

OXFORD

ORGANIC CHEMISTRY

SECOND
EDITION

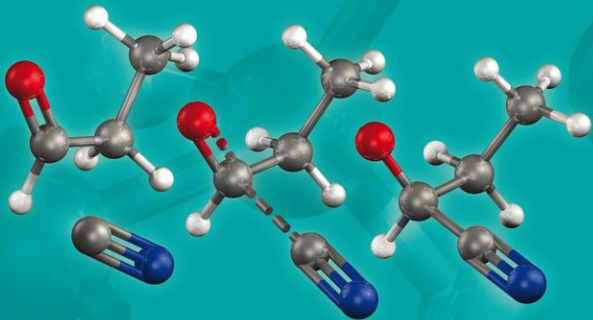

Jonathan Clayden, Nick Greeves,
and Stuart Warren

Organic Chemistry



Organic Chemistry—online support

Each chapter in this book is accompanied by a set of problems, which are available free of charge online. To access them visit the Online Resource Centre at www.oxfordtextbooks.co.uk/orc/clayden2e/ and enter the following:

Username: clayden2e

Password: compound

This page intentionally left blank

ORGANIC CHEMISTRY

SECOND
EDITION

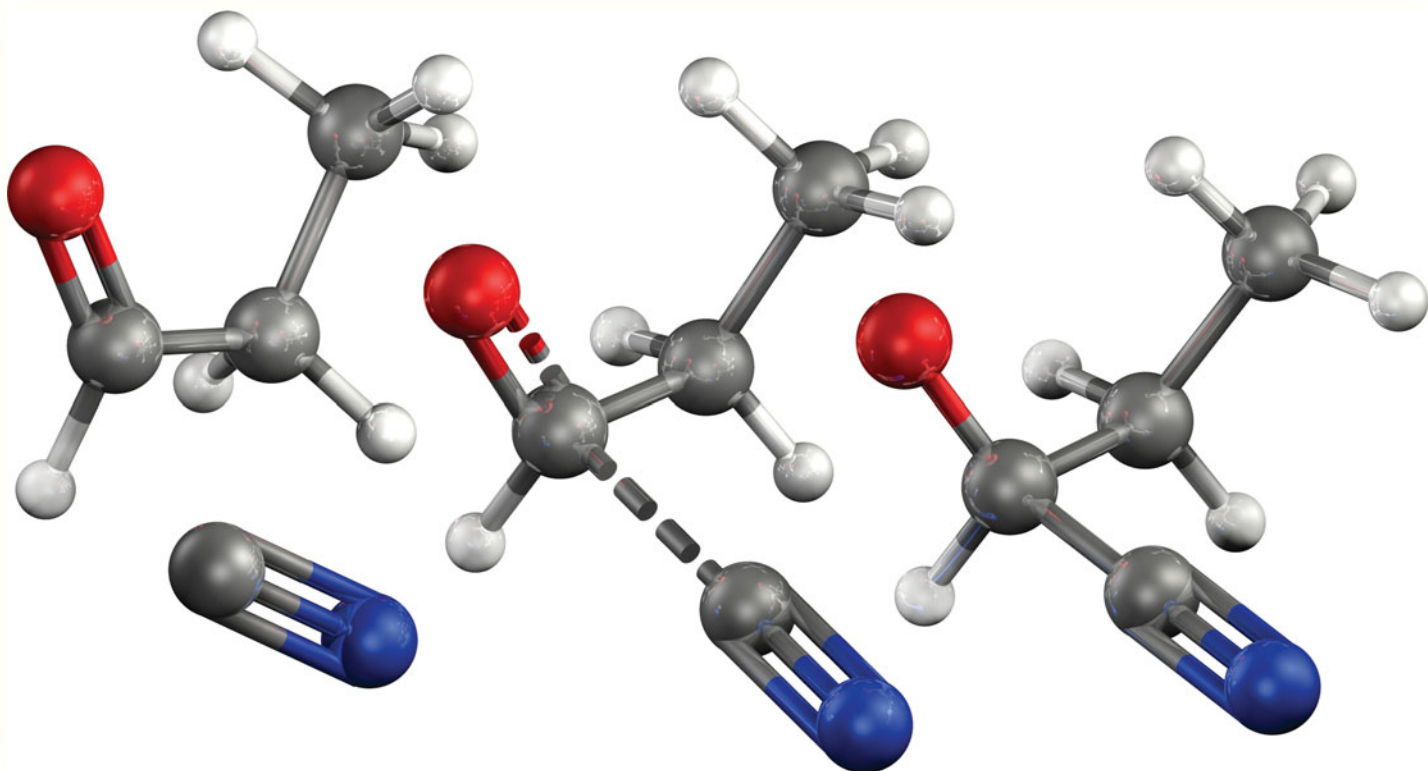

Jonathan Clayden

University of Manchester

Nick Greeves

University of Liverpool

Stuart Warren

University of Cambridge

OXFORD
UNIVERSITY PRESS

OXFORD

UNIVERSITY PRESS

Great Clarendon Street, Oxford OX2 6DP

Oxford University Press is a department of the University of Oxford.
It furthers the University's objective of excellence in research, scholarship,
and education by publishing worldwide in

Oxford New York

Auckland Cape Town Dar es Salaam Hong Kong Karachi
Kuala Lumpur Madrid Melbourne Mexico City Nairobi
New Delhi Shanghai Taipei Toronto

With offices in

Argentina Austria Brazil Chile Czech Republic France Greece
Guatemala Hungary Italy Japan Poland Portugal Singapore
South Korea Switzerland Thailand Turkey Ukraine Vietnam

Oxford is a registered trade mark of Oxford University Press
in the UK and in certain other countries

Published in the United States
by Oxford University Press Inc., New York

© Jonathan Clayden, Nick Greeves, and Stuart Warren 2012

The moral rights of the authors have been asserted

Crown Copyright material reproduced with the permission of the
Controller, HMSO (under the terms of the Click Use licence.)

Database right Oxford University Press (maker)

First published 2001

All rights reserved. No part of this publication may be reproduced,
stored in a retrieval system, or transmitted, in any form or by any means,
without the prior permission in writing of Oxford University Press,
or as expressly permitted by law, or under terms agreed with the appropriate
reprographics rights organization. Enquiries concerning reproduction
outside the scope of the above should be sent to the Rights Department,
Oxford University Press, at the address above

You must not circulate this book in any other binding or cover
and you must impose this same condition on any acquirer

British Library Cataloguing in Publication Data
Data available

Library of Congress Cataloging in Publication Data
Library of Congress Control Number: 2011943531

Typeset by Techset Composition Ltd, Salisbury, UK

Printed and bound in China by
C&C Offset Printing Co. Ltd

ISBN 978-0-19-927029-3

10 9 8 7 6 5 4 3 2 1

Brief contents

Abbreviations xv

Preface to the second edition xvii

Organic chemistry and this book xix

- 1** What is organic chemistry? 1
- 2** Organic structures 15
- 3** Determining organic structures 43
- 4** Structure of molecules 80
- 5** Organic reactions 107
- 6** Nucleophilic addition to the carbonyl group 125
- 7** Delocalization and conjugation 141
- 8** Acidity, basicity, and pK_a 163
- 9** Using organometallic reagents to make C–C bonds 182
- 10** Nucleophilic substitution at the carbonyl group 197
- 11** Nucleophilic substitution at C=O with loss of carbonyl oxygen 222
- 12** Equilibria, rates, and mechanisms 240
- 13** ^1H NMR: Proton nuclear magnetic resonance 269
- 14** Stereochemistry 302
- 15** Nucleophilic substitution at saturated carbon 328
- 16** Conformational analysis 360
- 17** Elimination reactions 382
- 18** Review of spectroscopic methods 407
- 19** Electrophilic addition to alkenes 427
- 20** Formation and reactions of enols and enolates 449
- 21** Electrophilic aromatic substitution 471
- 22** Conjugate addition and nucleophilic aromatic substitution 498
- 23** Chemoselectivity and protecting groups 528
- 24** Regioselectivity 562
- 25** Alkylation of enolates 584
- 26** Reactions of enolates with carbonyl compounds: the aldol and Claisen reactions 614
- 27** Sulfur, silicon, and phosphorus in organic chemistry 656
- 28** Retrosynthetic analysis 694
- 29** Aromatic heterocycles 1: reactions 723
- 30** Aromatic heterocycles 2: synthesis 757
- 31** Saturated heterocycles and stereoelectronics 789
- 32** Stereoselectivity in cyclic molecules 825

33	Diastereoselectivity	852
34	Pericyclic reactions 1: cycloadditions	877
35	Pericyclic reactions 2: sigmatropic and electrocyclic reactions	909
36	Participation, rearrangement, and fragmentation	931
37	Radical reactions	970
38	Synthesis and reactions of carbenes	1003
39	Determining reaction mechanisms	1029
40	Organometallic chemistry	1069
41	Asymmetric synthesis	1102
42	Organic chemistry of life	1134
43	Organic chemistry today	1169
	Figure acknowledgements	1182
	Periodic table of the elements	1184
	Index	1187

Contents

Abbreviations	xv		
Preface to the second edition	xvii		
Organic chemistry and this book	xix		
1 What is organic chemistry?	1		
Organic chemistry and you	1		
Organic compounds	2		
Organic chemistry and industry	6		
Organic chemistry and the periodic table	11		
Organic chemistry and this book	13		
Further reading	13		
2 Organic structures	15		
Hydrocarbon frameworks and functional groups	16		
Drawing molecules	17		
Hydrocarbon frameworks	22		
Functional groups	27		
Carbon atoms carrying functional groups can be classified by oxidation level	32		
Naming compounds	33		
What do chemists really call compounds?	36		
How should you name compounds?	40		
Further reading	42		
3 Determining organic structures	43		
Introduction	43		
Mass spectrometry	46		
Mass spectrometry detects isotopes	48		
Atomic composition can be determined by high-resolution mass spectrometry	50		
Nuclear magnetic resonance	52		
Regions of the ¹³ C NMR spectrum	56		
Different ways of describing chemical shift	57		
A guided tour of the ¹³ C NMR spectra of some simple molecules	57		
The ¹ H NMR spectrum	59		
Infrared spectra	63		
Mass spectra, NMR, and IR combined make quick identification possible	72		
Double bond equivalents help in the search for a structure	74		
Looking forward to Chapters 13 and 18	78		
Further reading	78		
4 Structure of molecules	80		
Introduction	80		
Electrons occupy atomic orbitals	83		
Molecular orbitals—diatomic molecules	88		
Bonds between different atoms	95		
Hybridization of atomic orbitals	99		
Rotation and rigidity	105		
Conclusion	106		
Looking forward	106		
Further reading	106		
5 Organic reactions	107		
Chemical reactions	107		
Nucleophiles and electrophiles	111		
Curly arrows represent reaction mechanisms	116		
Drawing your own mechanisms with curly arrows	120		
Further reading	124		
6 Nucleophilic addition to the carbonyl group	125		
Molecular orbitals explain the reactivity of the carbonyl group	125		
Attack of cyanide on aldehydes and ketones	127		
The angle of nucleophilic attack on aldehydes and ketones	129		
Nucleophilic attack by ‘hydride’ on aldehydes and ketones	130		
Addition of organometallic reagents to aldehydes and ketones	132		
Addition of water to aldehydes and ketones	133		
Hemiacetals from reaction of alcohols with aldehydes and ketones	135		
Ketones also form hemiacetals	137		
Acid and base catalysis of hemiacetal and hydrate formation	137		
Bisulfite addition compounds	138		
Further reading	140		
7 Delocalization and conjugation	141		
Introduction	141		
The structure of ethene (ethylene, CH ₂ =CH ₂)	142		
Molecules with more than one C=C double bond	143		

The conjugation of two π bonds	146	And to conclude...	220
UV and visible spectra	148	Further reading	220
The allyl system	150		
Delocalization over three atoms is a common structural feature	154	11 Nucleophilic substitution at C=O with loss of carbonyl oxygen	222
Aromaticity	156	Introduction	222
Further reading	162	Aldehydes can react with alcohols to form hemiacetals	223
8 Acidity, basicity, and pK_a	163	Acetals are formed from aldehydes or ketones plus alcohols in the presence of acid	224
Organic compounds are more soluble in water as ions	163	Amines react with carbonyl compounds	229
Acids, bases, and pK_a	165	Imines are the nitrogen analogues of carbonyl compounds	230
Acidity	165	Summary	238
The definition of pK_a	168	Further reading	239
Constructing a pK_a scale	171		
Nitrogen compounds as acids and bases	174	12 Equilibria, rates, and mechanisms	240
Substituents affect the pK_a	175	How far and how fast?	240
Carbon acids	176	How to make the equilibrium favour the product you want	244
pK_a in action—the development of the drug cimetidine	178	Entropy is important in determining equilibrium constants	246
Lewis acids and bases	180	Equilibrium constants vary with temperature	248
Further reading	181	Introducing kinetics: how to make reactions go faster and cleaner	250
		Rate equations	257
9 Using organometallic reagents to make C–C bonds	182	Catalysis in carbonyl substitution reactions	262
Introduction	182	Kinetic versus thermodynamic products	264
Organometallic compounds contain a carbon–metal bond	183	Summary of mechanisms from Chapters 6–12	266
Making organometallics	184	Further reading	267
Using organometallics to make organic molecules	189		
Oxidation of alcohols	194	13 ^1H NMR: Proton nuclear magnetic resonance	269
Looking forward	196	The differences between carbon and proton NMR	269
Further reading	196	Integration tells us the number of hydrogen atoms in each peak	270
		Regions of the proton NMR spectrum	272
10 Nucleophilic substitution at the carbonyl group	197	Protons on saturated carbon atoms	272
The product of nucleophilic addition to a carbonyl group is not always a stable compound	197	The alkene region and the benzene region	277
Carboxylic acid derivatives	198	The aldehyde region: unsaturated carbon bonded to oxygen	281
Why are the tetrahedral intermediates unstable?	200	Protons on heteroatoms have more variable shifts than protons on carbon	282
Not all carboxylic acid derivatives are equally reactive	205	Coupling in the proton NMR spectrum	285
Acid catalysts increase the reactivity of a carbonyl group	207	To conclude	301
Acid chlorides can be made from carboxylic acids using SOCl_2 or PCl_5	214	Further reading	301
Making other compounds by substitution reactions of acid derivatives	216		
Making ketones from esters: the problem	216	14 Stereochemistry	302
Making ketones from esters: the solution	218	Some compounds can exist as a pair of mirror-image forms	302
To summarize...	220		

Diastereoisomers are stereoisomers that are not enantiomers	311	Anion-stabilizing groups allow another mechanism—E1cB	399
Chiral compounds with no stereogenic centres	319	To conclude	404
Axes and centres of symmetry	320	Further reading	406
Separating enantiomers is called resolution	322		
Further reading	327		
15 Nucleophilic substitution at saturated carbon	328	18 Review of spectroscopic methods	407
Mechanisms for nucleophilic substitution	328	There are three reasons for this chapter	407
How can we decide which mechanism (S_N1 or S_N2) will apply to a given organic compound?	332	Spectroscopy and carbonyl chemistry	408
A closer look at the S_N1 reaction	333	Acid derivatives are best distinguished by infrared	411
A closer look at the S_N2 reaction	340	Small rings introduce strain inside the ring and higher s character outside it	412
Contrasts between S_N1 and S_N2	342	Simple calculations of C=O stretching frequencies in IR spectra	413
The leaving group in S_N1 and S_N2 reactions	347	NMR spectra of alkynes and small rings	414
The nucleophile in S_N1 reactions	352	Proton NMR distinguishes axial and equatorial protons in cyclohexanes	415
The nucleophile in the S_N2 reaction	353	Interactions between different nuclei can give enormous coupling constants	415
Nucleophiles and leaving groups compared	357	Identifying products spectroscopically	418
Looking forward: elimination and rearrangement reactions	358	Tables	422
Further reading	359	Shifts in proton NMR are easier to calculate and more informative than those in carbon NMR	425
		Further reading	426
16 Conformational analysis	360	19 Electrophilic addition to alkenes	427
Bond rotation allows chains of atoms to adopt a number of conformations	360	Alkenes react with bromine	427
Conformation and configuration	361	Oxidation of alkenes to form epoxides	429
Barriers to rotation	362	Electrophilic addition to unsymmetrical alkenes is regioselective	433
Conformations of ethane	363	Electrophilic addition to dienes	435
Conformations of propane	365	Unsymmetrical bromonium ions open regioselectively	436
Conformations of butane	365	Electrophilic additions to alkenes can be stereospecific	439
Ring strain	366	Adding two hydroxyl groups: dihydroxylation	442
A closer look at cyclohexane	370	Breaking a double bond completely: periodate cleavage and ozonolysis	443
Substituted cyclohexanes	374	Adding one hydroxyl group: how to add water across a double bond	444
To conclude...	381	To conclude... a synopsis of electrophilic addition reactions	447
Further reading	381	Further reading	447
17 Elimination reactions	382	20 Formation and reactions of enols and enolates	449
Substitution and elimination	382	Would you accept a mixture of compounds as a pure substance?	449
How the nucleophile affects elimination versus substitution	384	Tautomerism: formation of enols by proton transfer	450
E1 and E2 mechanisms	386	Why don't simple aldehydes and ketones exist as enols?	451
Substrate structure may allow E1	388		
The role of the leaving group	390		
E1 reactions can be stereoselective	391		
E2 eliminations have anti-periplanar transition states	395		
The regioselectivity of E2 eliminations	398		

Evidence for the equilibration of carbonyl compounds with enols	451	To conclude...	526
Enolization is catalysed by acids and bases	452	Further reading	527
The intermediate in the base-catalysed reaction is an enolate ion	452	23 Chemoselectivity and protecting groups	528
Summary of types of enol and enolate	454	Selectivity	528
Stable enols	456	Reducing agents	530
Consequences of enolization	459	Reduction of carbonyl groups	530
Reaction with enols or enolates as intermediates	460	Hydrogen as a reducing agent: catalytic hydrogenation	534
Stable equivalents of enolate ions	465	Getting rid of functional groups	539
Enol and enolate reactions at oxygen: preparation of enol ethers	467	Dissolving metal reductions	541
Reactions of enol ethers	468	Selectivity in oxidation reactions	544
To conclude	470	Competing reactivity: choosing which group reacts	546
Further reading	470	A survey of protecting groups	549
		Further reading	561
21 Electrophilic aromatic substitution	471	24 Regioselectivity	562
Introduction: enols and phenols	471	Introduction	562
Benzene and its reactions with electrophiles	473	Regioselectivity in electrophilic aromatic substitution	563
Electrophilic substitution on phenols	479	Electrophilic attack on alkenes	570
A nitrogen lone pair activates even more strongly	482	Regioselectivity in radical reactions	571
Alkyl benzenes also react at the <i>ortho</i> and <i>para</i> positions	484	Nucleophilic attack on allylic compounds	574
Electron-withdrawing substituents give <i>meta</i> products	486	Electrophilic attack on conjugated dienes	579
Halogens show evidence of both electron withdrawal and donation	489	Conjugate addition	581
Two or more substituents may cooperate or compete	491	Regioselectivity in action	582
Some problems and some opportunities	492	Further reading	583
A closer look at Friedel–Crafts chemistry	492	25 Alkylation of enolates	584
Exploiting the chemistry of the nitro group	494	Carbonyl groups show diverse reactivity	584
Summary	495	Some important considerations that affect all alkylations	584
Further reading	497	Nitriles and nitroalkanes can be alkylated	585
		Choice of electrophile for alkylation	587
		Lithium enolates of carbonyl compounds	587
		Alkylations of lithium enolates	588
		Using specific enol equivalents to alkylate aldehydes and ketones	591
		Alkylation of β -dicarbonyl compounds	595
		Ketone alkylation poses a problem in regioselectivity	598
		Enones provide a solution to regioselectivity problems	601
		Using Michael acceptors as electrophiles	605
		To conclude...	612
		Further reading	613
22 Conjugate addition and nucleophilic aromatic substitution	498	26 Reactions of enolates with carbonyl compounds: the aldol and Claisen reactions	614
Alkenes conjugated with carbonyl groups	498	Introduction	614
Conjugated alkenes can be electrophilic	499	The aldol reaction	615
Summary: factors controlling conjugate addition	509	Cross-condensations	618
Extending the reaction to other electron-deficient alkenes	510		
Conjugate substitution reactions	511		
Nucleophilic epoxidation	513		
Nucleophilic aromatic substitution	514		
The addition–elimination mechanism	515		
The S_N1 mechanism for nucleophilic aromatic substitution: diazonium compounds	520		
The benzyne mechanism	523		

Specific enol equivalents can be used to control aldol reactions	624	Functional group interconversion	699
How to control aldol reactions of esters	631	Two-group disconnections are better than one-group disconnections	702
How to control aldol reactions of aldehydes	632	C—C disconnections	706
How to control aldol reactions of ketones	634	Available starting materials	711
Intramolecular aldol reactions	636	Donor and acceptor synthons	712
Acylation at carbon	640	Two-group C—C disconnections	712
Crossed ester condensations	643	1,5-Related functional groups	719
Summary of the preparation of keto-esters by the Claisen reaction	647	'Natural reactivity' and 'umpolung'	719
Controlling acylation with specific enol equivalents	648	To conclude...	722
Intramolecular crossed Claisen ester condensations	652	Further reading	722
Carbonyl chemistry—where next?	654		
Further reading	654		
27 Sulfur, silicon, and phosphorus in organic chemistry	656	29 Aromatic heterocycles 1: reactions	723
Useful main group elements	656	Introduction	723
Sulfur: an element of contradictions	656	Aromaticity survives when parts of benzene's ring are replaced by nitrogen atoms	724
Sulfur-stabilized anions	660	Pyridine is a very unreactive aromatic imine	725
Sulfonium salts	664	Six-membered aromatic heterocycles can have oxygen in the ring	732
Sulfonium ylids	665	Five-membered aromatic heterocycles are good at electrophilic substitution	733
Silicon and carbon compared	668	Furan and thiophene are oxygen and sulfur analogues of pyrrole	735
Allyl silanes as nucleophiles	675	More reactions of five-membered heterocycles	738
The selective synthesis of alkenes	677	Five-membered rings with two or more nitrogen atoms	740
The properties of alkenes depend on their geometry	677	Benzo-fused heterocycles	745
Exploiting cyclic compounds	678	Putting more nitrogen atoms in a six-membered ring	748
Equilibration of alkenes	679	Fusing rings to pyridines: quinolines and isoquinolines	749
<i>E</i> and <i>Z</i> alkenes can be made by stereoselective addition to alkynes	681	Aromatic heterocycles can have many nitrogens but only one sulfur or oxygen in any ring	751
Predominantly <i>E</i> alkenes can be formed by stereoselective elimination reactions	684	There are thousands more heterocycles out there	753
The Julia olefination is regioselective and connective	686	Which heterocyclic structures should you learn?	754
Stereospecific eliminations can give pure single isomers of alkenes	688	Further reading	755
Perhaps the most important way of making alkenes—the Wittig reaction	689		
To conclude	693	30 Aromatic heterocycles 2: synthesis	757
Further reading	693	Thermodynamics is on our side	758
		Disconnect the carbon—heteroatom bonds first	758
28 Retrosynthetic analysis	694	Pyrroles, thiophenes, and furans from 1,4-dicarbonyl compounds	760
Creative chemistry	694	How to make pyridines: the Hantzsch pyridine synthesis	763
Retrosynthetic analysis: synthesis backwards	694	Pyrazoles and pyridazines from hydrazine and dicarbonyl compounds	767
Disconnections must correspond to known, reliable reactions	695	Pyrimidines can be made from 1,3-dicarbonyl compounds and amidines	770
Synthons are idealized reagents	695	Unsymmetrical nucleophiles lead to selectivity questions	771
Multiple step syntheses: avoid chemoselectivity problems	698	Isoxazoles are made from hydroxylamine or by cycloaddition	772
		Tetrazoles and triazoles are also made by cycloadditions	774
		The Fischer indole synthesis	775

Quinolines and isoquinolines	780	The Woodward–Hoffmann description of the Diels–Alder reaction	892
More heteroatoms in fused rings mean more choice in synthesis	784	Trapping reactive intermediates by cycloadditions	893
Summary: the three major approaches to the synthesis of aromatic heterocycles	785	Other thermal cycloadditions	894
Further reading	788	Photochemical [2 + 2] cycloadditions	896
31 Saturated heterocycles and stereoelectronics	789	Thermal [2 + 2] cycloadditions	898
Introduction	789	Making five-membered rings: 1,3-dipolar cycloadditions	901
Reactions of saturated heterocycles	790	Two very important synthetic reactions: cycloaddition of alkenes with osmium tetroxide and with ozone	905
Conformation of saturated heterocycles	796	Summary of cycloaddition reactions	907
Making heterocycles: ring-closing reactions	805	Further reading	908
Ring size and NMR	814	35 Pericyclic reactions 2: sigmatropic and electrocyclic reactions	909
Geminal (2J) coupling	817	Sigmatropic rearrangements	909
Diastereotopic groups	820	Orbital descriptions of [3,3]-sigmatropic rearrangements	912
To summarize...	824	The direction of [3,3]-sigmatropic rearrangements	913
Further reading	824	[2,3]-Sigmatropic rearrangements	917
32 Stereoselectivity in cyclic molecules	825	[1,5]-Sigmatropic hydrogen shifts	919
Introduction	825	Electrocyclic reactions	922
Stereochemical control in six-membered rings	826	Further reading	930
Reactions on small rings	832	36 Participation, rearrangement, and fragmentation	931
Regiochemical control in cyclohexene epoxides	836	Neighbouring groups can accelerate substitution reactions	931
Stereoselectivity in bicyclic compounds	839	Rearrangements occur when a participating group ends up bonded to a different atom	937
Fused bicyclic compounds	841	Carbocations readily rearrange	940
Spirocyclic compounds	846	The pinacol rearrangement	945
Reactions with cyclic intermediates or cyclic transition states	847	The dienone-phenol rearrangement	949
To summarize...	851	The benzilic acid rearrangement	950
Further reading	851	The Favorskii rearrangement	950
33 Diastereoselectivity	852	Migration to oxygen: the Baeyer–Villiger reaction	953
Looking back	852	The Beckmann rearrangement	958
Prochirality	856	Polarization of C–C bonds helps fragmentation	960
Additions to carbonyl groups can be diastereoselective even without rings	858	Fragmentations are controlled by stereochemistry	962
Stereoselective reactions of acyclic alkenes	865	Ring expansion by fragmentation	963
Aldol reactions can be stereoselective	868	Controlling double bonds using fragmentation	965
Single enantiomers from diastereoselective reactions	871	The synthesis of nootkatone: fragmentation showcase	966
Looking forward	876	Looking forward	969
Further reading	876	Further reading	969
34 Pericyclic reactions 1: cycloadditions	877	37 Radical reactions	970
A new sort of reaction	877	Radicals contain unpaired electrons	970
General description of the Diels–Alder reaction	879	Radicals form by homolysis of weak bonds	971
The frontier orbital description of cycloadditions	886		
Regioselectivity in Diels–Alder reactions	889		

Most radicals are extremely reactive. . .	974	Summary of methods for the investigation of mechanism	1067
How to analyse the structure of radicals: electron spin resonance	975	Further reading	1068
Radical stability	977		
How do radicals react?	980	40 Organometallic chemistry	1069
Radical–radical reactions	980	Transition metals extend the range of organic reactions	1069
Radical chain reactions	984	The 18 electron rule	1070
Chlorination of alkanes	986	Bonding and reactions in transition metal complexes	1073
Allylic bromination	989	Palladium is the most widely used metal in homogeneous catalysis	1078
Reversing the selectivity: radical substitution of Br by H	990	The Heck reaction couples together an organic halide or triflate and an alkene	1079
Carbon–carbon bond formation with radicals	992	Cross-coupling of organometallics and halides	1082
The reactivity pattern of radicals is quite different from that of polar reagents	997	Allylic electrophiles are activated by palladium(0)	1088
Alkyl radicals from boranes and oxygen	998	Palladium-catalysed amination of aromatic rings	1092
Intramolecular radical reactions are more efficient than intermolecular ones	999	Alkenes coordinated to palladium(II) are attacked by nucleophiles	1096
Looking forward	1002	Palladium catalysis in the total synthesis of a natural alkaloid	1098
Further reading	1002	An overview of some other transition metals	1099
		Further reading	1101
38 Synthesis and reactions of carbenes	1003	41 Asymmetric synthesis	1102
Diazomethane makes methyl esters from carboxylic acids	1003	Nature is asymmetric	1102
Photolysis of diazomethane produces a carbene	1005	The chiral pool: Nature's chiral centres 'off the shelf'	1104
How do we know that carbenes exist?	1006	Resolution can be used to separate enantiomers	1106
Ways to make carbenes	1006	Chiral auxiliaries	1107
Carbenes can be divided into two types	1010	Chiral reagents	1113
How do carbenes react?	1013	Asymmetric catalysis	1114
Carbenes react with alkenes to give cyclopropanes	1013	Asymmetric formation of carbon–carbon bonds	1126
Insertion into C–H bonds	1018	Asymmetric aldol reactions	1129
Rearrangement reactions	1020	Enzymes as catalysts	1132
Nitrenes are the nitrogen analogues of carbenes	1022	Further reading	1133
Alkene metathesis	1023		
Summary	1027	42 Organic chemistry of life	1134
Further reading	1027	Primary metabolism	1134
		Life begins with nucleic acids	1135
39 Determining reaction mechanisms	1029	Proteins are made of amino acids	1139
There are mechanisms and there are mechanisms	1029	Sugars—just energy sources?	1142
Determining reaction mechanisms: the Cannizzaro reaction	1031	Lipids	1147
Be sure of the structure of the product	1035	Mechanisms in biological chemistry	1149
Systematic structural variation	1040	Natural products	1156
The Hammett relationship	1041	Fatty acids and other polyketides are made from acetyl CoA	1161
Other kinetic evidence for reaction mechanisms	1050	Terpenes are volatile constituents of plants	1164
Acid and base catalysis	1053	Further reading	1167
The detection of intermediates	1060		
Stereochemistry and mechanism	1063		

43	Organic chemistry today	1169	Figure acknowledgements	1182
	Science advances through interaction between disciplines	1169	Periodic table of the elements	1184
	Chemistry vs viruses	1170	Index	1187
	The future of organic chemistry	1179		
	Further reading	1181		

Abbreviations

Ac	Acetyl	DMS	Dimethyl sulfide
Acac	Acetylacetonate	DMSO	Dimethyl sulfoxide
AD	Asymmetric dihydroxylation	DNA	Deoxyribonucleic acid
ADP	Adenosine 5'-diphosphate	E1	Unimolecular elimination
AE	Asymmetric epoxidation	E2	Bimolecular elimination
AIBN	Azobisisobutyronitrile	E _a	Activation energy
AO	Atomic orbital	EDTA	Ethylenediaminetetraacetic acid
Ar	Aryl	EPR	Electron paramagnetic resonance
ATP	Adenosine triphosphate	ESR	Electron spin resonance
9-BBN	9-Borabicyclo[3.3.1]nonane	Et	Ethyl
BHT	Butylated hydroxy toluene (2,6-di- <i>t</i> -butyl-4-methylphenol)	FGI	Functional group interconversion
BINAP	Bis(diphenylphosphino)-1,1'-binaphthyl	Fmoc	Fluorenylmethyloxycarbonyl
Bn	Benzyl	GAC	General acid catalysis
Boc, BOC	<i>tert</i> -Butyloxycarbonyl	GBC	General base catalysis
Bu	Butyl	HMPA	Hexamethylphosphoramide
<i>s</i> -Bu	<i>sec</i> -Butyl	HMPT	Hexamethylphosphorous triamide
<i>t</i> -Bu	<i>tert</i> -Butyl	HOBt	1-Hydroxybenzotriazole
Bz	Benzoyl	HOMO	Highest occupied molecular orbital
Cbz	Carboxybenzyl	HPLC	High performance liquid chromatography
CDI	Carbonyldiimidazole	HIV	Human immunodeficiency virus
CI	Chemical ionization	IR	Infrared
CoA	Coenzyme A	KHMDS	Potassium hexamethyldisilazide
COT	Cyclooctatetraene	LCAO	Linear combination of atomic orbitals
Cp	Cyclopentadienyl	LDA	Lithium diisopropylamide
DABCO	1,4-Diazabicyclo[2.2.2]octane	LHMDS	Lithium hexamethyldisilazide
DBE	Double bond equivalent	LICA	Lithium isopropylcyclohexylamide
DBN	1,5-Diazabicyclo[4.3.0]non-5-ene	LTMP, LiTMP	Lithium 2,2,6,6-tetramethylpiperidide
DBU	1,8-Diazabicyclo[5.4.0]undec-7-ene	LUMO	Lowest unoccupied molecular orbital
DCC	<i>N,N</i> -dicyclohexylcarbodiimide	<i>m</i> -CPBA	<i>meta</i> -Chloroperoxybenzoic acid
DDQ	2,3-Dichloro-5,6-dicyano-1,4-benzoquinone	Me	Methyl
DEAD	Diethyl azodicarboxylate	MO	Molecular orbital
DIBAL	Diisobutylaluminum hydride	MOM	Methoxymethyl
DMAP	4-Dimethylaminopyridine	Ms	Methanesulfonyl (mesyl)
DME	1,2-Dimethoxyethane	NAD	Nicotinamide adenine dinucleotide
DMF	<i>N,N</i> -Dimethylformamide	NADH	Reduced NAD
DMPU	1,3-Dimethyl-3,4,5,6-tetrahydro-2(1 <i>H</i>)-pyrimidinone	NBS	<i>N</i> -Bromosuccinimide
		NIS	<i>N</i> -Iodosuccinimide
		NMO	<i>N</i> -Methylmorpholine- <i>N</i> -oxide

NMR	Nuclear magnetic resonance	SOMO	Singly occupied molecular orbital
NOE	Nuclear Overhauser effect	STM	Scanning tunnelling microscopy
PCC	Pyridinium chlorochromate	TBDMS	<i>Tert</i> -butyldimethylsilyl
PDC	Pyridinium dichromate	TBDPS	<i>Tert</i> -butyldiphenylsilyl
Ph	Phenyl	Tf	Trifluoromethanesulfonyl (triflyl)
PPA	Polyphosphoric acid	THF	Tetrahydrofuran
Pr	Propyl	THP	Tetrahydropyran
<i>i</i> -Pr	<i>iso</i> -Propyl	TIPS	Triisopropylsilyl
PTC	Phase transfer catalysis	TMEDA	<i>N,N,N',N'</i> -tetramethyl-1,2-ethylenediamine
PTSA	<i>p</i> -Toluenesulfonic acid	TMP	2,2,6,6-Tetramethylpiperidine
Py	Pyridine	TMS	Trimethylsilyl, tetramethylsilane
Red Al	Sodium <i>bis</i> (2-methoxyethoxy) aluminum hydride	TMSOTf	Trimethylsilyl triflate
RNA	Ribonucleic acid	TPAP	Tetra- <i>N</i> -propylammonium perruthenate
SAC	Specific acid catalysis	Tr	Triphenylmethyl (trityl)
SAM	<i>S</i> -Adenosyl methionine	TS	Transition state
SBC	Specific base catalysis	Ts	<i>p</i> -Toluenesulfonyl, tosyl
S_N1	Unimolecular nucleophilic substitution	UV	Ultraviolet
S_N2	Bimolecular nucleophilic substitution	VSEPR	Valence shell electron pair repulsion

Preface to the second edition

Students of chemistry are not hard-pressed to find a text to support their learning in organic chemistry through their years at university. The shelves of a university bookshop will usually offer a choice of at least half a dozen—all entitled ‘Organic Chemistry’, all with substantially more than 1000 pages. Closer inspection of these titles quickly disappoints expectations of variety. Almost without exception, general organic chemistry texts have been written to accompany traditional American sophomore courses, with their rather precisely defined requirements. This has left the authors of these books little scope for reinvigorating their presentation of chemistry with new ideas.

We wanted to write a book whose structure grows from the development of ideas rather than being dictated by the sequential presentation of facts. We believe that students benefit most of all from a book which leads from familiar concepts to unfamiliar ones, not just encouraging them to *know* but to *understand* and to understand *why*. We were spurred on by the nature of the best modern university chemistry courses, which themselves follow this pattern: this is after all how science itself develops. We also knew that if we did this we could, from the start, relate the chemistry we were talking about to the two most important sorts of chemistry that exist—the chemistry that is known as life, and the chemistry as practised by chemists solving real problems in laboratories.

We aimed at an approach which would make sense to and appeal to today’s students. But all of this meant taking the axe to the roots of some long-standing textbook traditions. The best way to find out how something works is to take it apart and put it back together again, so we started with the tools for expressing chemical ideas: structural diagrams and curly arrows. Organic chemistry is too huge a field to learn even a small part by rote, but with these tools, students can soon make sense of chemistry which may be unfamiliar in detail by relating it to what they know and understand. By calling on curly arrows and ordering chemistry according to mechanism we allow ourselves to discuss mechanistically (and orbitally) simple reactions (addition to C=O, for example) before more complex and involved ones (such as S_N1 and S_N2).

Complexity follows in its own time, but we have deliberately omitted detailed discussion of obscure reactions of little value, or of variants of reactions which lie a simple step of mechanistic logic from our main story: some of these are explored in the problems associated with each chapter, which are available online.¹ We have similarly aimed to avoid exhuming principles and rules (from those of Le Châtelier through Markovnikov, Saytseff, least motion, and the like) to explain things which are better understood in terms of unifying fundamental thermodynamic or mechanistic concepts.

All science must be underpinned by evidence, and support for organic chemistry’s claims is provided by spectroscopy. For this reason we first reveal to students the facts which spectroscopy tells us (Chapter 3) before trying to explain them (Chapter 4) and then use them to deduce mechanisms (Chapter 5). NMR in particular forms a significant part of four chapters in the book, and evidence drawn from NMR underpins many of the discussions right through the book. Likewise, the mechanistic principles we outline in Chapter 5, firmly based in the orbital theories of Chapter 4, underpin all of the discussion of new reactions through the rest of the book.

We have presented chemistry as something whose essence is truth, of provable veracity, but which is embellished with opinions and suggestions to which not all chemists subscribe. We aim to avoid dogma and promote the healthy weighing up of evidence, and on occasion we are content to leave readers to draw their own conclusions. Science is important not just to scientists, but to society. Our aim has been to write a book which itself takes a scientific

¹ See www.oxfordtextbooks.co.uk/orc/clayden2e/.

standpoint—‘one foot inside the boundary of the known, the other just outside’²—and encourages the reader to do the same.

The authors are indebted to the many supportive and critical readers of the first edition of this book who have supplied us over the last ten years with a stream of comments and corrections, hearty encouragements and stern rebukes. All were carefully noted and none was overlooked while we were writing this edition. In many cases these contributions helped us to correct errors or make other improvements to the text. We would also like to acknowledge the support and guidance of the editorial team at OUP, and again to recognize the seminal contribution of the man who first nurtured the vision that organic chemistry could be taught with a book like this, Michael Rodgers. The time spent on the preparation of this edition was made available only with the forbearance of our families, friends and research groups, and we thank all of them for their patience and understanding.

Changes for this edition

In the decade since the publication of the first edition of this book it has become clear that some aspects of our original approach were in need of revision, some chapters in need of updating with material which has gained in significance over those years, and others in need of shortening. We have taken into account a consistent criticism from readers that the early chapters of the first edition were too detailed for new students, and have made substantial changes to the material in Chapters 4, 8, and 12, shifting the emphasis towards explanation and away from detail more suitably found in specialised texts. Every chapter has been rewritten to improve clarity and new explanations and examples have been used widely. The style, location, and content of the spectroscopy chapters (3, 13, 18, and 31) have been revised to strengthen the links with material appearing nearby in the book. Concepts such as conjugate addition and regioselectivity, which previously lacked coherent presentation, now have their own chapters (22 and 24). In some sections of the first edition, groups of chapters were used to present related material: these chapter groups have now been condensed—so, for example, Chapters 25 and 26 on enolate chemistry replace four previous chapters, Chapters 31 and 32 on cyclic molecules replace three chapters, Chapter 36 on rearrangements and fragmentations replaces two chapters, and Chapter 42 on the organic chemistry of life replaces three chapters (the former versions of which are available online). Three chapters placed late in the first edition have been moved forward and revised to emphasize links between their material and the enolate chemistry of Chapters 25 and 26, thus Chapter 27 deals with double-bond stereocontrol in the context of organo-main group chemistry, and Chapters 29 and 30, addressing aromatic heterocycles, now reinforce the link between many of the mechanisms characteristic of these compounds and those of the carbonyl addition and condensation reactions discussed in the previous chapters. Earlier discussion of heterocycles also allows a theme of cyclic molecules and transition states to develop throughout Chapters 29–36, and matches more closely the typical order of material in undergraduate courses.

Some fields have inevitably advanced considerably in the last 10 years: the chapters on organometallic chemistry (40) and asymmetric synthesis (41) have received the most extensive revision, and are now placed consecutively to allow the essential role of organometallic catalysis in asymmetric synthesis to come to the fore. Throughout the book, new examples, especially from the recent literature of drug synthesis, have been used to illustrate the reactions being discussed.

² McEvedy, C. *The Penguin Atlas of Ancient History*, Penguin Books, 1967.

Organic chemistry and this book

You can tell from the title that this book tells you about organic chemistry. But it tells you more than that: it tells you *how we know* about organic chemistry. It tells you facts, but it also teaches you how to find facts out. It tells you about reactions, and teaches you how to predict which reactions will work; it tells you about molecules, and it teaches you how to work out ways of making them.

We said 'it tells' in that last paragraph. Maybe we should have said 'we tell' because we want to speak to you through our words so that you can see how we think about organic chemistry and to encourage you to develop your own ideas. We expect you to notice that three people have written this book, and that they don't all think or write in the same way. That is as it should be. Organic chemistry is too big and important a subject to be restricted by dogmatic rules. Different chemists think in different ways about many aspects of organic chemistry and in many cases it is not yet, and may never be, possible to be sure who is right. In many cases it doesn't matter anyway.

We may refer to the history of chemistry from time to time but we are usually going to tell you about organic chemistry as it is now. We will develop the ideas slowly, from simple and fundamental ones using small molecules to complex ideas and large molecules. We promise one thing. We are not going to pull the wool over your eyes by making things artificially simple and avoiding the awkward questions. We aim to be honest and share both our delight in good complete explanations and our puzzlement at inadequate ones.

The chapters

So how are we going to do this? The book starts with a series of chapters on the structures and reactions of simple molecules. You will meet the way structures are determined and the theory that explains those structures. It is vital that you realize that theory is used to explain what is known by experiment and only then to predict what is unknown. You will meet mechanisms—the dynamic language used by chemists to talk about reactions—and of course some reactions.

The book starts with an introductory section of four chapters:

1. What is organic chemistry?
2. Organic structures
3. Determining organic structures
4. Structure of molecules

Chapter 1 is a 'rough guide' to the subject—it will introduce the major areas where organic chemistry plays a role, and set the scene by showing you some snapshots of a few landmarks. In Chapter 2 you will look at the way in which we present diagrams of molecules on the printed page. Organic chemistry is a visual, three-dimensional subject and the way you draw molecules shows how you think about them. We want you too to draw molecules in the best way possible. It is just as easy to draw them well as to draw them in an old-fashioned or inaccurate way.

Then in Chapter 3, before we come to the theory which *explains* molecular structure, we shall introduce you to the experimental techniques which *tell us about* molecular structure. This means studying the interactions between molecules and radiation by spectroscopy—using the whole electromagnetic spectrum from X-rays to radio waves. Only then, in Chapter 4, will we go behind the scenes and look at the theories of why atoms combine in the ways they do. Experiment comes before explanation. The spectroscopic methods of Chapter 3 will still be telling the truth in a hundred years' time, but the theories of Chapter 4 will look quite dated by then.

We could have titled those three chapters:

2. What shapes do organic molecules have?
3. How do we know they have those shapes?
4. Why do they have those shapes?

You need to have a grasp of the answers to these three questions before you start the study of organic reactions. That is exactly what happens next. We introduce organic reaction mechanisms in Chapter 5. Any kind of chemistry studies reactions—the transformations of molecules into other molecules. The dynamic process by which this happens is called *mechanism* and is the grammar of organic chemistry—the way that one molecule can change into another. We want you to start learning and using this language straight away so in Chapter 6 we apply it to one important class of reaction. We therefore have:

5. Organic reactions
6. Nucleophilic addition to the carbonyl group

Chapter 6 reveals how we are going to subdivide organic chemistry. We shall use a mechanistic classification rather than a structural classification and explain one type of *reaction* rather than one type of *compound* in each chapter. In the rest of the book most of the chapters describe types of reaction in a mechanistic way. Here is a selection from the first half of the book:

9. Using organometallic reagents to make C–C bonds
10. Nucleophilic substitution at the carbonyl group
11. Nucleophilic substitution at C=O with loss of carbonyl oxygen
15. Nucleophilic substitution at saturated carbon
17. Elimination reactions
19. Electrophilic addition to alkenes
20. Formation and reactions of enols and enolates
21. Electrophilic aromatic substitution
22. Conjugate addition and nucleophilic aromatic substitution

Interspersed with these chapters are others on physical aspects of molecular structure and reactivity, stereochemistry, and structural determination, which allow us to show you how we know what we are telling you is true and to explain reactions intelligently.

7. Delocalization and conjugation
8. Acidity, basicity, and pK_a
12. Equilibria, rates, and mechanisms
13. ^1H NMR: proton nuclear magnetic resonance
14. Stereochemistry
16. Conformational analysis
18. Review of spectroscopic methods

By the time we reach the end of Chapter 22 you will have met most of the important ways in which organic molecules react with one another, and we will then spend two chapters revisiting some of the reactions you have met before in two chapters on selectivity: how to get the reaction you want to happen and avoid the reaction you don't.

23. Chemoselectivity and protecting groups
24. Regioselectivity

The materials are now in place for us to show you how to make use of the reaction mechanisms you have seen. We spend four chapters explaining some ways of using carbonyl chemistry and the chemistry of Si, S, and P to make C–C and C=C bonds. We then bring this all together with a chapter which gives you the tools to work out how you might best set about making any particular molecule.

25. Alkylation of enolates
26. Reactions of enolates with carbonyl compounds: the aldol and Claisen reactions
27. Sulfur, silicon, and phosphorus in organic chemistry
28. Retrosynthetic analysis

Most organic compounds contain rings, and many cyclic structures entail one of two aspects which are rather special: aromaticity and well-defined conformations. The next group of chapters leads you through the chemistry of ring-containing compounds to the point where we have the tools to explain why even acyclic molecules react to give products with certain spatial features.

29. Aromatic heterocycles 1: reactions
30. Aromatic heterocycles 2: synthesis
31. Saturated heterocycles and stereoelectronics
32. Stereoselectivity in cyclic molecules
33. Diastereoselectivity

We said that Chapter 22 marks the point where most of the important ways in which molecules react together have been introduced—most but not all. For the next section of the book we survey a range of rather less common but extremely important alternative mechanisms, finishing with a chapter that tells you how we can find out what mechanism a reaction follows.

34. Pericyclic reactions 1: cycloadditions
35. Pericyclic reactions 2: sigmatropic and electrocyclic reactions
36. Participation, rearrangement, and fragmentation
37. Radical reactions
38. Synthesis and reactions of carbenes
39. Determining reaction mechanisms

The last few chapters of the book take you right into some of the most challenging roles that organic chemistry has been called on to play, and in many cases tell you about chemistry discovered only in the last few years. The reactions in these chapters have been used to make the most complex molecules ever synthesized, and to illuminate the way that organic chemistry underpins life itself.

40. Organometallic chemistry
41. Asymmetric synthesis
42. Organic chemistry of life
43. Organic chemistry today

'Connections' sections

That's a linear list of 43 chapters, but chemistry is not a linear subject! It is impossible to work through the whole field of organic chemistry simply by starting at the beginning and working through to the end, introducing one new topic at a time, because chemistry is a network of interconnecting ideas. But, unfortunately, a book is, by nature, a beginning-to-end sort of thing. We have arranged the chapters in a progression of difficulty as far as is possible, but to help you find your way around we have included at the beginning of each chapter a 'Connections' section. This tells you three things divided among three columns:

- (a) The 'Building on' column: what you should be familiar with before reading the chapter—in other words, which previous chapters relate directly to the material within the chapter.
- (b) The 'Arriving at' column: a guide to what you will find within the chapter.
- (c) The 'Looking forward to' column: signposting which chapters later in the book fill out and expand the material in the chapter.

The first time you read a chapter, you should really make sure you have read any chapter mentioned under (a). When you become more familiar with the book you will find that the links highlighted in (a) and (c) will help you see how chemistry interconnects with itself.

➔ This sort of margin note will mainly contain cross-references to other parts of the book as a further aid to navigation. You will find an example on p. 10.

■ Sometimes the main text of the book needs clarification or expansion, and this sort of margin note will contain such little extras to help you understand difficult points. It will also remind you of things from elsewhere in the book that illuminate what is being discussed. You would do well to read these notes the first time you read the chapter, although you might choose to skip them later as the ideas become more familiar.

 This icon indicates that related interactive resources are available online. A full explanation of how to find these resources is given in a purple panel on the first page of each chapter

Boxes and margin notes

The other things you should look out for throughout the text are the margin notes and boxes. There are four sorts:

- **The most important box looks like this. Anything in this sort of box is a key concept or a summary. It's the sort of thing you would do well to hold in your mind as you read or to note down as you learn.**

Boxes like this will contain additional examples, amusing background information, and similar interesting, but maybe inessential, material. The first time you read a chapter, you might want to miss out this sort of box, and only read them later on to flesh out some of the main themes of the chapter.

Online support

Organic structures and organic reactions are three-dimensional (3D), and as a complement to the necessarily two-dimensional representations in this book we have developed a comprehensive online resource to allow you to appreciate the material in three dimensions. ChemTube3D contains interactive 3D animations and structures, with supporting information, for some of the most important topics in organic chemistry, to help you master the concepts presented in this book. Online resources are flagged on the pages to which they relate by an icon in the margin. Each web page contains some information about the reaction and an intuitive interactive reaction scheme that controls the display. 3D curly arrows indicate the reaction mechanism, and the entire sequence from starting materials via transition state to products is displayed with animated bond-breaking and forming, and animated charges and lone pairs. The entire process is under the control of you, the user, and can be viewed in three dimensions from any angle. The resizable window button produces a larger window with a range of control options and the molecular photo booth allows you to make a permanent record of the view you want.

ChemTube3D uses Jmol to display the animations so users can interact with the animated 3D structures using the pop-up menu or console using only a web browser. It is ideal for personalized learning and open-ended investigation is possible. We suggest that you make use of the interactive resources once you have read the relevant section of the book to consolidate your understanding of chemistry and enhance your appreciation of the importance of spatial arrangements.

Substantial modifications were made in the writing of this new edition, including the loss or contraction of four chapters found towards the end of the first edition. To preserve this material for future use, the following four chapters from the first edition are available for download from the book's website at www.oxfordtextbooks.co.uk/orc/clayden2e/:

- The chemistry of life
- Mechanisms in biological chemistry
- Natural products
- Polymerization

Further reading

At the end of each chapter, you may find yourself wanting to know more about the material it covers. We have given a collection of suggested places to look for this material—other books, or reviews in the chemical literature, or even some original research papers. There are thousands of examples in this book, and in most cases we have not directed you to the reports of the original work—this can usually be found by a simple electronic database search. Instead, we have picked out publications which seem most interesting, or relevant. If you want an encyclopaedia of organic chemistry, this is not the book for you. You would be better turning to one such as *March's Advanced Organic Chemistry* (M. B. Smith and J. March, 6th edn, Wiley, 2007), which contains thousands of references.

Problems

You can't learn all of organic chemistry—there's just too much of it. You can learn trivial things like the names of compounds but that doesn't help you understand the principles behind the subject. You have to *understand* the principles because the only way to tackle organic chemistry is to learn to work it out. That is why we have provided problems, which you can access from the book's web site. They are to help you discover if you have understood the material presented in each chapter.

If a chapter is about a certain type of organic reaction, say elimination reactions (Chapter 19), the chapter itself will describe the various ways ('mechanisms') by which the reaction can occur and it will give definitive examples of each mechanism. In Chapter 19 there are three mechanisms and about 60 examples altogether. You might think that this is rather a lot but there are in fact millions of examples known of these three mechanisms and Chapter 19 barely scrapes the surface. The problems will help you make sure that your understanding is sound, and that it will stand up to exposure to the rigours of explaining real-life chemistry.

In general, the 10–15 problems at the end of each chapter start easy and get more difficult. They come in two or three sorts. The first, generally shorter and easier, allow you to revise the material in that chapter. They might revisit examples from the chapter to check that you can use the ideas in familiar situations. The next few problems might develop specific ideas from different parts of the chapter, asking you, for example, why one compound reacts in one way while a similar one behaves quite differently. Finally, you will find some more challenging problems asking you to extend the ideas to unfamiliar molecules, and, especially later in the book, to situations which draw on the material from more than one chapter.

The end-of-chapter problems should set you on your way but they are not the end of the journey to understanding. You are probably reading this text as part of a university course and you should find out what kind of examination problems your university uses and practise them too. Your tutor will be able to advise you on suitable problems to help you at each stage of your development.

The solutions manual

The problems would be of little use to you if you could not check your answers. For maximum benefit, you need to tackle some or all of the problems as soon as you have finished each chapter without looking at the answers. Then you need to compare your suggestions with ours. You will find our suggestions in the accompanying solutions manual, where each problem is discussed in some detail. (You can buy the solutions manual separately from this book.) The purpose of the problem is first stated or explained. Then, if the problem is a simple one, the answer is given. If the problem is more complex, a discussion of possible answers follows with some comments on the value of each. There may be a reference to the source of the problem so that you can read further if you wish.

 To access the problems just visit www.oxfordtextbooks.co.uk/orc/clayden2e. The problems are available free of charge; you'll just need the username and password given at the very front of this book

Colour

If you have flicked forward through the pages of this book, you will already have noticed something unusual: almost all of the chemical structures are shown in red. This is quite intentional: emphatic red underlines the message that structures are more important than words in organic chemistry. But sometimes small parts of structures are in other colours: here are two examples from p. 12, where we talk about organic compounds containing elements other than C and H.

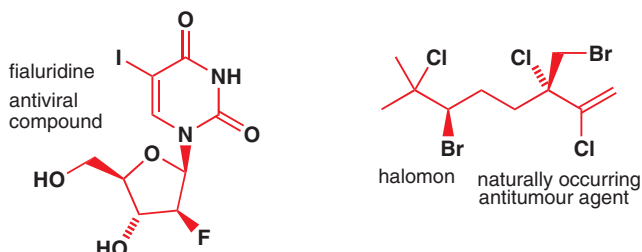

Why are the atom labels black? Because we wanted them to stand out from the rest of the molecule. In general you will see black used to highlight the important details of a molecule—they may be the groups taking part in a reaction, or something that has changed as a result of the reaction, as in these examples from Chapters 9 and 17.

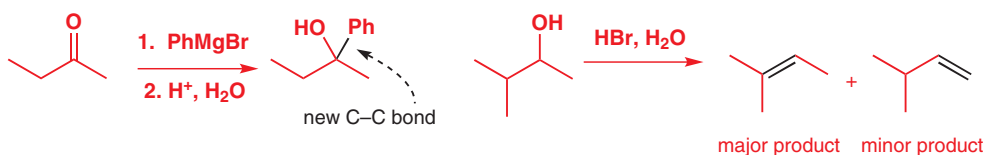

We shall often use black to emphasize ‘curly arrows’, devices that show the movement of electrons, and whose use you will learn about in Chapter 5. Here are examples from Chapters 11 and 22: notice black also helps the ‘+’ and ‘-’ charges to stand out.

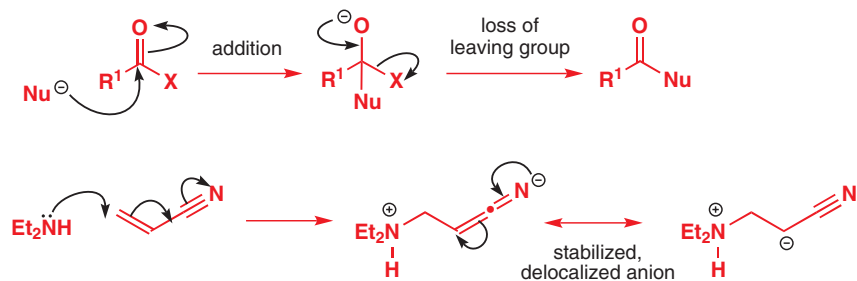

Occasionally, we shall use other colours, such as green, orange, or brown, to highlight points of secondary importance. This example is part of a reaction taken from Chapter 19: we want to show that a molecule of water (H₂O) is formed. The green atoms show where the water comes from. Notice black curly arrows and a new black bond.

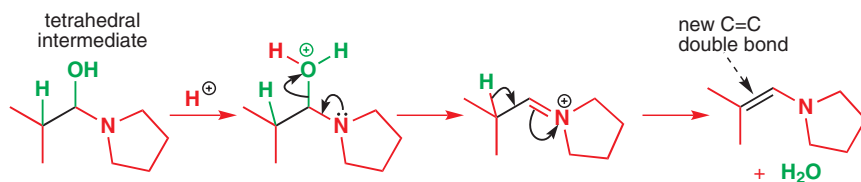

Other colours come in when things get more complicated—in this Chapter 21 example, we want to show two possible outcomes of a reaction: the brown and the orange arrows show the two alternatives, with the green highlighting the deuterium atom remaining in both cases.

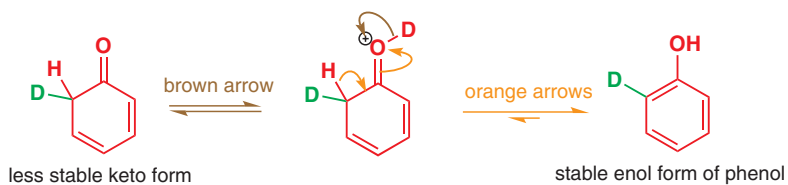

And, in Chapter 14, colour helps us highlight the difference between carbon atoms carrying four different groups and those with only three different groups. The message is: if you see something in a colour other than red, take special note—the colour is there for a reason.

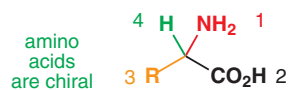

except glycine—plane of paper is a plane of symmetry through C, N, and CO₂H

This page intentionally left blank

What is organic chemistry?

Organic chemistry and you

You are already a highly skilled organic chemist. As you read these words, your eyes are using an organic compound (retinal) to convert visible light into nerve impulses. When you picked up this book, your muscles were doing chemical reactions on sugars to give you the energy you needed. As you understand, gaps between your brain cells are being bridged by simple organic molecules (neurotransmitter amines) so that nerve impulses can be passed around your brain. And you did all that without consciously thinking about it. You do not yet understand these processes in your mind as well as you can carry them out in your brain and body. You are not alone there. No organic chemist, however brilliant, understands the detailed chemical working of the human mind or body very well.

We, the authors, include ourselves in this generalization, but we are going to show you in this book what enormous strides have been taken in the understanding of organic chemistry since the science came into being in the early years of the nineteenth century. Organic chemistry began as a tentative attempt to understand the chemistry of life. It has grown into the confident basis of worldwide activities that feed, clothe, and cure millions of people without their even being aware of the role of chemistry in their lives. Chemists cooperate with physicists and mathematicians to understand how molecules behave and with biologists to understand how interactions between molecules underlie all of life. The enlightenment brought by chemistry in the twentieth century amounted to a revolution in our understanding of the molecular world, but in these first decades of the twenty-first century the revolution is still far from complete. We aim not to give you the measurements of the skeleton of a dead science but to equip you to understand the conflicting demands of an adolescent one.

Like all sciences, chemistry has a unique place in our pattern of understanding of the universe. It is the science of molecules. But organic chemistry is something more. It literally creates itself as it grows. Of course we need to study the molecules of nature both because they are interesting in their own right and because their functions are important to our lives. Organic chemistry has always been able to illuminate the mechanisms of life by making new molecules that give information not available from the molecules actually present in living things.

This creation of new molecules has given us new materials such as plastics to make things with, new dyes to colour our clothes, new perfumes to wear, new drugs to cure diseases. Some people think some of these activities are unnatural and their products dangerous or unwholesome. But these new molecules are built by humans from other molecules found naturally on earth using the skills inherent in our natural brains. Birds build nests; people build houses. Which is unnatural? To the organic chemist this is a meaningless distinction. There are toxic compounds and nutritious ones, stable compounds and reactive ones—but there is only one type of chemistry: it goes on both inside our brains and bodies, and also in our flasks and reactors, born from the ideas in our minds and the skill in our hands. We are not going to set ourselves up as moral judges in any way. We believe it is right to try and understand the world

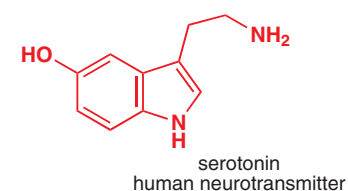
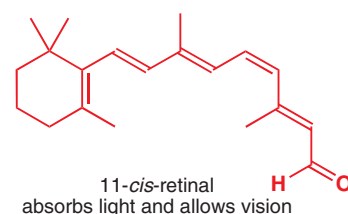

■ We are going to illustrate this chapter with the structures of the organic compounds we talk about. If you do not understand the diagrams, just read the text. Explanation of the rest is on its way.

about us as best we can and to use that understanding creatively. This is what we want to share with you.

■ At the other end of this book (Chapter 42) you will read about the extraordinary chemistry that allows life to exist—facts that are known only from cooperation between chemists and biologists.

Organic compounds

Organic chemistry started as the chemistry of life, when that was thought to be different from the chemistry in the laboratory. Then it became the chemistry of carbon compounds, especially those found in coal. But now it is both. It is the chemistry of the compounds formed by carbon and other elements such as are found in living things, in the products of living things, and wherever else carbon is found.

The most abundant organic compounds are those present in living things and those formed over millions of years from dead things. In earlier times, the organic compounds known from nature were those in the ‘essential oils’ that could be distilled from plants and the alkaloids that could be extracted from crushed plants with acid. Menthol is a famous example of a flavouring compound from the essential oil of spearmint and *cis*-jasmone an example of a perfume distilled from jasmine flowers.

Natural products have long been used to cure diseases, and in the sixteenth century one became famous—quinine was extracted from the bark of the South American cinchona tree and used to treat fevers, especially malaria. The Jesuits who did this work (the remedy was known as ‘Jesuit’s bark’) did not of course know what the structure of quinine was, but now we do. More than that, the molecular structure of quinine has inspired the design of modern drug molecules which treat malaria much more effectively than quinine itself.

The main reservoir of chemicals available to the nineteenth century chemists was coal. Distillation of coal to give gas for lighting and heating (mainly hydrogen and carbon monoxide) also gave a brown tar rich in aromatic compounds such as benzene, pyridine, phenol, aniline, and thiophene.

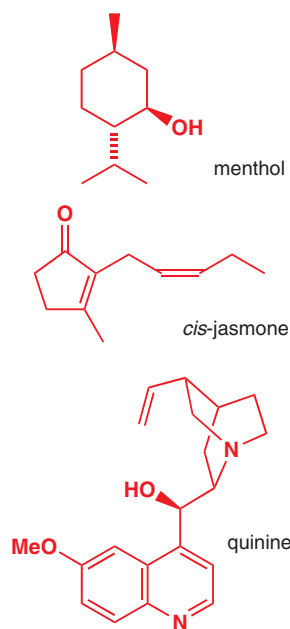

benzene



pyridine

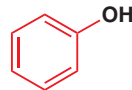

phenol

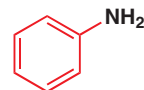

aniline



thiophene

Perkin was studying in London with the great German chemist, Hofmann. Perkin’s attempt to make quinine this way was a remarkable practical challenge given that its structure was still unknown.

Phenol was used in the nineteenth century by Lister as an antiseptic in surgery, and aniline became the basis for the dyestuffs industry. It was this that really started the search for new organic compounds made by chemists rather than by nature. In 1856, while trying to make quinine from aniline, an 18-year old British chemist, William Perkin, managed to produce a mauve residue, mauveine, which revolutionized the dyeing of cloth and gave birth to the synthetic dyestuffs industry. A related dyestuff of this kind—still available—is Bismarck Brown: much of the early work on dyes was done in Germany.

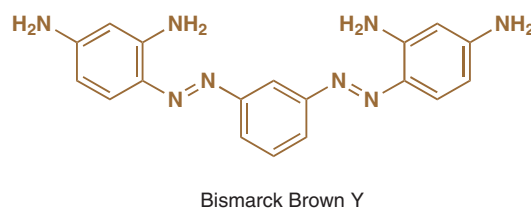
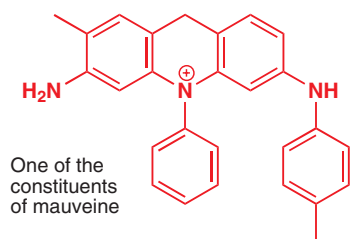

In the twentieth century oil overtook coal as the main source of bulk organic compounds so that simple hydrocarbons like methane (CH₄, ‘natural gas’), propane, and butane (CH₃CH₂CH₃ and CH₃CH₂CH₂CH₃, ‘calor gas’ or LPG) became available for fuel. At the same time chemists began the search for new molecules from new sources such as fungi, corals, and bacteria, and two organic chemical industries developed in parallel—‘bulk’ and







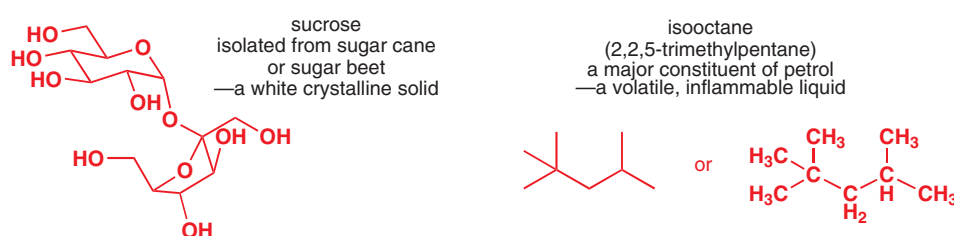

'fine' chemicals. Bulk chemicals like paints and plastics are usually based on simple molecules produced in multitonne quantities while fine chemicals such as drugs, perfumes, and flavouring materials are produced in smaller quantities but much more profitably.

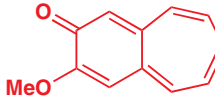
At the time of writing there were over 16 million organic compounds known. How many more might there be? Even counting only moderately sized molecules, containing fewer than about 30 carbon atoms (about the size of the mauveine structure above), it has been calculated that something in the region of 1,000 (10⁶³) stable compounds are possible. There aren't enough carbon atoms in the universe to make them all.

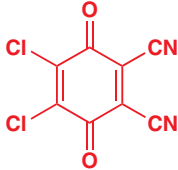
Among the 16 million that have been made, there are all kinds of molecules with amazingly varied properties. What do they look like? They may be crystalline solids, oils, waxes, plastics, elastics, mobile or volatile liquids, or gases. Familiar ones include sugar, a cheap natural compound isolated from plants as hard white crystals when pure, and petrol, a mixture of colourless, volatile, flammable hydrocarbons. Isooctane is a typical example and gives its name to the octane rating of petrol.

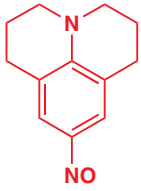

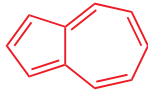
The compounds need not lack colour. Indeed we can soon dream up a rainbow of organic compounds covering the whole spectrum, not to mention black and brown. In this table we have avoided dyestuffs and have chosen compounds as varied in structure as possible.

Colour	Description	Compound	Structure
	dark red hexagonal plates	3-methoxybenzocycloheptatriene-2-one	
	amber needles	dichlorodicyanoquinone (DDQ)	
	toxic yellow explosive gas	diazomethane	$\text{H}_2\text{C}=\text{N}=\text{N}^{\ominus}$
	green prisms with a steel-blue lustre	9-nitrosojulolidine	
	deep blue liquid with a peppery smell	azulene	
	deep blue gas condensing to a purple solid	nitrosotrifluoromethane	$\text{F}_3\text{C}-\text{N}=\text{O}$

skunk spray contains:

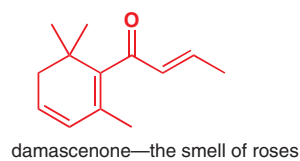
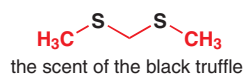
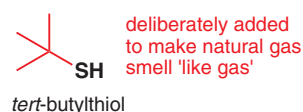
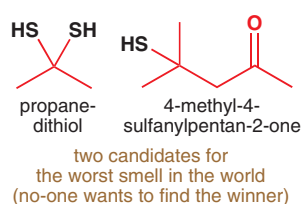
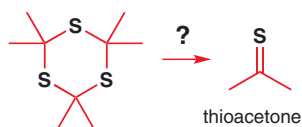
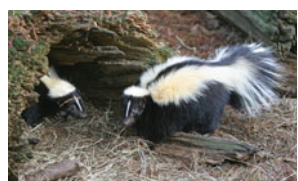

Colour is not the only characteristic by which we recognize compounds. All too often it is their odour that lets us know they are around. There are some quite foul organic compounds too; the infamous stench of the skunk is a mixture of two thiols—sulfur compounds containing SH groups.

But perhaps the worst smell ever recorded was that which caused the evacuation of the German city of Freiburg in 1889. Attempts to make thioacetone by the cracking of trithioacetone gave rise to 'an offensive smell which spread rapidly over a great area of the town causing fainting, vomiting, and a panic evacuation...the laboratory work was abandoned'.

It was perhaps foolhardy for workers at an Esso research station to repeat the experiment of cracking trithioacetone south of Oxford in 1967. Let them take up the story. 'Recently we found ourselves with an odour problem beyond our worst expectations. During early experiments, a stopper jumped from a bottle of residues, and, although replaced at once, resulted in an immediate complaint of nausea and sickness from colleagues working in a building two hundred yards away. Two of our chemists who had done no more than investigate the cracking of minute amounts of trithioacetone found themselves the object of hostile stares in a restaurant and suffered the humiliation of having a waitress spray the area around them with a deodorant. The odours defied the expected effects of dilution since workers in the laboratory did not find the odours intolerable ... and genuinely denied responsibility since they were working in closed systems. To convince them otherwise, they were dispersed with other observers around the laboratory, at distances up to a quarter of a mile, and one drop of either acetone *gem*-dithiol or the mother liquors from crude trithioacetone crystallizations were placed on a watch glass in a fume cupboard. The odour was detected downwind in seconds.'

There are two candidates for this dreadful smell—propane dithiol (called acetone *gem*-dithiol above) or 4-methyl-4-sulfanylpentan-2-one. It is unlikely that anyone else will be brave enough to resolve the controversy.

But nasty smells have their uses. The natural gas piped into homes contains small amounts of deliberately added sulfur compounds such as *tert*-butyl thiol ($(\text{CH}_3)_3\text{CSH}$). When we say small, we mean *very small*—humans can detect one part in 50,000,000,000 parts of natural gas.

Other compounds have delightful odours. To redeem the honour of sulfur compounds we must cite the truffle, which pigs can smell through a metre of soil and whose taste and smell is so delightful that truffles cost more than their weight in gold. Damascenones are responsible for the smell of roses. If you smell one drop you will be disappointed, as it smells rather like turpentine or camphor, but next morning you, and the clothes you were wearing, will smell powerfully of roses. Many smells develop on dilution.

Humans are not the only creatures with a sense of smell. We can find mates using all our senses, but insects cannot do this. They are small in a crowded world and they find those of the opposite sex of their own species by smell. Most insects produce volatile compounds that can be picked up by a potential mate in incredibly weak concentrations. Only 1.5 mg of serricornin, the sex pheromone of the cigarette beetle, could be isolated from 65,000 female beetles—so there isn't much in each beetle. Nevertheless, the slightest whiff of it causes the males to gather and attempt frenzied copulation. The sex pheromone of the beetle *Popilia japonica*, also given off by the females, has been made by chemists. As little as 5 μg (micrograms, note!) was more effective than four virgin females in attracting the males.

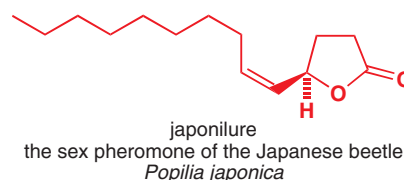
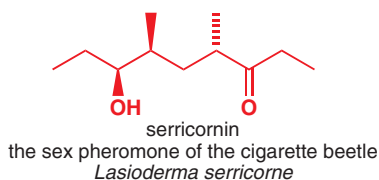

The pheromone of the gypsy moth, disparlure, was identified from a few μg isolated from the moths: as little as 2×10^{-12} g is active as a lure for the males in field tests. The three pheromones we have mentioned are available commercially for the specific trapping of these destructive insect pests.

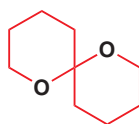
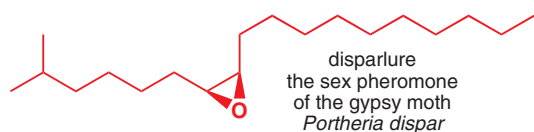

Gypsy moth

Don't suppose that the females always do all the work; both male and female olive flies produce pheromones that attract the other sex. The remarkable thing is that one mirror image of the molecule attracts the males while the other attracts the females! Mirror image isomers of a molecule called frontalin are also emitted by male elephants; female elephants can tell the age and appeal of a potential mate from the amount of each isomer he produces.



What about taste? Take the grapefruit. The main flavour comes from another sulfur compound and human beings can detect 2×10^{-5} parts per billion of this compound. This is an almost unimaginably small amount equal to 10^{-4} mg per tonne or a drop, not in a bucket, but in a fairly large lake. Why evolution should have left us so extraordinarily sensitive to grapefruit, we leave you to imagine.

For a nasty taste, we should mention 'bittering agents', put into dangerous household substances like toilet cleaner to stop children drinking them by accident. Notice that this complex organic compound is actually a salt—it has positively charged nitrogen and negatively charged oxygen atoms—and this makes it soluble in water.

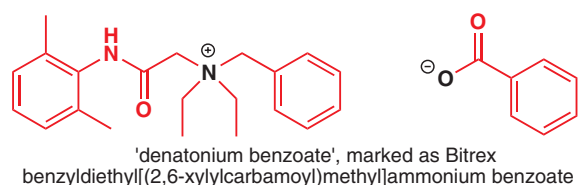

Other organic compounds have strange effects on humans. Various 'drugs' such as alcohol and cocaine are taken in various ways to make people temporarily happy. They have their dangers. Too much alcohol leads to a lot of misery and any cocaine at all may make you a slave for life.

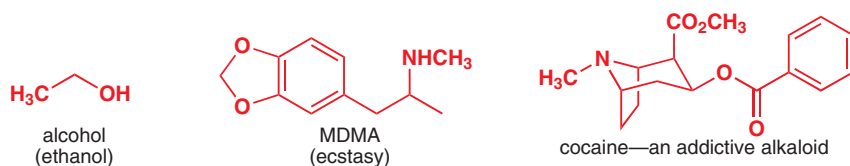

Again, let's not forget other creatures. Cats seem to be able to go to sleep anywhere, at any time. This surprisingly simple compound, isolated from the cerebrospinal fluid of cats, appears to be part of their sleep-control mechanism. It makes them, or rats, or humans fall asleep immediately.

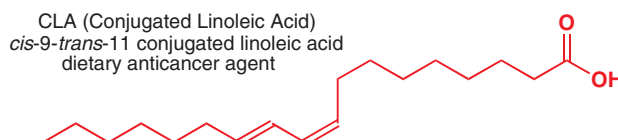
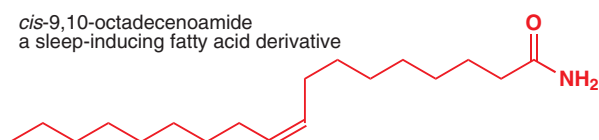

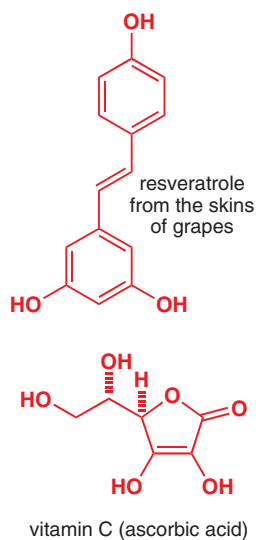

This compound and disparlure (above) are both derivatives of fatty acids. Fatty acids in the diet are a popular preoccupation, and the good and bad qualities of saturates, monounsaturates, and polyunsaturates are continually in the news: one of the many dietary molecules reckoned to have demonstrable anticancer activity is CLA (conjugated linoleic acid), which is found in dairy products and also, most abundantly, you may be interested to know, in kangaroo meat.

Resveratrol is another dietary component with beneficial effects: it may be responsible for the apparent ability of red wine to prevent heart disease. It is a quite different sort of organic compound, with two benzene rings.

For a third edible molecule, how about vitamin C? This is an essential factor in your diet—that is why it is called a vitamin—and in the diet of other primates, guinea-pigs, and fruit bats (other mammals possess the biochemical machinery to make it themselves). The disease scurvy, a degeneration of soft tissues from which sailors on the long voyages of past centuries suffered, results from a lack of vitamin C. It also is a universal antioxidant, scavenging for rogue reactive radicals and protecting damage to DNA. Some people think an extra large intake may even protect against the common cold.

Organic chemistry and industry

Vitamin C is manufactured on a huge scale by Roche, a Swiss company. All over the world there are chemistry-based companies making organic molecules on scales varying from a few kilograms to thousands of tonnes per year. This is good news for students of organic chemistry: knowing how molecules behave and how to make them is a skill in demand, and it is an international job market.

The petrochemicals industry consumes huge amounts of crude oil: the largest refinery in the world, in Jamnagar, India, processes 200 million litres of crude oil every day. An alarmingly large proportion of this is still just burnt as fuel, but some of it is purified or converted into organic compounds for use in the rest of the chemical industry.

Some simple compounds are made both from oil and from plants. The ethanol used as a starting material to make other compounds in industry is largely made by the catalytic hydration of ethylene from oil. But ethanol is also used as a fuel, particularly in Brazil, where it is made by fermentation of sugar cane. Plants are extremely powerful organic chemical factories (with sugar cane being among the most efficient of all of them). Photosynthesis extracts carbon dioxide directly from the air and uses solar energy to reduce it to form less oxygen-rich organic compounds from which energy can be re-extracted by combustion. Biodiesel is made in a similar way from the fatty acid components of plant oils.



ethyl stearate (ethyl octadecanoate), a major component of biodiesel

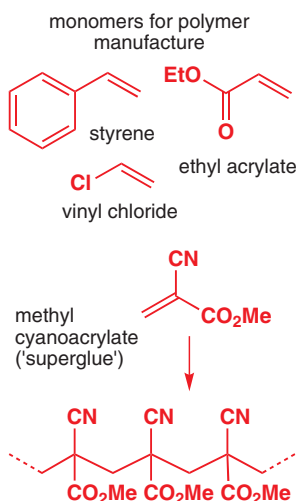
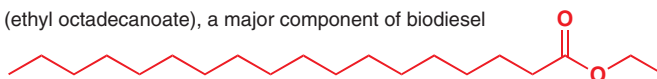

Plastics and polymers take much of the production of the petrochemical industry in the form of monomers such as styrene, acrylates, and vinyl chloride. The products of this enormous industry are everything made of plastic, including solid plastics for household goods and furniture, fibres for clothes (over 25 million tonnes per annum), elastic polymers for car tyres, light bubble-filled polymers for packing, and so on. Worldwide 100 million tonnes of polymers are made per year and PVC manufacture alone employs over 50,000 people to make over 20 million tonnes per year.

Many adhesives work by polymerization of monomers, which can be applied as a simple solution. You can glue almost anything with 'superglue', a polymer of methyl cyanoacrylate.

Washing-up bowls are made of the polymer polyethylene but the detergent you put in them belongs to another branch of the chemical industry—companies like Unilever and Procter and Gamble produce detergent, cleaners, bleaches, and polishes, along with soaps, gels, cosmetics, and shaving foams. These products may smell of lemon, lavender, or sandalwood but they too mostly come from the oil industry.

Products of this kind tend to underplay their petrochemical origins and claim affinity with the perceived freshness and cleanliness of the natural world. They also try to tell us, after a

fashion, what they contain. Try this example—the list of contents from a well-known brand of shower gel, which we are reassuringly told is ‘packed with natural stuff’ (including 10 ‘real’ lemons) and contains ‘100% pure and natural lemon and tea tree essential oils’.

It doesn’t all make sense to us, but here is a possible interpretation. We certainly hope this book will set you on the path of understanding the sense (and the nonsense!) of this sort of thing.

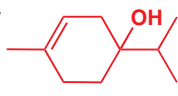
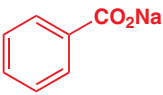
Ingredient	Chemical meaning	Purpose
aqua	$\text{H}-\text{O}-\text{H}$ water	solvent
sodium laureth sulfate	$\text{C}_{12}\text{H}_{25}(\text{O}-\text{CH}_2-\text{CH}_2)_n\text{OSO}_3\text{Na}$ typically $n = 3$	detergent
cocamide DEA	$\text{C}_{11}\text{H}_{23}-\text{C}(=\text{O})-\text{N}(\text{CH}_2\text{CH}_2\text{OH})_2$	foaming agent
<i>Citrus medica limonum</i> peel oil	mainly  α -pinene	scent, appeal to customer
<i>Melaleuca alternifolia</i> leaf oil	mainly  terpinen-4-ol	scent, appeal to customer, possibly antiseptic
glycerin	$\text{HO}-\text{CH}_2-\text{CH}(\text{OH})-\text{CH}_2-\text{OH}$ glycerol	cosolvent; moisturizer; ensures smoothness
cocamidopropyl betaine	$\text{C}_{11}\text{H}_{24}-\text{C}(=\text{O})-\text{NH}-\text{CH}_2-\text{CH}_2-\text{CH}_2-\text{N}^+(\text{CH}_3)_2-\text{CH}_2-\text{COO}^-$	detergent and anti-electrostatic
sodium chloride	NaCl	control solubility of Na^+ -based detergents
lactic acid	$\text{CH}_3-\text{CH}(\text{OH})-\text{CO}_2\text{H}$	acidifier
styrene acrylates copolymer	$\left[\text{Ph}-\text{CH}_2-\text{CH} \right]_n \left[\text{CO}_2\text{R}-\text{CH}_2-\text{CH} \right]_m$ $\text{R} = \text{Me or H}$	film former
tetrasodium glutamate diacetate	$\text{NaO}_2\text{C}-\text{CH}_2-\text{CH}_2-\text{CH}(\text{CO}_2\text{Na})-\text{CH}_2-\text{N}(\text{CH}_2\text{CO}_2\text{Na})_2$	chelator, to prevent formation of insoluble scum in hard water
sodium benzoate		preservative

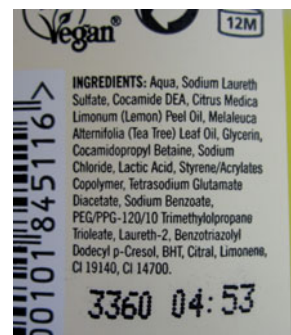
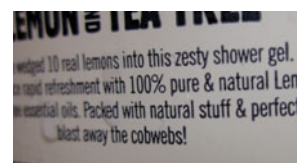

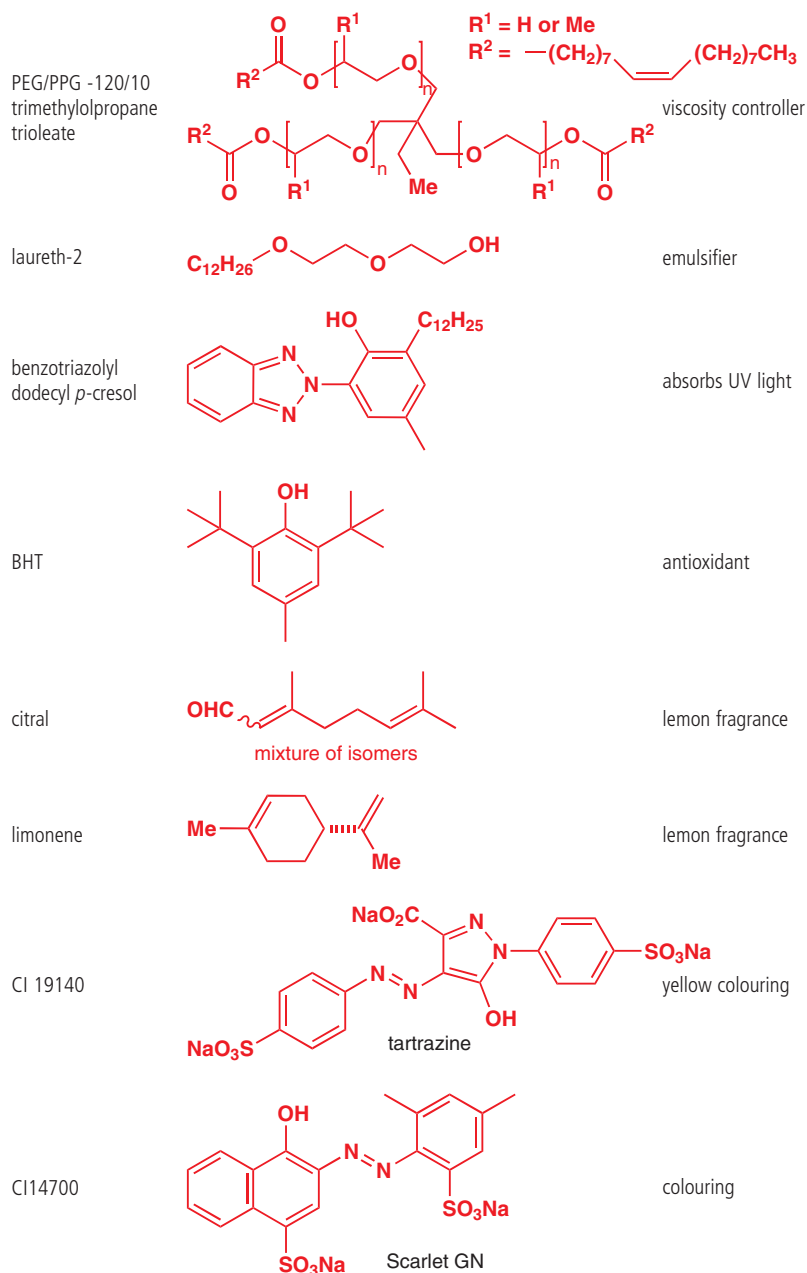

The particular detergents, surfactants, acids, viscosity controllers, and so on are chosen to blend together to give a smooth gel. The result should feel, smell, and look attractive and work as an effective detergent and shampoo (some of the compounds are added for their moisturizing and anti-electrostatic effect on hair). The yellow colour and lemon scent are considered fresh and clean by the customer. Several of the ingredients are added as pure compounds; the ones which aren't are mixtures of isomers or polymers; the most impure are the mixtures of hydrocarbons referred to as the 'pure and natural' essential oils. Is it 'packed with natural stuff'? Indeed it is. It all comes from natural sources, the principal one being decomposed carboniferous forests trapped for millions of years underground.

The coloration of manufactured goods is a huge business, with a range of intense colours required for dyeing cloth, colouring plastic and paper, painting walls, and so on. Leaders in this area are companies such as Akzo Nobel, which had sales of €14.6 bn in 2010. One of the most commonly used dyestuffs is indigo, an ancient dye that used to be isolated from plants but is now made from petrochemical feedstocks. It is the colour of blue jeans. More modern

dyestuffs can be represented by the benzodifuranones developed by ICI, which are used for colouring synthetic fabrics like polyesters (red), the phthalocyanine–metal complexes (typically blue or green), or the ‘high-performance’ red pigment DPP (1,4-diketopyrrolo[3,4-c]pyrroles) series developed by Ciba-Geigy.

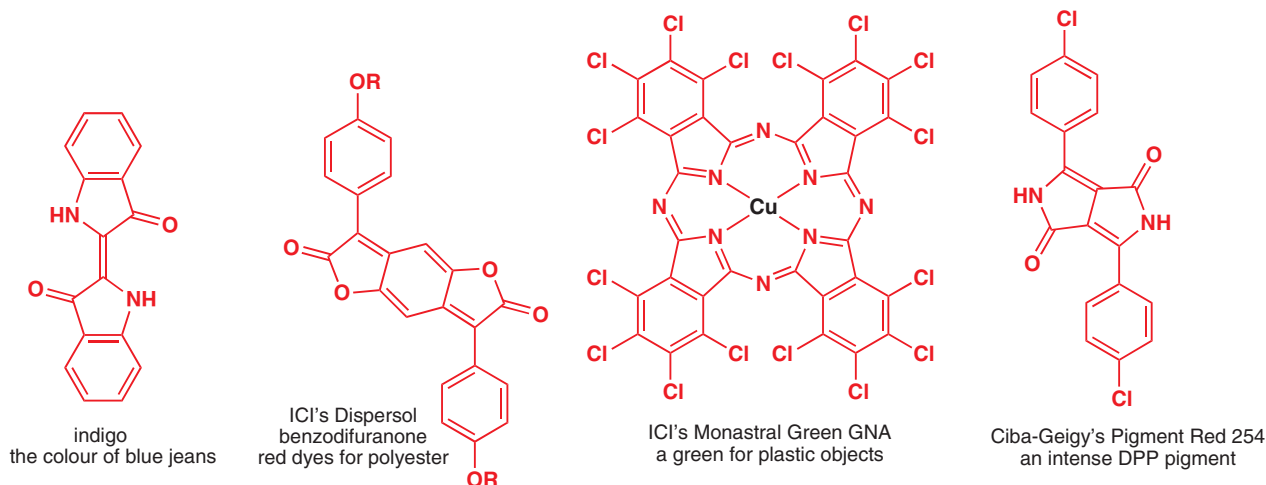

The scent of the shower gel above came from a mixture of plant extracts with the pure compound (in fact a mixture of two isomers) citral. The big fragrance and flavouring companies (such as Firmenich, International Flavors and Fragrances, and Givaudan) deal in both naturals and synthetics—‘naturals’ are mixtures of compounds extracted from plants—leaves, seeds, and flowers. ‘Synthetics’ are single compounds, sometimes present in plant-derived sources and sometime newly designed molecules, which are mixed with each other and with ‘naturals’ to build up a scent. A typical perfume will contain 5–10% fragrance molecules in an ethanol/water (about 90:10) mixture. So the perfumery industry needs a very large amount of ethanol and, you might think, not much perfumery material. In fact, important fragrances like jasmine are produced on a >10,000 tonnes per annum scale. The cost of a pure perfume ingredient like *cis*-jasmone (p. 2), the main ingredient of jasmine, may be several hundred pounds, dollars, or euros per gram.

The world of perfumery

Perfume chemists use extraordinary language to describe their achievements: ‘PacoRabanne pour homme was created to reproduce the effect of a summer walk in the open air among the hills of Provence: the smell of herbs, rosemary and thyme, and sparkling freshness with cool sea breezes mingling with warm soft Alpine air. To achieve the required effect, the perfumer blended herbaceous oils with woody accords and the synthetic aroma chemical dimethylheptanol, which has a penetrating but indefinable freshness associated with open air or freshly washed linen.’

Chemists produce synthetic flavourings such as ‘smoky bacon’ and even ‘chocolate’. Meaty flavours come from simple heterocycles such as alkyl pyrazines (present in coffee as well as roast meat) and furonol, originally found in pineapples. Compounds such as corylone and maltol give caramel and meaty flavours. Mixtures of these and other synthetic compounds can be ‘tuned’ to taste like many roasted foods from fresh bread to coffee and barbecued meat. Some flavouring compounds are also perfumes and may also be used as an intermediate in making other compounds. Vanillin is the main component of the flavour of vanilla, but is manufactured on a large scale for many other uses too.

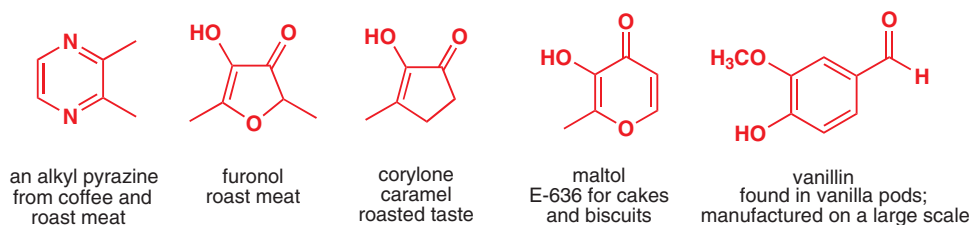

Food chemistry includes much larger-scale items than flavours. Sweeteners such as sugar itself are isolated from plants on an enormous scale. You saw sucrose on p. 3, but other sweeteners such as saccharin (discovered in 1879!) and aspartame (1965) are made on a sizeable scale. Aspartame is a compound of two of the natural amino acids present in all living things and over 10,000 tonnes per annum are made by the NutraSweet company.

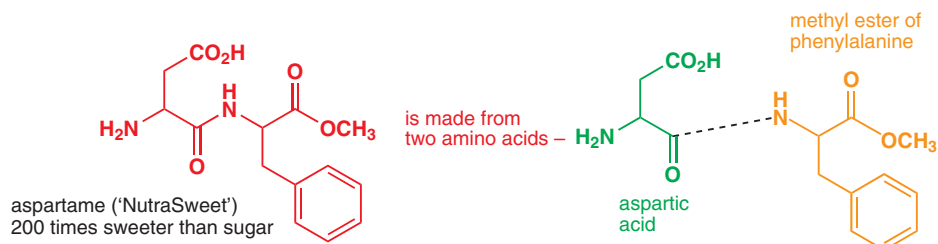

➡ The story of Tamiflu and how the ingenuity of chemists ensures a constant supply is related at the other end of this book, in Chapter 43.

One of the great revolutions of modern life has been the expectation that humans will survive diseases because of a specifically designed treatment. In the developed world, people live to old age because infections which used to kill can now be cured or kept at bay. Antibiotics are our defence against bacteria, preventing them from multiplying. One of the most successful of these is Beecham amoxicillin, which was developed by SmithKline. The four-membered ring at the heart of the molecule is the β -lactam, which targets the disease-causing bacteria. Medicinal chemists also protect us from the insidious threat of viruses which use the body's own biochemistry to replicate. Tamiflu is a line of defence against the ever-present danger of a flu epidemic, while ritonavir is one of the most advanced drugs designed to prevent replication of HIV and to slow down or prevent the onset of AIDS.

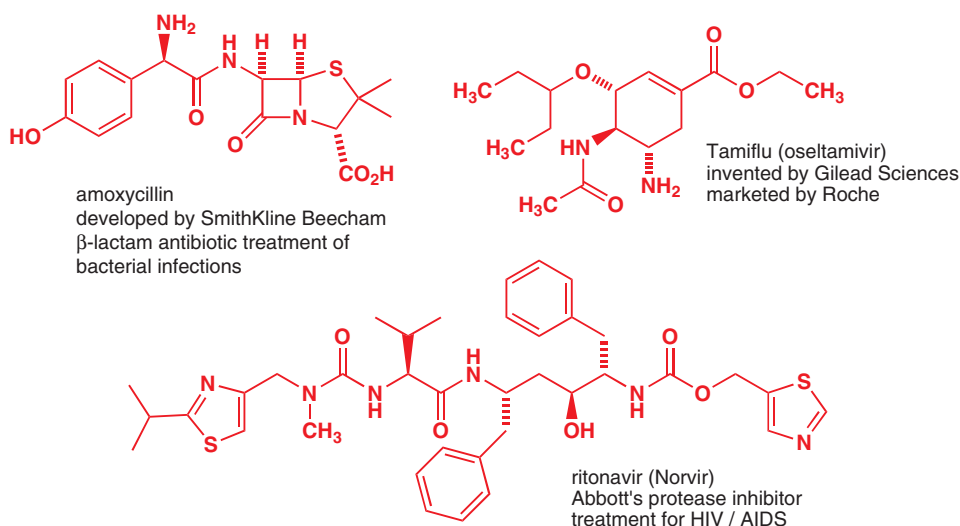

The best-selling current drugs are largely designed to address the human body's own failings. Sales of Lipitor and Nexium both topped \$5bn in 2009, figures which serve to illustrate the financial scale of developing safe and effective new treatments. Lipitor is one of the class of drugs known as statins, widely prescribed to control cholesterol levels in older people. Nexium is a proton pump inhibitor, which works to reduce peptic and duodenal ulcers. Sales of Glivec (developed by Novartis and introduced in 2001) are far smaller, but to those suffering from certain cancers such as leukaemia it can be a lifesaver.

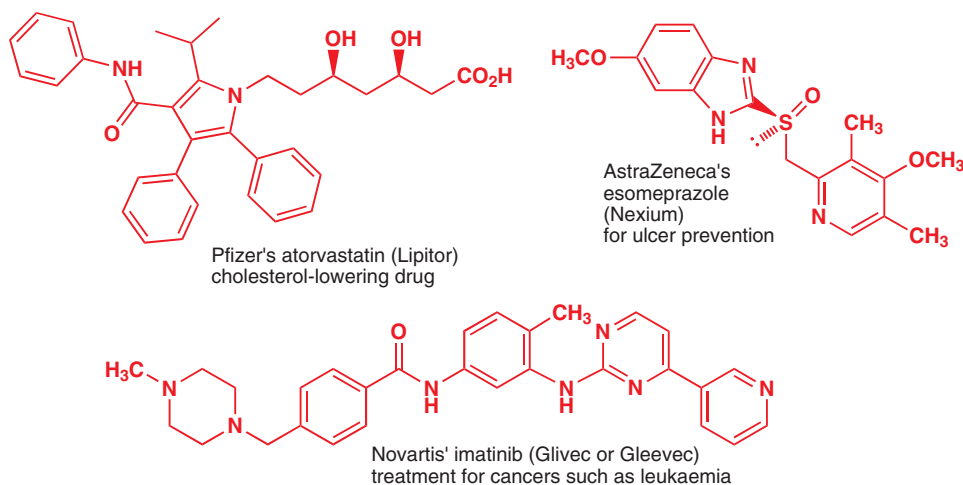

We cannot maintain our present high density of population in the developed world, nor deal with malnutrition in the developing world unless we preserve our food supply from attacks by insects and fungi and from competition by weeds. The world market for agrochemicals produced by multinationals such as Bayer CropScience and Syngenta is over £10bn per annum divided between herbicides, fungicides, and insecticides.

Many of the early agrochemicals were phased out as they were persistent environmental pollutants. Modern agrochemicals have to pass stringent environmental safety tests. The most famous modern insecticides are modelled on the plant-derived pyrethrins, stabilized against degradation in sunlight by chemical modification (the brown and green portions of decamethrin) and targeted to specific insects on specific crops. Decamethrin has a safety factor of >10,000 for mustard beetles over mammals, can be applied at only 10 grams per hectare (about one level tablespoon per football pitch), and leaves no significant environmental residue.

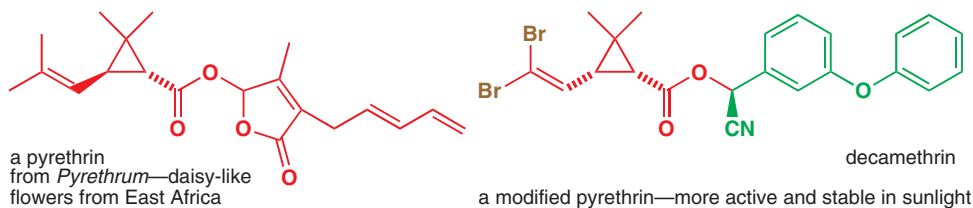

As you learn more chemistry, you will appreciate how remarkable it is that Nature should produce the three-membered rings in these compounds and that chemists should use them in bulk compounds to be sprayed on crops in fields. Even more remarkable in some ways are the fungicides based on a five-membered ring containing three nitrogen atoms—the triazole ring. These compounds inhibit an enzyme present in fungi but not in plants or animals. Fungal diseases are a real threat: as in the Irish potato famine of the nineteenth century, the various fungal blights, blotches, rots, rusts, smuts, and mildews can overwhelm any crop in a short time.

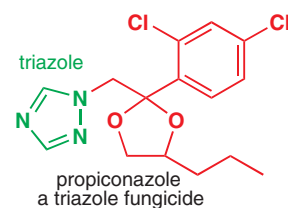

Organic chemistry and the periodic table

All the compounds we have shown you are built up on hydrocarbon (carbon and hydrogen) skeletons. Most have oxygen and/or nitrogen as well; some have sulfur and some phosphorus, and maybe the halogens (F, Cl, Br, and I). These are the main elements of organic chemistry.

But organic chemistry has also benefitted from the exploration of (some would say take-over bid for) the rest of the periodic table. The organic chemistry of silicon, boron, lithium, tin, copper, zinc, and palladium has been particularly well studied and these elements are common constituents of ‘organic’ reagents used in the laboratory. You will meet many of them throughout this book. Butyllithium, trimethylsilyl chloride, tributyltin hydride, diethylzinc, and lithium dimethylcuprate provide examples.

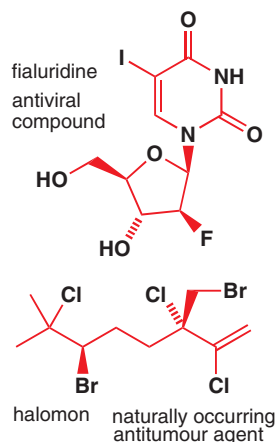

The halogens also appear in many life-saving drugs. Antiviral compounds such as fialuridine (which contains both F and I, as well as N and O) are essential for the fight against HIV and AIDS. They are modelled on natural compounds from nucleic acids. The naturally occurring cytotoxic (antitumour) agent halomon, extracted from red algae, contains Br and Cl.

The organic chemist's periodic table would have to emphasize all of these elements and more—the table below highlights most of those elements in common use in organic reactions. New connections are being added all the time—before the end of the last century the organic chemistry of ruthenium, gold, and samarium was negligible; now reagents and catalysts incorporating these metals drive a wide range of important reactions.

➔ We will devote whole chapters to the organic chemistry of S, P, and Si (Chapter 27) and to the transition metals, especially Pd (Chapter 40).

■ You will certainly know something about the periodic table from your previous studies of chemistry. A full Periodic Table appears on pp. 1184–1185 of this book, but basic knowledge of the groups, which elements are metals, and where the elements shown in this table appear will be helpful to you.

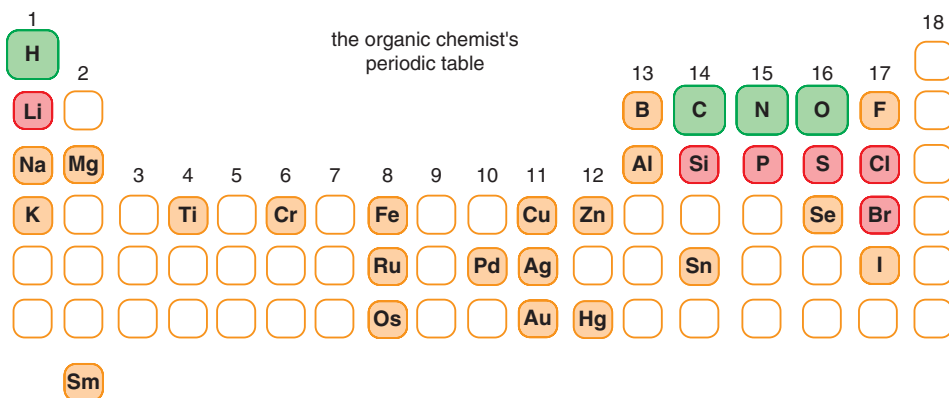

So where does inorganic chemistry end and organic chemistry begin? Would you say that the antiviral compound foscarnet was organic? It is a compound of carbon with the formula CPO₅Na₃ but it has no C–H bonds. And what about the important reagent tetrakis (triphenylphosphine)palladium? It has lots of hydrocarbon—12 benzene rings in fact—but the benzene rings are all joined to phosphorus atoms that are arranged in a square around the central palladium atom, so the molecule is held together by C–P and P–Pd bonds, not by a hydrocarbon skeleton. Although it has the very organic-looking formula C₇₂H₆₀P₄Pd, many people would say it is inorganic. But is it?

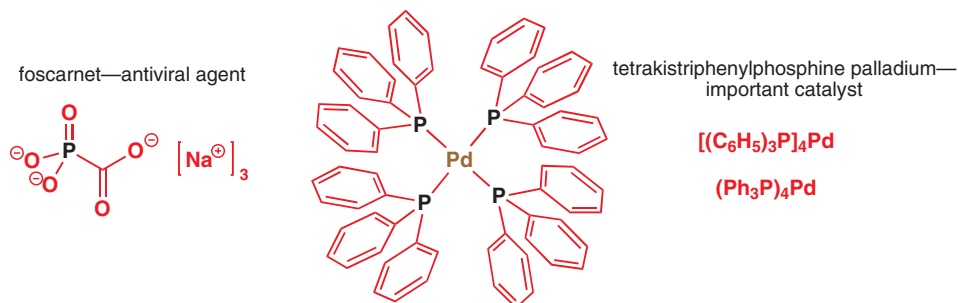

The answer is that we don't know and we don't care. Strict boundaries between traditional disciplines are undesirable and meaningless. Chemistry continues across the old boundaries between organic chemistry and inorganic chemistry, organic chemistry and physical chemistry or materials, or organic chemistry and biochemistry. Be glad that the boundaries are indistinct as that means the chemistry is all the richer. This lovely molecule $(\text{Ph}_3\text{P})_4\text{Pd}$ belongs to *chemistry*.

Organic chemistry and this book

We have told you about organic chemistry's history, the types of compounds it concerns itself with, the things it makes, and the elements it uses. Organic chemistry today is the study of the structure and reactions of compounds in nature, of compounds in the fossil reserves such as coal and oil, and of those compounds that can be made from them. These compounds will usually be constructed with a hydrocarbon framework but will also often have atoms such as O, N, S, P, Si, B, halogens, and metals attached to them. Organic chemistry is used in the making of plastics, paints, dyestuffs, clothes, foodstuffs, human and veterinary medicines, agrochemicals, and many other things. Now we can summarize all of these in a different way.

● The main components of organic chemistry as a discipline are:

- structure determination—how to find out the structures of new compounds even if they are available only in invisibly small amounts
- theoretical organic chemistry—how to understand these structures in terms of atoms and the electrons that bind them together
- reaction mechanisms—how to find out how these molecules react with each other and how to predict their reactions
- synthesis—how to design new molecules, and then make them
- biological chemistry—how to find out what Nature does and how the structures of biologically active molecules are related to what they do.

This book is about all these things. It is about the structures of organic molecules and the reasons behind those structures. It is about the shapes of these molecules and how the shape relates to their function, especially in the context of biology. It explains how these structures and shapes are discovered. It tells you about the reactions the molecules undergo and, more importantly, how and why they behave in the way they do. It tells you about nature and about industry. It tells you how molecules are made and how you too can think about making molecules.

This is the landscape through which you are about to travel. And, as with any journey to somewhere new, exciting, and sometimes challenging, the first thing is to make sure you have at least some knowledge of the local language. Fortunately the language of organic chemistry couldn't be simpler: it's all pictures. The next chapter will get us communicating.

Further reading

One interesting and amusing book you might enjoy is B. Selinger, *Chemistry in the Marketplace*, 5th edn, Harcourt Brace, Sydney, 2001.

Check your understanding



To check that you have mastered the concepts presented in this chapter, attempt the problems that are available in the book's Online Resource Centre at <http://www.oxfordtextbooks.co.uk/orc/clayden2e/>

Connections

➔ Building on

- This chapter does not depend on **Chapter 1**

Arriving at

- The diagrams used in the rest of the book
- Why we use these particular diagrams
- How organic chemists name molecules in writing and in speech
- What is the skeleton of an organic molecule
- What is a functional group
- Some abbreviations used by all organic chemists
- Drawing organic molecules realistically in an easily understood style

➔ Looking forward to

- Ascertaining molecular structure spectroscopically **ch3**
- What determines a molecule's structure **ch4**

There are over 100 elements in the periodic table. Many molecules contain well over 100 atoms—palytoxin (a naturally occurring compound with potential anticancer activity), for example, contains 129 carbon atoms, 221 hydrogen atoms, 54 oxygen atoms, and 3 nitrogen atoms. It's easy to see how chemical structures can display enormous variety, providing enough molecules to build even the most complicated living creatures.

■ Palytoxin was isolated in 1971 in Hawaii from *Limu make o Hane* ('deadly seaweed of Hana'), which had been used to poison spear points. It is one of the most toxic compounds known, requiring only about 0.15 micrograms per kilogram for death by injection. The complicated structure was determined a few years later.

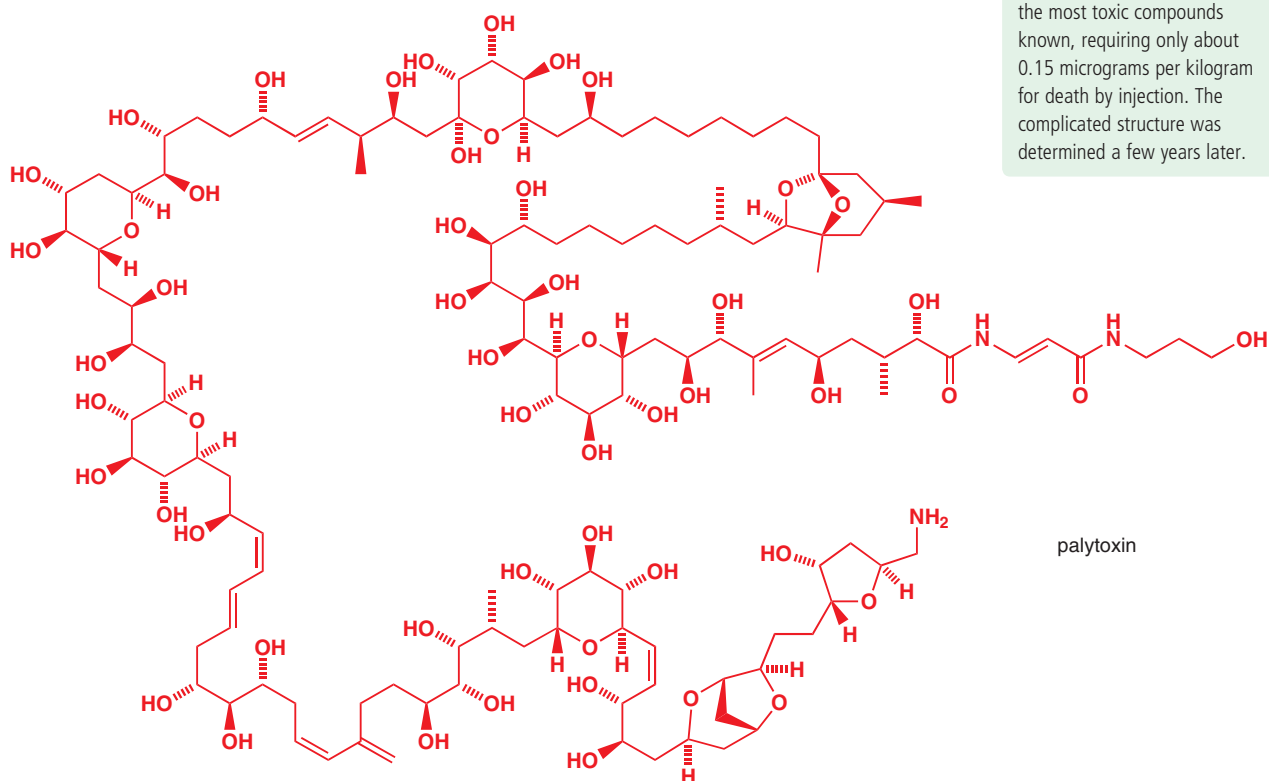

Online support. The icon  in the margin indicates that accompanying interactive resources are provided online to help your understanding: just type www.chemtube3d.com/clayden/123 into your browser, replacing **123** with the number of the page where you see the icon. For pages linking to more than one resource, type **123-1, 123-2** etc. (replacing **123** with the page number) for access to successive links.

But how can we understand what seems like a recipe for confusion? Faced with the collection of atoms we call a molecule, how can we make sense of what we see? This chapter will teach you how to interpret organic structures. It will also teach you how to draw organic molecules in a way that conveys all the necessary information and none of the superfluous.

Hydrocarbon frameworks and functional groups

As we explained in Chapter 1, organic chemistry is the study of compounds that contain carbon. Nearly all organic compounds also contain hydrogen; most also contain oxygen, nitrogen, or other elements. Organic chemistry concerns itself with the way in which these atoms are bonded together into stable molecular structures, and the way in which these structures change in the course of chemical reactions.

Some molecular structures are shown below. These molecules are all amino acids, the constituents of proteins. Look at the number of carbon atoms in each molecule and the way they are bonded together. Even within this small class of molecules there's great variety—*glycine* and *alanine* have only two or three carbon atoms; *phenylalanine* has nine.

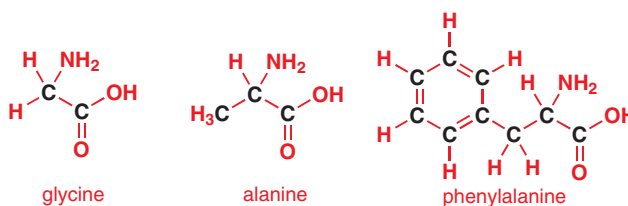

Lysine has a chain of atoms; *tryptophan* has rings.

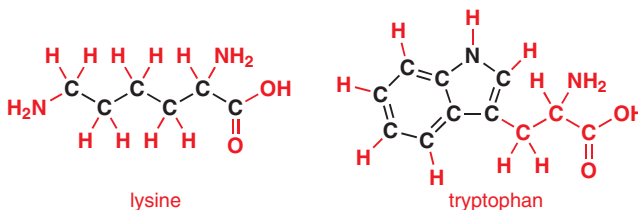

In *methionine* the atoms are arranged in a single chain; in *leucine* the chain is branched. In *proline*, the chain bends back on itself to form a ring.

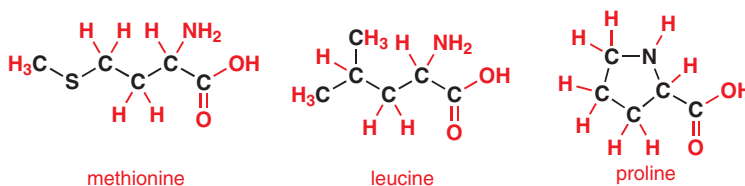

 Interactive amino acid structures

➔ We shall return to amino acids as examples several times in this chapter but we shall leave detailed discussion of their chemistry till Chapters 23 and 42 when we look at the way they polymerize to form peptides and proteins.

Yet all of these molecules have similar properties—they are all soluble in water, they are all both acidic and basic (amphoteric), they can all be joined with other amino acids to form proteins. This is because the chemistry of organic molecules depends much less on the number or the arrangement of carbon or hydrogen atoms than on the other types of atoms (O, N, S, P, Si...) in the molecule. We call parts of molecules containing small collections of these other atoms **functional groups**, simply because they are groups of atoms that determine the way the molecule works. All amino acids contain two functional groups: an amino (NH₂ or NH) group and a carboxylic acid (CO₂H) group (some contain other functional groups as well).

- The functional groups determine the way the molecule works both chemically and biologically.

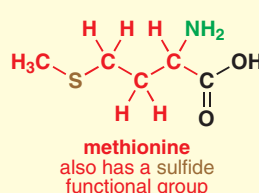
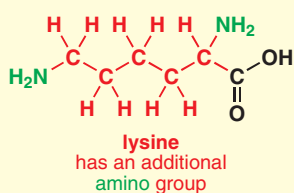
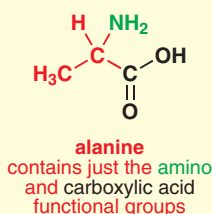

That isn't to say the carbon atoms aren't important; they just play quite a different role from those of the oxygen, nitrogen, and other atoms they are attached to. We can consider the chains and rings of carbon atoms we find in molecules as their skeletons, which support the functional groups and allow them to take part in chemical interactions, much as your skeleton supports your internal organs so they can interact with one another and work properly.

- The hydrocarbon framework is made up of chains and rings of carbon atoms, and it acts as a support for the functional groups.

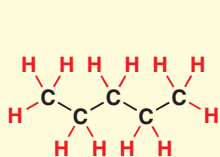

a chain

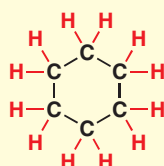

a ring

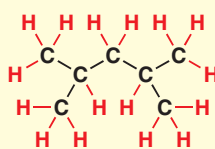

a branched chain

We will see later how the interpretation of organic structures as hydrocarbon frameworks supporting functional groups helps us to understand and rationalize the reactions of organic molecules. It also helps us to devise simple, clear ways of representing molecules on paper. You saw these structural diagrams in Chapter 1, and in the next section we shall teach you ways to draw (and ways not to draw) molecules—the handwriting of chemistry. *This section is extremely important* because it will teach you how to communicate chemistry, clearly and simply, throughout your life as a chemist.

Drawing molecules

Be realistic

Below is another organic structure—again, you may be familiar with the molecule it represents; it is a fatty acid commonly called linoleic acid.

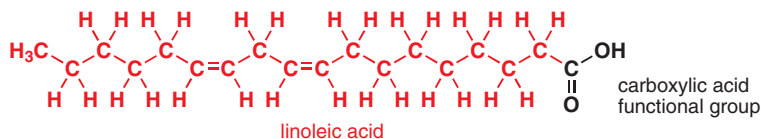

We could also depict linoleic acid as

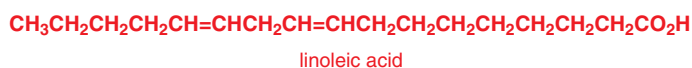

or as

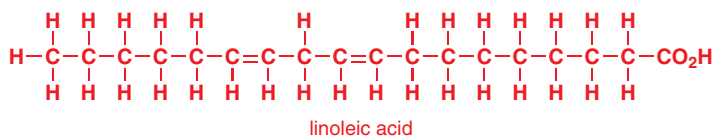

Organic skeletons

Organic molecules left to decompose for millions of years in the absence of light and oxygen become literally carbon skeletons—crude oil, for example, is a mixture of molecules consisting of nothing but carbon and hydrogen, while coal consists of little else but carbon. Although the molecules in coal and oil differ widely in chemical structure, they have one thing in common: no functional groups. Many are very unreactive: about the only chemical reaction they can take part in is combustion, which, in comparison to most chemical reactions that take place in chemical laboratories, is an extremely violent process. In Chapter 5 we shall start to look at the way that functional groups direct the chemical reactions of molecules.

■ Three fatty acid molecules and one glycerol molecule combine to form the fats that store energy in our bodies and are used to construct the membranes around our cells. This particular fatty acid, linoleic acid, cannot be synthesized in the human body but must be an essential component of a healthy diet found, for example, in sunflower oil. Fatty acids differ in the length of their chains of carbon atoms, yet they have very similar chemical properties because they all contain the carboxylic acid functional group. We shall come back to fatty acids in Chapter 42.

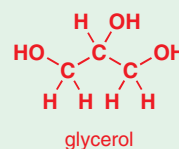

You may well have seen diagrams like these last two in older books—they used to be easy to print (in the days before computers) because all the atoms were in a line and all the angles were 90° . But are they realistic? We will consider ways of determining the shapes and structures of molecules in more detail in Chapter 3, but the picture below shows the structure of linoleic acid determined by X-ray crystallography.

■ X-ray crystallography discovers the structures of molecules by observing the way X-rays bounce off atoms in crystalline solids. It gives clear diagrams with the atoms marked as circles and the bonds as rods joining them together.

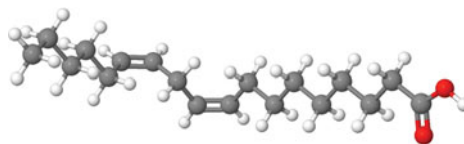

X-ray structure of linoleic acid

You can see that the chain of carbon atoms is not linear, but a zig-zag. Although our diagram is just a two-dimensional representation of this three-dimensional structure, it seems reasonable to draw it as a zig-zag too.

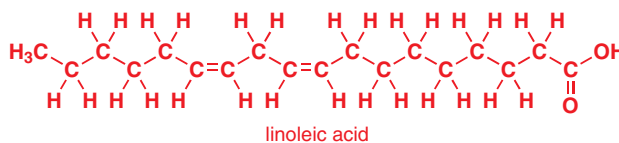

Interactive linoleic acid structure

This gives us our first guideline for drawing organic structures.

● **Guideline 1**

Draw chains of atoms as zig-zags.

Realism of course has its limits—the X-ray structure shows that the linoleic acid molecule is in fact slightly bent in the vicinity of the double bonds; we have taken the liberty of drawing it as a ‘straight zig-zag’. Similarly, close inspection of crystal structures like this reveals that the angle of the zig-zag is about 109° when the carbon atom is not part of a double bond and 120° when it is. The 109° angle is the ‘tetrahedral angle’, the angle between two vertices of a tetrahedron when viewed from its centre. In Chapter 4 we shall look at why carbon atoms take up this particular arrangement of bonds. Our realistic drawing is a projection of a three-dimensional structure onto flat paper so we have to compromise.

Be economical

When we draw organic structures we try to be as realistic as we can be without putting in superfluous detail. Look at these three pictures.



1



2



3

(1) is immediately recognizable as Leonardo da Vinci’s Mona Lisa. You may not recognize (2)—it’s also Leonardo da Vinci’s Mona Lisa—this time viewed from above. The frame is very ornate, but the picture tells us as much about the painting as our rejected linear and 90° angle

diagrams did about our fatty acid. They're both correct—in their way—but sadly useless. What we need when we draw molecules is the equivalent of (3). It gets across the idea of the original, and includes all the detail necessary for us to recognize what it's a picture of, and leaves out the rest. And it was quick to draw—this picture was drawn in less than 10 minutes: we haven't got time to produce great works of art!

Because functional groups are the key to the chemistry of molecules, clear diagrams must emphasize the functional groups and let the hydrocarbon framework fade into the background. Compare the diagrams below:

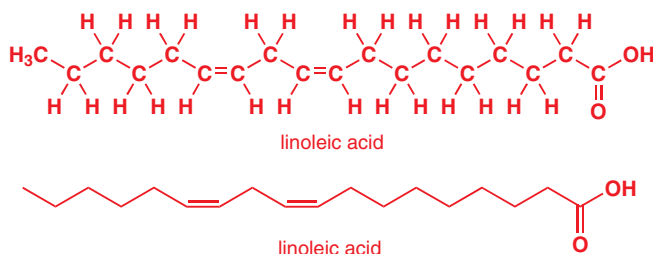

The second structure is the way that most organic chemists would draw linoleic acid. Notice how the important carboxylic acid functional group stands out clearly and is no longer cluttered by all those Cs and Hs. The zig-zag pattern of the chain is much clearer too. And this structure is much quicker to draw than any of the previous ones!

To get this diagram from the one above we've done two things. Firstly, we've got rid of all the hydrogen atoms attached to carbon atoms, along with the bonds joining them to the carbon atoms. Even without drawing the hydrogen atoms we know they're there—we assume that any carbon atom that doesn't appear to have its potential for four bonds satisfied is also attached to the appropriate number of hydrogen atoms. Secondly, we've rubbed out all the Cs representing carbon atoms. We're left with a zig-zag line, and we assume that every kink in the line represents a carbon atom, as does the end of the line.

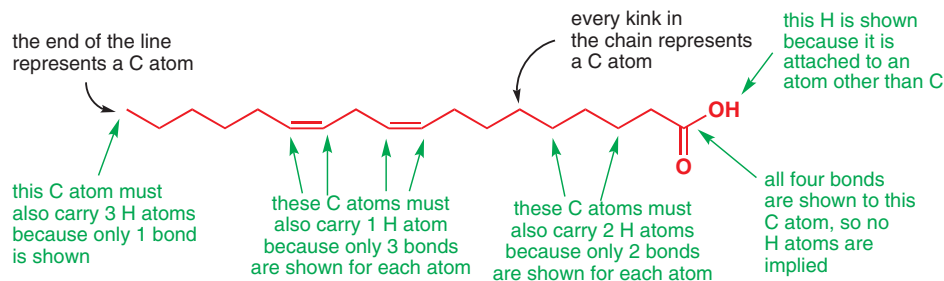

We can turn these two simplifications into two more guidelines for drawing organic structures.

● Guideline 2

Miss out the Hs attached to carbon atoms, along with the C–H bonds (unless there is a good reason not to).

● Guideline 3

Miss out the capital Cs representing carbon atoms (unless there is a good reason not to).

■ What is 'a good reason not to'? One is if the C or H is part of a functional group. Another is if the C or H needs to be highlighted in some way, for example because it's taking part in a reaction. Don't be too rigid about these guidelines: they're not rules. It is better just to learn by example (you'll find plenty in this book): if it helps to clarify, put it in; if it clutters and confuses, leave it out. One thing you must remember, though: if you write a carbon atom as a letter C then you must add all the H atoms too. If you don't want to draw all the Hs, don't write C for carbon.

Be clear

Try drawing some of the amino acids represented on p. 16 in a similar way, using the three guidelines. The bond angles at tetrahedral carbon atoms are about 109° . Make them look about 109° projected on to a plane! (120° is a good compromise, and it makes the drawings look neat.)

Start with leucine—earlier we drew it as the structure to the right. Get a piece of paper and do it now. Once you have done this, turn the page to see how your drawing compares with our suggestions.

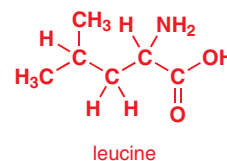

It doesn't matter which way up you've drawn it, but your diagram should look something like one of these structures below.

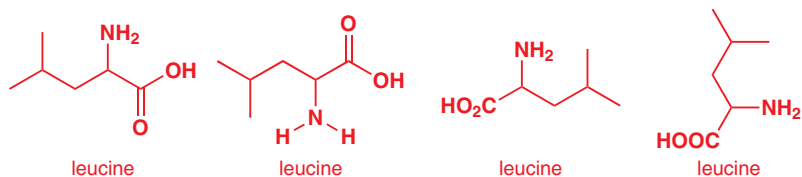

The guidelines we gave were only guidelines, not rules, and it certainly does not matter which way round you draw the molecule. The aim is to keep the functional groups clear and let the skeleton fade into the background. That's why the last two structures are all right—the carbon atom shown as 'C' is part of a functional group (the carboxyl group) so it can stand out.

Now turn back to p. 16 and try redrawing the some of the other eight structures there using the guidelines. Don't look at our suggestions below until you've done them! Then compare your drawings with our suggestions.

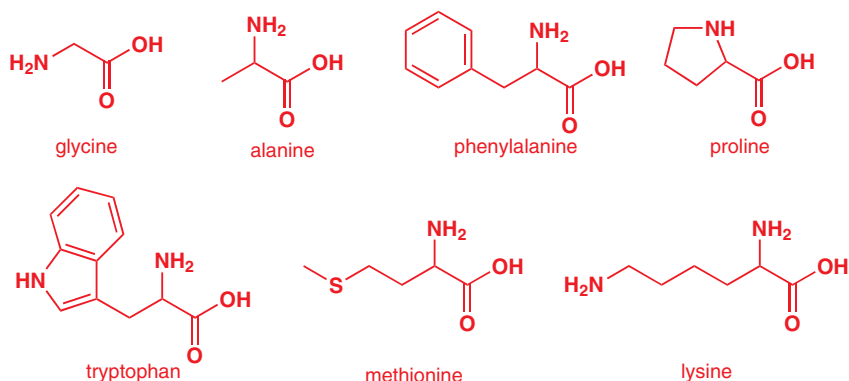

Remember that these are only suggestions, but we hope you'll agree that this style of diagram looks much less cluttered and makes the functional groups much clearer than the diagrams on p. 16. Moreover, they still bear significant resemblance to the 'real thing'—compare these crystal structures of lysine and tryptophan with the structures shown above, for example.

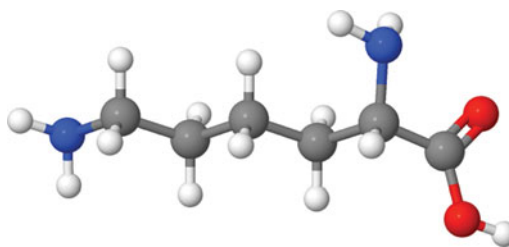

X-ray crystal structure of lysine

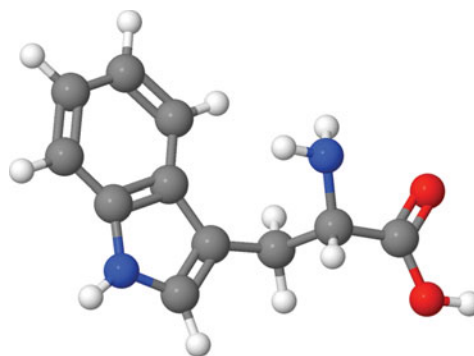

X-ray crystal structure of tryptophan

Structural diagrams can be modified to suit the occasion

You'll probably find that you want to draw the same molecule in different ways on different occasions to emphasize different points. Let's carry on using leucine as an example. We mentioned before that an amino acid can act as an acid or as a base. When it acts as an acid, a base (for example hydroxide, OH^-) removes H^+ from the carboxylic acid group in a reaction we can represent as:

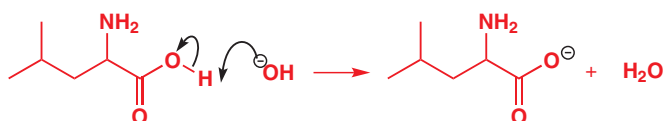

The product of this reaction has a negative charge on an oxygen atom. We have put it in a circle to make it clearer, and we suggest you do the same when you draw charges: + and - signs are easily mislaid. We shall discuss this type of reaction, the way in which reactions are drawn, and what the 'curly arrows' in the diagram mean in Chapter 5. But for now, notice that we drew out the CO_2H as the fragment on the left because we wanted to show how the O-H bond was broken when the base attacked. We modified our diagram to suit our own purposes.

When leucine acts as a base, the amino (NH_2) group is involved. The nitrogen atom attaches itself to a proton, forming a new bond using its *lone pair*.

We can represent this reaction as:



Notice how we drew in the lone pair this time because we wanted to show how it was involved in the reaction. The oxygen atoms of the carboxylic acid groups also have lone pairs but we didn't draw them in because they weren't relevant to what we were talking about. Neither did we feel it was necessary to draw CO_2H in full this time because none of the atoms or bonds in the carboxylic acid functional group was involved in the reaction.

Structural diagrams can show three-dimensional information on a two-dimensional page

Of course, all the structures we have been drawing give only an idea of the real structure of the molecules. For example, the carbon atom between the NH_2 group and the CO_2H group of leucine has a tetrahedral arrangement of atoms around it, a fact which we have so far completely ignored.

We might want to emphasize this fact by drawing in the hydrogen atom we missed out at this point, as in structure 1 (in the right-hand margin). We can then show that one of the groups attached to this carbon atom comes towards us, out of the plane of the paper, and the other one goes away from us, into the paper.

There are several ways of doing this. In structure 2, the bold, wedged bond suggests a perspective view of a bond coming towards you, while the hashed bond suggests a bond fading away from you. The other two 'normal' bonds are in the plane of the paper.

Alternatively we could miss out the hydrogen atom and draw something a bit neater, although slightly less realistic, as in structure 3. We can assume the missing hydrogen atom is behind the plane of the paper because that is where the 'missing' vertex of the tetrahedron of atoms attached to the carbon atom lies. When you draw diagrams like these to indicate the three dimensional shape of the molecule, try to keep the hydrocarbon framework in the

■ Not all chemists put circles round their plus and minus charges—it's a matter of personal choice.

■ A lone pair is a pair of electrons that is not involved in a chemical bond. We shall discuss lone pairs in detail in Chapter 4. Again, don't worry about what the curly arrows in this diagram mean—we will cover them in detail in Chapter 5.

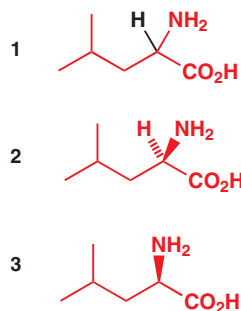

plane of the paper and allow functional groups and other branches to project forwards out of the paper or backwards into it.

These conventions allow us to give an idea of the three-dimensional shape (stereochemistry) of any organic molecule—you have already seen them in use in the diagram of the structure of palytoxin at the beginning of this chapter.

► We shall look in more detail at the shapes of molecules—their *stereochemistry*—in Chapter 14.

● Reminder

Organic structural drawings should be *realistic, economical, and clear*.

We gave you three guidelines to help you achieve this when you draw structures:

- **Guideline 1:** Draw chains of atoms as zig-zags.
- **Guideline 2:** Miss out the Hs attached to the carbon atoms along with the C–H bonds.
- **Guideline 3:** Miss out the capital Cs representing carbon atoms.

The guidelines we have given and the conventions we have illustrated in this section have grown up over decades. They are not arbitrary pronouncements by some official body but are used by organic chemists because they work! We guarantee to follow them for the rest of the book—try to follow them yourself whenever you draw an organic structure. Before you ever draw a capital C or a capital H again, ask yourself whether it's really necessary!

Now that we have considered how to draw structures, we can return to some of the structural types that we find in organic molecules. Firstly, we'll talk about hydrocarbon frameworks, then about functional groups.

Hydrocarbon frameworks

Carbon as an element is unique in the variety of structures it can form. It is unusual because it forms strong, stable bonds to the majority of elements in the periodic table, including itself. It is this ability to form bonds to itself that leads to the variety of organic structures that exist, and indeed to the possibility of life existing at all. Carbon may make up only 0.2% of the earth's crust, but it certainly deserves a whole branch of chemistry all to itself.

Chains

The simplest class of hydrocarbon frameworks contains just chains of atoms. The fatty acids we met earlier have hydrocarbon frameworks made of zig-zag chains of atoms, for example. Polythene is a polymer whose hydrocarbon framework consists entirely of chains of carbon atoms. The wiggly line at each end of this structure shows that we have drawn a piece in the middle of the polythene molecule. The structure continues indefinitely beyond the wiggly lines.



a section of the structure of polythene

Interactive structure of polythene

At the other end of the spectrum of complexity is this antibiotic, extracted from a fungus in 1995 and aptly named linearmycin as it has a long linear chain. The chain of this antibiotic is so long that we have to wrap it round two corners just to get it on the page. We haven't drawn whether the CH₃ and OH groups are in front of or behind the plane of the paper because, at the time of writing this book, the stereochemistry of linearmycin is unknown.

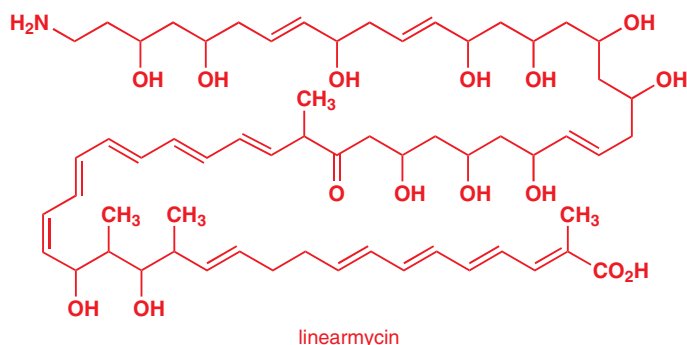

■ Notice we've drawn in four groups as CH₃—we did this because we didn't want them to get overlooked in such a large structure. They are the only tiny branches off this long winding trunk.

Names for carbon chains

It is often convenient to refer to a chain of carbon atoms by a name indicating its length. You have probably met some of these names before in the names of the simplest organic molecules, the alkanes. There are also commonly used abbreviations for these names: these can be very useful in both writing about chemistry and in drawing chemical structures, as we shall see shortly.

Names and abbreviations for carbon chains

Number of carbon atoms in chain	Name of group	Formula [†]	Abbreviation	Name of alkane (= chain + H)
1	methyl	–CH ₃	Me	methane
2	ethyl	–CH ₂ CH ₃	Et	ethane
3	propyl	–CH ₂ CH ₂ CH ₃	Pr	propane
4	butyl	–(CH ₂) ₃ CH ₃	Bu	butane
5	pentyl	–(CH ₂) ₄ CH ₃	— [‡]	pentane
6	hexyl	–(CH ₂) ₅ CH ₃	— [‡]	hexane
7	heptyl	–(CH ₂) ₆ CH ₃	— [‡]	heptane
8	octyl	–(CH ₂) ₇ CH ₃	— [‡]	octane
9	nonyl	–(CH ₂) ₈ CH ₃	— [‡]	nonane
10	decyl	–(CH ₂) ₉ CH ₃	— [‡]	decane

[†] This representation is not recommended, except for CH₃. [‡] Names for longer chains are not commonly abbreviated.

■ The names for shorter chains (which you must learn) exist for historical reasons; for chains of five or more carbon atoms, the systematic names are based on Greek number names.

Organic elements

You may notice that the abbreviations for the names of carbon chains look very much like the symbols for chemical elements: this is deliberate, and these symbols are sometimes called 'organic elements'. They can be used in chemical structures just like element symbols. It is often convenient to use the 'organic element' symbols for short carbon chains for tidiness. Here are some examples. Structure 1 to the right shows how we drew the structure of the amino acid methionine on p. 20. The stick representing the methyl group attached to the sulfur atom does, however, look a little odd. Most chemists would draw methionine as structure 2, with 'Me' representing the CH₃ (methyl) group. Tetraethyllead used to be added to petrol to prevent engines 'knocking', until it was shown to be a health hazard. Its structure (as you might easily guess from the name) is easy to write as PbEt₄ or Et₄Pb.

Remember that these symbols (and names) can be used only for terminal chains of atoms. We couldn't abbreviate the structure of lysine to 3, for example, because Bu represents 4 and not 5.

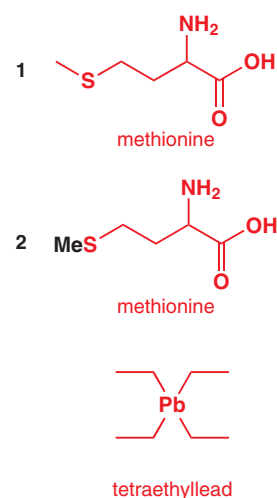

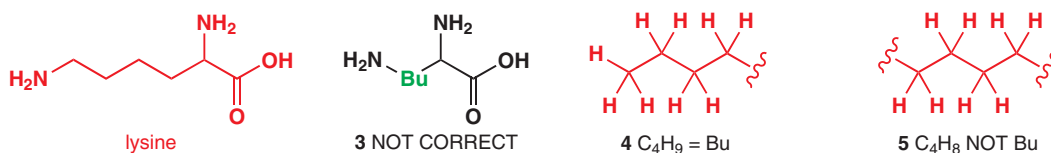

Before leaving carbon chains, we must mention one other very useful organic element symbol, R. R in a structure can mean *anything*—it's a sort of wild card. For example, structure 6 would indicate any amino acid, if R = H it is glycine, if R = Me it is alanine... As we've mentioned before, and you will see later, the reactivity of organic molecules is so dependent on their functional groups that the rest of the molecule can be irrelevant. In these cases, we can choose just to call it R.

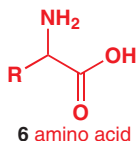

Carbon rings



benzene

Rings of atoms are also common in organic structures. You may have heard the famous story of Auguste Kekulé first realizing that benzene has a ring structure when he dreamed of snakes biting their own tails. You have met benzene rings in phenylalanine and aspirin. Paracetamol also has a structure based on a benzene ring.

Benzene's ring structure

In 1865, August Kekulé presented a paper at the Academie des Sciences in Paris suggesting a cyclic structure for benzene, the inspiration for which he ascribed to a dream. However, was Kekulé the first to suggest that benzene was cyclic? Some believe not and credit an Austrian school-teacher, Josef Loschmidt, with the first depiction of cyclic benzene structures. In 1861, 4 years before Kekulé's 'dream', Loschmidt published a book in which he represented benzene as a set of rings. It is not certain whether Loschmidt or Kekulé—or even a Scot named Archibald Couper—got it right first.

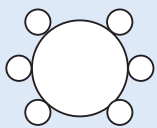

Loschmidt's structure for benzene

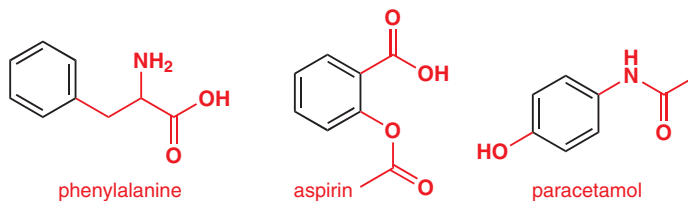

When a benzene ring is attached to a molecule by only *one* of its carbon atoms (as in phenylalanine, but not paracetamol or aspirin), we can call it a 'phenyl' group and give it the organic element symbol Ph.

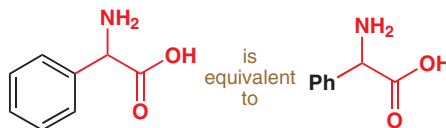

Any compound containing a benzene ring or a related (Chapter 7) ring system is known as 'aromatic', and another useful organic element symbol related to Ph is Ar (for 'aryl'). While Ph always means C₆H₅, Ar can mean any *substituted* phenyl ring, in other words phenyl with any number of the hydrogen atoms replaced by other groups. Of course Ar = argon too but there is no confusion as there are no organic compounds of argon.

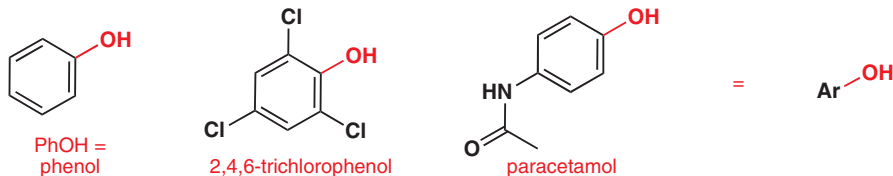
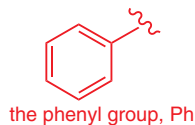

For example, while PhOH always means phenol, ArOH could mean phenol, 2,4,6-trichlorophenol (the antiseptic TCP), paracetamol, or aspirin (among many other substituted phenols). Like R, the 'wild card' alkyl group, Ar is a 'wild card' *aryl* group.

The compound known as muscone has only relatively recently been made in the laboratory. It is the pungent aroma that makes up the base-note of musk fragrances. Before chemists had determined its structure and devised a laboratory synthesis the only source of musk was the musk deer, now rare for this very reason. Muscone's skeleton is a 13-membered ring of carbon atoms.

The steroid hormones have several (usually four) rings fused together. These hormones are testosterone and oestradiol, the important human male and female sex hormones.

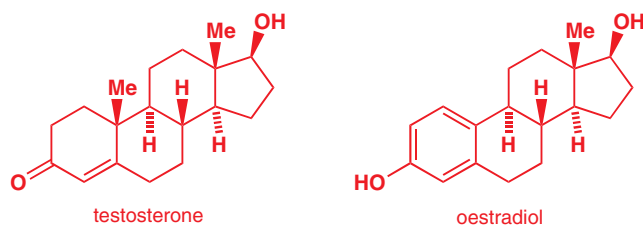

Some ring structures are much more complicated. The potent poison strychnine is a tangle of interconnecting rings.

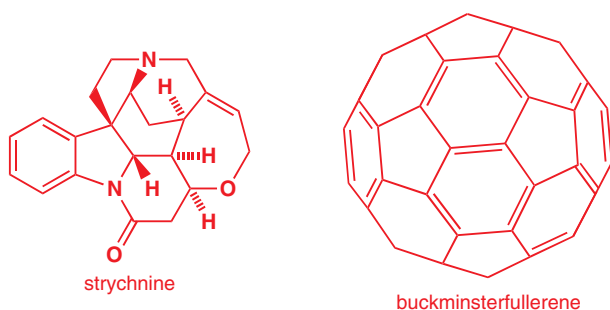

One of the most elegant ring structures is shown above and is known as buckminsterfullerene. It consists solely of 60 carbon atoms in rings that curve back on themselves to form a football-shaped cage. Count the number of bonds at any junction and you will see they add up to four so no hydrogens need be added. This compound is C_{60} . Note that you can't see all the atoms as some are behind the sphere.

Rings of carbon atoms are given names starting with 'cyclo', followed by the name for the carbon chain with the same number of carbon atoms. Structure 1 shows chrysanthemic acid, part of the naturally occurring pesticides called pyrethrins (an example appears in Chapter 1), which contains a cyclopropane ring. Propane has three carbon atoms. Cyclopropane is a three-membered ring. Grandisol (structure 2), an insect pheromone used by male boll weevils to attract females, has a structure based on a cyclobutane ring. Butane has four carbon atoms. Cyclobutane is a four-membered ring. Cyclamate (structure 3), formerly used as an artificial sweetener, contains a cyclohexane ring. Hexane has six carbon atoms. Cyclohexane is a six-membered ring.

Branches

Hydrocarbon frameworks rarely consist of single rings or chains, but are often branched. Rings, chains, and branches are all combined in structures like that of the marine toxin palytoxin that we met at the beginning of the chapter, polystyrene, a polymer made of six-membered rings dangling from linear carbon chains, or of β -carotene, the compound that makes carrots orange.

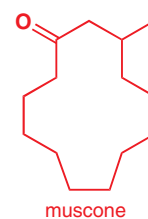

■ A reminder: solid wedge-shaped bonds are coming towards us out of the paper while cross-hatched bonds are going back into the page away from us.

 Interactive structures of testosterone, oestradiol, strychnine, and buckminsterfullerene

Buckminsterfullerene

Buckminsterfullerene is named after the American inventor and architect Richard Buckminster Fuller, who designed the structures known as 'geodesic domes'.

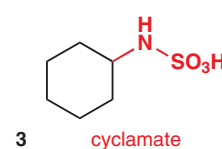
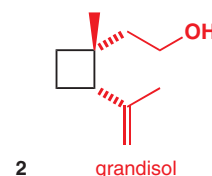
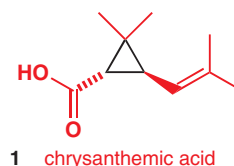

Interactive structure of polystyrene

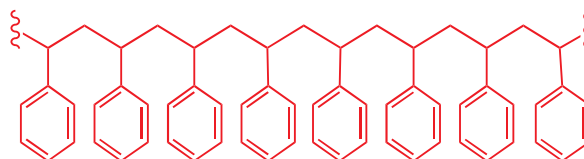

part of the structure of polystyrene

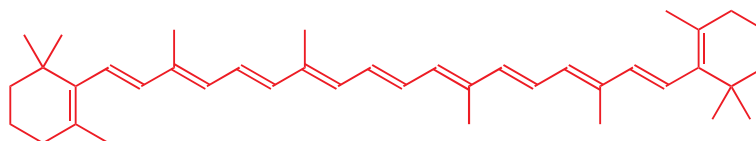

β -carotene

the isopropyl group
i-Pr

Just like some short straight carbon chains, some short branched carbon chains are given names and organic element symbols. The most common is the isopropyl group. Lithium diisopropylamide (also called LDA) is a strong base commonly used in organic synthesis.

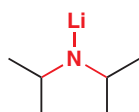

lithium diisopropylamide (LDA)
is equivalent to LiNi-Pr_2

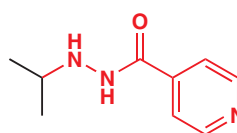

is equivalent to

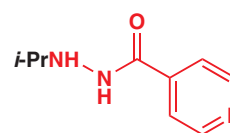

iproniazid

Notice how the 'propyl' part of 'isopropyl' still indicates three carbon atoms; they are just joined together in a different way—in other words, as an *isomer* of the straight chain propyl group. Sometimes, to avoid confusion, the straight chain alkyl groups are called '*n*-alkyl' (for example, *n*-Pr, *n*-Bu)—*n* for 'normal'—to distinguish them from their branched counterparts. Iproniazid is an antidepressant drug with *i*-Pr in both structure and name. 'Isopropyl' may be abbreviated to *i*-Pr, 'Pr, or Pr'. We shall use the first in this book, but you may see the others used elsewhere.

● **Isomers** are molecules with the same kinds and numbers of atoms joined up in different ways. *n*-propanol, *n*-PrOH, and isopropanol, *i*-PrOH, are isomeric alcohols. Isomers need not have the same functional groups—these compounds are all isomers of $\text{C}_4\text{H}_8\text{O}$:

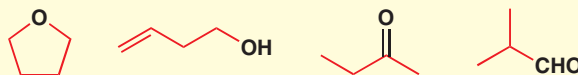

the isobutyl group
i-Bu

The isobutyl (*i*-Bu) group is a CH_2 group joined to an *i*-Pr group. It is i-PrCH_2- . Two isobutyl groups are present in the reducing agent diisobutyl aluminium hydride (DIBAL). The painkiller ibuprofen (marketed as Nurofen®) contains an isobutyl group. Notice how the invented name ibuprofen is a medley of 'ibu' (from *i*-Bu for isobutyl) + 'pro' (for propyl, the three-carbon unit shown in brown) + 'fen' (for the phenyl ring). We will talk about the way in which compounds are named later in this chapter.

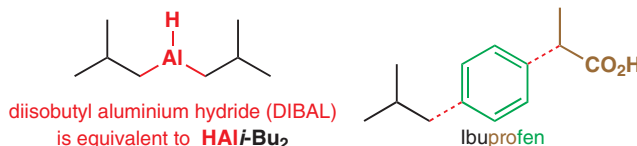

diisobutyl aluminium hydride (DIBAL)
is equivalent to HAl-i-Bu_2

ibuprofen

the *sec*-butyl group, *s*-Bu

There are two more isomers of the butyl group, both of which have common names and abbreviations. The *sec*-butyl group (*s*-butyl or *s*-Bu) has a methyl and an ethyl group joined to the same carbon atom. It appears in an organolithium compound, *sec*-butyl lithium, used to introduce lithium atoms into organic molecules.

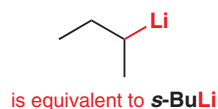

The *tert*-butyl group (*t*-butyl or *t*-Bu) group has three methyl groups joined to the same carbon atom. Two *t*-Bu groups are found in butylated hydroxy toluene (BHT E321), an anti-oxidant added to some processed foods.

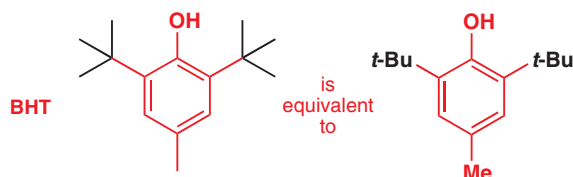

the *tert*-butyl group *t*-Bu

● Primary, secondary, and tertiary

The prefixes *sec* and *tert* are really short for secondary and tertiary, terms that refer to the carbon atom that attaches these groups to the rest of the molecular structure.

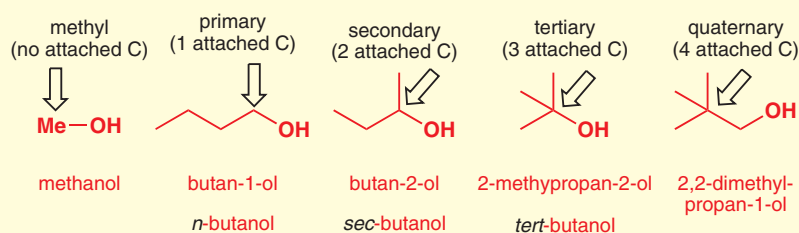

A primary carbon atom is attached to only one other C atom, a secondary to two other C atoms, and so on. This means there are five types of carbon atom. These names for bits of hydrocarbon framework are more than just useful ways of writing or talking about chemistry. They tell us something fundamental about the molecule and we shall use them when we describe reactions.

This quick architectural tour of some of the molecular edifices built by nature and by humans serves just as an introduction to some of the hydrocarbon frameworks you will meet in the rest of this chapter and this book. Yet, fortunately for us, however complicated the hydrocarbon framework might be, it serves only as a support for the functional groups. And, by and large, a functional group in one molecule behaves in much the same way as it does in another molecule. What we now need to do, and we start in the next section, is to introduce you to some functional groups and explain why it is that their attributes are the key to understanding organic chemistry.

Functional groups

If you bubble ethane gas (CH_3CH_3 , or EtH) through acids, bases, oxidizing agents, reducing agents—in fact almost any chemical you can think of—it will remain unchanged. Just about the only thing you can do with it is burn it. Yet ethanol ($\text{CH}_3\text{CH}_2\text{OH}$, or preferably EtOH—structure in the margin) not only burns, it reacts with acids, bases, and oxidizing agents.

The difference between ethanol and ethane is the functional group—the OH, or hydroxyl group. We know that these chemical properties (being able to react with acids, bases, and oxidizing agents) are properties of the hydroxyl group and not just of ethanol because other compounds containing OH groups (in other words, other alcohols) have similar properties, whatever their hydrocarbon frameworks.

Your understanding of functional groups will be the key to your understanding of organic chemistry. We shall therefore now go on to meet some of the most important functional groups. We won't say much about the properties of each group; that will come in Chapter 5

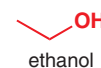

Ethanol

The reaction of ethanol with oxidizing agents makes vinegar from wine and sober people from drunk ones. In both cases, the oxidizing agent is oxygen from the air, catalysed by an enzyme in a living system. The oxidation of ethanol by micro-organisms that grow in wine left open to the air leads to acetic acid (ethanoic acid) while the oxidation of ethanol by the liver gives acetaldehyde (ethanal).

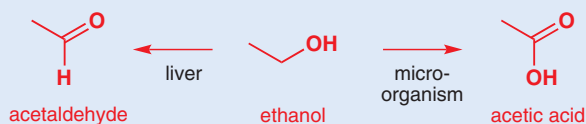

Human metabolism and oxidation

The human metabolism makes use of the oxidation of alcohols to render harmless other toxic compounds containing the OH group. For example, lactic acid, produced in muscles during intense activity, is oxidized by an enzyme called lactate dehydrogenase to the metabolically useful compound pyruvic acid.

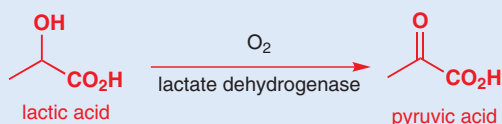

and later. Your task at this stage is to learn to recognize them when they appear in structures, so make sure you learn their names. The classes of compound associated with some functional groups also have names, for example compounds containing the hydroxyl group are known as alcohols. Learn these names too as they are more important than the systematic names of individual compounds. We've told you a few snippets of information about each group to help you to get to know something of the group's character.

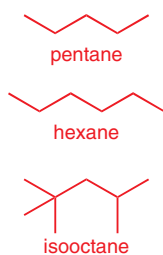

Alkanes contain no functional groups

The alkanes are the simplest class of organic molecules because they contain no functional groups. They are extremely unreactive and therefore rather boring as far as the organic chemist is concerned. However, their unreactivity can be a bonus, and alkanes such as pentane and hexane are often used as solvents, especially for the purification of organic compounds. Just about the only thing alkanes will do is burn—methane, propane, and butane are all used as domestic fuels, and petrol is a mixture of alkanes containing largely isooctane.

Alkenes (sometimes called olefins) contain C=C double bonds

It may seem strange to classify a type of bond as a functional group, but you will see later that C=C double bonds impart reactivity to an organic molecule just as functional groups consisting of, say, oxygen or nitrogen atoms do. Some of the compounds produced by plants and used by perfumers are alkenes (see Chapter 1). For example, pinene has a smell evocative of pine forests, while limonene smells of citrus fruits.

You've already met the orange pigment β -carotene. Eleven C=C double bonds make up most of its structure. Coloured organic compounds often contain chains or rings of C=C double bonds like this. In Chapter 7 you will find out why this is so.

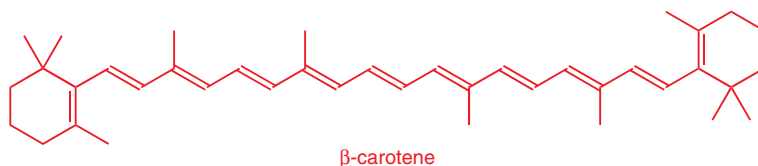
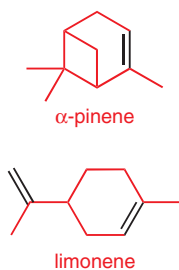

Alkynes contain C \equiv C triple bonds

Just like C=C double bonds, C \equiv C triple bonds have a special type of reactivity associated with them, so it's useful to call a C \equiv C triple bond a functional group. Alkynes are linear so we

draw them with four carbon atoms in a straight line. Alkynes are not as widespread in nature as alkenes, but one fascinating class of compounds containing $C\equiv C$ triple bonds is a group of antitumour agents discovered during the 1980s. Calicheamicin is a member of this group. The high reactivity of this combination of functional groups enables calicheamicin to attack DNA and prevent cancer cells from proliferating. For the first time we have drawn a molecule in three dimensions, with two bonds crossing one another—can you see the shape?

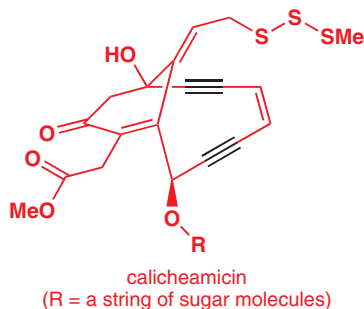

Alcohols (R–OH) contain a hydroxyl (OH) group

We've already talked about the hydroxyl group in ethanol and other alcohols. Carbohydrates are peppered with hydroxyl groups; sucrose has eight of them, for example (a more three-dimensional picture of the sucrose molecule appears in Chapter 1, p.3).

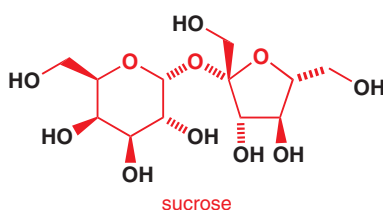

Molecules containing hydroxyl groups are often soluble in water, and living things often attach sugar groups, containing hydroxyl groups, to otherwise insoluble organic compounds to keep them in solution in the cell. Calicheamicin, a molecule we have just mentioned, contains a string of sugars for just this reason. The liver carries out its task of detoxifying unwanted organic compounds by repeatedly hydroxylating them until they are water soluble, and they are then excreted in the bile or urine.

Ethers (R¹–O–R²) contain an alkoxy group (–OR)

The name ether refers to any compound that has two alkyl groups linked through an oxygen atom. 'Ether' is also used as an everyday name for diethyl ether, Et_2O . You might compare this use of the word 'ether' with the common use of the word 'alcohol' to mean ethanol. Diethyl ether is a highly flammable solvent that boils at only $35^\circ C$. It used to be used as an anaesthetic. Tetrahydrofuran (THF) is another commonly used solvent and is a cyclic ether.

Brevetoxin B (overleaf) is a fascinating naturally occurring compound that was synthesized in the laboratory in 1995. It is packed with ether functional groups in ring sizes from 6 to 8.

Amines (R–NH₂) contain the amino (NH₂) group

We met the amino group when we were discussing the amino acids: we mentioned that it was this group that gave these compounds their basic properties. Amines often have powerful fishy smells: the smell of putrescine is particularly foul. It is formed as meat decays. Many neurologically active compounds are also amines: amphetamine is a notorious stimulant.

Saturated and unsaturated

In an alkane, each carbon atom is joined to four other atoms (C or H). It has no potential for forming more bonds and is therefore **saturated**. In alkenes, the carbon atoms making up the $C=C$ double bond are attached to only three atoms each. They still have the potential to bond with one more atom, and are therefore **unsaturated**. In general, carbon atoms attached to four other atoms are saturated; those attached to three, two, or one are **unsaturated**. Remember that R may mean any alkyl group.

 Interactive structure of sucrose

■ If we want a structure to contain more than one 'R', we give the Rs numbers and call them R¹, R²... Thus R¹–O–R² means an ether with two different unspecified alkyl groups. (Not R₁, R₂..., which would mean 1 × R, 2 × R...)

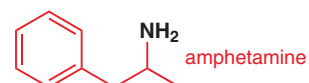
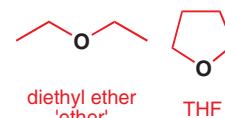

Brevetoxin B

Brevetoxin B is one of a family of polyethers found in a sea creature (a dinoflagellate *Gymnodinium breve*, hence the name) which sometimes multiplies at an amazing rate and creates 'red tides' around the coasts of the Gulf of Mexico. Fish die in shoals and so do people if they eat the shellfish that have eaten the red tide. The brevetoxins are the killers. The many ether oxygen atoms interfere with sodium ion (Na^+) metabolism.

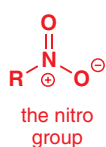
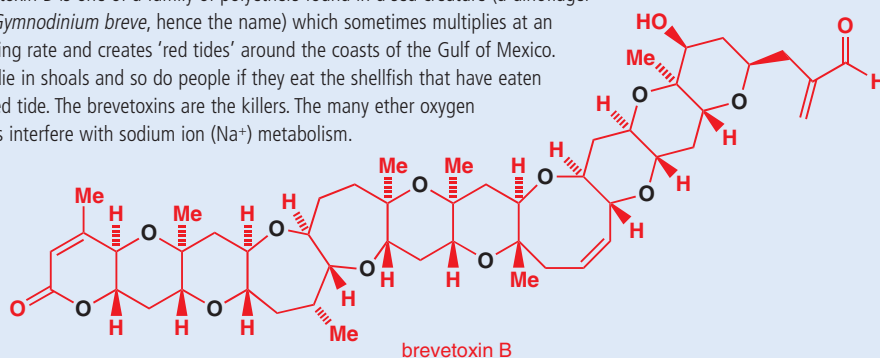

nitrogen cannot have five bonds!



incorrect structure for the nitro group

Nitro compounds (R-NO_2) contain the nitro group (NO_2)

The nitro group (NO_2) is sometimes incorrectly drawn with five bonds to nitrogen which as you will see in Chapter 4 is impossible. Make sure you draw it correctly when you need to draw it out in detail. If you write just NO_2 you are all right!

Several nitro groups in one molecule can make it quite unstable and even explosive. Three nitro groups give the most famous explosive of all, trinitrotoluene (TNT), its kick. However, functional groups refuse to be stereotyped. Nitrazepam also contains a nitro group, but this compound is marketed as Mogadon[®], the sleeping pill.

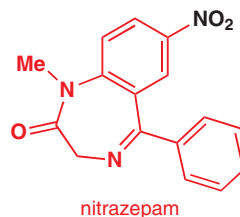

Alkyl halides (fluorides R-F , chlorides R-Cl , bromides R-Br , or iodides R-I) contain the fluoro, chloro, bromo, or iodo groups

These four functional groups have similar properties, although alkyl iodides are the most reactive and alkyl fluorides the least. Polyvinyl chloride (PVC) is one of the most widely used polymers—it has a chloro group on every other carbon atom along a linear hydrocarbon framework. Methyl iodide (MeI), on the other hand, is a dangerous carcinogen since it reacts with DNA and can cause mutations in the genetic code. These compounds are also known as haloalkanes (fluoroalkanes, chloroalkanes, bromoalkanes, or iodoalkanes).

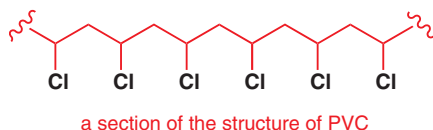

Aldehydes (R-CHO) and ketones ($\text{R}^1\text{-CO-R}^2$) contain the carbonyl group C=O

Aldehydes can be formed by oxidizing alcohols—in fact the liver detoxifies ethanol in the bloodstream by oxidizing it first to acetaldehyde (ethanal, CH_3CHO) (see p. 28). Acetaldehyde in the blood is the cause of hangovers. Aldehydes often have pleasant smells—2-methylundecanal is a key component of the fragrance of Chanel No. 5, and 'raspberry ketone' is the major component of the flavour and smell of raspberries.

Interactive structure of PVC

Because alkyl halides have similar properties, chemists use yet another wild card organic element symbol, X, as a convenient substitute for Cl, Br, or I and sometimes F: R-X is any alkyl halide.

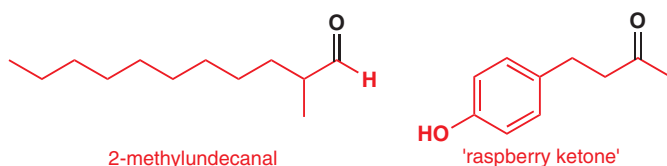

Carboxylic acids ($R-CO_2H$) contain the carboxyl group CO_2H

As their name implies, compounds containing the carboxylic acid (CO_2H) group can react with bases, losing a proton to form carboxylate salts. Edible carboxylic acids have sharp flavours and several are found in fruits—citric, malic, and tartaric acids are found in lemons, apples, and grapes, respectively.

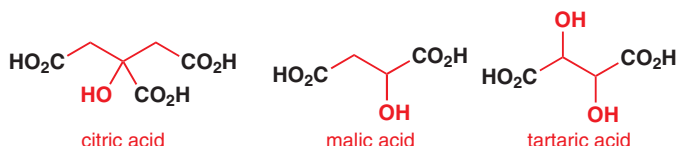

Esters ($R^1-CO_2R^2$) contain a carboxyl group with an extra alkyl group (CO_2R)

Fats are esters; in fact they contain three ester groups. They are formed in the body by condensing glycerol, a compound with three hydroxyl groups, with three fatty acid molecules. Other, more volatile, esters have pleasant, fruity smells and flavours. These three are components of the flavours of bananas, rum, and apples:

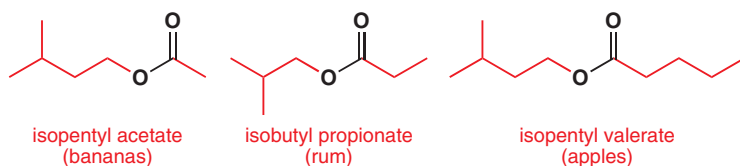

Amides ($R-CONH_2$, $R^1-CONHR^2$, or $R^1-CONR^2R^3$)

Proteins are amides: they are formed when the carboxylic acid group of one amino acid condenses with the amino group of another to form an amide linkage (also known as a peptide bond). One protein molecule can contain hundreds of amide bonds. Aspartame, the artificial sweetener marketed as NutraSweet®, on the other hand, contains just two amino acids, aspartic acid and phenylalanine, joined through one amide bond. Paracetamol is also an amide.

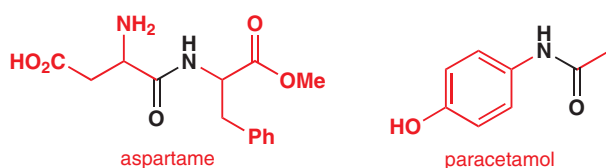

Nitriles or cyanides ($R-CN$) contain the cyano group $-C\equiv N$

Nitrile groups can be introduced into molecules by reacting potassium cyanide with alkyl halides. The organic nitrile group has quite different properties from those associated with lethal inorganic cyanide: laetrile, for example, is extracted from apricot kernels, and was once developed as an anticancer drug.

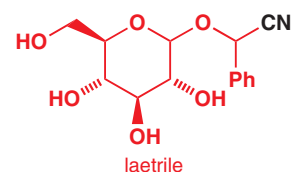

Acyl chlorides (acid chlorides, $R-COCl$)

Acyl chlorides are reactive compounds used to make esters and amides. They are derivatives of carboxylic acids with the $-OH$ replaced by $-Cl$, and are too reactive to be found in nature.

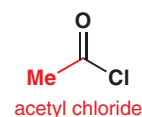

■ $-CHO$ represents



When we write aldehydes as $R-CHO$, we have no choice but to write in the C and H (because they're part of the functional group)—one important instance where you should ignore Guideline 3 for drawing structures. Another point: always write $R-CHO$ and never $R-COH$, which looks too much like an alcohol.

■ The terms 'saturated fats' and 'unsaturated fats' are familiar—they refer to whether the R groups are saturated (no $C=C$ double bonds) or unsaturated (contain $C=C$ double bonds)—see the box on p. 29. Fats containing R groups with several double bonds (for example those that are esters formed from linoleic acid, which we met at the beginning of this chapter) are known as 'polyunsaturated'.

Acetals

Acetals are compounds with two single-bonded oxygen atoms attached to the same carbon atom. Many sugars are acetals, as is laetrile, which you have just met.

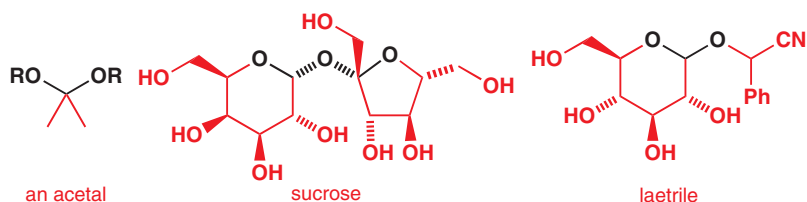

Carbon atoms carrying functional groups can be classified by oxidation level

A heteroatom is an atom that is not C or H

You've seen that a functional group is essentially any deviation from an alkane structure, either because the molecule has fewer hydrogen atoms than an alkane (alkenes, alkynes) or because it contains a collection of atoms that are not C and not H. There is a useful term for these 'different' atoms: heteroatoms. A heteroatom is any atom in an organic molecule other than C or H.

All functional groups are different, but some are more different than others. For example, the structures of a carboxylic acid, an ester, and an amide are all very similar: in each case the carbon atom carrying the functional group is bonded to two **heteroatoms**, one of the bonds being a double bond. You will see in Chapter 10 that this similarity in structure is mirrored in the reactions of these three types of compounds and in the ways in which they can be interconverted. Carboxylic acids, esters, and amides can be changed one into another by reaction with simple reagents such as water, alcohols, or amines plus appropriate catalysts. To change them into aldehydes or alcohols requires a different type or reagent, a reducing agent (a reagent which adds hydrogen atoms). We say that the carbon atoms carrying functional groups that can be interconverted without the need for reducing agents (or oxidizing agents) have the same oxidation level—in this case, we call it the 'carboxylic acid oxidation level'.

● The carboxylic acid oxidation level

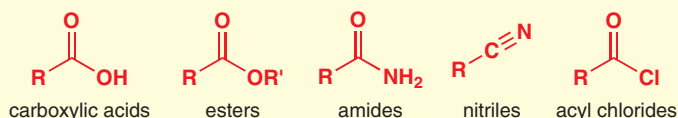

In fact, amides can quite easily be converted into nitriles just by dehydration (removal of water), so we must give nitrile carbon atoms the same oxidation level as carboxylic acids, esters, and amides. Maybe you're beginning to see the structural similarity between these four functional groups that you could have used to assign their oxidation level? In all four cases, the carbon atom has *three* bonds to heteroatoms, and only one to C or H. It doesn't matter how many heteroatoms there are, just how many bonds to them. Having noticed this, we can also assign both carbon atoms in 'CFC-113', one of the environmentally unfriendly aerosol propellants/refrigerants that have caused damage to the earth's ozone layer, to the carboxylic acid oxidation level.

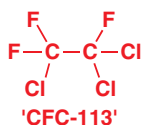

■ Don't confuse oxidation level with oxidation state. Oxidation level is determined by the number of heteroatoms bonded to carbon while oxidation state is determined by the number of bonds to carbon, including those to C and H. In all of these compounds, carbon has four bonds and is in oxidation state +4.

● The aldehyde oxidation level

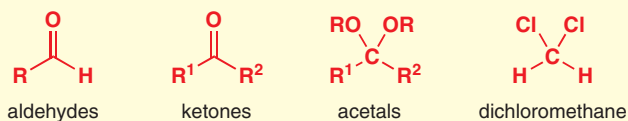

Aldehydes and ketones contain a carbon atom with *two* bonds to heteroatoms; they are at the 'aldehyde oxidation level'. The common laboratory solvent dichloromethane CH_2Cl_2 also has two bonds to heteroatoms, so it too contains a carbon atom at the aldehyde oxidation level, as do acetals.

● The alcohol oxidation level

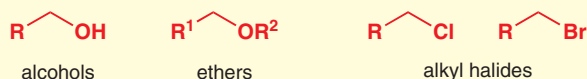

Alcohols, ethers, and alkyl halides have a carbon atom with only *one* single bond to a heteroatom. We assign these the 'alcohol oxidation level', and they are all easily made from alcohols without oxidation or reduction.

● **The alkane oxidation level**

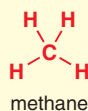

We must include simple alkanes, which have no bonds to heteroatoms, as an 'alkane oxidation level'.

● **The carbon dioxide oxidation level**

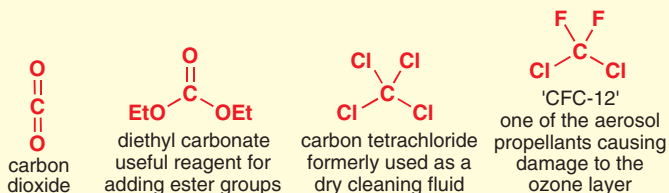

The small class of compounds that have a carbon atom with four bonds to heteroatoms is related to CO₂ and best described as at the carbon dioxide oxidation level.

Alkenes and alkynes obviously don't fit easily into these categories as they have no bonds to heteroatoms. Alkenes can be made from alcohols by dehydration without any oxidation or reduction so it seems sensible to put them in the alcohol column. Similarly, alkynes and aldehydes are related by hydration/dehydration without oxidation or reduction.

● **Summary: Important functional groups and oxidation level**

Zero bonds to heteroatoms: alkane oxidation level	One bond to heteroatoms: alcohol oxidation level	Two bonds to heteroatoms: aldehyde oxidation level	Three bonds to heteroatoms: carboxylic acid oxidation level	Four bonds to heteroatoms: carbon dioxide oxidation level
 alkanes	 alcohols ethers amines	 aldehydes ketones acetals	 carboxylic acids esters amides nitriles acyl chlorides	 carbon dioxide carbonates tetrahalo compounds ureas
	 alkyl halides alkenes	 alkynes		

Naming compounds

So far, we have talked a lot about compounds by name. Many of the names we've used (palytoxin, muscone, brevetoxin) are simple names given to complicated molecules without regard for the actual structure or function of the molecule—these three names, for example, are all derived from the name of the organism from which the compound was first extracted.

They are known as **trivial names**, not because they are unimportant, but because they are used in everyday scientific conversation.

Names like this are fine for familiar compounds that are widely used and referred to by chemists, biologists, doctors, nurses, and perfumers alike. But there are over 16 million known organic compounds. They can't all have simple names, and no-one would remember them if they did. For this reason, the International Union of Pure and Applied Chemistry (IUPAC) have developed **systematic nomenclature**, a set of rules that allows any compound to be given a unique name that can be deduced directly from its chemical structure. Conversely, a chemical structure can be deduced from its systematic name.

The problem with systematic names is that they tend to be grotesquely unpronounceable for anything but the most simple molecules. In everyday speech and writing, chemists therefore do tend to disregard them, and use a mixture of systematic and trivial names. Nonetheless, it's important to know how the rules work. We shall look next at systematic nomenclature, before going on to look at the real language of chemistry.









Systematic nomenclature

There isn't space here to explain all the rules for giving systematic names for compounds—they fill several desperately dull volumes, and there's no point knowing them anyway since computers will do the naming for you. What we will do is to explain the principles underlying systematic nomenclature. You should understand these principles because they provide the basis for the names used by chemists for the vast majority of compounds that do not have their own trivial names.

Systematic names can be divided into three parts: one describes the hydrocarbon framework, one describes the functional groups, and one indicates where the functional groups are attached to the skeleton.

You have already met the names for some simple fragments of hydrocarbon framework (methyl, ethyl, propyl). Adding a hydrogen atom to these alkyl fragments and changing -yl to -ane makes the alkanes and their names. You should hardly need reminding of their structures:

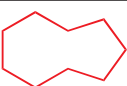
Names for the hydrocarbon framework

one carbon	methane	CH_4	
two carbons	ethane	$\text{H}_3\text{C}-\text{CH}_3$	
three carbons	propane	$\text{H}_3\text{C}-\text{CH}_2-\text{CH}_3$	cyclopropane 
four carbons	butane	$\text{H}_3\text{C}-\text{CH}_2-\text{CH}_2-\text{CH}_3$	cyclobutane 
five carbons	pentane	$\text{H}_3\text{C}-\text{CH}_2-\text{CH}_2-\text{CH}_2-\text{CH}_3$	cyclopentane 
six carbons	hexane	$\text{H}_3\text{C}-\text{CH}_2-\text{CH}_2-\text{CH}_2-\text{CH}_2-\text{CH}_3$	cyclohexane 
seven carbons	heptane	$\text{H}_3\text{C}-\text{CH}_2-\text{CH}_2-\text{CH}_2-\text{CH}_2-\text{CH}_2-\text{CH}_3$	cycloheptane 
eight carbons	octane	$\text{H}_3\text{C}-\text{CH}_2-\text{CH}_2-\text{CH}_2-\text{CH}_2-\text{CH}_2-\text{CH}_2-\text{CH}_3$	cyclooctane 
nine carbons	nonane	$\text{H}_3\text{C}-\text{CH}_2-\text{CH}_2-\text{CH}_2-\text{CH}_2-\text{CH}_2-\text{CH}_2-\text{CH}_2-\text{CH}_3$	cyclononane 
ten carbons	decane	$\text{H}_3\text{C}-\text{CH}_2-\text{CH}_2-\text{CH}_2-\text{CH}_2-\text{CH}_2-\text{CH}_2-\text{CH}_2-\text{CH}_2-\text{CH}_3$	cyclodecane 

The name of a functional group can be added to the name of a hydrocarbon framework either as a suffix or as a prefix. Some examples follow. It is important to count all of the carbon atoms in the chain, even if one of them is part of a functional group: pentanenitrile is actually BuCN.

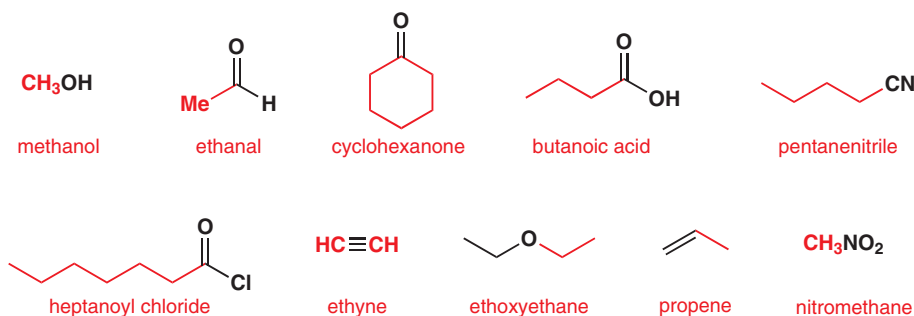

Compounds with functional groups attached to a benzene ring are named in a similar way.

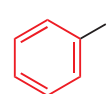

iodobenzene

Numbers are used to locate functional groups

Sometimes a number can be included in the name to indicate which carbon atom the functional group is attached to. None of the above list needed a number—check that you can see why not for each one. When numbers are used, the carbon atoms are counted from one end. In most cases, either of two numbers could be used (depending on which end you count from); the one chosen is always the lower of the two. Again, some examples will illustrate this point. Notice again that some functional groups are named by prefixes, some by suffixes, and that the number always goes directly before the functional group name.

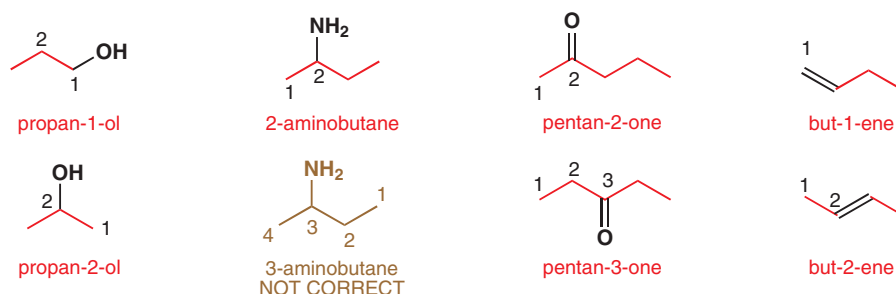

One carbon atom can have as many as four functional groups: this limit is reached with tetrabromomethane, CBr₄. Here are some other examples of compounds with more than one functional group.

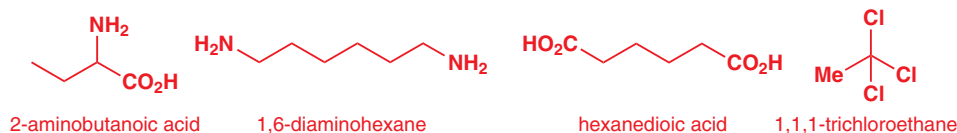

Again, the numbers indicate how far the functional groups are from the end of the carbon chain. Counting must always be from the same end for each functional group. Notice how we use di-, tri-, and tetra- if there is more than one of the same functional group.

With cyclic compounds, there isn't an end to the chain, but we can use numbers to show the distance between the two groups—start from the carbon atom carrying one of the functional groups, then count round. These rules work for hydrocarbon frameworks that are

chains or rings, but many skeletons are branched. We can name these by treating the branch as though it were a functional group.

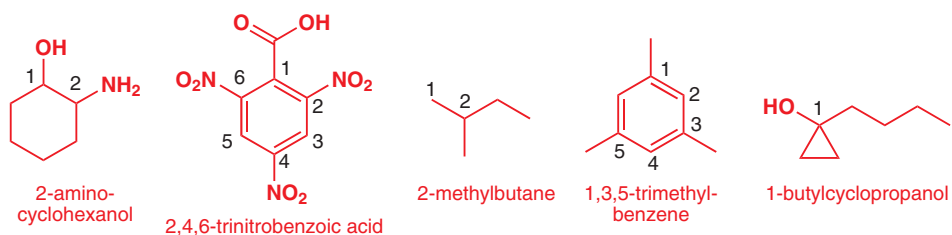

Ortho, meta, and para

■ *ortho, meta, and para* are often abbreviated to *o, m, and p*.

With substituted benzene rings, an alternative way of identifying the positions of the substituents is to use the terms *ortho, meta, and para*. *Ortho* compounds are 1,2-disubstituted, *meta* compounds are 1,3-disubstituted, and *para* compounds are 1,4-disubstituted. Some examples should make this clear.

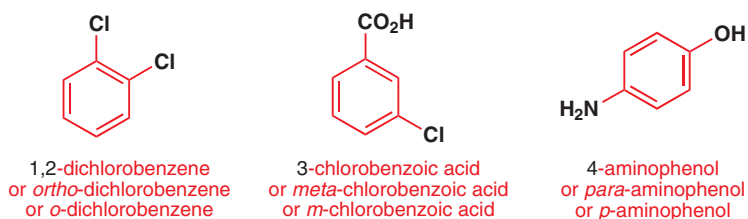

Beware! *Ortho, meta, and para* are used in chemistry to mean other things too: you may come across orthophosphoric acid, metastable states, and paraformaldehyde—these have nothing to do with the substitution patterns of benzene rings.

The terms *ortho, meta, and para* are used by chemists because they're easier to remember than numbers, and the words carry with them chemical meaning. *Ortho* shows that two groups are next to each other on the ring even though the atoms may not happen to be numbered 1 and 2. They are one example of the way in which chemists don't always use systematic nomenclature but revert to more convenient 'trivial' terms. We consider trivial names in the next section.

What do chemists really call compounds?

The point of naming a compound is to be able to communicate with other chemists. Most chemists are happiest communicating chemistry by means of structural diagrams, and structural drawings are far more important than any sort of chemical nomenclature. That's why we explained in detail how to draw structures, but only gave an outline of how to name compounds. Good diagrams are easy to understand, quick to draw, and difficult to misinterpret.

- Always give a diagram alongside a name unless it really is something very simple, such as ethanol.

But we do need to be able to communicate by speech and by writing as well. In principle we could do this by using systematic names. In practice, however, the full systematic names of anything but the simplest molecules are far too clumsy for use in everyday chemical speech. There are several alternatives, mostly based on a mixture of trivial and systematic names.

Names for well-known and widely used simple compounds

A few simple compounds are called by trivial names not because the systematic names are complicated, but just out of habit. We know them so well that we use their familiar names.

You may have met the compound on the right before and perhaps called it ethanoic acid, its systematic name. But in a chemical laboratory everyone would refer to this acid as acetic acid, its trivial name. The same is true for all these common substances.

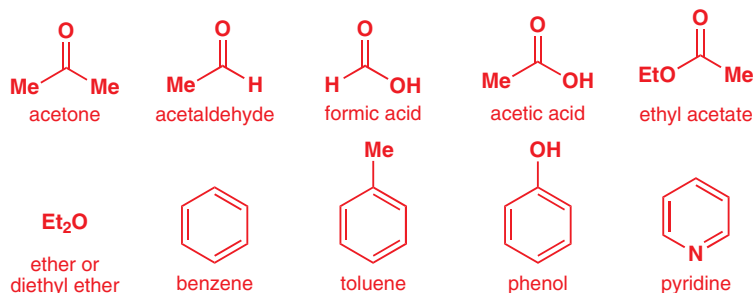
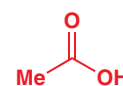

■ We haven't asked you to remember any trivial names of molecules yet, but these 10 compounds are so important you must be able to remember them. Learn them now.

Trivial names like this are often long-lasting, well-understood historical names that are less easy to confuse than their systematic counterparts. 'Acetaldehyde' is easier to distinguish from 'ethanol' than is 'ethanal'.

Trivial names also extend to fragments of structures containing functional groups. Acetone, acetaldehyde, and acetic acid all contain the acetyl group (MeCO-, ethanoyl) abbreviated Ac and chemists often use this organic element symbol in writing AcOH for acetic acid or EtOAc for ethyl acetate. Chemists use special names for four fragments because they have mechanistic as well as structural significance. These are vinyl and allyl, phenyl and benzyl.

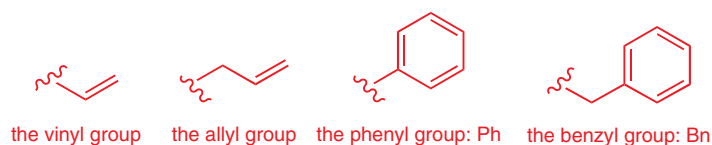

Giving the vinyl group a name allows chemists to use simple trivial names for compounds like vinyl chloride, the material that polymerizes to give PVC (polyvinyl chloride) but the importance of the name lies more in the difference in reactivity (Chapter 15) between the vinyl and allyl groups.

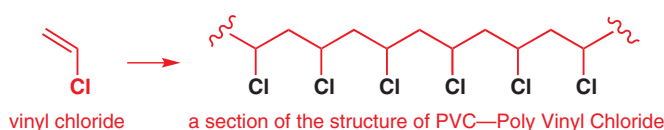

The allyl group gets its name from garlic (*Allium* sp.) because it makes up part of the structure of the compounds on the right responsible for the taste and smell of garlic.

Allyl and vinyl are different in that the vinyl group is attached directly to a double-bonded C=C carbon atom, while the allyl group is attached to a carbon atom *adjacent* to the C=C double bond. The difference is extremely important chemically: allyl compounds are typically quite reactive, while vinyl compounds are fairly unreactive.

For some reason, the allyl and vinyl groups have never acquired organic element symbols, but the benzyl group has and it is Bn. It is again important not to confuse the benzyl group with the phenyl group: the phenyl group is joined through a carbon atom in the ring, while the benzyl group is joined through a carbon atom attached to the ring. Phenyl compounds are typically unreactive but benzyl compounds are often reactive. Phenyl is like vinyl, and benzyl is like allyl. We shall review all the organic element symbols you have met at the end of the chapter.

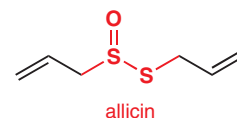
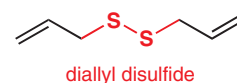

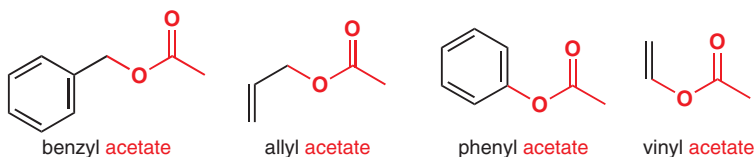

Names for more complicated but still well-known molecules

Complicated molecules that have been isolated from natural sources are always given trivial names because in these cases the systematic names really are impossible! Strychnine is a famous poison featured in many detective stories and a molecule with a beautiful structure. All chemists refer to it as strychnine as the systematic name is virtually unpronounceable. Two groups of experts at IUPAC and *Chemical Abstracts* also have different ideas on the systematic name for strychnine. Others like this are penicillin, DNA, and folic acid.

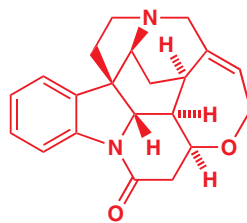

strychnine, or
 (1R,11R,18S,20S,21S,22S)-12-oxa-8,17-
 diazaheptacyclo[15.5.0^{1,8}.0^{2,7}.0^{15,20}]
 tetracos-2,4,6,14-tetraene-9-one (IUPAC)
 or
 4aR-[4a α ,5a α ,8aR*,15a α ,15b α ,15c β]-
 2,4a,5,5a,7,8,15,15a,15b,15c-decahydro-
 4,6-methano-6H,14H-indolo[3,2,1-*ij*]oxepino
 [2,3,4-*de*]pyrrolo[2,3-*h*]quinolone
 (*Chemical Abstracts*)

But the champion is vitamin B₁₂, a complicated cobalt complex with a three-dimensional structure of great intricacy. No chemist would learn this structure but would look it up in an advanced textbook of organic chemistry. You will find it in such books in the index under vitamin B₁₂ and not under its systematic name. We do not even know what its systematic name might be and we are not very interested.

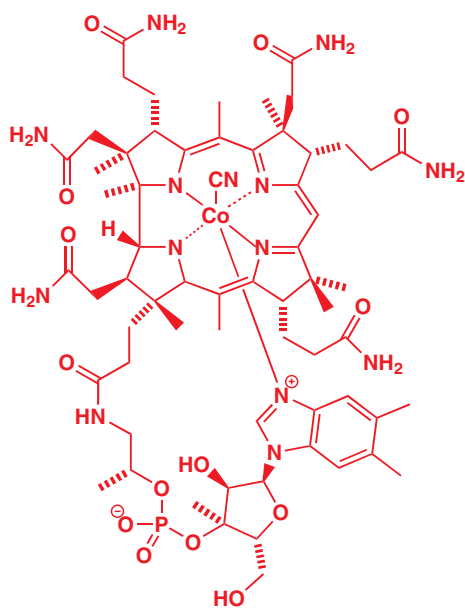

vitamin B₁₂, or...

Even fairly simple but important molecules, the amino acids for example, which have systematic names that are relatively easy to understand, are normally referred to by their trivial names, which are, with a bit of practice, easy to remember and hard to muddle up. They are given in full in Chapter 23.

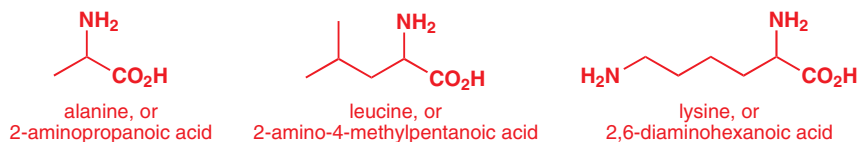

A very flexible way of getting new, simple names for compounds can be to combine a bit of systematic nomenclature with trivial nomenclature. Alanine is a simple amino acid that occurs in proteins. Add a phenyl group and you have phenylalanine, which is a more complex amino acid also in proteins. Toluene, the common name for methylbenzene, can be combined (both chemically and in making names for compounds!) with three nitro groups to give the famous explosive trinitrotoluene or TNT.

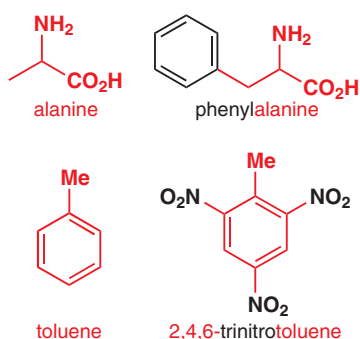

Compounds named as acronyms

Some compounds are referred to by acronyms, shortened versions of either their systematic or their trivial name. We just saw TNT as an abbreviation for TriNitroToluene but the more common use for acronyms is to define solvents and reagents in use all the time. Later in the book you will meet these solvents:

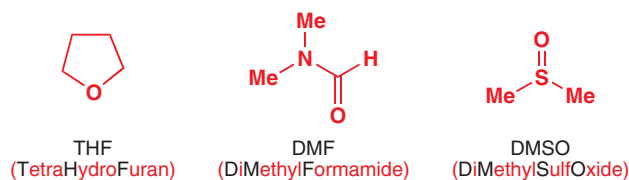

The following reagents are usually referred to by acronym and their functions will be introduced in other chapters so you do not need to learn them now. You may notice that some acronyms refer to trivial and some to systematic names.

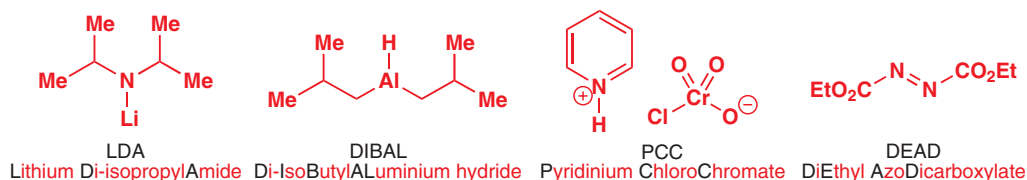

■ The names and structures of these common solvents need learning too.

Compounds for which chemists use systematic names

You may be surprised to hear that practising organic chemists use systematic names at all in view of what we have just described, but they do! Systematic names really begin with derivatives of

pentane (C_5H_{12}) since the prefix *pent-* means five, whereas *but-* does not mean four. Chemists refer to simple derivatives of open-chain and cyclic compounds with 5 to about 20 carbon atoms by their systematic names, providing that there is no common name in use. Here are some examples.

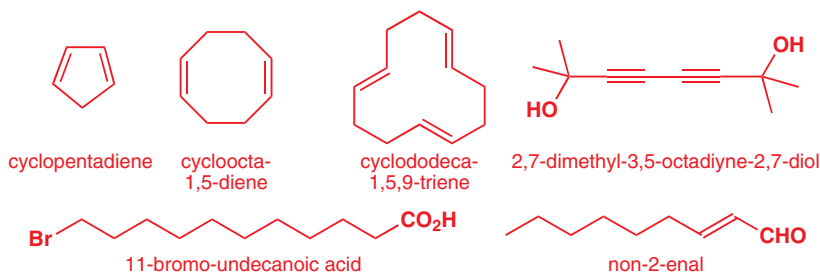

These names contain a syllable that tells you the framework size: penta- for C_5 , octa- for C_8 , nona for C_9 , undeca- for C_{11} , and dodeca- for C_{12} . These names are easily worked out from the structures and, what is more important, you get a clear idea of the structure from the name. One of them might make you stop and think a bit (which one?), but the others are clear even when heard without a diagram to look at.

Complicated molecules with no trivial names

When chemists make complex new compounds in the laboratory, they publish the method for making them in a chemical journal, giving their full systematic names in the experimental account, however long and clumsy those names may be. But in the text of the paper, and while talking in the laboratory about the compounds they have made, they will just call them ‘the amine’ or ‘the alkene’. Everyone knows which amine or alkene is meant because at some point they remember seeing a chemical structure of the compound. This is the best strategy for talking about almost any molecule: draw a structure, then give the compound a ‘tag’ name like ‘the amine’ or ‘the acid’. In written chemistry it’s often easiest to give every chemical structure a ‘tag’ number as well. To illustrate what we mean, let’s talk about a recent drug synthesis.

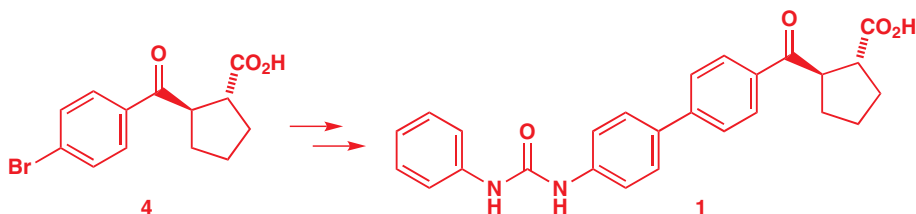

This potential anti-obesity drug 1, which might overcome insulin resistance in diabetics, was recently made at Abbott laboratories from a simpler intermediate 4. In the published work the drug is called ‘a selective DGAT-1 inhibitor’ but that doesn’t mean much to us. In the text of the paper they refer to it by its compound number 1. How much more sensible than using its systematic name: *trans*-(1*R*,2*R*)-2-(4’-(3-phenylureido)biphenylcarbonyl)cyclopentanecarboxylic acid. The simpler intermediate they call ‘the ketoacid 4’ or ‘the aryl bromide 4’ or ‘the free acid 4’ depending on what aspect of its structure they want to emphasize. Notice that in both cases a clear diagram of the structure appears with its number.

How should you name compounds?

So what should you call a compound? It really depends on circumstances, but you won’t go far wrong if you follow the example of this book. We shall use the names for compounds

that real chemists use. There's no need to learn all the commonly used names for compounds now, but you should log them in your memory as you come across them. Never allow yourself to pass a compound name by unless you are sure you know what chemical structure it refers to.

● **Our advice on chemical names—six points in order of importance**

- Draw a structure first and worry about the name afterwards.
- Learn the names of the *functional groups* (ester, nitrile, etc.).
- Learn and use the names of a few simple compounds used by all chemists.
- In speech, refer to compounds as 'that acid' (or whatever) while pointing to a diagram.
- Grasp the principles of systematic (IUPAC) nomenclature and use it for compounds of medium size.
- Keep a notebook to record acronyms, trivial names, structures, etc. that you might need later.

We've met a great many molecules in this chapter. Most of them were just there to illustrate points so don't learn their structures! Instead, learn to recognize the names of the functional groups they contain. However, there were 10 names for simple compounds and three for common solvents that we advised you to learn. Cover up the right-hand part of each column and draw the structures for these 14 compounds.

Important structures to learn

acetone

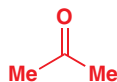

toluene

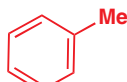

ether or diethyl-ether

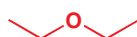

pyridine



acetaldehyde

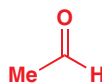

phenol

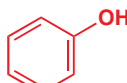

formic acid

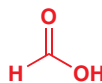

aniline

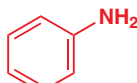

acetic acid or AcOH

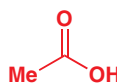

THF or tetrahydrofuran



benzene



DMF, Me₂NCHO, or dimethylformamide

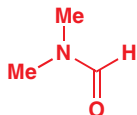

ethyl acetate or EtOAc

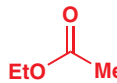



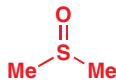





DMSO

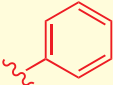

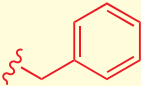
That's all we'll say on the subject of nomenclature—you'll find that as you practise using these names and start hearing other people referring to compounds by name you'll soon pick up the most important ones. But, to reiterate, make sure you never pass a compound name by without being absolutely sure what it refers to—draw a structure to check.

● Review box: Table of fragment names and 'organic elements'

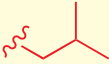
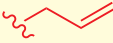
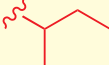
R	alkyl		t-Bu	tert-butyl	
Me	methyl		Ar	aryl	any aromatic ring
Et	ethyl		Ph	phenyl	
Pr (n-Pr)	propyl		Bn	benzyl	
Bu (n-Bu)	butyl		Ac	acetyl	
i-Pr	isopropyl			vinyl	
i-Bu	isobutyl			allyl	
s-Bu	sec-butyl		X	halide	F, Cl, Br or I

Further reading

All the big American textbooks have early chapters on structure, shape, and the drawing of molecules but they tend to use Lewis structures with all atoms and electrons in bonds shown and often right angles between bonds.

A short and sensible introduction is in the Oxford Primer *Foundations of Organic Chemistry* by M. Hornby and J. Peach, OUP, Oxford, 1996.

For more on palytoxin: E. M. Suh and Y. Kishi, *J. Am. Chem. Soc.*, 1994, **116**, 11205–11206.

For an account of the competing claims to the first proposal of a cyclic structure of benzene, see Alfred Bader's article 'Out of the Shadow' in the 17 May 1993 issue of *Chemistry and Industry*.

Check your understanding



To check that you have mastered the concepts presented in this chapter, attempt the problems that are available in the book's Online Resource Centre at <http://www.oxfordtextbooks.co.uk/orc/clayden2e/>

Determining organic structures

Connections

➔ Building on

- What sorts of structures organic molecules have **ch2**

Arriving at

- Determining structure by X-ray crystallography
- Determining structure by mass spectrometry
- Determining structure by ^{13}C NMR spectroscopy
- An introduction to ^1H NMR spectroscopy
- Determining structure by infrared spectroscopy

➔ Looking forward to

- How ^{13}C NMR spectroscopy helps locate electrons **ch7**
- How infrared spectroscopy tells us about reactivity **ch10 & ch11**
- Using ^1H NMR spectroscopy to determine structures **ch13**
- Solving unknown structures spectroscopically **ch13**

Introduction

Organic structures can be determined accurately and quickly by spectroscopy

Having urged you, in the last chapter, to draw structures realistically, we now need to answer the question: what is realistic? How do we know what structures molecules actually have? Make no mistake about this important point: *we really do know what shape molecules have*. You wouldn't be far wrong if you said that the single most important development in organic chemistry in modern times is just this certainty, as well as the speed with which we can be certain. What has caused this revolution can be stated in a word—spectroscopy.

● What is spectroscopy?

Rays or waves interact with molecules	Spectroscopy	Tells us about
X-rays are scattered by atoms	Measures the scattering pattern	Bond lengths and angles
Radio waves make nuclei resonate	Plots charts of resonant frequencies	The symmetry and connectivity of the hydrocarbon skeleton
Infrared waves make bonds vibrate	Plots charts of absorption	The functional groups in the molecule

Structure of the chapter

We shall first consider structure determination as a whole and then introduce three different methods:

- mass spectrometry (to determine mass of the molecule and atomic composition)
- nuclear magnetic resonance (NMR) spectroscopy (to determine symmetry, branching, and connectivity in the molecule)
- infrared spectroscopy (to determine the functional groups in the molecule).

Online support. The icon  in the margin indicates that accompanying interactive resources are provided online to help your understanding: just type www.chemtube3d.com/clayden/123 into your browser, replacing **123** with the number of the page where you see the icon. For pages linking to more than one resource, type **123-1**, **123-2** etc. (replacing **123** with the page number) for access to successive links.

■ If you would like more details of any of the spectroscopic methods we discuss, you should refer to one of the specialized books listed in the 'further reading' section at the end of this chapter.

Of these, NMR is more important than all the rest put together and so we shall return to it in more detail in Chapter 13. Then in Chapter 18, after we've discussed a wider range of molecules, there will be a review chapter to bring the ideas together and show you how unknown structures are really determined.

X-ray is the final appeal

In Chapter 2 we suggested you draw saturated carbon chains as zig-zags and not in straight lines with 90° or 180° bond angles. This is because we know they *are* zig-zags. The X-ray crystal structure of the 'straight' chain diacid, hexanedioic acid, is shown below. You can clearly see the zig-zag chain, the planar carboxylic acid groups, and even the hydrogen atoms coming towards you and going away from you. It obviously makes sense to draw this molecule *realistically*, as in the second drawing.

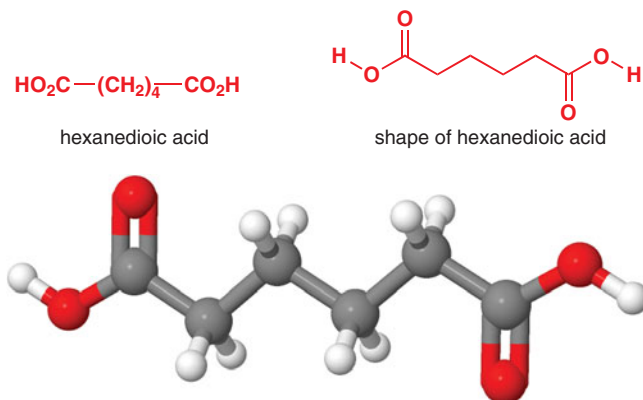

X-ray crystal structures are determined by allowing a sample of a crystalline compound to diffract X-rays. From the resulting diffraction pattern, it is possible to deduce the precise spatial arrangement of the atoms in the molecule—except, usually, the hydrogen atoms, which are too light to diffract the X-rays and whose position must be inferred from the rest of the structure. This is one question that X-ray answers better than any other method: what shape does a molecule have? Another important problem it can solve is the structure of an important new unknown compound. There are subterranean bacteria, for example, that use methane as an energy source. It is amazing that bacteria manage to convert methane into anything useful, and, of course, chemists really wanted to know how they did it. In 1979 it was found that the bacteria use a coenzyme, given the trivial name 'methoxatin', to oxidize methane to methanol. Methoxatin was a new compound with an unknown structure and could be obtained in only very small amounts. It proved exceptionally difficult to solve the structure by NMR but eventually methoxatin was found by X-ray crystallography to be a polycyclic tricarboxylic acid.

■ **Coenzymes** are biochemical reagents that work hand-in-hand with enzymes to catalyse reactions.

 Interactive structure of methoxatin

■ The trivial name 'methoxatin' has a systematic alternative: 4,5-dihydro-4,5-dioxo-1H-pyrrolo[2,3-f]quinoline-2,7,9-tricarboxylic acid. Both are valid names. There are no prizes for guessing which one is used more often.

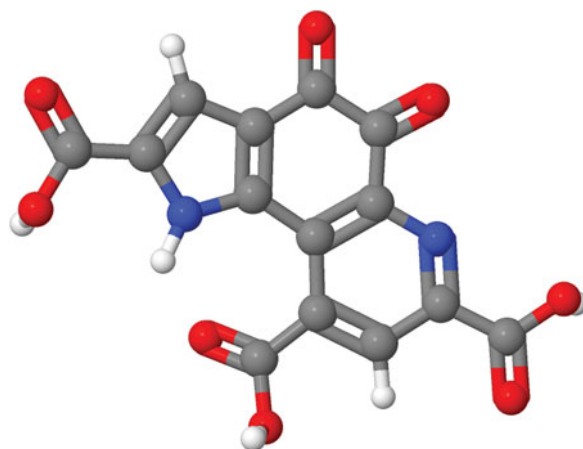
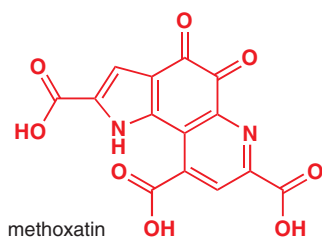

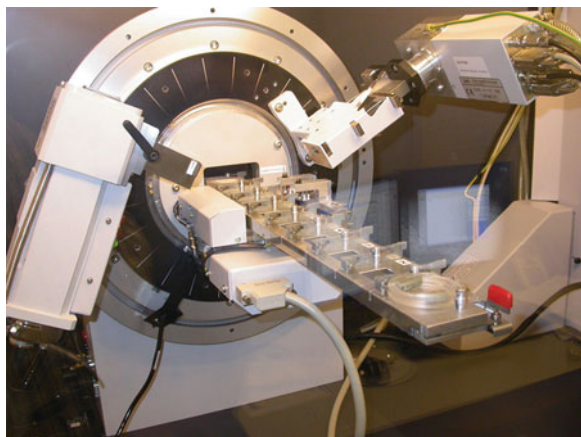

X-ray crystallography has its limitations

If X-ray crystallography is so powerful, why do we bother with other methods? There are two reasons:

- X-ray crystallography works by the scattering of X-rays from electrons and requires crystalline solids. If an organic compound is a liquid or is a solid but does not form good crystals, its structure cannot be determined in this way.
- X-ray crystallography is a science in its own right, requiring specialized skills, and a structure determination can take a long time. Modern methods have reduced this time to a matter of hours or less, but nonetheless by contrast a modern NMR machine with a robot attachment can run more than 100 spectra overnight. We normally use NMR routinely and reserve X-rays for difficult unknown structures and for determining the detailed shape of important molecules.

X-ray crystallography is not infallible!

Because it cannot usually 'see' H atoms, it is important to appreciate that X-ray crystallography is not infallible: it can still get things wrong. A famous example is the antibiotic diazepamide A, which from 1991 (when it was isolated from a marine organism) until 2001 (when the error was realized) was thought to have the structure shown on the right. It has the same mass as the real structure on the left, and X-ray crystallography was unable to tell the O and the N apart. Only when the compound was synthesized did the error become apparent, and the fact that the correct structure was indeed that on the left was confirmed by the fact that synthetic material of this structure made in 2002 was identical with the natural product.

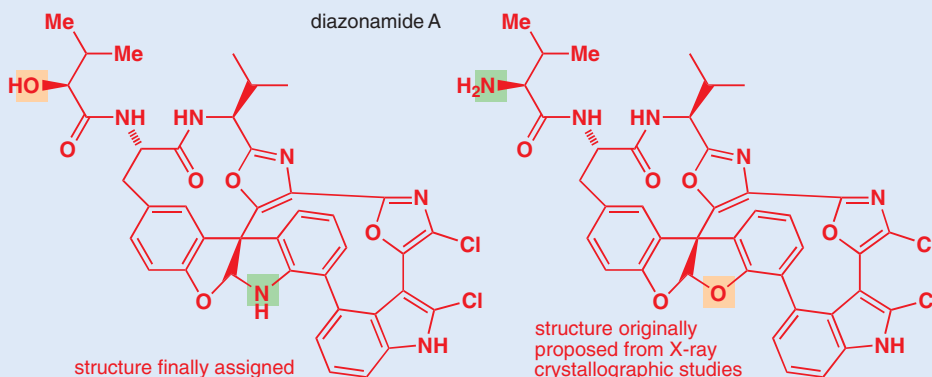

Outline of structure determination by spectroscopy

Put yourself in these situations, regularly encountered by professional chemists:

- You notice an unexpected product from a chemical reaction.
- You discover a previously unknown compound in a plant extract.

- You detect a suspected food contaminant and need to know what it is.
- You are routinely checking purity during the manufacture of a drug.

In all cases, except perhaps the second, you would need a quick and reliable answer. Suppose you are trying to identify the heart drug propranolol. You would first want to know the molecular weight and atomic composition, and these would come from a *mass spectrum*: propranolol has a molecular weight (relative molecular mass) of 259 and the composition $C_{16}H_{21}NO_2$. Next you would need the carbon skeleton—this would come from *NMR*, which would reveal the three fragments shown below.

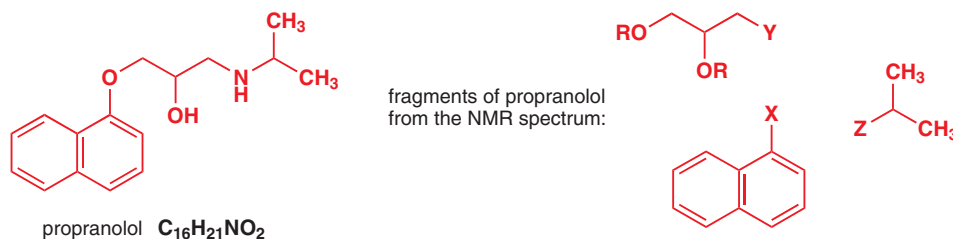

■ NMR does not literally break up the molecule into fragments, but it does view molecules as pieces of hydrocarbon linked together.

There are many ways in which the fragments seen by NMR could be joined together and at this stage you would have no idea whether the oxygen atoms were present as OH groups or as ethers, whether the nitrogen would be an amine or not, and whether Y and Z might or might not be the same atom, say N. More information comes from the infrared spectrum, which highlights the functional groups, and which would show that there is an OH and an NH in the molecule but not other functional groups such as CN or NO_2 . This still leaves a variety of possible structures, and these could finally be distinguished by the details revealed by 1H NMR. We will deal with 1H NMR only briefly in this chapter because it is more complicated than ^{13}C NMR, but we will return to it in Chapter 13.

Now we must go through each of these methods and see how they give us information about the propranolol molecule.

● What each spectroscopic method tells us

Method and what it does	What it tells us	Type of data provided
Mass spectrum weighs the molecule	Molecular weight (relative molecular mass) and composition	259; $C_{16}H_{21}NO_2$
^{13}C NMR reveals all the different carbon nuclei	Carbon skeleton	No C=O group; ten carbons in aromatic rings; two carbons next to O; three other saturated C atoms
Infrared reveals chemical bonds	Functional groups	No C=O group; one OH; one NH
1H NMR reveals all the different H nuclei	Distribution of H atoms	Two methyl groups; six H atoms on aromatic rings; three H atoms on carbons next to O; three H atoms on carbons next to N

■ Mass spectrometry is different from other forms of spectroscopy because it measures mass rather than the absorption of energy.

Mass spectrometry

Mass spectrometry weighs the molecule

It's not easy to weigh a neutral molecule, and a mass spectrometer works by measuring the mass of a charged ion instead: the charge makes the molecule controllable by an electric field. A mass spectrometer therefore has three basic components:

- something to volatilize and ionize the molecule into a beam of charged particles
- something to focus the beam so that particles of the same mass:charge ratio are separated from all others and
- something to detect the particles.

All spectrometers in common use operate in a high vacuum and use one of several methods to convert neutral molecules into cations, the most common being **electron impact**, **chemical ionization**, and **electrospray**.

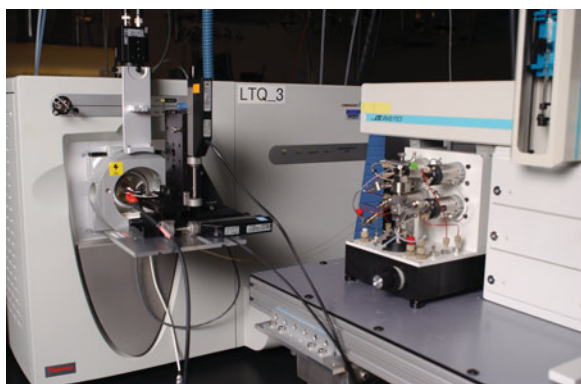

Mass spectrometry by electron impact

In electron impact (EI) mass spectrometry the molecule is bombarded with highly energetic electrons that knock a weakly bound electron out of the molecule. If you think this is strange, think of throwing bricks at a brick wall: the bricks can't stick to the wall but can knock loose bricks off the top of the wall. Losing a single electron leaves behind an unpaired electron and a positive charge. The electron that is lost will be one of relatively high energy (the bricks come from the *top* of the wall), and typically one not involved in bonding, for example an electron from a lone pair.

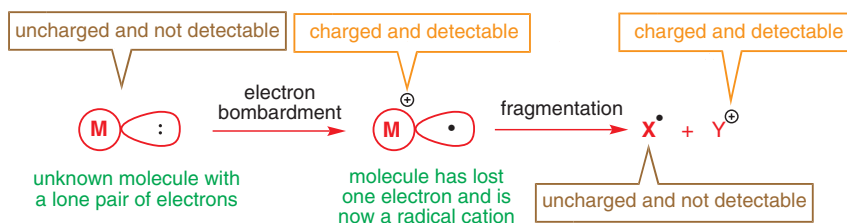

Thus ammonia gives $NH_3^+\bullet$ and a ketone gives $R_2C=O^+\bullet$. These unstable species are known as **radical cations**, and being charged they are accelerated by an electric field and focused onto the detector, which detects the mass of the ion by how far its path has been deflected by the electric field. It only takes about 20 μs for the radical cations to reach the detector, but sometimes they fragment before they get there, in which case other ions will also be detected. These fragments will always have a lower mass than the 'parent' molecular ion, so in a typical mass spectrum we are most interested in the heaviest ion we can see.

A typical EI mass spectrum looks like this:

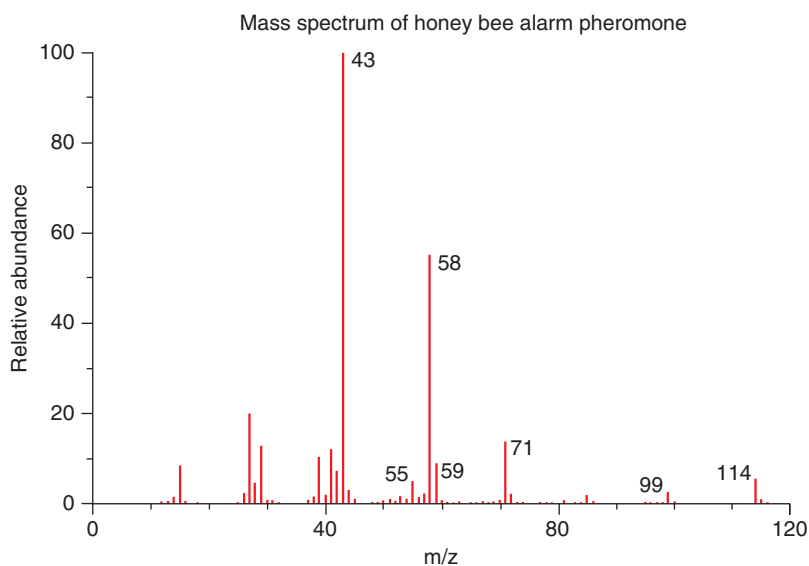

Radical cations

Most molecules have all their electrons paired; **radicals** have unpaired electrons. Molecules that carry a negative charge are **anions**; molecules with a positive charge are **cations**. **Radical cations** and **radical anions** are simply species that are both charged *and* have an unpaired electron.

This compound was identified as a pheromone deposited by worker bees when feeding as a marker to deter their colleagues from visiting the same, now depleted, nectar source. Only minute quantities are available for analysis of course, but that doesn't matter: mass spectrometry is successful even on a microgram scale. The spectrum you see here indicates that the molecule has a mass of 114 because that is the highest mass observed in the spectrum: the molecule is in fact the volatile ketone heptan-2-one.

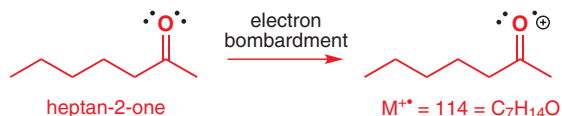

Mass spectrometry by chemical ionization, electrospray, or other methods

■ If you are interested in how to use fragmentation patterns to establish structure, you should consult one of the specialized textbooks in the bibliography at the end of this chapter.

■ We will not be discussing ionization techniques in detail: it is sufficient for you to realize at this stage that there are several ways of ionizing a molecule gently so that its mass can be determined.

A problem with EI mass spectrometry is that, for fragile molecules, the energy of the bombarding electron can be sufficient to cause it to fragment completely, losing all trace of the molecular ion. Some useful information can be gained from fragmentation patterns, but in general it is more useful to aim to weigh the molecule all in one piece. This can be achieved using any of a number of other techniques, of which the most common are chemical ionization (CI) and electrospray (ES).

Chemical ionization is achieved by mixing a gas such as ammonia with the substrate in the spectrometer. Bombardment of NH_3 with electrons leads to formation of some NH_4^+ by proton transfer, and reaction of this ion with the substrate makes a charged complex, which can be accelerated by the electric field. The masses observed by chemical ionization spectroscopy carried out in this way are usually $M + 1$ or $M + 18$ (the mass of NH_4^+) relative to the mass of the substrate. With electrospray mass spectroscopy, an aerosol of the substrate is ionized, and ionization in the presence of sodium ions means that masses of $M + 1$ and $M + 23$ are often seen, or, if the ionization forms anions, $M - 1$.

This is the electrospray mass spectrum of heptan-2-one. Notice how a single molecular ion is clearly visible this time, but that it has a mass of 137, which is 23 more than the mass of 114 (in other words, this is the mass of $M + \text{Na}^+$).

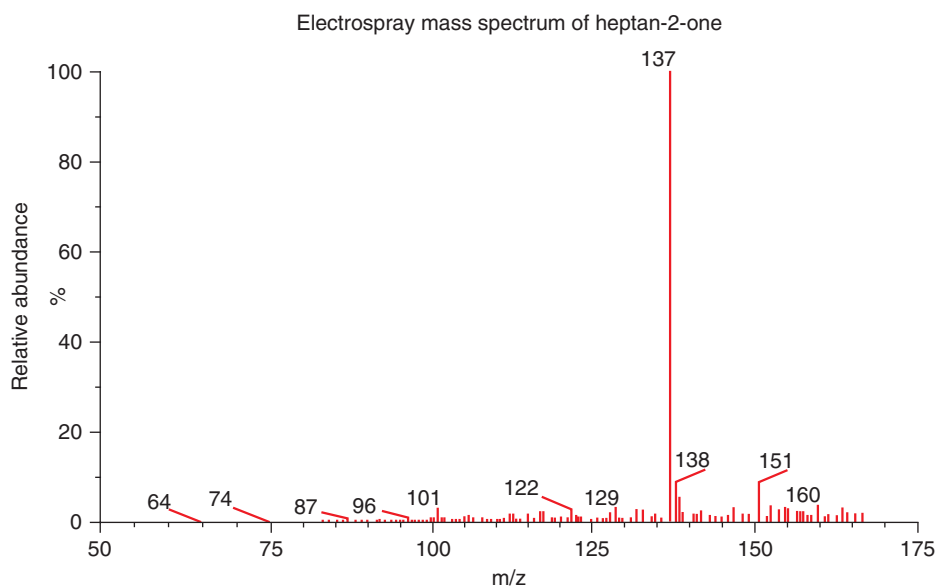

Mass spectrometry detects isotopes

Most elements can exist as more than one isotope. Usually, one isotope accounts for the vast majority (perhaps >99%) of the atoms of an element. But for some elements, atoms of several isotopes make up a significant proportion of the total in a sample. Chlorine, for example, is

normally a 3:1 mixture of ^{35}Cl and ^{37}Cl (hence the averaged relative atomic mass of 35.5 for chlorine), while bromine is an almost 1:1 mixture of ^{79}Br and ^{81}Br (hence the average mass of 80 for bromine). Because mass spectrometry weighs individual molecules, there is no averaging; instead it detects the true weight of each molecule, whatever isotope it contains.

For example, the molecular ion in the EI mass spectrum of this aryl bromide has two peaks at 186 and 188 of roughly equal intensity. Having two molecular ions of equal intensity separated by 2 mass units is indicative of bromine in a molecule.

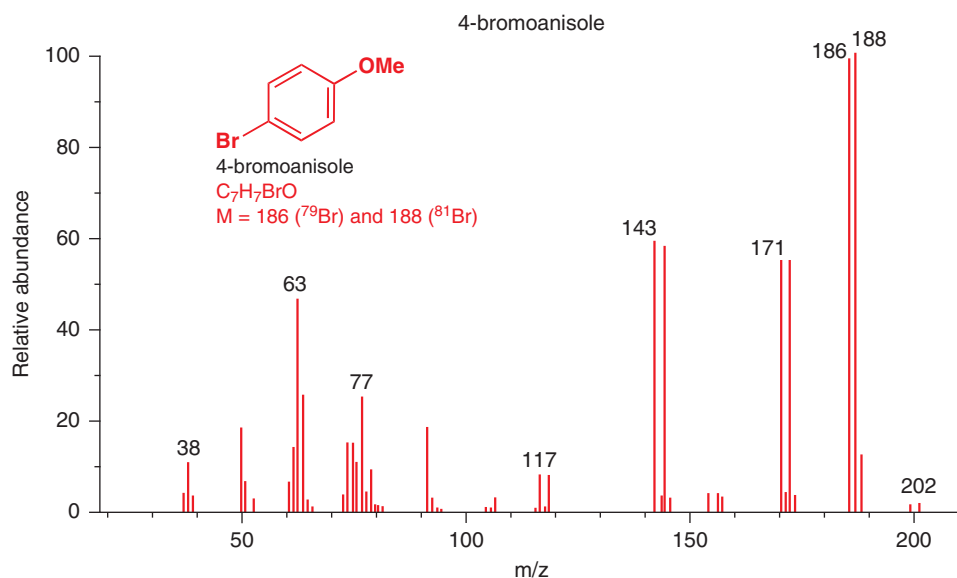

The mass spectrum of a chlorine-containing molecule is likewise easy to identify from two peaks separated by two mass units, but this time in a ratio of 3:1, arising from the 3:1 isotopic ratio of ^{35}Cl and ^{37}Cl .

What happens with more than one Br or Cl? Here's an example: the painkiller diclofenac. This spectrum was obtained from commercial tablets, which contain the potassium salt of the active ingredient (it becomes protonated in the acidic environment of the stomach).

The ES spectrum shows the mass of the carboxylate anion as three peaks, at 294, 296, and 298. The relative size of the peaks can be worked out from the 75% probability that each Cl atom will be ^{35}Cl and the 25% probability it will be ^{37}Cl . The ratios are therefore $3/4 \times 3/4 : 2 \times 3/4 \times 1/4 : 1/4 \times 1/4$ or 9:6:1.

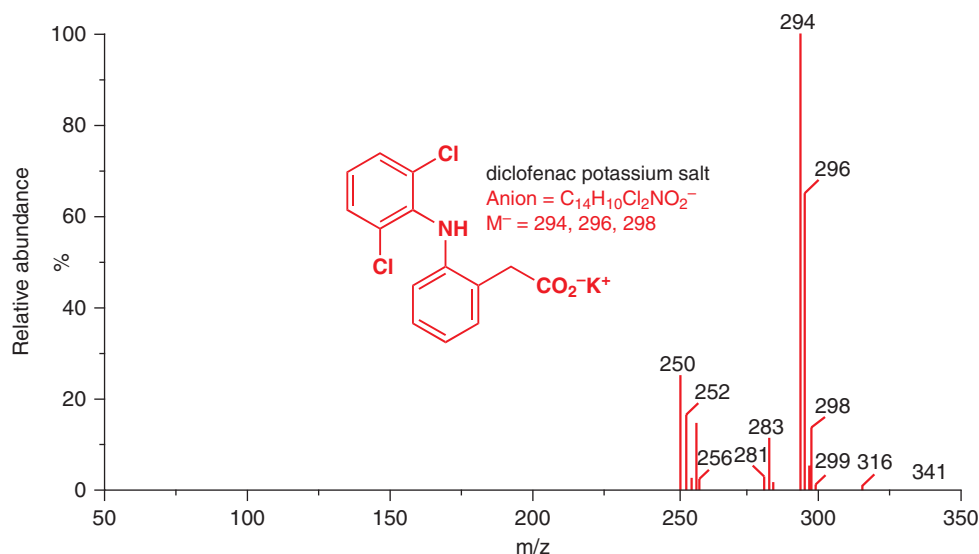

■ Diclofenac behaves like soluble aspirin in this way: see Chapter 8, p. 163.

Summary table of common elements with more than one isotope at >1% abundance

Element	Isotopes	Approximate ratio	Exact ratio
carbon	^{12}C , ^{13}C		98.9:1.1
chlorine	^{35}Cl , ^{37}Cl	3:1	75.8:24.2
bromine	^{79}Br , ^{81}Br	1:1	50.5:49.5

H, N, O, S, P, F, and I have only very small amounts of isotopes other than ^1H , ^{14}N , ^{16}O , ^{31}P , ^{32}S , and ^{127}I . The real oddity though is tin, which exists as a mixture of 10 different stable isotopes, the major ones being ^{116}Sn (15%), ^{117}Sn (8%), ^{118}Sn (24%), ^{119}Sn (9%), ^{120}Sn (33%), ^{122}Sn (5%), and ^{124}Sn (6%). In reality the precise ratio of isotopes for any element varies according to its source, a fact which can supply useful forensic information.

Carbon has a minor but important isotope ^{13}C

The minor isotopes of many elements that appear at below the 1% level are not usually important, but one we cannot ignore is the 1.1% of ^{13}C present in ordinary carbon, of which the main isotope is of course ^{12}C . Another isotope, ^{14}C , is radioactive and used in carbon dating, but its natural abundance is minute. The stable isotope ^{13}C is not radioactive, but it is *NMR active*, as we shall soon see. If you look back at all the mass spectra illustrated so far in this chapter, you will see a small peak one mass unit higher than each peak: these are peaks arising from molecules containing ^{13}C instead of ^{12}C . The exact height of these peaks is useful as an indication of the number of carbon atoms in the molecule. Each carbon has a 1.1% chance of being ^{13}C rather than ^{12}C , so the more C atoms there are the bigger this chance becomes. If there are n carbon atoms in a molecular ion, then the ratio of M^+ to $[M + 1]^+$ is $100:(1.1 \times n)$.

Look at the spectrum below: it's the fuel additive Topanol 354, whose structure and molecular formula are shown. With 15 carbons, there's a 16.5% chance there will be one ^{13}C atom in the molecule, and you can clearly see the sizeable $M + 1$ peak at 237. We can ignore the possibility of having *two* ^{13}C atoms as the probability is so small.

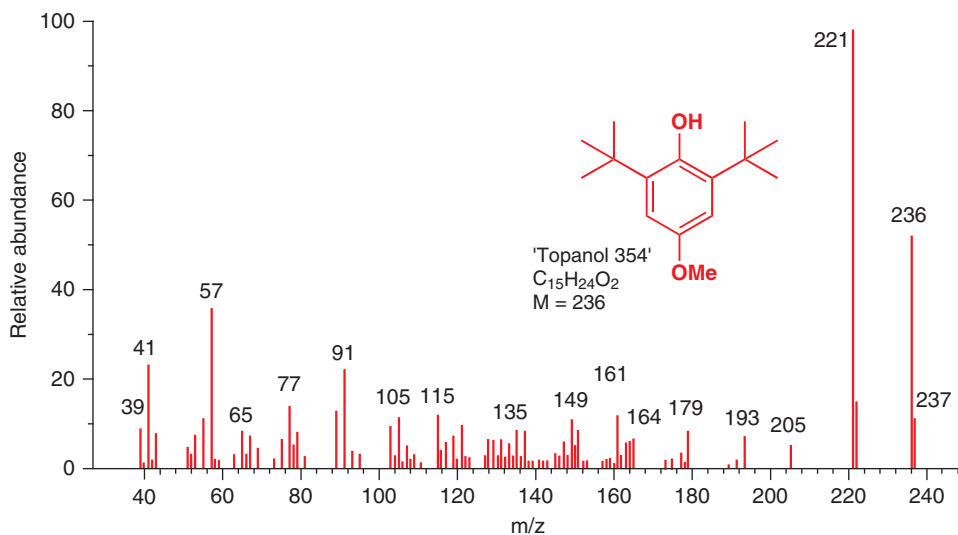

- For any mass spectrum, always look at the heaviest peak first: note whether there is chlorine or bromine in the molecule, and look to check that the ratio of M^+ to $[M + 1]^+$ is about right for the number of carbons you expect.

Atomic composition can be determined by high-resolution mass spectrometry

Ordinary mass spectra tell us the molecular weight (MW) of the molecule: we could easily see, for example, that the bee pheromone on p. 48 had MW 114 even without knowing its structure. When we revealed it was $\text{C}_7\text{H}_{14}\text{O}$, we had to use other information to infer this, because 114 could also be many other things, such as C_8H_{18} or $\text{C}_6\text{H}_{10}\text{O}_2$ or $\text{C}_6\text{H}_{14}\text{N}_2$. These different atomic compositions for the same molecular weight can nonetheless be distinguished if we know the *exact* molecular weight, since individual isotopes have non-integral masses (except ^{12}C by definition). The table below gives these masses to five decimal places, which is the sort of accuracy you need for meaningful results. Such accurate mass measurements are obtained by a technique called *high-resolution mass spectrometry*.

The reason that exact masses are not integers lies in the slight mass difference between a proton (1.67262×10^{-27} kg) and a neutron (1.67493×10^{-27} kg), and in the fact that electrons have mass (9.10956×10^{-31} kg).

Exact masses of common elements

Element	Isotope	Mass number	Exact mass
hydrogen	^1H	1	1.00783
carbon	^{12}C	12	12.00000
carbon	^{13}C	13	13.00335
nitrogen	^{14}N	14	14.00307
oxygen	^{16}O	16	15.99492
fluorine	^{19}F	19	18.99840
phosphorus	^{31}P	31	30.97376
sulfur	^{32}S	32	31.97207
chlorine	^{35}Cl	35	34.96886
chlorine	^{37}Cl	37	36.96590
bromine	^{79}Br	79	78.91835
bromine	^{81}Br	81	80.91635

For the bee pheromone on p. 48, the accurate mass turns out to be 114.1039. The table below compares possible atomic compositions for an approximate MW 114, and the result is conclusive. The exact masses to three places of decimals fit the observed exact mass only for the composition $\text{C}_7\text{H}_{14}\text{O}$. You may not think the fit is very good when you look at the two numbers, but notice the difference in the error expressed as parts per million. One answer stands out from the rest. Note that even two places of decimals would be enough to distinguish these four compositions.

Exact mass determination for the bee alarm pheromone

Composition	Calculated M^+	Observed M^+	Error in ppm
$\text{C}_6\text{H}_{10}\text{O}_2$	114.068075	114.1039	358
$\text{C}_6\text{H}_{14}\text{N}_2$	114.115693	114.1039	118
$\text{C}_7\text{H}_{14}\text{O}$	114.104457	114.1039	5
C_8H_{18}	114.140844	114.1039	369

● In the rest of the book, whenever we state that a molecule has a certain atomic composition you can assume that it has been determined by high-resolution mass spectrometry on the molecular ion.

One thing you may have noticed in the table above is that there are no entries with just one nitrogen atom. Two nitrogen atoms, yes; one nitrogen no! This is because any complete molecule with C, H, O, S, and *just one nitrogen in it has an odd molecular weight*. This is because C, O, S, and N all have even atomic weights—only H has an odd atomic weight. Nitrogen is the only element from C, O, S, and N that can form an odd number of bonds (3). Molecules with one nitrogen atom must have an odd number of hydrogen atoms and hence an odd molecular weight.

● **Quick nitrogen count (for molecules containing any of the elements C, H, N, O, and S)**
Molecules with an odd molecular weight must have an odd number of nitrogen atoms.
Molecules with even molecular weight must have an even number of nitrogen atoms or none at all.

Nuclear magnetic resonance

What does it do?

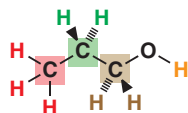

^1H NMR distinguishes the coloured hydrogens
 ^{13}C NMR distinguishes the boxed carbons

Nuclear magnetic resonance (NMR) allows us to detect atomic nuclei and say what sort of environment they are in within the molecule. In a molecule such as propanol, the hydrogen atom of the hydroxyl group is clearly different from the hydrogen atoms of its carbon skeleton—it can be displaced by sodium metal, for example. NMR (actually ^1H , or proton, NMR) can easily distinguish between these two sorts of hydrogens by detecting the environment the hydrogen's nucleus finds itself in. Moreover, it can also distinguish between all the other different sorts of hydrogen atoms present. Likewise, carbon (more precisely ^{13}C) NMR can easily distinguish between the three different carbon atoms. NMR is extremely versatile: it can even scan living human brains (see picture) but the principle is still the same: being able to detect nuclei (and hence atoms) in different environments.



■ When NMR is used medically it is usually called magnetic resonance imaging (MRI) for fear of alarming patients wary of all things *nuclear*.

NMR uses a strong magnetic field

Imagine for a moment that we were able to 'switch off' the earth's magnetic field. Navigation would be made much harder since all compasses would be useless, with their needles pointing randomly in any direction. However, as soon as we switched the magnetic field back on, they would all point north—their lowest energy state. Now if we wanted to force a needle to point south we would have to use up energy and, of course, as soon as we let go, the needle would return to its lowest energy state, pointing north.

In a similar way, some atomic nuclei act like tiny compass needles when placed in a magnetic field and have different energy levels according to the direction in which they are 'pointing'. (We will explain how a nucleus can 'point' somewhere in a moment.) A real compass needle can rotate through 360° and have an essentially infinite number of different energy levels, all higher in energy than the 'ground state' (pointing north). Fortunately, things are simpler with an atomic nucleus: its energy levels are quantized, just like the energy levels of an electron, which you will meet in the next chapter, and it can adopt only certain specific energy levels. This is like a compass which points, say, only north or south, or maybe only north, south, east, or west, and nothing in between. Just as a compass needle has to be made of a magnetic material to feel the effect of the earth's magnetism, so it is that only certain nuclei are 'magnetic'. Many (including 'normal' carbon-12, ^{12}C) do not interact with a magnetic field at all and cannot be observed in an NMR machine. But, importantly for us in this chapter, the minor carbon isotope ^{13}C does display magnetic properties, as does ^1H , the most abundant atomic nucleus on earth. When a ^{13}C or ^1H atom finds itself in a magnetic field, it has two available energy states: it can either align itself with the field ('north' you could say), which would be the lowest energy state, or against the field ('south'), which is higher in energy.



■ This picture shows a typical NMR instrument. The fat cylinder is the supercooled magnet. The device hanging over it is an automatic sample changer and the console in the foreground controls the machine.

The property of a nucleus that allows magnetic interactions, i.e. the property possessed by ^{13}C and ^1H but not by ^{12}C , is *spin*. If you conceive of a ^{13}C and ^1H nucleus spinning, you can see how the nucleus can point in one direction—it is the axis of the spin that is aligned with or against the field.

Let's return to the compass for a moment. If you want to move a compass needle away from pointing north, you have to push it—and expend energy as you do so. If you put the compass next to a bar magnet, the attraction towards the magnet is much greater than the attraction towards the north pole, and the needle now points at the magnet. You also have to push much harder if you want to move the needle. Exactly how hard it is to turn the compass needle depends on how strong the magnetic field is and also on how well the needle is magnetized—if it is only weakly magnetized, it is much easier to turn it round and if it isn't magnetized at all, it is free to rotate.

Likewise, for a nucleus in a magnetic field, the difference in energy between the nuclear spin aligned with and against the applied field depends on:

- how strong the magnetic field is, and
- the magnetic properties of the nucleus itself.

The stronger the magnetic field, the greater the energy difference between the two alignments of the nucleus. Now there is an unfortunate thing about NMR: the energy difference between the nuclear spin being aligned with the magnetic field and against it is really *very* small—so small that we need a very, very strong magnetic field to see any difference at all.

NMR also uses radio waves

A ^1H or ^{13}C nucleus in a magnetic field can have two energy levels, and energy is needed to flip the nucleus from the more stable state to the less stable state. But since the amount of energy needed is so small, it can be provided by low-energy electromagnetic radiation of radio-wave frequency. Radio waves flip the nucleus from the lower energy state to the higher state. Turn off the radio pulse and the nucleus returns to the lower energy state. When it does so, the energy comes out again, and this (a tiny pulse of radio frequency electromagnetic radiation) is what we detect.

We can now sum up how an NMR machine works.

1. The sample of the unknown compound is dissolved in a suitable solvent, placed in a narrow tube, and put inside a very strong electromagnet. To even out imperfections in

Nuclear spin is quantized and has the symbol I . The exact number of different energy levels a nucleus can adopt is determined by the value of I of the particular isotope. The nuclear spin I can have various values such as 0, $1/2$, 1, $3/2$... and the number of energy levels is given by $2I + 1$. Some examples are ^1H , $I = 1/2$; ^2H (= D), $I = 1$; ^{11}B , $I = 5/2$; ^{12}C , $I = 0$.

NMR machines contain very strong electromagnets. The earth's magnetic field has a field strength of between 30 and 60 microtesla. A typical magnet used in an NMR machine has a field strength of between 2 and 10 tesla, some 10^5 times stronger than the earth's field. These magnets are dangerous and no metal objects must be taken into the rooms where they are: stories abound of unwitting workmen whose metal toolboxes have become firmly attached to NMR magnets. Even with the immensely powerful magnets used the energy difference is still so small that the nuclei only have a very small preference for the lower energy state. Fortunately, we can just detect this small preference.

Radio waves are very, very low in energy. You may know—and if not, you will need to in the future—that the energy associated with electromagnetic radiation is related to its wavelength λ by the formula:

$$E = hc/\lambda$$

where h and c are constants (Planck's constant and the speed of light). Radio waves, whose wavelengths are measured in metres, are millions of times less energetic than rays of visible light, with wavelengths between 380 nm (violet) and 750 nm (red).

the sample, the tube is spun very fast by a stream of air. Inside the magnetic field, any atomic nuclei with a nuclear spin now possess different energy levels, the exact number of different energy levels depending on the value of the nuclear spin. For ^1H and ^{13}C NMR there are two energy levels.

- The sample is irradiated with a short pulse of radiofrequency energy. This disturbs the equilibrium balance between the two energy levels: some nuclei absorb the energy and are promoted to a higher energy level.
- When the pulse finishes, the radiation given out as the nuclei fall back down to the lower energy level is detected using what is basically a sophisticated radio receiver.
- After lots of computation, the results are displayed in the form of intensity (i.e. number of absorptions) against frequency. Here is an example, which we shall return to in more detail later:

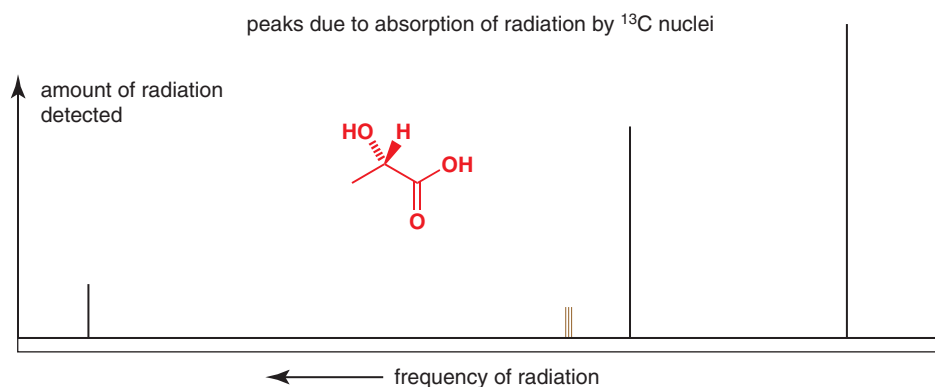

■ 'Resonance' is a good analogy here. If you find a piano and hold down a key to release a single string then give the piano lid a good thwack, you will hear the note you are holding down, and only that note, continuing to sound—it resonates. The thwack provides the piano with sound energy of a range of frequencies, but only sound energy with the right frequency is absorbed and then re-emitted by the vibrating string. There is another chemical use of the word resonance, mentioned in Chapter 7, which is much less appropriate: the two have nothing to do with one another.

Why do chemically distinct nuclei absorb energy at different frequencies?

In the spectrum you see above, each peak represents a different kind of carbon atom: each one absorbs energy (or resonates—hence the term 'nuclear magnetic resonance') at a different frequency. But why should carbon atoms be 'different'? We have told you two factors that affect the energy difference (and therefore the frequency)—the magnetic field strength and what sort of nucleus is being studied. So you might expect all ^{13}C nuclei to resonate at one particular frequency and all protons (^1H) to resonate at one (different) frequency. But they don't.

The variation in frequency for different carbon atoms must mean that the energy jump from 'nucleus-aligned-with' to 'nucleus-aligned-against' the applied magnetic field must be different for each type of carbon atom. The reason is that the ^{13}C nuclei in question experience a magnetic field that is not quite the same as the magnetic field that we apply. Each nucleus is surrounded by electrons, and in a magnetic field these will set up a tiny electric current. This current will set up its own magnetic field (rather like the magnetic field set up by the electrons of an electric current moving through a coil of wire or solenoid), which will oppose the magnetic field that we apply. The electrons are said to **shield** the nucleus from the external magnetic field. If the electron distribution varies from ^{13}C atom to ^{13}C atom, so does the local magnetic field experienced by its nucleus, and so does the corresponding resonating frequency.

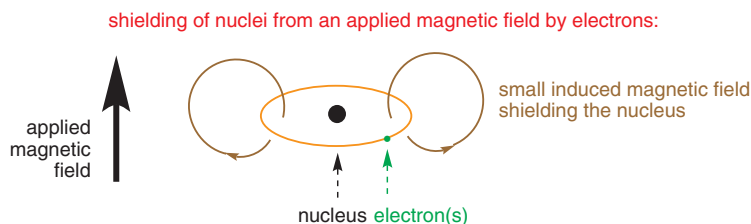

● **Changes in the distribution of electrons around a nucleus affect:**

- the local magnetic field that the nucleus experiences
- the frequency at which the nucleus resonates
- the chemistry of the molecule at that atom

This variation in frequency is known as the **chemical shift**. Its symbol is δ .

As an example, consider ethanol (right). The red carbon attached to the OH group will have a smaller share of the electrons around it compared to the green carbon since the oxygen atom is more electronegative and pulls electrons towards it, away from the red carbon atom.

The magnetic field that the red carbon nucleus feels will therefore be slightly greater than that felt by the green carbon, which has a greater share of the electrons, since the red carbon is less shielded from the applied external magnetic field—in other words it is **deshielded**. Since the carbon attached to the oxygen feels a stronger magnetic field (it is more ‘exposed’ to the field as it has lost some of its electronic shielding) there will be a greater energy difference between the two alignments of its nucleus. The greater the energy difference, the higher the resonant frequency (energy is proportional to frequency). So for ethanol we would expect the red carbon with the OH group attached to resonate at a higher frequency than the green carbon, and indeed this is exactly what the ^{13}C NMR spectrum shows.

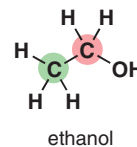

■ We wouldn't usually draw all the Cs and Hs of course, but we have done so here because we want to talk about them.

^{13}C NMR spectrum of ethanol

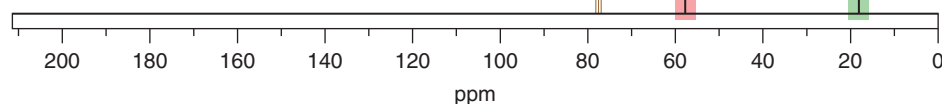

■ The peaks at 77 ppm, shaded brown, are those of the usual solvent (CDCl_3) and can be ignored for the moment. We shall explain them in Chapter 13.

The chemical shift scale

When you look at a real NMR spectrum you will see that the scale does not appear to be in magnetic field units, nor in frequency, nor yet even energy, units, but in ‘parts per million’ (ppm). There is a very good reason for this. The exact frequency at which the nucleus resonates depends on the external applied magnetic field. This means that if the sample is run on a machine with a different magnetic field, it will resonate at a different frequency. It would make life very difficult if we couldn't say exactly where our signal was, so we say how far it is from some reference sample, as a fraction of the operating frequency of the machine. We know that all protons resonate at approximately the same frequency in a given magnetic field and that the *exact* frequency depends on what sort of chemical environment it is in, which in turn depends on its electrons. This approximate frequency is the operating frequency of the machine and simply depends on the strength of the magnet—the stronger the magnet, the larger the operating frequency. The precise value of the operating frequency is simply the frequency at which a standard reference sample resonates. In everyday use, rather than actually referring to the strength of the magnet in tesla, chemists usually just refer to its operating frequency. A 9.4 T NMR machine is referred to as a 400 MHz spectrometer since that is the frequency in this strength field at which the protons in the reference sample resonate; other nuclei, for example ^{13}C , would resonate at a different frequency, but the strength is arbitrarily quoted in terms of the proton operating frequency.

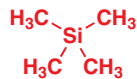

tetramethylsilane, TMS

■ Silicon and oxygen have opposite effects on an adjacent carbon atom: electropositive silicon shields; electronegative oxygen deshields. Electronegativities: Si: 1.8; C: 2.5; O: 3.5.

The reference sample—tetramethylsilane, TMS

The compound we use as a reference sample is usually tetramethylsilane, TMS. This is silane (SiH_4) with each of the hydrogen atoms replaced by methyl groups to give $\text{Si}(\text{CH}_3)_4$. The four carbon atoms attached to silicon are all equivalent and, because silicon is more electropositive than carbon, they are fairly electron-rich (or *shielded*), which means they resonate at a frequency a little less than that of most organic compounds. This is useful because it means our reference sample is not bang in the middle of our spectrum!

The chemical shift, δ , in parts per million (ppm) of a given nucleus in our sample is defined in terms of the resonance frequency as:

$$\delta = \frac{\text{frequency (Hz)} - \text{frequency TMS (Hz)}}{\text{frequency TMS (MHz)}}$$

No matter what the operating frequency (i.e. strength of the magnet) of the NMR machine, the signals in a given sample (e.g. ethanol) will always occur at the same chemical shifts. In ethanol the (red) carbon attached to the OH resonates at 57.8 ppm whilst the (green) carbon of the methyl group resonates at 18.2 ppm. Notice that by definition TMS itself resonates at 0 ppm. The carbon nuclei in most organic compounds resonate at greater chemical shifts, normally between 0 and 200 ppm.

Now, let's return to the sample spectrum you saw on p. 54 and which is reproduced below, and you can see the features we have discussed. This is a 100 MHz spectrum; the horizontal axis is actually frequency but is usually quoted in ppm of the field of the magnet, so each unit is one ppm of 100 MHz, that is, 100 Hz. We can tell immediately from the three peaks at 176.8, 66.0, and 19.9 ppm that there are three different types of carbon atom in the molecule.

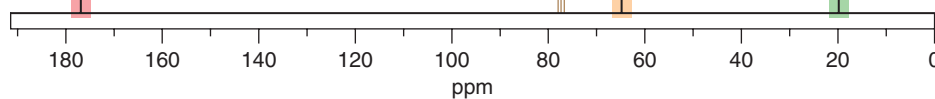
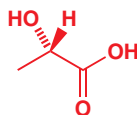
 ^{13}C NMR spectrum of lactic acid

■ Again, ignore the brown solvent peaks at 77 ppm—they are of no interest to us at the moment. You also need not worry about the fact that the signals have different intensities. This is a consequence of the way the spectrum was recorded and in ^{13}C spectra signal intensity is usually of no consequence.

Regions of the ^{13}C NMR spectrum

But we can do better than this: we can also work out what sort of chemical environment the carbon atoms are in. All ^{13}C spectra can be divided into four major regions: saturated carbon atoms (0–50 ppm), saturated carbon atoms next to oxygen (50–100 ppm), unsaturated carbon atoms (100–150 ppm), and unsaturated carbon atoms next to oxygen, i.e. $\text{C}=\text{O}$ groups (150 to about 200 ppm).

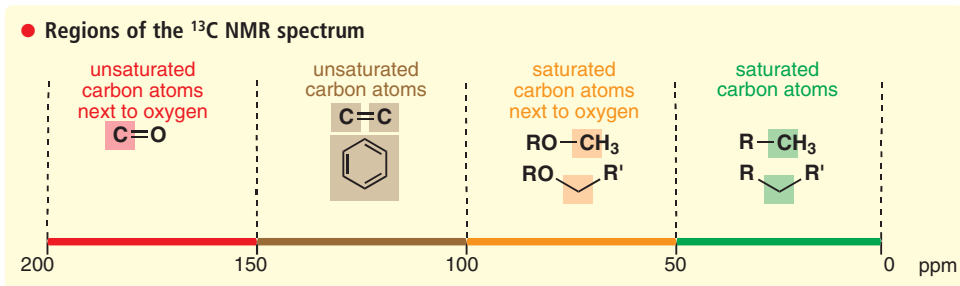

The spectrum you just saw is in fact that of lactic acid (2-hydroxypropanoic acid). When you turned the last page, you made some lactic acid from glucose in the muscles of your arm—it is the breakdown product from glucose when you do anaerobic exercise. Each of lactic acid's carbon atoms gives a peak in a different region of the spectrum.

But hang on one moment, you may say—don't we only see signals for carbon-13 nuclei and not carbon-12, which make up most of the carbon atoms in any normal sample of lactic acid? The answer is yes, and indeed only about 1.1% (the natural abundance of ^{13}C) of the C atoms in any sample are 'visible' by ^{13}C NMR. But since those ^{13}C atoms will be distributed more or less randomly through the sample, this fact does not affect any of the arguments about the appearance of the spectrum. What it does mean, however, is that ^{13}C NMR is not as sensitive as ^1H NMR, for example, where essentially all of the H atoms in the sample will be 'visible'.

Different ways of describing chemical shift

The chemical shift scale runs to the left from zero (where TMS resonates), i.e. backwards from the usual style. Chemical shift values around zero are obviously small but are confusingly called 'high field' because this is the high magnetic field end of the scale. We suggest you say 'large' or 'small' chemical shift and 'large' or 'small' δ , but 'high' or 'low' field to avoid confusion. Alternatively, use 'upfield' for high field (small δ) and 'downfield' for low field (large δ).

One helpful description we have already used is shielding. Each carbon nucleus is surrounded by electrons that shield the nucleus from the applied field. Simple saturated carbon nuclei are the most shielded: they have small chemical shifts (0–50 ppm) and resonate at high field. One electronegative oxygen atom moves the chemical shift downfield into the 50–100 ppm region. The nucleus has become deshielded. Unsaturated carbon atoms experience even less shielding (100–150 ppm) because of the way in which electrons are distributed around the nucleus. If they are also bonded to oxygen (the most common unsaturated carbons bonded to oxygen are those of carbonyl groups), then the nucleus is even more deshielded and moves to the largest chemical shifts around 200 ppm. The next diagram summarizes these different ways of talking about NMR spectra.

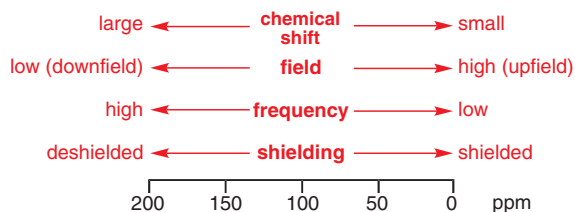

A guided tour of the ^{13}C NMR spectra of some simple molecules

So, on to some real ^{13}C NMR spectra. Our very first compound, hexanedioic acid, has the simple NMR spectrum shown here. The first question is: why only three peaks for six carbon atoms? Because of the symmetry of the molecule, the two carboxylic acids are identical and give one peak at 174.2 ppm. By the same token C2 and C5 are identical, and C3 and C4 are identical. These are all in the saturated region 0–50 ppm but the carbons next to the electron-withdrawing CO_2H group will be more deshielded than the others. So we assign C2/C5 to the peak at 33.2 ppm and C3/C4 to 24.0 ppm.

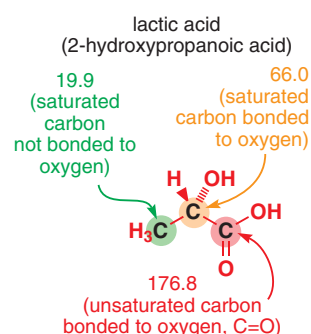
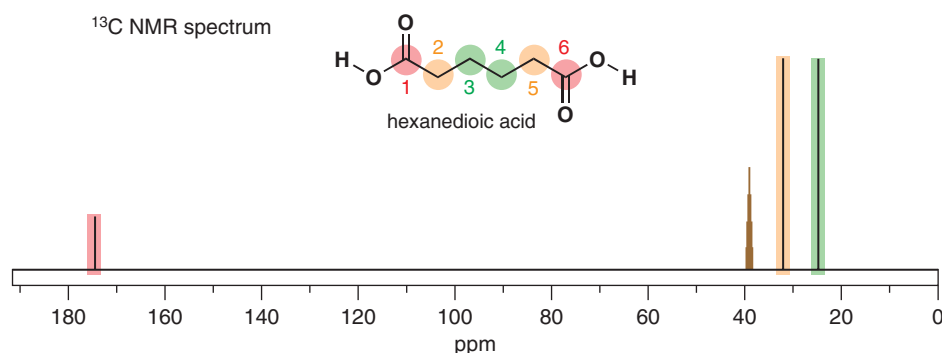

■ In fact, the low abundance of ^{13}C in natural carbon makes ^{13}C spectra simpler than they would otherwise be—we go into this in more detail in Chapter 13.

■ NMR spectra were originally recorded by varying the applied field. They are now recorded by variation of the frequency of the radio waves and that is done by a pulse of radiation. The terms 'high field' and 'low field' are a relic from the days of scanning by field variation.

If you are coming back to this chapter after reading Chapter 4 you might like to know that unsaturated C atoms are more deshielded than saturated ones because a π bond has a *nodal plane*, i.e. a plane with no electron density in at all. Electrons in π bonds are less efficient at shielding the nucleus than electrons in σ bonds.

■ Why isn't this compound called 'hexane-1,6-dioic acid'? Well, carboxylic acids can only be at the end of chains, so no other hexanedioic acids are possible: the 1 and 6 are redundant.

■ This spectrum was run in a different solvent, DMSO (dimethylsulfoxide), hence the brown solvent peaks are in a different region and have a different form. Again, we will deal with these in Chapter 13.

Heptan-2-one is the bee pheromone mentioned on p. 48. It has no symmetry so all its seven carbon atoms are different. The carbonyl group is easy to identify (208.8 ppm) but the rest are more difficult. The two carbon atoms next to the carbonyl group come at lowest field, while C7 is at highest field (13.9 ppm). It is important that there is the right number of signals at about the right chemical shift. If that is so, we are not worried if we cannot assign each frequency to a precise carbon atom (such as atoms 4, 5, and 6, for example). As we said before, don't be concerned with the *intensities* of the peaks.

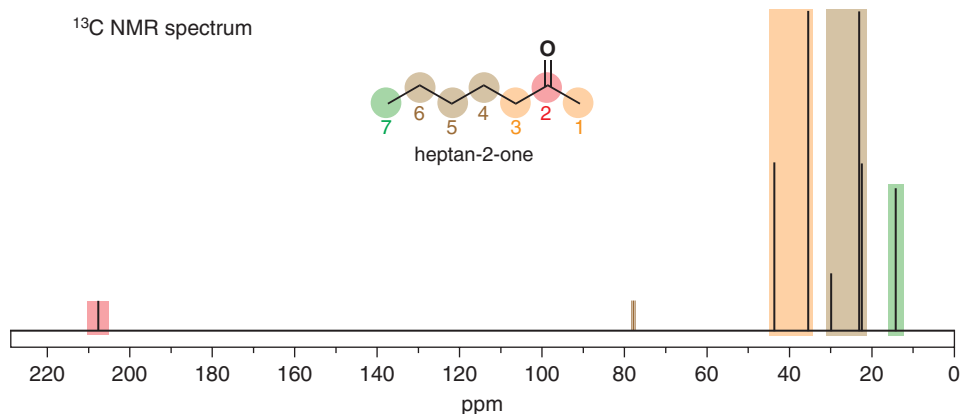

You met BHT on p. 8: its formula is $C_{15}H_{24}O$ and the first surprise in its NMR spectrum is that there are only seven signals for the 15 carbon atoms. There is obviously a lot of symmetry; in fact the molecule has a plane of symmetry vertically as it is drawn here, and the coloured blobs indicate pairs or groups of carbons related to each other by symmetry which therefore give only one signal. The very strong signal at $\delta = 30.4$ ppm belongs to the six identical methyl groups on the *t*-butyl groups (coloured red) and the other two signals in the 0–50 ppm range are the methyl group at C4 and the brown central carbons of the *t*-butyl groups. In the aromatic region there are only four signals as the two halves of the molecule are the same. As with the last example, we are not concerned with exactly which is which—we just check that there are the right number of signals with the right chemical shifts.

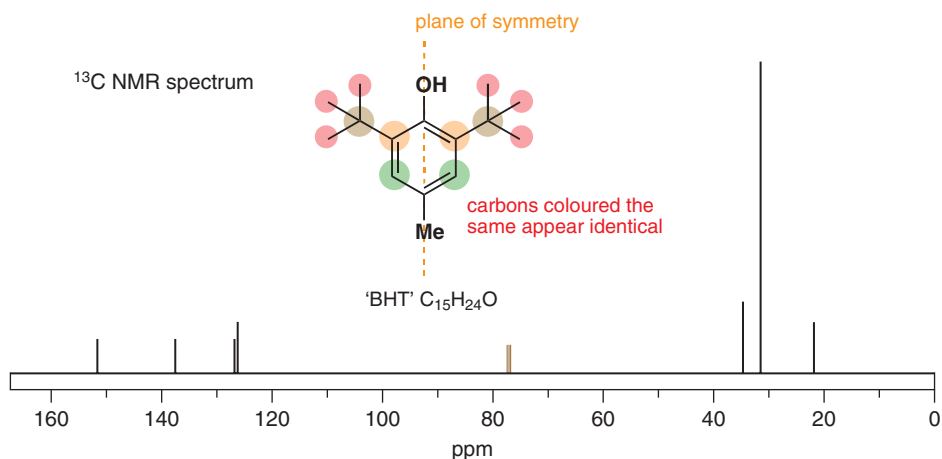

Paracetamol is a familiar painkiller with a simple structure—it too is a phenol but in addition it carries an amide substituent on the benzene ring. Its NMR spectrum contains one saturated carbon atom at 24 ppm (the methyl group of the amide side chain), one carbonyl group at 168 ppm, and four other peaks at 115, 122, 132, and 153 ppm. These are the carbons of the benzene ring. Why four peaks? The two halves of the benzene ring must be the same (only one signal for each pair of carbons coloured red and green), which tells us that the $NHCOCH_3$ group doesn't really lie just to one side as shown here, but rotates rapidly, meaning that *on average* the two sides of the ring are indistinguishable, as in BHT. Why is one of these aromatic peaks in the C=O region at 153 ppm? This must be C4 because it is bonded to oxygen, a reminder that carbonyl groups are not the only unsaturated carbon atoms bonded to oxygen (see the chart on p. 56), although it is not as deshielded as the true C=O group at 168 ppm.

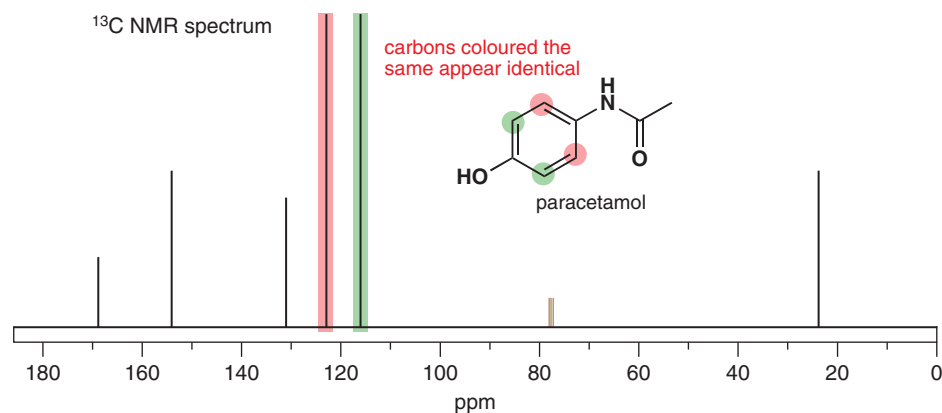

The ^1H NMR spectrum

^1H NMR (or 'proton NMR') spectra are recorded in the same way as ^{13}C NMR spectra: radio waves are used to study the energy level differences of nuclei, but this time they are ^1H and not ^{13}C nuclei. Like ^{13}C , ^1H nuclei have a nuclear spin of $1/2$ and so have two energy levels: they can be aligned either with or against the applied magnetic field. Here, as an example, is the ^1H NMR spectrum of acetic (ethanoic) acid, MeCO_2H , and below it the ^{13}C NMR spectrum.

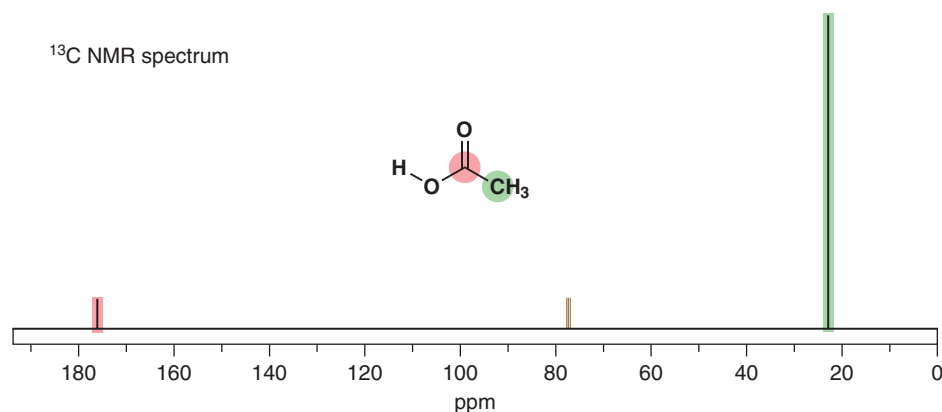
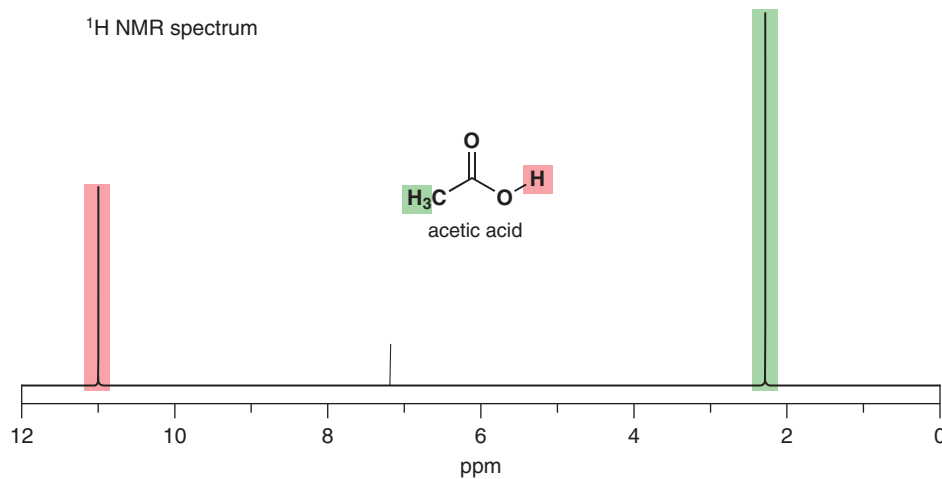

■ The brown peak at 7.25 ppm is a solvent peak and can be ignored.

^1H NMR spectra have many similarities with ^{13}C NMR spectra: the scale runs from right to left and the zero point is given by the same reference compound, though it is the proton resonance of Me_4Si rather than the carbon resonance that defines the zero point. However, as you immediately see in the spectrum above, the scale is much smaller, ranging over only about 10 ppm instead of the 200 ppm needed for carbon. This makes perfect sense: the variation in the chemical

shift is a measure of the shielding of the nucleus by the electrons around it. There is inevitably less change possible in the distribution of two electrons around a hydrogen nucleus than in that of the eight valence electrons around a carbon nucleus. Nonetheless the acetic acid spectrum above shows you that, just as you would expect, the H atom of the carboxylic acid group, directly attached to an oxygen atom, is more deshielded than the H atoms of acetic acid's methyl group.

We can also divide up the ^1H NMR spectrum into regions that parallel the regions of the ^{13}C NMR spectrum. Hydrogen atoms bonded to saturated carbon atoms appear in the right-hand, more shielded (between 5 and 0 ppm) region of the spectrum, while those bonded to unsaturated carbon atoms (alkenes, arenes, or carbonyl groups primarily) appear in the left-hand, less shielded region between 10 and 5 ppm. As with the ^{13}C spectrum, nearby oxygen atoms withdraw electron density and make the signals appear towards the left-hand end of each of these regions.

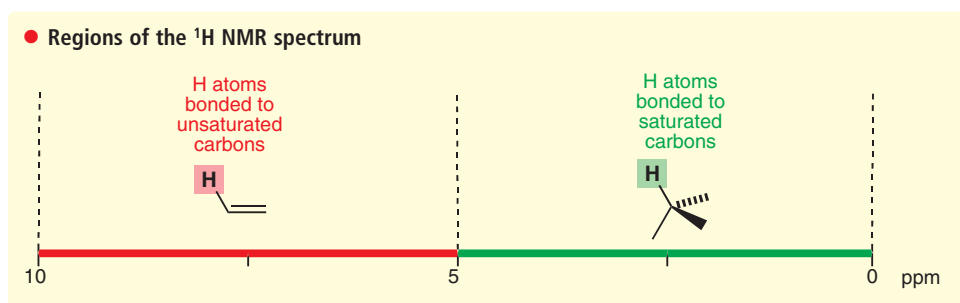

Some examples of ^1H NMR spectra

You can see exactly how ^1H NMR signals fall into these regions in the following collection of spectra. The first two spectra each contain only one peak because every proton in benzene and in cyclohexane is identical. In benzene the peak is at 7.5 ppm, where we expect a proton attached to an unsaturated C atom to lie, while in cyclohexane it is at 1.35 ppm because all the cyclohexane protons are attached to saturated C atoms. Again, to help comparisons, we have also included the ^{13}C spectra of benzene and cyclohexane. For benzene, the signal falls in the unsaturated C region (100–150 ppm), at 129 ppm, while for cyclohexane it is in the saturated C region, at 27 ppm.

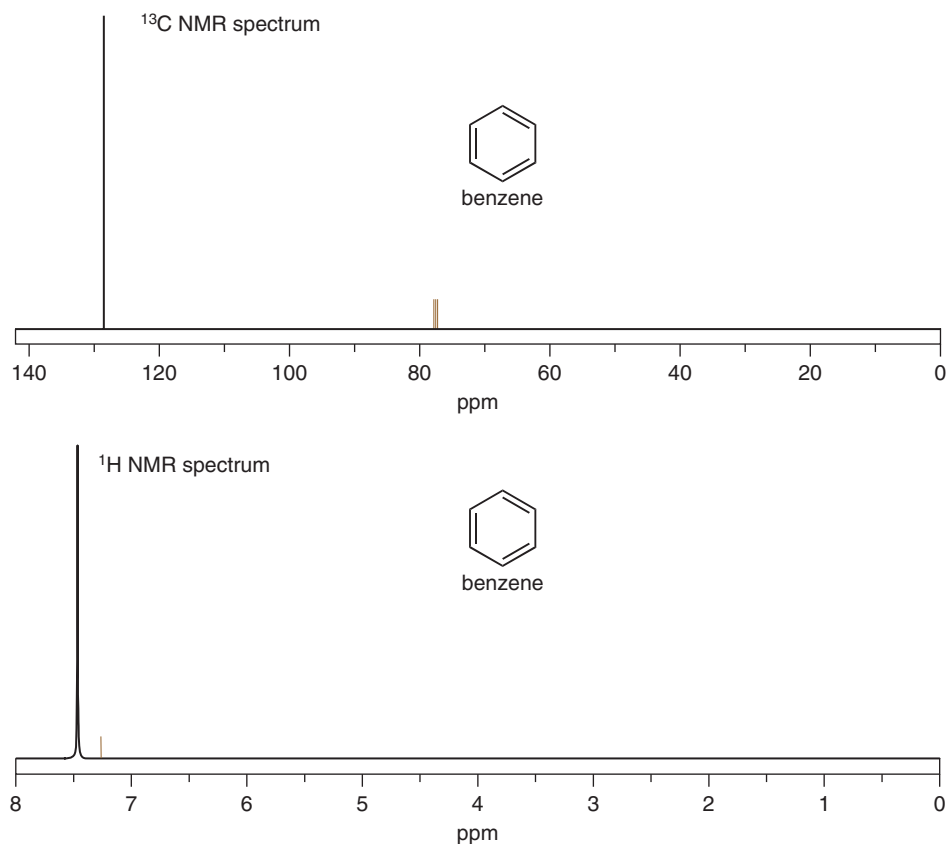

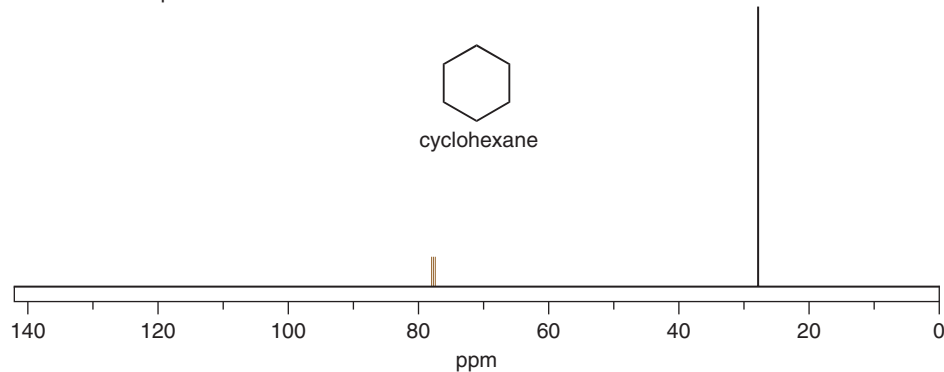
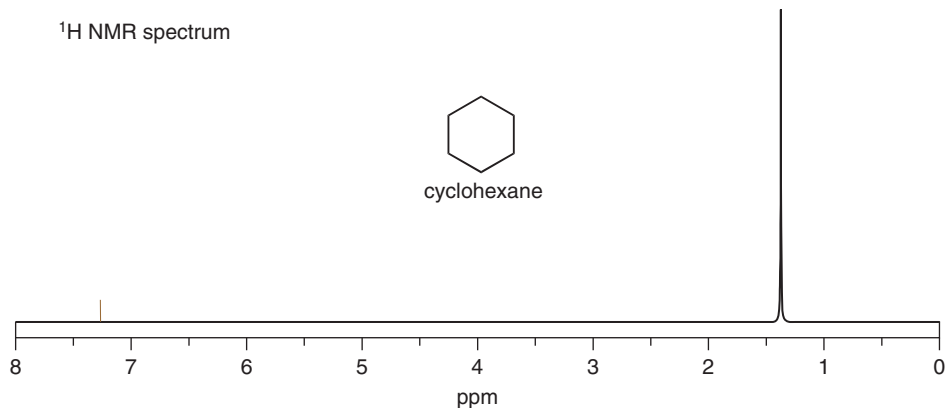
^{13}C NMR spectrum ^1H NMR spectrum

tert-Butyl methyl ether is a solvent and fuel additive whose ^1H spectrum illustrates the effect of a nearby oxygen atom: the large peak at 1.1 ppm comes from the nine H atoms making up three identical methyl groups of the *tert*-butyl part of the molecule, while the three H atoms of the methyl part of the ether are at 3.15 ppm. These three hydrogen atoms are all bonded directly to a C atom, which itself is bonded to O, whose electronegativity attracts their electrons, deshielding the ^1H nuclei and shifting them to larger chemical shift.

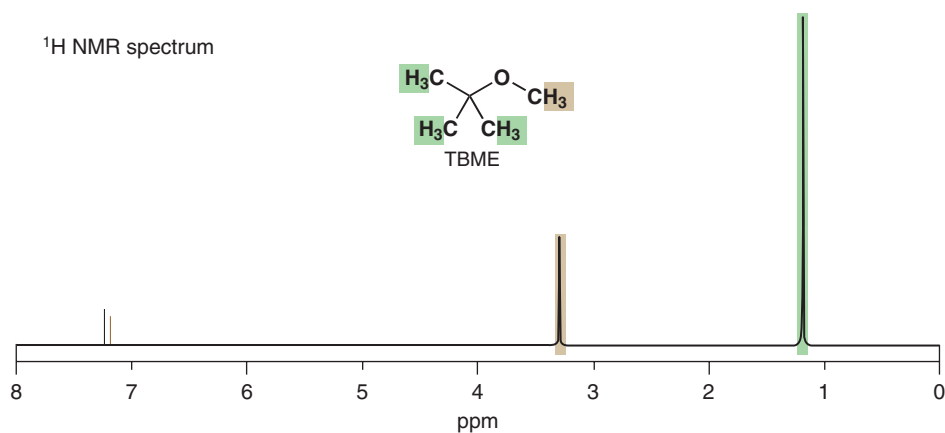
 ^1H NMR spectrum

The plane of symmetry we noted in the ^{13}C NMR spectrum of BHT means that the ^1H NMR spectrum of the related compound Topanol 354 is relatively simple for a compound with 26 H atoms: a large peak and two small peaks between 5 and 0 ppm for the 18 protons of the *tert*-butyl groups and the three protons of each methyl group, and another small peak between 5 and 10 ppm for the two protons attached to the aromatic ring.

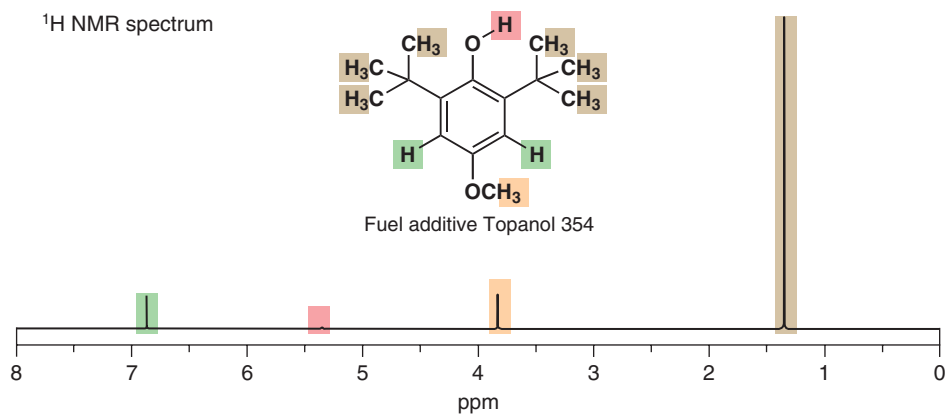

¹H NMR has many more features, which we will leave aside for the moment, and it is no exaggeration to say it is in general more important for the routine determination of structure than all the other methods put together. We will come back to ¹H NMR in more detail in Chapter 13.

NMR is a powerful tool for solving unknown structures

To illustrate the power of NMR, consider these three alcohols of formula C₄H₁₀O, each of which has a quite different ¹³C NMR spectrum. Peaks from the spectra are shown in the table below.

➡ The meanings of *n*-, *iso*-, and *tert*- were covered in Chapter 2 (p. 26).

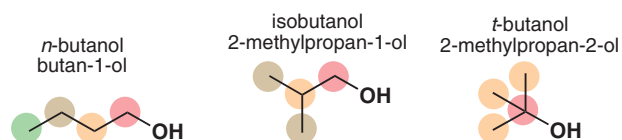

Chemical shift (δ , ppm)

Carbon atom	<i>n</i> -butanol	isobutanol	<i>tert</i> -butanol
	62.9	70.2	69.3
	36.0	32.0	32.7
	20.3	20.4	–
	15.2	–	–

Each alcohol has a saturated carbon atom next to oxygen, all appearing in the region typical of saturated carbon atoms next to oxygen (p. 56). Then there are carbons next door but one to oxygen: they are back in the 0–50 ppm region but at its low field end—about 30–35 ppm—because they are still deshielded by the nearby oxygen atom. Two of the alcohols have carbon(s) one further away still at yet smaller chemical shift (further upfield, more shielded) at about 20 ppm, but only the *n*-butanol has a more remote carbon still at 15.2. The *number* and the *chemical shift* of the signals identify the molecules very clearly.

A common situation chemists find themselves in is that they have some idea about a molecular formula—from high-resolution mass spectrometry, for example—and need to match a structure to NMR data. Here's an example: the formula C₃H₆O is represented by seven reasonable structures, as shown in the margin. The three ¹³C NMR spectra below represent three of these compounds. The challenge is to identify which three. We will give you some clues, and then we suggest you try to work out the answer for yourself before turning the page.

Simple symmetry can distinguish structures A, C, and E from the rest as these three have only two types of carbon atom. The two carbonyl compounds, D and E, will have one peak in the 150–200 ppm region but D has two different saturated carbon atoms while E has only one. The two alkenes, F and G, both have two unsaturated carbon atoms (100–200 ppm) but in ether G one of them is joined to oxygen—you would expect it therefore to be deshielded and to appear between 150 and 200 ppm.

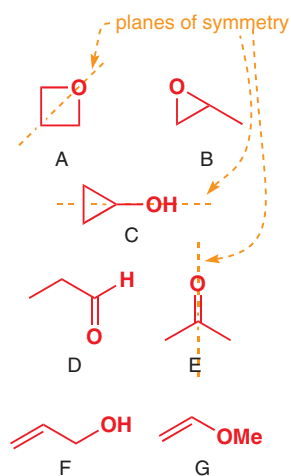

The three saturated compounds (A, B, and C) present the greatest problem. The epoxide, B, has two different carbon atoms next to oxygen (50–100 ppm) and one normal saturated carbon atom (0–50 ppm). The remaining two both have one signal in the 0–50 ppm region and one in the 50–100 ppm region, and only the more powerful techniques of ^1H NMR and, to a certain extent, infrared spectroscopy (which we will move on to shortly) will distinguish them reliably.

Here are NMR spectra of three of these molecules. Before reading further see if you can assign them to the structures on the previous page. Try also to suggest which signals belong to which carbon atoms.

■ An epoxide is a three-membered cyclic ether, such as B.

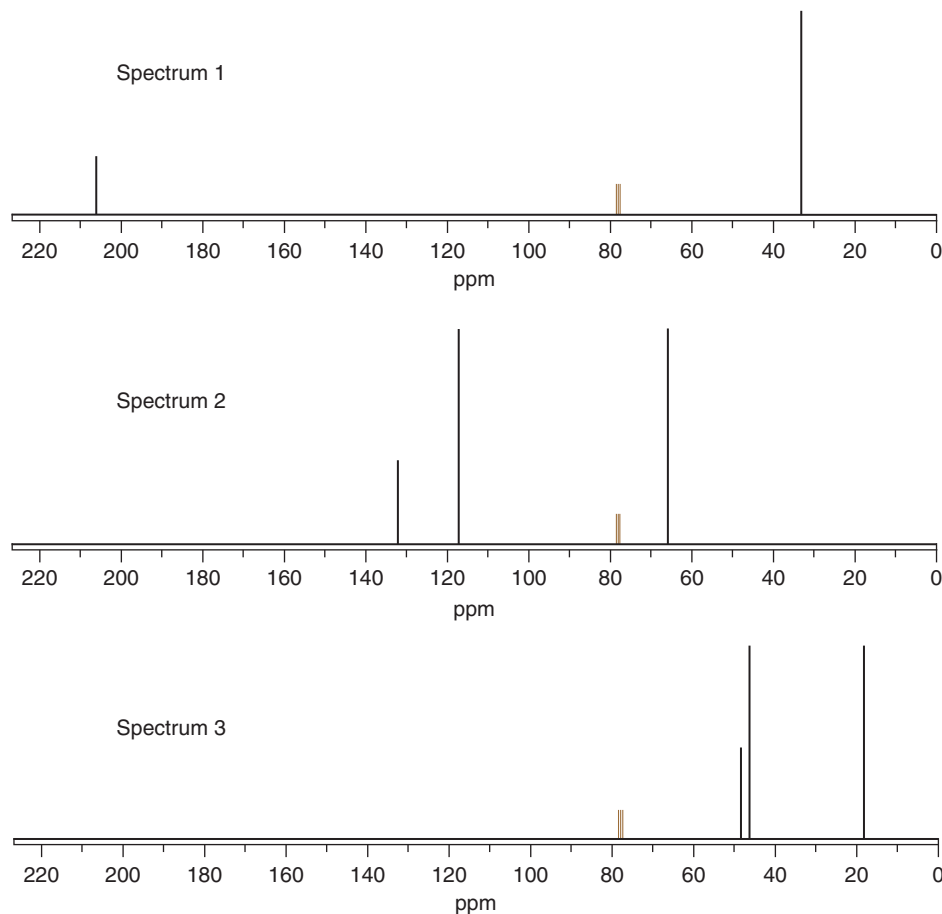

We hope these didn't give you too much trouble. The only carbonyl compound with two identical carbons is acetone (E) so spectrum 1 must be that one. Notice the very low field signal (206.6 ppm) typical of a simple ketone $\text{C}=\text{O}$ carbon atom. Spectrum 2 has two unsaturated carbons and a saturated carbon next to oxygen so it must be F or G. In fact it has to be F as both unsaturated carbons are similar (137 and 116 ppm) and neither is next to oxygen (>150 ppm). This leaves spectrum 3, which appears to have no carbon atoms next to oxygen as all chemical shifts are less than 50 ppm. No compound fits that description and the two signals at 48.0 and 48.2 ppm are suspiciously close to the arbitrary 50 ppm borderline. They are, of course, both next to oxygen and this is compound B.

Infrared spectra

Functional groups are identified by infrared spectra

^{13}C and ^1H NMR spectra tell us a lot about the hydrocarbon skeleton of a molecule, and mass spectroscopy weighs the molecule as a whole. But none of these techniques reveal much about functional groups. Some functional groups, for example $\text{C}=\text{O}$ or $\text{C}=\text{C}$, can be seen in the ^{13}C NMR spectrum because they contain carbon atoms, but many, such as ethers or nitro groups, cannot be seen at all by NMR—they show their presence only by the way they affect the chemical shifts of nearby H or C atoms.

bond vibration in the infrared

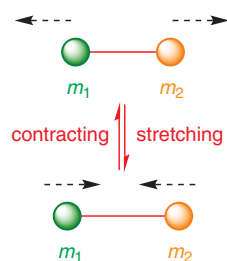

Infrared (IR) spectroscopy, however, provides a direct way of observing these functional groups because it detects the stretching and bending of bonds rather than any property of the atoms themselves. It is particularly good at detecting the stretching of unsymmetrical bonds of the kind found in functional groups such as OH, C=O, NH₂, and NO₂, and for this reason IR spectroscopy complements NMR beautifully as a method for structural analysis.

NMR requires electromagnetic waves in the radio-wave region of the spectrum to make nuclei flip from one state to another. The amount of energy needed for stretching and bending individual bonds, while still very small, is rather greater, and therefore corresponds to much shorter wavelengths. These wavelengths lie in the infrared, just to the long wavelength side of visible light (wavelengths between 10 and 100 nm). When the carbon skeleton of a molecule vibrates, all the bonds stretch and relax in combination and by and large these absorptions are unhelpful. However, some bonds stretch essentially independently of the rest of the molecule, and we can use these to identify functional groups. This occurs if the bond is either:

- much stronger or weaker than others nearby, or
- between atoms that are much heavier or lighter than their neighbours

Indeed, the relationship between the frequency of the bond vibration, the mass of the atoms, and the strength of the bond is essentially the same as Hooke's law for a simple harmonic oscillator. Hooke's law shows that the frequency of the vibration ν is proportional to the square root of a force constant f —more or less the bond strength—and inversely proportional to the square root of a reduced mass μ , that is, the product of the masses of the two atoms forming the bond divided by their sum:

$$\mu = \frac{m_1 m_2}{m_1 + m_2}$$

The precise maths is less important to us as chemists than the simple result.

Hooke's law describes the movement of two masses attached to a spring. You may have met it if you have studied physics. You need not be concerned here with its derivation, just the result. It takes the following form:

$$\nu = \frac{1}{2\pi c} \sqrt{\frac{f}{\mu}}$$

where ν is the frequency, f is the force constant and μ is the reduced mass. c is a constant needed to make the units work.

• **Stronger bonds vibrate faster and so do lighter atoms.**

Infrared spectra are simple absorption spectra. The sample is dissolved in a solvent (or sometimes deposited on the surface of an inert NaCl plate) and exposed to infrared radiation. The wavelength scanned across the spectrum and the amount of infrared energy able to pass through the sample are plotted against the wavelength of the radiation. Just to make the numbers work out nicely, IR spectra don't usually indicate the wavelength but instead a value known as the 'wavenumber', in cm⁻¹, which is simply the number of wavelengths in one centimetre. For a typical bond this will fall between 4000 (short wavelengths, i.e. high frequency) and 500 (long wavelengths, i.e. low frequency). Strong bonds, and light atoms, vibrate fast, so you expect to see these bonds at the high wavenumber end of the spectrum, always plotted at the left-hand end.

To illustrate what we mean, here are some typical values for the IR frequencies of a selection of bonds grouped in two ways. Firstly, a series of bonds to increasingly heavy atoms (D, deuterium, has twice the mass of H, and Cl has about twice the mass of O) and secondly a series of bonds of increasing strength.

Values chiefly affected by mass of atoms (lighter atom, higher frequency)			
C—H	C—D	C—O	C—Cl
3000 cm ⁻¹	2200 cm ⁻¹	1100 cm ⁻¹	700 cm ⁻¹
Values chiefly affected by bond strength (stronger bond, higher frequency)			
C≡O	C=O	C—O	
2143 cm ⁻¹	1715 cm ⁻¹	1100 cm ⁻¹	

Here's what a typical IR spectrum actually looks like: notice that the wavenumber scale runs from high to low but also that absorption maxima are shown upside down (IR spectra plot 'transmission')—you might say that IR spectra are upside down and back to front. If you look carefully you will also see that the scale changes in the middle to give more space to the more detailed right-hand half of the spectrum.

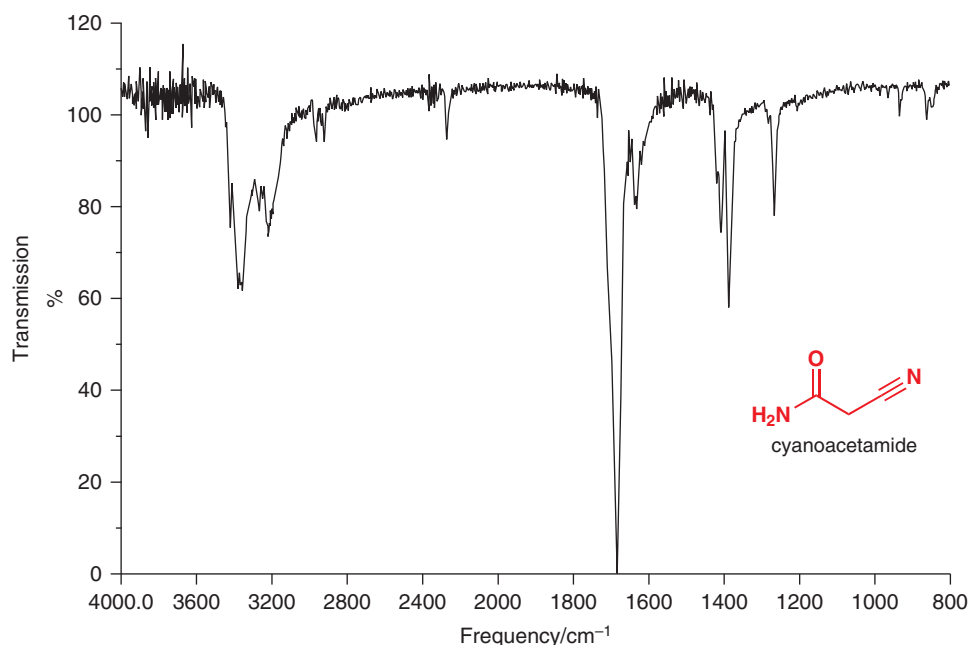

This is the spectrum of cyanoacetamide, the compound shown on the right. The overall shape of the spectrum is characteristic of this compound, but as chemists we need to be able to *interpret* the spectrum, and we can do this by dividing it up into regions, just as we did with the NMR spectra.

There are four important regions of the infrared spectrum

The first region, from 4000 to 2500 cm^{-1} is the region for C–H, N–H, and O–H bond stretching. Most of the atoms in an organic molecule (C, N, O, for example) are about the same weight (12, 14, 16...). Hydrogen is an order of magnitude lighter than any of these and so it dominates the stretching frequency by the large effect it has on the reduced mass, so any bond to H comes right at the left-hand end of the spectrum.

Even the strongest bonds between non-H atoms—triple bonds such as $\text{C}\equiv\text{C}$ or $\text{C}\equiv\text{N}$ —absorb at slightly lower frequencies than bonds to hydrogen: these are in the next region, the **triple bond region from about 2500 to 2000 cm^{-1}** . This and the other two regions of the spectrum follow in logical order of bond strength as the reduced masses are all about the same: $\text{C}=\text{C}$ and $\text{C}=\text{O}$ **double bonds appear about 2000 – 1500 cm^{-1}** and at the right-hand end of the spectrum come **single bonds, below 1500 cm^{-1}** . These regions are summarized in this chart, which you should memorize.

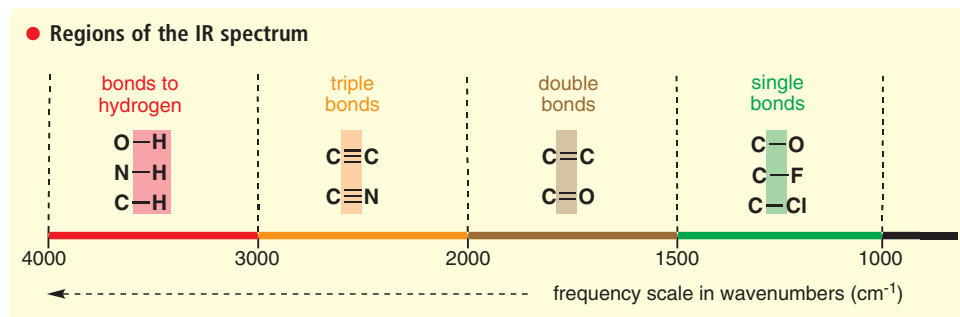

Reduced mass and atomic mass

We introduced the idea of reduced mass on p. 64. To illustrate the effect of H on reduced mass, consider this: the reduced mass of a C–C bond is $(12 \times 12)/(12 + 12)$, i.e. $144/24 = 6.0$. If we change one of these atoms for H, the reduced mass changes to $(12 \times 1)/(12 + 1)$, i.e. $12/13 = 0.92$, but if we change it instead for F, the reduced mass changes to $(12 \times 19)/(12 + 19)$, i.e. $228/31 = 7.35$. There is a small change when we increase the mass to 19 (F), but an enormous change when we decrease it to 1 (H).

■ Absorptions in the IR are frequently referred to as 'peaks'—on the spectrum of course they are 'troughs'!

Looking back at the spectrum of cyanoacetamide on p. 65, we see peaks in the X–H region at about 3300 and 2950 cm^{-1} , which are the N–H and C–H stretches of the NH_2 and CH_2 groups. The one rather weak peak in the triple bond region (2270 cm^{-1}) is the C≡N group and the strong peak at about 1670 cm^{-1} belongs to the C=O group. We shall explain soon why some IR peaks are stronger than others. The rest of the spectrum is in the single bond region. This region is not normally interpreted in detail but is characteristic of the compound as a whole rather in the way that a fingerprint is characteristic of an individual human being—similarly, it cannot be 'interpreted'. It is indeed called the fingerprint region. The useful information from this spectrum is the presence of the C≡N and C=O groups and the exact position of the C=O absorption.

The X–H region (4000–3000 cm^{-1}) distinguishes C–H, N–H, and O–H bonds

The reduced masses of the C–H, N–H, and O–H combinations are all about the same. Any difference between the positions of the IR bands of these bonds must then be due to bond strength. In practice, C–H stretches occur at around 3000 cm^{-1} (although they are of little use in identifying compounds, it's a rare organic compound that has *no* C–H bonds), N–H stretches occur at about 3300 cm^{-1} , and O–H stretches higher still at around 3500 cm^{-1} . We can immediately deduce that the O–H bond is stronger than N–H, which is stronger than C–H. IR is a good way to measure such bond strengths.

■ This may surprise you: you may be used to thinking of O–H as more reactive than CH. This is, of course, true but, as you will see in Chapter 5, factors other than bond strength control reactivity. Bond strengths will be much more important when we discuss radical reactions in Chapters 35 and 39.

IR bands for bonds to hydrogen

Bond	Reduced mass, μ	IR frequency, cm^{-1}	Typical bond strength, kJ mol^{-1}
C–H	$12/13 = 0.92$	2900–3200	CH_4 : 440
N–H	$14/15 = 0.93$	3300–3400	NH_3 : 450
O–H	$16/17 = 0.94$	3500–3600 ^a	H_2O : 500

^aWhen not hydrogen-bonded: see below.

The *form* of the absorption bands resulting from X–H IR stretches are very different in these four compounds. Have a look at the shaded portions of the following spectra:

Spectrum 1

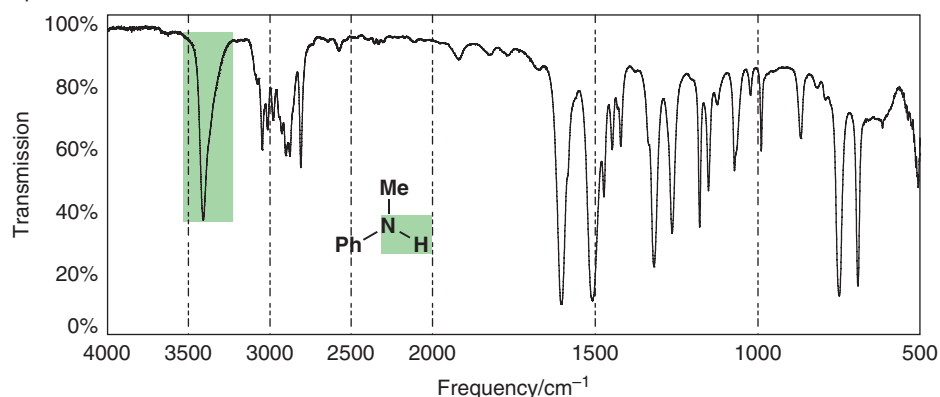

Spectrum 2

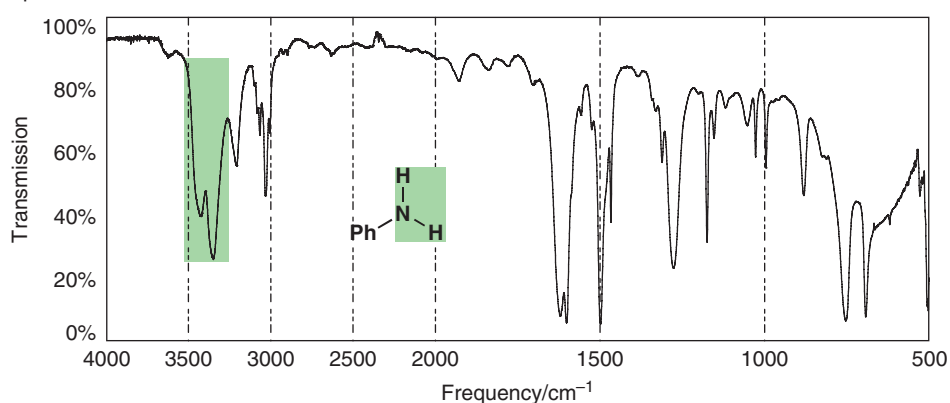

Spectrum 3

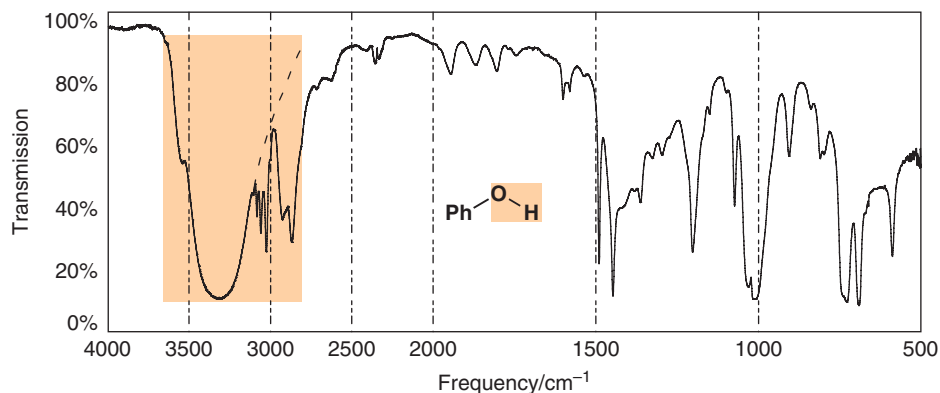

Spectrum 4

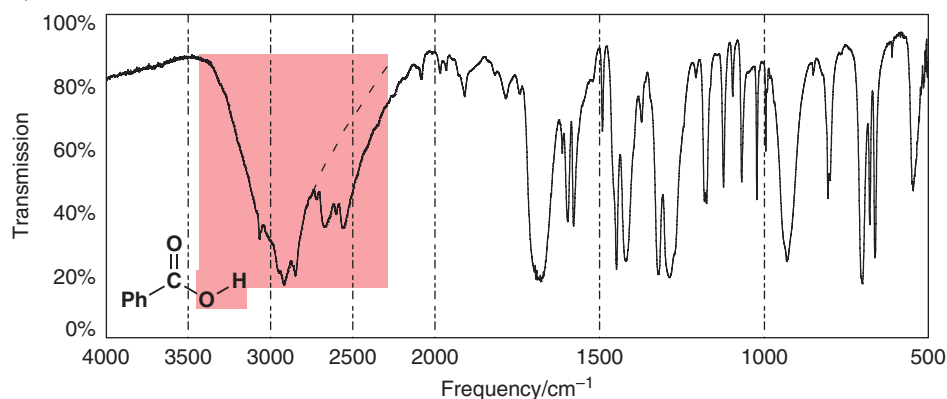

The IR peak of an NH group looks different (spectrum 1) from that of an NH₂ group (spectrum 2). A bond gives an independent vibration only if both bond strength and reduced mass are different from those of neighbouring bonds. In the case of an isolated N–H group, this is likely to be true and we usually get a sharp peak at about 3300 cm⁻¹, whether the NH group is part of a simple amine (R₂NH) or an amide (RCONHR). The NH₂ group is also independent of the rest of the molecule, but the two NH bonds inside the NH₂ group have identical force constants and reduced masses, and so vibrate as a single unit. Two equally strong bands appear: one for the two N–H bonds vibrating in phase (symmetric) and one for the two N–H bonds vibrating in opposition (antisymmetric). The antisymmetric vibration requires more energy and is at slightly higher frequency.

The O–H bands occur at higher frequency, sometimes as a sharp absorption at about 3600 cm⁻¹. More often, as in spectra 3 and 4, you will see a broad absorption at anywhere from 3500 to 2900 cm⁻¹. This is because OH groups form strong hydrogen bonds that vary in length and strength. A sharp absorption at 3600 cm⁻¹ indicates a non-hydrogen-bonded OH group; the lower the absorption frequency the stronger the H bond.

Alcohols form hydrogen bonds between the hydroxyl oxygen of one molecule and the hydroxyl hydrogen of another. These bonds are variable in length (although they are usually rather longer than normal covalent O–H bonds) and they slightly weaken the true covalent O–H bonds by varying amounts. When a bond varies in length and strength it will have a range of stretching frequencies distributed about a mean value. Alcohols, including the phenol shown in spectrum 3, typically give a rounded absorption at about 3300 cm⁻¹ (contrast the sharp shape of the N–H stretch in the same region you see in the spectra above). Carboxylic acids (RCO₂H) form hydrogen-bonded dimers with two strong H bonds between the carbonyl oxygen atom of one molecule and the acidic hydrogen of the other. These also vary considerably in length and strength, and usually give the very broad V-shaped absorbance you see in the benzoic acid spectrum 4.

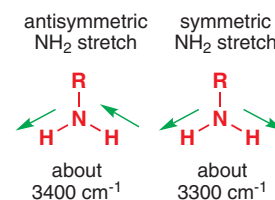

Interactive vibrations of methylamine

Hydrogen bonds are weak bonds formed from electron-rich atoms such as O or N to hydrogen atoms also attached by 'normal' bonds to the same sorts of atoms. In this diagram of a hydrogen bond between two molecules of water, the solid line represents the 'normal' bond and the green dotted line the longer hydrogen bond. The hydrogen atom is about a third of the way along the distance between the two oxygen atoms.

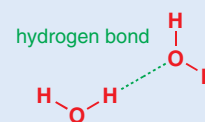

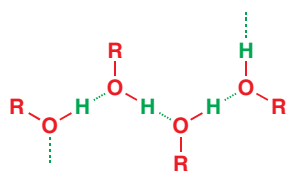

hydrogen bonding in an alcohol

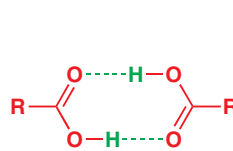

the hydrogen-bonded dimer of a carboxylic acid

The spectra of paracetamol and BHT (which you met on pp. 58–59) illustrate the effect of hydrogen bonding on peak shape. Paracetamol has a typical sharp peak at 3330 cm^{-1} for the N–H stretch and then a rounded absorption for the hydrogen-bonded O–H stretch from 3300 down to 3000 cm^{-1} in the gap between the N–H and C–H stretches. By contrast, BHT has a sharp absorption at 3600 cm^{-1} as the two large *t*-butyl groups prevent the typical hydrogen bond from forming.

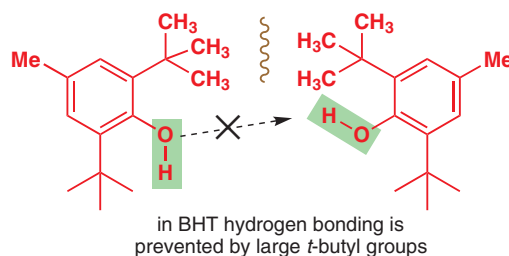
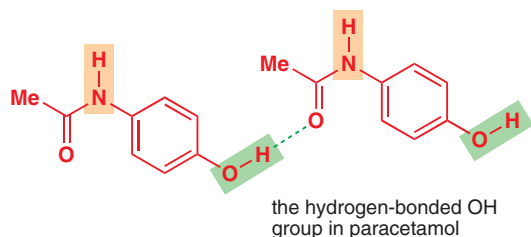
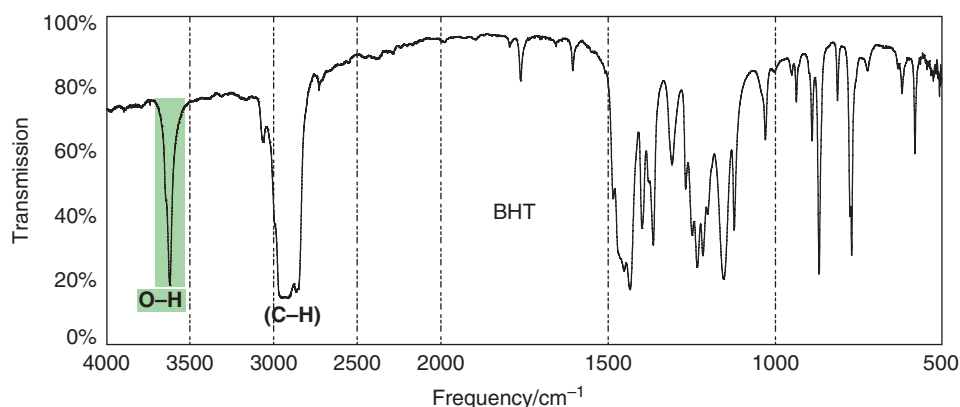
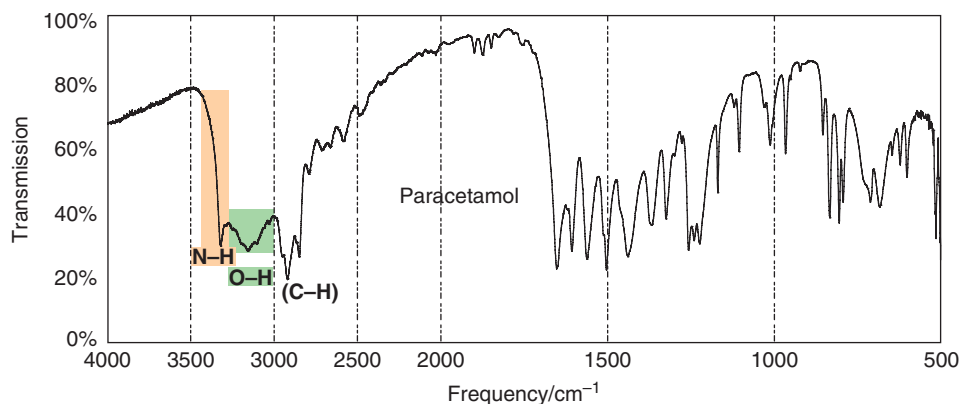

You may be confused the first time you see the IR spectrum of a terminal alkyne, $\text{R}-\text{C}\equiv\text{C}-\text{H}$, because you will see a strongish sharp peak at around 3300 cm^{-1} that looks just like an N–H stretch—the spectrum below (of methyl propynoate, also known as methyl propiolate) illustrates this. The displacement of this peak from the usual C–H stretch at about 3000 cm^{-1}

cannot be due to a change in the reduced mass and must be due to a marked increase in bond strength. The alkyne C–H bond is shorter and stronger than alkane C–H bonds.

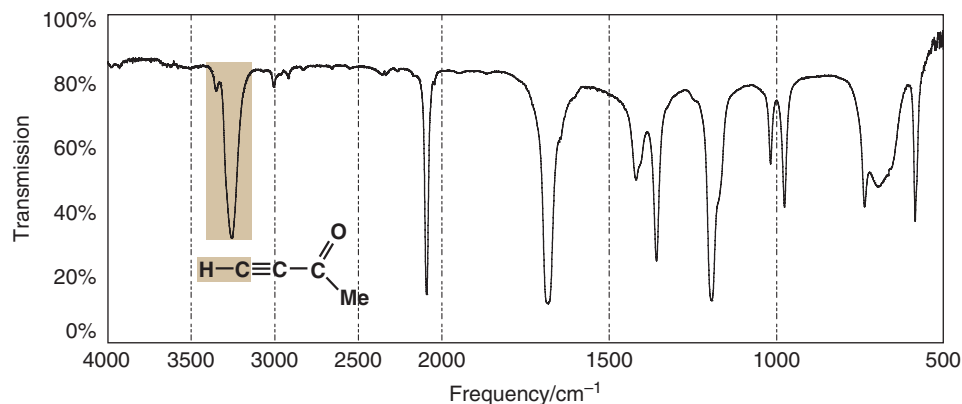

■ In Chapter 4 you will see that carbon uses an sp^3 orbital to make a C–H bond in a saturated structure but has to use an sp orbital for a terminal alkyne C–H. This orbital has one-half s character instead of one-quarter s character. The electrons in an s orbital are held closer to the carbon's nucleus than in a p orbital, so the sp orbital makes for a shorter, stronger C–H bond.

● Typical peak shapes and frequencies for X–H bonds in the region 4000–3000 cm^{-1} .

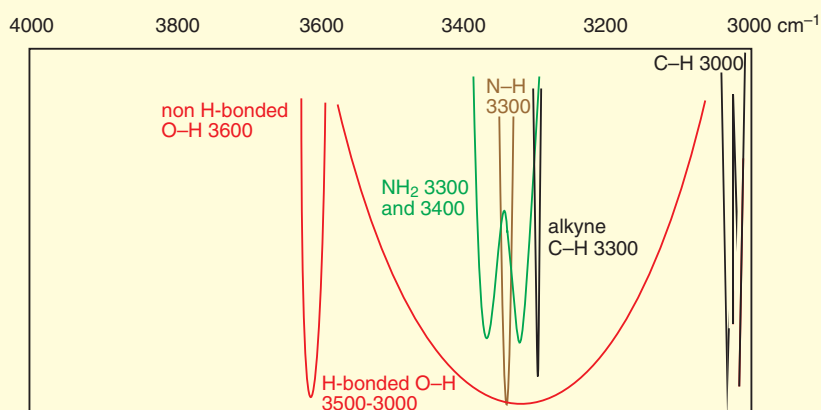

The triple bond region (3000–2000 cm^{-1})

This region is often empty, meaning that when you do see a peak between 2000 and 2500 you can be absolutely certain that the compound is an alkyne (usually at around 2100) or a nitrile (at 2250 cm^{-1}). There are examples above and on p. 65.

● The only two peaks in the triple bond region

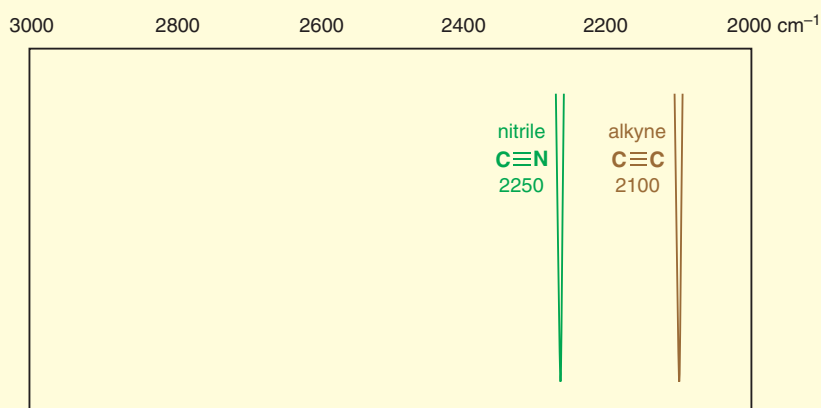

The double bond region is the most important in IR spectra

The most important absorptions in the double bond region are those of the carbonyl (C=O), alkene or arene (C=C), and nitro (NO₂), groups. All give rise to sharp bands, C=O gives one strong (i.e. intense) band anywhere between 1900 and 1500 cm⁻¹; alkene C=C gives one weak band at about 1640 cm⁻¹, and NO₂ gives two strong (intense) bands in the mid-1500s and mid-1300s cm⁻¹. Arenes usually give two or three bands in the region 1600–1500 cm⁻¹. We can illustrate several of these features in the spectrum shown below, which is that of 4-nitrocinnamaldehyde, shown in the margin.

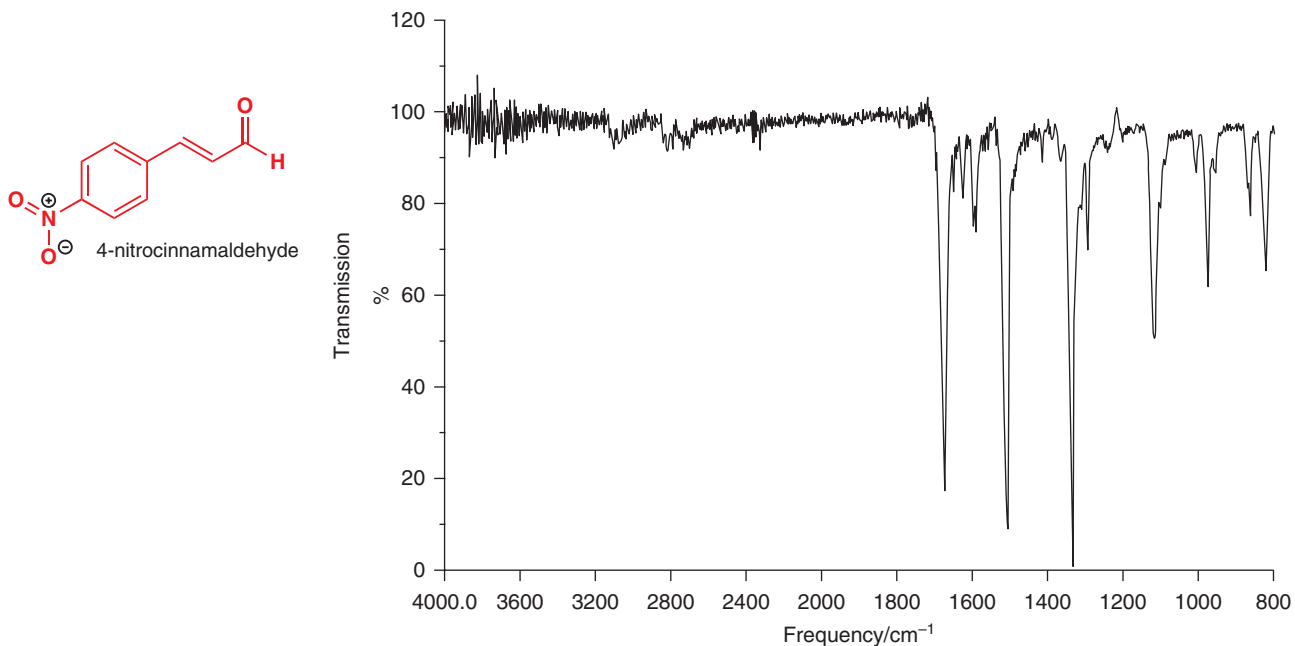

► Delocalization is covered in Chapter 7; for the moment, just accept that both NO bonds are the same.

Why the nitro group gives two bands is easily understood. Just as with OH and NH₂, it is a matter of how many identical bonds are present in the same functional group. Carbonyl and alkene clearly have one double bond each. The nitro group at first sight appears to contain two different groups, N⁺–O⁻ and N=O, but delocalization means they are identical and we see absorption for symmetric and antisymmetric stretching vibrations. As with NH₂, more energy is associated with the antisymmetric vibration and it occurs at higher frequency (>1500 cm⁻¹).

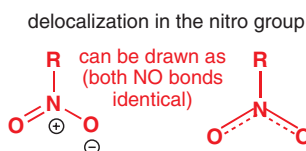

antisymmetric NO₂ stretch (~1550)

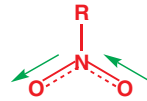

symmetric NO₂ stretch (~1350)

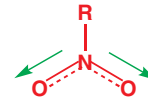

Arenes, being rings, have a much more complex pattern of vibration that cannot be analysed simply. However, it's worth noting that arene C=C bonds come at lower frequency (<1600 cm⁻¹) than alkene C=C bonds (>1600 cm⁻¹). Why? Well the individual C–C bonds in benzene are of course not full C=C double bonds—all six bonds are the same, and have the averaged character of one-and-a-half bonds each. Not surprisingly, the absorptions of these bonds fall right on the boundary between the single and double bond regions.

You've already seen the IR spectra of the three carbonyl compounds below in this chapter. It's easy to identify the C=O peak in each spectrum—C=O peaks are always intense (you will see why in a minute) and come somewhere near 1700 cm⁻¹.

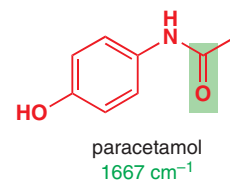
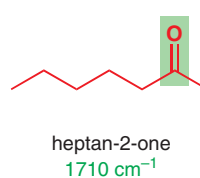
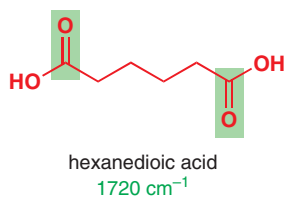

Why the positions of the peaks vary, and what we can make of this information, will be discussed in Chapter 18.

● Important absorptions in the double bond region

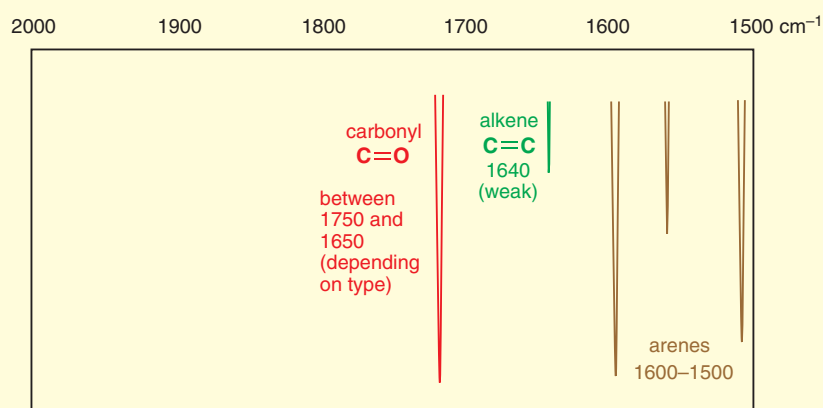

The strength of an IR absorption depends on dipole moment

If you look back at the X–H regions (3000–4000 cm^{-1}) of the four spectra on pp. 66–67, you'll notice something that at first sight seems odd. The N–H and O–H absorptions are stronger than the C–H absorptions at 3000 cm^{-1} , despite there being more C–H bonds in these molecules than O–H or N–H bonds. The reason for this is that the strength of an IR absorption varies with the change of *dipole moment* (see the box below for a definition) when the bond is stretched. If the bond is perfectly symmetrical, there is no change in dipole moment and there is no IR absorption. Obviously, the C=C bond is less polar than either C=O or N=O and its absorption is less intense in the IR. Indeed it may be absent altogether in a symmetrical alkene. By contrast the carbonyl group is very polarized, with oxygen attracting the electrons away from carbon, and stretching it causes a large change in dipole moment. C=O stretches are usually the strongest peaks in the IR spectrum. O–H and N–H stretches are stronger than C–H stretches because C–H bonds are only weakly polarized.

■ Contrast the term 'strength' applied to *absorption* and to *bonds*. A stronger absorption is a *more intense* absorption. A strong *bond* on the other hand has a *higher frequency* of absorption (other things being equal).

Dipole moments

Dipole moment depends on the variation in distribution of electrons along the bond and also its length, which is why stretching a bond can change its dipole moment. For bonds between unlike atoms, the larger the difference in electronegativity, the greater the dipole moment and the more it changes when stretched. For identical atoms (C=C, for example) the dipole moment, and its capacity to change with stretching, is much smaller. Stretching frequencies for symmetrical molecules can be measured using an alternative method known as Raman spectroscopy. This is an IR-based technique using scattered light that relies on the polarizability of bonds. Raman spectra are outside the scope of this book.

This is a good point to remind you of the various deductions we have made so far about IR spectra.

● Absorptions in IR spectra

Position of band depends on:	reduced mass of atoms bond strength	light atoms give high frequency strong bonds give high frequency
Strength (intensity) of band depends on:	change in dipole moment	large dipole moment gives strong absorption
Width of band depends on:	hydrogen bonding	strong H bond gives broad peak

The single bond region is used as a molecular fingerprint

The region below 1500 cm^{-1} is where the single bond vibrations occur. Here our hope that individual bonds may vibrate independently of the rest of the molecule is usually doomed to disappointment. The atoms C, N, and O all have about the same atomic weight and C–C, C–N, and C–O single bonds all have about the same strength.

Pair of atoms	Reduced mass	Bond strength
C–C	6.0	350 kJ mol^{-1}
C–N	6.5	305 kJ mol^{-1}
C–O	6.9	360 kJ mol^{-1}

■ A matching fingerprint is used to link a suspect to a crime, but you can't *interpret* a fingerprint to deduce the height, weight, or eye-colour of a criminal. Likewise with the fingerprint region: a matching fingerprint confirms that two compounds are identical, but without a 'suspect' you have to rely on the rest of the spectrum, above 1500 cm^{-1} , for analysis.

In addition, C–C bonds are often joined to other C–C bonds with virtually identical strength and reduced mass, and they have essentially no dipole moments. The only one of these single bonds of any value is C–O, which is polar enough to show up as a strong absorption at about 1100 cm^{-1} . Some other single bonds, such as C–Cl (weak and with a large reduced mass, so appearing at low frequency), are quite useful at about 700 cm^{-1} . Otherwise the single bond region is usually crowded with hundreds of absorptions from vibrations of all kinds used as a 'fingerprint' characteristic of the molecule but not really open to interpretation.

Among those hundreds of peaks in the fingerprint region there are some of a quite different kind. Stretching is not the only bond movement that leads to IR absorption. Bending of bonds, particularly C–H and N–H bonds, also leads to quite strong peaks. These are called *deformations*. Bending a bond is easier than stretching it (which is easier, stretching or bending an iron bar?). Consequently, bending absorptions need less energy and come at lower frequencies than stretching absorptions for the same bonds. These bands may not often be useful in identifying molecules, but you will notice them as they are often strong (they are usually stronger than C=C stretches, for example) and may wonder what they are.

Deformation frequencies

Group	Frequency, cm^{-1}
CH ₂	1440–1470
CH ₃	~1380
NH ₂	1550–1650

Mass spectra, NMR, and IR combined make quick identification possible

If these methods are each as powerful as we have seen on their own, how much more effective they must be together! We shall finish this chapter with the identification of some simple unknown compounds using all three methods. The first is an industrial emulsifier used to blend solids and liquids into smooth pastes. Its electrospray mass spectrum shows it has $M + H$ with a mass of 90, so an odd molecular weight (89) suggests one nitrogen atom. High-resolution mass spectrometry reveals that the formula is C₄H₁₁NO.

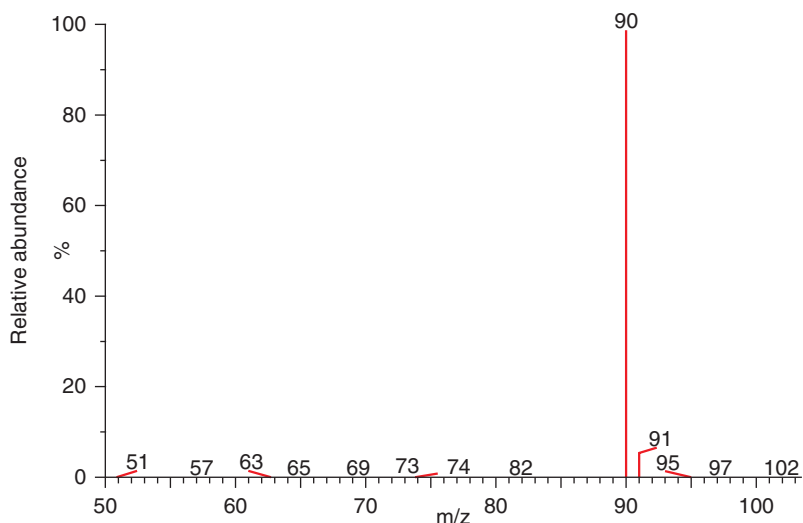

The ^{13}C NMR spectrum has only three peaks so two of the carbon atoms must be the same. There is one signal for saturated carbon next to oxygen, and two for other saturated carbons, one more downfield than the other.

^{13}C NMR spectrum

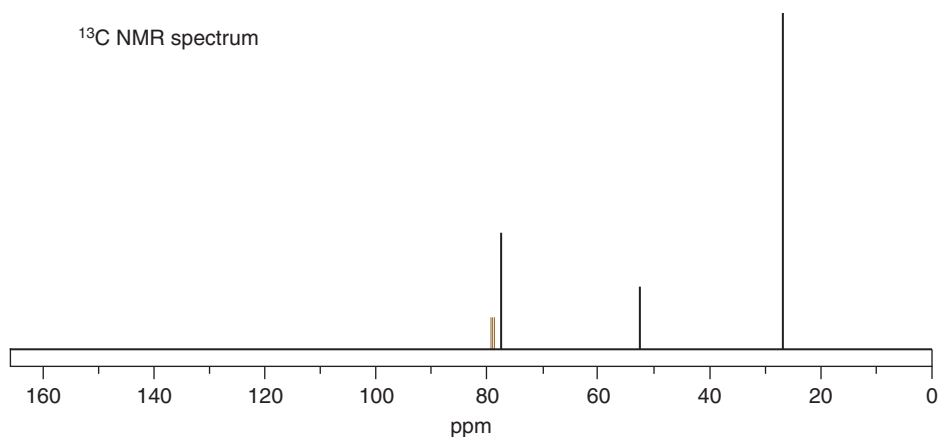

The IR spectrum reveals a broad peak for an OH group with two sharp NH_2 peaks just protruding. If we put this together, we know we have $\text{C}-\text{OH}$ and $\text{C}-\text{NH}_2$. Neither of these carbons can be duplicated (as there is only one O and only one N) so it must be the other two C atoms that are the same.

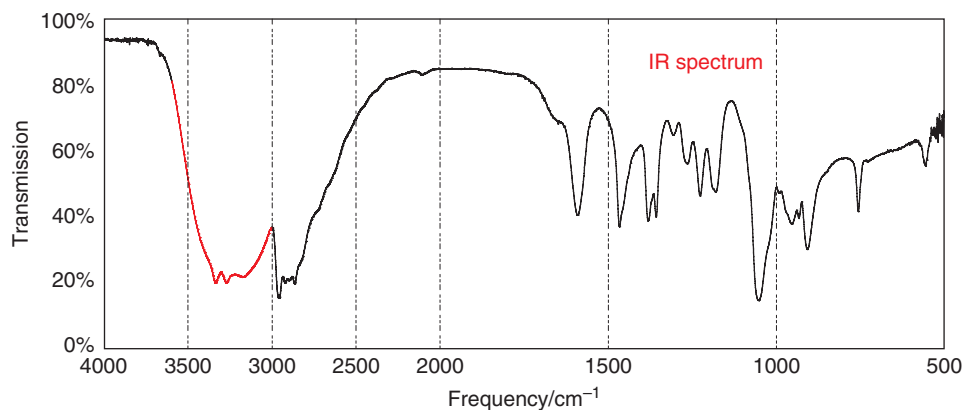

The next stage is one often overlooked. We don't seem to have much information, but try and put the two fragments together, knowing the molecular formula, and there's very little choice. The carbon chain (shown in red) could either be linear or branched and that's it!

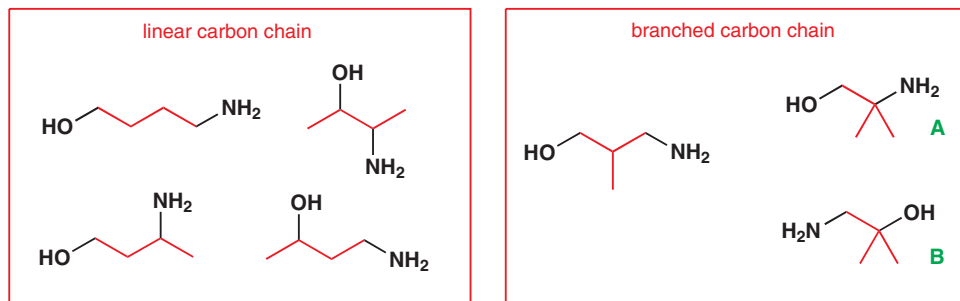

There is no room for double bonds or rings because we need to fit in the 11 hydrogen atoms. We cannot put N or O in the chain because we know from the IR that we have the groups OH and NH₂, which can each be joined only to one other group. Of the seven possibilities only the last two, A and B, are possible since they alone have two identical carbon atoms (the two methyl groups in each case); all the other structures would have four separate signals in the NMR.

So, how can we choose between these? The solution is in the ¹H NMR spectrum, which is shown below. There are only two peaks visible: one at 3.3 and one at 1.1 ppm. It's quite common in ¹H NMR spectra not to see signals for protons attached to O or N (you will see why in Chapter 13) so we can again rule out all structures with more than two different types of H attached to C. Again, we are left with A and B, confirming our earlier deductions. But the chemical shift of the signal at δ 3.3 tells us more: it has to be due to H atoms next to an oxygen atom because it is deshielded. The industrial emulsifier must therefore be A: 2-amino-2-methylpropan-1-ol.

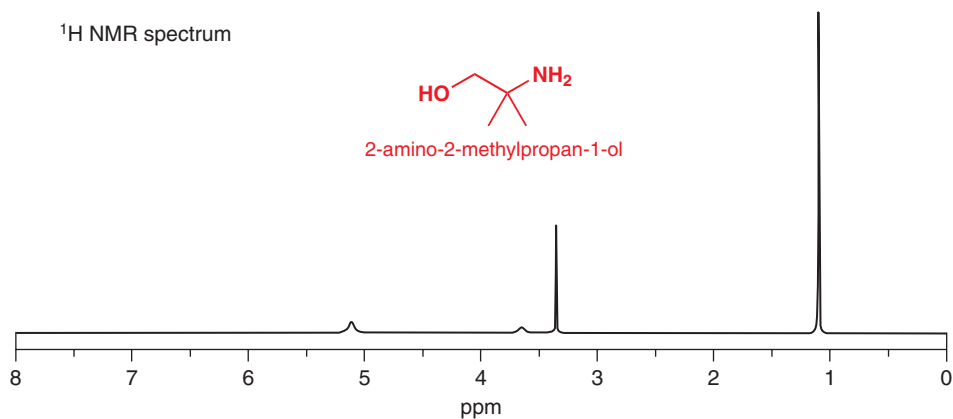
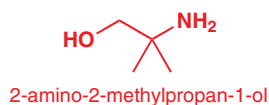

Double bond equivalents help in the search for a structure

The last example was fully saturated but it is usually a help in deducing the structure of an unknown compound if, once you know the atomic composition, you immediately work out how much unsaturation there is. It may seem obvious to you that, as C₄H₁₁NO has no double bonds, then C₄H₉NO (losing two hydrogen atoms) must have one double bond, C₄H₇NO two double bonds, and so on. Well, it's not quite as simple as that. Some possible structures for these formulae are shown below.

some structures for C_4H_9NO

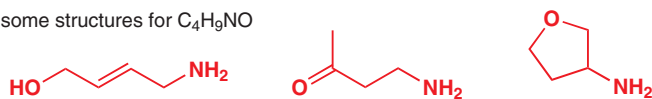

some structures for C_4H_7NO

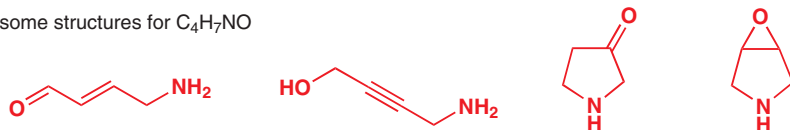

Some of these structures have the right number of double bonds ($C=C$ and $C=O$), one has a triple bond, and three compounds use rings as an alternative way of 'losing' some hydrogen atoms. Each time you make a ring or a double bond, you have to lose two more hydrogen atoms. So double bonds (of all kinds) and rings are called **double bond equivalents** (DBEs).

You can work out how many DBEs there are in a given atomic composition just by making a drawing of one possible structure for the formula (all possible structures for the same formula have the same number of DBEs). Alternatively, you can calculate the DBEs if you wish. A saturated hydrocarbon with n carbon atoms has $(2n + 2)$ hydrogens. Oxygen doesn't make any difference to this: there are the same number of Hs in a saturated ether or alcohol as in a saturated hydrocarbon.

saturated hydrocarbon C_7H_{16}



saturated alcohol $C_7H_{16}O$

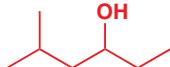

saturated ether $C_7H_{16}O$

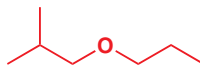

All have
($2n + 2$)
H atoms

So, for a compound containing C, H, and O only, take the actual number of hydrogen atoms away from $(2n + 2)$ and divide by two. Just to check that it works, for the unsaturated ketone $C_7H_{12}O$ the calculation becomes:

1. Maximum number of H atoms for 7Cs: $2n + 2 = 16$
2. Subtract the actual number of H atoms (12): $16 - 12 = 4$
3. Divide by 2 to give the DBEs: $4/2 = 2$

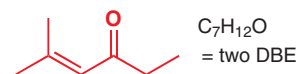

Here are two more examples to illustrate the method. This unsaturated cyclic acid has: $16 - 10 = 6$ divided by $2 = 3$ DBEs and it has one alkene, one $C=O$, and one ring. Correct.

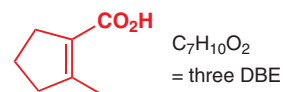

The aromatic ether has $16 - 8 = 8$ divided by 2 gives 4 DBEs and it has three double bonds in the ring and the ring itself. Correct again. A benzene ring always gives four DBEs: three for the double bonds and one for the ring.

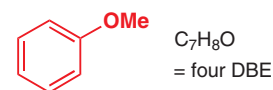

Nitrogen makes a difference. Every nitrogen adds *one extra hydrogen* atom because nitrogen can make three bonds. This means that the formula becomes: subtract actual number of hydrogens from $(2n + 2)$, *add one for each nitrogen atom*, and divide by two. We can try this out too. Here are some example structures of compounds with seven C atoms, one N and an assortment of unsaturation and rings.

saturated C_7 compound with nitrogen



$C_7H_{17}N = (2n + 3)$ H atoms



$C_7H_{15}NO_2 =$ one DBE

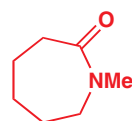

$C_7H_{13}NO =$ two DBE

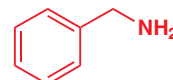

$C_7H_9N =$ four DBE

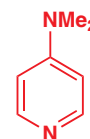

$C_7H_{10}N_2 =$ four DBE

The saturated compound has $(2n + 3)$ Hs instead of $(2n + 2)$. The saturated nitro compound has $(2n + 2) = 16$, less 15 (the actual number of Hs) plus one (the number of nitrogen atoms) = 2.

Divide this by 2 and you get 1 DBE, which is the N=O bond. We leave the third and fourth examples for you to work out, but the last compound (we shall meet this later as DMAP) has:

1. Maximum number of H atoms for 7Cs: $2n + 2 = 16$
2. Subtract the actual number of H atoms (10): $16 - 10 = 6$
3. Add number of nitrogens: $6 + 2 = 8$
4. Divide by 2 to give the DBEs: $8/2 = 4$

There are indeed three double bonds and a ring, making four in all. Make sure that you can do these calculations without much trouble.

If you have other elements too it is simpler just to draw a trial structure and find out how many DBEs there are. You may prefer this method for all compounds as it has the advantage of giving you one possible structure before you really start. One good tip is that if you have few hydrogens relative to the number of carbon atoms (at least four DBEs) then there is probably an aromatic ring in the compound.

Knowing the number of double bond equivalents for a formula derived by high-resolution mass spectrometry is a quick short cut to generating some plausible structures. You can then rule them in or rule them out by comparing with IR and NMR data.

■ Do not confuse this calculation with the observation we made about mass spectra that the molecular weight of a compound containing one nitrogen atom must be odd. This observation and the number of DBEs are, of course, related but they are different calculations made for different purposes.

● Working out the DBEs for an unknown compound

- 1 Calculate the expected number of Hs in the saturated structure
 - (a) For C_n there would be $2n + 2$ H atoms if C, H, O only.
 - (b) For C_nN_m there would be $2n + 2 + m$ H atoms.
- 2 Subtract the actual number of Hs and divide by 2. This gives the DBEs.
- 3 If there are other atoms (Cl, B, P, etc.) it is best to draw a trial structure.
- 4 A DBE indicates either a ring or a double bond (a triple bond is two DBEs).
- 5 A benzene ring has four DBEs (three for the double bonds and one for the ring).
- 6 If there are few Hs, e.g. less than the number of Cs, suspect a benzene ring.
- 7 A nitro group has one DBE only.

An unknown compound from a chemical reaction

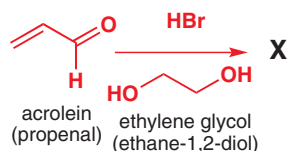

Our last example addresses a situation very common in chemistry—working out the structure of a product of a reaction. The situation is this: you have treated propenal (acrolein) with HBr in ethane-1,2-diol (or glycol) as solvent for 1 hour at room temperature. Distillation of the reaction mixture gives a colourless liquid, compound X. What is it?

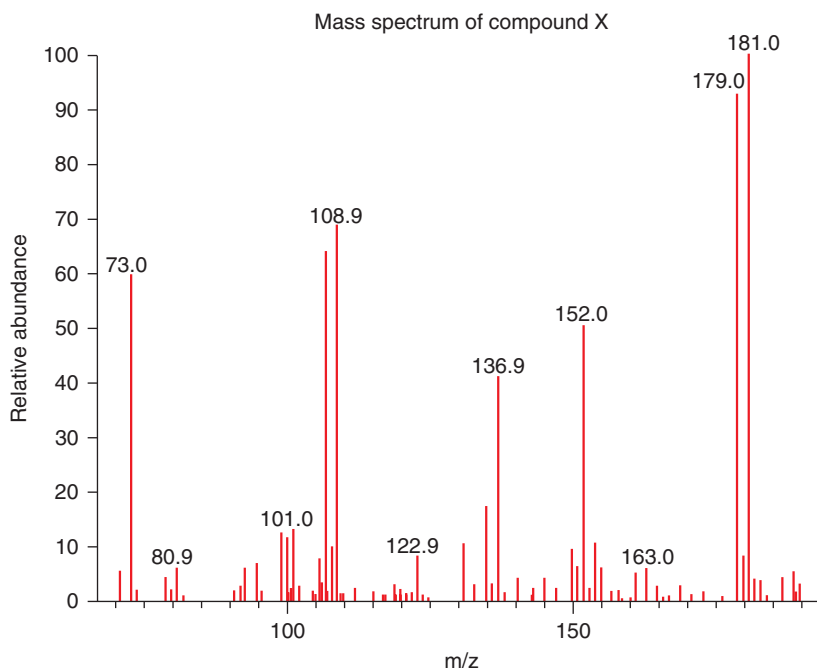

The mass spectrum shows a molecular ion (181) much heavier than that of the starting material, $C_3H_4O = 56$. Indeed it shows two molecular ions at 181 and 179, typical of a bromo compound, so it looks as if HBr has added to the aldehyde somehow. High resolution mass spectrometry reveals a formula of $C_5H_9BrO_2$, and the five carbon atoms make it look as though the glycol has added in too. If we add everything together we find that the unknown compound is the result of the three reagents added together less one molecule of water.

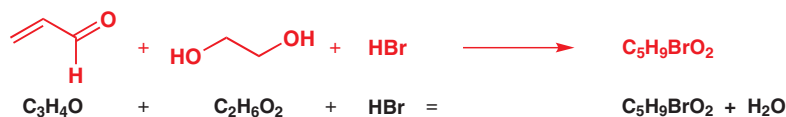

Now, how many DBEs have we got? With a formula like this the safest bet is to draw something that has the right formula—it *need not be what you expect the product to be*. Here's something in the margin—we just added atoms till we got there, and to do so we had to put in one double bond. $C_5H_9BrO_2$ has one DBE.

The next thing is to see what remains of the hydrocarbon skeleton of propenal by NMR. The ^{13}C NMR spectrum of $\text{CH}_2=\text{CH}-\text{CHO}$ clearly shows one carbonyl group and two carbons on a double bond. These have all disappeared in the product and for the five carbon atoms we are left with four signals, two saturated, one next to oxygen, and one at 102.6 ppm, just creeping into the double bond region.

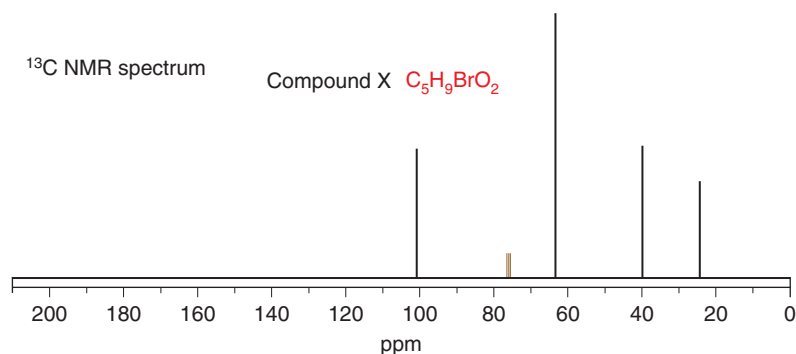
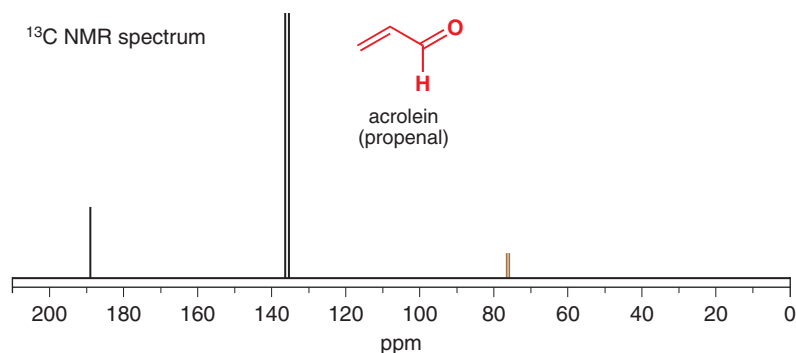

The IR spectrum gives us another puzzle—there appear to be no functional groups at all! No OH, no carbonyl, no alkene—what else can we have? The answer is an ether, or rather two ethers as there are two oxygen atoms. Now that we suspect an ether, we can look for the C–O single bond stretch in the IR spectrum and find it at 1128 cm^{-1} .

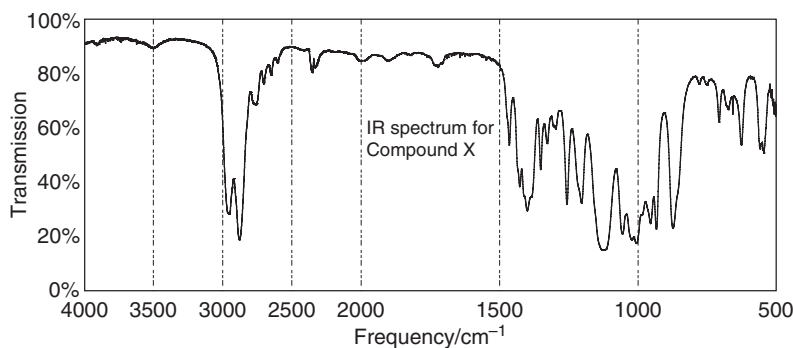

It's often very helpful, when you have an unknown product, to subtract the molecular mass of the starting material from its molecular mass to find out what has been added (or taken away).

trial structure for $C_5H_9BrO_2$:
one DBE

Just a trial structure, not a suggestion for the real product!

Each ether oxygen must have a carbon atom on each side of it, but we seem to have only one carbon in the saturated C next to O region (50–100 ppm) in the ^{13}C NMR. Of course, as you've already seen, these limits are arbitrary, and in fact the peak at 102 ppm is also a saturated C next to O. It is unlikely to be an alkene anyway as it takes two carbons to make an alkene. What would deshield a saturated C as much as this? The answer is two oxygen atoms. We can explain the ^{13}C spectrum if we assume a symmetrical fragment C–O–C–O–C accounts for three of the five carbon atoms.

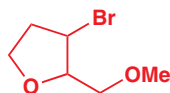

So, where is our double bond equivalent? We know we haven't got a double bond (no alkene and no C=O) so the DBE must be a ring. You might feel uncomfortable with rings, but you must get used to them. Five-, six-, and seven-membered rings are very common. In fact, most known organic compounds have rings in them. We could draw many cyclic structures for the formula we have here, such as this one in the margin.

But this won't do as it would have five different carbon atoms. It is much more likely that the basic skeletons of the organic reagents are preserved, that is, that we have a two-carbon (from the ethylene glycol) and a three-carbon (from the propenal) fragment joined through oxygen atoms. This gives four possibilities, all containing the C–O–C–O–C fragment we deduced earlier (highlighted in black).

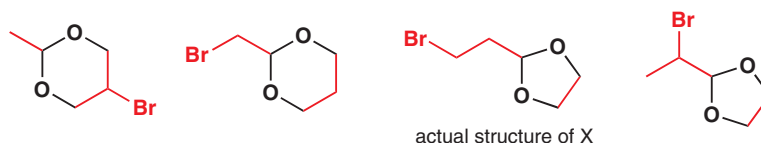

These are all quite reasonable, although we might prefer the third as it is easier to see how it derives from the reagents. The product is in fact this third possibility, and to be sure we would have to turn to the fine details of ^1H NMR spectroscopy, which we return to in Chapter 13.

Looking forward to Chapters 13 and 18

We have only begun to explore the intricate world of identification of structure by spectroscopy. It is important that you recognize that structures are assigned, not because of some theoretical reason or because a reaction 'ought' to give a certain product, but because of sound evidence from spectra. You have seen four powerful methods—mass spectra, ^{13}C and ^1H NMR, and IR spectroscopy—in this chapter. In Chapter 13 we delve more deeply into the most important of all (^1H NMR) and, finally, in Chapter 18 we shall take each of these methods a little further and show how the structures of more complex unknown compounds are really deduced. The last problem we have discussed here is not really solvable without ^1H NMR and in reality no-one would tackle any structure problem without this most powerful of all techniques. From now on spectroscopic evidence will appear in virtually every chapter. Even if we do not say so explicitly every time a new compound appears, the structure of this compound will in fact have been determined spectroscopically. Chemists make new compounds, and every time they do they characterize the compound with a full set of spectra. No scientific journal will accept that a new compound has been made unless a full description of all of these spectra are submitted with the report. Spectroscopy lets the science of organic chemistry advance.

Further reading

You will find it an advantage to have one of the short books on spectroscopic analysis to hand as they give explanations, comprehensive tables of data, and problems. We recommend *Spectroscopic Methods in Organic Chemistry*, 6th edn, by D. H. Williams and Ian

Fleming, McGraw-Hill, London, 2007, and the Oxford Primer *Introduction to Organic Spectroscopy* by L. M. Harwood and T. D. W. Claridge, OUP, Oxford, 1996.

Check your understanding



To check that you have mastered the concepts presented in this chapter, attempt the problems that are available in the book's Online Resource Centre at <http://www.oxfordtextbooks.co.uk/orc/clayden2e/>

4

Structure of molecules

Connections

➔ Building on

- How organic structures are drawn **ch2**
- Evidence used to determine organic structure **ch3**

Arriving at

- How we know that electrons have different energies
- How electrons fit into atomic orbitals
- How atomic orbitals combine to make molecular orbitals
- Why organic molecules adopt linear, planar, or tetrahedral structures
- Connection between shape and electronic structure
- Picturing the shape and energy of molecular orbitals in simple molecules
- Predicting the locations of lone pairs and empty orbitals

➔ Looking forward to

- Reactions depend on interactions between molecular orbitals **ch5 & ch6**
- Reactivity derives from the energies of molecular orbitals **ch5, ch10, & ch12**
- Conjugation results from overlap of orbitals **ch7**
- NMR involves molecular orbitals **ch13**

Introduction

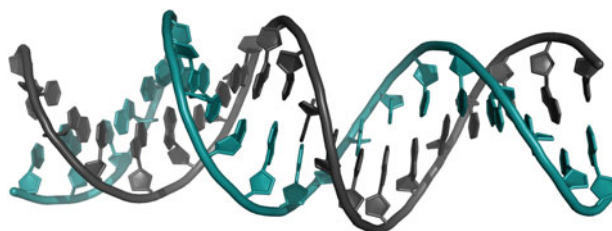

You may recognize the model above as DNA, the molecule that carries the genetic instructions for making all life on earth. The helical shape of DNA was discovered in 1953, and the detailed arrangement of atoms in the DNA molecule determines whether it is a recipe for an ant, an antelope, an antirrhinum, or anthrax.

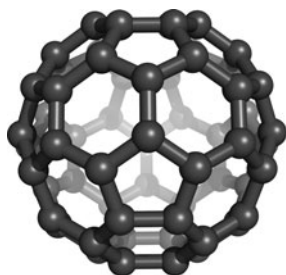

You may also have recognized this molecule as buckminsterfullerene, a soccer-ball shaped allotrope of carbon. Buckminsterfullerene, named after the architect of the geodesic dome (which it resembles), was first identified in 1985 and earned its discoverers the Nobel Prize for chemistry in 1996.

Online support. The icon  in the margin indicates that accompanying interactive resources are provided online to help your understanding: just type www.chemtube3d.com/clayden/123 into your browser, replacing **123** with the number of the page where you see the icon. For pages linking to more than one resource, type **123-1, 123-2** etc. (replacing **123** with the page number) for access to successive links.

Now, our question is this: how did you recognize these two compounds? You recognized their *shapes*. Molecules are not simply a jumble of atoms: they are atoms held together in a defined three-dimensional shape. A compound's properties are determined not only by the atoms it contains, but also by the spatial arrangement of these atoms. Graphite and diamond—the two other allotropes of carbon—are both composed only of carbon atoms and yet their properties, both chemical and physical, are completely different because those carbon atoms are arranged very differently. Graphite has carbon atoms arranged in sheets of hexagons; diamond has them arranged in a tetrahedral array.

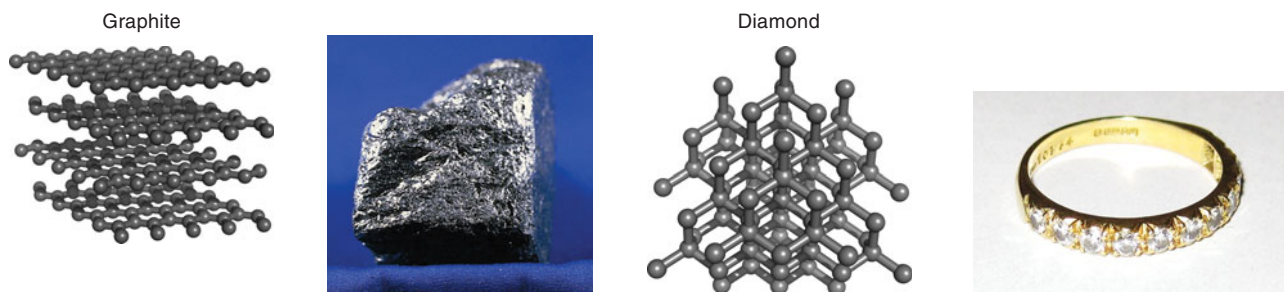

We know what shapes molecules have because we can see them—not literally of course, but by methods such as atomic force microscopy (AFM). AFM reveals the shape of pentacene, the molecule we would usually draw as the structure below, to be as shown on the left. This is the closest we can get to actually 'seeing' the atoms themselves.

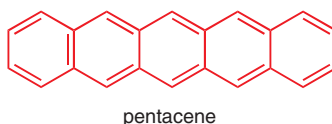
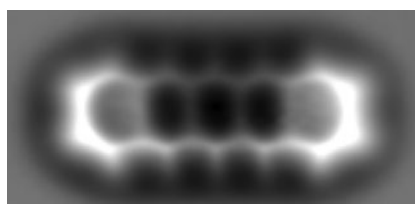



Most analytical techniques reveal the shapes of molecules less directly. X-ray diffraction gives information about the arrangement of atoms in space, while the other spectroscopic methods you met in Chapter 3 reveal details of the composition of molecules (mass spectroscopy) or the connectivity of the atoms they contain (NMR and IR).

From methods such as these, we know what shapes molecules have. This is why we urged you in Chapter 2 to make your drawings of molecules realistic—we can do this because we know what is realistic and what isn't. But now we need to tackle the question of *why* molecules have the shapes they do. What is it about the properties of their constituent atoms which dictates those shapes? We will find that the answer not only allows us to explain and predict structure, but also allows us to explain and predict reactivity (which forms the topic of Chapter 5).

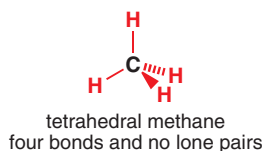
First of all, we need to consider why atoms form molecules at all. Some atoms (helium, for example) do so only with extreme reluctance, but the vast majority of atoms in the periodic table are much more stable in molecules than as free atoms. Here, for example, is methane: four hydrogen atoms arranged around a carbon in the shape of a tetrahedron.



 Interactive structures of buckminsterfullerene, graphite, diamond, and pentacene

 Interactive structures of methane, ammonia, and water

Molecules hold together because positively charged atomic nuclei are attracted to negatively charged electrons, and this fact allows electrons to act as 'glue' between the nuclei. The C and H nuclei of methane are of course positively charged, but the ten electrons (a total of six from C, four from the H atoms) bind those positive charges into a molecular structure. Ammonia (NH_3) and water (H_2O) also have ten electrons in total, and we know that their molecular shapes are in fact just like that of methane, but with one or two hydrogen atoms removed.

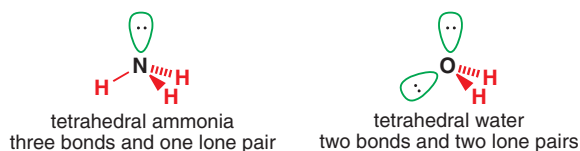

This tells us something important: it is the number of *electrons* which determines the shape of a molecule, and not just the number of *atoms* (or atomic nuclei). But what determines how electrons are arranged? Why do ten electrons give rise to a tetrahedron, for example?

Before we can answer this question, we need to simplify our discussion a bit and think about electrons not in molecules but in individual atoms. We can then approximate the electronic structure of *molecules* by considering how the component atoms combine. It is important to remember throughout this chapter, however, that molecules are only very rarely 'made' directly by joining atoms together. What we are going to present is an analysis of the structure of molecules, not a discussion of ways to build them (to which we will devote much of the later part of this book). Much of what we will cover was worked out in the decades around 1900, and it all came from experimental observation. Quantum theory explains the details, and you can read much more about it in a textbook of physical chemistry. Our aim here is to give you enough of an understanding of the theory to be able to use sound principles to predict and explain the structure of organic molecules.

So, first, some evidence.



■ You met the idea of using energy to move from a lower state to a higher state, and the re-emission of that energy, in the context of NMR in Chapter 3. Here we are talking about much larger differences in energy, and consequently much shorter wavelengths of emitted light.

Two elements, caesium and rubidium, were discovered by Robert Bunsen in 1860 and 1861 after studying atomic emission spectra of this type. They are named after the presence of a pair of brightly coloured lines in their spectra—caesium from the Latin *caesius* meaning bluish grey and rubidium from the Latin *rubidus* meaning red.

■ You can find details of Balmer's formula in a textbook of physical chemistry.

Atomic emission spectra

Many towns and streets are lit at night by sodium vapour lamps, which emit an intense, pure yellow-orange glow. Inside these lights is sodium metal. When the light is switched on, the sodium metal is slowly vaporized. As an electric current is passed through the sodium vapour, an orange light is emitted—the same colour as the light you get when you put a small amount of a sodium compound on a spatula and place it in a Bunsen flame. Given sufficient energy (from the electric current or from a flame) sodium always emits this same wavelength of light, and it does so because of the way the electrons are arranged in a sodium atom. The energy supplied causes an electron to move from a lower energy state to a higher energy, or *excited*, state, and as it drops down again light is emitted. The process is a bit like a weight-lifter lifting a heavy weight—he can hold it above his head with straight arms (the excited state) but sooner or later he will drop it and the weight will fall to the ground, releasing energy with a crash, if not a broken toe. This is the origin of the lines in the atomic spectra not only for sodium but for all the elements. The flame or the electric discharge provides the energy to promote an electron to a higher energy level and, when this electron returns to its ground state, this energy is released in the form of light.

If you refract the orange sodium light through a prism, you see a series of very sharp lines, with two particularly bright ones in the orange region of the spectrum at around 600 nm. Other elements produce similar spectra—even hydrogen, and since a hydrogen atom is the simplest atom of all, we shall look at the atomic spectrum of hydrogen first.

Electrons have quantized energy levels

The absorption spectrum for hydrogen was first measured in 1885 by a Swiss schoolmaster, Johann Balmer, who also noticed that the wavelengths of the lines in this spectrum could be predicted using a mathematical formula. You do not need to know the details of his formula at this stage, instead let's think about the implications of the observation that a hydrogen atom, with just one electron, has a spectrum of discrete lines at precise wavelengths. It means

that the electron can only occupy energy levels with precisely determined values, in other words that the energy of an electron orbiting a proton (a hydrogen nucleus) is **quantized**. The electron can have only certain amounts of energy, and therefore the gaps between these energy levels (which give rise to the spectrum) likewise can only have certain well-defined values. Think of climbing a flight of stairs—you can jump up one, two, five, or even all the steps if you are energetic enough, but you cannot climb up half or two-thirds of a step. Likewise coming down, you can jump from one step to any other—lots of different combinations are possible *but there is a finite number, depending on the number of steps*.

We mentioned an electron 'orbiting' a hydrogen nucleus in the last paragraph deliberately, because that is one way of thinking about an atom—as a miniature (10^{-23} scale!) solar system with the nucleus as the sun and the electrons as planets. This model breaks down when we look at it in detail (as we shall see shortly), but for the moment we can use it to think about why electrons must exist in quantized energy levels.

To do this, we need to introduce a concept from nineteenth century physics—the experimentally observable fact that particles such as photons and electrons can also have the character of a **wave** as well as a **particle**. It's not obvious why the energy of a particle should be quantized, but it makes sense if you allow yourself to think of an electron as a wave.

Imagine a taut string—a piano wire or guitar string, for example—fixed at either end. You may well know that such a string has a fundamental frequency: if you make it vibrate by hitting or plucking it, it will vibrate in a way represented in the diagram on the right.

This diagram shows a snapshot of the string; we could also represent a 'blurred' image of all the places you might find the string as it vibrates, such as you would get if you took a picture with a slow shutter speed.

But this is not the only way the string can vibrate. An alternative possibility is shown on the right, where not only are the ends of the string stationary, but so is the point—known as a 'node'—right in the middle. The wavelength of the vibration in this string is half that of the one above, so the frequency is double. Musically this vibration will sound an octave higher and is known as the first harmonic of the first vibration we showed you, the fundamental. Third and fourth possibilities for 'allowed' vibrations are shown below, and again these correspond musically to further harmonics of the fundamental frequency.

Even if you have not met this idea in music or physics before, we hope that you can see that the vibrating string has no choice but to adopt one of these quantized frequencies—the frequency can take on only certain values because the fixed ends to the string means the wavelength has to be an exact divisor of the length of the string. And as we have seen before, frequencies are directly linked to energies: the energy levels of a vibrating string are quantized.

If you think of an electron as a wave, it becomes much easier to see why it can have only certain energy values. If you think of an electron orbiting a nucleus as a string looped back on itself, you can visualize from the diagrams below why only certain wavelengths are possible. These wavelengths have associated frequencies and the frequencies have associated energies: we have a plausible explanation for the quantization of the energy of an electron.

Electrons occupy atomic orbitals

The popular image of an atom as a miniature solar system, with the electrons behaving like planets orbiting a star—the nucleus—works in some situations, but we are going to have to leave it behind. The problem with this view of the atoms is that electrons can never be precisely located, and instead must be thought of as 'smeared out' over the space available to them. The reason for this derives from **Heisenberg's Uncertainty Principle**, which you can read about in any book on quantum physics. The Uncertainty Principle tells us that we can never know exactly both the location and the momentum of any particle. If we know the energy of an electron (and with quantized energy levels we do), we know its momentum and therefore we cannot know exactly where it is.

As a consequence, we have to think of electrons in atoms (and in molecules) as having a **probability** of being in a certain place at a certain time, and the sum of all these probabilities gives a smeared out picture of the electron's habits, a bit like blurred pictures of the vibrating strings. Because an electron is free to move around an atom in three dimensions, not just two, the allowed

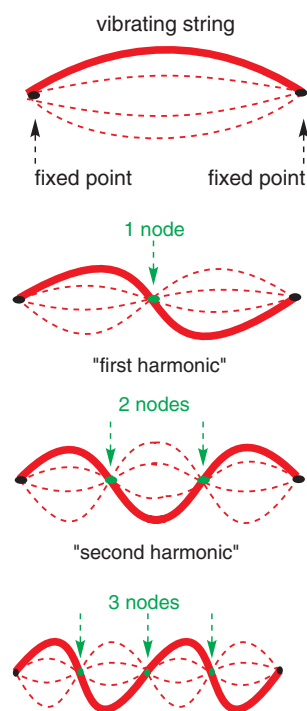
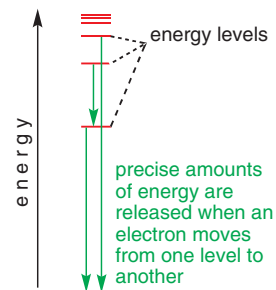

The vibration analogy was first seen by the Danish physicist Niels Bohr, and we hope you can see how it helps to explain why orbitals can only have certain energies. The analogy only works so far—we will have to leave it behind soon—but it can be used to visualize some other aspects of orbitals too, such as nodes and signs of wavefunctions.

'vibrations' it can adopt are also three dimensional and are known as orbitals, or (because we are just considering electrons in a single atom for now) **atomic orbitals**. The shapes of these orbitals are determined by mathematical functions known as **wavefunctions**. The smeared out picture of the simple atomic orbital—the lowest energy state of an electron in a hydrogen atom—looks something like the picture on the left below. We have used shading to indicate the probability of finding an electron at any one point, but a more convenient way to represent an orbital is to draw a line (in reality a three-dimensional surface) encompassing the space where an electron spends, say, 95% of its time. This gives something like the picture on the right. This simplest possible orbital—the fundamental orbital of the H atom—is spherical, and is known as a **1s orbital**. Higher energy atomic orbitals have different shapes, as you will see soon.

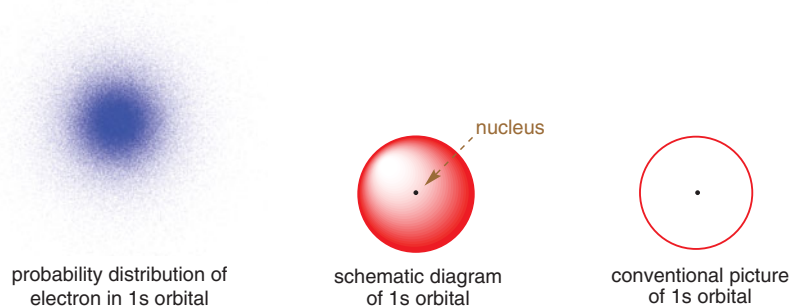

It's useful to think of the atomic orbitals as a series of possible energy values for an electron, and to think of them as 'occupied' if there is an electron (or, as we shall see below, two electrons) at that energy level, and 'unoccupied' if there isn't. In a hydrogen atom in its most stable state, there is only one electron, occupying the lowest energy 1s orbital. So our picture of the 1s orbital makes a good picture of what an H atom looks like too. We can also represent the 1s orbital as an energy level, and the electron which occupies it as a little arrow (which we will explain in a moment).

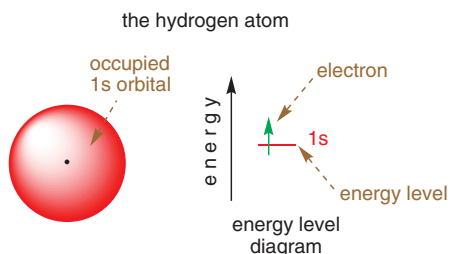

This is known as the *Pauli exclusion principle*.

What happens if you put more than one electron into the orbitals around an atom? Well, for reasons we can't go into here, each orbital can hold two electrons—and only two, never any more. If you add an electron to the H atom, you get the hydride anion, H^- , which has two electrons around an H nucleus (a proton). Both of the electrons occupy the same spherical 1s orbital.

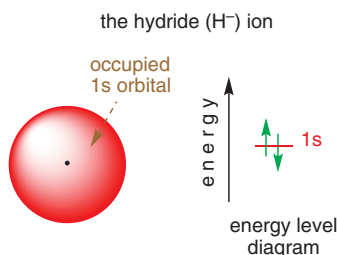

■ We talked about spinning *nuclei* in the context of NMR (p. 53). Electron spin is analogous, but different—you can't observe electrons by NMR, for example, and instead they can be observed by a technique known as electron spin resonance or ESR.

We can also represent the orbital occupancy as an energy level (the horizontal line) occupied by two electrons (the arrows). Why do we draw the electrons as arrows? Well, electrons have the property of spin, and the two electrons allowed in each orbital have to spin in opposite directions. The arrows are a reminder of these opposing spins.

The same is true for the helium atom: its two electrons occupy the same orbital. However, the energy of that orbital (and all of the other possible orbitals) will be different from the orbital for hydrogen because it has double the nuclear charge of hydrogen and the electrons are more strongly attracted to the nucleus. We can represent the orbital occupancy like this, with the energy level lower than the one for H because of this stronger attraction.

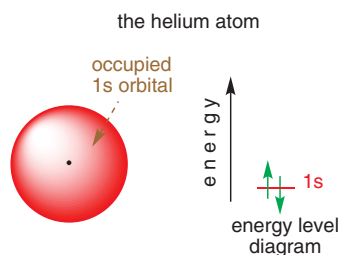

s and p orbitals have different shapes

So far, so good. Now, lithium. The lowest energy 1s orbital around the Li nucleus can contain two electrons, but two only, so the third electron has to go into a higher energy orbital—one of the energy levels whose existence was inferred from atomic absorption spectroscopy. You can think of this orbital as the three-dimensional equivalent of the first harmonic of the guitar string. Like the vibration of the string, this next orbital has a node. On the string the node was the point where no motion was observed. In an atom, a node is a point where the electron can never be found—a void separating the two parts of the orbital. For the orbital containing the third electron of the Li atom, this node is spherical—it divides the orbital into two parts which nestle one within another like the layers of an onion or the stone inside a peach. We call this orbital the 2s orbital—'2' because we have moved up to an orbital with a node (like the first harmonic) and 's' because the orbital is still spherical. The 's' did not originally stand for 'spherical', but as all 's' orbitals are spherical it's fine to remember it that way.

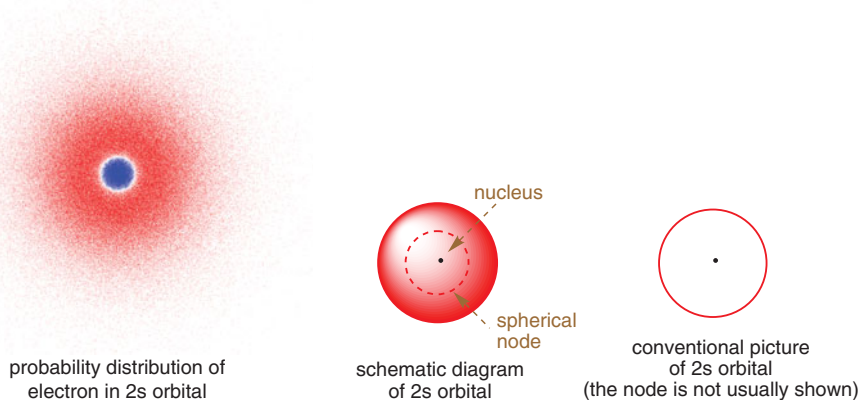

In a lithium atom the 1s orbital, close to the nucleus, is occupied by two electrons, while the 2s orbital, further from the nucleus, contains one. In beryllium, there is a second electron in the 2s orbital. As before the energy levels will change as the nuclear charge increases, so the orbital occupancy in Li and Be can be represented as shown below.

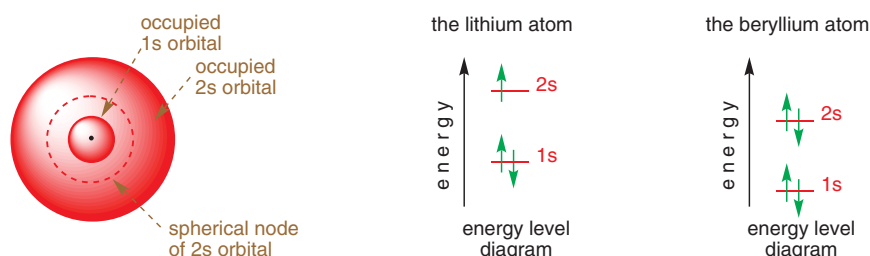

When we get to boron, something a little different happens. It turns out that for an orbital with one node (such as the 2s orbital), the node does not have to be *spherical*. The node can

alternatively be a *plane*. This alternative arrangement for an orbital with a single planar node gives us a new type of orbital, the 2p orbital. A 2p orbital looks something like the picture on the left below, in ‘smeared out’ form. It is often represented as the propeller shape in the middle, and it is conventionally drawn as the shape shown in the diagram to the right.

■ We will explain shortly why only half of the picture of the p orbital on the right has been filled in.

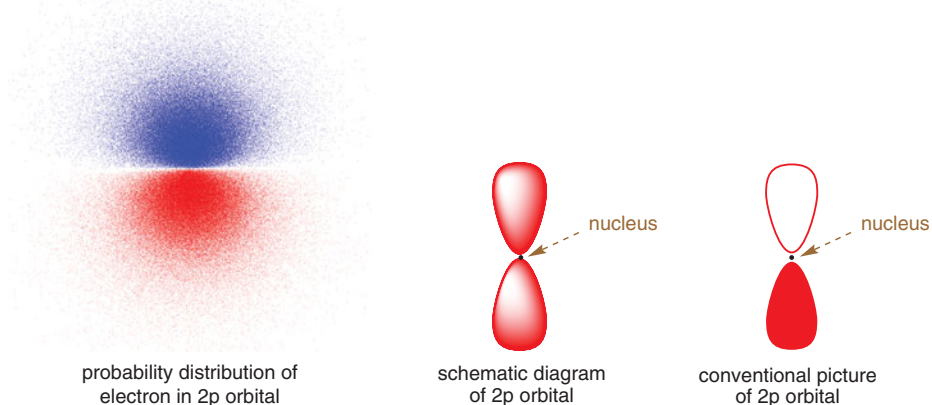

Unlike the 1s or 2s orbitals, the 2p orbital is directional—it points along an axis, and in three dimensions there are three possible orientations for the axis, each of which gives rise to a new 2p orbital (which we can call $2p_x$, $2p_y$, and $2p_z$ if we need to).

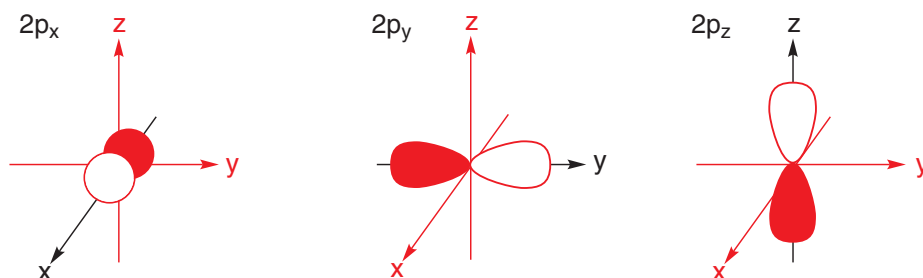

Three-dimensional representations of the shapes of atomic orbitals

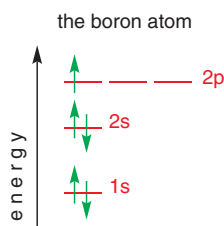

This is known as **Hund's rule**. An atom adopts the electronic configuration that has the greatest number of unpaired electrons in degenerate orbitals. Whilst this is all a bit theoretical in that isolated atoms are not found very often, the same rule applies to electrons in degenerate orbitals in molecules, as you will see soon.

The planar node of the three 2p orbitals gives them just slightly more energy than a 2s orbital, with its spherical node. Boron atoms therefore have two electrons in the 1s orbital, two in the 2s orbital, and just one in one of the 2p orbitals. The orbital occupancy is shown in the energy level diagram on the left. You can imagine what shape each of the orbitals has: we won't need to show a picture of them all superimposed.

The next element, carbon, with one more (a sixth) electron, seems to have a choice—it can put its sixth electron paired with the fifth one, in the same 2p orbital, or it can put it into a new 2p orbital, with both electrons unpaired. In fact it chooses the latter: electrons are negatively charged and repel one another, so if there is a choice of equal energy orbitals they occupy different orbitals singly until they are forced to start pairing up. The repulsion is never enough to force an electron to occupy a higher energy orbital, but when the orbitals are otherwise of identical energy, this is what happens.

Not surprisingly therefore, the orbitals of atoms of the remainder of the elements of the first row of the periodic table are occupied as shown below. All the while the entire set of orbitals is going down in energy because the nucleus is attracting the electrons more strongly, but otherwise it is a simple matter of filling up the 2p orbitals first singly and then doubly. With the ten electrons of neon, all the orbitals with one node are filled, and we say that neon has a ‘closed shell’. A ‘shell’ is a group of orbitals of similar energy all with the same number of nodes (in this case all called ‘2’ something—2s or 2p).

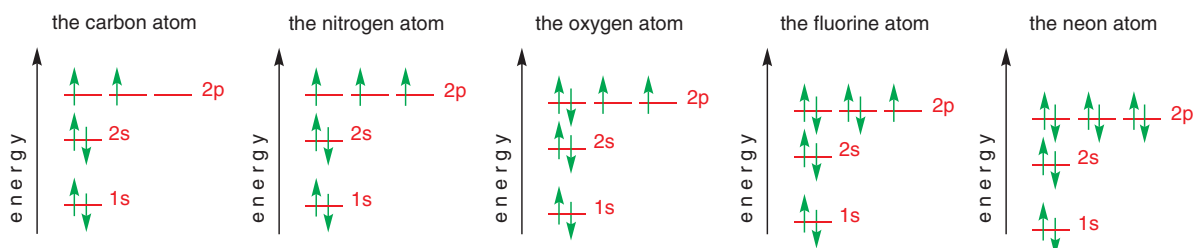

The phase of an orbital

Look at the diagrams below, which are the same as the ones on p. 83: they represent the first three vibrational frequencies of a string. Now think about the motion of the string itself: in the first vibration, all of the string moves up and down at the same time—each point on the string moves by a different amount, but the direction moved at every point is the same. The same is not true for the second ‘energy level’ of the string—during a vibration like this, the left-hand half of the string moves upwards while the right-hand half moves downwards—the two halves of the string are out of phase with one another, and there is a change of phase at the node. The same is true of the third energy level—again, there is a change of phase at each node.

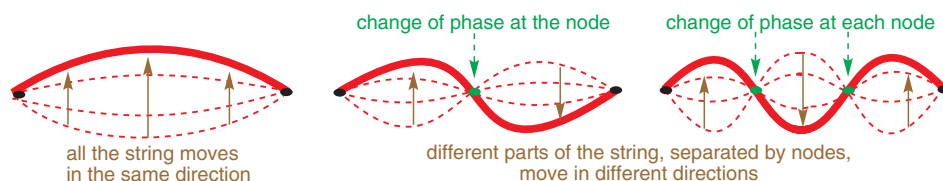

The same is true for orbitals. A nodal plane, such as that in the 2p orbitals, divides the orbital into two parts with different phases, one where the phase of the wavefunction is positive and one where it is negative. The phases are usually represented by shading—one half is shaded and the other half not. You saw this in the representation of the 2p orbital above. The phase of an orbital is arbitrary, in the sense that it doesn't matter which half you shade. It's also important to note that phase is nothing to do with charge: both halves of a filled 2p orbital contain electron density, so both will be negatively charged.

So why is phase important? Well, in a moment we will see that, just as atoms add together to give molecules, we can add together the wavefunctions of atomic orbitals to give molecular orbitals, which tell us where electrons are, and how much energy they have, in molecules.

As it happens, the electron density at any point in the orbital is given by the *square* of the mathematical function (the wavefunction) which determines the phase, so both positive and negative values of the wavefunction give positive electron densities.

s, p, d, f

Why 2s, 2p...? These letters hark back to the early days of spectroscopy and refer to the appearance of certain lines in atomic emission spectra: 's' for 'sharp' and 'p' for 'principal'. Later you will meet d and f orbitals, which have other arrangements of nodes. These letters came from 'diffuse' and 'fundamental'. The letters s, p, d, and f matter and you must know them, but you do not need to know what they originally stood for.

Four short clarifications about orbitals before we go on

We're about to develop the idea of orbitals in order to understand how electrons behave in molecules, but before we go on, we should just clarify a few points about orbitals that can sometimes lead to confusion.

1. Orbitals do not need to have electrons in them—they can be vacant (there doesn't have to be someone standing on a stair for it to exist). Helium's two electrons fill only the 1s orbital, but an input of energy—the intense heat in the sun, for example—will make one of them hop up into the previously empty 2s, or 2p, or 3s... etc. orbitals waiting to receive them. In fact, it was observing, from earth, the energy absorbed by this process which led to the first discovery of helium in the sun.
2. Electrons may be found anywhere in an orbital except in a node. In a p orbital containing one electron, this electron may be found on either side but never in the middle. When the orbital contains two electrons, one electron doesn't stay in one half and the other electron in the other half—both electrons could be anywhere (except in the node).
3. All these orbitals of an atom are superimposed on each other. The 1s orbital is *not* the middle part of the 2s orbital. The 1s and 2s orbitals are separate orbitals in their own rights and each can hold a maximum of two electrons but the 2s orbital does occupy some of the same space as the 1s orbital (and also as the 2p orbitals, come to that). Neon, for example, has ten electrons in total: two will be in the 1s orbital, two in the

(much bigger) 2s orbital, and two in each of the three 2p orbitals. All these orbitals are superimposed on each other.

4. As we move across subsequent rows of the periodic table—starting with sodium—the 1s, 2s, and 2p orbitals are already filled with electrons, so we must start putting electrons into the 3s and 3p orbitals, then the 4s, 3d, and 4p orbitals. With d orbitals (and f orbitals, which start to be filled in the lanthanide series) there are yet further new arrangements of nodes. We won't be discussing these orbitals in detail—you will find detailed consideration in an inorganic textbook—but the principles are just the same as the simple arrangements we have described.

Three-dimensional representations of d and f orbitals

■ This way of building up molecular from atomic orbitals is known as the **linear combination of atomic orbitals** or **LCAO**.

Molecular orbitals—diatomic molecules

Now for electrons in molecules. Just as the behaviour of electrons in atoms is dictated by the **atomic orbitals** they reside in, so electrons in molecules behave in ways dictated by the **molecular orbitals** which contain them. We think of molecules as being built from atoms (even if that is not actually how you would usually make them), and likewise we can think of molecular orbitals as being built up from a combination of atomic orbitals.

As atomic orbitals are wavefunctions, they can be combined in the same way that waves combine. You may be already familiar with the ideas of combining waves either *constructively* (in phase) or *destructively* (out of phase):

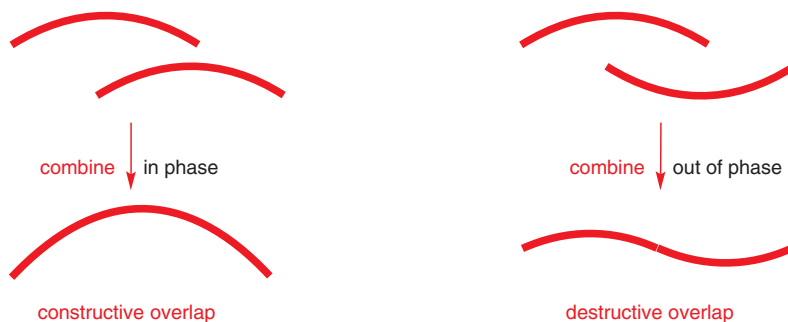

Atomic orbitals can combine in the same ways—in phase or out of phase. Using two 1s orbitals drawn as circles (representing spheres) with dots to mark the nuclei and shading to represent phase, we can combine them in phase (that is, we add them together), resulting in an orbital spread over both atoms, or out of phase (by subtracting one from the other). In this case we get a molecular orbital with a nodal plane down the centre between the two nuclei, where the wavefunctions of the two atomic orbitals exactly cancel one another out and with two regions of opposite phase.

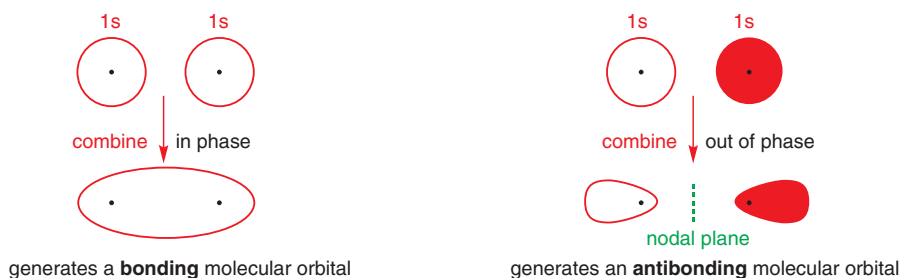

The resulting orbitals belong to both atoms—they are *molecular* rather than atomic orbitals. Now, imagine putting electrons into the first of these orbitals (the bonding orbital). Remember, you can put zero, one, or two electrons into an orbital, but no more. The diagram of the orbital shows that the electrons would spend most of their time in between the two atomic nuclei. Being negatively charged, the electrons will exert an attractive force on each of the nuclei, and would hold them together. We have a chemical bond! For this reason the in-phase molecular orbital is called a **bonding orbital**.

The out-of-phase molecular orbital offers no such attractive possibility—in fact putting electrons into the out-of-phase molecular orbital works against bonding. These electrons are mainly to be found anywhere *but* between the two nuclei, where there is a node. The exposed positively charged nuclei repel each other, and that is why this orbital is known as an **anti-bonding molecular orbital**.

The combination of the atomic 1s orbitals to give the two new molecular orbitals can also be shown on a molecular orbital energy level diagram. The two atomic orbitals are shown on the left and the right, and the molecular orbitals which result from combining them in and out of phase are shown in the middle. The diagram as a whole is a sort of ‘before and after’ diagram—the situation before the interaction between the orbitals is shown on the left and the right, and after the interaction is shown in the middle. Notice that the bonding orbital is lower in energy than the constituent 1s orbitals, and the antibonding orbital is higher.

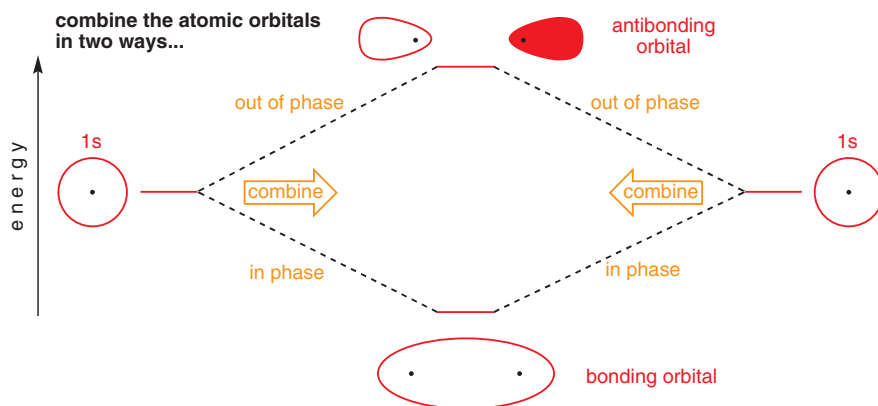

 Interactive molecular orbitals for hydrogen

Now we can actually put the electrons into the orbitals, just as we did on p. 84 when we were building up the picture of atomic orbitals. Each hydrogen atom has one electron and so the resulting hydrogen molecule (shown in the middle) contains two electrons. Always fill up orbitals from the lowest energy first, putting a maximum of two electrons into each orbital, so both of these electrons go into the bonding orbital. The antibonding orbital remains empty. The electrons therefore spend most of their time in between the nuclei, and we have a plausible explanation for the existence of a chemical bond in the H_2 molecule.

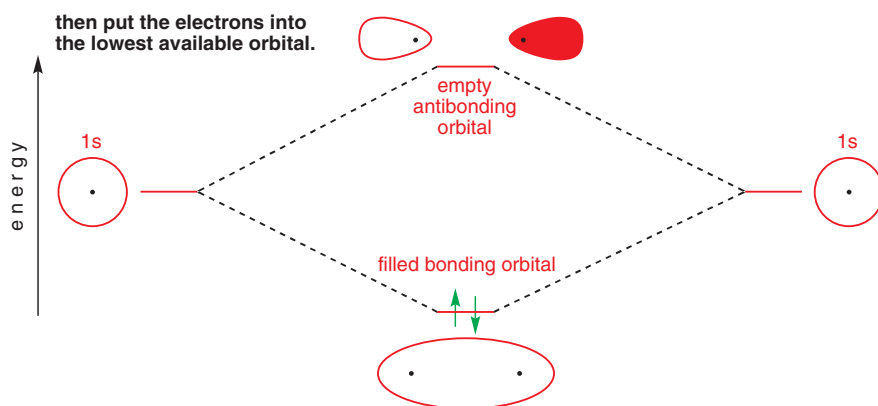

Diagrams such as these are central to the way we can use molecular orbital theory (MO theory) to explain structure and reactivity, and you will in future meet many more of them. So before we go on it is worth clarifying several points about this one:

- Two atomic orbitals (AOs) combine to give two molecular orbitals (MOs). You always get the same number of MOs out as you put AOs in.
- Adding the wavefunctions (combining them in phase) of the two AOs makes the bonding orbital; subtracting them (combining them out of phase) makes the antibonding orbital.

- Since the two atoms are the same (both H), each AO contributes the same amount to the MOs (this will not always be the case).
- The bonding MO is *lower* in energy than the AOs.
- The antibonding MO is *higher* in energy than the AOs.
- Each hydrogen atom initially had one electron. The spin of these electrons is unimportant.
- The two electrons end up in the MO lowest in energy—the bonding MO.
- Just as with AOs, each MO can hold two electrons as long as the electrons are spin-paired (shown by opposing arrows). You do not need to be concerned with the details of spin-pairing at this stage, just with the result that any orbital may contain no more than two electrons.
- The two electrons between the two nuclei in the bonding MO hold the molecule together—they are the chemical bond.
- Since these two electrons are lower in energy in the MO than they were in the AOs, the molecule is more stable than its constituent atoms; energy is given out when the atoms combine.
- Or, if you prefer, we must put in energy to separate the two atoms again and to break the bond.

From now on, we will always represent molecular orbitals in energy order—the highest-energy MO at the top (usually an antibonding MO) and the lowest in energy (usually a bonding MO and the one in which the electrons are most stable) at the bottom.

Before you leave this section, let's recap how we got to the MO diagram of H_2 . It's worth working through these steps to check you can draw your own MO diagram before you leave this section.

1. Draw two H atoms along with the 1s atomic orbitals which contain the electron, one on either side of the page.
2. Sketch the result of adding and of subtracting the wavefunctions of these two 1s orbitals to show the bonding and antibonding MOs. These go one above the other (high energy antibonding orbital on top) in between the AOs.
3. Count up the total number of electrons in the atoms going in to the molecule, and put that number of electrons into the MOs, starting at the bottom and building upwards, two in each orbital.

Breaking bonds

The diagram we have studied shows the most stable ground state of a hydrogen molecule, in which the electrons have the lowest possible energy. But what happens if an electron is promoted up from the lowest energy level, the bonding MO, to the next lowest energy level, the antibonding MO? Again, an energy level diagram helps.

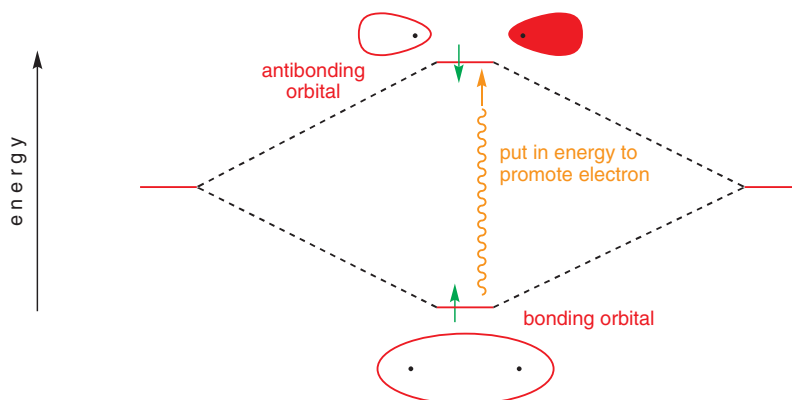

Now the electron in the antibonding orbital cancels out the bonding of the electron in the bonding orbital. Since there is no overall bonding holding the two atoms together, they can drift apart as two separate atoms with their electrons in 1s AOs. In other words, promoting an electron from the bonding MO to the antibonding MO breaks the chemical bond. This is difficult to do with hydrogen molecules but easy with, say, bromine molecules. Shining light on Br_2 causes it to break up into bromine atoms.

Why hydrogen is diatomic but helium is not

Like H atoms, He atoms have their electrons in 1s orbitals, so we can construct an energy level diagram for He_2 in a similar way. But there is one big difference: each helium atom has two electrons so now both the bonding MO and the antibonding MO are full! Any bonding due to the electrons in the bonding orbital is cancelled out by the electrons in the antibonding orbital, and the He_2 molecule falls apart. He_2 does not exist.

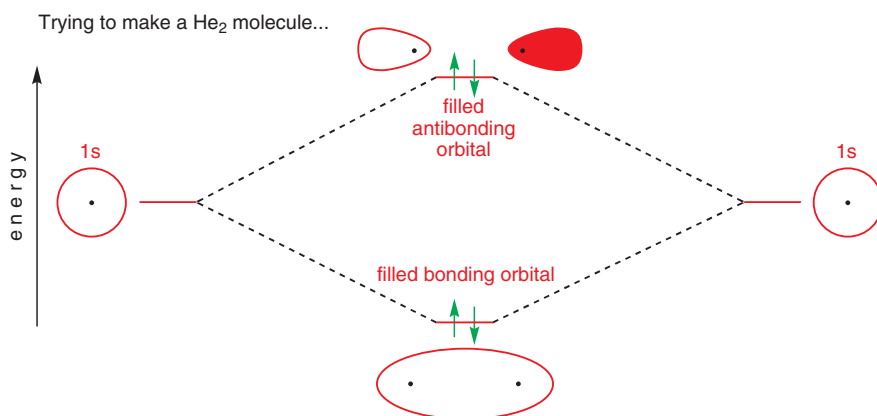

Bond order

Only if there are more electrons in bonding MOs than in antibonding MOs will there be any bonding between two atoms. In fact, we define the number of bonds between two atoms as the bond order (dividing by two since *two* electrons make up a chemical bond).

$$\text{bond order} = \frac{(\text{no. of electrons in bonding MOs}) - (\text{no. of electrons in antibonding MOs})}{2}$$

Hence the bond orders for H_2 and He_2 are

$$\text{bond order}(\text{H}_2) = \frac{2-0}{2} = 1, \quad \text{i.e. a single bond}$$

$$\text{bond order}(\text{He}_2) = \frac{2-2}{2} = 0, \quad \text{i.e. no bond}$$

Forming bonds using 2s and 2p atomic orbitals: σ and π orbitals

Atoms in the row of the periodic table running from Li to F have electrons in 2s and 2p orbitals, and as all molecules of interest to organic chemists contain at least one such atom we now need to think about how 2s and 2p orbitals interact. We also need to introduce you to a useful piece of terminology that is used to describe the *symmetry* of molecular orbitals.

We can do all of this by thinking about the bonding in another ubiquitous diatomic gas, N_2 . N atoms have electrons in 1s, 2s, and 2p orbitals, so we need to consider interactions between pairs of each of these orbitals in turn.

1s orbitals we have already dealt with. Combining 2s orbitals is essentially just the same; they form bonding and antibonding orbitals just as 1s orbitals do and with similar shapes too, but higher energies, because the 2s orbitals are higher in energy than the 1s orbitals. The 2s orbitals are also bigger than 1s orbitals, and because of their 'onion skin' form, the exact nature of the MOs they give rise to is more complex than those which come from 1s AOs, but you can represent them in sketches in just the same way:

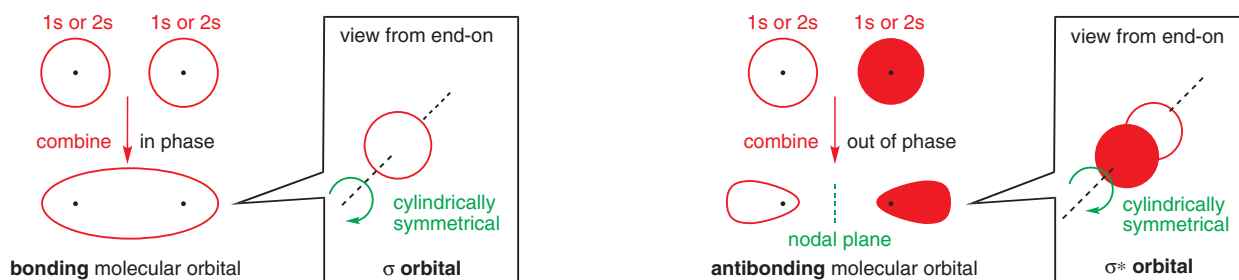

The bonding orbitals formed from 1s–1s and 2s–2s interactions have another important feature in common: they are all *cylindrically symmetrical*. In other words, if you look at the molecular orbital end-on, you can rotate it around the axis between the two atoms by any amount and it looks identical. It has the symmetry of a cigar, a carrot, or a baseball bat. Bonding orbitals with cylindrical symmetry like this are known as σ (sigma) orbitals, and the bonds which result from putting two electrons into these orbitals are known as σ bonds. The single bond in the H_2 molecule is therefore a σ bond.

The antibonding orbitals which result from combining these AOs are also cylindrically symmetrical and are called σ^* orbitals, with the * denoting their antibonding character.

Now for the 2p orbitals. As described on p. 86 each atom has three mutually perpendicular 2p atomic orbitals. In a diatomic molecule, such as N_2 , these 2p orbitals must combine in two different ways—one p orbital from each atom (shown in red here) can overlap end-on, but the other two p orbitals on each atom (shown in black) must combine side-on.

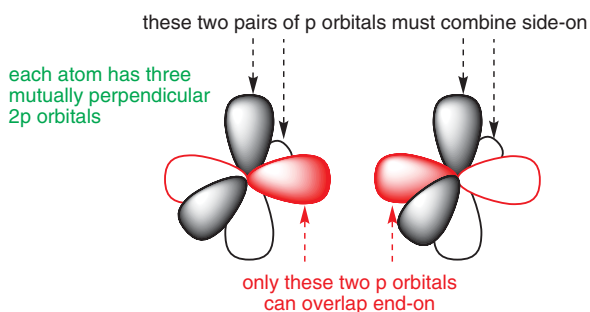

We'll deal with the end-on overlap first. This is what happens if we combine the two 2p orbitals out of phase: as with the 2s orbitals, we have a node between the atoms, and any electron in this MO would spend most of its time not between the nuclei—as you can guess, this is an antibonding orbital.

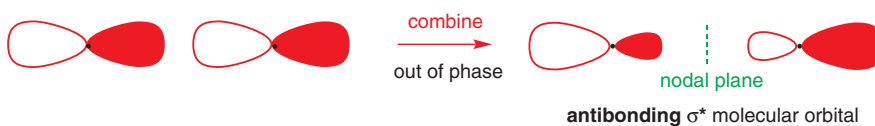

If we combine the orbitals in phase, this is what we get.

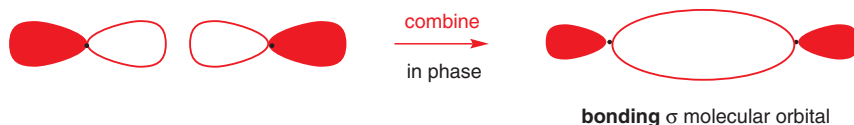

There is a nice rich area of electron density between the nuclei, and somewhat less outside, so overall filling this orbital with electrons would lead to an attraction between the atoms and a bond would result.

Both of these MOs have cylindrical symmetry and are therefore designated σ and σ^* orbitals, and a bond formed by filling the MO made from interacting two 2p orbitals end-on is called a σ bond.

● **σ bonds can be made from s or p atomic orbitals, provided they form a cylindrically symmetrical molecular orbital.**

Each atom presents its other two 2p orbitals for side-on overlap. This is what the antibonding MO formed by out-of-phase combination of two side-on p orbitals looks like:

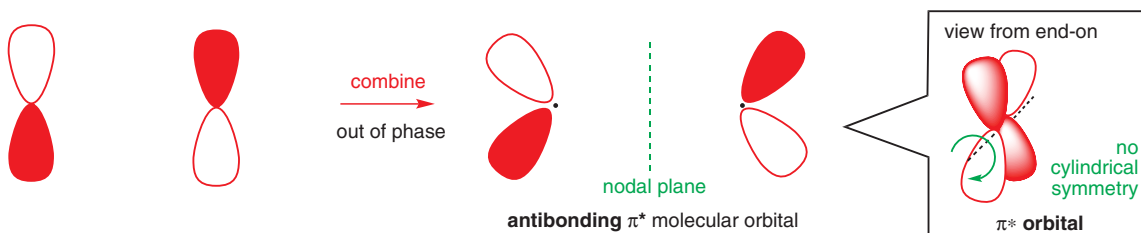

And this is the bonding, in-phase combination

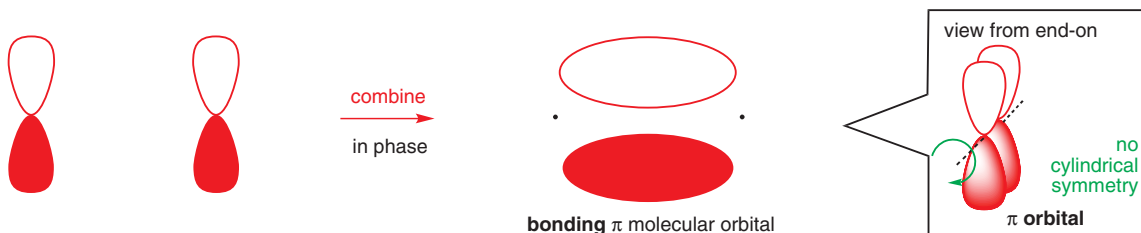

These MOs do not have cylindrical symmetry—in fact you have to rotate them 180° about the axis between the nuclei before you get back something looking like what you started with but with opposite phase—and as a result the symmetry of these orbitals is given the symbol π : the bonding orbital is a π orbital and the antibonding orbital is a π^* orbital. Bonds which are formed by filling π orbitals are called π bonds, and you'll notice that because of the π symmetry the electron density in these bonds does not lie directly between the two nuclei but rather to either side of the line joining them.

Since an atom has three mutually perpendicular 2p orbitals, two of which can interact side-on in this way, there will exist a pair of degenerate (equal in energy) mutually perpendicular π orbitals and likewise a pair of degenerate mutually perpendicular π^* orbitals. (The third p orbital interacts end-on, forming a σ orbital and a σ^* orbital, of course).

The two sorts of MOs arising from the combinations of the p orbitals are, however, not degenerate—more overlap is possible when the AOs overlap end-on than when they overlap side-on. As a result, the 2p–2p σ orbital is lower in energy than the 2p–2p π orbitals.

We can now draw an energy level diagram to show the combinations of the 1s, 2s, and 2p AOs to form MOs, labelling each of the energy levels with σ , σ^* , π , or π^* as appropriate.

■ Because it can be difficult to represent exactly the result of adding and subtracting p orbitals, you will often see π and π^* orbitals represented in diagrams simply as their 'uncombined' p orbitals—the structures on the left above. For an example, see p. 105.

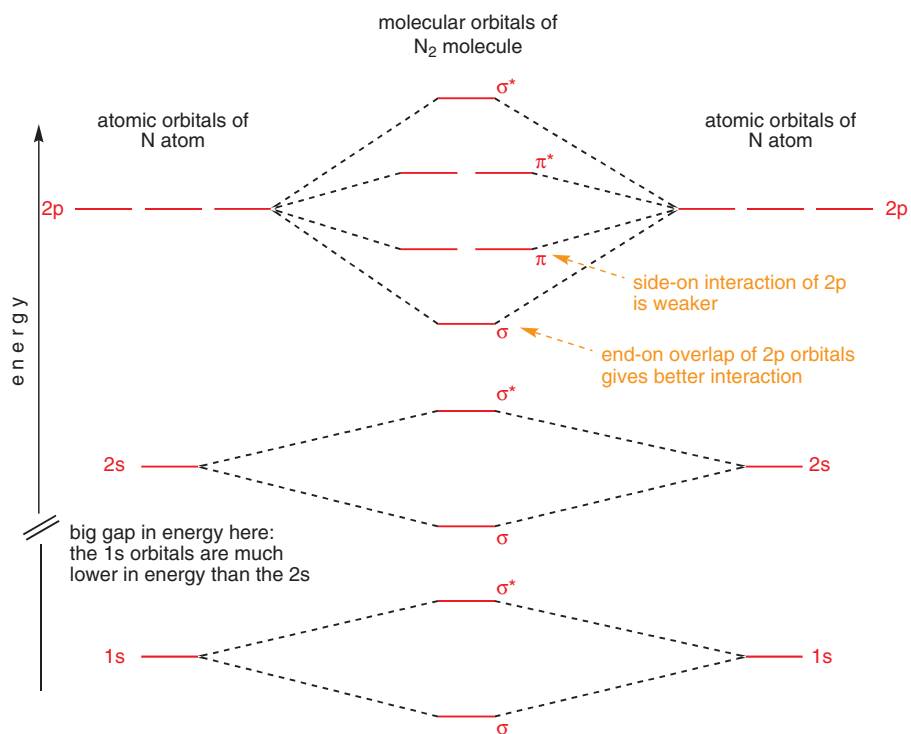

Now for the electrons. Each nitrogen atom contributes seven electrons to the molecule, so we have to fill this stack of orbitals with 14 electrons, starting at the bottom. The result is:

■ The $2s\sigma$, $2p\sigma$, and $2p\pi$ orbitals fall very close in energy: for a more detailed discussion of their relative energies, consult an inorganic chemistry textbook.

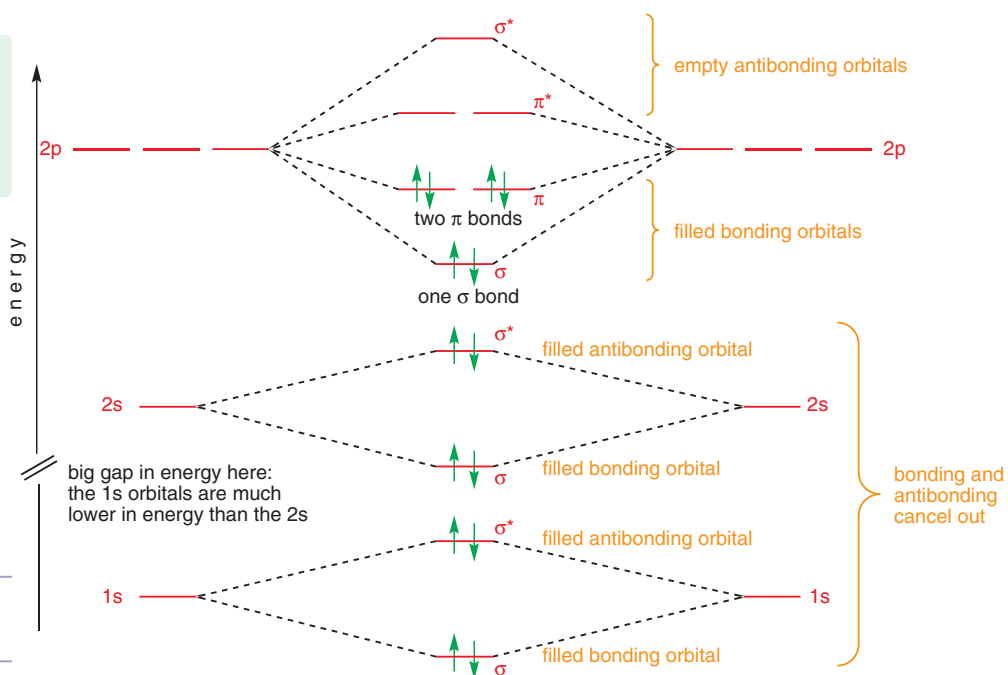

Interactive molecular orbitals for nitrogen

The σ and σ^* MOs formed from interactions between the two 1s orbitals, and the two 2s orbitals are all filled: no overall bonding results because the filled bonding and antibonding orbitals cancel each other out. All the bonding is done with the remaining six electrons. They fit neatly into a σ bond from two of the p orbitals and two π bonds from the other two pairs.

The electrons in the σ bond lie between the two nuclei, while the electrons in the two π bonds lie in two perpendicular clouds flanking the central σ bond.

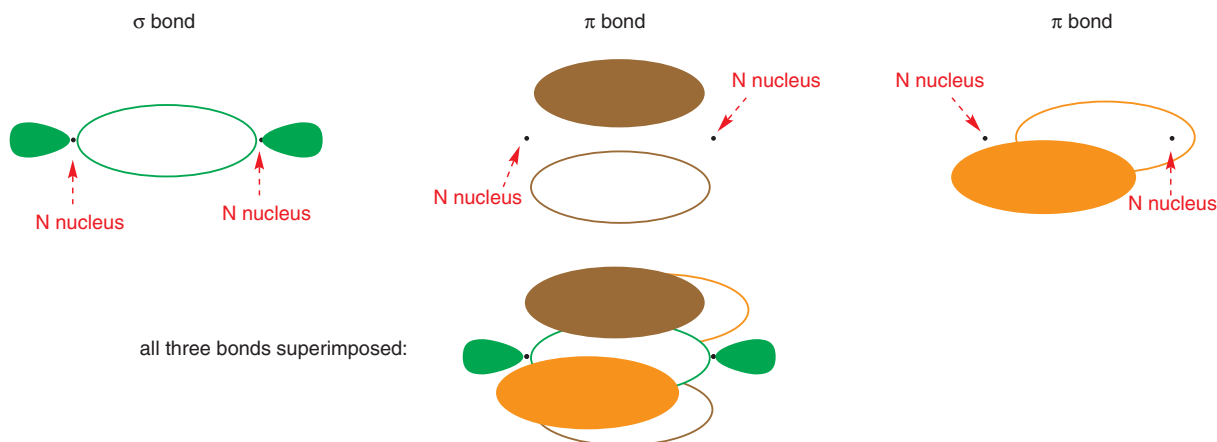

Calculating the bond order in N_2 is easy—a total of ten bonding electrons and four antibonding electrons gives a credit of six, or a bond order of three. N_2 has a triple-bonded structure.

We can't, however, ignore the electrons that are not involved in bonding: there are eight of them altogether. These non-bonding electrons can be thought of as being localized on each of the N atoms. The four 1s electrons are low-energy inner shell electrons that are not involved in the chemistry of N_2 , while the four 2s electrons provide the non-bonded lone pairs located one on each N atom. In the structure shown here we have drawn them in: you don't have to draw lone pairs of every molecule that has them, but sometimes it can be useful to emphasize them—for example if they are taking part in a reaction scheme.

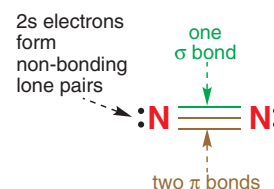

Bonds between different atoms

Up to now we have only considered combining two atoms of the same element, which makes things simpler because the same orbitals on each of the two atoms have the same energy. But when the two atoms are different two things change. The first is obvious—the number of electrons contributed by each atom is different. This is easy to accommodate since it just affects the total number of electrons we need to put into the MO diagram when we fill up the energy levels. So, for example, if you were constructing an MO diagram for NO, the gas nitric oxide (NO, a rather remarkable biological messenger in the human body) rather than N_2 , you simply put in a total of 15 rather than 14 electrons because O contributes eight electrons and N seven.

Nitric oxide, NO

Nitric oxide was for a long time known only as one of the villains of urban air pollution, being formed during the combustion of petroleum and other fossil fuels. In the last 20 years, however, it has become evident that it is much more than that—one unexpected role, which earned its discoverers the Nobel Prize in physiology in 1998, is as a biological messenger, managing the contraction of smooth vessels and hence regulating blood flow.

The second thing that changes when you have two different atoms bonded together is the relative energies of the AOs being combined. It may seem natural to assume that a 2p orbital has the same energy whatever atom it finds itself in, but of course the difference is that an electron in a 2p (or any other) orbital feels an attraction to the nucleus which depends on the nuclear charge. The greater the number of protons in the nucleus, the greater the attraction, and hence the more tightly held, more stable, and lower in energy the electron becomes.

This is the origin of *electronegativity*. The more electronegative an atom is, the more it attracts electrons, the lower in energy are its AOs, and so any electrons in them are held more tightly.

Electronegativity *increases* across each row but *decreases* down each column even though the nuclear charge increases. This is because once electrons start filling a new shell they are shielded from the nucleus by all the electrons in the lower energy filled shells. You can find more detailed information in an inorganic chemistry textbook.

As you move across each row of the periodic table, therefore, electronegativity increases as the energy of each orbital drops. From Li (electronegativity 0.98) across to C (2.55), and on to N (3.04), O (3.44), and F (3.98), the elements steadily become more electronegative and the AOs lower in energy.

So our diagram of the orbitals of NO actually looks like this.

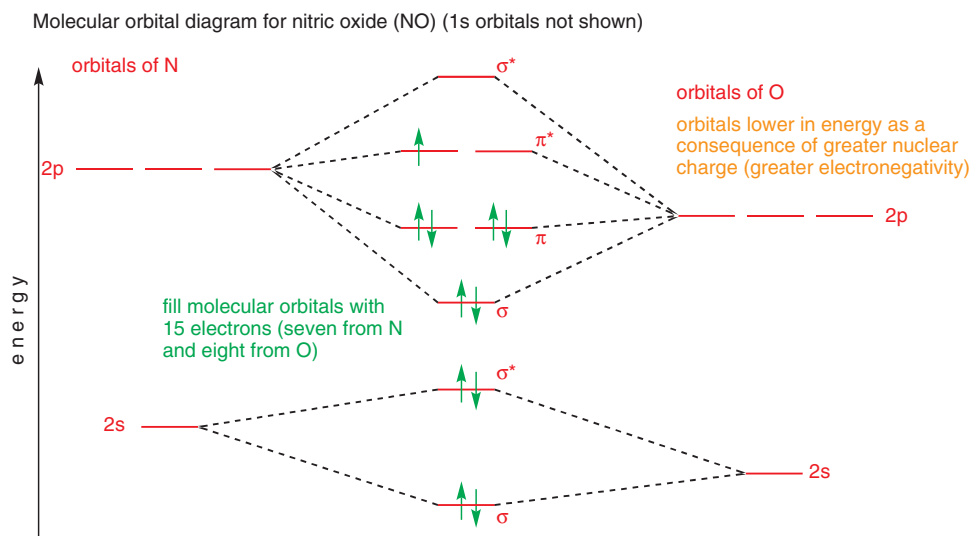

■ We have here the beginnings of an explanation for both the structure and reactivity of polarized bonds. In Chapter 6 we will revisit the idea that a carbonyl C=O bond is polarized towards O, but that the asymmetry of the antibonding π^* orbital leads to attack on the C=O group at C.

We have shown only the 2s and 2p orbitals as the 1s orbitals are much lower in energy, and as you saw in the diagram of N_2 on p. 94 their bonding and antibonding interactions cancel each other out.

The orbitals on O are lower in energy than the orbitals on N, but they still interact just fine. However, there is one interesting consequence: if you look at each bonding orbital, you will see that it is closer in energy to the contributing orbital on O than the contributing orbital on N. Likewise, each antibonding orbital is closer in energy to the contributing orbital on N than the contributing orbital on O. The result is that the MOs are unsymmetrical, and while all the bonding orbitals have a greater contribution from the oxygen AOs, all the antibonding orbitals have a greater contribution from the nitrogen AOs. Overall the diagram shows eight electrons in bonding orbitals and three electrons in antibonding orbitals, so the overall electron distribution is skewed (polarized) towards O, just as you would expect from a comparison of the electronegativities of N and O.

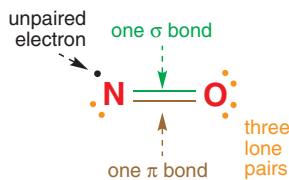

The eight electrons in bonding orbitals and three electrons in antibonding orbitals means that NO has a bond order of $2\frac{1}{2}$. It also has an unpaired electron—it is a radical. We can't easily represent half a bond in valence bond terms, so we usually draw NO with a double bond, representing four bonding electrons. The remaining seven electrons can be shown as three lone pairs and one unpaired electron. Where do we put them? Well, our MO diagram tells us that the unpaired electron occupies an orbital closer in energy to N than to O, so we put that on N.

■ We haven't considered what happens in the second row of the periodic table yet, but it will come as no surprise to you to learn that the electronic structure of the elements of Na to Cl arises from filling 3s and 3p orbitals. You might like to think about what shape these orbitals have: a textbook on inorganic chemistry will tell you more.

N and O differ only slightly in electronegativity (electronegativity of N 3.04; O 3.44): their orbitals are quite close in energy and form stable covalent bonds. But we also need to consider what happens when two atoms forming a bond differ hugely in electronegativity. We can take sodium (electronegativity 0.93) and chlorine (electronegativity 3.16) as our example. We know from observation that the product of reacting these two elements (don't try this at home) is the ionic solid Na^+Cl^- , and the MO energy level diagram tells us why.

The AOs we need to consider are the 3s and 3p orbitals of Na (all its lower energy 1s, 2s, and 2p orbitals are filled, so we can ignore those, as we did with the 1s orbitals of N_2 and NO above) and the 3s and 3p orbitals of Cl (again, the 1s, 2s, and 2p orbitals are all filled). Here is the diagram, with the Na orbitals much higher in energy than the Cl orbitals.

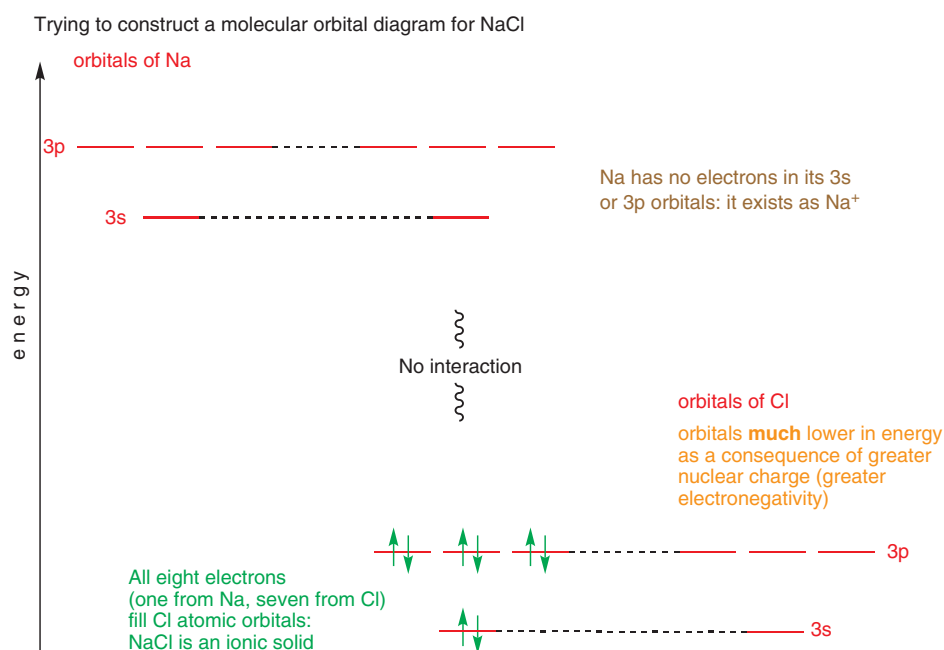

But these AOs are too far apart in energy to combine to form new MOs and no covalent bond is formed. The orbitals which get filled are simply the 3s and 3p orbitals of the Cl atom. The electrons available to fill these orbitals are the seven provided by Cl plus the one from Na: we end up with Na^+ and Cl^- . The ionic bonding in NaCl is due simply to the attraction between two oppositely charged ions—there is no orbital overlap.

These three different cases where the two combining orbitals differ greatly in energy, only a little, or not at all are summarized below.

Energies of AOs both the same	AO on atom B is a little lower in energy than AO on atom A	AO on atom B is a lot lower in energy than AO on atom A
large interaction between AOs	less interaction between AOs	AOs are too far apart in energy to interact
bonding MO much lower in energy than AOs	bonding MO is lowered by a small amount relative to AO on atom B	the filled orbital on the same energy as the AO on atom B
antibonding MO is much higher in energy than the AOs	antibonding MO is raised in energy by a small amount relative to AO on atom A	the empty orbital on the cation has same energy as the AO on atom A
both AOs contribute equally to the MOs	the AO on B contributes more to the bonding MO and the AO on A contributes more to the antibonding MO	Only one AO contributes to each MO
electrons in bonding MO are shared equally between the two atoms	electrons in bonding MO are shared between atoms but are associated more with B than A	electrons in the filled orbital are located only on atom B
bond between A and B would classically be described as purely covalent	bond between A and B is covalent but there is also some electrostatic (ionic) attraction between atoms	bond between A and B would classically be described as purely ionic
easiest to break bond into two radicals (homolytic fission)	easiest to break bond into two ions, A^+ and B^- , although it is also possible to give two radicals	compound already exists as ions A^+ and B^-
heterolytic fission of the bond is possible and could give either A^+ and B^- or A^- and B^+ (this point is discussed more fully in Chapters 24 and 37)		

Other factors affecting degree of orbital interaction

Having similar energies is not the only criterion for good interaction between two AOs. It also matters how the orbitals overlap. We have seen that p orbitals overlap better in an end-on fashion (forming a σ bond) than they do side-on (forming a π bond). Another factor is the size of the AOs. For best overlap, the orbitals should be the same size—a 2p orbital overlaps much better with another 2p orbital than it does with a 3p or 4p orbital.

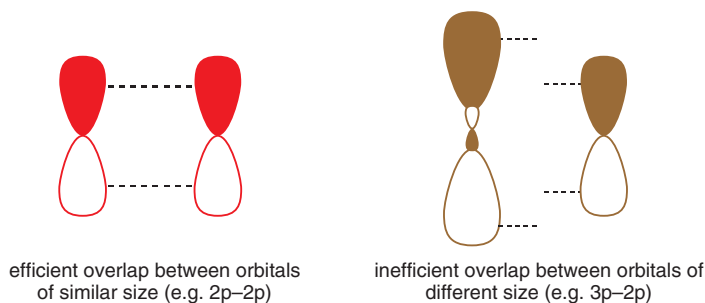

A third factor is the symmetry of the orbitals—two AOs must have the appropriate symmetry to combine. Thus a $2p_x$ orbital cannot combine with a $2p_y$ or $2p_z$ orbital since they are all perpendicular to each other (they are orthogonal). Depending on the alignment, there is either no overlap at all or any constructive overlap is cancelled out by equal amounts of destructive overlap. Likewise, an s orbital can overlap with a p orbital only end-on. Sideways overlap leads to equal amounts of bonding and antibonding interactions and no overall gain in energy.

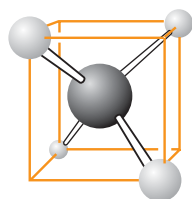
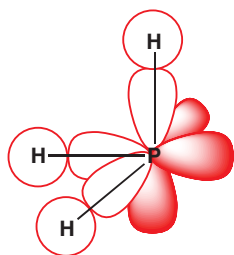
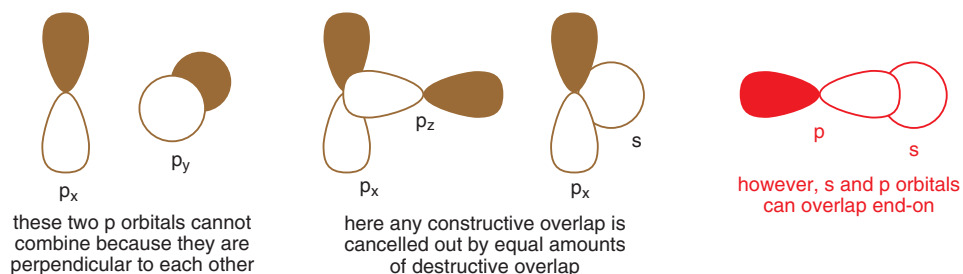

a molecule of methane enclosed in a cube

Molecular orbitals of molecules with more than two atoms

We now need to look at ways of combining more than two atoms at a time. For some molecules, such as H_2S and PH_3 , which have all bond angles equal to 90° , the bonding should be straightforward—the 3p orbitals (which are at 90°) on the central atom simply overlap with the 1s orbitals of the hydrogen atoms.

Now, you might imagine it would be similar for ammonia, NH_3 , since N lies above P in the periodic table. The trouble is, we know experimentally that the bond angles in ammonia, as in water and methane, are not 90° , but instead 104° , 107° , and 109° , respectively. All the covalent compounds of elements in the row Li to Ne raise this difficulty. How can we get 109° angles from orbitals arranged 90° apart?

To see what has to happen, we'll start with a molecule of methane enclosed in a cube. It is possible to do this since the opposite corners of a cube describe a perfect tetrahedron. The carbon atom is at the centre of the cube and the four hydrogen atoms are at four of the corners.

Now let's consider each of the carbon's 2s and 2p AOs in turn. The carbon's 2s orbital can overlap with all four hydrogen 1s orbitals at once with all the orbitals in the same phase.

Each of the 2p orbitals points to a pair of opposite faces of the cube. Once more all four hydrogen 1s orbitals can combine with each p orbital, provided the hydrogen AOs on the opposite faces of the cube are of opposite phases.

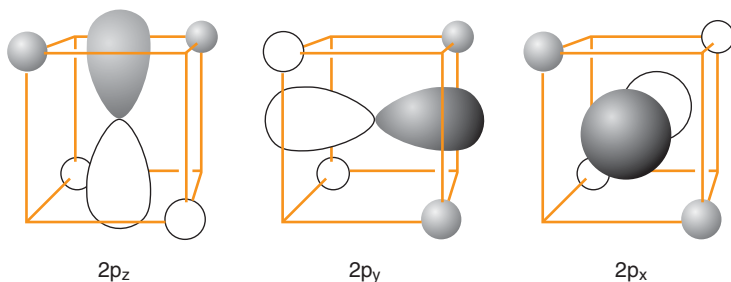

the hydrogen 1s orbitals can overlap with the three 2p orbitals

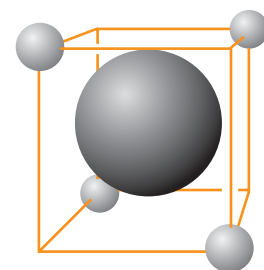

the carbon 2s AO can overlap
with all four hydrogen 1s
AOs at once

The three MOs generated in this way are degenerate, and this gives us four bonding orbitals. Along with four associated antibonding orbitals this gives us a total of eight MOs, which is correct since there were eight AOs (C gave us 2s and $3 \times 2p$, while $4 \times \text{H}$ gave us $4 \times 1s$).

Using this approach, it is possible to construct a complete MO picture of methane—and indeed for very much more complex molecules than methane. There is experimental evidence too that these pictures are correct. But the problem is this: the four filled, bonding orbitals of methane are *not* all the same (one came from the interaction with the C 2s orbital and three from the C 2p orbitals). But we also know from experimental observations all four C–H bonds in methane *are* the same.

Something seems to be wrong, but there is in fact no contradiction. The MO approach tells us that there is one MO of one kind and three of another but the electrons in them are shared out over all five atoms. No one hydrogen atom has more or fewer electrons than any other—they are all equivalent. Techniques that tell us the structure of methane do not tell us where bonds are; they simply tell us where the atoms are located in space—we draw in bonds connecting atoms together. Certainly the *atoms* form a regular tetrahedron but exactly where the electrons are is a different matter entirely. So, do we have to give up the idea that methane has four bonds, each made of two electrons, linking the C with an H? If we choose to, then for every reaction, even of the simplest molecules, we are going to need to calculate, by computer, a full set of MOs and all of their interactions.

That would be using physics to do chemistry. It might be accurate but it would kill creativity and invention. So here is an alternative: we keep our tried and tested practical picture of molecules made from discrete bonds, each containing a pair of electrons, but we make it compatible with MO theory. To do this we need a concept known as *hybridization*.

Hybridization of atomic orbitals

To get a picture of methane with four equivalent pairs of electrons we need to start with four equivalent AOs on C, which we don't have. But we can get them if we combine the carbon 2s and 2p orbitals first to make four new orbitals, each composed of one-quarter of the 2s orbital and three-quarters of one of the p orbitals. The new orbitals are called sp^3 (that's said *s-p-three*, not *s-p-cubed*) hybrid orbitals to show the proportions of the AOs in each. This process of mixing is called *hybridization*. The hybrid orbitals are mathematically equivalent to the 2s and 2p orbitals we started with, and they have the advantage that when we use them to make MOs the orbitals correspond to bonding pairs of electrons.

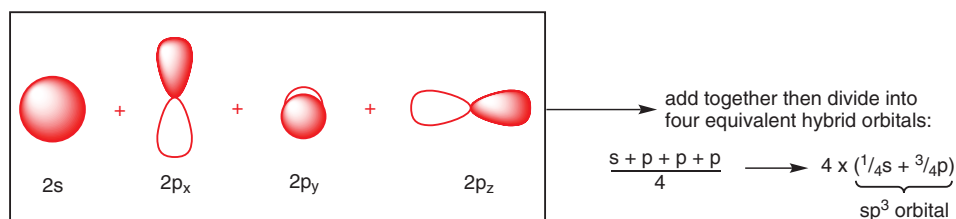

What do the four hybrid orbitals look like? Each sp^3 orbital takes three-quarters of its character from a p orbital and one-quarter from an s orbital. It has a planar node through the nucleus like a p orbital but one lobe is larger than the other because of the extra contribution of the 2s orbital: the symmetry of the 2s orbital means that adding it to a 2p orbital will increase the size of the wavefunction in one lobe, but decrease it in the other.

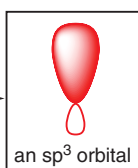
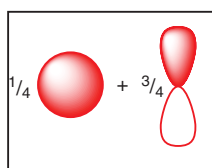
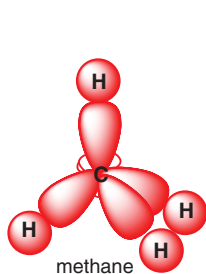

four sp^3 on one C atom point to the corners of a tetrahedron

The four sp^3 orbitals point to the corners of a tetrahedron and we build up a molecule of methane by overlapping the large lobe of each sp^3 orbital with the 1s orbital of a hydrogen atom, as shown in the margin. Each overlap forms an MO ($2sp^3 + 1s$) and we can put two electrons in each to form a C–H σ bond. There will of course also be an antibonding MO, σ^* ($2sp^3 - 1s$) in each case, but these orbitals are empty. Overall, the electrons are spatially distributed exactly as they were in our previous model, but now we can *think of them* as being located in four bonds.

Interactive bonding orbitals in methane

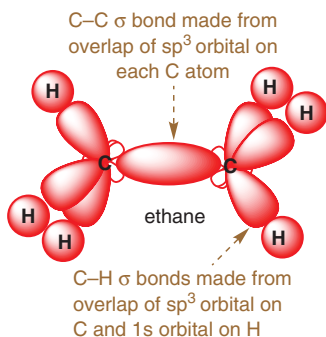
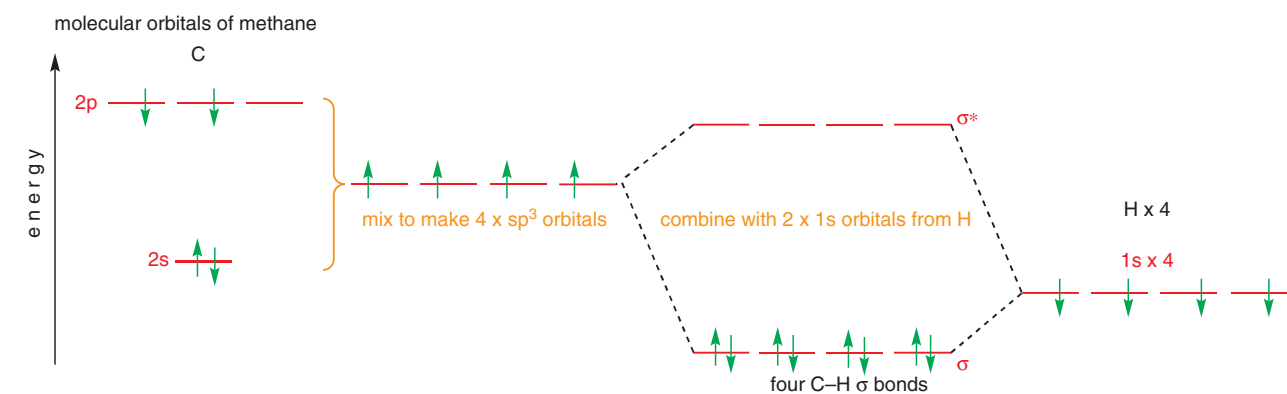

The great advantage of this method is that it can be used to build up structures of much larger molecules quickly and without having to imagine that the molecule is made up from isolated atoms. Take **ethane**, for example. Each carbon uses three sp^3 AOs orientated towards the three hydrogen atoms, leaving one sp^3 orbital on each carbon atom for the C–C bond.

In the MO energy level diagram we now have both C–H bonding σ and antibonding σ^* orbitals (made from combining sp^3 orbitals on C with 1s orbitals on H) and also a C–C bonding σ and antibonding σ^* orbital, made from two sp^3 orbitals on C. The diagram below just shows the C–C bond.

molecular orbitals of ethane (just C–C bond shown)

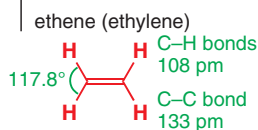
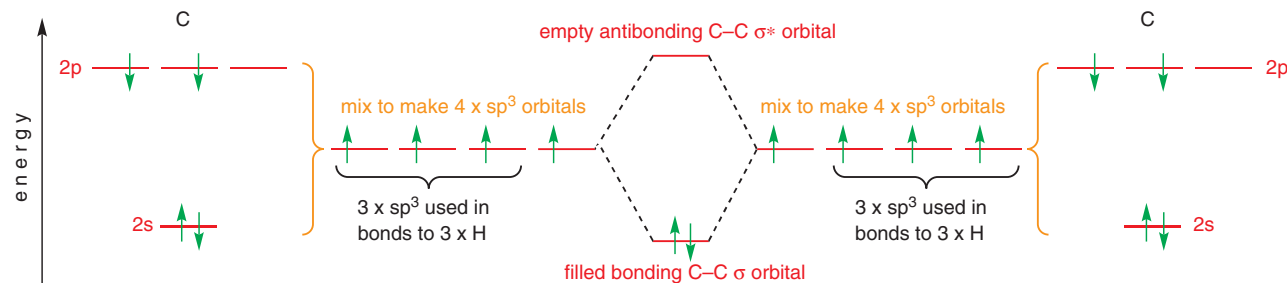

For **ethene** (ethylene), the simplest alkene, we need a new set of hybrid orbitals. Ethene is a planar molecule with bond angles close to 120° . Our approach will be to hybridize all the

orbitals needed for the C–H framework and see what is left over. In this case we need three equivalent bonds from each carbon atom (one to make a C–C bond and two to make C–H bonds). Therefore we need to combine the 2s orbital on each carbon atom with two p orbitals to make the three bonds. We could hybridize the 2s, 2p_y, and 2p_z orbitals (that is, all the AOs in the plane) to form three equal sp² orbitals, leaving the 2p_x orbital unchanged. These sp² hybrid orbitals will have one-third s character and only two-thirds p character.

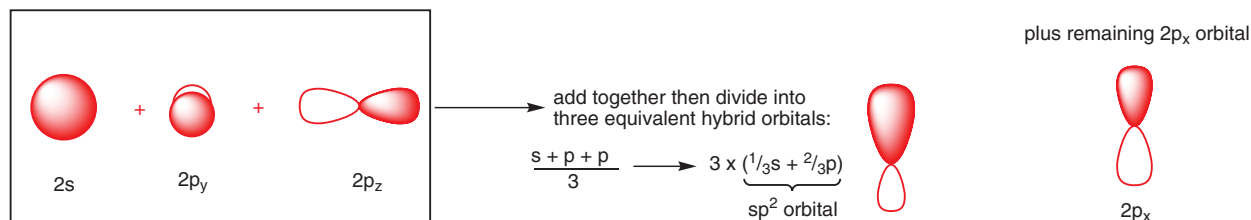

The three sp² hybrid AOs on each carbon atom can overlap with three other orbitals (two hydrogen 1s AOs and one sp² AO from the other carbon) to form three σ MOs. This leaves the two 2p_x orbitals, one on each carbon, which combine to form the π MO. The skeleton of the molecule has five σ bonds (one C–C and four C–H) in the plane and the central π bond is formed by two 2p_x orbitals above and below the plane.

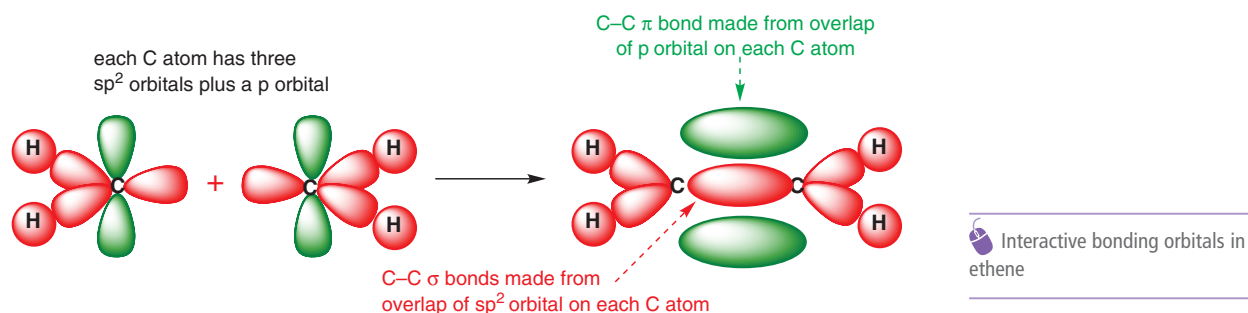

This is the first MO picture we have constructed with a C=C double bond, and it is worth taking the time to think about the energies of the orbitals involved. We'll again ignore the C–H bonds, which involve two of the sp² orbitals of each C atom. Remember, we mixed two of the three 2p orbitals in with the 2s orbital to make 3 × sp² orbitals on each C atom, leaving behind one unhybridized 2p orbital.

Now, first we need to generate the σ and σ* orbitals by interacting one sp² orbital on each atom. Then we need to deal with the two p orbitals, one on each C, which interact side-on. The unhybridized p orbitals are a bit higher in energy than the sp² orbitals, but they interact less well (we discussed this on p. 93) so they give a π orbital and a π* orbital whose energies are *in between* the σ and σ* orbitals. Each C atom donates two electrons to these orbitals (the other two electrons are involved in the two bonds to H), so the overall picture looks like this. Two AOs give two MOs.

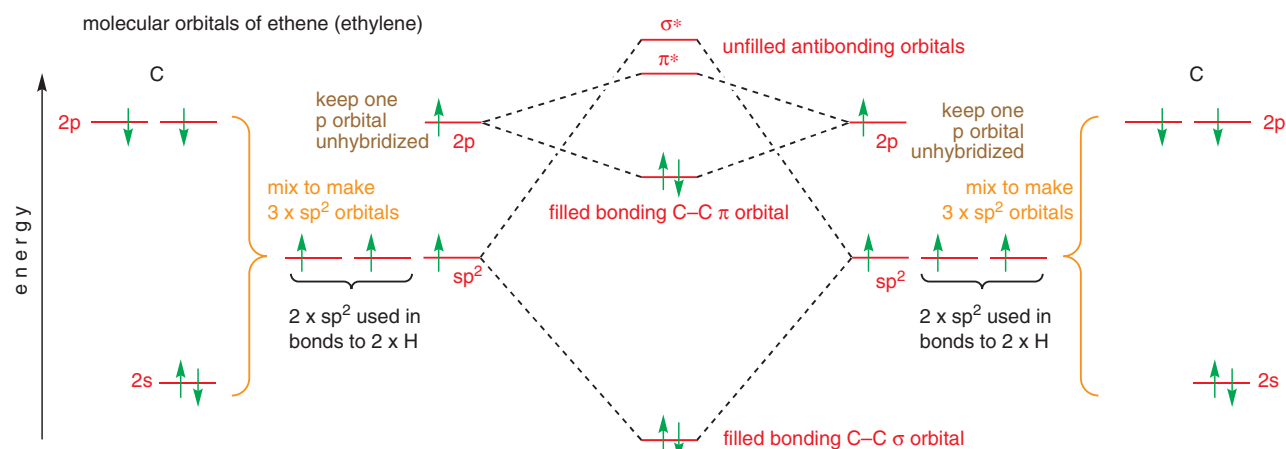

The fact that the sideways overlap of the p orbitals to form a π bond is not as effective as the head-on overlap of the orbitals to form a σ bond means that it takes less energy to break a C–C π bond than a C–C σ bond (about 260 kJ mol⁻¹ compared to about 350 kJ mol⁻¹).

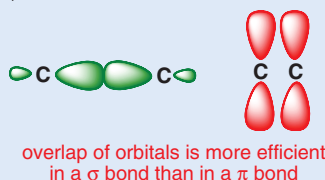

ethyne (acetylene)



Ethyne (acetylene) has a C≡C triple bond. Each carbon bonds to only two other atoms to form a linear CH skeleton. Only the carbon 2s and 2p_x have the right symmetry to bond to the two atoms at once so we can hybridize these to form two sp hybrids on each carbon atom, leaving the 2p_y and 2p_z to form π MOs with the 2p orbitals on the other carbon atom. These sp hybrids have 50% each s and p character and form a linear carbon skeleton.

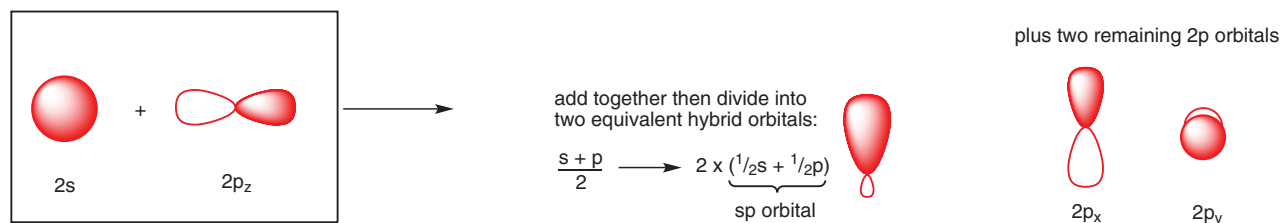

We could then form the MOs as shown below. Each sp hybrid AO overlaps with either a hydrogen 1s AO or with the sp orbital from the other carbon. The two sets of p orbitals combine to give two mutually perpendicular π MOs.

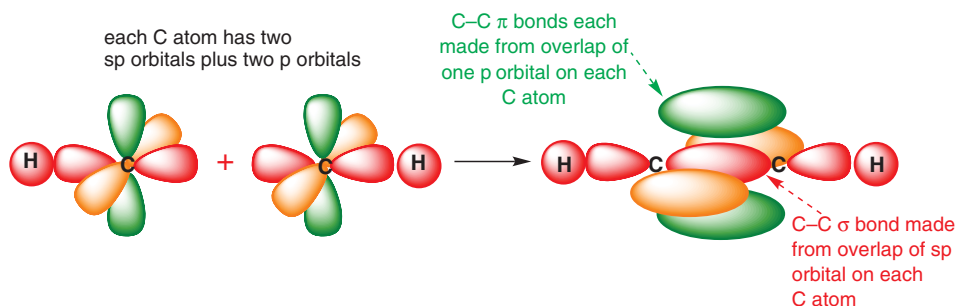

Interactive bonding orbitals in ethyne

Hydrocarbon skeletons are built up from tetrahedral (sp³), trigonal planar (sp²), or linear (sp) hybridized carbon atoms. Deciding what sort of hybridization any carbon atom has, and hence what sort of orbitals it will use to make bonds, is easy. All you have to do is count up the atoms bonded to each carbon atom. If there are two, that carbon atom is linear (sp hybridized), if there are three, that carbon atom is trigonal (sp² hybridized), and if there are four, that carbon atom is tetrahedral (sp³ hybridized). Since the remaining unhybridized p orbitals are used to make the π orbitals of double or triple bonds, you can also work out hybridization state just by counting up the number of π bonds at each carbon. Carbon atoms with no π bonds are tetrahedral (sp³ hybridized), those with one π bond are trigonal (sp² hybridized), and those with two π bonds are linear (sp hybridized).

There's a representative example on the left. This hydrocarbon (hex-5-en-2-yne) has two linear sp carbon atoms (C2 and C3), two trigonal sp² carbon atoms (C5 and C6), a tetrahedral sp³ CH₂ group in the middle of the chain (C4), and a tetrahedral sp³ methyl group (C1) at the end of the chain. We had no need to look at any AOs to deduce this—we needed only to count the bonds.

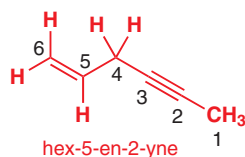

We can hybridize any atoms

We can use the same ideas with any sort of atom. The three molecules shown on the next page all have a tetrahedral structure, with four equivalent σ bonds from the central tetrahedral sp³

atom, whether this is B, C, or N, and the same total number of bonding electrons—the molecules are said to be **isoelectronic**. The atoms contribute different numbers of electrons so to get the eight bonding electrons we need we have to add one to BH_4 and subtract one from NH_4 —hence the charges in BH_4^- and NH_4^+ . In each case the central atom can be considered to be sp^3 hybridized, using an sp^3 orbital to bond to each of the four H atoms, each resulting σ bond being made up of two electrons.

Compounds of the same three elements with only three bonds take more thinking about. Borane, BH_3 , has only three pairs of bonding electrons (three from B and three from the three H atoms). Since the central boron atom bonds to only three other atoms we can therefore describe it as being sp^2 hybridized. Each of the B–H bonds results from the overlap of an sp^2 orbital with the hydrogen 1s orbital. Its remaining p orbital is not involved in bonding and must remain empty. Do not be tempted by the alternative structure with tetrahedral boron and an empty sp^3 orbital. You want to populate the lowest energy orbitals for greatest stability and sp^2 orbitals with their greater s character are lower in energy than sp^3 orbitals. Another way to put this is that, if you have to have an empty orbital, it is better to have one with the highest possible energy since it has no electrons in it and so it doesn't affect the stability of the molecule.

Borane is isoelectronic with the methyl cation, CH_3^+ or Me^+ . All the arguments we have just applied to borane also apply to Me^+ so it too is sp^2 hybridized with a vacant p orbital. This will be very important when we discuss the reactions of carbocations in Chapters 15 and 36.

Now what about ammonia, NH_3 ? Ammonia is *not* isoelectronic with borane and Me^+ ! It has a total of eight electrons—five from N and three from $3 \times \text{H}$. As well as three N–H bonds, each with two electrons, the central nitrogen atom also has a lone pair of electrons. We have a choice: either we could hybridize the nitrogen atom sp^2 and put the lone pair in the p orbital or we could hybridize the nitrogen sp^3 and have the lone pair in an sp^3 orbital.

This is the opposite of the situation with borane and Me^+ . The extra pair of electrons *does* contribute to the energy of ammonia so it prefers to be in the lower-energy orbital, sp^3 , rather than pure p. Experimentally the H–N–H bond angles are all 107.3° . Clearly, this is much closer to the 109.5° sp^3 angle than the 120° sp^2 angle. But the bond angles are not exactly 109.5° , so ammonia cannot be described as pure sp^3 hybridized. One way of looking at this is to say that the lone pair repels the bonds more than they repel each other. Alternatively, you could say that the orbital containing the lone pair must have slightly more s character while the N–H bonding orbitals must have correspondingly more p character.

The carbonyl group

The C=O double bond is the most important functional group in organic chemistry. It is present in aldehydes, ketones, acids, esters, amides, and so on. We shall spend several chapters discussing its chemistry so it is important that you understand its electronic structure from this early stage. We'll use the simplest carbonyl compound, methanal (formaldehyde), as our example. As in alkenes, the carbon atom needs three sp^2 orbitals to form σ bonds with the two H atoms and the O atom. But what about oxygen? It needs only to form one σ bond to C, but it needs two more hybrid orbitals for its lone pairs: the oxygen atom of a carbonyl group is also sp^2 hybridized. A p orbital from the carbon and one from the oxygen make up the π bond, which also contains two electrons. This is what the bonding looks like:

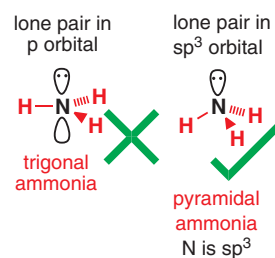
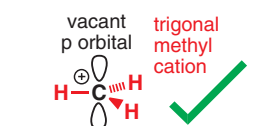
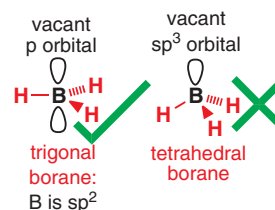
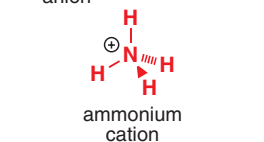
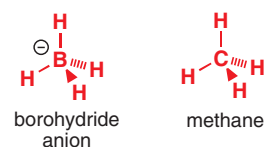
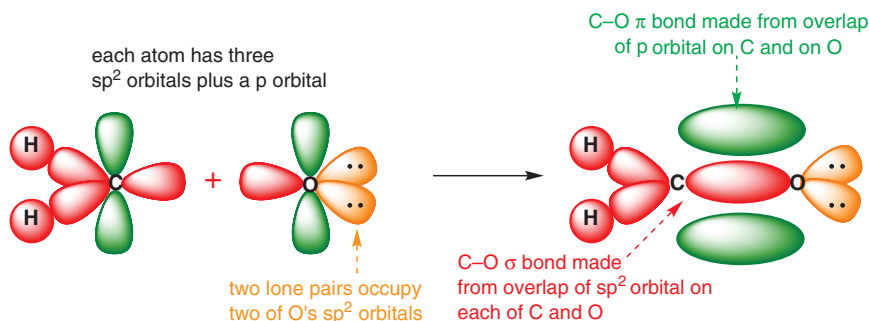

How do we know the O has its lone pairs in sp^2 orbitals? Well, whenever carbonyl compounds form bonds using those lone pairs—hydrogen bonds, for example—they prefer to do so in a direction corresponding to where the lone pairs are expected to be.

Interactive bonding orbitals in formaldehyde

For the MO energy diagram, we'll again just consider the bonding between C and O. First, we hybridize the orbitals of both atoms to give us the $3 \times sp^2$ orbitals and $1 \times p$ orbital we need. Notice that we have made the AOs at O lower in energy than the AOs at C because O is more electronegative. Once we have accounted for the non-bonding sp^2 orbitals at O and the two C–H bonds, we allow the two remaining sp^2 orbitals to interact and make a σ and a σ^* orbital, and the two p orbitals to make a π and a π^* orbital.

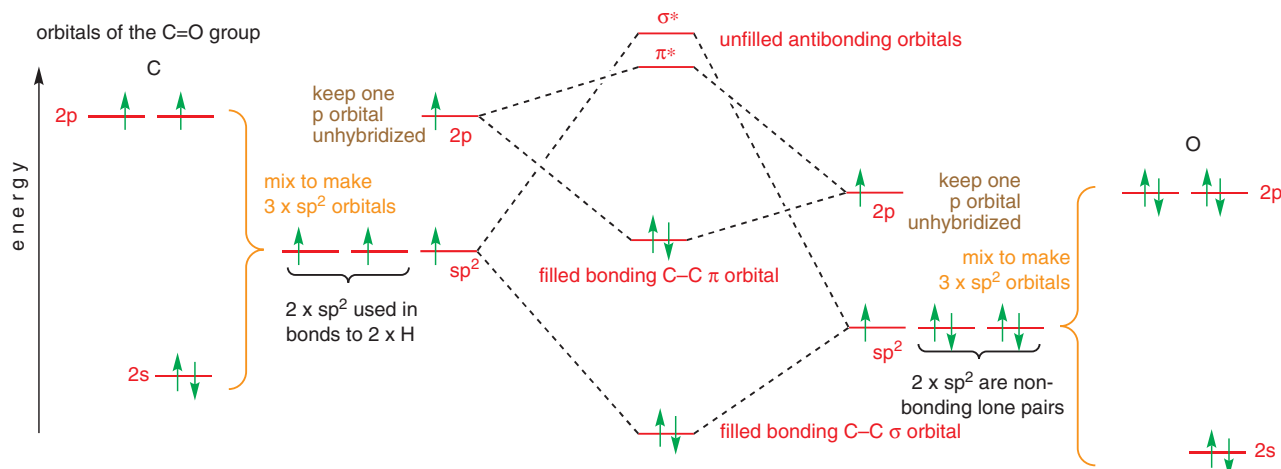

Alkenes have *nucleophilic* π bonds while carbonyl compounds have *electrophilic* π bonds. If you are not yet familiar with these terms, you will meet them in Chapter 5.

The fact that oxygen is more electronegative than carbon has two consequences for this diagram. Firstly it makes the energy of the orbitals of a C=O bond lower than they would be in the corresponding C=C bond. That has consequences for the reactivity of alkenes and carbonyl compounds, as you will see in the next chapter.

The second consequence is polarization. You met this idea before when we were looking at NO. Look at the filled π orbital in the MO energy level diagram. It is more similar in energy to the p orbital on O than the p orbital on C. We can interpret this by saying that it receives a *greater contribution* from the p orbital on O than from the p orbital on C. Consequently the orbital is distorted so that it is bigger at the O end than at the C end, and the electrons spend more time close to O. The same is true for the σ bond, and the consequent polarization of the C=O group can be represented by one of two symbols for a dipole—the arrow with the cross at the positive end or the pair of δ^+ and δ^- symbols.

➔ We will develop this idea in Chapter 6.

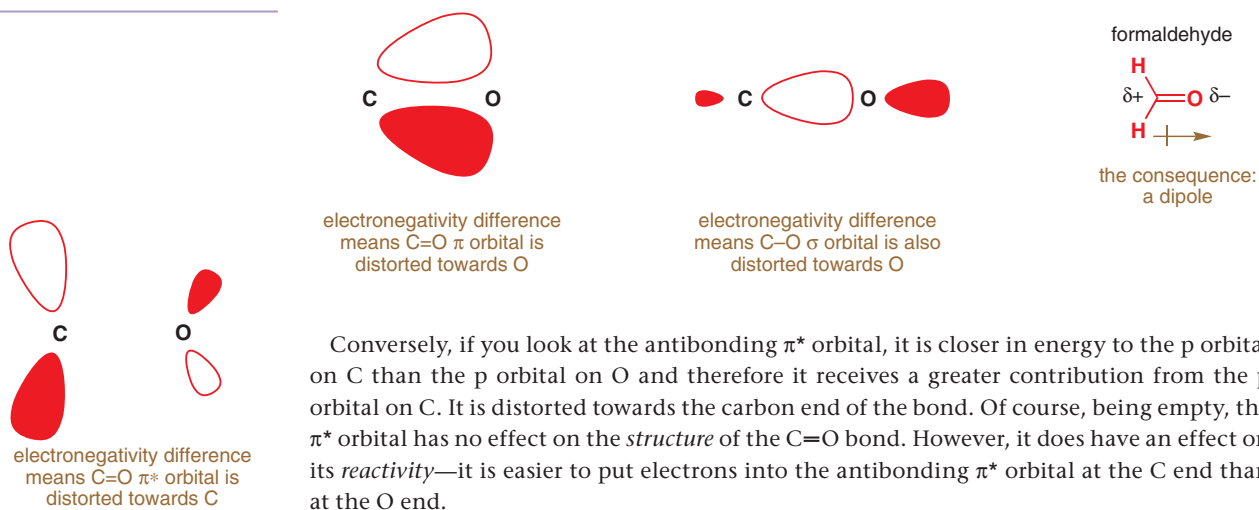

Conversely, if you look at the antibonding π^* orbital, it is closer in energy to the p orbital on C than the p orbital on O and therefore it receives a greater contribution from the p orbital on C. It is distorted towards the carbon end of the bond. Of course, being empty, the π^* orbital has no effect on the *structure* of the C=O bond. However, it does have an effect on its *reactivity*—it is easier to put electrons into the antibonding π^* orbital at the C end than at the O end.

Rotation and rigidity

To end this chapter, we deal with one more question which MOs allow us to answer: how flexible is a molecule? The answer depends on the molecule of course, but more importantly it depends on the type of bond. You may be aware that many alkenes can exist in two forms, *cis* and *trans*, also called *Z* and *E* (see Chapter 17). These two forms are not usually easy to interconvert—in other words the C=C double bond is very rigid and cannot rotate.

If we look at the bonding in but-2-ene we can see why. The π bond is made up of two parallel p orbitals. To rotate about the π bond requires those orbitals to lose their interaction, pass through a state in which they lie perpendicular, and finally line up again. That transitional, perpendicular state is very unfavourable because all of the energy gained through π bonding is lost. Alkenes are rigid and do not rotate.

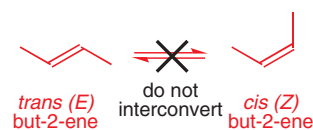
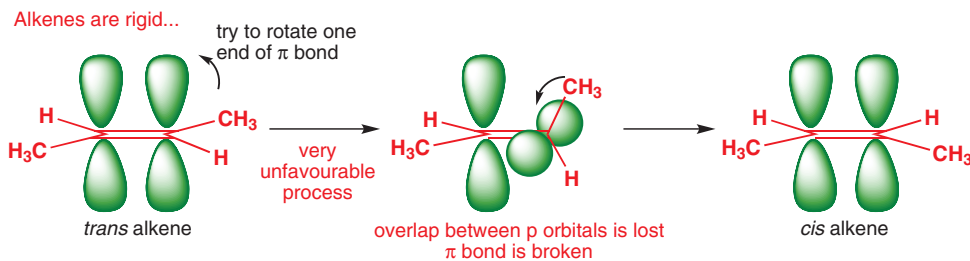

It is in fact possible to interconvert *cis* and *trans* alkenes, but it requires a considerable amount of energy—around 260 kJ mol⁻¹. One way to break the π bond is to promote an electron from the π orbital to the π^* orbital. If this were to happen, there would be one electron in the bonding π orbital and one in the antibonding π^* orbital, and hence no overall bonding. The energy required to do this corresponds to light in the ultraviolet (UV) region of the spectrum. Shining UV light on an alkene can break the π bond (but not the σ bond) and allows rotation to occur.

Alkene isomers

Maleic and fumaric acids were known in the nineteenth century to have the same chemical composition and the same functional groups, and yet they were different compounds—why remained a mystery. That is, until 1874 when van't Hoff proposed that free rotation about double bonds was restricted. This meant that, whenever each carbon atom of a double bond had two different substituents, isomers would be possible. He proposed the terms *cis* (Latin meaning 'on this side') and *trans* (Latin meaning 'across or on the other side') for the two isomers. The problem was: which isomer was which? On heating, maleic acid readily loses water to become maleic anhydride so this isomer must have both acid groups on the same side of the double bond.

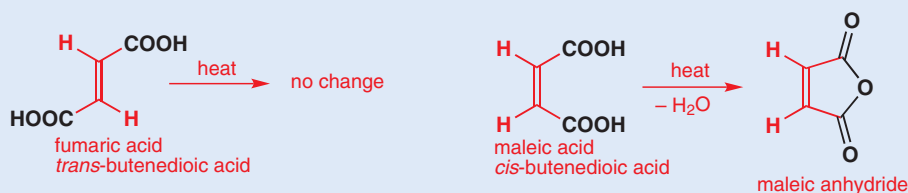

Compare that situation with butane. Rotating about the middle bond doesn't break any bonds because the σ bond is, by definition, cylindrically symmetrical. Atoms connected only by a σ bond are therefore considered to be rotationally free, and the two ends of butane can spin relative to one another.

Alkanes rotate freely...

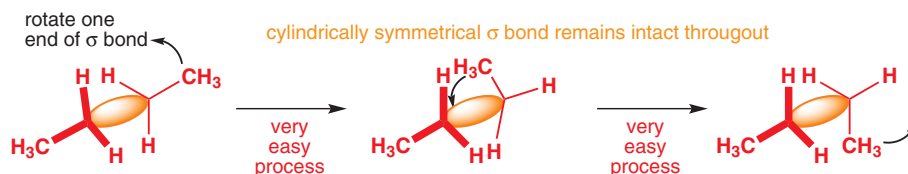

The same comparison works for ethylene (ethene) and ethane: in ethylene all the atoms lie in a plane, enforced by the need for overlap between the p orbitals. But in ethane, the two ends of the molecule spin freely. This difference in rigidity has important consequences throughout chemistry, and we will come back to it in more detail in Chapter 16.

■ In fact not all orientations about a σ bond are equally favourable. We come back to this aspect of structure, known as *conformation*, in Chapter 16.

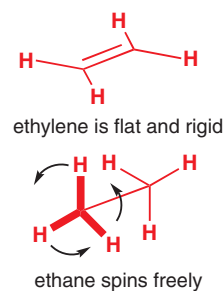

Conclusion

We have barely touched the enormous variety of molecules, but it is important that you realize at this point that these simple ideas of structural assembly can be applied to the most complicated molecules known. We can use AOs and combine them into MOs to solve the structure of very small molecules and to deduce the structures of small parts of much larger molecules. With the additional concept of conjugation in Chapter 7 you will be able to grasp the structure of any organic compound. From now on we shall use terms like AO and MO, 2p orbital, sp^2 hybridization, σ bond, energy level, and populated orbital without further explanation. If you are unsure about any of them, refer back to this chapter.

Looking forward

We started the chapter with atomic orbitals, which we combined into molecular orbitals. But what happens when the orbitals of *two molecules* interact? This is what happens during chemical reactions, and it's where we are heading in the next chapter.

Further reading

An excellent introduction to orbitals and bonding is *Molecular Orbitals and Organic Chemical Reactions: Student Edition* by Ian Fleming, Wiley, Chichester, 2009.

Check your understanding



To check that you have mastered the concepts presented in this chapter, attempt the problems that are available in the book's Online Resource Centre at <http://www.oxfordtextbooks.co.uk/orc/clayden2e/>

Organic reactions

Connections

➔ Building on

- Drawing molecules realistically **ch2**
- Ascertaining molecular structure spectroscopically **ch3**
- What determines molecular shape and structure **ch4**

Arriving at

- Why molecules generally *don't* react with each other
- Why sometimes molecules do react with each other
- How molecular shape and structure determine reactivity
- In chemical reactions electrons move from full to empty orbitals
- Identifying nucleophiles and electrophiles
- Representing the movement of electrons in reactions by curly arrows

➔ Looking forward to

- Reactions of the carbonyl group **ch6**
- The rest of the chapters in this book

Chemical reactions

Most molecules are at peace with themselves. Bottles of sulfuric acid, sodium hydroxide, water, or acetone can be safely stored in a laboratory cupboard for years without any change in the chemical composition of the molecules inside. Yet if these compounds are mixed, chemical reactions, in some cases vigorous ones, will occur. This chapter is an introduction to the behaviour of organic molecules: why some react together and some don't, and how to understand reactivity in terms of charges, orbitals, and the movement of electrons. We shall also be introducing a device for representing the detailed movement of electrons—the mechanism of the reaction—called the *curly arrow*.

To understand organic chemistry you need to be fluent in two languages. The first is the language of **structure**: of atoms, bonds, and orbitals. This language was the concern of the last three chapters: in Chapter 2 we looked at how to draw structures, in Chapter 3 how to find out what those structures are, and in Chapter 4 how to explain structure using electrons in orbitals.

But now we need to take up a second language: that of **reactivity**. Chemistry is first and foremost about the *dynamic* features of molecules—how to create new molecules from old ones, for example. To understand this we need new terminology and tools for explaining, predicting, and talking about **reactions**.

Molecules react because they move. Atoms have (limited) movement within molecules—you saw in Chapter 3 how the stretching and bending of bonds can be detected by infrared spectroscopy, and we explained in Chapter 4 how the σ bonds of alkanes (but not the π bonds of alkenes) rotate freely. On top of that, in a liquid or a gas whole molecules move around continuously. They bump into each other, into the walls of the container, maybe into solvent

Marcellin Berthelot (1827–1907) pointed out in 1860 that 'chemistry's creative capability, resembling that of art itself, distinguishes it from the natural and historical sciences'.

in a solution. It is all this incessant motion which drives reactions, and we first need to look at what happens when molecules collide.

Not all collisions between molecules lead to chemical change

Molecules are coated with a layer of electrons which occupy bonding and maybe non-bonding orbitals. As a result the surface of each molecule is negatively charged and by and large molecules repel each other. Reactions can occur only if a pair of molecules have enough energy to overcome this superficial repulsion. If they don't, they will simply bounce off one another like two balls in pool or snooker, exchanging energy and moving off with new velocities, but remaining chemically unchanged. That minimum energy requirement for reaction—a barrier over which molecules must pass if they are to react—is known as the **activation energy**. In any sample of a compound, the molecules will have a range of energies, but at least some must have more than the activation energy if they are to react.

➔ We'll discuss this more in Chapter 12.

Charge attraction brings molecules together

If you mix a solution of sodium chloride with a solution of silver nitrate, electrostatic attraction between the Ag^+ cations and Cl^- anions is enough to bring them together into a stable, crystalline ionic lattice of silver chloride, which precipitates from solution. Both ions are of course surrounded by electrons, but the deficit of negative charge in the Ag^+ cation (one electron short of the full Ag complement of 47) is enough to overcome the repulsion between the rest of the electrons.

Direct reaction of a cation and an anion is rare with organic molecules because there are relatively few stable organic anions, and even fewer stable organic cations. A more common cause of organic reactions is attraction between a charged reagent (a cation or anion) and an organic compound that both possess a **dipole**. An example that we shall explore in this chapter (and which decorates the cover of this book) is the reaction between a carbonyl compound such as formaldehyde (methanal) and one of those few stable organic anions, cyanide ($-\text{CN}$, in the form of its salt NaCN). The carbonyl group of formaldehyde is polarized because oxygen is more electronegative than carbon (see p. 103). The negative cyanide ion is attracted to the positive end of the carbonyl group dipole.

Actually, it isn't necessary for *either* reagent to be charged. Water also reacts with formaldehyde and this time it is the **lone pair** of electrons—the non-bonding pair of electrons located on the oxygen atom of the uncharged water molecule—that is attracted to the positive end of the carbonyl dipole.

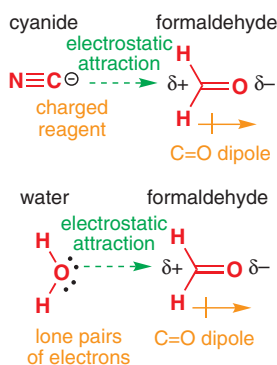

Orbital overlap brings molecules together

Charges and dipoles can help bring molecules together for reaction, helping them to overcome their electronic repulsion and lowering their activation energy. But reactions can still take place even between completely uncharged molecules with no dipole, provided their molecular orbitals can interact. One of the old 'tests' for unsaturation was to treat a compound with bromine water. If the brown colour disappeared, the molecule was unsaturated (contained double bonds). Spectroscopy means we rarely need to use such tests now, but the reaction is still an important one. An alkene reacts with bromine, even though the alkene and the bromine molecule have neither charge nor dipole. The attraction between these molecules is not electrostatic; instead, their electronic repulsion is overcome because the bromine molecule has an empty orbital available—the σ^* orbital of the $\text{Br}-\text{Br}$ bond—which can accept electrons from the alkene. Unlike the repulsive interaction between filled orbitals, the interaction between a filled and an unfilled orbital can lead to attraction and reaction.

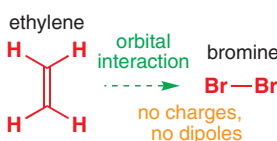

In fact, orbital interactions are also involved in the other two reactions on this page, but in those cases the orbital interactions are augmented by electrostatic attraction.

● **To summarize the situation:**

- In general, molecules repel each other, and need to overcome a barrier with a minimum amount of *activation energy* in order to react.
- Most organic reactions involve interactions between full and empty orbitals.
- Many, but not all, also involve charge interactions, which help overcome electronic repulsion.
- Some ionic reactions involve nothing but charge attraction.

We don't need to analyse whether *charge* or *orbital interaction* is the most important factor in bringing molecules together, but you do need to be aware that both may be involved to varying degrees.

Reactions happen when electrons flow between molecules

When, as a result of these interactions, a pair of molecules find themselves close together, a reaction can take place provided electrons move from one molecule to another. This is what we call the **mechanism of the reaction**—the detailed description of the pathway the electrons take. In most organic reactions, the electrons start in one molecule and move towards another. We call the molecule that accepts the electrons the **electrophile** (electron-lover) for obvious reasons. The molecule that donates the electrons is called the **nucleophile**.

● **A bond forms when electrons move from a nucleophile to an electrophile:**

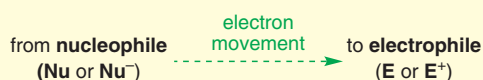

The nucleophile donates electrons.

The electrophile accepts electrons.

Here's a very simple example where the nucleophile is an anion (Cl⁻) and the electrophile is a cation (H⁺). The two are brought together by charge attraction, and the new bond is formed by electrons donated by the nucleophile. Since we are representing the formation of a new bond by the movement of electrons, it's natural to use an arrow to show the way the electrons flow. Arrows used to show electron flow are always curved: we call them 'curly arrows'. The arrow showing the reaction itself is straight.



In the next example, neither the nucleophile (ammonia, NH₃) nor the electrophile (borane, BH₃) are charged, but they are drawn together by the interaction between the electrons of the non-bonding lone pair at N and the empty p orbital on B. Electrons flow from the nucleophile (NH₃) to the electrophile (BH₃) and a new bond is formed.

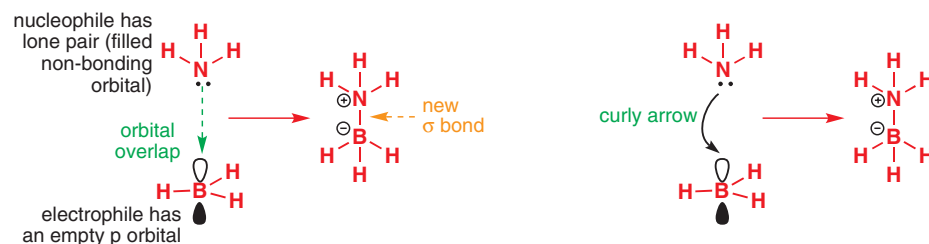

➔ Bonding in BH₃ and NH₃ was discussed on p. 103.

A 'dative covalent bond' is just an ordinary σ bond whose electrons happen to come from one atom. Most bonds are formed by electron donation from one atom to another and a classification that makes it necessary to know the history of the molecule is not useful. The only important distinction you need to make between types of covalent bonds is between σ bonds and π bonds.

The charges on the B and the N are necessary simply to account correctly for the electrons. Usually, we think of the pair of electrons in a bond as coming one from each of the bonded atoms. But here, since nitrogen donates both electrons (such bonds used to be called 'dative bonds') we have to account for the fact that boron ends up with one electron extra, and nitrogen one electron too few. The bond that forms is just a normal σ bond.

Orbital overlap is essential for successful reaction

In the reaction of ammonia with borane, not only do the molecules have to collide with enough energy to react, but they must also collide with the orbitals aligned correctly for them to interact. As you saw in Chapter 3, the lone pair of the nitrogen atom resides in a filled, non-bonding sp^3 orbital. This orbital has to overlap with the empty p orbital on B to form a bond. So, a collision like this

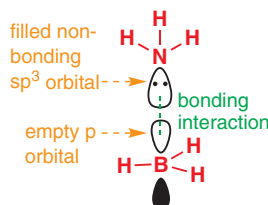

will do just fine for making a bond, but collisions like these

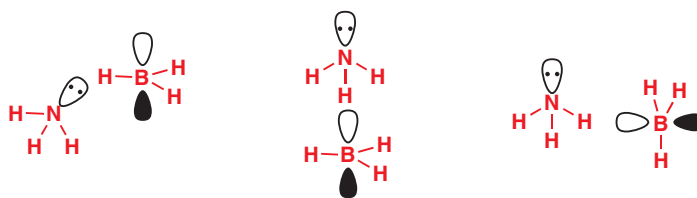

will not do at all.

Of course we can also draw a molecular orbital energy level diagram for the constructive, end-on interaction of the orbitals: look back to Chapter 4 to remind yourself of how to do this. Here, we need the filled sp^3 orbital on N to interact with the empty p orbital on B to give a new σ bonding orbital and an empty σ^* antibonding orbital. Finally, putting in the two electrons from the N's lone pair gives us a full picture of the new B–N bond.

■ We've ignored the N–H and B–H bonds as they are not involved in the reaction. The sp^3 orbital on N is lower in energy than the p orbital on B for two reasons—firstly it has more s-character and secondly N is more electronegative than B.

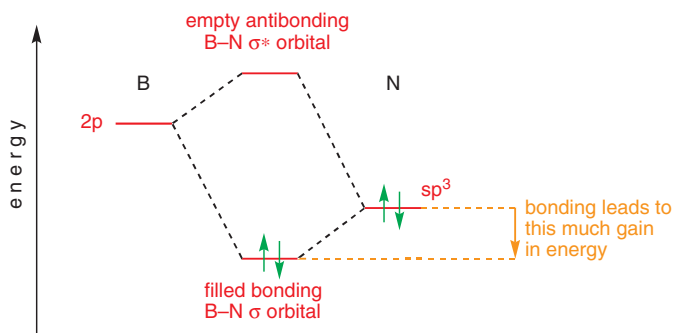

The energy level diagram makes it clear why bonding is favourable too: the electrons have dropped down from the non-bonding sp^3 orbital to the new lower energy bonding σ orbital. We don't need to consider what has happened to the energy of the unfilled orbitals because they're empty and don't contribute to the energy of the molecule as a whole.

We can generalize this idea to work out what makes a good nucleophile and a good electrophile. We'll use an imaginary, generic nucleophile Nu, with a pair of electrons in some sort of filled orbital (it doesn't matter what this orbital is) which it can donate to the empty orbital of a generic electrophile E. Here are three versions of the molecular orbital energy level diagram:

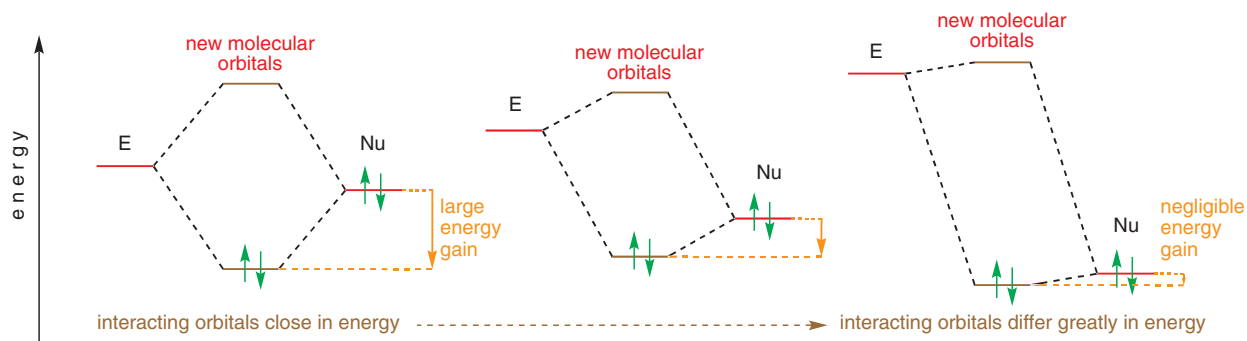

On the left, the energies of the filled Nu orbital and the empty E orbital are almost the same. There is a significant gain in energy when the new bond forms between them. On the right, there is a large difference between the energies of the filled Nu orbital and the empty E orbital, and the energy gain is negligible. This tells us something: **the best reactions are ones in which the energies of the interacting orbitals are similar in energy.**

● **For a reaction to take place, molecules must:**

- overcome their electronic repulsion by charge attraction and/or orbital overlap
- have orbitals of appropriate energy to interact—a filled orbital on the nucleophile and an empty orbital on the electrophile
- approach each other such that these orbitals can overlap to form a bonding interaction.

Nucleophiles and electrophiles

What does this mean for nucleophiles and electrophiles? Well, in general, filled orbitals tend to be low in energy—that is after all why they are filled! Conversely, empty orbitals tend to be high in energy. So the best interaction (the one that gains the new molecule the most energy) is likely to be between the highest in energy of all the filled orbitals—an orbital we can term the ‘highest occupied molecular orbital’ or HOMO for short—and the lowest in energy of all of the unoccupied orbitals—the ‘lowest unoccupied molecular orbital’ or LUMO for short. This diagram may help clarify this idea—it’s a repeat of the best interaction above (the one on the left), but with other orbitals sketched in.

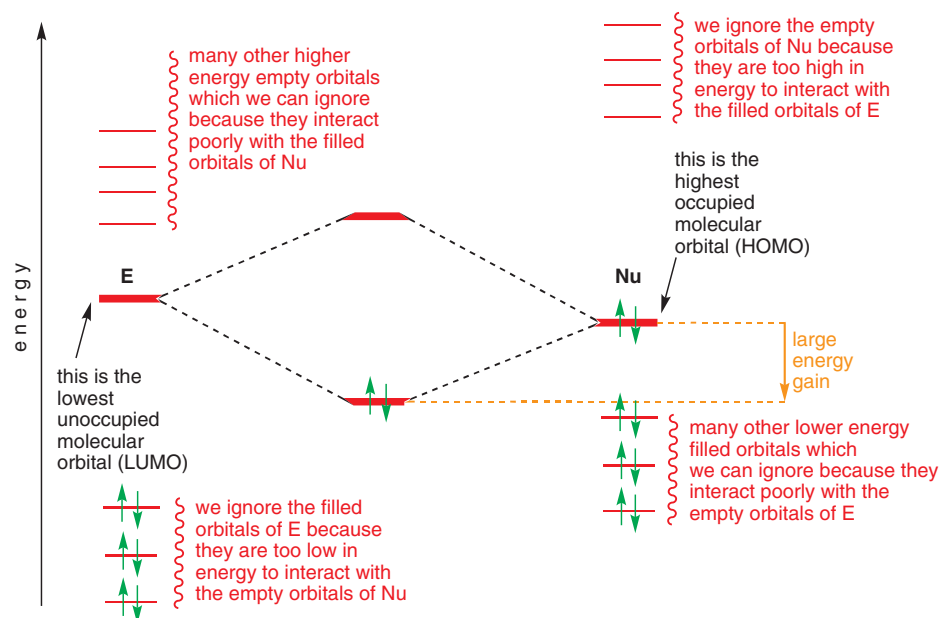

Remember, we can ignore all interactions between pairs of filled orbitals (bonding and antibonding cancel out, see p. 94) and pairs of unfilled orbitals (they don't contain electrons so don't contribute to the stability of the molecule). Of the interactions that are left, the one that gains the molecule the most energy is between the LUMO of the electrophile and the HOMO of the nucleophile. To make these orbitals as close as possible in energy, we want the nucleophile to have a high-energy HOMO and the electrophile to have a low-energy LUMO.

- The best nucleophiles have high-energy occupied molecular orbitals (HOMOs).
- The best electrophiles have low-energy unoccupied molecular orbitals (LUMOs).

The very first stage in understanding any reaction is to work out which of the reacting molecules is the nucleophile and which is the electrophile. It is impossible to stress too much how important it is to be able to identify nucleophiles and electrophiles correctly. For this reason we'll now conduct an identity parade of each class. We'll show you some of the top performing nucleophiles and top performing electrophiles, with a few comments on why they are so good at what they do, before we move on to see them in action.

Identifying a nucleophile

Nucleophiles are either negatively charged or neutral species with a pair of electrons in a high-energy orbital (the HOMO). The most common type of nucleophile has a non-bonding **lone pair of electrons**. Non-bonding electrons are typically high in energy because they do not benefit from the stabilization bonding electrons get from being shared between two nuclei. Typical neutral nucleophiles with lone pairs are ammonia, amines, water, and alcohols, all of which have lone pairs (one for N, two of equal energy for O) occupying sp^3 orbitals.

Other atoms later in the periodic table which carry lone pairs, such as phosphines, thiols, and sulfides, also make good nucleophiles, especially since their lone pairs are of even higher energy occupying orbitals made up of 3s and 3p atomic orbitals.

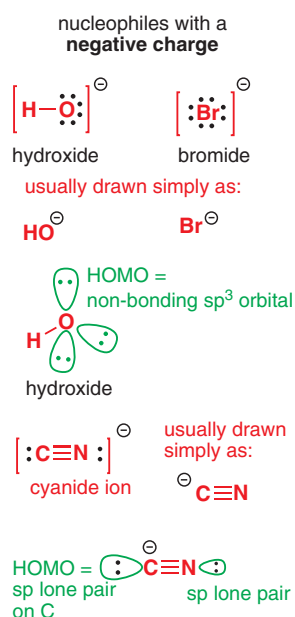
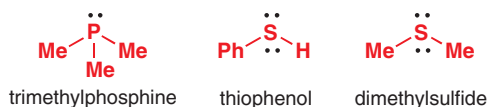
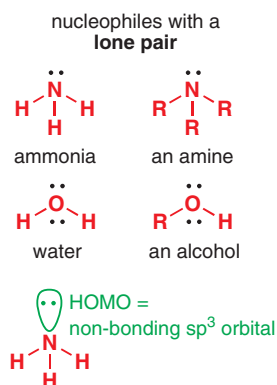

Anions which have lone pairs are often good nucleophiles too, partly because they can be attracted electrostatically by positively charged electrophiles. The anionic centre is usually O, S, or halogen, each of which can have several identical lone pairs. For example, hydroxide has three lone pairs—the negative charge cannot be assigned to one of them in particular. It's convenient just to draw the negative charge, and not the lone pairs as well. Negative charges like this actually represent a pair of electrons—both the 'extra' electron and its partner in the lone pair—so we normally write mechanisms with an arrow starting on the negative charge.

The most important *carbon* nucleophile with a lone pair of electrons is the cyanide ion. Although linear cyanide (which is isoelectronic with N_2) has a lone pair on nitrogen and a lone pair on carbon, the nucleophilic atom is usually anionic carbon rather than neutral nitrogen as the sp orbital on carbon is of higher energy than that on the more electronegative nitrogen, and therefore constitutes the HOMO.

Molecules can still be nucleophilic without non-bonding lone pairs. The next highest set of orbitals are **bonding π orbitals**, especially **C=C double bonds**, since they are higher in energy than σ orbitals (see p. 93). Simple alkenes are weakly nucleophilic and react with strong electrophiles such as bromine. Note, however, that molecules with π bonds can also be electrophiles, particularly when the π bond involves an electronegative atom. The only common π nucleophiles are alkenes and aromatic rings.

Finally, it is possible for the σ bond of a nucleophile to donate electrons, provided it is a σ **bond associated with electropositive atoms** such as B, Si, or the metals, along with C or H. You saw on p. 97 how the weak hold these atoms have over their electrons means that their atomic orbitals (and hence the molecular orbitals they contribute to) are high in energy. You met the borohydride anion BH_4^- in Chapter 4. Borohydride is a good nucleophile—it attacks electrophilic carbonyl compounds, as you will see shortly. It donates electrons from its HOMO, the B–H σ bond. Notice that in this case the negative charge does *not* represent a pair of electrons: you cannot start a curly arrow from it.

In later chapters you will see organometallics—compounds with carbon–metal bonds, for example methyl lithium—acting as nucleophiles. They do so because the σ orbital generated from electropositive C and even more electropositive Li is high in energy.

a nucleophile with a
C=C double bond

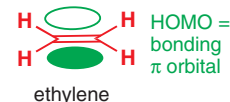

nucleophiles with a σ bond
between electropositive atoms

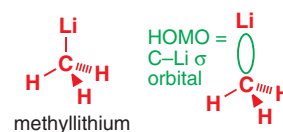
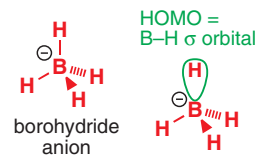

• **Nucleophiles donate electrons from available, high-energy orbitals represented by one of the following:**

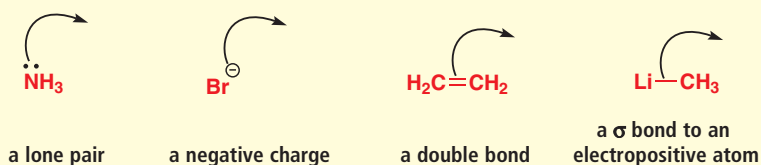

The curly arrows in the box above represent electron movement away from the nucleophile. But the electrons have to go somewhere: they are donated to an **electrophile**.

Identifying an electrophile

Electrophiles are neutral or positively charged species with an empty atomic orbital (such as the empty p orbital in borane) or a low-energy antibonding orbital that can easily accept electrons. The simplest electrophile is the hydrogen cation, H^+ , usually named for what it is, a proton. H^+ is a species without any electrons at all and a vacant, very low energy, 1s orbital. It is so reactive that it is hardly ever found and almost any nucleophile will react with it. Acid solutions containing H^+ are neutralized by the nucleophile hydroxide, for example, and strong acid goes on to protonate water as well, the water acting as a nucleophile and the proton as the electrophile. The product is the hydronium ion, H_3O^+ , the true acidic species in all aqueous strong acids. Here's the reaction between hydroxide and H^+ with the electron movement from the nucleophile to the electrophile represented by curly arrows. The arrows start on the hydroxide's negative charge, which represents one of the oxygen's pairs of electrons:

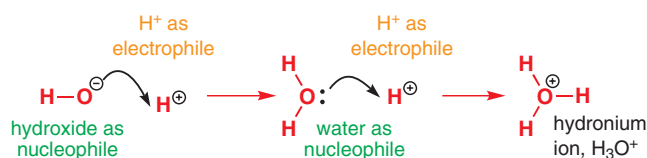

Other electrophiles with **empty atomic orbitals** include borane, which you met on p. 103, and related compounds such as boron trifluoride and aluminium trichloride. BF_3 reacts with ethers, as shown below, to form stable complexes. This time the arrow starts on the lone pair.

electrophiles with an
empty atomic orbital



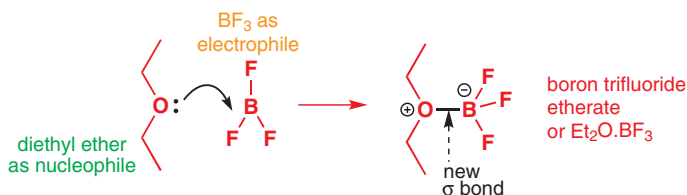
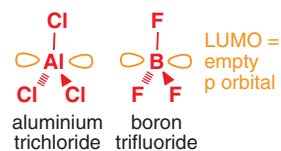

Few organic compounds have vacant atomic orbitals and in most organic electrophiles the LUMOs are instead **low-energy antibonding orbitals associated with electronegative atoms**. These antibonding orbitals can be either π^* orbitals or σ^* orbitals—in other words, molecules which make good electrophiles might have a double or a single bond to an electronegative atom such as O, N, Cl, or Br. It's important that an electronegative atom is involved in order to lower the energy of the orbital (see p. 96) and make it ready to accept electrons.

Carbon's place in the electronegativity scale

Here is a summary of electronegativities for atoms commonly involved in organic reactions.

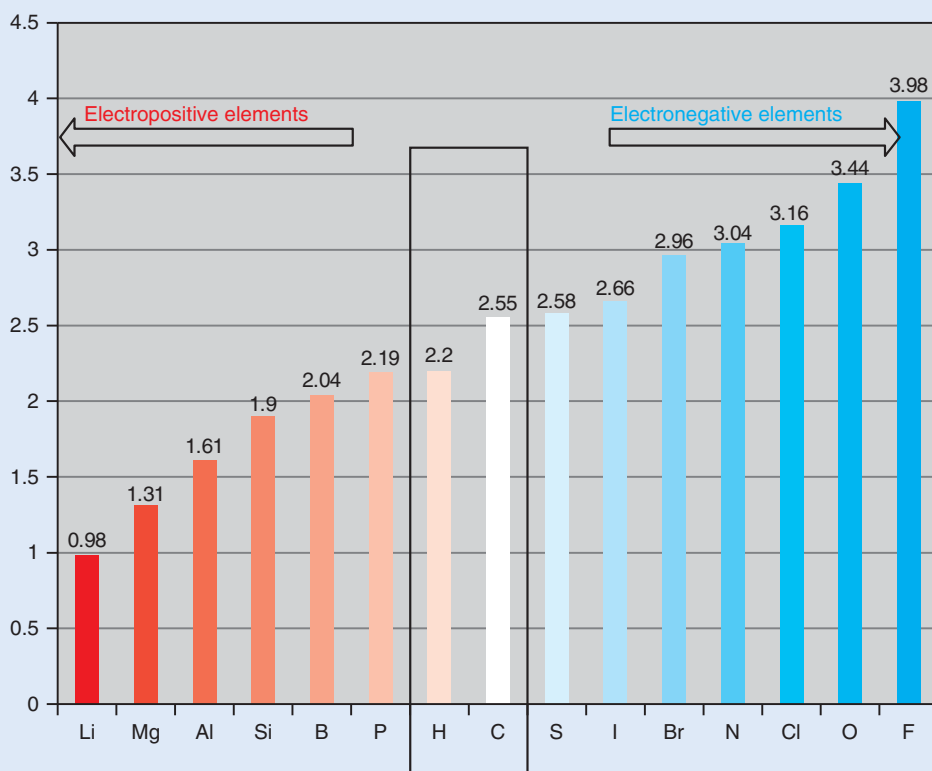

This bar chart makes it clear why carbon is just so special: it can form strong bonds to almost anything, especially itself. Elements at either end of the scale form weak bonds to similar elements (metal–metal bonds are weak, as are halogen–halogen or O–O bonds), but elements in the middle can form strong bonds to other elements at either end of the scale or elements in the middle. Being in the middle also gives C versatile reactivity: it is electrophilic when bonded to a more electronegative element and nucleophilic when bonded to a more nucleophilic element.

electrophiles with a double-bonded electronegative atom

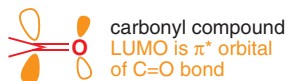

The most important molecules with a **double bond to an electronegative atom** are carbonyl compounds. In fact carbonyl groups are the most important functional groups in organic chemistry. We looked at their orbitals on p. 103 and we devote the next chapter, Chapter 6, to a detailed study of their reactivity. The low-energy π^* orbital is available to accept electrons, and its electrophilicity is further enhanced by the partial positive charge at carbon which arises from the C=O dipole. Here's an example of a carbonyl compound, acetone, reacting with an anionic nucleophile—we'll choose borohydride in this case. Notice

how the arrow does not start on the negative charge, as the charge does not represent a pair of electrons here.

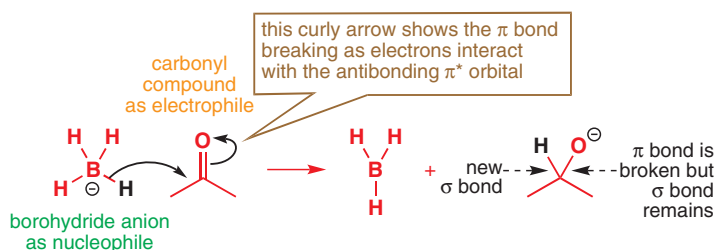

The arrows showing electron movement are a little more involved this time, but the explanation is straightforward. The first arrow shows the electrons moving from the nucleophile's HOMO (the B–H σ orbital) to the electrophile's LUMO (the C=O π^* orbital). The new feature in this mechanism is a second arrow showing the electrons moving from the double bond onto the oxygen atom. This is easy to explain. Since the reaction is putting electrons into an *antibonding* orbital (the π^*), a bond has to break. That breaking bond is the C=O π bond (the σ bond remains intact). The electrons in the bond have to go somewhere and they end up as an extra lone pair (represented by the negative charge) on oxygen. The product has a new C–H σ bond in place of the C=O π bond.

Molecules with a single bond to electronegative atoms can also make good electrophiles. In compounds such as HCl or CH₃Br, the σ^* orbital is low in energy because of the electronegative Cl or Br (see p. 95) and the dipole attracts the electrons of the nucleophile to the H or C atom.

Here's an example of hydrogen chloride acting as an electrophile with ammonia as the nucleophile. As with the carbonyl example above, we are putting electrons into an antibonding orbital, so a bond must break. This time the antibonding orbital is the H–Cl σ^* , so the bond which breaks is the H–Cl σ bond.

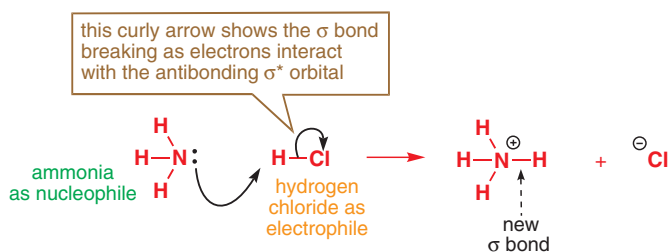

You may recognize this reaction, and the one on p. 113, as the reaction between a base and an acid. All acid–base reactions are reactions between a nucleophile (the base) and an electrophile (the acid). We call an electrophile an acid if it has an X–H bond (X being any atom) that loses H⁺ in its reactions. We call a nucleophile a base when it uses a lone pair to donate electrons to the X–H bond.

There is a little more to the definition of an acid, which we shall discuss in Chapter 8, where you will meet the term 'Lewis acid'.

Some σ bonds are electrophilic even though they have no dipole at all. The bonds in the halogens I₂, Br₂, and Cl₂ are a case in point. Bromine, for example, is strongly electrophilic because it has a weak Br–Br bond with a low energy σ^* orbital. Why is the σ^* low in energy? Well, bromine is slightly electronegative, but it is also large: it has to use 4s and 4p atomic orbitals for bonding, but these orbitals are large and diffuse, and overlap poorly, meaning the σ^* molecular orbital is not raised far in energy and can easily accept electrons. How different the situation is with a C–C bond: C–C single bonds are almost never electrophilic.

➔ We shall come back to this very important reaction at the beginning of Chapter 6.

■ In the carbonyl group, the C=O π bond breaks, rather than the σ bond, because the π^* is lower in energy than the σ^* orbital.

electrophiles with a **single bond to an electronegative atom**

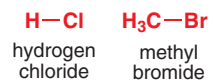

bonding in Br–Br

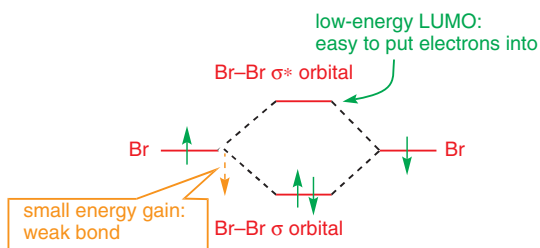
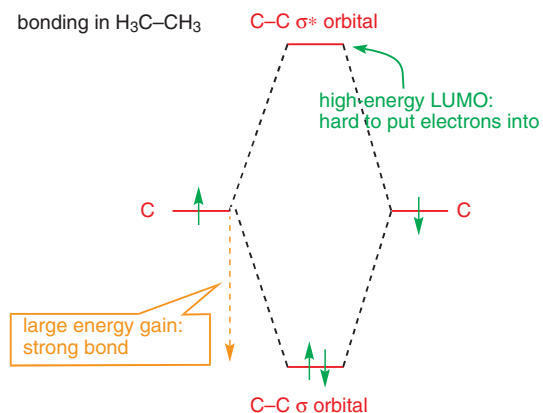
bonding in H₃C–CH₃

The unreactivity of C–C bonds is why we think of structures in terms of a hydrocarbon skeleton and functional groups: the hydrocarbon framework is made up of strong C–C bonds with unreactive low-energy filled and high-energy empty orbitals, while the functional groups tend to involve electronegative and electropositive atoms, which react because they contribute to more accessible low-energy LUMOs or high-energy HOMOs.

Bromine reacts with many nucleophiles, for example in the reaction shown below between a sulfide and bromine. Lone pair electrons are donated from sulfur into the Br–Br σ^* orbital, which makes a new bond between S and Br, and breaks the old Br–Br bond.

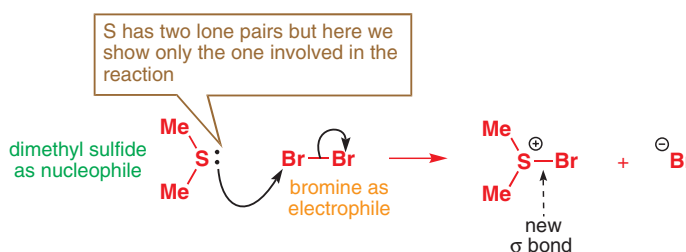

● **Electrophiles accept electrons into empty low-energy orbitals represented by one of the following:**



a positive charge representing an empty orbital

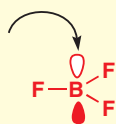

a neutral molecule with an empty p orbital



a double bond to an electronegative element

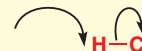

a single bond to an electronegative element

Curly arrows represent reaction mechanisms

You have now seen several examples of curly arrows representing the movement of electrons during a reaction, and it is time to discuss them in detail. It is no exaggeration to say that this simple device is the one most powerful tool chemists have for explaining simply and accurately how reactions work—in other words the mechanisms of reactions. Curly arrows are to reactions what structural diagrams are to molecules. We discussed the guidelines for drawing structures in Chapter 2, explaining that although the structure of a molecule may be very complex, a good structural diagram will represent all of its important features without unnecessary detail. Curly arrows are similar: you have seen how reactions involve the overlap and summation of molecular orbitals to make new molecular orbitals, and the movement of electrons within those orbitals. Curly arrows allow us to represent all the important features of those interactions and electron movements very simply, without being concerned with unnecessary detail. It's now time to outline some guidelines for writing mechanisms with curly arrows.

Curly arrows show the movement of electrons

A curly arrow represents the *movement of a pair of electrons* from a filled orbital into an empty orbital. You can think of the curly arrow as representing a pair of electrons thrown, like a

climber's grappling hook, across from where he is standing to where he wants to go. In the simplest cases, the result of this movement is to form a bond between a nucleophile and an electrophile. Here are two examples we have already seen in which lone pair electrons are transferred to empty atomic orbitals.

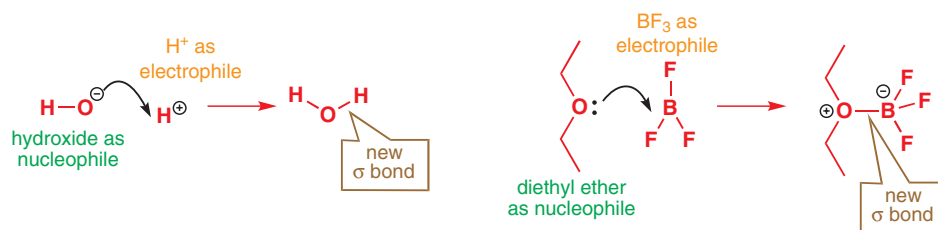

A curly arrow always starts with its tail resting on the symbol representing a pair of electrons in a filled orbital—in this case the lone pair or the negative charge (which actually represents a lone pair). The head of the arrow indicates the final destination of the pair of electrons—the new bond between oxygen and hydrogen or oxygen and boron in these examples. As we are forming a new bond, the head of the arrow should be drawn to a point somewhere on the line between the two atoms.

Why does a curly arrow represent two electrons? Well, as you saw in Chapter 4, it takes two electrons to make a bond, and in these two cases those electrons come from a lone pair. We use a different sort of arrow for movements of one electron, as you will see in Chapters 24 and 37.

When the nucleophile attacks an antibonding orbital, such as the weak Br–Br bond we have just been discussing, we need two arrows, one to make the new bond and one to break the old.

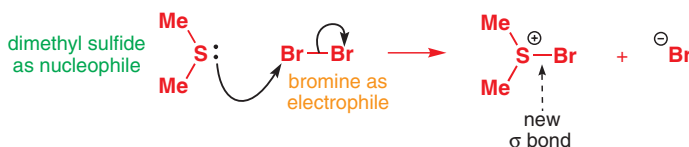

The bond-making arrow is the same as before—it starts on the nucleophile's lone pair and ends near the electrophile—but the bond-breaking arrow is new. This arrow shows that the two electrons in the bond move to one end (a bromine atom) and turn it into an anion. As always the arrow starts on something representing a pair of electrons in a filled orbital—the Br–Br σ bond. It should start in the centre of the bond and its head should rest on the atom (Br in this case) the electrons are heading for.

Another example is the attack of a base on the strong acid HBr.



It is not important how much curvature you put into the arrows—as long as they curl enough to distinguish them from straight reaction arrows, they can be as curly as you like. Neither does it matter whether they go to the left or the right, or whether they curve up or down as long as they begin and end in the right places. The mechanism below is just as correct:

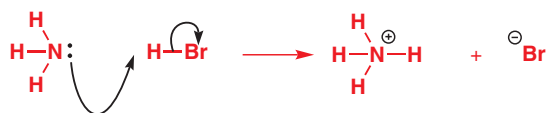

Some chemists prefer to place this point halfway between the atoms but we think it is clearer and more informative if the arrowhead is closer to the atom to which the new bond is forming. For these examples the difference is minimal and either method is completely clear, but in more complex situations our method prevents ambiguity, as we shall see later. We shall adopt this convention throughout this book: that the arrow ends close to the electrophile.

Notice that the final arrow ends up delivering the electrons to an electronegative atom, satisfying its desire for electron density. This is part of the reason why double or single bonds to electronegative atoms are often a feature of good electrophiles.

● **Curly arrows always start on something representing a pair of electrons:**

- a negative charge
- a lone pair
- or a bond

and end at the point those electrons are moving to.

Charge is conserved in each step of a reaction

Charge cannot be created or destroyed. If the starting materials have no overall charge, then neither must the products. In the last example above, it is obvious why the bromine becomes negatively charged—it takes both electrons from the bond even though only one of them formally ‘belongs’ to it. It may be less obvious to you why the ammonium cation has to have a positive charge, but it must, in order to maintain overall neutrality. One way to think about it is to note that both of the electrons in the new N–H bond come from N, so N is one electron down on the deal.

If the starting materials are charged, then the products must have, overall, the same charge. Here’s ammonia being protonated by H_3O^+ —both starting materials and products must have overall charge 1+.

H_3O^+ (the hydronium ion) is of course the electrophile here: it accepts electrons into the H–O σ^* . Why doesn’t this reaction happen though?

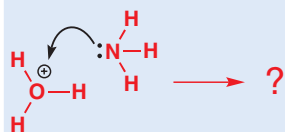

The answer is that the oxygen atom already has eight electrons—six from the three bonds to H and two from the other lone pair. It can’t receive any more unless one of those bonds breaks. The positive charge here does not represent an empty orbital in the way that H^+ has an empty orbital. H_3O^+ is electrophilic at H and not electrophilic at O.

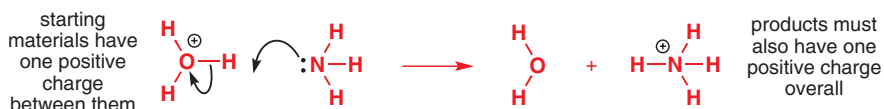

When it is a π bond that is being broken rather than a σ bond, only the π bond is broken and the σ bond should be left in place. This is what commonly happens when an electrophilic carbonyl group is attacked by a nucleophile. Just as in the breaking of a σ bond, start the arrow in the middle of the π bond and end by putting the arrowhead on the more electronegative atom, in this case oxygen rather than carbon.



In this case the starting materials had an overall negative charge and this is preserved in the anionic product. The charge disappears from the hydroxide ion because it is now sharing a pair of electrons with what was the carbonyl carbon atom and a charge appears on what was the carbonyl oxygen atom because it now has one of the electrons in the old π bond.

π bonds as nucleophiles

As you saw above, alkenes can be nucleophiles. The reaction of an alkene with HBr is a simple example: the C–C π bond is the HOMO of the nucleophile. The first arrow therefore starts in the middle of the π bond and goes into the gap between one of the carbon atoms and the hydrogen atom of HBr. The second arrow takes the electrons out of the H–Br σ bond and puts them onto the bromine atom to make bromide ion. Overall charge is conserved, so we must generate a positively charged species called a carbocation. The carbocation has a positive charge and an empty p orbital (you can count the electrons to make sure).

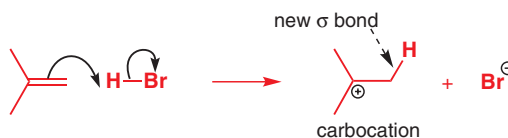

➔ We discussed the simplest carbocation, CH_3^+ , on p. 103.

■ We’ve drawn in the new C–H bond in the product to make it clear what has happened in the reaction: there are also two other C–H bonds at this C atom, which as usual we haven’t drawn in.

Notice that it was important to draw the two reagents in the right orientation since we need the arrow to show which end of the alkene reacts with which end of HBr. If we had aligned them differently we would have had trouble drawing the mechanism. Here is a less satisfactory representation, in which the H doesn't seem to transfer to the correct end of the alkene:



If you find yourself making an ambiguous drawing like this, it is worth having another go to see if you can be clearer. When the nucleophile is a π (or σ) bond rather than a lone pair or a charge there is always the question of which end of the bond actually reacts. One way to make this clear is to draw an *atom-specific curly arrow actually passing through* the atom that reacts. Something like this will do:

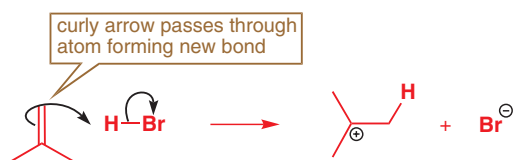

This reaction does not, in fact, stop here as the two ions produced now react with each other to form the product of the reaction. The anion is the nucleophile and the carbocation, with its empty p orbital, is the electrophile.



σ bonds as nucleophiles

When σ bonds act as nucleophiles, the electrons also have to go to one end of the σ bond as they form a new bond to the electrophile. We can return to an earlier example, the reaction of sodium borohydride (NaBH_4) with a carbonyl compound, and complete the mechanism. In this example, one of the atoms (the hydrogen atom) moves away from the rest of the BH_4^- anion and becomes bonded to the carbonyl compound. The LUMO of the electrophile is, of course, the π^* orbital of the $\text{C}=\text{O}$ double bond.



The arrow from the nucleophile should start in the middle of the bond that breaks and show which atom is transferred to the electrophile. You could use an atom-specific arrow if you wanted to make it absolutely clear that the electrons in the σ bond act as a nucleophile through the hydrogen and not through the boron atom:



The anion which forms is an intermediate, not the final product. The reaction is often carried out in water and the anion acts as a nucleophile to remove a proton from water. Water is the electrophile: its LUMO is the $\text{O}-\text{H}$ σ^* .

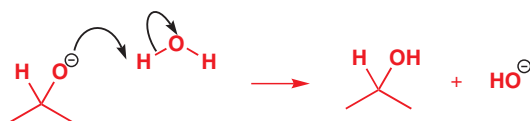

■ In Chapter 19 we will explain why the new $\text{C}-\text{H}$ bond forms at this end of the alkene.

■ Notice the contrast with the reaction of H_3O^+ above: unlike the O atom in H_3O^+ , the C atom in the carbocation has only six electrons and so can accept two more.

■ Remember (p. 115) you can't start a curly arrow on the negative charge of BH_4^- because it does not represent a lone pair: all eight electrons around the B atom are shown as the four $\text{B}-\text{H}$ bonds. This negative charge is conceptually similar to the positive charge of H_3O^+ , which does not represent an empty orbital. Contrast them with the negative charge of HO^- (representing an sp^3 lone pair) or the positive charge of H^+ (representing the empty $1s$ orbital).

■ In common with some other molecules, water can be either a nucleophile or an electrophile. In cases like this you can work out which it must be by looking at the other reagent: here, the anion *has* to be a nucleophile. Negatively charged molecules are *never* electrophiles.

● **Summary: Curly arrow health check**

- A curly arrow shows the movement of a pair of electrons.
- The tail of the arrow shows the source of the electron pair, which will be a filled orbital (HOMO) and can be represented by:
 - a lone pair
 - or a negative charge
 - or a π bond
 - or a σ bond.
- The head of the arrow indicates the destination of the electron pair, which will be:
 - an empty atomic orbital where a new bond will be formed
 - or a π^* or σ^* antibonding orbital where a new bond will be formed *and* an old bond will break
 - or an electronegative atom that can support a negative charge.
- Overall charge is always conserved in a reaction.

Drawing your own mechanisms with curly arrows

When you meet a new reaction, you must do two things:

1. identify which bonds have been formed and broken, and
2. decide which molecule is the nucleophile and which is the electrophile.

Once you have done that, you are well on the way to writing a reasonable mechanism using curly arrows. We'll take as an example the reaction of triphenylphosphine with methyl iodide.



First observe what has happened: a new bond has been formed between the phosphorus atom and the methyl group, and the carbon–iodine bond has been broken. So we need to draw the two reagents in such a way that a curly arrow can be used to represent this new bond. You'll also need to make sure that you draw out all of the bonds that are actually involved in the reaction (too much detail is better than too little):

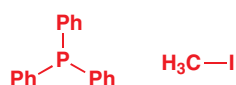

Now the all-important question: **which is the nucleophile and which is the electrophile?** For the nucleophile we are looking for a high-energy pair of electrons such as a lone pair, which the phosphorus has. Likewise, methyl iodide fits the bill as a plausible electrophile, with its bond between C and an electronegative element (I). All that remains is to draw the arrows. The first one starts on the source of the electrons, the phosphorus lone pair, and finishes near the C atom to indicate the new P–C bond. The second one breaks the old C–I bond and moves electrons onto the I atom.



Admittedly, that was quite an easy mechanism to draw but you should still be pleased if you succeeded at your first try.

Watch out for five-valent carbons

We now ought to spell out one thing that we have never stated but rather assumed. Most atoms in stable organic molecules have a full complement of electrons (two in the case of hydrogen, eight in the cases of carbon, nitrogen, and oxygen) and so, if you make a new bond to one of those elements, *you must also break an existing bond*. Suppose you just 'added' Ph_3P to MeI in this last example without breaking the C-I bond: what would happen?

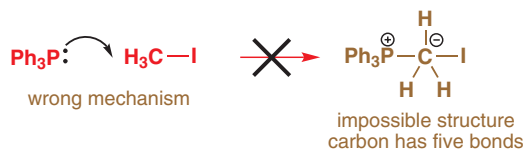

This structure must be wrong because carbon cannot have five bonds—if it did it would have ten electrons in the 2s and the three 2p orbitals. Four orbitals can contain only eight electrons.

- B, C, N, and O never have more than four bonds. If you make a new bond to uncharged H, C, N, or O you must also break one of the existing bonds in the same step.

Mechanisms with several steps

At the beginning of the chapter, we mentioned the fact that carbonyl compounds react with cyanide. We are now going to deduce a mechanism. This is the reaction:

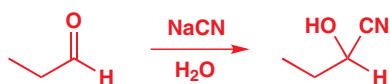

We must decide what happens. NaCN is an ionic solid so the true reagent must be cyanide ion, whose structure was discussed on p. 112. As it is an anion, it must be the nucleophile and the carbonyl group must be the electrophile. Starting the arrow on the nucleophile's negative charge and heading for the C=O group, and then using a second arrow to break the C=O bond gives us this:



This is a good mechanism but it doesn't quite produce the product. There must be a second step in which the anionic oxygen picks up a proton from somewhere. The only source of protons is the solvent, water, so we can write the full mechanism in one sequence:

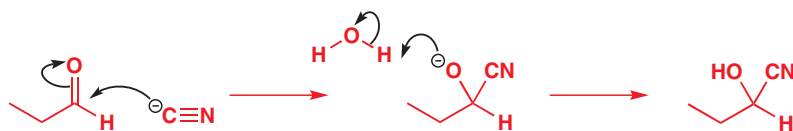

Try a more complicated example: primary alcohols can be converted into symmetrical ethers in acid solution. Suggest a mechanism for this acid-catalysed conversion of one functional group into another.

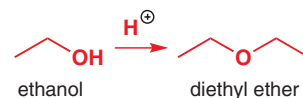

This reaction is presented in a style with which you will become familiar. The organic starting material is written first and then the reagent and solvent over and under the reaction arrow. We call this a *reaction scheme*. It is not an 'equation': it is not balanced, and we use a (straight) reaction arrow \longrightarrow , not an 'equals' sign.

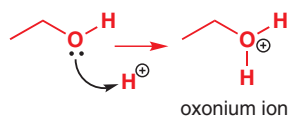

The acid must do something, so we need to start with the reaction between ethanol and H^+ . H^+ has to be an electrophile, so the nucleophile must be ethanol, using its HOMO, one of the O lone pairs, as the source of electrons. The first intermediate we get is called an oxonium ion.

The positively charged oxonium ion has to be the electrophile in the second step of the reaction, and the only possible nucleophile is another molecule of ethanol. But how do they react? It's tempting to allow the ethanol's lone pair to attack the positively charged oxygen atom, but that would give us an oxygen atom with ten electrons—as with H_3O^+ this positive charge is not an empty orbital. Attacking the H–O bond is a good alternative, but that just takes us back to where we started.

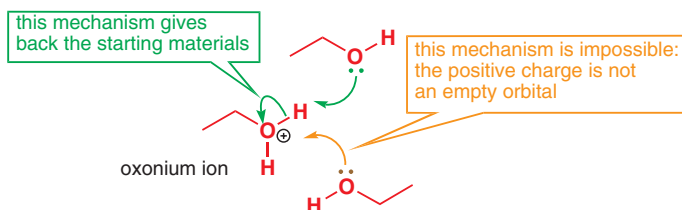

What we need is a new C–O bond, so the lone pair must attack at carbon, putting electrons into the C–O σ^* and expelling a molecule of water. Here's the full mechanism. The last step is loss of the proton to give the ether.

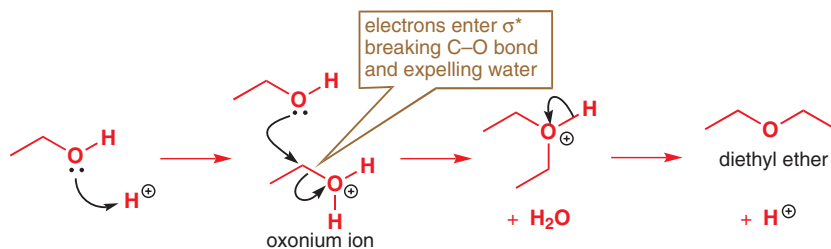

Now for something completely new: try drawing a mechanism for this reaction.

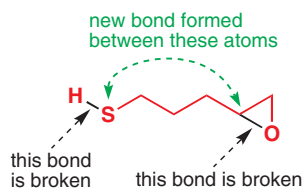

You might well protest that you don't know anything about the chemistry of either of the functional groups, the thiol or the cyclic ether. Be that as it may, you can still draw a mechanism. Ask first of all: which bonds have been formed and which broken? Clearly the S–H bond has been broken and a new S–C bond formed. The three-membered ring has gone by the cleavage of one of the C–O bonds. The main chain of carbon atoms is unchanged. All this is sketched in the diagram in the margin. We suggest you now cover the rest of this page and try to work out a mechanism yourself before reading further.

The hydroxide must do something, and since it is negatively charged, a reasonable starting point is going to be to use it as a nucleophile to break the S–H bond. Hydroxide is after all a base; it likes to remove protons. So here's the first step:



Now we have a negatively charged sulfur atom, which must be the nucleophile. We want to make a bond to carbon, so the C–O bond in the three-membered ring must be the electrophile. So ... just draw the arrows and see what happens. Here goes ...



That is not quite the product: we need to let this anion pick up a proton from somewhere. Where can the proton come from? It must be the proton originally removed by the hydroxide. The anion attacks water and the hydroxide is regenerated.



Your mechanism possibly didn't look as neat as the printed version, but if you got it roughly right, you should be proud. This is a three-step mechanism involving chemistry that is new to you and yet you could draw a mechanism for it.

Curly arrows are vital for learning organic chemistry

Curly arrows can be used to explain the interaction between the structure of reactants and products, and their reactivity in the vast majority of organic reactions, regardless of their complexity. When used correctly they can even be used to predict possible outcomes of unknown processes and hence to design new synthetic reactions. They are a powerful tool for understanding and developing organic chemistry and it is vital that you become proficient in their use. They are the dynamic language of organic reaction mechanisms and they will appear in every chapter of the book from now on.

Another equally important reason for mastering curly arrows now, as we start the systematic study of different types of reactions, is that the seemingly vast number of 'different reactions' turn out not to be so vast after all. Most organic reactions involve the movement of pairs of electrons between nucleophiles and electrophiles. And with relatively few types of organic nucleophiles and electrophiles involved in all these reactions, the similarity between seemingly unrelated reactions will become immediately apparent if you understand and can draw mechanisms. Learning to draw mechanisms means you can understand groups of related reactions rather than having to learn them individually.

Drawing curly arrow mechanisms is a bit like riding a bike. Before you've mastered the skill, you keep falling off. Once you've mastered the skill, it seems so straightforward that you wonder how you ever did without it. You'll come across busy streets and complex traffic junctions, but with care you'll get through safely.

Step-by-step guide to drawing mechanisms with curly arrows

If you still feel you are at the wobbly stage, and need a helping hand, this step-by-step guide may help you. You'll soon find you won't need to follow it through in detail.

1. Draw out the reagents as clear structures following the guidelines in Chapter 2. Check that you understand what the reagents and the solvent are under the conditions of the reaction, for example if the reaction is in a base, will one of the compounds exist as an anion?
2. Inspect the starting materials and the products, and assess what has happened in the reaction. What new bonds have been formed? What bonds have been broken? Has anything been added or removed? Have any bonds moved around the molecule?
3. Identify the nucleophilic centres in all the reactant molecules and decide which is the most nucleophilic. Then identify the electrophiles present and again decide which is the most electrophilic.
4. If the combination of these two centres appears to lead to the product, draw the reactants, complete with charges, so as to position the nucleophilic and electrophilic centres within bonding distance, ensuring that the angle of attack of the nucleophile is more or less consistent with the orbitals involved.
5. Draw a curly arrow from the nucleophile to the electrophile. It must start on a representation of electrons—a filled orbital or negative charge (show this clearly by just touching the bond or charge)—and finish where the electrons are heading for (show this clearly by the position of the head).

■ We will generally show mechanisms using black arrows on red diagrams but the only point of that is to make the arrows stand out. We suggest that when you write mechanisms you consider using a colour for your arrows that contrasts with the structures.

➔ The few reaction types that don't involve nucleophiles and electrophiles are discussed in Chapters 34, 35, 37, and 38.

➔ You will see a great example of this in Chapter 10: carboxylic acids, amides, esters, anhydrides ... many functional groups, but all the same mechanisms.

6. Consider whether any atom that has been changed now has too many bonds; if so one of them must be broken to avoid absurd structures. Select a bond to break. Draw a curly arrow from the centre of the chosen bond, the filled orbital, and terminate it in a suitable place, such as an electronegative atom.
7. Write out the structures of the products specified by the curly arrows. Break the bonds that are the sources of the arrows and make those that are the targets. Consider the effect on the charges on individual atoms and check that the overall charge is not changed. Once you have drawn the curly arrows, the structure of the products is already decided and there is no room for any further decisions. Just write what the curly arrows tell you. If the structure is wrong, then the curly arrows were wrong so go back and change them.
8. Repeat stages 5–7 as required to produce a stable product.

Now you have met the language of mechanism it's time to look in detail at the reactions of some functional groups, and we start with the most important functional group of all, the carbonyl group.

Further reading

S. Warren, *Chemistry of the Carbonyl Group: A Programmed Approach to Organic Reaction Mechanisms*, Wiley, Chichester, 1974. Our recommendation for the last chapter, *Molecular Orbitals and Organic Chemical Reactions: Student Edition* by Ian Fleming, Wiley, Chichester, 2009, also gives guidance on using orbitals in chemical reactions and drawing mechanisms.

For a theoretical/physical approach to the question of reactivity, see J. Keeler and P. Wothers, *Why Chemical Reactions Happen*, OUP, Oxford, 2003.

Check your understanding



To check that you have mastered the concepts presented in this chapter, attempt the problems that are available in the book's Online Resource Centre at <http://www.oxfordtextbooks.co.uk/orc/clayden2e/>

Nucleophilic addition to the carbonyl group

6

Connections

➔ Building on

- Functional groups, especially the C=O group **ch2**
- Identifying the functional groups in a molecule spectroscopically **ch3**
- How molecular orbitals explain molecular shapes and functional groups **ch4**
- How, and why, molecules react together and using curly arrows to describe reactions **ch5**

Arriving at

- How and why the C=O group reacts with nucleophiles
- Explaining the reactivity of the C=O group using molecular orbitals and curly arrows
- What sorts of molecules can be made by reactions of C=O groups
- How acid or base catalysts improve the reactivity of the C=O group

➔ Looking forward to

- Additions of organometallic reagents **ch9**
- Substitution reactions of the C=O group's oxygen atom **ch11**
- How the C=O group in derivatives of carboxylic acids promotes substitution reactions **ch10**
- C=O groups with an adjacent double bond **ch22**

Molecular orbitals explain the reactivity of the carbonyl group

We are now going to leave to one side most of the reactions you met in the last chapter—we will come back to them all again later in the book. In this chapter we are going to concentrate on just one of them—probably the simplest of all organic reactions—the addition of a nucleophile to a carbonyl group. The carbonyl group, as found in aldehydes, ketones, and many other compounds, is without doubt the most important functional group in organic chemistry, and that is another reason why we have chosen it as our first topic for more detailed study.

You met nucleophilic addition to a carbonyl group on pp. 115 and 121, where we showed you how cyanide reacts with aldehydes to give an alcohol. As a reminder, here is the reaction again, this time with a ketone, with its mechanism.

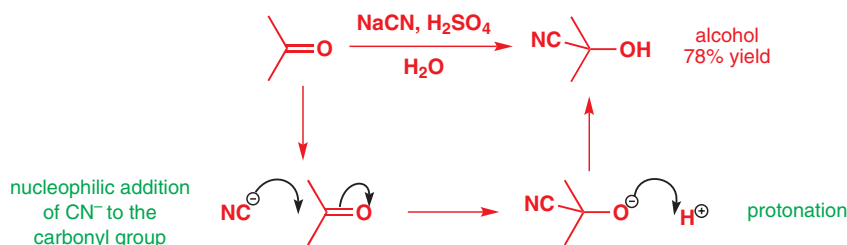

The reaction has two steps: nucleophilic addition of cyanide, followed by protonation of the anion. In fact, this is a general feature of all nucleophilic additions to carbonyl groups.

■ We will frequently use a device like this, showing a reaction scheme with a mechanism for the same reaction looping round underneath. The reagents and conditions above and below the arrow across the top tell you how you might carry out the reaction, and the pathway shown underneath tells you how it actually works.

Online support. The icon  in the margin indicates that accompanying interactive resources are provided online to help your understanding: just type www.chemtube3d.com/clayden/123 into your browser, replacing 123 with the number of the page where you see the icon. For pages linking to more than one resource, type 123-1, 123-2 etc. (replacing 123 with the page number) for access to successive links.

• **Additions to carbonyl groups generally consist of two mechanistic steps:**

- nucleophilic attack on the carbonyl group
- protonation of the anion that results.

The addition step is more important, and it forms a new C–C σ bond at the expense of the C=O π bond. The protonation step makes the overall reaction addition of HCN across the C=O π bond.

Why does cyanide, in common with many other nucleophiles, attack the carbonyl group? And why does it attack the *carbon* atom of the carbonyl group? To answer these questions we need to look in detail at the structure of carbonyl compounds in general and the orbitals of the C=O group in particular.

The carbonyl double bond, like that found in alkenes (whose bonding we discussed in Chapter 4), consists of two parts: one σ bond and one π bond. The σ bond between the two sp^2 hybridized atoms—carbon and oxygen—is formed from two sp^2 orbitals. The other sp^2 orbitals on carbon form the two σ bonds to the substituents while those on oxygen are filled by the two lone pairs. The sp^2 hybridization means that the carbonyl group has to be planar, and the angle between the substituents is close to 120° . The diagram illustrates all this for the simplest carbonyl compound, formaldehyde (or methanal, CH_2O). The π bond then results from overlap of the remaining p orbitals—again, you can see this for formaldehyde in the diagram.

 Interactive bonding orbitals in formaldehyde

➔ You were introduced to the polarization of orbitals in Chapter 4 and we discussed the case of the carbonyl group on p. 104.

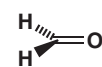

formaldehyde
(methanal, CH_2O)
viewed from a slight angle

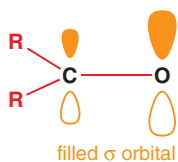
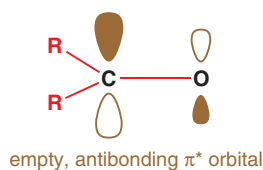
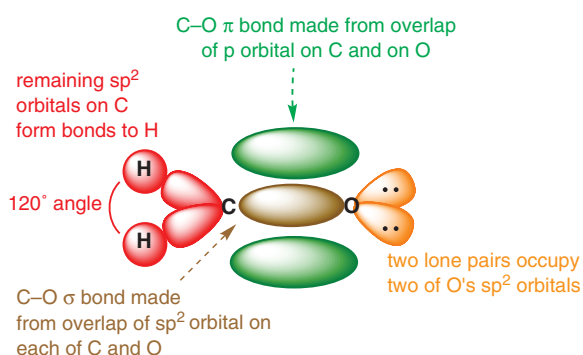

When we introduced the bonding in the carbonyl group in Chapter 4 we explained how polarization in the π bond means it is skewed towards oxygen, because oxygen is more electronegative than carbon. Conversely, the unfilled π^* antibonding orbital is skewed in the opposite direction, with a larger coefficient at the carbon atom. This is quite hard to represent with the π bond represented as a single unit, as shown above, but becomes easier to visualize if instead we represent the π and π^* orbitals using individual p orbitals on C and O. The diagrams in the margin show the π and π^* orbitals represented in this way.

Electronegativities, bond lengths, and bond strengths

Representative bond energy, kJ mol^{-1}		Representative bond length, \AA		Electronegativity	
C–O	351	C–O	1.43	C	2.5
C=O	720	C=O	1.21	O	3.5

Because there are two types of bonding between C and O, the C=O double bond is rather shorter than a typical C–O single bond, and also over twice as strong—so why is it so reactive? Polarization is the key. The polarized C=O bond gives the carbon atom some degree of positive charge, and this charge attracts negatively charged nucleophiles (like cyanide) and encourages reaction. The polarization of the antibonding π^* orbital towards carbon is also

important because, when the carbonyl group reacts with a nucleophile, electrons move from the HOMO of the nucleophile (an sp orbital in the case of cyanide) into the LUMO of the electrophile—in other words the π^* orbital of the $C=O$ bond. The greater coefficient of the π^* orbital at carbon means a better HOMO–LUMO interaction, so this is where the nucleophile attacks.

As our nucleophile—which we are representing here as ‘Nu[−]’—approaches the carbon atom, the electron pair in its HOMO starts to interact with the LUMO (antibonding π^*) to form a new σ bond. Filling antibonding orbitals breaks bonds and, as the electrons enter the antibonding π^* of the carbonyl group, the π bond is broken, leaving only the $C-O$ σ bond intact. But electrons can't just vanish, and those that were in the π bond move off on to the electronegative oxygen, which ends up with the negative charge that started on the nucleophile. You can see all this happening in the diagram below.

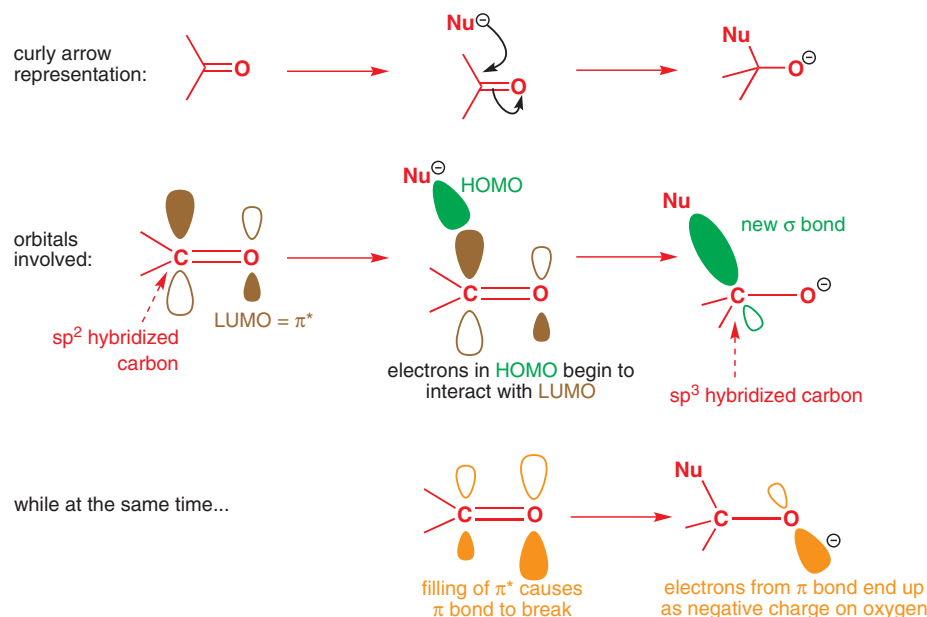

Notice how the trigonal, planar sp^2 hybridized carbon atom of the carbonyl group changes to a tetrahedral, sp^3 hybridized state in the product. For each class of nucleophile you meet in this chapter, we will show you the HOMO–LUMO interaction involved in the addition reaction. These interactions also show you how the orbitals of the starting materials change into the orbitals of the product as they combine. Most importantly here, the lone pair of the nucleophile combines with the π^* of the carbonyl group to form a new σ bond in the product.

Attack of cyanide on aldehydes and ketones

Now that we've looked at the theory of how a nucleophile attacks a carbonyl group, let's go back to the real reaction with which we started this chapter: cyanohydrin formation from a carbonyl compound and sodium cyanide. Cyanide contains sp hybridized C and N atoms, and its HOMO is an sp orbital on carbon. The reaction is a typical nucleophilic addition reaction to a carbonyl group: the electron pair from the HOMO of the CN^- (an sp orbital on carbon) moves into the $C=O$ π^* orbital; the electrons from the $C=O$ π orbital move on to the oxygen atom. The reaction is usually carried out in the presence of acid, which protonates the resulting alkoxide to give the hydroxyl group of the composite functional group known as a cyanohydrin. The reaction works with both ketones and aldehydes, and the mechanism below shows the reaction of a general aldehyde. This reaction appeared first in Chapter 5.

The HOMO of the nucleophile will depend on what the nucleophile is, and we will meet examples in which it is an sp or sp^3 orbital containing a lone pair, or a B–H σ orbital or metal–carbon σ orbital. We shall shortly discuss cyanide as the nucleophile; cyanide's HOMO is an sp orbital on carbon.

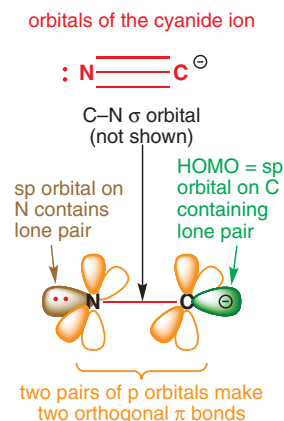

Interactive mechanism for cyanohydrin formation

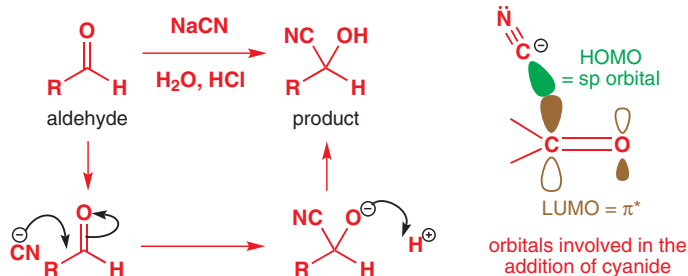

Cyanohydrins in synthesis

Cyanohydrins are important synthetic intermediates, for example the cyanohydrin formed from this cyclic amino ketone is the first intermediate in a synthesis of some medicinal compounds known as 5HT₃ agonists, which were designed to reduce nausea in chemotherapy patients.

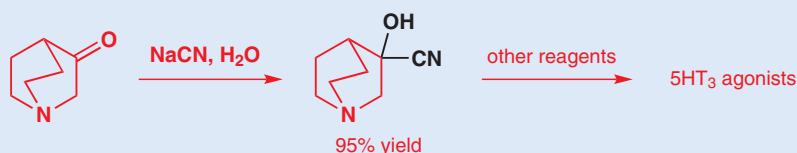

Cyanohydrins are also components of many natural and industrial products, such as the insecticide cypermethrin (marketed as 'Ripcord' and 'Barricade').

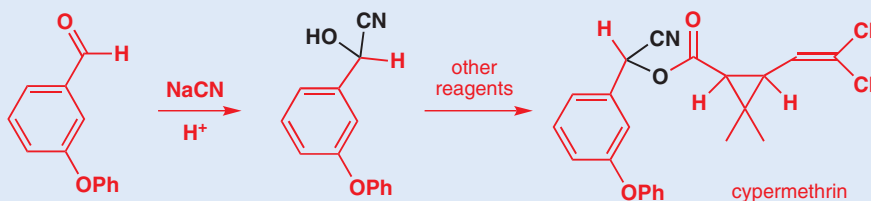

Cyanohydrin formation is reversible: just dissolving a cyanohydrin in water can give back the aldehyde or ketone you started with, and aqueous base usually decomposes cyanohydrins completely. This is because cyanide is a good *leaving group*—we'll come back to this type of reaction in more detail in Chapter 10.

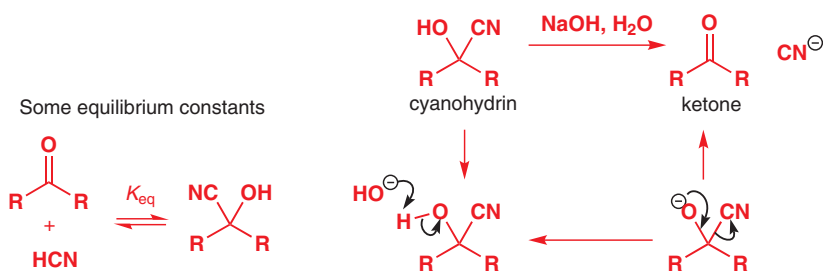

aldehyde or ketone	K_{eq}
PhCHO	212
	28

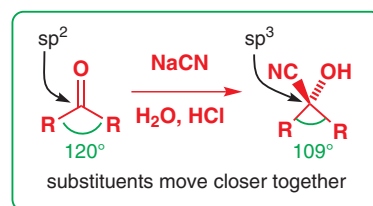

Cyanohydrin formation is therefore an equilibrium between starting materials and products, and we can get good yields only if the equilibrium favours the products. The equilibrium is more favourable for aldehyde cyanohydrins than for ketone cyanohydrins, and the reason is the size of the groups attached to the carbonyl carbon atom. As the carbonyl carbon atom changes from sp^2 to sp^3 , its bond angles change from about 120° to

about 109° —in other words, the substituents it carries move closer together. This reduction in bond angle is not a problem for aldehydes, because one of the substituents is just a (very small) hydrogen atom, but for ketones, especially ones that carry larger alkyl groups, this effect can disfavour the addition reaction. Effects that result from the size of substituents and the repulsion between them are called steric effects, and we call the repulsive force experienced by large substituents steric hindrance. Steric hindrance (not ‘hinderance’) is a consequence of repulsion between the electrons in all the filled orbitals of the alkyl substituents.

Steric hindrance

The size of substituents plays a role in very many organic reactions—it’s the reason aldehydes (with an H next to the C=O group) are more reactive than ketones, for example. Steric hindrance affects reaction rates, but also makes molecules react by completely different mechanisms, as you will see in the substitution reactions in Chapter 15. You will need to get used to thinking about whether the presence of large substituents, with all their filled C–H and C–C bonds, is a factor in determining how well a reaction will go.

Cyanohydrins and cassava

The reversibility of cyanohydrin formation is of more than theoretical interest. In parts of Africa the staple food is cassava. This food contains substantial quantities of the glucoside of acetone cyanohydrin (a glucoside is an acetal derived from glucose). We shall discuss the structure of glucose later in this chapter, but for now, just accept that it stabilizes the cyanohydrin.

The glucoside is not poisonous in itself, but enzymes in the human gut break it down and release HCN. Eventually 50 mg HCN per 100 g of cassava can be released and this is enough to kill a human being after a meal of unfermented cassava. If the cassava is crushed with water and allowed to stand (‘ferment’), enzymes in the cassava will do the same job and then the HCN can be washed out before the cassava is cooked and eaten.

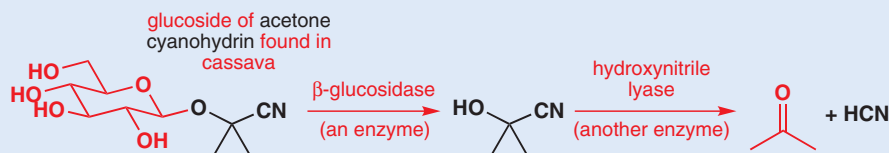

The cassava is now safe to eat but it still contains some glucoside. Some diseases found in eastern Nigeria can be traced to long-term consumption of HCN. Similar glucosides are found in apple pips and the kernels inside the stones of fruit such as peaches and apricots. Some people like eating these, but it is unwise to eat too many at one sitting!

The angle of nucleophilic attack on aldehydes and ketones

Having introduced you to the sequence of events that makes up a nucleophilic attack at C=O (interaction of HOMO with LUMO, formation of new σ bond, breakage of π bond), we should now tell you a little more about the *direction* from which the nucleophile approaches the carbonyl group. Not only do nucleophiles always attack carbonyl groups at carbon, but they also always approach from a particular angle. You may at first be surprised by this angle, since nucleophiles attack not from a direction perpendicular to the plane of the carbonyl group but at about 107° to the C=O bond—close to the angle at which the new bond will form. This approach route is known as the Bürgi–Dunitz trajectory after the authors of the elegant crystallographic methods that revealed it. You can think of the angle of attack as the result of a compromise between maximum orbital overlap of the HOMO with π^* and minimum repulsion of the HOMO by the electron density in the carbonyl π bond. But a better explanation is that π^* does not have parallel atomic orbitals as there is a node halfway down the bond (Chapter 4) so the atomic orbitals are already at an angle. The nucleophile attacks along the axis of the larger orbital in the HOMO.

➔ We pointed this out in Chapter 4 on p. 104.

■ Although we now know precisely from which direction the nucleophile attacks the C=O group, this is not always easy to represent when we draw curly arrows. As long as you bear the Bürgi–Dunitz trajectory in mind, you are quite at liberty to write any of the variants shown here, among others.

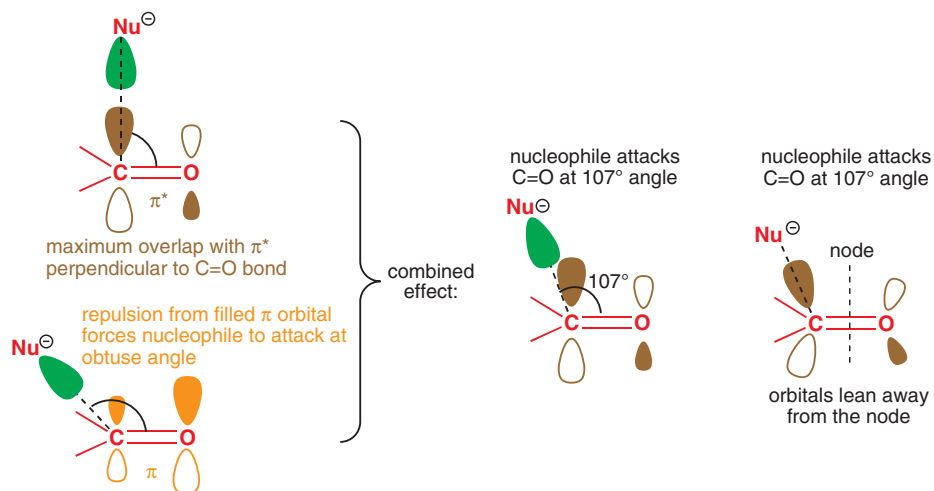
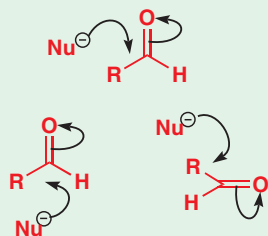

Any other portions of the molecule that get in the way of (or, in other words, that cause *steric hindrance* to) the Bürgi–Dunitz trajectory will greatly reduce the rate of addition and this is another reason why aldehydes are more reactive than ketones. The importance of the Bürgi–Dunitz trajectory will become more evident later, particularly in Chapter 33.

Bürgi and Dunitz deduced this trajectory by examining crystal structures of compounds containing both a nucleophilic nitrogen atom and an electrophilic carbonyl group. They found that, when the two got close enough to interact, but were not free to undergo reaction, the nitrogen atom always lay on or near the 107° trajectory described here. Theoretical calculations later gave the same 107° value for the optimum angle of attack.

Nucleophilic attack by 'hydride' on aldehydes and ketones

Nucleophilic attack by the hydride ion, H^- , is an almost unknown reaction. This species, which is present in the salt sodium hydride, NaH, has such a high charge density that it only ever reacts as a base. The reason is that its filled 1s orbital is of an ideal size to interact with the hydrogen atom's contribution to the σ^* orbital of an H–X bond (X can be any atom), but much too small to interact easily with carbon's more diffuse 2p orbital contribution to the LUMO (π^*) of the C=O group.

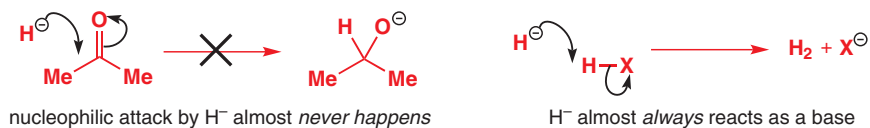

Nevertheless, adding H^- to the carbon atom of a C=O group would be a very useful reaction, as the result would be the formation of an alcohol. This process would involve going down from the aldehyde or ketone oxidation level to the alcohol oxidation level (Chapter 2, p. 32) and would therefore be a reduction. It cannot be done with NaH, but it can be done with some other compounds containing nucleophilic hydrogen atoms.



The most important of these compounds is sodium borohydride, NaBH_4 . This is a water-soluble salt containing the tetrahedral BH_4^- anion, which is isoelectronic with methane but has a negative charge since boron has one less proton in the nucleus than does carbon.

In Chapter 4 we looked at isoelectronic borane BH_3 and the cation CH_3^+ . Here we have effectively added a hydride ion to each of them.

But beware! Remember (p. 115) there is no lone pair on boron: you must not draw an arrow coming out of this negative charge to form another bond. If you did, you would get a penta-covalent B(V) compound, which would have ten electrons in its outer shell. Such a thing is impossible with a first-row element as there are only four available orbitals ($1 \times 2s$ and $3 \times 2p$). Instead, since all of the electrons (including those represented by the negative charge) are in B–H σ orbitals, it is from a B–H bond that we must start any arrow to indicate reaction of BH_4^- as a nucleophile. By transferring this pair of electrons we make the boron atom neutral—it is now trivalent with just six electrons.

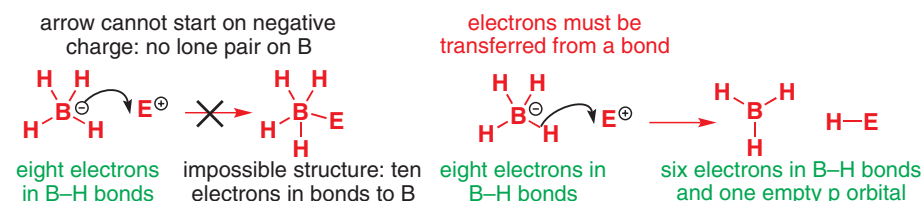
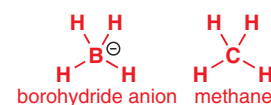

Just as we have used Nu^- to indicate any (undefined) nucleophile, here E^+ means any (undefined) electrophile.

What happens when we carry out this reaction using a carbonyl compound as the electrophile? The hydrogen atom, together with the pair of electrons from the B–H bond, will be transferred to the carbon atom of the $\text{C}=\text{O}$ group. Although no hydride ion, H^- , is actually involved in the reaction, the transfer of a hydrogen atom with an attached pair of electrons can be regarded as a 'hydride transfer'. You will often see it described this way in books. But be careful not to confuse BH_4^- with the hydride ion itself. To make it quite clear that it is the hydrogen atom that is forming the new bond to C, this reaction may also be helpfully represented with a curly arrow *passing through* the hydrogen atom.

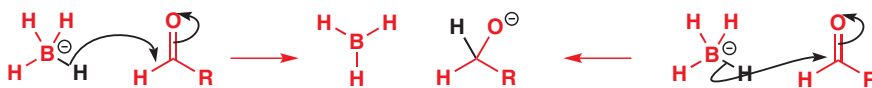

Interactive mechanism for borohydride reduction

You met this reaction in Chapter 5 but there is more to say about it. The oxyanion produced in the first step can help stabilize the electron-deficient BH_3 molecule by adding to its empty p orbital. Now we have a tetravalent boron anion again, which could transfer a second hydrogen atom (with its pair of electrons) to another molecule of aldehyde.

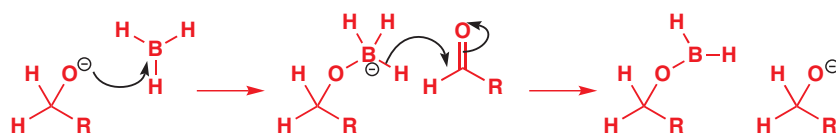

This process can continue so that, in principle, all four hydrogen atoms could be transferred to molecules of aldehyde. In practice the reaction is rarely as efficient as that, but aldehydes and ketones are usually reduced in good yield to the corresponding alcohol by sodium borohydride in water or alcoholic solution. The water or alcohol solvent provides the proton needed to form the alcohol from the alkoxide.

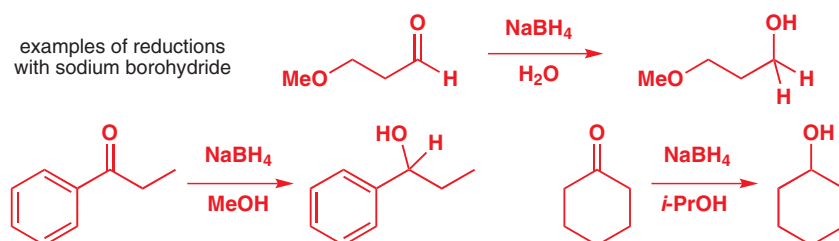

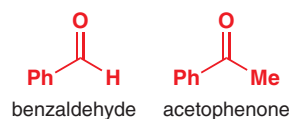

Aluminium is more electropositive (more metallic) than boron and is therefore more ready to give up a hydrogen atom (and the associated negative charge), whether to a carbonyl group or to water. Lithium aluminium hydride reacts violently and dangerously with water in an exothermic reaction that produces highly flammable hydrogen.

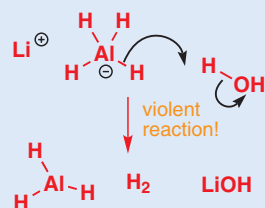

Sodium borohydride is one of the weaker hydride donors. The fact that it can be used in water is evidence of this: more powerful hydride donors such as lithium aluminium hydride, LiAlH₄, react violently with water. Sodium borohydride reacts with both aldehydes and ketones, although the reaction with ketones is slower: for example, benzaldehyde is reduced about 400 times faster than acetophenone in isopropanol. This is because of steric hindrance (see above).

Sodium borohydride does not react at all with less reactive carbonyl compounds such as esters or amides: if a molecule contains both an aldehyde and an ester, only the aldehyde will be reduced.

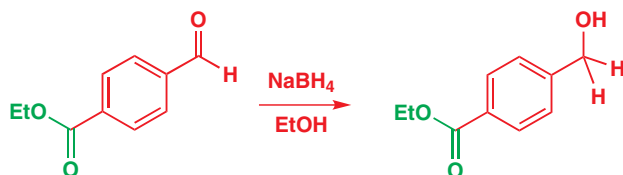

The next two examples illustrate the reduction of aldehydes and ketones in the presence of other reactive functional groups. No reaction occurs at the nitro group in the first case or at the alkyl halide in the second.

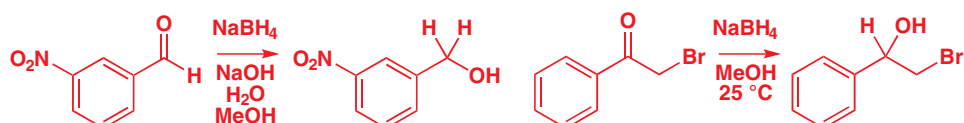

Addition of organometallic reagents to aldehydes and ketones

Organometallic compounds have a carbon–metal bond. Lithium and magnesium are very electropositive metals, and the Li–C or Mg–C bonds in organolithium or organomagnesium reagents are highly polarized towards carbon. They are therefore very powerful nucleophiles, and attack the carbonyl group to give alcohols, forming a new C–C bond. For our first example, we shall take one of the simplest of organolithiums, methyl lithium, which is commercially available as a solution in Et₂O, shown here reacting with an aldehyde. The orbital diagram of the addition step shows how the polarization of the C–Li bond means that it is the carbon atom of the nucleophile that attacks the carbon atom of the electrophile and we get a new C–C bond. We explained on p. 113 the polarization of bonds between carbon and more electropositive elements. The relevant electronegativities are C 2.5, Li 1.0, and Mg 1.2 so both metals are much more electropositive than carbon. The orbitals of MeLi are discussed in Chapter 4.

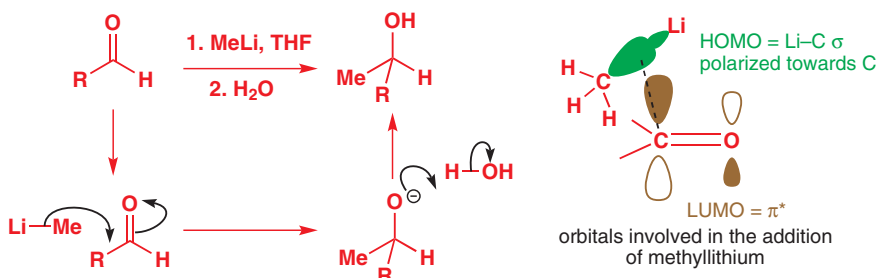

Interactive mechanism for methyl lithium addition

The course of the reaction is much the same as you have seen before, but we need to highlight a few points where this reaction scheme differs from those you have met earlier in the chapter. First of all, notice the legend '1. MeLi, THF; 2. H₂O'. This means that, first, MeLi is added to the aldehyde in a THF solvent. Reaction occurs: MeLi adds to the aldehyde to give an alkoxide. Then (and only then) water is added to protonate the alkoxide. The '2. H₂O' means that water is added in a separate step only when all the MeLi has reacted: it is not present at the start of the reaction as it was in the cyanide reaction and some of the borohydride addition reactions. In fact, water *must not be* present during the addition of MeLi (or of any other organometallic reagent) to a carbonyl group because water destroys organometallics very rapidly

by protonating them to give alkanes (organolithiums and organomagnesiums are strong bases as well as powerful nucleophiles). The addition of water, or sometimes dilute acid or ammonium chloride, at the end of the reaction is known as the *work-up*.

Because they are so reactive, organolithiums are usually used at low temperature, often $-78\text{ }^{\circ}\text{C}$ (the sublimation temperature of solid CO_2), in aprotic solvents such as Et_2O or THF. Protic solvents such as water or alcohols have acidic protons but aprotic solvents such as ether do not. Organolithiums also react with oxygen, so they have to be handled under a dry, inert atmosphere of nitrogen or argon. Other common, and commercially available, organolithium reagents include *n*-butyllithium and phenyllithium, and they react with both aldehydes and ketones. Note that addition to an aldehyde gives a secondary alcohol while addition to a ketone gives a tertiary alcohol.

Low-temperature baths

Cooling reaction mixtures is generally the job of a cooling bath of ice and water for around $0\text{ }^{\circ}\text{C}$, or baths of solid CO_2 in organic solvents such as acetone or ethanol down to about $-78\text{ }^{\circ}\text{C}$. Small pieces of solid CO_2 are added slowly to the solvent until vigorous bubbling ceases. Few chemists then measure the temperature of the bath, which may be anywhere from -50 to $-80\text{ }^{\circ}\text{C}$. The temperature given in publications is often $-78\text{ }^{\circ}\text{C}$, about the lower limit. Lower temperatures require liquid nitrogen. Practical handbooks give details.

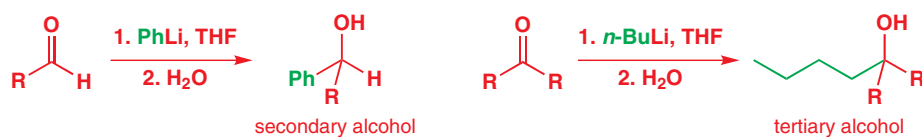

Organomagnesium reagents known as Grignard reagents (RMgX) react in a similar way. Some simple Grignard reagents, such as methyl magnesium chloride, MeMgCl , and phenyl magnesium bromide, PhMgBr , are commercially available, and the scheme shows PhMgBr reacting with an aldehyde. The reactions of these two classes of organometallic reagent—organolithiums and Grignard reagents—with carbonyl compounds are among the most important ways of making carbon–carbon bonds, and we will consider them in more detail in Chapter 9.

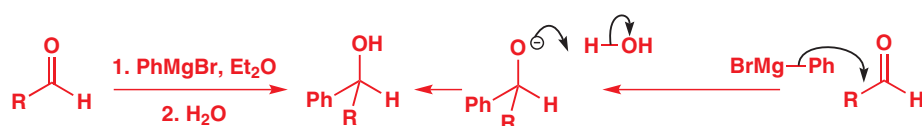

Grignard reagents were discovered by Victor Grignard (1871–1935) at the University of Lyon, who got the Nobel prize for his discovery in 1912. They are made by reacting alkyl or aryl halides with magnesium ‘turnings’.

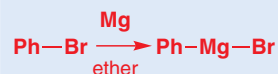

Interactive mechanism for Grignard addition

Addition of water to aldehydes and ketones

Nucleophiles don't have to be highly polarized or negatively charged to react with aldehydes and ketones: neutral ones will as well. How do we know? This ^{13}C NMR spectrum was obtained by dissolving formaldehyde, $\text{H}_2\text{C}=\text{O}$, in water. You will remember from Chapter 3 that the carbon atoms of carbonyl groups give ^{13}C signals typically in the region of 150–200 ppm. So where is formaldehyde's carbonyl peak? Instead we have a signal at 83 ppm—where we would expect tetrahedral carbon atoms singly bonded to oxygen to appear.

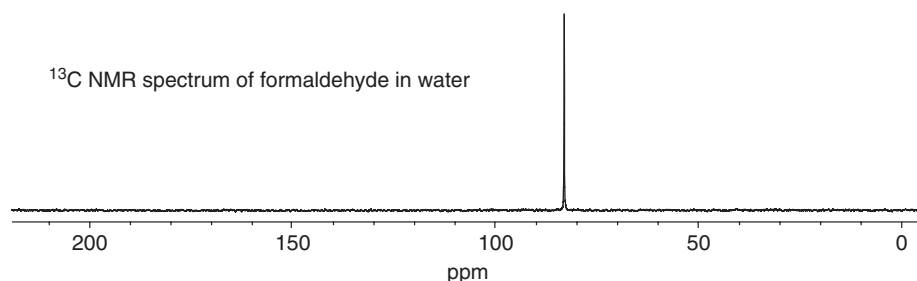

organometallics are destroyed by water

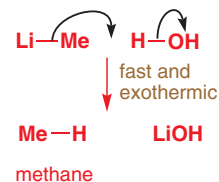

What has happened is that water has added to the carbonyl group to give a compound known as a hydrate or 1,1-diol.

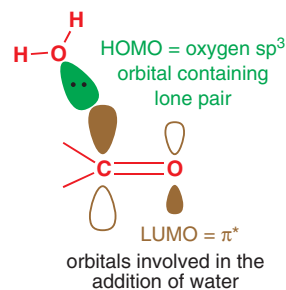
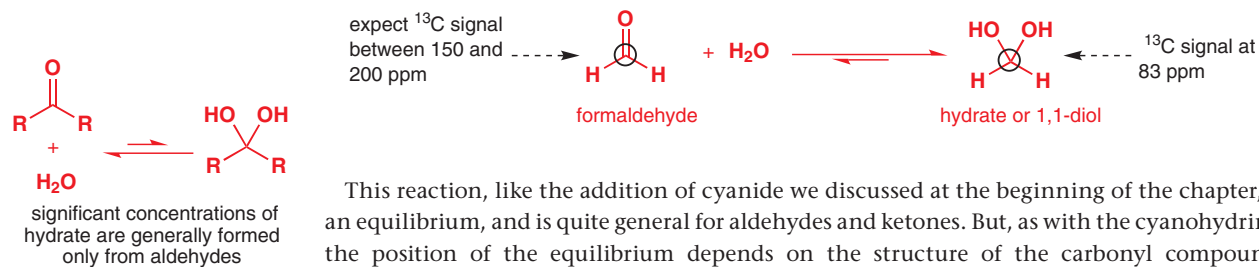

Interactive mechanism for hydrate formation

This reaction, like the addition of cyanide we discussed at the beginning of the chapter, is an equilibrium, and is quite general for aldehydes and ketones. But, as with the cyanohydrins, the position of the equilibrium depends on the structure of the carbonyl compound. Generally, the same steric factors (p. 129) mean that simple aldehydes are hydrated to some extent while simple ketones are not. However, special factors can shift the equilibrium towards the hydrated form even for ketones, particularly if the carbonyl compound is reactive or unstable.

Formaldehyde is an extremely reactive aldehyde as it has no substituents to hinder attack—it is so reactive that it is rather prone to polymerization. And it is quite happy to move from sp^2 to sp^3 hybridization because there is very little increased steric hindrance between the two hydrogen atoms as the bond angle changes from 120° to 109° (p. 129). This is why our aqueous solution of formaldehyde contains essentially no CH_2O —it is completely hydrated. A mechanism for the hydration reaction is shown below. Notice how a proton has to be transferred from one oxygen atom to the other, mediated by water molecules.

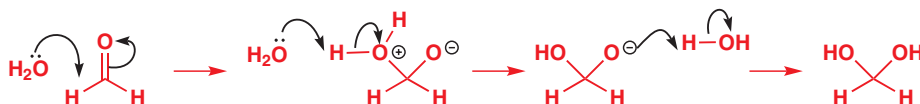

Formaldehyde reacts with water so readily because its substituents are very small: a steric effect. Electronic effects can also favour reaction with nucleophiles—electronegative atoms such as halogens attached to the carbon atoms next to the carbonyl group can increase the extent of hydration by the inductive effect according to the number of halogen substituents and their electron-withdrawing power. They increase the polarization of the carbonyl group, which already has a positively polarized carbonyl carbon, and make it even more prone to attack by water. Trichloroacetaldehyde (chloral, Cl_3CHO) is hydrated completely in water, and the product ‘chloral hydrate’ can be isolated as crystals and is an anaesthetic. You can see this quite clearly in the two IR spectra below. The first one is a spectrum of chloral hydrate from a bottle—notice there is no strong absorption between 1700 and 1800 cm^{-1} (where we would expect $C=O$ to appear) and instead we have the tell-tale broad $O-H$ peak at 3400 cm^{-1} . Heating drives off the water, and the second IR spectrum is of the resulting dry chloral: the $C=O$ peak has reappeared at 1770 cm^{-1} and the $O-H$ peak has gone.

Monomeric formaldehyde

The hydrated nature of formaldehyde poses a problem for chemistry that requires anhydrous conditions such as the organometallic additions we have just been talking about. Fortunately, cracking (heating to decomposition) the polymeric ‘paraformaldehyde’ can provide monomeric formaldehyde in anhydrous solution.

polymeric ‘paraformaldehyde’

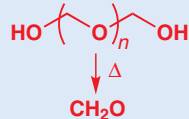

Chloral hydrate is the infamous ‘knockout drops’ of Agatha Christie or the ‘Mickey Finn’ of prohibition gangsters.

• Steric and electronic effects

- **Steric effects** are concerned with the size and shape of groups within molecules.
- **Electronic effects** result from the way that electronegativity differences between atoms affect the way electrons are distributed in molecules. They can be divided into *inductive effects*, which are the consequence of the way that electronegativity differences lead to polarization of σ bonds, and *conjugation* (sometimes called *mesomeric effects*) which affects the distribution of electrons in π bonds and is discussed in the next chapter.

Steric and electronic effects are two of the main factors dominating the reactivity of nucleophiles and electrophiles.

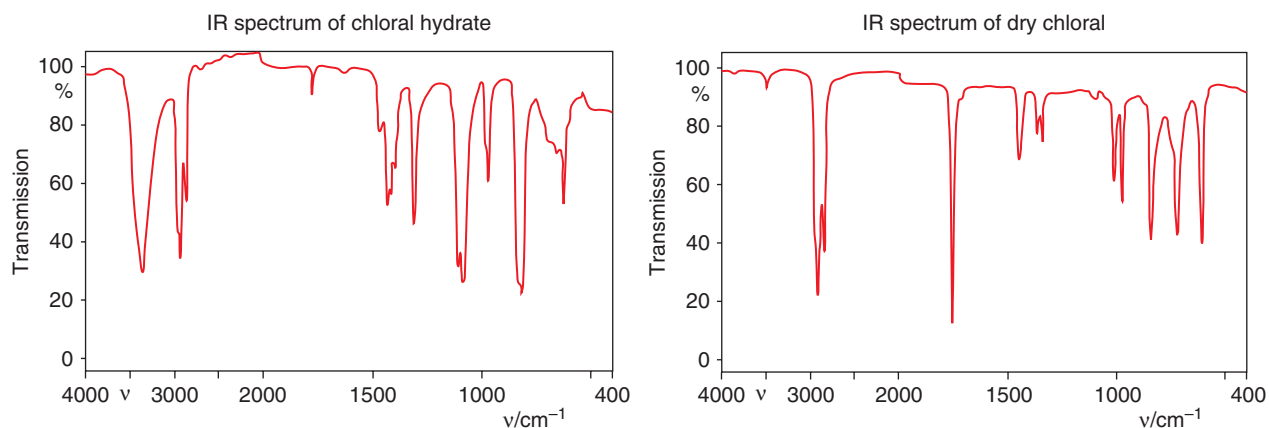

The chart shows the extent of hydration (in water) of a small selection of carbonyl compounds: hexafluoroacetone is probably the most hydrated carbonyl compound possible! The larger the equilibrium constant, the more the equilibrium is to the right.

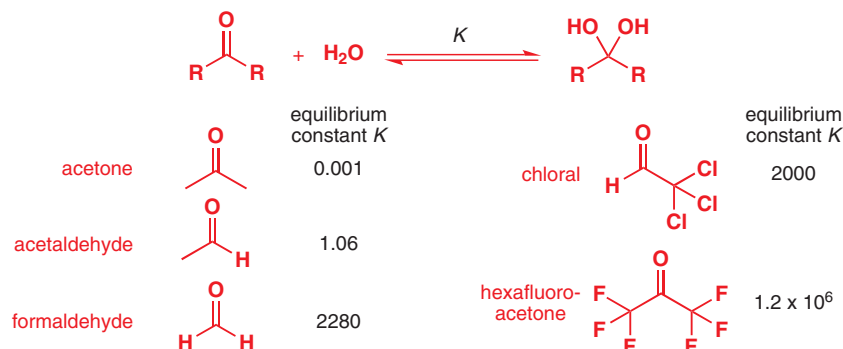

 Interactive structures of carbonyl compounds and hydrates

Cyclopropanones—three-membered ring ketones—are also hydrated to a significant extent, but for a different reason. You saw earlier how *acyclic* ketones suffer increased steric hindrance when the bond angle changes from 120° to 109° on moving from sp^2 to sp^3 hybridization. Cyclopropanones (and other small-ring ketones) conversely prefer the small bond angle because their substituents are already confined within a ring. Look at it this way: a three-membered ring is really very strained, with bond angles forced to be 60° . For the sp^2 hybridized ketone this means bending the bonds 60° away from their 'natural' 120° . But for the sp^3 hybridized hydrate the bonds have to be distorted by only 49° ($= 109^\circ - 60^\circ$). So addition to the C=O group allows some of the strain inherent in the small ring to be released—hydration is favoured, and indeed cyclopropanone and cyclobutanone are very reactive electrophiles.

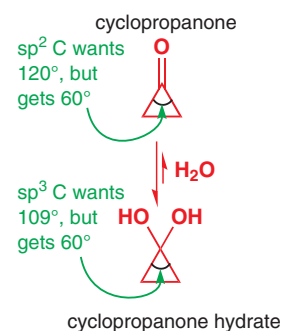

- The same structural features that favour or disfavour hydrate formation are important in determining the reactivity of carbonyl compounds with other nucleophiles, whether the reactions are reversible or not. Steric hindrance and more alkyl substituents make carbonyl compounds less reactive towards any nucleophile; electron-withdrawing groups and small rings make them more reactive.

Hemiacetals from reaction of alcohols with aldehydes and ketones

Since water adds to (at least some) carbonyl compounds, it should come as no surprise that alcohols do too. The product of the reaction is known as a hemiacetal, because it is halfway to

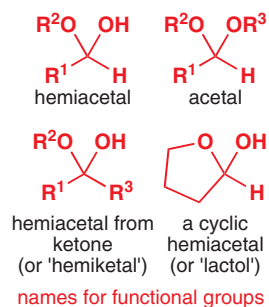

Interactive mechanism for hemiacetal formation

an acetal, a functional group that you met in Chapter 2 (p. 32) and that will be discussed in detail in Chapter 11. The mechanism follows in the footsteps of hydrate formation: just use ROH instead of HOH.

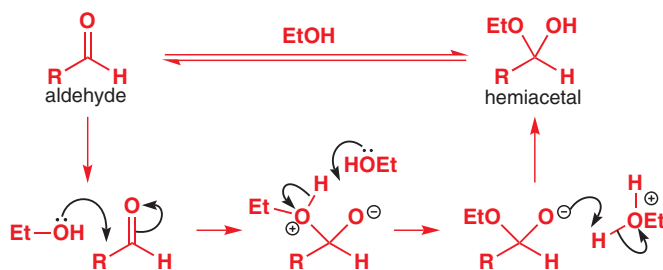

In the mechanism above, as in the mechanism of hydrate formation on p. 134, a proton has to be transferred between one oxygen atom and the other. We have shown a molecule of ethanol (or water) doing this, but it is impossible to define exactly the path taken by any one proton as it transfers between the oxygen atoms. It might not even be the same proton: another possible mechanism is shown below on the left, where a molecule of ethanol simultaneously gives away one proton and takes another. In the simplest case, the proton just hops from one oxygen to another, as shown in the right, and there is no shame in writing this mechanism: it is no more or less correct than the others.

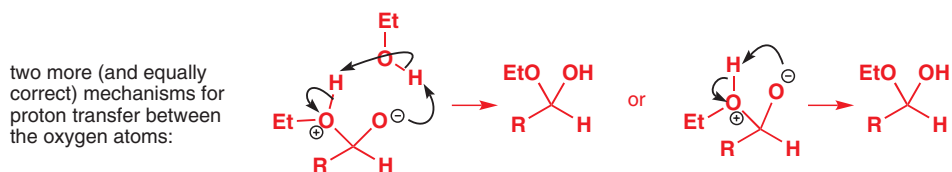

What is certain is that proton transfers between oxygen atoms are very fast and are reversible, and for that reason we don't need to be concerned with the details—the proton can always get to where it needs to be for the next step of the mechanism. As with all these carbonyl group reactions, what is really important is the addition step, not what happens to the protons.

Hemiacetal formation is reversible, and hemiacetals are stabilized by the same special structural features as those of hydrates. However, hemiacetals can also gain stability by being cyclic—when the carbonyl group and the attacking hydroxyl group are part of the same molecule. The reaction is now an intramolecular (within the same molecule) addition, as opposed to the intermolecular (between two molecules) ones we have considered so far.

Intermolecular reactions occur between two molecules.

Intramolecular reactions occur within the same molecule. We shall discuss the reasons why intramolecular reactions are more favourable and why cyclic hemiacetals and acetals are more stable in Chapters 11 and 12.

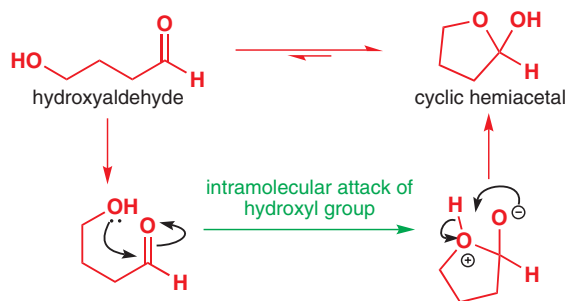

Although the cyclic hemiacetal (also called lactol) product is more stable, it is still in equilibrium with some of the open-chain hydroxyaldehyde form. Its stability, and how easily it

forms, depends on the size of the ring: five- and six-membered rings are free from strain (their bonds are free to adopt 109° or 120° angles—compare the three-membered rings on p. 135), and five- or six-membered hemiacetals are common. Among the most important examples are many sugars. Glucose, for example, is a hydroxyaldehyde that exists mainly as a six-membered cyclic hemiacetal (>99% of glucose is cyclic in solution), while ribose exists as a five-membered cyclic hemiacetal.

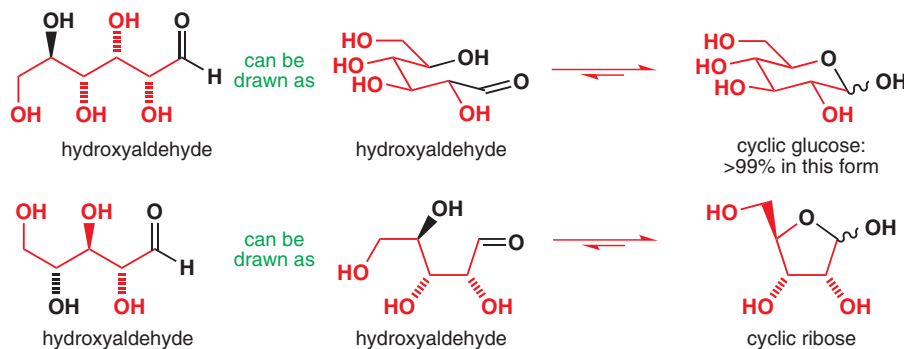

■ The way we have represented some of these molecules may be unfamiliar to you, although we first mentioned it in Chapter 2: we have shown **stereochemistry** (whether bonds come out of the paper or into it—the wiggly lines indicate a mixture of both) and, for the cyclic glucose, **conformation** (the actual shape the molecules adopt). These are very important in the sugars: we devote Chapter 14 to stereochemistry and Chapter 16 to conformation.

Ketones also form hemiacetals

Hydroxyketones can also form hemiacetals but, as you should expect, they usually do so less readily than hydroxyaldehydes. But we know that this hydroxyketone must exist as the cyclic hemiacetal as it has no $C=O$ stretch in its IR spectrum. The reason? The hydroxyketone is already cyclic, with the OH group poised to attack the ketone—it can't get away so cyclization is highly favoured.

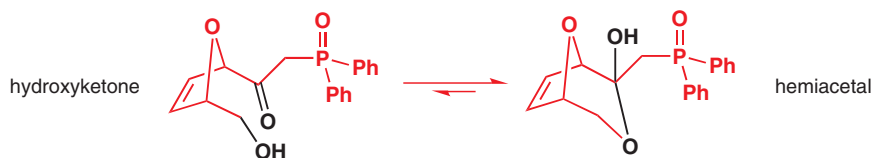

Acid and base catalysis of hemiacetal and hydrate formation

In Chapter 8 we shall look in detail at acids and bases, but at this point we need to tell you about one of their important roles in chemistry: they act as catalysts for a number of carbonyl addition reactions, among them hemiacetal and hydrate formation. To see why, we need to look back at the mechanisms of hemiacetal formation on p. 138 and hydrate formation on p. 134. Both involve proton-transfer steps, which we can choose to draw like this:

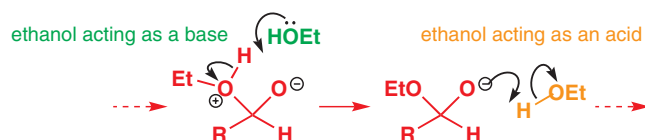

In the first proton-transfer step, ethanol acts as a **base**, removing a proton; in the second it acts as an **acid**, donating a proton. You saw in Chapter 5 how water can also act as an acid or a base. Strong acids or strong bases (for example HCl or NaOH) increase the rate of hemiacetal or hydrate formation because they allow these proton-transfer steps to occur *before* the addition to the carbonyl group.

In acid (dilute HCl, say), the mechanism is different in detail. The first step is now protonation of the carbonyl group's lone pair: the positive charge makes it much more electrophilic

so the addition reaction is faster. Notice how the proton added at the beginning is lost again at the end—it is really a catalyst.

■ In acid it is also possible for the hemiacetal to react further with the alcohol to form an acetal, but this is dealt with in Chapter 11 and need not concern you at present.

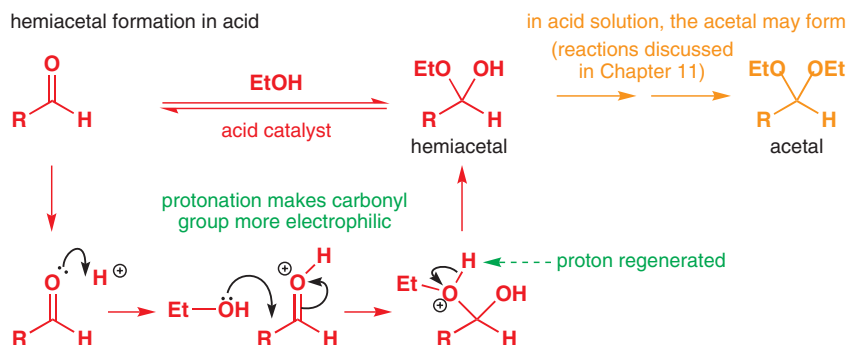

The mechanism in basic solution is slightly different again. The first step is now deprotonation of the ethanol by hydroxide, which makes the addition reaction faster by making the ethanol more nucleophilic. Again, base (hydroxide) is regenerated in the last step, making the overall reaction catalytic in base.

■ As you will see in Chapter 11, the reaction in base always stops with the hemiacetal—acetals never form in base.

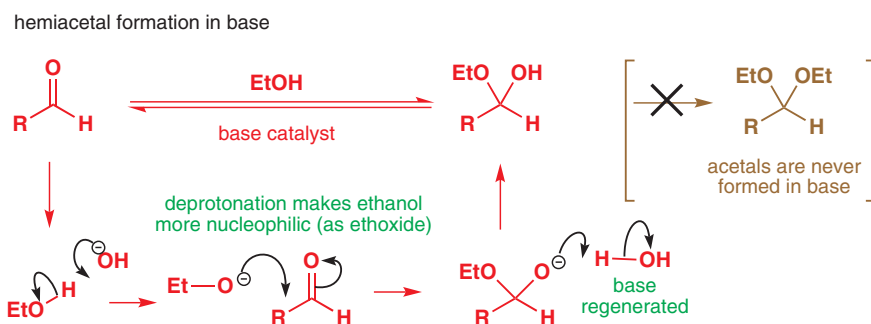

The final step could equally well involve deprotonation of ethanol to give alkoxide—and alkoxide could equally well do the job of catalysing the reaction. In fact, you will often come across mechanisms with the base represented just as 'B⁻' because it doesn't matter what the base is.

● For nucleophilic additions to carbonyl groups:

- acid catalysts work by making the carbonyl group more electrophilic
- base catalysts work by making the nucleophile more nucleophilic
- both types of catalysts are regenerated at the end of the reaction.

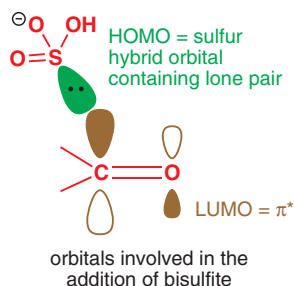

Bisulfite addition compounds

The last nucleophile of this chapter, sodium bisulfite (NaHSO_3) adds to aldehydes and some ketones to give what is usually known as a **bisulfite addition compound**. The reaction occurs by nucleophilic attack of a lone pair on the carbonyl group, just like the attack of cyanide. This leaves a positively charged sulfur atom but a simple proton transfer leads to the product.

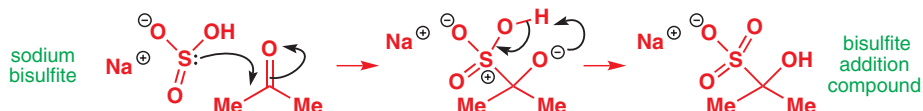

The products are useful for two reasons. They are usually crystalline and so can be used to purify liquid aldehydes by recrystallization. This is of value only because this reaction, like

several you have met in this chapter, is reversible. The bisulfite compounds are made by mixing the aldehyde or ketone with saturated aqueous sodium bisulfite in an ice bath, shaking, and crystallizing. After purification the bisulfite addition compound can be hydrolysed back to the aldehyde in dilute aqueous acid or base.

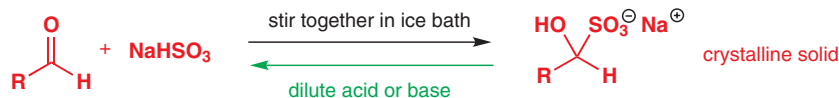

The reversibility of the reaction makes bisulfite compounds useful intermediates in the synthesis of other adducts from aldehydes and ketones. For example, one practical method for making cyanohydrins involves bisulfite compounds. The famous practical book 'Vogel' suggests reacting acetone first with sodium bisulfite and then with sodium cyanide to give a good yield (70%) of the cyanohydrin.

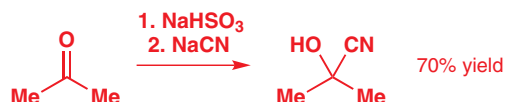

What is happening here? The bisulfite compound forms first, but only as an intermediate on the route to the cyanohydrin. When the cyanide is added, reversing the formation of the bisulfite compound provides the single proton necessary to give back the hydroxyl group at the end of the reaction. No dangerous HCN is released (always a hazard when cyanide ions and acid are present together).

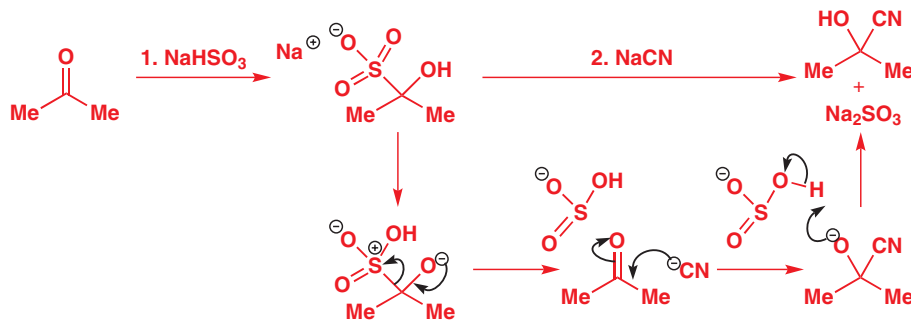

Other compounds from cyanohydrins

Cyanohydrins can be converted by simple reactions into hydroxyacids or amino alcohols. Here is one example of each, but you will have to wait until Chapter 10 for the details and the mechanisms of the reactions. Note that one cyanohydrin was made by the simplest method—simply NaCN and acid—while the other came from the bisulfite route we have just discussed.

hydroxyacids by hydrolysis of CN in cyanohydrin

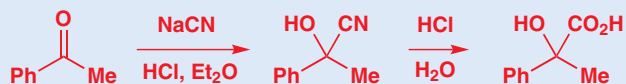

amino alcohols by reduction of CN in cyanohydrin

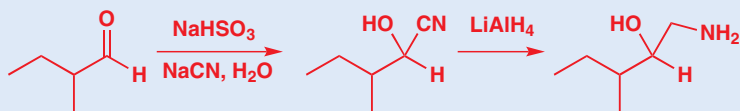

The second reason that bisulfite compounds are useful is that they are soluble in water. Some small (that is, low molecular weight) aldehydes and ketones are water-soluble—acetone is an example. But most larger (more than four or so carbon atoms) aldehydes and ketones are not.

■ The structure of NaHSO₃, sodium bisulfite, is rather curious. It is an oxyanion of a sulfur(IV) compound with a lone pair of electrons—the HOMO—on the sulfur atom, but the charge is formally on the more electronegative oxygen. As a 'second-row' element (second row of the periodic table, that is) sulfur can have more than just eight electrons—it's all right to have four, five, or six bonds to S or P, unlike, say, B or O. Second-row elements have d orbitals as well as s and p so they can accommodate more electrons.

This does not usually matter to most chemists as we often want to carry out reactions in organic solvents rather than water. But it can matter to medicinal chemists, who make compounds that need to be compatible with biological systems. And in one case, the solubility of bisulfite adduct in water is literally vital.

Dapsone is an antileprosy drug. It is a very effective one too, especially when used in combination with two other drugs in a 'cocktail' that can be simply drunk as an aqueous solution by patients in tropical countries without any special facilities, even in the open air. But there is a problem! Dapsone is insoluble in water. The solution is to make a bisulfite compound from it. You may ask how this is possible since dapsone has no aldehyde or ketone—just two amino groups and a sulfone. The trick is to use the formaldehyde bisulfite compound and exchange the OH group for one of the amino groups in dapsone.

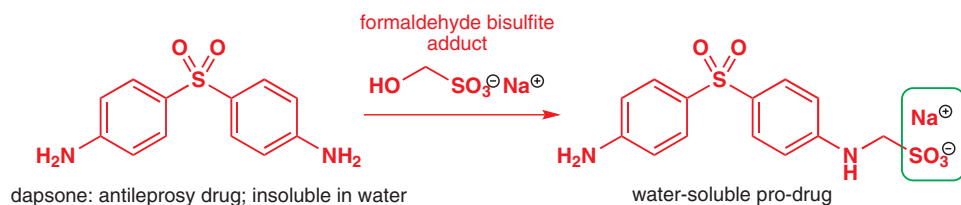

Now the compound will dissolve in water and release dapsone inside the patient. The details of this sort of chemistry will come in Chapter 11, when you will meet imines as intermediates. But at this stage we just want you to appreciate that even the relatively simple chemistry in this chapter is useful in synthesis, in commerce, and in medicine.

Further reading

Section 1, 'Nucleophilic addition to the carbonyl group' in S. Warren, *Chemistry of the Carbonyl Group*, Wiley, Chichester, 1974, and P. Sykes, *A Guidebook to Mechanism in Organic Chemistry*, 6th edn, Longman, Harlow, 1986, pp. 203–219. For a more theoretical approach, we suggest J. Keeler and P. Wothers, *Why Chemical Reactions Happen*, OUP, Oxford, 2003, especially pp. 102–106.

For further, more advanced, details of the cassava–HCN problem: D. Siritunga, D. Arias-Garzon, W. White, and R. T. Sayre, *Plant Biotechnology Journal*, 2004, 2, 37. For details of cyanohydrin formation using sodium bisulfite: B. S. Furniss, A. J. Hannaford, P. W. G. Smith, and A. T. Tatchell, *Vogel's Textbook of Practical Organic Chemistry*, 5th edn, Longman, Harlow, 1989, pp. 729–730.

Check your understanding



To check that you have mastered the concepts presented in this chapter, attempt the problems that are available in the book's Online Resource Centre at <http://www.oxfordtextbooks.co.uk/orc/clayden2e/>

Delocalization and conjugation

Connections

➔ Building on

- Orbitals and bonding **ch4**
- Representing mechanisms by curly arrows **ch5**
- Ascertaining molecular structure spectroscopically **ch3**

Arriving at

- Interaction between orbitals over many bonds
- Stabilization by the sharing of electrons over more than two atoms
- Where colour comes from
- Molecular shape and structure determine reactivity
- Representing one aspect of structure by curly arrows
- Structure of aromatic compounds

➔ Looking forward to

- Acidity and basicity **ch8**
- How conjugation affects reactivity **ch10, ch11, & ch15**
- Conjugate addition and substitution **ch22**
- Chemistry of aromatic compounds **ch21 & ch22**
- Enols and enolates **ch20, ch24–ch27**
- Chemistry of heterocycles **ch29 & ch30**
- Chemistry of dienes and polyenes **ch34 & ch35**
- Chemistry of life **ch42**

Introduction

As you look around you, you will be aware of many different colours—from the greens and browns outside to the bright blues and reds of the clothes you are wearing. All these colours result from the interaction of light with the pigments in these different things—some frequencies of light are absorbed, others scattered. Inside our eyes, chemical reactions detect these different frequencies and convert them into electrical nerve impulses sent to the brain. All these pigments have one thing in common—lots of double bonds. For example, the pigment responsible for the red colour in tomatoes, lycopene, is a long-chain polyalkene.

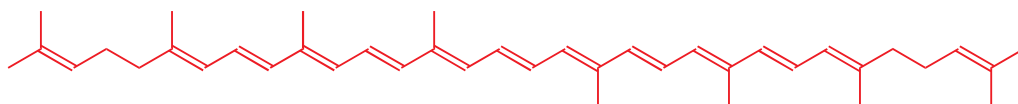

lycopene, the red pigment in tomatoes, rose hips, and other berries

Lycopene contains only carbon and hydrogen; many pigments contain other elements. But nearly all contain double bonds—and many of them. This chapter is about the properties, including colour, of molecules that have several double bonds. These properties depend on the way the double bonds join up, or *conjugate*, and the resulting *delocalization* of the electrons within them.

In earlier chapters we talked about carbon skeletons made up of σ bonds. In this chapter we shall see how, in some cases, we can also have a large π framework spread over many atoms and how this dominates the chemistry of such compounds. We shall see how this π framework is responsible for the otherwise unexpected *stability* of certain cyclic polyunsaturated

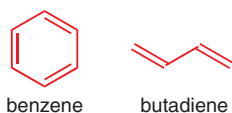

compounds, including benzene, but also *reactivity* in others, such as butadiene. We shall also see how this π framework gives rise to colour. To understand such molecules properly, we need to start with the simplest of all unsaturated compounds, ethene.

The structure of ethene (ethylene, $\text{CH}_2=\text{CH}_2$)

The structure of ethene (ethylene) is well known. It has been determined by electron diffraction and is **planar** (all atoms are in the same plane), with the bond lengths and angles shown on the left. The carbon atoms are roughly trigonal and the C=C bond distance is shorter than that of a typical C–C single bond. The electronic structure of ethene, you will recall from Chapter 4, can be considered in terms of two sp^2 hybridized C atoms with a σ bond between them and four σ bonds linking them each to two H atoms. The π bond is formed by overlap of a p orbital on each carbon atom.

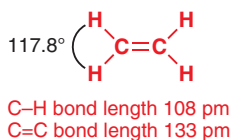

Interactive bonding orbitals in ethene

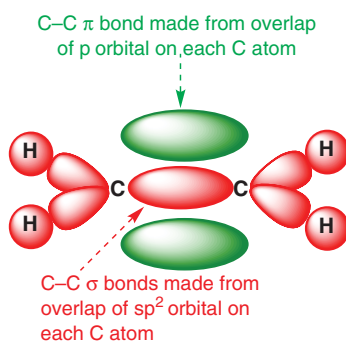

Ethene is chemically more interesting than *ethane* because of the π system. As you saw in Chapter 5, alkenes can be nucleophiles because the electrons in the π bond are available for donation to an electrophile. But remember that when we combine *two* atomic orbitals we get *two* molecular orbitals, from combining the p orbitals either in phase or out of phase. The in-phase combination accounts for the bonding molecular orbital (π), whilst the out-of-phase combination accounts for the antibonding molecular orbital (π^*). The shapes of the orbitals as they were introduced in Chapter 4 are shown below, but in this chapter we will also represent them in the form shown in the brown boxes—as the constituent p orbitals.

We described the structure of ethene in Chapter 4 (p. 101)

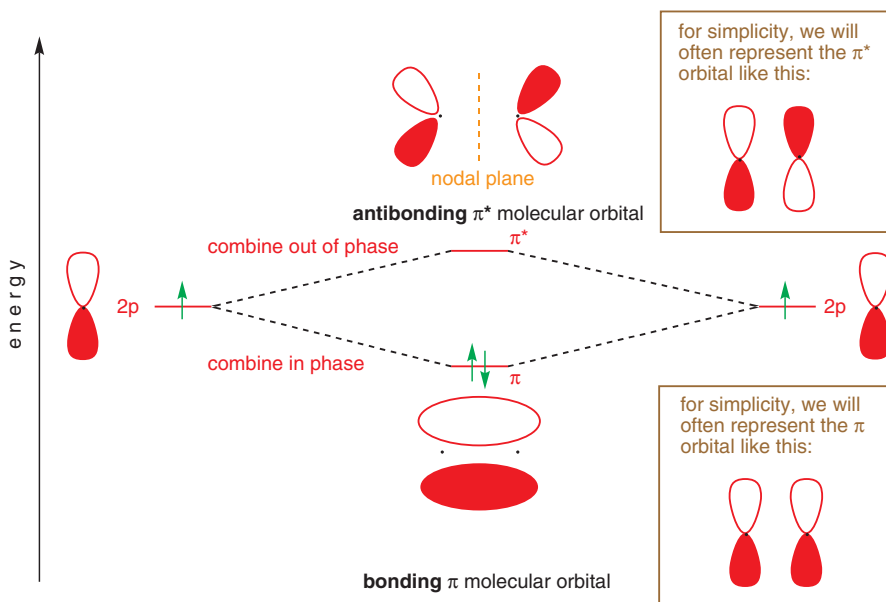

Molecules with more than one C=C double bond

Benzene has three strongly interacting double bonds

The rest of this chapter concerns molecules with more than one C=C double bond and what happens to the π orbitals when they interact. To start, we shall take a bit of a jump and look at the structure of benzene. Benzene has been the subject of considerable controversy since its discovery in 1825. It was soon worked out that the formula was C_6H_6 , but how were these atoms arranged? Some strange structures were suggested until Kekulé proposed the correct structure in 1865.

Shown below are the molecular orbitals for Kekulé's structure. As in simple alkenes, each of the carbon atoms is sp^2 hybridized, leaving the remaining p orbital free.

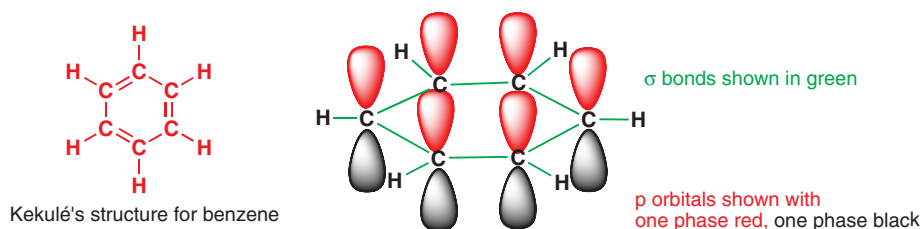

The σ framework of the benzene ring is like the framework of an alkene, and for simplicity we have just represented the σ bonds as green lines. The difficulty comes with the p orbitals—which pairs do we combine to form the π bonds? There seem to be two possibilities.

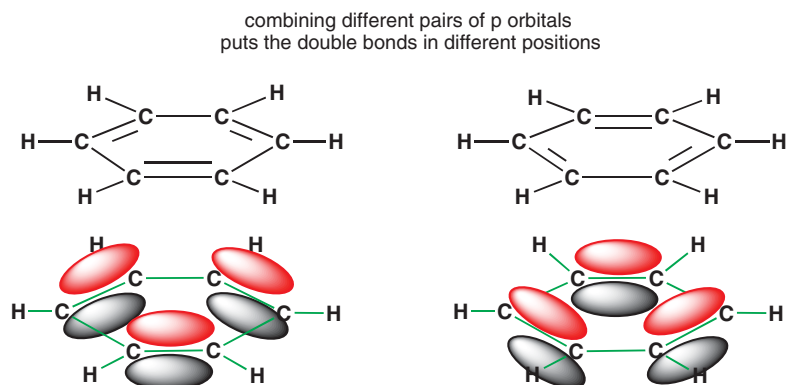

With benzene itself, these two forms are identical but, if we had a 1,2- or a 1,3-disubstituted benzene compound, these two forms would be different. A synthesis was designed for the two compounds in the box on the right but it was found that both compounds were identical. This posed a problem to Kekulé—his structure didn't seem to work after all. His solution—which we now know to be incorrect—was that benzene rapidly equilibrates, or 'resonates', between the two forms to give an averaged structure in between the two.

The molecular orbital answer to this problem is that all six p orbitals can combine to form (six) new molecular orbitals, and the electrons in these orbitals form a ring of electron density above and below the plane of the molecule. Benzene *does not resonate* between the two Kekulé structures—the electrons are in molecular orbitals spread equally over all the carbon atoms. However, the term 'resonance' is still sometimes used (but not in this book) to describe the averaging effect of this mixing of molecular orbitals. We shall describe the π electrons in benzene as **delocalized**, that is, no longer localized in specific double bonds between two particular carbon atoms but spread out, or delocalized, over all six atoms in the ring.

The two early proposals for the structure of benzene were wrong, but nonetheless are stable isomers of benzene (they are both C_6H_6) which have since been synthesized. For more on the Kekulé structure, see p. 24.

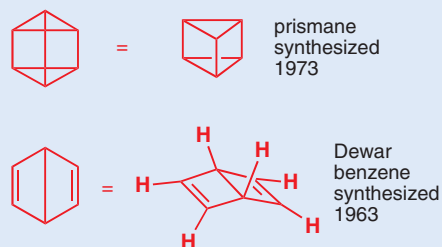

■ For example, if the double bonds were localized then these two compounds would be chemically different. (The double bonds are drawn shorter than the single bonds to emphasize the difference.)

in reality these are the same compound

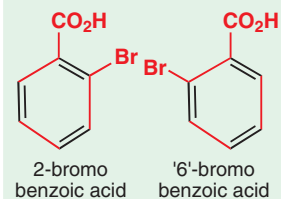



the circle represents the delocalized system

The alternative drawing on the left shows the π system as a ring and does not put in the double bonds: you may feel that this is a more accurate representation, but it does present a problem when it comes to writing mechanisms. As you saw in Chapter 5, the curly arrows we use represent two electrons. The circle here represents *six* electrons, so in order to write reasonable mechanisms we still need to draw benzene *as though* the double bonds were localized. However, when you do so, you must keep in mind that the electrons are delocalized, and it does not matter which of the two arrangements of double bonds you draw.

If we want to represent delocalization using these ‘localized’ structures, we can do so using curly arrows. Here, for example, are the two ‘localized’ structures corresponding to 2-bromocarboxylic acid. The double bonds are not localized, and the relationship between the two structures can be represented with curly arrows which indicate how one set of bonds map onto the other.

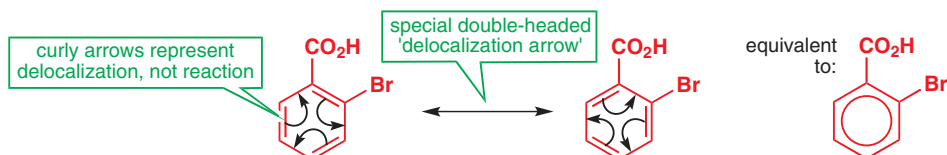

■ The delocalization arrow is used to connect two representations of the same structure. Don't get it confused with an equilibrium arrow, which is used to show two structures interconverting. In an equilibrium, at least one σ bond must change place.

delocalization arrow

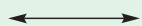

equilibrium arrow



These curly arrows are similar to the ones we introduced in Chapter 5, but there is a crucial difference: here, there is no reaction taking place. In a real reaction, electrons move. Here, they do not: the only things that ‘move’ are the double bonds in the structures. The curly arrows just show the link between alternative representations of exactly the same molecule. You must not think of them as showing ‘movement round the ring’. To emphasize this difference we also use a different type of arrow connecting them—a delocalization arrow made up of a single line with an arrow at each end. Delocalization arrows remind us that our simple fixed-bond structures do not tell the whole truth and that the real structure is a mixture of both.

The fact that *the π electrons are not localized* in alternating double bonds but are *spread out over the whole system* in a ring is supported by theoretical calculations and confirmed by experimental observations. Electron diffraction studies show benzene to be a regular planar hexagon with all the carbon–carbon bond lengths identical (139.5 pm). This bond length is in between that of a carbon–carbon single bond (154.1 pm) and a full carbon–carbon double bond (133.7 pm). A further strong piece of evidence for this ring of electrons is revealed by proton NMR and discussed in Chapter 13.

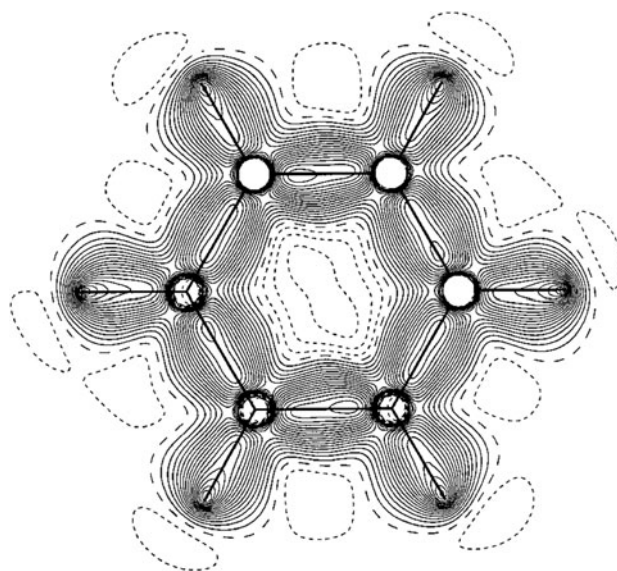

Electron diffraction image of a molecule of benzene

How to describe delocalization?

What words should be used to describe delocalization is a vexed question. Terms such as *resonance*, *mesomerism*, *conjugation*, and *delocalization* are only a few of the ones you will find in books. You will already have noticed that we're avoiding *resonance* because it carries a suggestion that the structure is somehow oscillating between localized structures. We shall use the words *conjugation* and *delocalization*: *conjugation* focuses on the way that double bonds link together into a single π system, while *delocalization* focuses on the electrons themselves. Adjacent double bonds, as you will see, are *conjugated*; the electrons in them are *delocalized*.

Multiple double bonds not in a ring

Are electrons still delocalized even when there is no ring? To consider this, we'll look at hexatriene—three double bonds and six carbons, like benzene, but without the ring. There are two isomers of hexatriene, with different chemical and physical properties, because the central double bond can adopt a *cis* or a *trans* geometry. The structures of both *cis*- and *trans*-hexatriene have been determined by electron diffraction and two important features emerge:

- Both structures are essentially planar.
- Unlike benzene, the double and single bonds have different lengths, but the central double bond in each case is slightly longer than the end double bonds and the single bonds are slightly shorter than a 'standard' single bond.

Here's the most stable structure of *trans*-hexatriene, with benzene shown for comparison.

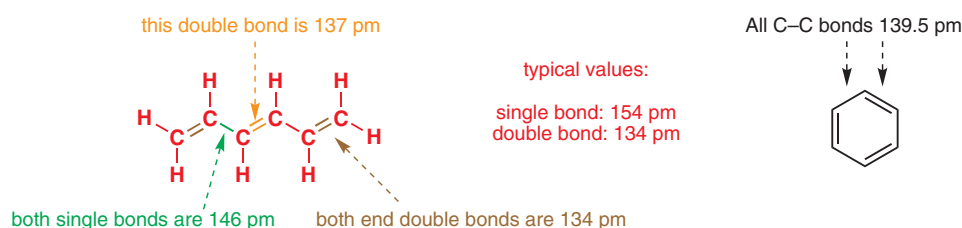

The reason for the deviation of the bond lengths from typical values and the preference for planar structures is again due to the molecular orbitals which arise from the combination of the six p orbitals. Just as in benzene, these orbitals can combine to give one molecular orbital stretching over the whole molecule. The p orbitals can overlap and combine only if the molecule is planar.

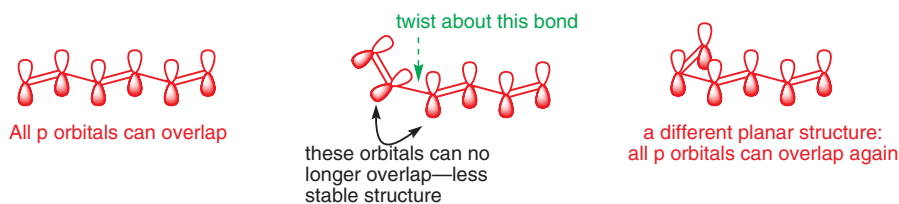

If the molecule is twisted about one of the single bonds, then some overlap is lost, making it harder to twist about the single bonds in this structure than in a simple alkene. Other planar arrangements are stable, however, and *trans*-hexatriene can adopt any of the planar conformations shown in the margin.

Conjugation

In benzene and hexatriene every carbon atom is sp^2 hybridized with one p orbital available to overlap with its neighbours. The uninterrupted chain of p orbitals is a consequence of having alternate double and single bonds. When two double bonds are separated by just one single bond, the two double bonds are said to be *conjugated*. Conjugated double bonds have different properties from isolated double bonds, both physically (they are often longer, as you have just seen) and chemically (see Chapters 22).

You have already met several conjugated systems: lycopene at the start of this chapter and β -carotene in Chapter 3, for example. Each of the 11 double bonds in β -carotene is separated

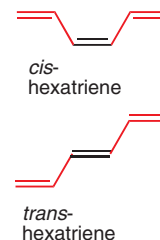

■ The terminal double bonds can't have two forms because they have only one substituent.

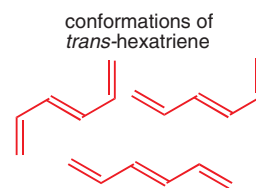

➔ Conformation is the topic of Chapter 16.

Conjugation

In the dictionary 'conjugated' is defined, among other ways, as 'joined together, especially in pairs' and 'acting or operating as if joined'. This does indeed fit very well with the behaviour of such conjugated double bonds, since the properties of a conjugated system are different from those of the component parts.

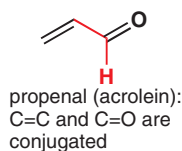

■ The chemistry of such conjugated carbonyl compounds is significantly different from the chemistry of the component parts. The alkene in propenal, for example, is electrophilic and not nucleophilic. This will be explained in Chapter 22.

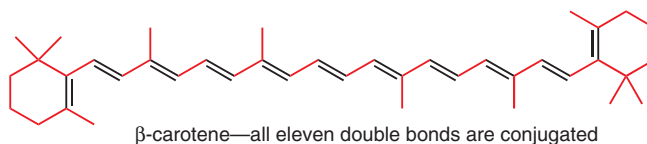

It is not necessary to have two C=O double bonds in order to have a conjugated system—the C=C and C=O double bonds of propenal (acrolein) are also conjugated. What is important is that the double bonds are separated by *one and only one* single bond. Here's a counter-example: arachidonic acid is one of the fabled 'polyunsaturated' fatty acids. None of the four double bonds in this structure are conjugated since in between any two double bonds there is an sp^3 carbon. This means that there is no p orbital available to overlap with the ones from the double bonds. The saturated carbon atoms 'insulate' the double bonds from each other and prevent conjugation.

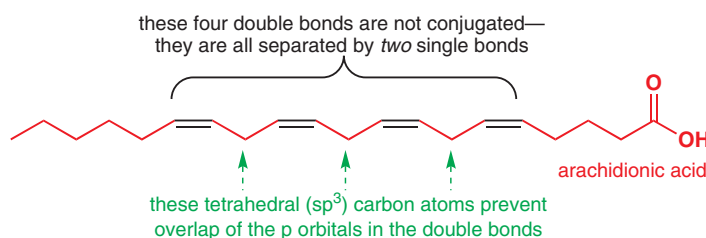

If an atom has two double bonds directly attached to it, that is, there are no single bonds separating them, again no conjugation is possible. The simplest compound with such an arrangement is allene. The arrangement of the p orbitals in allene means that no delocalization is possible because the two π bonds are perpendicular to each other.

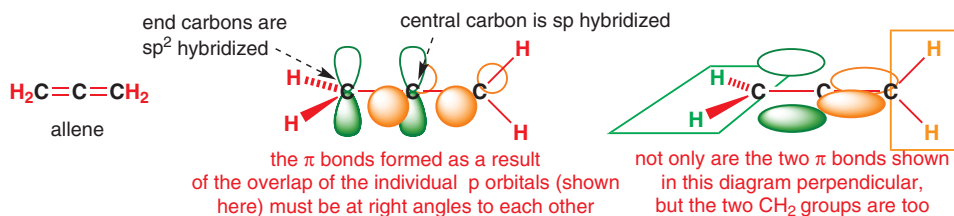

Interactive bonding orbitals in allene

● Requirements for conjugation

- Conjugation requires double bonds separated by one single bond.
- Double bonds separated by two single bonds or no single bonds are not conjugated.

Isomers of butadiene

Butadiene normally refers to 1,3-butadiene. It is also possible to have 1,2-butadiene, which is another example of an allene.

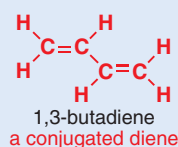
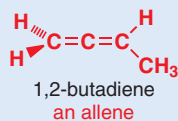

The conjugation of two π bonds

To understand the effects of conjugation on molecules, we need now to look at their molecular orbitals. We'll concentrate only on the electrons in π orbitals—you can take it that all the C–C and C–H σ bonds are essentially the same as those of all the other molecules you met in Chapter 4. We'll start with the simplest compound that can have two conjugated π bonds: butadiene. As you would expect, butadiene prefers to be planar to maximize overlap between its p orbitals. But exactly how does that overlap happen, and how does it give rise to bonding?

The molecular orbitals of butadiene

Butadiene has two π bonds, each made up of two p orbitals: a total of four atomic orbitals. We'd therefore expect four molecular orbitals, housing four electrons. Just like

hexatriene above, these orbitals extend over the whole molecule, but we can easily work out what these molecular orbitals look like simply by taking the orbitals of two alkenes and interacting them side by side. We have two π orbitals and two π^* orbitals, and we can interact them in phase or out of phase. Here are the first two, made by interacting the two π orbitals:



and the next two, made from two π^* orbitals:

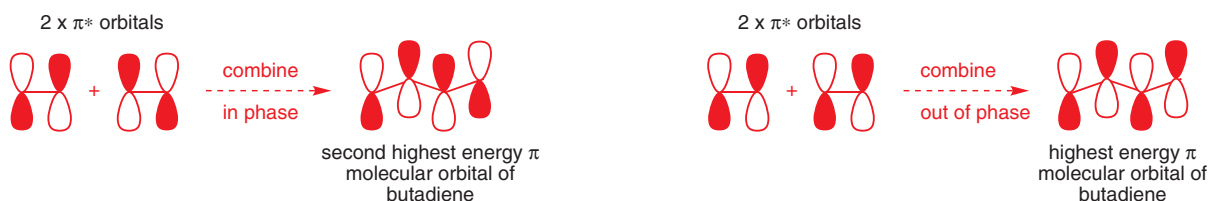

We can represent all four molecular orbitals like this, stacked up in order of their energy in a molecular orbital energy level diagram. With four orbitals, we can't just use '*' to represent antibonding orbitals, so conventionally they are numbered ψ_1 – ψ_4 (ψ is the Greek letter psi).

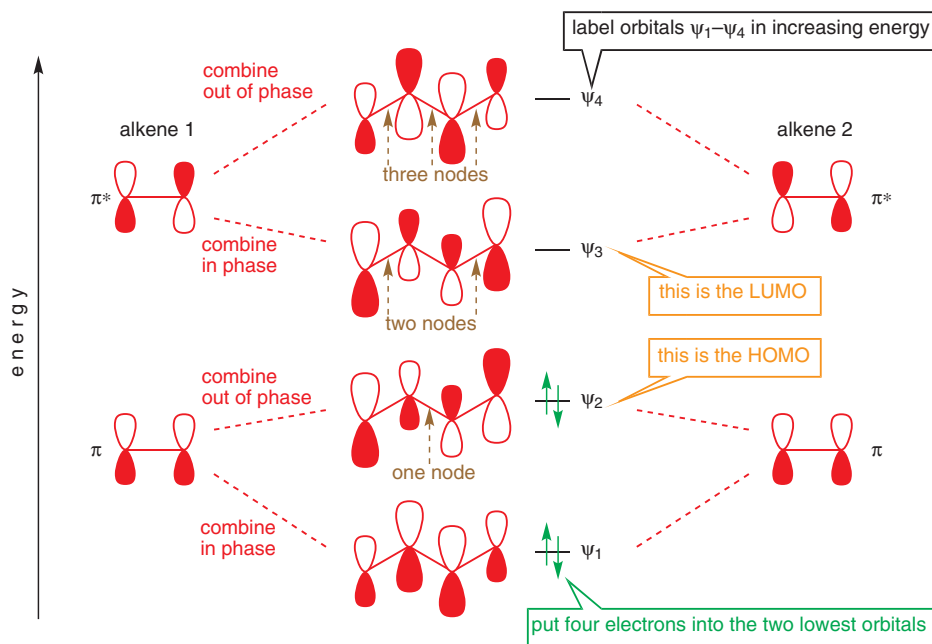

Interactive bonding orbitals in butadiene

➔ The idea that higher energy orbitals have more nodes is familiar to you from Chapter 4—see p. 88.

It's worth noticing a couple of other things about the way we have represented these four molecular orbitals before we move on. Firstly, the number of nodes (changes in phase as you move from one orbital to the next) increases from zero in ψ_1 to three in ψ_4 . Secondly, notice that the p orbitals making up the π system are not all shown as the same size—their *coefficients* vary according to the orbital they are in. This is a mathematical consequence of the way the orbitals sum together, and you need not be concerned with the details, just the general principle that ψ_1 and ψ_4 have the largest coefficients in the middle; ψ_2 and ψ_3 the largest coefficients at the ends.

Now for the electrons: each orbital holds two electrons, so the four electrons in the π system go into orbitals ψ_1 and ψ_2 .

The term 'coefficient' describes the contribution of an individual atomic orbital to a molecular orbital. It is represented by the size of the lobes on each atom.

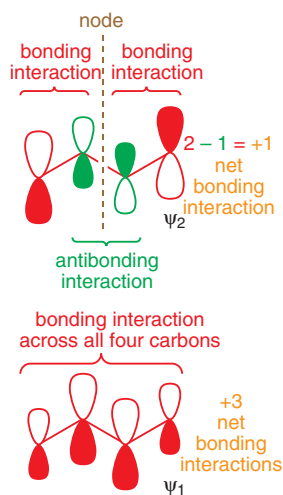

■ In our glimpse of hexatriene earlier in this chapter we saw similar effects: a tendency to be planar and restriction to rotation about the slightly shortened single bonds.

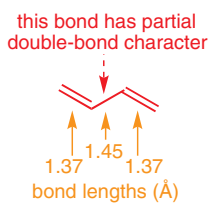

it takes 30 kJ mol^{-1} to rotate about this bond

it takes 3 kJ mol^{-1} to rotate about this single bond

rotation about a full double bond needs more than 260 kJ mol^{-1} : it's essentially impossible

A closer look at these filled orbitals shows that in ψ_1 , the lowest energy bonding orbital, the electrons are spread out over all four carbon atoms (above and below the plane) in one continuous orbital. There is bonding between all four C atoms—three net bonding interactions. ψ_2 has bonding interactions between carbon atoms 1 and 2, and also between 3 and 4 but an *antibonding* interaction between carbons 2 and 3—in other words, $2 - 1 = 1$ net bonding interaction. For the unoccupied orbitals there is a net -1 antibonding interaction in ψ_3 and a net -3 antibonding interaction in ψ_4 .

Overall, in both the occupied π orbitals there are electrons between carbons 1 and 2 and between 3 and 4, but the antibonding interaction between carbons 2 and 3 in ψ_2 partially cancels out the bonding interaction in ψ_1 . Only 'partially', because the coefficients of the antibonding pair of orbitals in ψ_2 are smaller than the coefficients of the bonding pair in ψ_1 . This explains why all the bonds in butadiene are not the same, and also why the middle bond is like a single bond but with a little bit of double-bond character. Its double-bond character extends to its preference for planarity, the fact that it takes more energy to rotate about this bond than about a typical single bond, and the fact that it is slightly shorter (1.45 Å) than a typical C–C single bond (around 1.54 Å).

The molecular orbital diagram also helps us explain some aspects of the reactivity of butadiene. Notice that we have marked on for you the HOMO (ψ_2) and the LUMO (ψ_3). On either side you can see the equivalent HOMO (π orbital) and LUMO (π^* orbital) for the isolated alkene (i.e. ethene). Some relevant features to note:

- The overall energy of the two bonding butadiene molecular orbitals is lower than that of the two molecular orbitals for ethene. This means that conjugated butadiene is more thermodynamically stable than just two isolated double bonds.
- The HOMO of butadiene is *higher* in energy than the HOMO for ethene. This is consistent with the fact that butadiene is *more* reactive than ethene towards electrophiles.
- The LUMO for butadiene is *lower* in energy than the LUMO for ethene. This is consistent with the fact that butadiene is *more* reactive than ethene towards nucleophiles.

■ To understand this section well you will need to remember the formulae linking energy and wavelength, $E = h\nu$, and energy and frequency, $E = hc/\lambda$. See p. 53 for more on these.

So conjugation makes butadiene more stable, but it also makes it more reactive to both nucleophiles and electrophiles! This superficially surprising result is revisited in detail in Chapter 19.

UV and visible spectra

In Chapter 2 you saw how, if given the right amount of energy, electrons can be promoted from a low-energy atomic orbital to a higher energy one and how this gives rise to an atomic absorption spectrum. Exactly the same process can occur with molecular orbitals: energy of the right wavelength can promote an electron from a filled orbital (for example the HOMO) to an unfilled one (for example the LUMO), and plotting the absorption of energy against wavelength gives rise to a new type of spectrum called, for obvious reasons which you will see in a moment, a UV–visible spectrum.

You have just seen that the energy difference between the HOMO and LUMO for butadiene is less than that for ethene. We would therefore expect butadiene to absorb light of longer

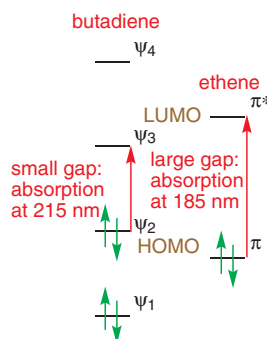

wavelength than ethene (the longer the wavelength the lower the energy). This is indeed the case: butadiene absorbs at 215 nm compared to 185 nm for ethene. The conjugation in butadiene means it absorbs light of a longer wavelength than ethene. One of the consequences of conjugation is to lessen the gaps between filled and empty orbitals, and so allow absorption of light of a longer wavelength.

UV absorption in ethene and butadiene

● The more conjugated a compound is, the smaller the energy transition between its HOMO and LUMO, and hence the longer the wavelength of light it can absorb. UV–visible spectroscopy can tell us about the conjugation present in a molecule.

Both ethene and butadiene absorb in the UV region of the electromagnetic spectrum. If we extend the conjugation further, the gap between HOMO and LUMO will eventually be small enough to allow the compound to absorb visible light and hence have a colour. Lycopene, the pigment in tomatoes, which we introduced at the start of the chapter, has 11 conjugated double bonds (plus two unconjugated ones). It absorbs blue–green light at about 470 nm: consequently tomatoes are red. Chlorophyll, in the margin, has a cyclic conjugated system: it absorbs at long wavelengths and is green.

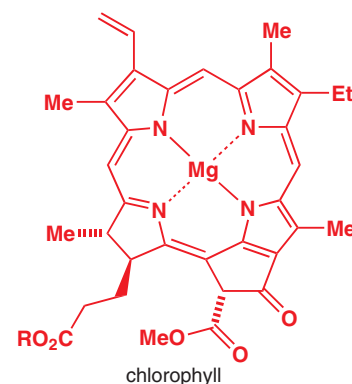
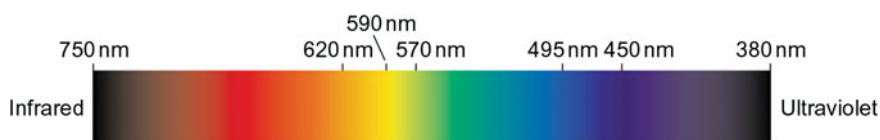

The colour of pigments depends on conjugation

It is no coincidence that these and many other highly conjugated compounds are coloured. All dyes and pigments based on organic compounds are highly conjugated.

The table below shows the approximate wavelengths of light absorbed by a polyene conjugated system containing various numbers n of double bonds. Note that the colour absorbed is complementary to the colour transmitted—a red compound must absorb blue and green light to appear red.

Approximate wavelengths for different colours

Absorbed frequency, nm	Colour absorbed	Colour transmitted	$R(\text{CH}=\text{CH})_n\text{R}$, $n =$
200–400	ultraviolet	—	< 8
400	violet	yellow–green	8
425	indigo–blue	yellow	9
450	blue	orange	10
490	blue–green	red	11
510	green	purple	
530	yellow–green	violet	
550	yellow	indigo–blue	
590	orange	blue	
640	red	blue–green	
730	purple	green	

Fewer than about eight conjugated double bonds, and the compound absorbs only in the UV. With more than eight conjugated double bonds, the absorption creeps into the visible and, by the time it reaches 11, the compound is red. Blue or green polyenes are rare, and dyes of these colours rely on more elaborate conjugated systems.

In colour chemistry, *dye* is a soluble colorant while a *pigment* is made of insoluble coloured particles. In biology the word pigment is used for any coloured compound. Dyeing pigments are often inorganic compounds, which are coloured for reasons other than conjugation, but nonetheless to do with the gaps between orbitals.

UV absorption in linear conjugated polyenes

Blue jeans

Transitions from bonding to antibonding π orbitals are called $\pi \rightarrow \pi^*$ transitions. If electrons are instead promoted from a non-bonding lone pair (n orbital) to a π^* orbital (an $n \rightarrow \pi^*$ transition) smaller energy gaps may be available, and many dyes make use of $n \rightarrow \pi^*$ transitions to produce colours throughout the whole spectrum. For example, the colour of blue jeans comes from the pigment indigo. The two nitrogen atoms provide the lone pairs that can be excited into the π^* orbitals of the rest of the molecule. These are low in energy because of the two carbonyl groups. Yellow light is absorbed by this pigment and indigo–blue light is transmitted.

Jeans are dyed by immersion in a vat of reduced indigo, which is colourless since the conjugation is interrupted by the central single bond. When the cloth is hung up to dry, the oxygen in the air oxidizes the pigment to indigo and the jeans turn blue.

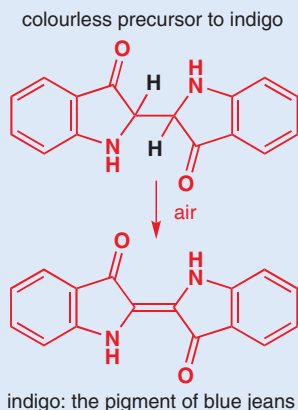

The allyl system

The allyl anion

In butadiene, four atomic p orbitals interact to make four molecular orbitals; in hexatriene (and you will soon see benzene too) six atomic orbitals interact to make six molecular orbitals. We are now going to consider some common conjugated systems made up of *three* interacting p orbitals. We'll start with the structure we get from treating propene with a very strong base—one strong enough to remove one of the protons from its methyl group. H^+ is removed, so the product must have a negative charge, which formally resides on the carbon of what was the methyl group. That carbon atom started off sp^3 hybridized (i.e. tetrahedral: it had four substituents), but after it has been deprotonated it must become trigonal (sp^2), with only three substituents plus a p orbital to house the negative charge.

➔ You will meet such super-strength bases in the next chapter.

■ Of course the anion doesn't really exist 'free' like this; it will most likely have a metal cation to which it is coordinated in some way. The arguments we are going to apply about its structure are still valid whether or not there is a metal associated with it.

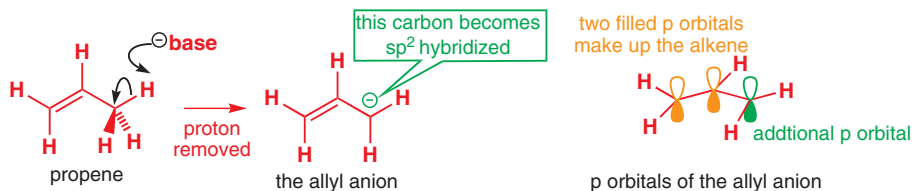

We could work out the orbitals of the allyl anion by combining this p orbital with a ready-made π bond, but instead this time we will start with the three separate p atomic orbitals and combine them to get three molecular orbitals. At first we are not concerned about where the electrons are—we are just building up the molecular orbitals.

The lowest energy orbital (ψ_1) will have them all combining in phase. This is a bonding orbital since all the interactions are bonding. The next orbital (ψ_2) requires one node, and the only way to include a node and maintain the symmetry of the system is to put the node through the central atom. This means that when this orbital is occupied there will be no electron density on this central atom. Since there are no interactions between adjacent atomic orbitals (either bonding or antibonding), this is a non-bonding orbital. The final molecular

orbital (ψ_3) must have two nodal planes. All the interactions of the atomic orbitals are out of phase so the resulting molecular orbital is an antibonding orbital.

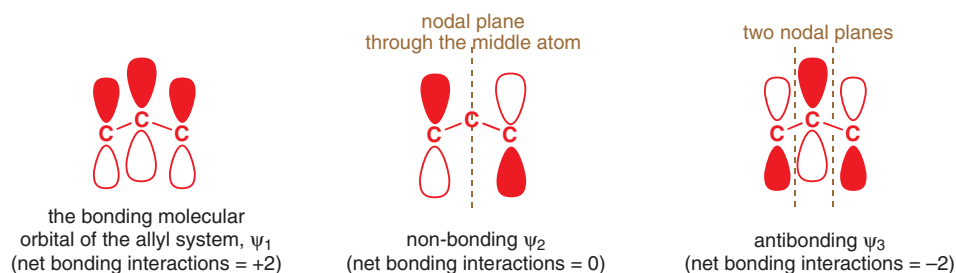

We can summarize all this information in a molecular orbital energy level diagram, and at the same time put the electrons into the orbitals. We need four electrons—two from the alkene π bond and two more for the anion (these were the two in the C–H bond, and they are still there because only a proton, H^+ , was removed). The four electrons go into the lowest two orbitals, ψ_1 and ψ_2 , leaving ψ_3 vacant. Notice too that the energy of two of the electrons is lower than it would have been if they had remained in unconjugated p orbitals: conjugation lowers the energy of filled orbitals and makes compounds more stable.

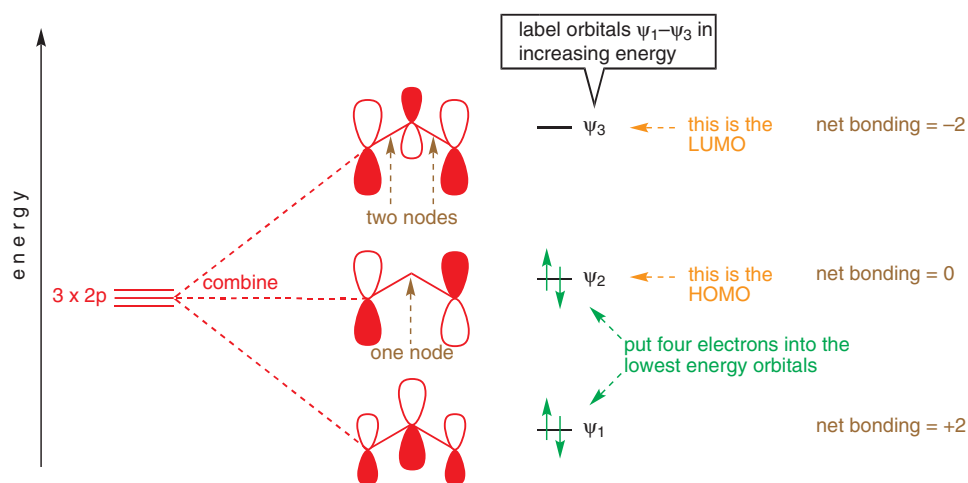

■ This diagram shows only the π orbitals of the allyl system. We have ignored all the molecular orbitals from the σ framework because the bonding σ orbitals are considerably lower in energy than the molecular orbitals of the π system and the vacant antibonding σ^* orbitals are much higher in energy than the π antibonding molecular orbital.

Interactive bonding orbitals in the allyl anion

Where is the electron density in the allyl anion π system? We have two filled π molecular orbitals and the electron density comes from a sum of both orbitals. This means there is electron density on all three carbon atoms. However, the coefficients of the end carbons are of a significant size in both orbitals, but in ψ_2 the middle carbon has no electron density at all—it lies on a node. So overall, even though the negative charge is spread over the whole molecule, the end carbons carry more of the electron density than the middle one. We can represent this in two ways—the first structure below emphasizes the delocalization of the charge over the whole molecule, but fails to get across the important point that the negative charge resides principally at the ends. Curly arrows do this much better: we can use them to show that the negative charge is not localized, but principally divided between the two end carbons.

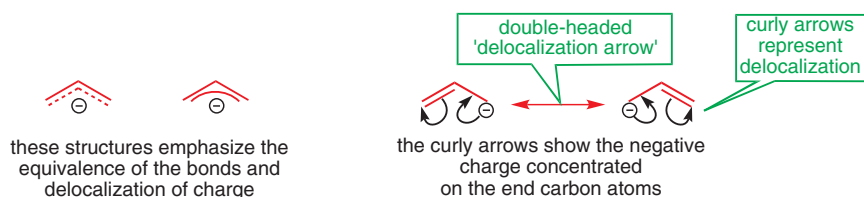

■ A reminder: this is not an equilibrium—the arrows do not represent the movement of charge. The two structures are alternative, imperfect representations of an 'averaged' structure, and they are linked by a double-headed delocalization arrow.



The problem with these structures carrying curly arrows is that they seem to imply that the negative charge (and the double bond for that matter) is jumping from one end of the molecule to the other. This, as we have seen, is just not so. Another and perhaps better picture uses dotted lines and partial charges. But the structure with the dotted bonds, as with the representation of benzene with a circle in the middle, is no good for writing mechanisms. Each of the representations has its strong and weak points: we shall use each as the occasion demands.

Using NMR to study delocalization

Delocalization of the allyl anion, and the localization of the negative charge mainly on the end carbons, is clear from its ^{13}C NMR spectrum as well. In Chapter 3 we explained that ^{13}C NMR gives us a good measure of the amount of electron density around a C atom—the extent to which it is deshielded and therefore exposed to the applied magnetic field. If you need reminding about the terminology, theory, and practice of NMR, turn back now to Chapter 3, pp. 52–63.

It is possible to record a ^{13}C NMR spectrum of an allyl anion with a lithium counterion. The spectrum shows only two signals: the middle carbon at 147 ppm and the two end carbons both at 51 ppm. This confirms two things: (i) both end carbons are the same and the structure is delocalized, and (ii) most of the negative charge is on the end carbons—they are more shielded (have a smaller chemical shift) as a result of the greater electron density. In fact, the central carbon's shift of 147 ppm is not far from that of a normal double-bond carbon (compare the signals in propene). The end carbons' shift is in between that of a double bond and a saturated carbon directly bonded to a metal (e.g. methyl lithium, whose negative chemical shift results from the highly polarized Li–C bond).

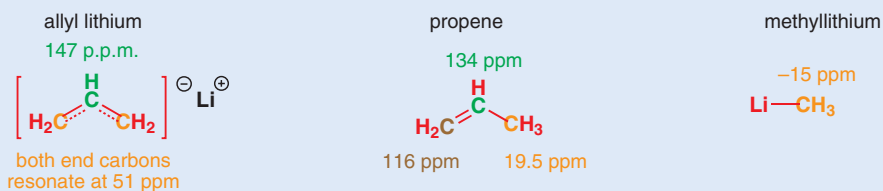

The allyl cation

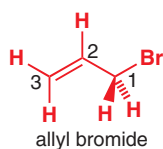

What if, instead of taking just a proton, we had also taken away two electrons from propene? In reality we can get such a structure quite straightforwardly from allyl bromide (prop-2-enyl bromide or 1-bromoprop-2-ene). Carbon 1 in this compound has four atoms attached to it (a carbon, two hydrogens, and a bromine atom) so it is tetrahedral (or sp^3 hybridized).

Bromine is more electronegative than carbon and so the C–Br bond is polarized towards the bromine. It is quite easy to break this bond completely, with the bromine keeping both electrons from the C–Br bond to become bromide ion, Br^- , leaving behind an *allyl cation*. The positively charged carbon now has only three substituents so it becomes trigonal (sp^2 hybridized). It must therefore have a vacant p orbital.

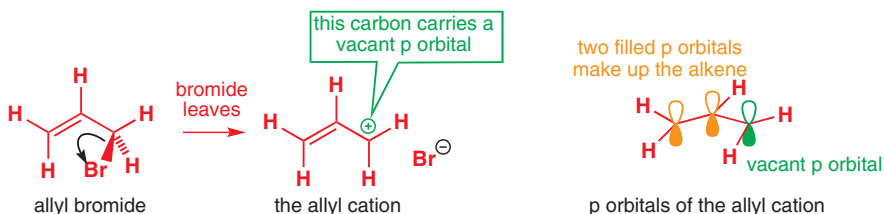

Like the allyl anion, the orbitals in the allyl cation are a combination of three atomic p orbitals, one from each carbon. So we can use the same molecular orbital energy level diagram as we did for the anion, simply by adjusting the number of electrons we put into the orbitals. This time, there are only two electrons, from the alkene, as those which were in the C–Br bond have left with anionic bromide.

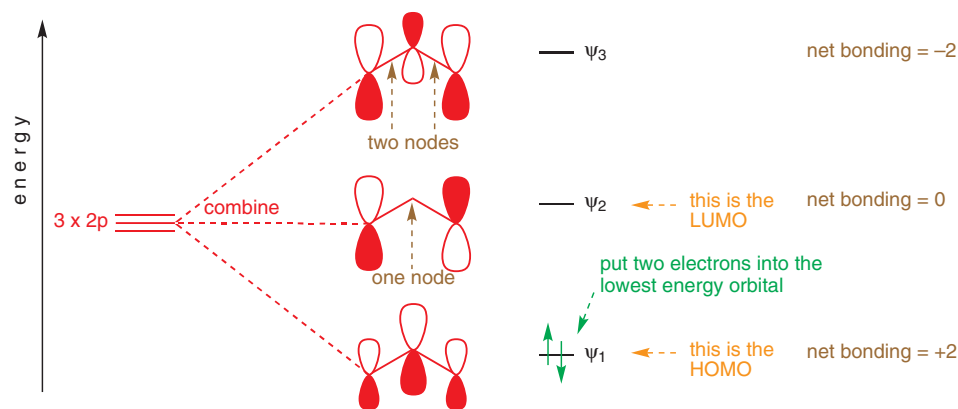

The two electrons in the filled orbital are in a lower energy orbital than they would have been if they had stayed in an unconjugated p orbital: as with the anion, *conjugation* leads to *stabilization*.

The two electrons are spread over three carbon atoms. Overall, the allyl cation has a positive charge. But where is the positive charge concentrated? What we need to do is look to see where there is a *deficit* of charge. The only orbital with any electrons in it is the bonding molecular orbital ψ_1 . From the relative sizes of the coefficients on each atom we can see that the middle carbon has more electron density on it than the end ones, so the end carbons must be more positive than the middle one.

We expect both end carbons to be identical, and ^{13}C NMR tells us that this is so (see below). Again we need a way of showing this delocalization, either on a single structure or as a pair of localized structures linked by a delocalization arrow.

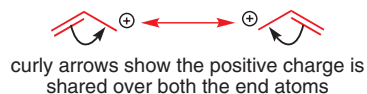
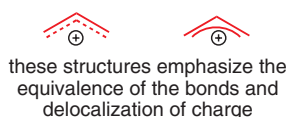

Notice how we draw the curly arrows here: we want to show the positive charge ‘moving’, and it is tempting to draw a curly arrow starting from the positive charge. But curly arrows must always start on something representing a pair of electrons. So we must move the positive charge as a consequence of the movement of the electrons in the double bond: as we pull them away from one end, they leave behind a positive charge.

➔ The guidelines for drawing curly arrows are given on p. 123.

The NMR spectrum of a delocalized cation

The reaction below shows the formation of a cation close in structure to the allyl cation. A very strong acid (called ‘superacid’—see Chapter 15) protonates the OH group of 3-cyclohexenol, which can then leave as water. The resulting cation is, not surprisingly, unstable and would normally react rapidly with a nucleophile. However, at low temperatures and if there are no nucleophiles present, the cation is relatively stable and it is even possible to record a ^{13}C NMR spectrum (at -80°C).

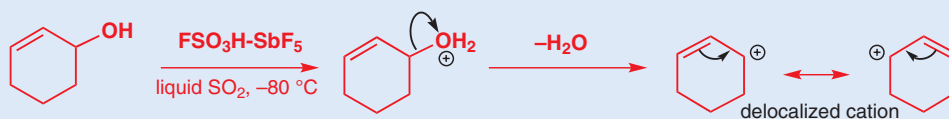

The ^{13}C NMR spectrum of this allylic cation reveals a plane of symmetry, which confirms that the positive charge is spread over two carbons. The large shift of 224 ppm for these carbons indicates very strong deshielding (that is, lack of electrons) but is nowhere near as large as that of a localized cation (which would resonate at about 330 ppm). The middle carbon’s shift of 142 ppm is almost typical of a normal double bond, indicating that it is neither significantly more nor less electron-rich than normal. In fact, it is interesting to note that the middle carbon of this cation and the allyl anion we described above have almost exactly the same chemical shift—proof that the charge lies mainly on the ends of the allyl system.

^{13}C NMR shifts in ppm—notice the plane of symmetry down the middle

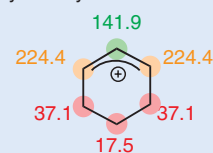

Delocalization over three atoms is a common structural feature

The carboxylate anion

You may already be familiar with one anion very much like the allyl anion—the carboxylate ion, which forms when a carboxylic acid reacts with a base. In this structure we again have a negatively charged atom separated from a double bond by a single bond adjacent to a single bond: it's analogous to an allyl anion with oxygen atoms replacing two of the carbon atoms.

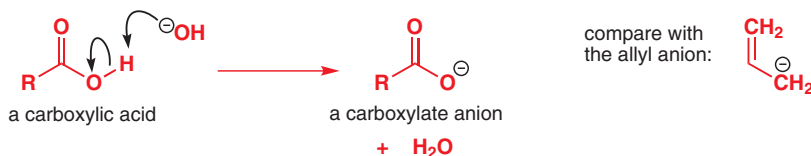

X-ray crystallography shows both carbon–oxygen bond lengths in this anion to be the same (136 pm), in between that of a normal carbon–oxygen double bond (123 pm) and single bond (143 pm). The negative charge is spread out equally over the two oxygen atoms, and we can represent this in two ways—as before, the one on the left shows the equivalence of the two C–O bonds, but you would use the one on the right for writing mechanisms. The delocalization arrow tells us that both localized forms contribute to the real structure.

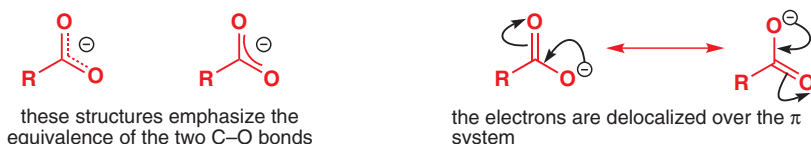

The nitro group

The nitro group consists of a nitrogen bonded to two oxygen atoms and a carbon (for example an alkyl group). There are two ways of representing the structure: one using formal charges, the other (which we suggest you avoid) using a dative bond. Notice in each case that one oxygen is depicted as being doubly bonded, the other singly bonded. Drawing both oxygen atoms doubly bonded is incorrect—*nitrogen cannot participate in five bonds*: this would require ten bonding electrons around the N atom, and there are not enough s and p orbitals to put them in.

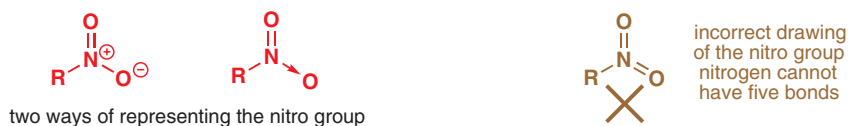

The problem even with the 'correct' structure on the left is that the equivalence of the two N–O bonds is not made clear. The nitro group has exactly the same number of electrons as a carboxylate anion (although it's neutral of course because nitrogen already has one more electron than carbon) and the delocalized structure can be shown with curly arrows in the same way.

We have not shown molecular orbital energy level diagrams for the carboxylate and nitro groups, since they are similar to that of the allyl anion. Only the absolute energies of the molecular orbitals are different since different elements with different electronegativities are involved in each case.

The amide group

Life is built of amides, because the amide group is the link through which amino acids join together to form the proteins which make up much of the structural features of living systems.

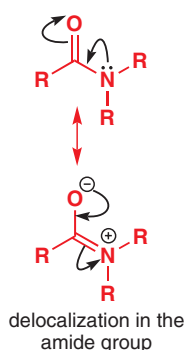

➔ This important principle was explained on p. 30.

We call structures such as a nitro and a carboxylate group *isoelectronic*: the atoms may be different but the number of and arrangement of the bonding electrons are the same.

Nylon is a synthetic polyamide, and shares with many proteins the property of durability. The structure of this deceptively simple functional group has an unexpected feature which is responsible for much of the stability it confers.

The allyl anion, carboxylate, and nitro groups have four electrons in a π system spread out over three atoms. The nitrogen in the amide group also has a pair of electrons that can conjugate with the π bond of the carbonyl group. For effective overlap with the π bond, this lone pair of electrons must be in a p orbital. This in turn means that the nitrogen must be sp^2 hybridized.

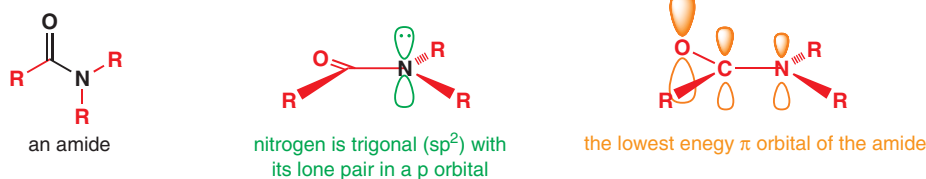

In the carboxylate ion, a negative charge is shared (equally) between two oxygen atoms. In an amide there is no charge as such—the lone pair on nitrogen is shared between the nitrogen and the oxygen. The delocalization can be shown as usual by using curly arrows, as shown in the margin.

This representation suffers from the usual problems. Curly arrows usually show electron movement, but here they do not: they simply show how to get from one of the alternative representations to the other. The molecular orbital picture of the amide tells us that the electrons are unevenly distributed over the three atoms in the π system with a greater electron density on the oxygen: you can see this in the delocalized structure on the right, which has a full negative charge on O and a positive charge on N. (We also indicated this in the diagram of the lowest energy π orbital above, which has a greatest coefficient, and therefore greatest electron density, on O.) Another aspect of the structure of the amide group that this pair of structures indicates correctly is that there is partial double bond character between the C atom and the N atom. We will come back to this shortly.

The real structure of the amide group lies in between the two extreme structures linked by the delocalization arrow: a better representation might be the structure on the right. The charges in brackets indicate substantial, although not complete, charges, maybe about a half plus or minus charge. However, we cannot draw mechanisms using this structure.

We can summarize several points about the structure of the amide group, and we will then return to each in a little more detail

- The amide group is planar—this includes the first carbon atoms of the R groups attached to the carbonyl group and to the nitrogen atom.
- The lone pair of electrons on nitrogen is delocalized into the carbonyl group.
- The C–N bond is strengthened by this interaction—it takes on partial double bond character. This also means that we no longer have free rotation about the C–N bond, which we would expect if it were only a single bond.
- The oxygen is more electron-rich than the nitrogen. Hence we might expect the oxygen rather than the nitrogen to be the site of electrophilic attack.
- The amide group as a whole is made more stable as a result of the delocalization.

How do we know the amide group is planar? X-ray crystal structures are the simplest answer. Other techniques such as electron diffraction also show that simple (non-crystalline) amides have planar structures. *N,N*-Dimethylformamide (DMF) is an example.

The N–CO bond length in DMF (135 pm) is closer to that of a standard C–N double bond (127 pm) than to that of a single bond (149 pm). This partial double bond character, which the delocalized structures led us to expect, is responsible for restricted rotation about this C–N bond. We must supply 88 kJ mol⁻¹ if we want to rotate the C–N bond in DMF (remember a single bond only takes about 3 kJ mol⁻¹, while a full C–C double bond takes about 260 kJ mol⁻¹). The amount of energy available at room temperature is only enough to allow this bond

■ Contrast this with the lone pair of a typical amine, which lies in an sp^3 orbital (see p. 103): an amine N is pyramidal (sp^3) while an amide N is trigonal planar (sp^2).

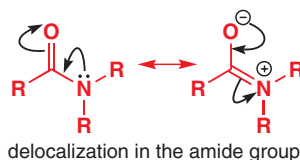

delocalization in the amide group

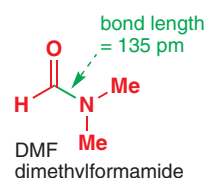
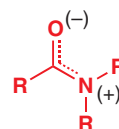

to rotate slowly, and the result is quite clear in the ^{13}C NMR spectrum of DMF. There are three carbon atoms altogether and three signals appear—the two methyl groups on the nitrogen are different. If free rotation were possible about the C–N bond, we would expect to see only two signals, since the two methyl groups would become identical.

■ In fact, if we record the spectrum at higher temperatures, we do indeed only see two signals since now there is sufficient energy available to overcome the rotational barrier and allow the two methyl groups to interchange.

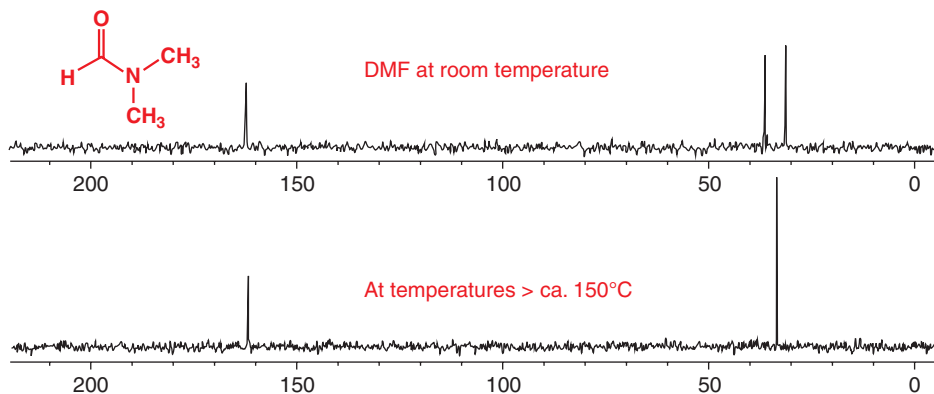

Amides in proteins

Proteins are composed of many amino acids joined together with amide bonds. The amino group of one can combine with the carboxylic acid group of another to give an amide known as a peptide—two amino acids join to form a dipeptide; many join to give a polypeptide.

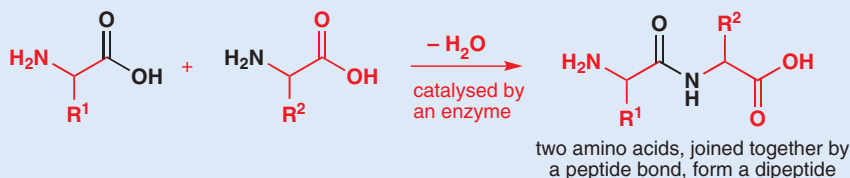

The peptide unit so formed is a planar, rigid structure because of restricted rotation about the C–N bond. This rigidity confers organizational stability on protein structures.

Conjugation and reactivity: looking forward to Chapter 10

Just as delocalization stabilizes the allyl cation and anion (at least some of the electrons in conjugated systems end up in lower energy orbitals than they would have done without conjugation) so too is the amide group stabilized by the conjugation of the nitrogen's lone pair with the carbonyl group. This makes an amide C=O one of the least reactive carbonyl groups (we shall discuss this in Chapter 10). Furthermore, the nitrogen atom of an amide group is very different from that of a typical amine. Most amines are easily protonated. However, since the lone pair on the amide's nitrogen is conjugated into the π system, it is less available for protonation or, indeed, reaction with any electrophile. As a result, when an amide is protonated (and it is not protonated easily, as you will see in the next chapter) it is protonated on oxygen rather than nitrogen. The consequences of conjugation for reactivity extend far and wide, and will be a running theme through many chapters in this book.

Aromaticity

It's now time to go back to the structure of benzene. Benzene is unusually stable for an alkene and is not normally described as an alkene at all. For example, whereas normal alkenes (whether conjugated or not) readily react with bromine to give dibromoalkane *addition* products, benzene reacts with bromine only with difficulty—it needs a catalyst (iron will do) and then the product is a *monosubstituted* benzene and not an addition compound.

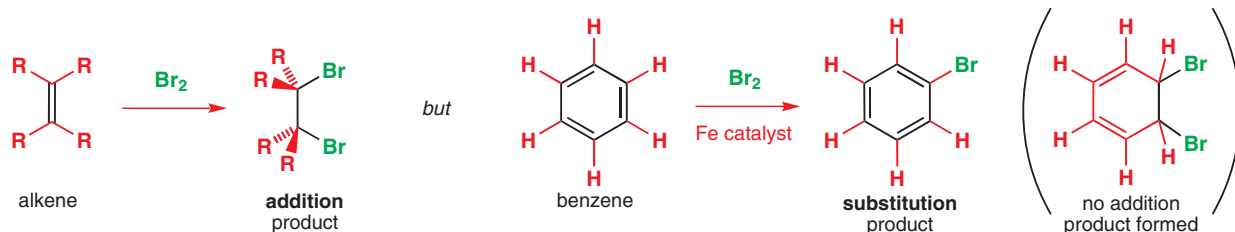

Bromine reacts with benzene in a substitution reaction (a bromine atom replaces a hydrogen atom), *keeping the benzene structure intact*. This ability to retain its conjugated structure through all sorts of chemical reactions is one of the important differences between benzene and other alkenes.

What makes benzene special?

You might assume benzene's special feature is its ring structure. To see whether this is the case, we'll look at another cyclic polyene, cyclooctatetraene, with four double bonds in a ring. Given what we have explained about the way that π systems gain stability by allowing overlap between their p orbitals, you may be surprised to find that cyclooctatetraene, unlike benzene, is *not* planar. There is no conjugation between any of the double bonds—there are indeed alternate double and single bonds in the structure, but conjugation is possible only if the p orbitals of the double bonds can overlap and here they do not. The fact that there is no conjugation is shown by the alternating C–C bond lengths in cyclooctatetraene—146.2 and 133.4 pm—which are typical for single and double C–C bonds. If possible, make a model of cyclooctatetraene for yourself—you will find the compound naturally adopts the shape on the right below. This shape is often called a 'tub'.

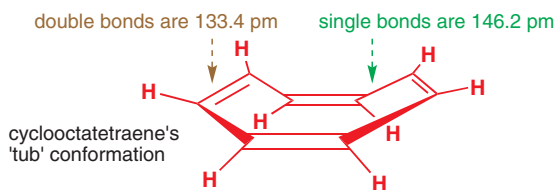
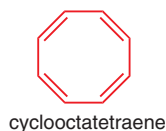

Interactive structures of cyclooctatetraene, the dianion and dication

Chemically, cyclooctatetraene behaves like an alkene, not like benzene. With bromine, for example, it forms an addition product and not a substitution product. So benzene is not special just because it is cyclic—cyclooctatetraene is cyclic too but does not behave like benzene.

Heats of hydrogenation of benzene and cyclooctatetraene

C=C double bonds can be reduced using hydrogen gas and a metal catalyst (usually nickel or palladium) to produce fully saturated alkanes. This process is called hydrogenation and it is exothermic (that is, energy is released) since a thermodynamically more stable product, an alkane, is produced.

When *cis*-cyclooctene is hydrogenated to cyclooctane, 96 kJ mol^{-1} of energy is released. Cyclooctatetraene releases 410 kJ mol^{-1} on hydrogenation. This value is approximately four times one double bond's worth, as we might expect. However, whereas the heat of hydrogenation for cyclohexene is 120 kJ mol^{-1} , on hydrogenating benzene only 208 kJ mol^{-1} is given out, which is much less than the 360 kJ mol^{-1} that we would have predicted by multiplying the figure for cyclohexene by 3. Benzene has something to make it stable which cyclooctatetraene does not have.

More on this in Chapter 23.

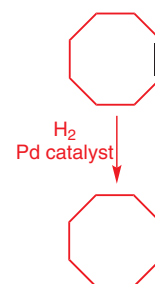

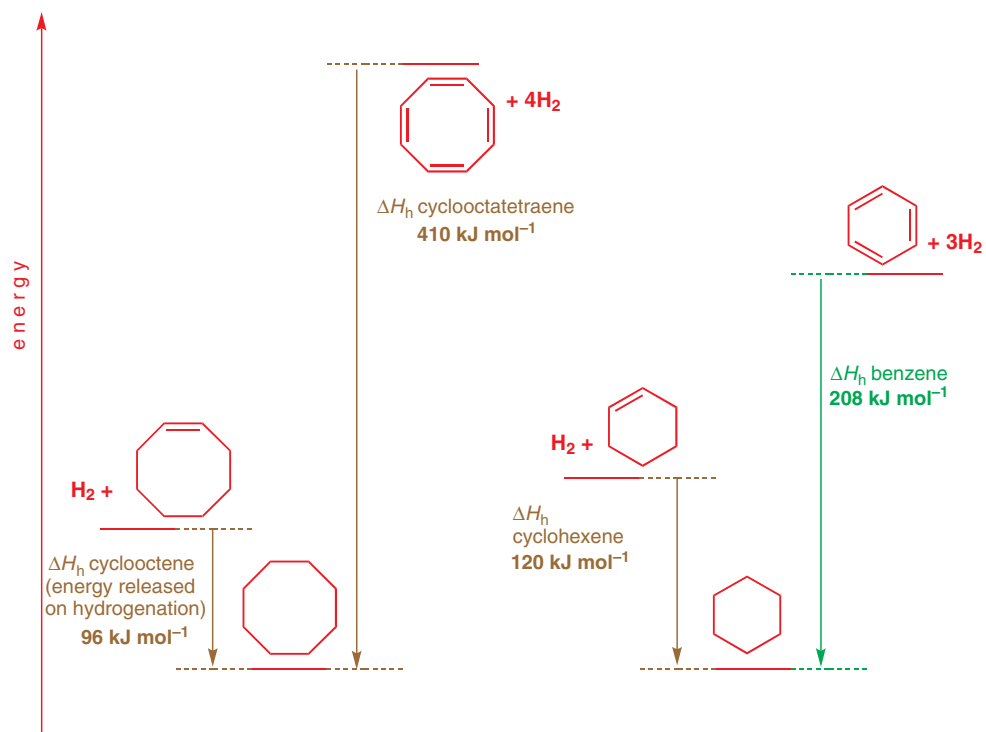

Varying the number of electrons

The mystery deepens when we look at what happens when we treat cyclooctatetraene with powerful oxidizing or reducing agents. If 1,3,5,7-tetramethylcyclooctatetraene is treated at low temperature ($-78\text{ }^{\circ}\text{C}$) with $\text{SbF}_5/\text{SO}_2\text{ClF}$ (strongly oxidizing conditions) a dication is formed. This cation, unlike the neutral compound, is *planar* and all the C–C bond lengths are the same.

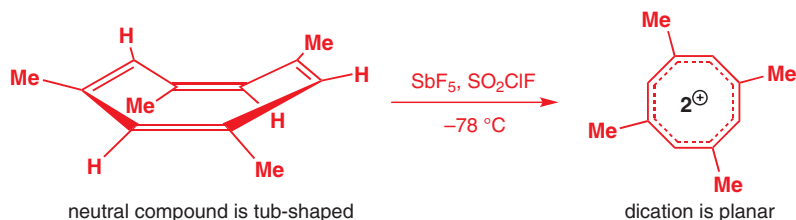

Interactive structures of cyclooctatetraene, the dianion and dication

This dication still has the same number of atoms as the neutral species, only fewer electrons. The electrons have come from the π system, which is now two electrons short. We could draw a structure showing two localized positive charges, but the charge is in fact spread over the whole ring.

It is also possible to *add* electrons to cyclooctatetraene by treating it with alkali metals and a *dianion* results. X-ray structures reveal this dianion to be planar, again with all C–C bond lengths the same (140.7 pm). The difference between the anion and cation of cyclooctatetraene on the one hand and cyclooctatetraene on the other is the number of electrons in the π system. Neutral, non-planar, cyclooctatetraene has eight π electrons, the planar dication has six π electrons (as does benzene), and the planar anion has ten.

Can you see a pattern forming? The important point is not the number of conjugated atoms but the *number of electrons in the π system*.

- When they have four or eight π electrons, both six- and eight-membered rings adopt non-planar structures; when they have six or ten π electrons, a planar structure is preferred.

If you made a model of cyclooctatetraene, you might have tried to force it to be flat. If you managed this you probably found that it didn't stay like this for long and that it popped back into the tub shape. The strain in planar cyclooctatetraene can be overcome by the molecule

adopting the tub conformation. The strain is due to the numbers of atoms and double bonds in the ring—it has nothing to do with the number of electrons. The planar dication and dianion of cyclooctatetraene still have this strain. The fact that these ions do adopt planar structures must mean there is some other form of stabilization that outweighs the strain of being planar. This extra stabilization is called *aromaticity*.

Benzene has six π molecular orbitals

The difference between the amount of energy we expect to get from benzene on hydrogenation (360 kJ mol^{-1}) and what is observed (208 kJ mol^{-1}) is about 150 kJ mol^{-1} . This represents a crude measure of just how extra stable benzene really is relative to what it would be like with three localized double bonds. In order to understand the origin of this stabilization, we must look at the molecular orbitals. We can think of the π molecular orbitals of benzene as resulting from the combination of the six p orbitals in a ring and, as with butadiene, each successively higher energy orbital contains one more node. This is what we get for benzene:

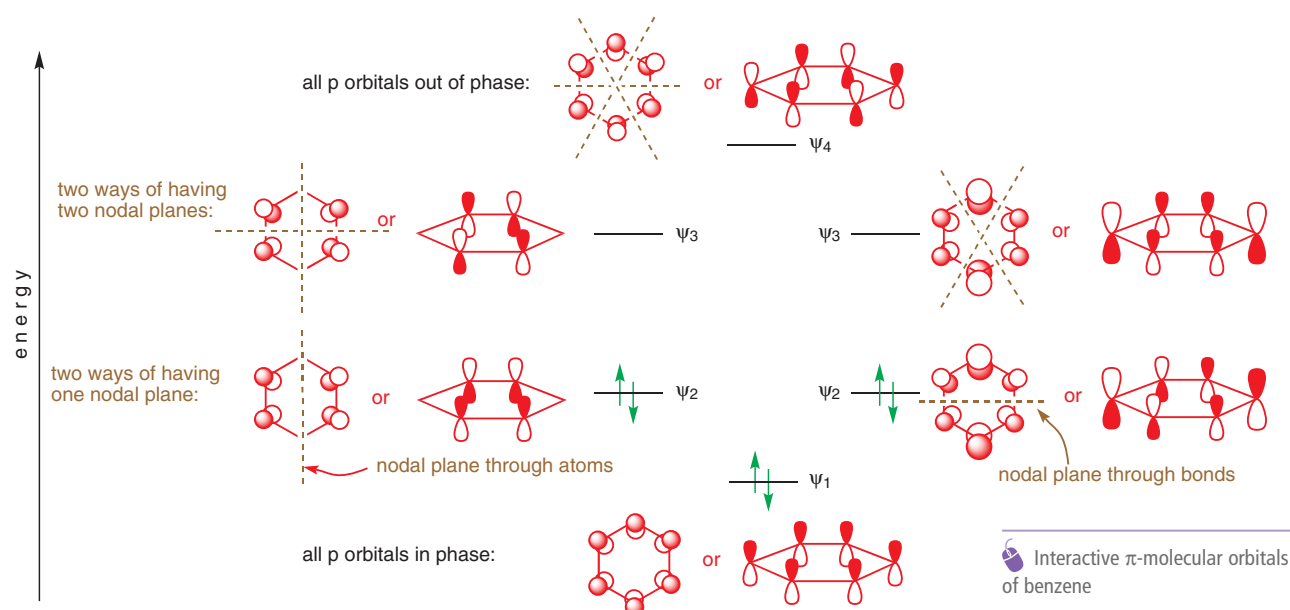

The molecular orbital lowest in energy, ψ_1 , has no nodes, with all the orbitals combining in phase. The next lowest molecular orbital will have one nodal plane, which can be arranged in two ways depending on whether or not the nodal plane passes through a bond or an atom. It turns out that these two different molecular orbitals both have exactly the same energy, that is, they are degenerate, and we call them both ψ_2 . There are likewise two ways of arranging two nodal planes and again there are two degenerate molecular orbitals ψ_3 . The final molecular orbital ψ_4 will have three nodal planes, which must mean all the p orbitals combining out of phase. Six electrons slot neatly into the three lowest energy bonding orbitals.

The π molecular orbitals of other conjugated cyclic hydrocarbons

Notice that the layout of the energy levels in benzene is a regular hexagon with its apex pointing downwards. It turns out that the energy level diagram for the molecular orbitals resulting from the combination of *any* regular cyclic arrangement of p orbitals can be deduced from the appropriately sided polygon with an apex pointing downwards. The horizontal diameter (the red line) represents the energy of a carbon p orbital and any energy levels on this line represent non-bonding molecular orbitals. All molecular orbitals with energies below this line are bonding; all those above are antibonding.

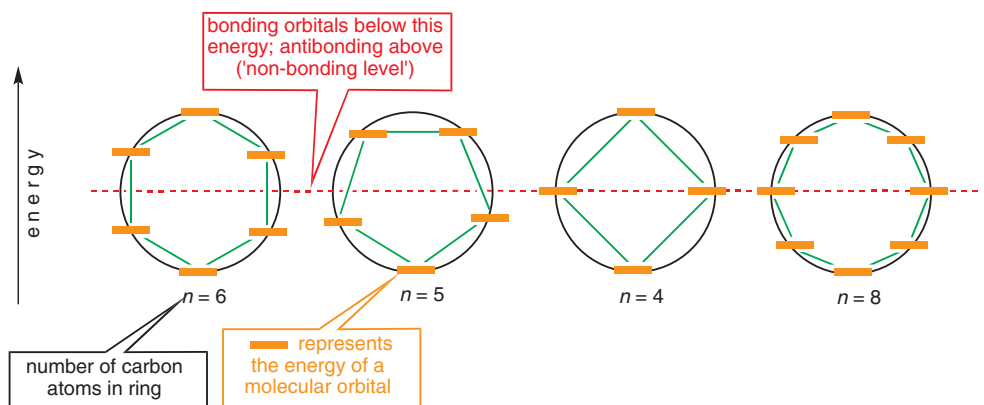

Aromaticity of cyclic polyenes

It's worth noting a few points about these energy level diagrams:

- The method predicts the energy levels for the molecular orbitals of planar, cyclic arrangements of identical atoms (usually all C) only.
- There is always one single molecular orbital lower in energy than all the others. This is because there is always one molecular orbital where all the p orbitals combine in phase.
- If there is an even number of atoms, there is also a single molecular orbital highest in energy; otherwise there will be a pair of degenerate molecular orbitals highest in energy.
- All the molecular orbitals come in degenerate pairs except the one lowest in energy and (for even-numbered systems) the one highest in energy.

Molecular orbitals and aromaticity

Now we can begin to put all the pieces together and make sense of what we know so far. We'll compare the way that the electrons fit into the energy level diagrams for benzene and planar cyclooctatetraene. We are not concerned with the actual shapes of the molecular orbitals involved, just their energies.

Benzene has six π electrons, which means that all its three bonding molecular orbitals are fully occupied, giving what we can call a 'closed shell' structure. Cyclooctatetraene's eight electrons, on the other hand, do not fit so neatly into its orbitals. Six of these fill up the bonding molecular orbitals but there are two electrons left. These must go into the degenerate pair of non-bonding orbitals. Hund's rule (Chapter 4) would suggest one in each. Planar cyclooctatetraene would not have the closed shell structure that benzene has—to get one it must either lose or gain two electrons. This is exactly what we have already seen—both the dianion and dication from cyclooctatetraene are planar, allowing delocalization all over the ring, whereas neutral cyclooctatetraene avoids the unfavourable arrangement of electrons shown below by adopting a tub shape with localized bonds.

■ You can draw an analogy here with the stability of 'closed shell' electronic arrangements in atoms.

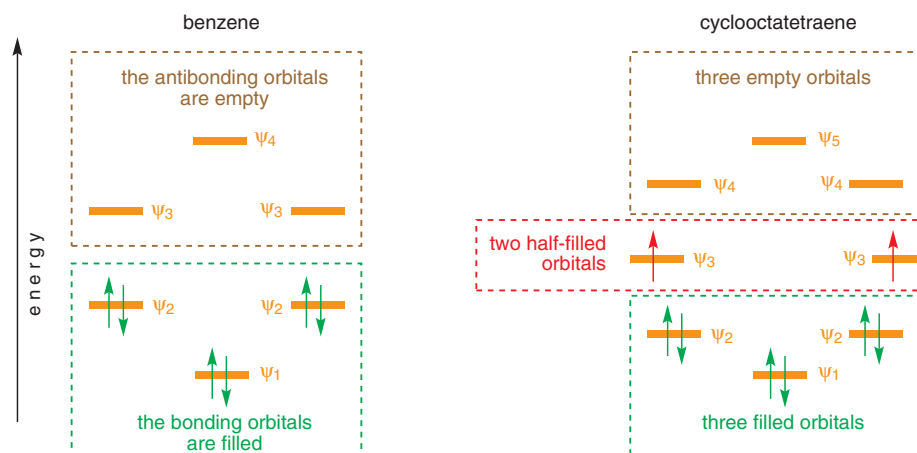

Hückel's rule tells us if compounds are aromatic

As we pointed out on the previous page, all the cyclic conjugated hydrocarbons have a single lowest energy molecular orbital, and then a stack of degenerate pairs of orbitals of increasing energy. Since the single low energy orbital holds two electrons, and then the successive degenerate pairs four each, a 'closed shell' arrangement in which all the orbitals below a certain level are filled will always contain $(4n + 2)$ electrons (where n is an integer—0, 1, 2, etc.—corresponding to the number of degenerate orbital pairs). This is the basis of Hückel's rule.

● Hückel's rule

Planar, fully conjugated, monocyclic systems with $(4n + 2)$ π electrons have a closed shell of electrons all in bonding orbitals and are exceptionally stable. Such systems are said to be aromatic.

Analogous systems with $4n$ π electrons are described as anti-aromatic.

The next $(4n + 2)$ number after six is ten so we might expect this cyclic alkene, [10]annulene, to be aromatic. But if a compound with five *cis* double bonds were planar, each internal angle would be 144° . Since a normal double bond has bond angles of 120° , this would be far from ideal. This compound can be made but it does *not* adopt a planar conformation and therefore is not aromatic even though it has ten π electrons.

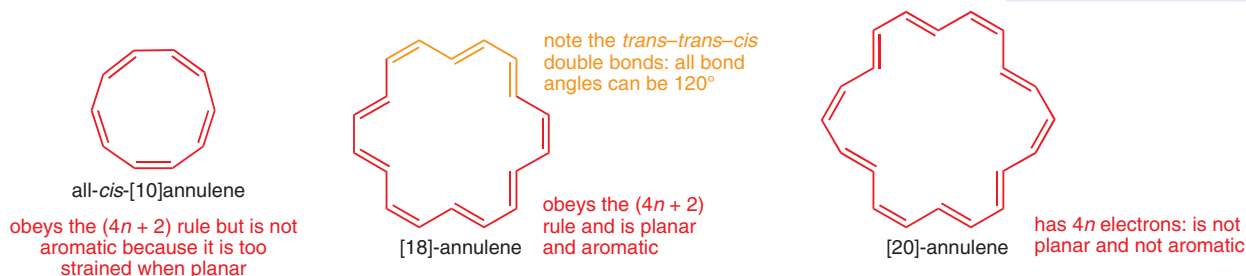

By contrast, [18]annulene, which is also a $(4n + 2)$ π electron system ($n = 4$), does adopt a planar conformation and *is* aromatic. The *trans-trans-cis* double bond arrangement allows all bond angles to be 120° . [20]Annulene presumably could become planar (it isn't quite) but since it is a $4n$ π electron system rather than a $4n + 2$ system, it is not aromatic and the structure shows localized single and double bonds.

When the conjugated systems are not monocyclic, the situation becomes a little less clear. Naphthalene, for example, has ten electrons but you can also think of it as two fused benzene rings. From its chemistry, it is very clear that naphthalene has aromatic character (it does substitution reactions) but is less aromatic than benzene itself. For example, naphthalene can easily be reduced to tetralin (1,2,3,4-tetrahydronaphthalene), which still contains a benzene ring. Also, in contrast to benzene, all the bond lengths in naphthalene are not the same. 1,6-Methano[10]annulene is rather like naphthalene but with the middle bond replaced by a methylene bridging group. This compound is almost flat and shows aromatic character.

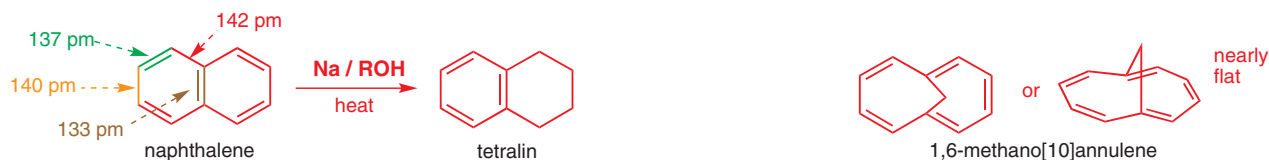

Hückel's rule helps us predict and understand the aromatic stability of numerous other systems. Cyclopentadiene, for example, has two conjugated double bonds but the conjugated system is not cyclic since there is an sp^3 carbon in the ring. However, this compound is relatively easy to deprotonate to give a very stable anion in which all the bond lengths are the same.

■ This is not a strict definition of aromaticity: it is actually very difficult to define aromaticity precisely, but all aromatic systems obey Hückel's $(4n + 2)$ rule.

Annulenes are compounds with alternating double and single bonds. The number in brackets tells us how many carbon atoms there are in the ring. Using this nomenclature, you could call benzene [6]annulene and cyclooctatetraene [8]annulene—but don't.

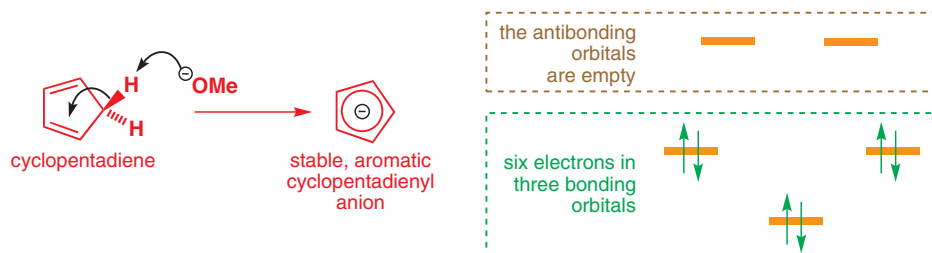

■ Not only are most aromatic systems heterocyclic, but more than 50% of *all organic compounds* contain an aromatic heterocycle.

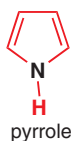
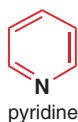

Each of the double bonds contributes two electrons and the negative charge (which must be in a p orbital to complete the conjugation) contributes a further two, making six altogether. The energy level diagram shows that six π electrons completely fill the bonding molecular orbitals, thereby giving a stable aromatic structure.

Heterocyclic aromatic compounds

So far all the aromatic compounds you have seen have been hydrocarbons. However, most aromatic systems are heterocyclic—that is, they contain atoms other than just carbon and hydrogen. (In fact the majority of *all organic compounds* are aromatic heterocycles!) A simple example is pyridine, in which a nitrogen replaces one of the CH groups of benzene. The ring still has three double bonds and thus six π electrons.

Consider the structure shown on the left, pyrrole. This is also aromatic but it's not enough just to use the electrons in the double bonds: in pyrrole the nitrogen's lone pair contributes to the six π electrons needed for the system to be aromatic. Aromatic chemistry makes several more appearances in this book: in Chapter 21 we shall look at the chemistry of benzene and in Chapters 30 and 31 we shall discuss heterocyclic aromatic compounds in much more detail.

Further reading

Molecular Orbitals and Organic Chemical Reactions: Student Edition by Ian Fleming, Wiley, Chichester, 2009, gives an excellent account of delocalization.

Check your understanding



To check that you have mastered the concepts presented in this chapter, attempt the problems that are available in the book's Online Resource Centre at <http://www.oxfordtextbooks.co.uk/orc/clayden2e/>

Acidity, basicity, and pK_a

Connections

➔ Building on

- Conjugation and molecular stability [ch7](#)
- Curly arrows represent delocalization and mechanisms [ch5](#)
- How orbitals overlap to form conjugated systems [ch4](#)

Arriving at

- Why some molecules are acidic and others basic
- Why some acids are strong and others weak
- Why some bases are strong and others weak
- Estimating acidity and basicity using pH and pK_a
- Structure and equilibria in proton transfer reactions
- Which protons in more complex molecules are more acidic
- Which lone pairs in more complex molecules are more basic
- Quantitative acid/base ideas affecting reactions and solubility
- Effects of quantitative acid/base ideas on medicine design

➔ Looking forward to

- Acid and base catalysis in carbonyl reactions [ch10 & ch11](#)
- The role of catalysts in organic mechanisms [ch12](#)
- Making reactions selective using acids and bases [ch23](#)
- More details on acid and base catalysis [ch39](#)

Organic compounds are more soluble in water as ions

Most organic compounds are insoluble in water. But sometimes it's necessary to make them dissolve, perhaps by converting them to anions or cations. Water can solvate both cations and anions, unlike some of the solvents you will meet later. A good way of dissolving an organic acid is to put it in basic solution: the base deprotonates the acid to give an anion. A simple example is aspirin: whilst the acid itself is not very soluble in water, the sodium salt is much more soluble. The sodium salt forms with the weak base, sodium hydrogencarbonate.

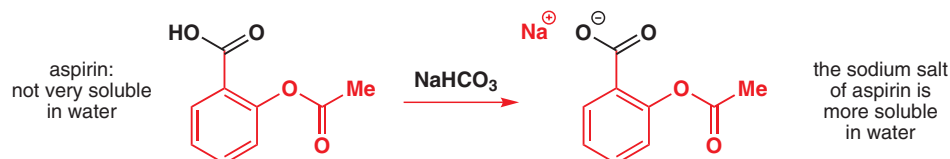

The sodium or calcium salt of 'normal' aspirin is sold as 'soluble aspirin'. But when the pH of a solution of aspirin's sodium salt is lowered, the amount of the 'normal' acidic form present increases and the solubility decreases. In the acidic environment of the stomach (around pH 1–2), soluble aspirin will be converted back to the normal acidic form and precipitate out of solution.

Water is special for many reasons, and it falls into a class of solvents we call *polar protic* solvents. We will discuss other solvents in this class, as well as *polar aprotic* solvents (such as acetone and DMF) and *non-polar* solvents (such as toluene and hexane) in Chapter 12.



Online support. The icon  in the margin indicates that accompanying interactive resources are provided online to help your understanding: just type www.chemtube3d.com/clayden/123 into your browser, replacing 123 with the number of the page where you see the icon. For pages linking to more than one resource, type 123-1, 123-2 etc. (replacing 123 with the page number) for access to successive links.

In the same way, organic bases such as amines can be dissolved by *lowering* the pH. Codeine (7,8-didehydro-4,5-epoxy-3-methoxy-17-methylmorphinan-6-ol) is a commonly used pain-killer. Codeine itself is not very soluble in water but it does contain a basic nitrogen atom that can be protonated to give a more soluble salt. It is usually encountered as a phosphate salt. The structure is complex, but that doesn't matter.

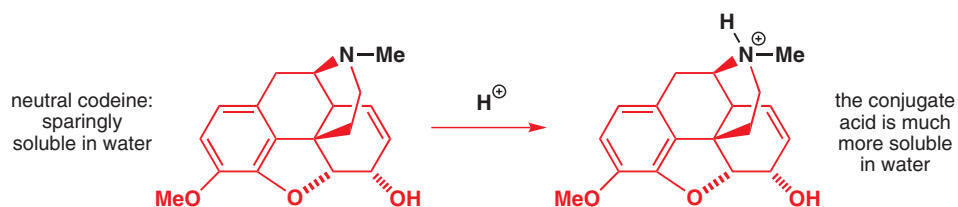

Charged compounds can be separated by acid–base extraction

Adjusting the pH of a solution often provides an easy way to separate compounds. Separating a mixture of benzoic acid ($PhCO_2H$) and toluene ($PhMe$) is easy: dissolve the mixture in CH_2Cl_2 , add aqueous NaOH, shake the mixture of solutions, and separate the layers. The CH_2Cl_2 layer contains all the toluene. The aqueous layer contains the sodium salt of benzoic acid. Addition of HCl to the aqueous layer precipitates the insoluble benzoic acid.

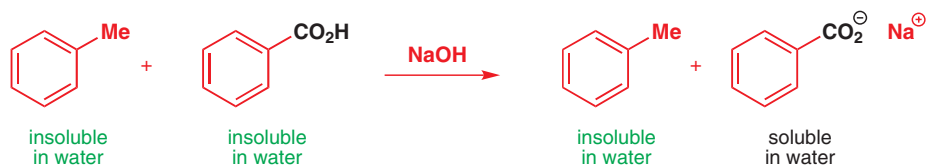

A more realistic separation is given in a modern practical book after a Cannizzaro reaction. You will meet this reaction in Chapters 26 and 39 but all you need to know now is that there are two products, formed in roughly equal quantities. Separation of these from starting material and solvent, as well as from each other, makes this a useful reaction.

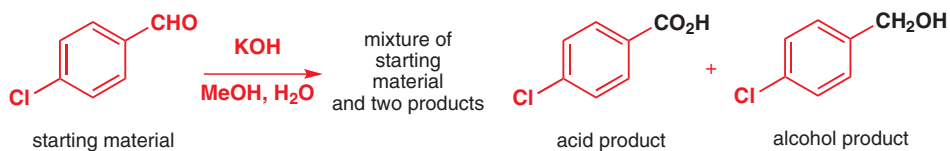

The products under the basic reaction conditions are the *salt* of the acid (soluble in water) and the alcohol (not soluble in water). Extraction with dichloromethane removes the alcohol and leaves the salt in the aqueous layer along with solvent methanol and residual KOH. Rotary evaporation of the CH_2Cl_2 layer gives crystalline alcohol and acidification of the aqueous layer precipitates the neutral acid.

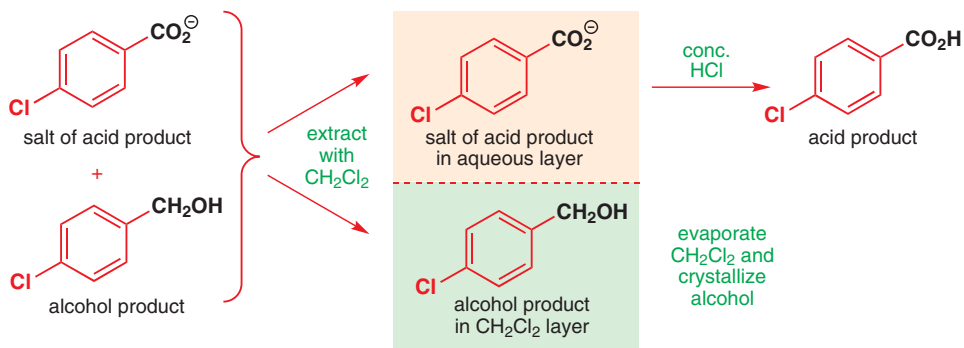

In the same way, any basic compounds dissolved in an organic layer can be extracted by washing the layer with dilute aqueous acid and recovered by raising the pH, which will precipitate out the less soluble neutral compound. A general way to make amines is by 'reductive amination.' Ignore the details of this reaction for now (we come back to them in Chapter 11) but consider how the amine might be separated from starting material, by-products, and solvent.

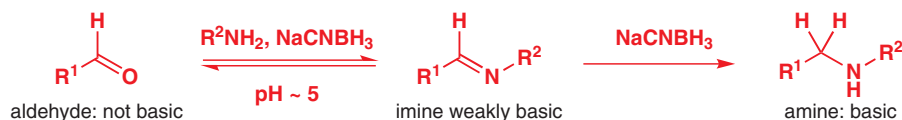

As the reaction mixture is weakly acidic, the amine will be protonated and will be soluble in water. The starting material and intermediate (of which very little is present anyway) are soluble in organic solvents. Extracting the aqueous layer and neutralizing with NaOH gives the amine.

Whenever you do any extractions or washes in practical experiments, just stop and ask yourself: 'What is happening here? In which layer is my compound and why?' You will then be less likely to throw away the wrong layer (and your precious compound)!

Acids, bases, and pK_a

If we are going to make use of the acid–base properties of compounds as we have just described, we are going to need a way of measuring *how acidic* or *how basic* they are. Raising the pH leads to deprotonation of aspirin and lowering the pH leads to protonation of codeine, but *how far* do we have to raise or lower the pH to do this? The measure of acidity or basicity we need is called pK_a . The value of pK_a tells us how acidic (or not) a given hydrogen atom in a compound is. Knowing about pK_a tells us, for example, that the amine product from the reaction just above will be protonated at weakly acidic pH 5, or that only a weak base (sodium hydrogen carbonate) is needed to deprotonate a carboxylic acid such as aspirin. It is also useful because many reactions proceed through protonation or deprotonation of one of the reactants (you met some examples in Chapter 6), and it is obviously useful to know what strength acid or base is needed. It would be futile to use too weak a base to deprotonate a compound but, equally, using a very strong base where a weak one would do risks the result of cracking open a walnut with a sledge hammer.

The aim of this chapter is to help you to understand *why* a given compound has the pK_a that it does. Once you understand the trends involved, you should have a good feel for the pK_a values of commonly encountered compounds and also be able to predict roughly the values for unfamiliar compounds.

Benzoic acid preserves soft drinks

Benzoic acid is used as a preservative in foods and soft drinks (E210). Like acetic acid, it is only the acid form that is effective as a bactericide. Consequently, benzoic acid can be used as a preservative only in foodstuffs with a relatively low pH, ideally less than its pK_a of 4.2. This isn't usually a problem: soft drinks, for example, typically have a pH of 2–3. Benzoic acid is often added as the sodium salt (E211), perhaps because this can be added to the recipe as a concentrated solution in water. At the low pH in the final drink, most of the salt will be protonated to give benzoic acid proper, which presumably remains in solution because it is so dilute.

Acidity

Let's start with two simple, and probably familiar, definitions:

- An acid is a species having a tendency to lose a proton.
- A base is a species having a tendency to accept a proton.

'The proton is a unique chemical species, being a bare nucleus. As a consequence it has no independent existence in the condensed state and is invariably found bound by a pair of electrons to another atom.'

Ross Stewart, *The Proton: Applications to Organic Chemistry*, Academic Press, Orlando, 1985, p. 1.

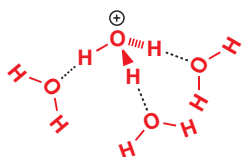

a structure for a solvated hydronium ion in water: the dashed bonds represent hydrogen bonds

An isolated proton is extremely reactive—formation of H_3O^+ in water

Gaseous HCl is not an acid at all—it shows no tendency to dissociate into H^+ and Cl^- as the H–Cl bond is strong. But hydrochloric acid—that is, a solution of HCl in water—is a strong acid. The difference is that an isolated proton H^+ is too unstable to be encountered under normal conditions, but in water the hydrogen of HCl is transferred to a water molecule and not released as a free species.



The chloride anion is the same in both cases: the only difference is that a very unstable naked proton would have to be the other product in the gas phase but a much more stable H_3O^+ cation would be formed in water. In fact it's even better than that, as other molecules of water cluster round ('solvate') the H_3O^+ cation, stabilizing it with a network of hydrogen bonds.

That is why HCl is an acid in water. But how strong an acid is it? This is where chloride plays a role: hydrochloric acid is a strong acid because chloride ion is a stable anion. The sea is full of it! Water is needed to reveal the acidic quality of HCl, and acidity is determined in water as the standard solvent. If we measure acidity in water, what we are really measuring is how much our acid transfers a proton to a water molecule.

HCl transfers its proton almost completely to water, and is a strong acid. But the transfer of protons to water from carboxylic acids is only partial. That is why carboxylic acids are weak acids. Unlike the reaction of HCl with water, the reaction below is an equilibrium.

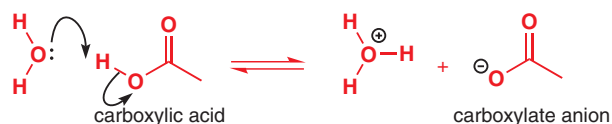

The pH scale and pK_a

The amount of H_3O^+ in any solution in water is described using the pH scale. pH is simply a measure of the concentration of H_3O^+ on a logarithmic scale, and it is characteristic of any aqueous acid—it depends not only on what the acid is (hydrochloric, acetic, etc.) but also on how concentrated the acid is.

● pH is the negative logarithm of the H_3O^+ concentration.

$$pH = -\log[H_3O^+]$$

You will already know that neutrality is pH 7 and that below pH 7 water is increasingly acidic while above pH 7 it is increasingly basic. At higher pH, there is little H_3O^+ in the solution and more hydroxide ion, but at lower pH there is more H_3O^+ and little hydroxide.

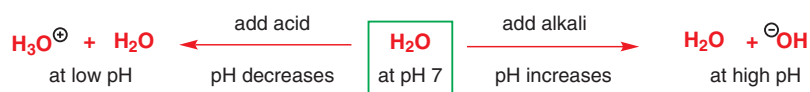

The reason that higher pH means less H_3O^+ is because the arbitrary definition of pH is the *negative* logarithm (to the base 10) of the H_3O^+ concentration. To summarize in a diagram:

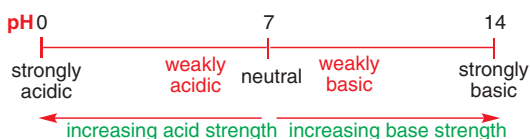

■ We will explain later why this scale seems to stop at pH 0 and 14—in fact these numbers are approximate, but easy to remember.

pH is used to measure the acidity of aqueous solutions, but what about the inherent tendency of an acidic compound to give up H^+ to water and form these acid solutions? A good way of measuring this tendency is to find the pH at which a solution contains exactly the same amount of the protonated, acidic form and its deprotonated, basic form. This number, which is characteristic of any acid, is known as the pK_a . In the example just above, this would be the pH where the amount of the carboxylic acid is matched by the amount of its carboxylate salt—which happens to be at about pH 5: the pK_a of acetic acid is 4.76.

We'll come back to a more formal definition of pK_a later, but first we need to look more closely at this pair of species—the protonated acid and its deprotonated, basic partner.

Every acid has a conjugate base

Looking back at the equilibrium set up when acetic acid dissolves in water, but drawing the mechanism of the back reaction, we see acetate ion acting as a base and H_3O^+ acting as an acid. In all equilibria involving just proton transfer a species acting as a base on one side acts as an acid on the other. We describe H_3O^+ as the *conjugate acid* of water and water as the *conjugate base* of H_3O^+ . In the same way, acetic acid is the conjugate acid of acetate ion and acetate ion is the conjugate base of acetic acid.



• For any acid and any base:

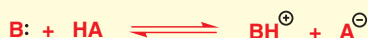

AH is an acid and A^- is its conjugate base and B is a base and BH^+ is its conjugate acid. That is, every acid has a conjugate base associated with it and every base has a conjugate acid associated with it.

Water doesn't have to be one of the participants—if we replace water in the reaction we have been discussing with ammonia, we now have ammonia as the conjugate base of NH_4^+ (the ammonium cation) and the ammonium cation as the conjugate acid of ammonia. What is different is the position of equilibrium: ammonia is more basic than water and now the equilibrium will be well over to the right. As you will see, pK_a will help us assess where equilibria like these lie.



The amino acids you met in Chapter 2 have carboxylic acid and amine functional groups within the same molecule. When dissolved in water, they transfer a proton from the CO_2H group to the NH_2 group and form a *zwitterion*. This German term describes a double ion having positive and negative charges in the same molecule.

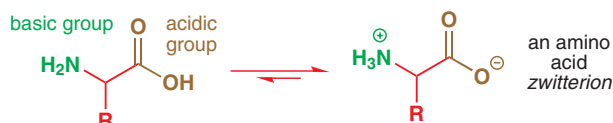

Water can behave as an acid or as a base

So far we have seen water acting as a (very weak) base to form H_3O^+ . If we added a strong base, such as sodium hydride, to water, the base would deprotonate the water to give hydroxide ion,

HO^- , and here the water would be acting as an acid. It's amusing to notice that hydrogen gas is the conjugate acid of hydride ion, but more important to note that hydroxide ion is the conjugate base of water.

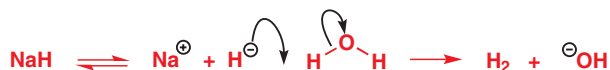

Water is a weak acid and a weak base so we need a strong acid like HCl to give much H_3O^+ , and a strong base, like hydride ion, to give much hydroxide ion.

The ionization of water

The concentration of H_3O^+ ions in water is very low indeed at $10^{-7} \text{ mol dm}^{-3}$. Pure water at 25 °C therefore has a pH of 7.00. Hydronium ions in pure water can arise only from water protonating (and deprotonating) itself. One molecule of water acts as a base, deprotonating another that acts as an acid. For every H_3O^+ ion formed, a hydroxide ion must also be formed, so that in pure water at pH 7 the concentrations of H_3O^+ and hydroxide ions must be equal: $[\text{H}_3\text{O}^+] = [\text{OH}^-] = 10^{-7} \text{ mol dm}^{-3}$.



Water is still safe to drink because the concentrations of hydronium and hydroxide ions are very small ($10^{-7} \text{ mol dm}^{-3}$ corresponds to about 2 parts per billion). This very low concentration means that there are not enough free hydronium or hydroxide ions in water to do any harm when you drink it, but neither are there enough to provide acid or base catalysts for reactions which need them.

The product of these two concentrations is known as the *ionization constant* (or as the *ionic product*) of water, K_w , with a value of $10^{-14} \text{ mol}^2 \text{ dm}^{-6}$ (at 25 °C). This is a constant in aqueous solutions, so if we know the hydronium ion concentration (which we can get by measuring the pH), we also know the hydroxide concentration since the product of the two concentrations always equals 10^{-14} .

So, roughly at what pH does water become mostly H_3O^+ ions and at what pH mostly hydroxide ions? We can now add two additional pieces of information to the approximate chart we gave you before. At pH 7, water is almost entirely H_2O . At about pH 0, the concentrations of water and H_3O^+ ions are about the same and at about pH 14, the concentrations of hydroxide ions and water are about the same.

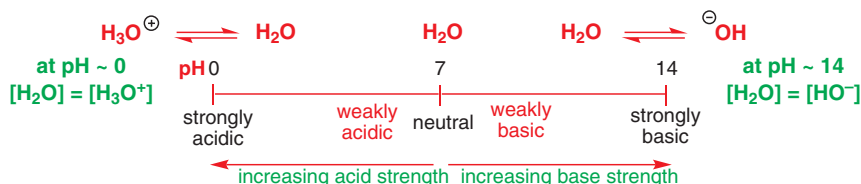

The figures 0 and 14 are approximate—there is a simple reason why this is so, which we will explain shortly. But you see now why we end the scale at these points—below 0 and above 14 there is little scope for varying the concentration of H_3O^+ .

Acids as preservatives

Acetic acid is used as a preservative in many foods, for example pickles, mayonnaise, bread, and fish products, because it prevents bacteria and fungi growing. However, its fungicidal nature is not due to any lowering of the pH of the foodstuff. In fact, it is the undissociated acid that acts as a bactericide and a fungicide in concentrations as low as 0.1–0.3%. Besides, such a low concentration has little effect on the pH of the foodstuff anyway.

Although acetic acid can be added directly to a foodstuff (disguised as E260), it is more common to add vinegar, which contains between 10 and 15% acetic acid. This makes the product more 'natural' since it avoids the nasty 'E numbers'. Actually, vinegar has also replaced other acids used as preservatives, such as propionic (propanoic) acid (E280) and its salts (E281, E282, and E283).

The definition of pK_a

When we introduced you to pK_a on p. 167, we said it is the pH at which an acid and its conjugate base are present in equal concentrations. We can now be more precise about the definition

of pK_a . pK_a is the log (to the base ten) of the equilibrium constant for the dissociation of the acid. For an acid HA this is:



The concentration of water is ignored in the definition because it is also constant (at 25 °C).

Because of the minus sign in the definition (it's there too in the definition of pH) the lower the pK_a the larger the equilibrium constant and the stronger the acid. You may find the way we introduced pK_a more helpful as a concept for visualizing pK_a : any acid is half dissociated in a solution whose pH matches the acid's pK_a . At a pH above the pK_a the acid exists largely as its conjugate base (A^-) but at a pH below the pK_a the acid largely exists as HA.

With pK_a we can put figures to the relative strengths of hydrochloric and acetic acid we introduced earlier. HCl is a much stronger acid than acetic acid: the pK_a of HCl is around -7 compared to 4.76 for acetic acid. This tells us that in solution K_a for hydrogen chloride is 10^7 mol dm^{-3} . This is an enormous number: only one molecule in 10,000,000 is not dissociated, so it is essentially fully dissociated. But K_a for acetic acid is only $10^{-4.76} = 1.74 \times 10^{-5} \text{ mol dm}^{-3}$ so it is hardly dissociated at all: only a few molecules in every million of acetic acid are present as the acetate ion.

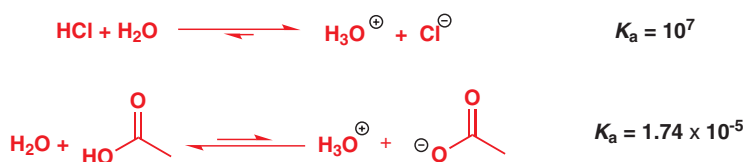

What about the pK_a of water? You know the figures already: K_a for water is $[\text{H}_3\text{O}^{\oplus}] \times [\text{HO}^-]/[\text{H}_2\text{O}] = 10^{-14}/55.5$. So $pK_a = -\log[10^{-14}/55.5] = 15.7$. Now you see why water isn't really quite half dissociated at pH 14—the concentration of water in the equation means that the two ends of the scale on p. 168 are not at 0 and 14, but at -1.7 and 15.7.

A graphical description of the pK_a of acids and bases

For both cases, adjusting the pH alters the proportions of the acid form and of the conjugate base. The graph plots the concentration of the free acid AH (green curve) and the ionized conjugate base A^- (red curve) as percentages of the total concentration as the pH is varied. At low pH the compound exists entirely as AH and at high pH entirely as A^- . At the pK_a the concentration of each species, AH and A^- , is the same. At pHs near the pK_a the compound exists as a mixture of the two forms.

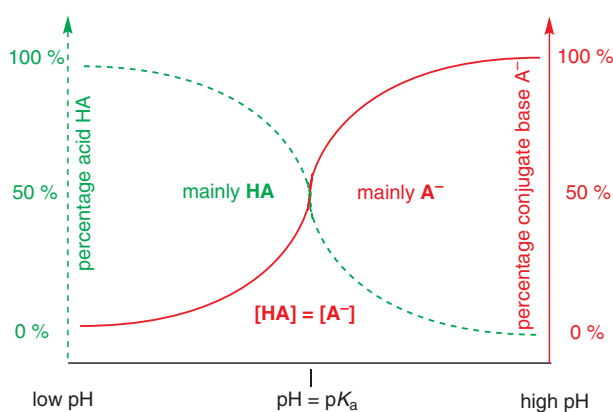

Now we have established why you need to understand acids and bases, we must move on to consider why some acids are stronger than other acids and some bases stronger than other bases. To do this we must be able to estimate the pK_a of common classes of organic compounds.

How concentrated is water? One mole of pure water has a mass of 18 g and occupies 18 cm³. So, in 1 dm³, there are 1000/18 = 55.56 mol. Water is a 55.56 mol dm⁻³ solution of water...in water.

You do not need to learn exact figures for pK_a values, but you will certainly need to develop a feel for approximate values—we will guide you towards which figures are worth learning and which you can leave to be looked up when you need them.

An acid's pK_a depends on the stability of its conjugate base

The stronger the acid, the easier it is to ionize, which means that it must have a stable conjugate base. Conversely, a weak acid is reluctant to ionize because it has an *unstable* conjugate base. The other side of this coin is that unstable anions A^- make strong bases and their conjugate acids AH are weak acids.

● Acid and conjugate base strength

The stronger the acid HA , the weaker its conjugate base A^- .

The stronger the base A^- , the weaker its conjugate acid AH .

For example, hydrogen iodide has a very low pK_a , about -10 . This means that HI is a strong enough acid to protonate almost anything. Its conjugate base, iodide ion, is therefore not basic at all—it will not deprotonate anything. A very powerful base is methyllithium, $MeLi$. Although it is actually a covalent compound, as we discuss in Chapter 9, for the purpose of the discussion here you can think of $MeLi$ as CH_3Li^+ . CH_3^- can accept a proton to become neutral methane, CH_4 . Methane is therefore the conjugate acid. Clearly, methane isn't at all acidic—its pK_a is estimated to be 48. The table below gives a few inorganic compounds and their approximate pK_a values.

The approximate pK_a values of some inorganic compounds

Acid	pK_a	Conjugate base	Acid	pK_a	Conjugate base	Acid	pK_a	Conjugate base
H_2SO_4	-3	HSO_4^-	H_3O^+	-1.7	H_2O	NH_4^+	9.2	NH_3
HCl	-7	Cl^-	H_2O	15.7	HO^-	NH_3	33	NH_2^-
HI	-10	I^-	H_2S	7.0	HS^-			

Notice that the lower down the periodic table we go, the stronger the acid. Notice also that oxygen acids are stronger than nitrogen acids. We have also put down more exact pK_a values for water but you need remember only the approximate values of 0 and 14. Over the next few pages we shall be considering the reasons for these differences in acid strength but we are first going to consider the simple consequences of mixing acids or bases of different strengths. Notice the vast range covered by pK_a values: from around -10 for HI to nearly 50 for methane. This corresponds to a difference of 10^{60} in the equilibrium constant.

The choice of solvent limits the pK_a range we can use

In water, we can measure the pK_a of an acid only if the acid does not completely protonate water to give H_3O^+ or completely deprotonate it to give HO^- . We are restricted roughly to pH -1.7 to 15.7 , beyond which water is more than 50% protonated or deprotonated. The strength of acids or bases we can use in any solvent is limited by the acidity and basicity of the solvent itself. Think of it this way: say you want to remove the proton from a compound with a high pK_a , say 25 – 30 . It would be impossible to do this in water since the strongest base we can use is hydroxide. If you add a base stronger than hydroxide, it won't deprotonate your compound, it will just deprotonate water and make hydroxide anyway. Likewise, acids stronger than H_3O^+ can't exist in water: they just protonate water completely to make H_3O^+ . If you do need a stronger base than OH^- (or a stronger acid than H_3O^+ , but this is rarer) you must use a different solvent.

Let's take acetylene as an example. Acetylene (ethyne) has pK_a 25 . This is remarkably low for a hydrocarbon (see below for why) but, even so, hydroxide (the strongest base we could have in aqueous solution, pK_a 15.7) would establish an equilibrium where only 1 in $10^{9.3}$ ($10^{15.7}/10^{25}$), or about 1 in 2 billion, ethyne molecules are deprotonated. We can't use a stronger base than hydroxide, since, no matter what strong base we dissolve in water, we will only at best get hydroxide ions. So, in order to deprotonate ethyne to any appreciable extent, we must use a different solvent—one that does not have a pK_a less than 25.

Conditions often used to do this reaction are sodium amide (NaNH_2) in liquid ammonia. Using the pK_a values of NH_3 (ca. 33) and ethyne (25) we would estimate an equilibrium constant for this reaction of 10^8 ($10^{-25}/10^{-33}$)—well over to the right. Amide ions can be used to deprotonate alkynes.

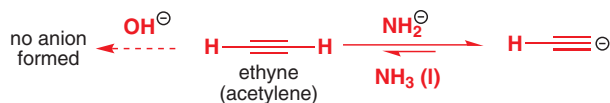

Since we have an upper and a lower limit on the strength of an acid or base that we can use in water, this poses a bit of a problem: how do we know that the pK_a for HCl is more negative than that of H_2SO_4 if both completely protonate water? How do we know that the pK_a of methane is greater than that of ethyne since both the conjugate bases fully deprotonate water? The answer is that we can't simply measure the equilibrium for the reaction in water—we can do this only for pK_a values that fall between the pK_a values of water itself. Outside this range, pK_a values are determined in other solvents and the results are extrapolated to give a value for what the pK_a in water might be.

Constructing a pK_a scale

We now want to look at ways to rationalize, and estimate, the different pK_a values for different compounds—we wouldn't want to have to memorize all the values. You will need to get a feel for the pK_a values of different compounds and if you know what factors affect them it will make it much easier to predict an approximate pK_a value, or at least understand why a given compound has the pK_a value that it does.



A number of factors affect the strength of an acid AH . These include:

1. The intrinsic stability of the conjugate base, anion A^- . Stability can arise by having the negative charge on an electronegative atom or by spreading the charge over several atoms (delocalization) groups. Either way, the more stable the conjugate base, the stronger the acid HA .
2. Bond strength A-H . Clearly, the easier it is to break this bond, the stronger the acid.
3. The solvent. The better the solvent is at stabilizing the ions formed, the easier it is for the reaction to occur.

● Acid strength

The most important factor in the strength of an acid is the stability of the conjugate base—the more stable the conjugate base, the stronger the acid.

An important factor in the stability of the conjugate base is which element the negative charge is on—the more electronegative the element, the more stable the conjugate base.

The negative charge on an electronegative element stabilizes the conjugate base

The pK_a values for the 'hydrides' of the first row elements CH_4 , NH_3 , H_2O , and HF are about 48, 33, 16, and 3, respectively. This trend is due to the increasing electronegativities across the period: F^- is much more stable than CH_3^- , because fluorine is much more electronegative than carbon.

Acid	Conjugate base	pK_a
methane CH_4	CH_3^-	~48
ammonia NH_3	amide ion NH_2^-	~33
water H_2O	hydroxide ion HO^-	~16
HF	fluoride ion F^-	3

Because the pK_a values for very strong acids and bases are so hard to determine, you will find that they often differ in different texts—sometimes the values are no better than good guesses! However, while the absolute values may differ, the relative values (which is the important thing because we need only a rough guide) are usually consistent.

Weak A–H bonds make stronger acids

However, on descending group VII (group 17), the pK_a values for HF, HCl, HBr, and HI decrease: 3, –7, –9, and –10. Since the electronegativities decrease on descending the group we might expect an increase in pK_a . The decrease is due to the weakening bond strengths on descending the group and to some extent the way in which the charge can be spread over the increasingly large anions.

Acid	Conjugate base	pK_a
HF	fluoride ion F^-	3
HCl	chloride ion Cl^-	–7
HBr	bromide ion Br^-	–9
HI	iodide ion I^-	–10

Delocalization of the negative charge stabilizes the conjugate base

The acids $HClO$, $HClO_2$, $HClO_3$, and $HClO_4$ have pK_a values 7.5, 2, –1, and about –10, respectively. In each case the acidic proton is on an oxygen attached to chlorine, that is, *we are removing a proton from the same environment in each case*. Why then is perchloric acid, $HClO_4$, some 17 orders of magnitude stronger in acidity than hypochlorous acid, $HClO$? Once the proton is removed, we end up with a negative charge on oxygen. For hypochlorous acid, this is localized on the one oxygen. With each successive oxygen, the charge can be more delocalized, and this makes the anion more stable. For example, with perchloric acid, the negative charge can be delocalized over all four oxygen atoms.

Acid	Conjugate base	pK_a
hypochlorous acid $HO-Cl$	ClO^-	7.5
chlorous acid $HO-ClO$	ClO_2^-	2
chloric acid $HO-ClO_2$	ClO_3^-	–1
perchloric acid $HO-ClO_3$	ClO_4^-	–10

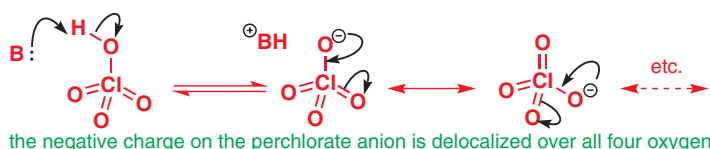

That the charge is spread out over all the oxygen atoms equally is shown by electron diffraction studies: whereas perchloric acid has two types of $Cl-O$ bond, one 163.5 pm and the other three 140.8 pm long, in the perchlorate anion all $Cl-O$ bond lengths are the same, 144 pm, and all $O-Cl-O$ bond angles are 109.5° . *Just to remind you:* these delocalization arrows do not indicate that the charge is actually moving from atom to atom. We discussed this in Chapter 7. These structures simply show that the charge is spread out in the molecular orbitals and mainly concentrated on the oxygen atoms.

Looking at some organic acids, we might expect alcohols to have a pK_a not far from that of water, and for ethanol that is correct (pK_a 15.9). If we allow the charge in the conjugate base to be delocalized over two oxygen atoms, as in acetate, acetic acid is indeed a much stronger acid (pK_a 4.8). The difference is huge: the conjugation makes acetic acid about 10^{10} times stronger.

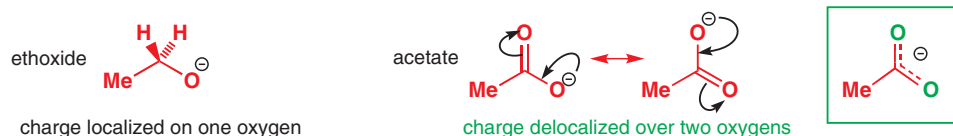

It is even possible to have a negative charge of an organic acid delocalized over *three* atoms—as in the anions of the sulfonic acids. Methanesulfonic acid has a pK_a of -1.9 .

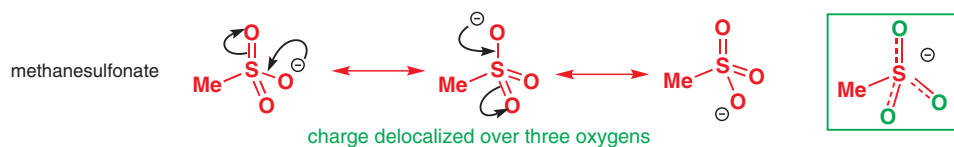

Even delocalization into a hydrocarbon part of the molecule increases acid strength. In phenol, PhOH, the OH group is directly attached to a benzene ring. On deprotonation, the negative charge can again be delocalized, not onto other oxygen atoms but into the aromatic ring itself. The effect of this is to stabilize the phenoxide anion relative to the conjugate base of cyclohexanol, where no delocalization is possible, and this is reflected in the pK_a values of the two compounds: 10 for phenol but 16 for cyclohexanol.

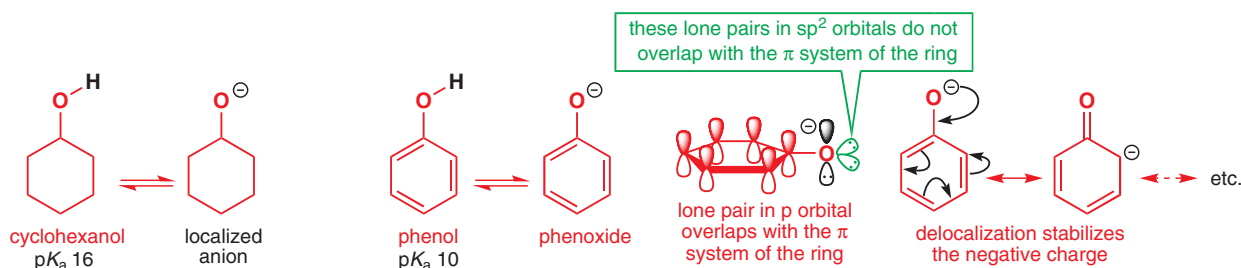

So now we can expand our chart of acid and base strengths to include the important classes of alcohols, phenols, and carboxylic acids. They conveniently, and memorably, have pK_a values of about 0 for the protonation of alcohols, about 5 for the deprotonation of carboxylic acids, about 10 for the deprotonation of phenols, and about 15 for the deprotonation of alcohols. The equilibria above each pK_a shows that at approximately that pH, the two species each form 50% of the mixture. You can see that carboxylic acids are weak acids, alkoxide ions (RO^-) are strong bases, and that it will need a strong acid to protonate an alcohol.

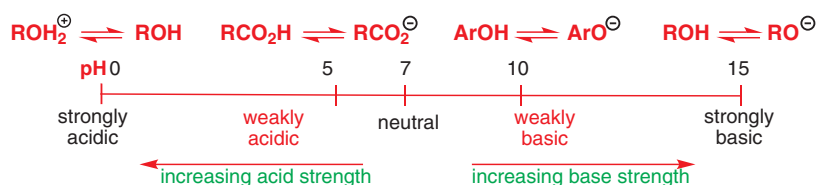

■ equilibrium arrow: \rightleftharpoons
 delocalization arrow \longleftrightarrow
 Reminder: the equilibrium arrows mean two interconverting compounds. The double-headed arrow means two ways of drawing a conjugated structure.

■ It is worthwhile learning these approximate values.

If we need to make the anion of a phenol, a base such as NaOH will be good enough, but if we want to make an anion from an alcohol, we need a stronger base. Vogel (p. 986) suggests potassium carbonate (K_2CO_3) is strong enough to make an ether from phenol. The base strength of carbonate anion is about the same as that of phenoxide ion (PhO^-) so the two will be in equilibrium but enough phenoxide ion will be present for the reaction.

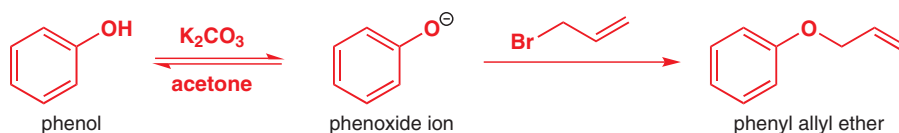

On the other hand, if we want to make the OH group into a good leaving group, we need to protonate it and a very strong acid will be needed. Sulfuric acid is used to make ethers from alcohols. Protonation of the OH groups leads to loss of water and formation of a cation. This reacts with more alcohol to give the ether. There is another example of this reaction in Chapter 5.

■ As you will discover in Chapters 10 and 15, a *leaving group* is simply a functional group that will leave the molecule, taking with it the pair of electrons that formed the bond. Leaving groups may be anions, such as bromide Br^- , or protonated groups such as the protonated alcohol in this example, which leaves as water.

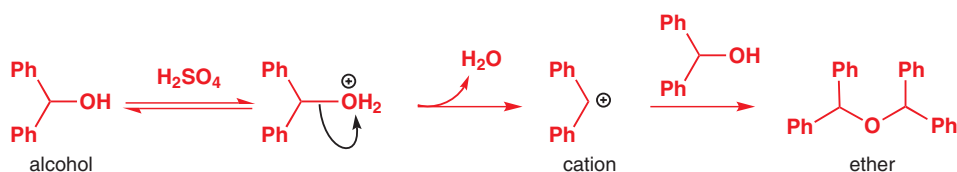

Nitrogen compounds as acids and bases

The most important organic nitrogen compounds are amines and amides. Amine nitrogens can be joined to alkyl or aryl groups (in which case the amines are called anilines). They all have lone pairs on nitrogen and may have hydrogen atoms on nitrogen too. As nitrogen is less electronegative than oxygen, you should expect amines to be less acidic and more basic than alcohols. And they are. The pK_a values for the protonated amines are about 10 (this value is about 0 for water and alcohol) and the pK_a values for amines acting as acids are very high, something like 35 (compared with about 15 for an alcohol). So ammonium salts are about as acidic as phenols and amines will be protonated at pH 7 in water. This is why amino acids (p. 167) exist as zwitterions in water.

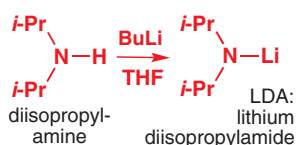
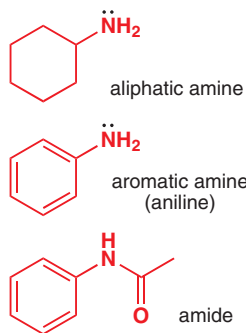

Removing a proton from an amine is very difficult as the anion (unfortunately called an ‘amide’ anion) is very unstable and very basic. The only way to succeed is to use a very strong base, usually an alkyllithium. The ‘anion’ then has a N–Li bond and is soluble in organic solvents. This example, known as LDA, is commonly used as a strong base in organic chemistry.

The basicity of amines as neutral compounds is measured by the pK_a of their conjugate acids—so, for example, the pK_a associated with the protonation of triethylamine, a commonly used tertiary amine, is 11.0.

The ‘ pK_a s’ of bases

Chemists often say things like ‘the pK_a of triethylamine is about 10.’ (It’s actually 11.0 but 10 is a good number to remember for typical amines). This may surprise you as triethylamine has no acidic hydrogens. What they mean is of course this: ‘the pK_a of the conjugate acid of triethylamine is about 10.’ Another way to put this is to write ‘the pK_{aH} of triethylamine is about 10.’ The subscript ‘aH’ refers to the conjugate acid.

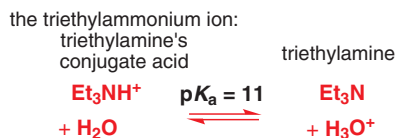

It’s OK to say ‘the pK_a of triethylamine is about 10’ as long as you understand that what is really meant is ‘the pK_a of the triethylammonium ion is about 10’, which can also be expressed thus: ‘the pK_{aH} of triethylamine is about 10’

When a molecule is both acidic and basic, as for example aniline, it is important to work out which pK_a is meant as again chemists will loosely refer to ‘the pK_a of aniline is 4.6’ when they mean ‘the pK_a of the conjugate acid of aniline is 4.6.’ Aniline is much less basic than ammonia or triethylamine because the lone pair on nitrogen is conjugated into the ring and less available for protonation.

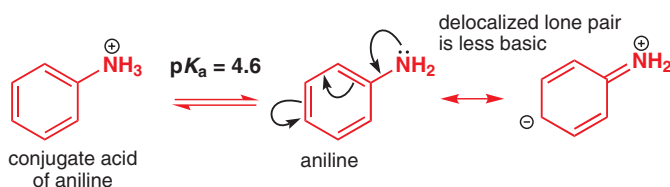

But for the same reason, aniline is also more acidic than ammonia (pK_a 33) and has a genuine pK_a in which one of the protons on nitrogen is lost. So we can say correctly that ‘the pK_a of aniline is about 28.’ Just be careful to check which pK_a is meant in such compounds. The full picture is:

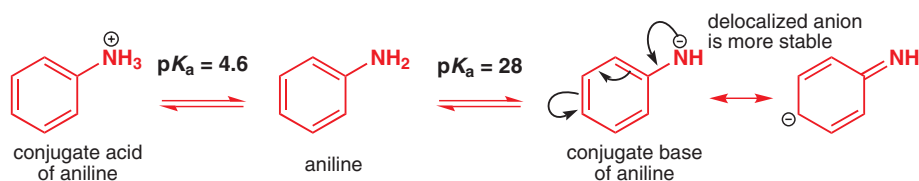

The pK_a associated for protonation of piperidine, a typical secondary amine, is about 13. The equivalent pK_a for protonation of pyridine—a compound with a similar heterocyclic structure, but with its lone pair in an sp^2 rather than an sp^3 orbital, is only 5.5: pyridine is a weaker base than piperidine (its conjugate acid is a stronger acid). Nitriles, whose lone pair is sp hybridized, are not basic at all. Lone pairs with more p character (sp^3 orbitals are $3/4 p$, while sp orbitals are $1/2 p$) are higher in energy—they spend more time further from the nucleus—and are therefore more basic.

Amides are very different because of the delocalization of the lone pair into the carbonyl group. This makes amides more acidic but less basic and protonation occurs on oxygen rather than nitrogen. Amides have pK_a values of around 15 when they act as acids, making them some 10^{10} times more acidic than amines. The pK_a of protonated amides is around 0, making them some 10^{10} times weaker as bases.

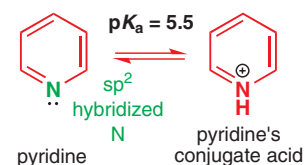
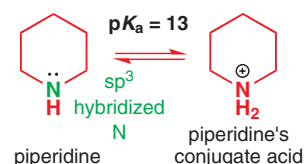
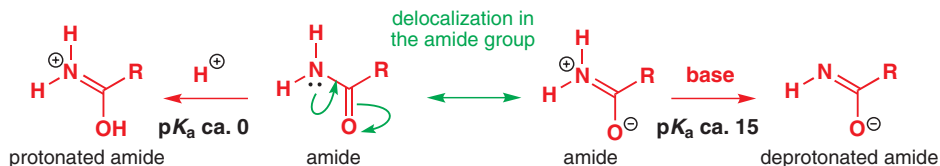

Delocalization in amides was discussed on p. 155.

If we replace the carbonyl oxygen atom in an amide by nitrogen we get an amidine. Amidines are conjugated, like amides, but unlike amides they are *stronger* bases than amines, by about 2–3 pK_a units, because the two nitrogens work together to donate electron density onto each other. The bicyclic amidine DBU is often used as a strong organic base (see Chapter 17).

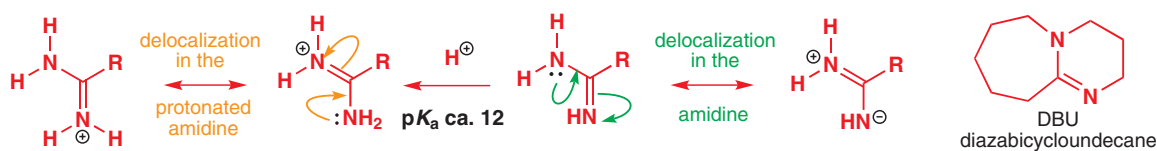

But the champions are the guanidines, with three nitrogens all donating lone pair electrons at once. A guanidine group (shown in green) makes arginine the most basic of the amino acids.

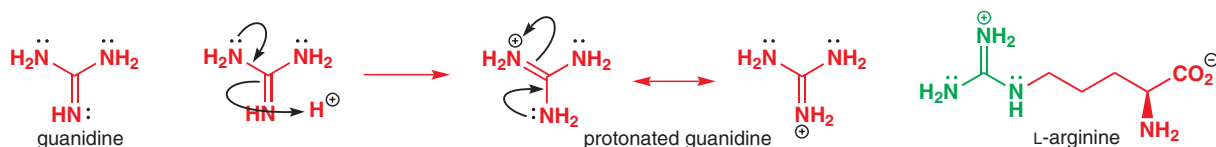

Substituents affect the pK_a

Substituents that are conjugated with the site of proton gain or loss, and even substituents that are electronegative but not conjugating, can have significant effects on pK_a values. Phenol has pK_a 10 but phenols with anions stabilized by extra conjugation can have much lower pK_a s.

Picric acid is a very acidic phenol

2,4,6-Trinitrophenol's more common name, picric acid, reflects the strong acidity of this compound (pK_a 0.7 compared to phenol's 10.0). Picric acid used to be used in the dyeing industry but is little used now because it is also a powerful explosive when dry. (Compare its structure with that of TNT!)

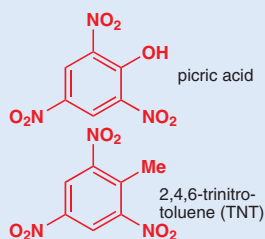

■ If you draw a carboxylate anion you will find that it is impossible to stabilize its negative charge any further by conjugation, other than between the two oxygens.

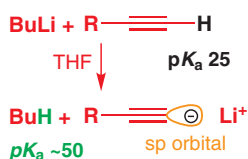

■ If you don't see why this is, think about the shapes of an s and a p orbital: the nucleus sits in the node of a p orbital, but in an s orbital the nucleus is in a region of high electron density. The more s character a negative charge has, the closer the electron density is to the nucleus, and the more stable it is.

One nitro group, as in *p*-nitrophenol, lowers the pK_a to 7.14, nearly a thousand-fold increase in acidity. This is because the negative charge on oxygen is delocalized into the very electron-withdrawing nitro group. By contrast 4-chlorophenol, with only inductive withdrawal in the C–Cl bond, has pK_a 9.38, hardly different from phenol itself.

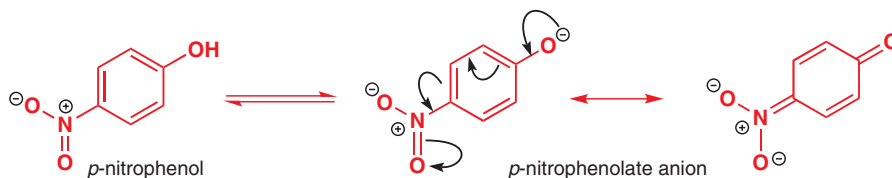

Inductive effects of nearby electronegative atoms can also have marked effects on the pK_a of acids. Adding fluorines to acetic acid reduces the pK_a from about 5 by smallish steps. Trifluoroacetic acid (TFA) is a very strong acid indeed, and is commonly used as a convenient strong acid in organic reactions. Inductive effects occur by polarization of σ bonds when the atom at one end is more electronegative than at the other. Fluorine is much more electronegative than carbon (indeed, F is the most electronegative element of all) so each σ bond is very polarized, making the carbon atom more electropositive and stabilizing the carboxylate anion.

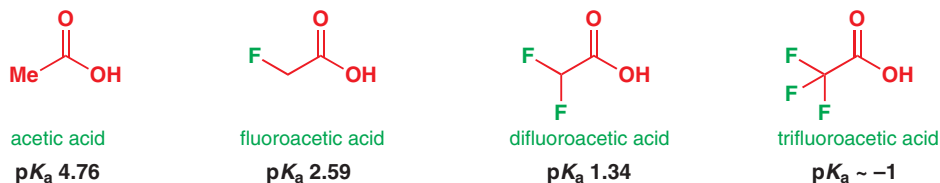

Carbon acids

Hydrocarbons are not acidic. We have already established that methane has a pK_a of about 48 (p. 170 above)—it's essentially impossible to deprotonate. Alkylolithiums are for this reason among the strongest bases available. But some hydrocarbons *can* be deprotonated, the most important example being alkynes—you saw on p. 171 that acetylene has a pK_a of 25 and can be deprotonated by NH_2^- (as well as other strong bases such as BuLi). The difference is one of hybridization—an idea we introduced with the nitrogen bases above. Making the acetylide anion, whose negative charge resides in an sp orbital, is much easier than making a methyl anion, with a negative charge in an sp^3 orbital, because electrons in sp orbitals spend a lot of their time closer to the nucleus than electrons in sp^3 orbitals.

C–H bonds can be even more acidic than those of acetylene if stabilization of the resulting anion is possible by *conjugation*. Conjugation with a carbonyl group has a striking effect. One carbonyl group brings the pK_a down to 13.5 for acetaldehyde so that even hydroxide ion can produce the anion. You will discover in Chapter 20 that we call this the 'enolate anion' and that the charge is mostly on oxygen, although the anion can be drawn as a carbanion.

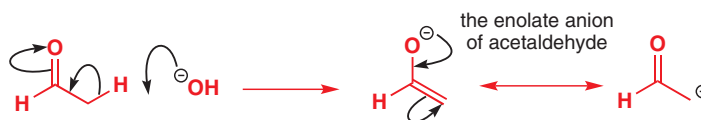

It is interesting to compare the strengths of the carbon, nitrogen, and oxygen acids of similar structure below. The ketone (acetone) is of course least acidic, the amide is more acidic, and the carboxylic acid most acidic. The oxyanion conjugate bases are all delocalized but delocalization onto a second very electronegative oxygen atom is much (~10 pH units) more effective than delocalization onto nitrogen, which is 4 pH units more effective than delocalization onto carbon.

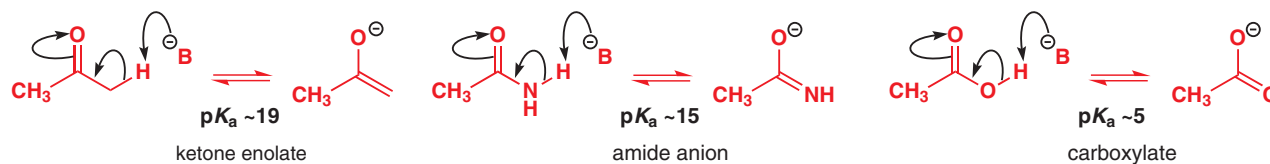

Nevertheless, the effect of conjugation on the carbon acid compared with methane is enormous (~30 pH units) and brings proton removal from carbon within the range of accessible bases

The nitro group is even more effective: nitromethane, with a pK_a of 10, dissolves in aqueous NaOH. The proton is removed from carbon, but the negative charge in the conjugate base is on oxygen. The big difference is that the nitrogen atom has a positive charge throughout. If the anion is protonated in water by some acid (HA) the 'enol' form of nitromethane is the initial product and this slowly turns into nitromethane itself. Whereas proton transfers between electronegative atoms (O, N, etc.) are fast, proton transfers to or from carbon can be slow.

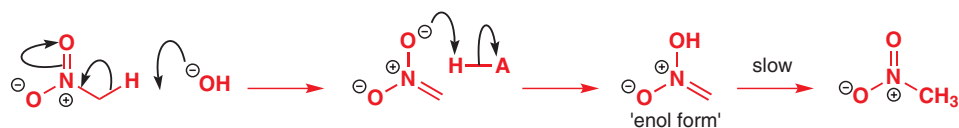

Carbon acids are very important in organic chemistry as they allow us to make carbon-carbon bonds and you will meet many more of them in later chapters of this book.

Why do we need to compare acid strengths of O and N acids?

The rates of nucleophilic addition to carbonyl groups that you met in Chapter 6 depend on the basicity of nucleophiles. As nitrogen bases are much stronger than oxygen bases (or, if you prefer, ammonium ions are much weaker acids than H_3O^+), amines are also much better nucleophiles than water or alcohols. This is dramatically illustrated in an amide synthesis from aniline and acetic anhydride in aqueous solution.

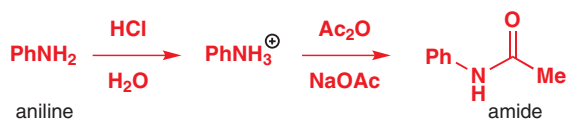

Aniline is not very soluble in water but addition of HCl converts it into the soluble cation by protonation at nitrogen. The solution is now warmed and equal amounts of acetic anhydride and aqueous sodium acetate are added. The pK_a of acetic acid is about 5, as is the pK_a of PhNH_3^+ , so an equilibrium is set up and the solution now contains these species:

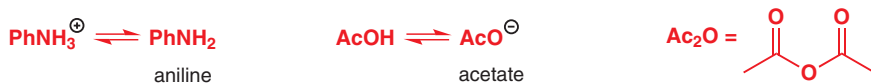

The only electrophile is acetic anhydride, with its two electrophilic carbonyl groups. The nucleophiles available are water, aniline, and acetate. Water is there in great abundance and does react with acetic anhydride but can't compete with the other two as they are more basic (by about 10^5). If acetate attacks the anhydride, it simply regenerates acetate. But if aniline attacks, the amide is formed as acetate is released.

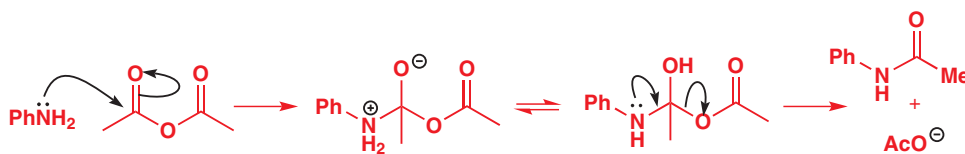

The isolation of the product is easy as the amide is insoluble in water and can be filtered off. Environmental considerations suggest that we should not use organic solvents so much and should use water when possible. If we have some idea about pK_a s we can estimate whether water will interfere in a reaction we are planning and decide whether it is a suitable solvent or not. It is even possible to acylate amines with the more reactive acid chlorides in aqueous solution, and we will return in detail to acylation reactions such as these in Chapter 10.

pK_a in action—the development of the drug cimetidine

Histamine is an agonist in the production of gastric acid. It binds to specific sites (receptor sites) in the stomach cells and triggers the production of gastric acid (mainly HCl).

An antagonist works by binding to the receptor but not stimulating acid secretion. It therefore inhibits acid secretion by blocking the receptor sites.

■ When the drug was invented, the company was called Smith, Kline and French (SKF) but after a merger with Beechams the company became SmithKline Beecham (SB). SB and GlaxoWellcome later merged to form GlaxoSmithKline (GSK). Things may have changed further by the time you read this book.

The development of the anti-peptic ulcer drug cimetidine gives a fascinating insight into the important role of pK_a in chemistry. Peptic ulcers are a localized erosion of the mucous membrane, resulting from overproduction of gastric acid in the stomach. One of the compounds that controls the production of the acid is histamine. (Histamine is also responsible for the symptoms of hay fever and allergies.)

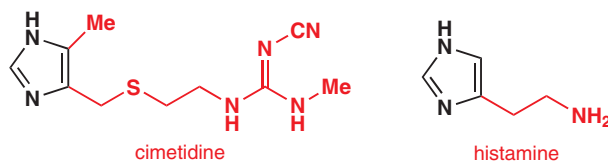

Histamine works by binding into a receptor in the stomach lining and stimulating the production of acid. What the developers of cimetidine at Smith, Kline and French wanted was a drug that would bind to these receptors without activating them and thereby prevent histamine from binding but not stimulate acid secretion itself. Unfortunately, the antihistamine drugs successfully used in the treatment of hay fever did not work—a different histamine receptor was involved.

Notice that cimetidine and histamine both have the same nitrogen-containing ring (shown in black) as part of their structures. This ring is known as an imidazole—imidazole itself is quite a strong base whose protonated form is delocalized as shown below. This is not coincidence—cimetidine's design was centred around the structure of histamine.

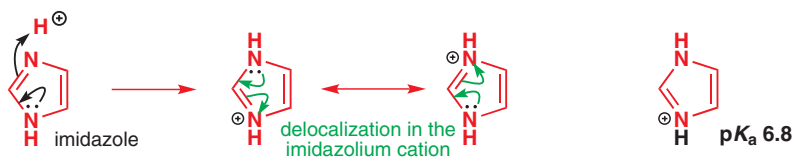

➔ Guanidine was introduced to you on p. 175.

In the body, most histamine exists as a salt, being protonated on the primary amine and the early compounds modelled this. The guanidine analogue was synthesized and tested to see if it had any antagonistic effect (that is, if it could bind in the histamine receptors and prevent histamine binding). It did bind but unfortunately it acted as an *agonist* rather than an *antagonist* and stimulated acid secretion rather than blocking it. Since the guanidine analogue has a pK_a even greater than histamine (about 14.5 compared to about 10), it is effectively all protonated at physiological pH.

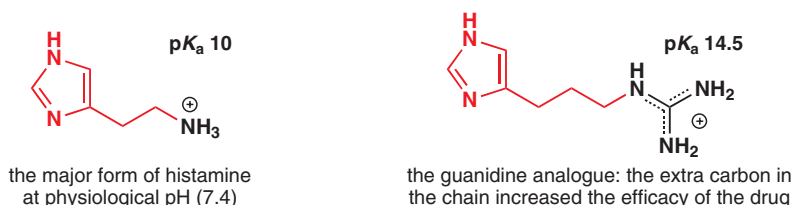

■ Remember that amidines and guanidines, p. 175, are basic but that amides aren't. The thiourea, and indeed a urea, is more like an amide.

The agonistic behaviour of the drug clearly had to be suppressed. The thought occurred to the chemists that perhaps the positive charge made the compound agonistic, and so a polar but much less basic compound was sought. Eventually, they came up with burimamide. The most important change is the replacement of the $C=NH$ in the guanidine compound by $C=S$. Now instead of a guanidine we have a thiourea, which is much less basic. Other adjustments were to increase the chain length, insert a second sulfur atom on the chain, and add methyl groups to the thiourea and the imidazole ring, to give metiamide with increased efficacy.

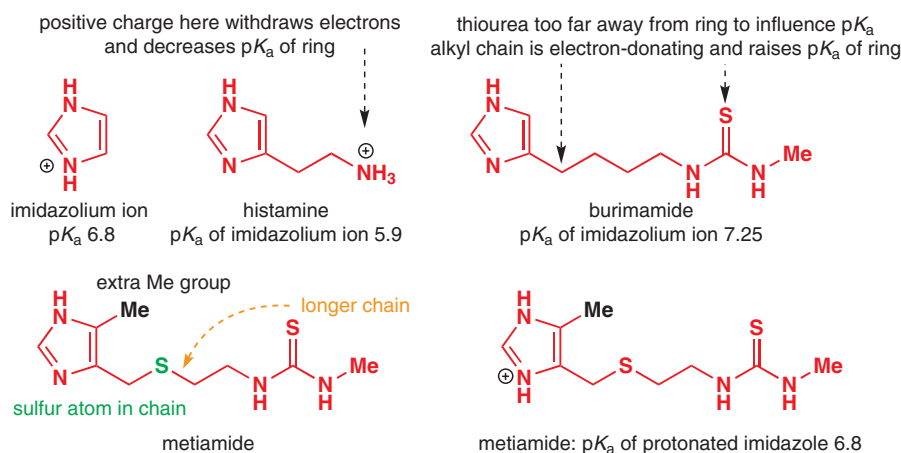

The new drug, metiamide, was ten times more effective than burimamide when tested in humans. However, there was an unfortunate side-effect: in some patients: the drug caused a decrease in the number of white blood cells, leaving the patient open to infection. This was eventually traced back to the thiourea group. The sulfur had again to be replaced by oxygen, to give a normal urea and, just to see what would happen, by nitrogen to give another guanidine.

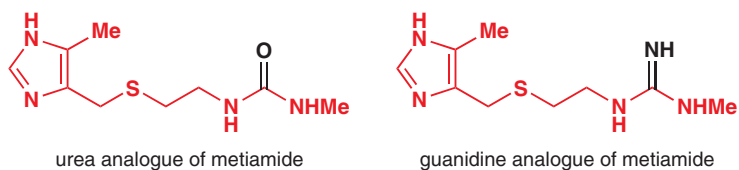

Neither was as effective as metiamide but the important discovery was that the guanidine analogue no longer showed the agonistic effects of the earlier guanidine. Of course, the guanidine would also be protonated so we had the same problem we had earlier—how to decrease the pK_a of the guanidinium ion. A section of this chapter considered the effect of electron-withdrawing groups on pK_a and showed that they make a base less basic. This was the approach now adopted—the introduction of electron-withdrawing groups on to the guanidine to lower its pK_a. The table below shows the pK_as of various substituted guanidinium ions.

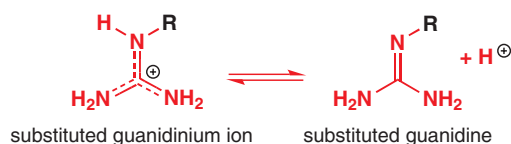
pK_as of substituted guanidinium ions

R	H	Ph	CH ₃ CO	NH ₂ CO	MeO	CN	NO ₂
pK _a	14.5	10.8	8.33	7.9	7.5	-0.4	-0.9

Clearly, the cyano and nitro-substituted guanidines would not be protonated at all. These were synthesized and found to be just as effective as metiamide but without the side-effects. Of the two, the cyanoguanidine compound was slightly more effective and this was developed and named 'cimetidine'.

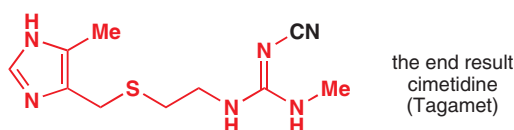

The development of cimetidine by Smith, Kline and French from the very start of the project up to its launch on the market took 13 years. This enormous effort was well rewarded—Tagamet (the trade name of the drug cimetidine) became the best-selling drug in the world and the first to gross more than one billion dollars per annum. Thousands of ulcer patients worldwide no longer had to suffer pain, surgery, or even death. The development of cimetidine followed a rational approach based on physiological and chemical principles and it was for this that one of the scientists involved, Sir James Black, received a share of the 1988 Nobel Prize for Physiology or Medicine. None of this would have been possible without an understanding of pK_a s.

Lewis acids and bases

Johannes Nicolaus Brønsted (1879–1947) was a Danish physical chemist who, simultaneous with Thomas Lowry, introduced the protic theory of acid–base reactions in 1923.

All the acids and bases we have been discussing so far have been protic, or *Brønsted*, acids and bases. In fact, the definition of an acid and a base we gave you on p. 165 is a definition of a Brønsted acid and a Brønsted base. When a carboxylic acid gives a proton to an amine, it is acting as a Brønsted acid while the amine is a Brønsted base. The ammonium ion produced is a Brønsted acid while the carboxylate anion is a Brønsted base.



- Brønsted acids donate protons.
- Brønsted bases accept protons.

But there is another important type of acid: the Lewis acid. These acids don't donate protons—indeed they usually have no protons to donate. Instead they accept electrons. It is indeed a more general definition of acids to say that they accept electrons and of bases that they donate electrons. Lewis acids are usually halides of the higher oxidation states of metals, such as BF_3 , AlCl_3 , ZnCl_2 , SbF_5 , and TiCl_4 . By removing electrons from organic compounds, Lewis acids act as important catalysts in important reactions such as the Friedel–Crafts alkylation and acylation of benzene (Chapter 21), the $\text{S}_{\text{N}}1$ substitution reaction (Chapter 15), and the Diels–Alder reaction (Chapter 34).

The American chemist Gilbert Lewis (1875–1946) introduced his electronic theory of acid–base interactions in 1924.

- Lewis acids accept electrons.
- Lewis bases donate electrons.

A simple Lewis acid is BF_3 . As you saw in Chapter 5, monomeric boron compounds have three bonds to other atoms and an empty p orbital, making six electrons only in the outer shell. They are therefore not stable and BF_3 is normally used as its 'etherate': a complex with Et_2O . Ether donates a pair of electrons into the empty p orbital of BF_3 and this complex has tetrahedral boron with eight electrons. In this reaction the ether donates electrons (it can be described as a Lewis base) and BF_3 accepts electrons: it is a Lewis acid. No protons are exchanged. The complex is a stable liquid and is the form usually available from suppliers.

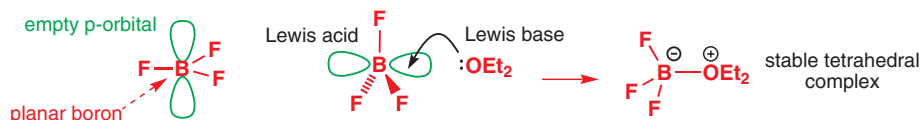

Lewis acids often form strong interactions with electronegative atoms such as halides or oxygen. In the Friedel–Crafts acylation, which you will meet in Chapter 21, for example, AlCl_3 removes the chloride ion from an acyl chloride to give a species, the acylium ion, which is reactive enough to combine with benzene.

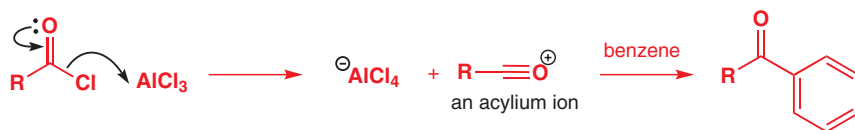

Lewis acid–base interactions are very common in chemistry and are often rather subtle. You are about to meet, in the next chapter, an important way of making C–C bonds by adding organometallics to carbonyl compounds, and in many of these reactions there is an interaction at some point between a Lewis acidic metal cation and a Lewis basic carbonyl group.

Further reading

The quote at the start of the chapter comes from Ross Stewart, *The Proton: Applications to Organic Chemistry*, Academic Press, Orlando, 1985, p 1.

More detailed information about acid/base extraction can be found in any organic practical book. The details of the Cannizzaro reaction are from J. C. Gilbert and S. F. Martin, *Experimental Organic Chemistry*, Harcourt, Fort Worth, 2002. The reduction of amides to amines comes from B. S. Furniss, A. J. Hannaford, P. W. G. Smith,

and A. R. Tatchell, *Vogel's Textbook of Practical Organic Chemistry*, 5th edn, Longman, Harlow, 1989.

Details about the acylation of amines with anhydrides and acid chlorides are in L. M. Harwood, C. J. Moody, and J. M. Percy, *Experimental Organic Chemistry*, 2nd edn, Blackwell, Oxford, 1999, p 279.

There is more about the discovery of cimetidine in W. Sneader, *Drug Discovery: a History*, Wiley, Chichester, 2005.

Check your understanding



To check that you have mastered the concepts presented in this chapter, attempt the problems that are available in the book's Online Resource Centre at <http://www.oxfordtextbooks.co.uk/orc/clayden2e/>

9

Using organometallic reagents to make C–C bonds

Connections

➔ Building on

- Electronegativity and the polarization of bonds **ch4**
- Grignard reagents and organolithiums attack carbonyl groups **ch6**
- C–H deprotonated by very strong bases **ch8**

Arriving at

- Organometallics: nucleophilic and often strongly basic
- Making organometallics from halo-compounds
- Making organometallics by deprotonating carbon atoms
- Using organometallics to make new C–C bonds from C=O groups

➔ Looking forward to

- More about organometallics **ch24 & ch40**
- More ways to make C–C bonds from C=O groups **ch25, ch26, & ch27**
- Synthesis of molecules **ch28**

Introduction

In Chapters 2–8 we covered basic chemical concepts concerning *structure* (Chapters 2–4 and 7) and *reactivity* (Chapters 5, 6, and 8). These concepts are the bare bones supporting all of organic chemistry, and now we shall start to put flesh on these bare bones. In Chapters 9–22 we shall tell you about the most important classes of organic reaction in more detail.

One of the things organic chemists do, for all sorts of reasons, is to make molecules, and making organic molecules means making C–C bonds. In this chapter we are going to look at one of the most important ways of making C–C bonds: using organometallics, such as organolithiums and Grignard reagents, in combination with carbonyl compounds. We will consider reactions such as these:

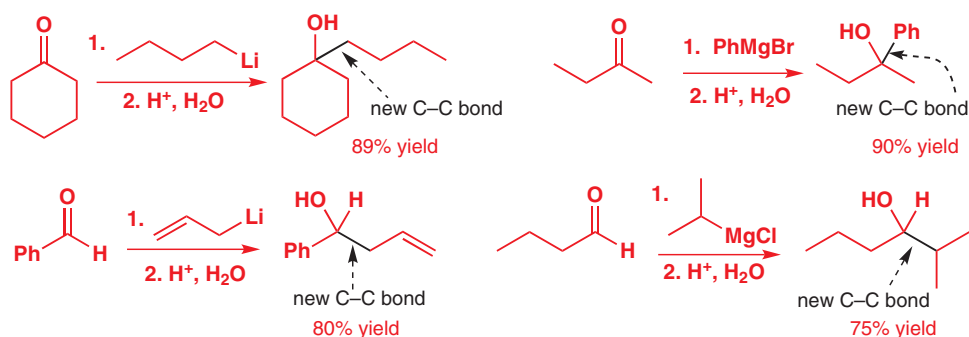

You met these types of reactions in Chapter 6: in this chapter we will be adding more detail with regard to the nature of the organometallic reagents and what sort of molecules can be made using the reactions. The organometallic reagents act as nucleophiles towards the

Online support. The icon  in the margin indicates that accompanying interactive resources are provided online to help your understanding: just type www.chemtube3d.com/clayden/123 into your browser, replacing **123** with the number of the page where you see the icon. For pages linking to more than one resource, type **123-1, 123-2** etc. (replacing **123** with the page number) for access to successive links.

electrophilic carbonyl group, and this is the first thing we need to discuss: why are organometallics nucleophilic? We then move on to, firstly, how to make organometallics, then to the sorts of electrophiles they will react with, and finally to the sort of molecules we can make with them.

Organometallic compounds contain a carbon–metal bond

The polarity of a covalent bond between two different elements is determined by electronegativity. The more electronegative an element is, the more it attracts the electron density in the bond. So the greater the *difference* between the electronegativities, the greater the difference between the attraction for the bonding electrons, and the more polarized the bond becomes. In the extreme case of complete polarization, the covalent bond ceases to exist and is replaced by electrostatic attraction between ions of opposite charge. We discussed this in Chapter 4 (p. 96), where we considered the extreme cases of bonding in NaCl.

How important are organometallics for making C–C bonds?

As an example, let's take a molecule known as 'juvenile hormone'. It is a compound that prevents several species of insects from maturing and can be used as a means of controlling insect pests. Only very small amounts of the naturally occurring compound can be isolated from the insects, but it can instead be made in the laboratory from simple starting materials. At this stage you need not worry about how, but we can tell you that, in one synthesis, of the 16 C–C bonds in the final product, seven were made by reactions of organometallic reagents, many of them the sort of reactions we will describe in this chapter. This is not an isolated example. As further proof, take an important enzyme inhibitor, closely related to arachidonic acid which you met in Chapter 7. It has been made by a succession of C–C bond-forming reactions using organometallic reagents: eight of the 20 C–C bonds in the product were formed using organometallic reactions.

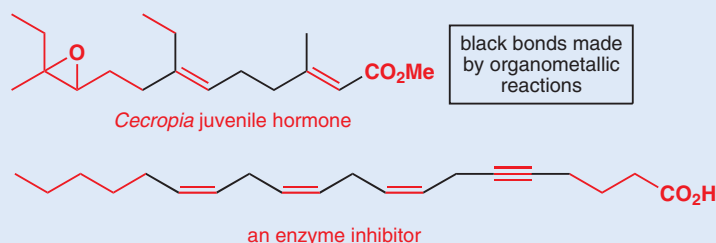

When we discussed (in Chapter 6) the electrophilic nature of carbonyl groups we saw that their reactivity is a direct consequence of the polarization of the carbon–oxygen bond towards the more electronegative oxygen, making the carbon a site for nucleophilic attack. In Chapter 6 you also met the two most important organometallic compounds—organolithiums and organomagnesium halides (known as Grignard reagents). In these organometallic reagents the key bond is polarized in the opposite direction—*towards* carbon—making carbon a nucleophilic centre. This is true for most organometallics because, as you can see from this edited version of the periodic table, metals (such as Li, Mg, Na, and Al) all have lower electronegativity than carbon.

Pauling electronegativities of selected elements

Li 1.0		B 2.0	C 2.5	N 3.0	O 3.5	F 4.0
Na 0.9	Mg 1.3	Al 1.6	Si 1.9	P 2.2	S 2.6	Cl 3.2

The molecular orbital energy level diagram—the kind you met in Chapter 4—represents the C–Li bond in methyllithium in terms of the sum of the atomic orbitals of carbon and lithium. The more electronegative an atom is, the lower in energy are its atomic orbitals (p. 96). The filled C–Li σ orbital is closer in energy to the carbon's sp^3 orbital than to the lithium's 2s orbital, so we can say that the carbon's sp^3 orbital makes a greater contribution to the C–Li σ bond and that the C–Li bond has a larger coefficient on carbon. Reactions involving the filled

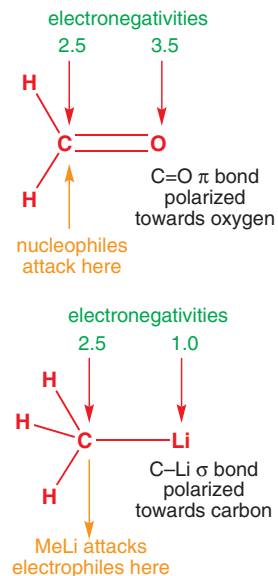

 Interactive display of polarity of organometallics

 We explained this reasoning on p. 104.

σ orbital will therefore take place at C rather than Li. The same arguments hold for the C–Mg bond of organo-magnesium or Grignard reagents, named after their inventor Victor Grignard.

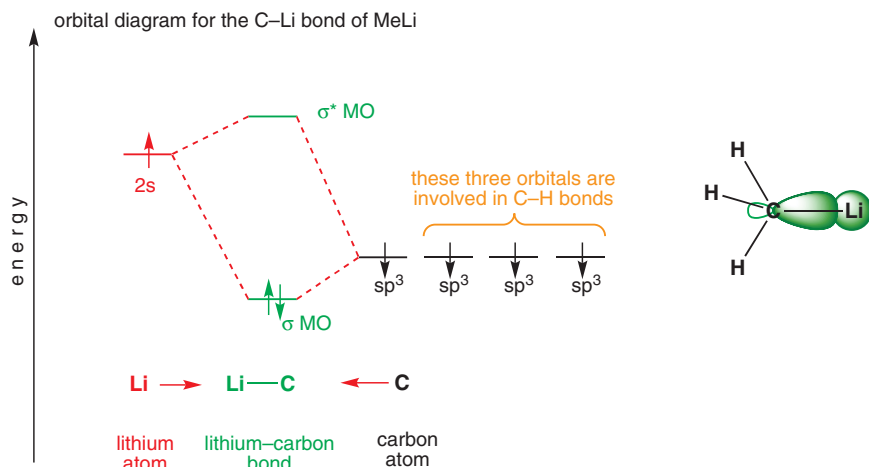

■ Carbon atoms that carry a negative charge are known as **carbanions**.

You have already met cyanide (p. 121), a carbanion that really does have a lone pair on carbon. Cyanide's lone pair is stabilized by being in a lower-energy sp orbital (rather than sp³) and by having the electronegative nitrogen atom triply bonded to the carbon.

We can also say that, because the carbon's sp³ orbital makes a greater contribution to the C–Li σ bond, the σ bond is close in structure to a filled C sp³ orbital—a lone pair on carbon. This useful idea can be carried too far: methyl lithium is not an ionic compound Me[–]Li⁺—although you may sometimes see MeLi or MeMgCl represented in mechanisms as Me[–].

The true structure of organolithiums and Grignard reagents is rather more complicated! Even though these organometallic compounds are extremely reactive towards water and oxygen, and have to be handled under an atmosphere of nitrogen or argon, some have been studied by X-ray crystallography in the solid state and by NMR in solution. It turns out that they generally form complex aggregates with two, four, six, or more molecules bonded together, often with solvent molecules, one reason why apparently polar compounds such as BuLi dissolve in hydrocarbons. In this book we shall not be concerned with these details, and we shall represent organometallic compounds as simple monomeric structures.

Making organometallics

How to make Grignard reagents

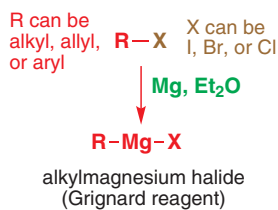

Grignard reagents are made by reacting magnesium turnings with alkyl halides in ether solvents to form solutions of alkylmagnesium halide. Iodides, bromides, and chlorides can be used, as can both aryl and alkyl halides. Our examples include methyl, primary, secondary, and tertiary alkyl halides, aryl and allyl halides. They cannot contain any functional groups that would react with the Grignard reagent once it is formed. The final example has an acetal functional group as an example of one that does not react with the Grignard reagent. (See Chapter 23 for further discussion.)

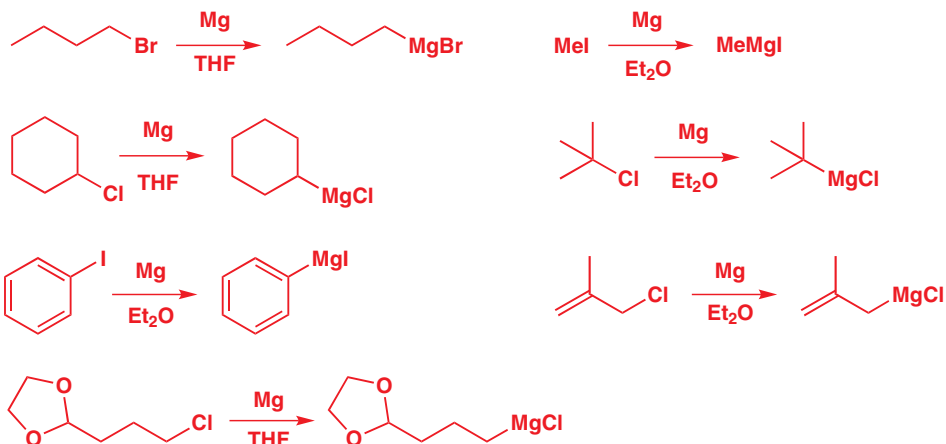

Interactive mechanism for Grignard addition

The solvents in these examples are all ethers, either diethyl ether Et_2O or THF. Other solvents that are sometimes used include the diethers dioxane and dimethoxyethane (DME).

common ether solvents

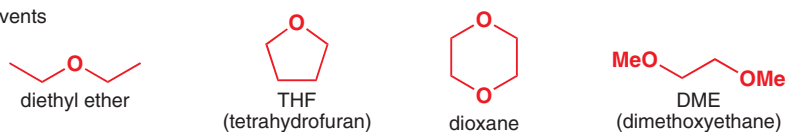

The reaction scheme is easy enough to draw, but what is the mechanism? Overall it involves an *insertion* of magnesium into the carbon–halogen bond. There is also a change in oxidation state of the magnesium, from $\text{Mg}(0)$ to $\text{Mg}(\text{II})$. The reaction is therefore known as an oxidative insertion or oxidative addition, and is a general process for many metals such as Mg , Li (which we meet shortly), Cu , and Zn . $\text{Mg}(\text{II})$ is much more stable than $\text{Mg}(0)$ and this drives the reaction.

The mechanism of the reaction is not completely understood, and probably involves radical intermediates. But what is sure is that by the end of the reaction the magnesium has surrendered its lone pair of electrons and gained two σ bonds. The true product is a complex between the Grignard reagent and, probably, two molecules of the ether solvent, as $\text{Mg}(\text{II})$ prefers a tetrahedral structure.

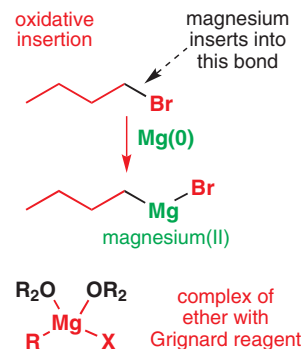

More on making Grignard reagents

The reaction takes place not in solution but on the surface of the metal, and how easy it is to make a Grignard reagent can depend on the state of the surface—how finely divided the metal is, for example. Magnesium is usually covered by a thin coating of magnesium oxide, and Grignard formation generally requires ‘initiation’ to allow the metal to come into direct contact with the alkyl halide. Initiation usually means adding a small amount of iodine or 1,2-diiodoethane, or using ultrasound to dislodge the oxide layer. Once the Grignard starts to form, it catalyses further reactions of $\text{Mg}(0)$, perhaps by this mechanism:

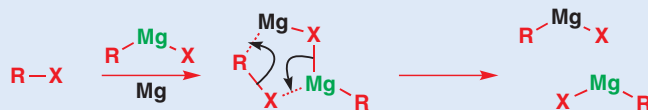

How to make organolithium reagents

Organolithium compounds may be made by a similar oxidative insertion reaction from lithium metal and alkyl halides. Each inserting reaction requires two atoms of lithium and generates one equivalent of lithium halide salt. As with Grignard formation, there is really very little limit on the types of organolithium that can be made this way.

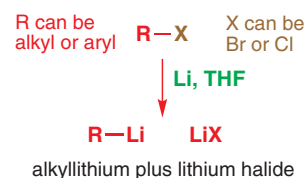
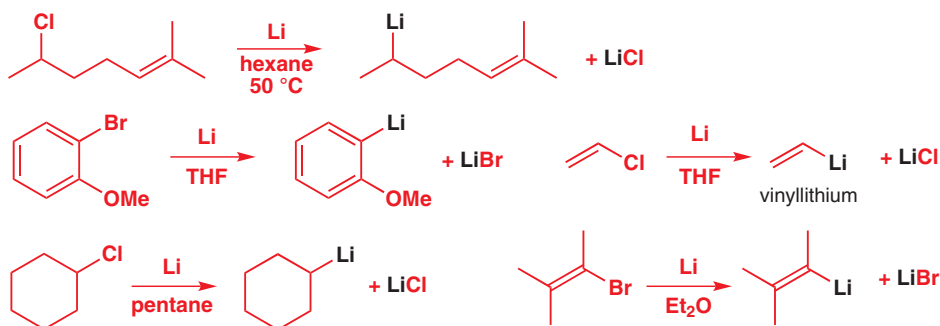

You will notice secondary alkylolithiums, an aryllithium, and two vinylolithiums. The only other functional groups are alkenes and an ether. So far, that is quite like the formation of Grignard reagents. However, there are differences. Lithium goes from $\text{Li}(0)$ to $\text{Li}(\text{I})$ during the

Interactive mechanism for organolithium addition

reaction and there is no halide attached to the Li. Instead a second Li atom has to be used to make the Li halide. Again, Li(I) is very much more stable than Li(0) so the reaction is irreversible. Although ether solvents are often used, there is less need for extra coordination and hydrocarbon solvents such as pentane or hexane are also good.

Commercially available organometallics

Some Grignard and organolithium reagents are commercially available. Most chemists (unless they were working on a very large scale) would not usually make the simpler organolithiums or Grignard reagents by these methods, but would buy them in bottles from chemical companies (who, of course, do use these methods). The table lists some of the most important commercially available organolithiums and Grignard reagents.

methyl lithium (MeLi) in Et₂O or DME

***n*-butyllithium** (*n*-BuLi or just BuLi)



in cyclohexane or hexanes

sec-butyllithium (*sec*-BuLi or *s*-BuLi) in pentane or cyclohexane

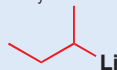

tert-butyllithium (*tert*-BuLi or *t*-BuLi) in pentane



phenyllithium (PhLi) in (*n*-Bu)₂O

methylmagnesium chloride, bromide, and iodide (MeMgX) in Et₂O, or THF

ethylmagnesium bromide (EtMgBr)

butylmagnesium chloride (BuMgCl) in Et₂O or THF

allylmagnesium chloride and bromide



phenylmagnesium chloride and bromide (PhMgCl or PhMgBr) in Et₂O or THF

Organometallics as bases

Organometallics need to be kept absolutely free of moisture—even moisture in the air will destroy them. The reason is that they react very rapidly and highly exothermically with water to produce alkanes. Anything that can protonate them will do the same thing. The organometallic reagent is a strong base, and is protonated to form its conjugate acid—methane or benzene in these cases. The pK_a of methane (Chapter 8) is somewhere around 50: it isn't an acid at all and essentially nothing will remove a proton from methane.



The equilibria lie vastly to the right: methane and Li⁺ are much more stable than MeLi while benzene and Mg²⁺ are much more stable than PhMgBr. Some of the most important uses of organolithiums—butyllithium, in particular—are as bases and, because they are so strong, they will deprotonate almost anything. That makes them very useful as reagents for making *other* organolithiums.



Making organometallics by deprotonating alkynes

In Chapter 8 (p. 175) we talked about how hybridization affects acidity. Alkynes, with their C–H bonds formed from sp orbitals, are the most acidic of hydrocarbons, with pK_a s of about 25.

They can be deprotonated by more basic organometallics such as butyllithium or ethylmagnesium bromide. Alkynes are sufficiently acidic to be deprotonated even by nitrogen bases and you saw on p. 171 that a common way of deprotonating alkynes is to use NaNH_2 (sodium amide), obtained by reacting sodium with liquid ammonia. An example of each is shown here. Propyne and acetylene are gases, and can be bubbled through a solution of the base.

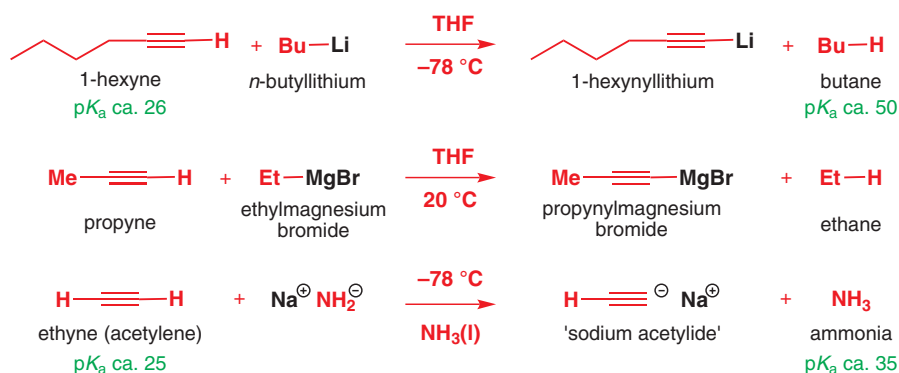

■ We have chosen to represent the alkynyl lithium and alkynyl magnesium halides as organometallics and the alkynyl sodium as an ionic salt. Both probably have some covalent character but lithium is less electropositive than sodium so alkynyl lithiums are more covalent and usually used in non-polar solvents while the sodium derivatives are more ionic and usually used in polar solvents.

The metal derivatives of alkynes can be added to carbonyl electrophiles, as in the following examples. The first (we have reminded you of the mechanism for this) is the initial step of an important synthesis of the antibiotic erythronolide A, and the second is the penultimate step of a synthesis of the widespread natural product farnesol.

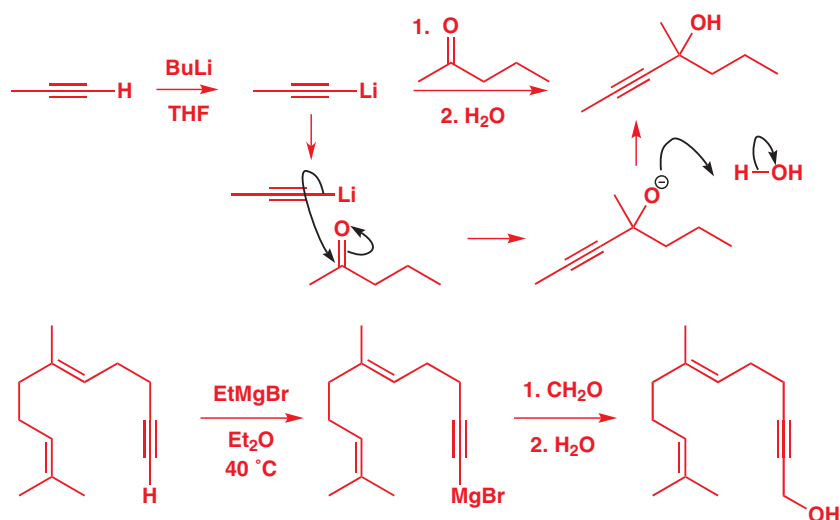

Ethnyloestradiol

The ovulation-inhibiting component of almost all oral contraceptive pills is a compound known as ethnyloestradiol, and this compound too is made by an alkynyllithium addition to the female sex hormone oestrone. A range of similar synthetic analogues of hormones containing an ethynyl unit are used in contraceptives and in treatments for disorders of the hormonal system.

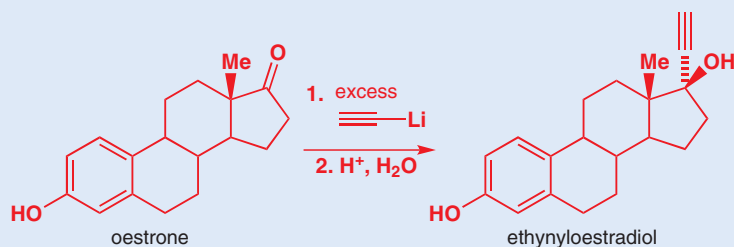

Triple bonds: stability and acidity

You have now met all the more important compounds with triple bonds. They all have electrons in low-energy sp hybrid orbitals (shown in green on the diagrams below), a feature which gives them stability or even unreactivity. Remember, an sp orbital has 50% s character, so electrons in this orbital are on average closer to the nucleus, and therefore more stable, than electrons in an sp^2 or sp^3 orbital.

Nitrogen, N_2 , has sp orbitals at both ends and is almost inert. It is neither basic nor nucleophilic and a major achievement of life is the 'fixing' (trapping in reductive chemical reactions) of nitrogen by bacteria such as those in the roots of leguminous plants (peas and beans). HCN has an sp orbital on nitrogen and a C–H σ bond at the other end. The nitrogen's sp lone pair is not at all basic, but HCN is quite acidic with a pK_a of 10 because the negative charge in the conjugate base (CN^-) is in an sp orbital. Nitriles have similar bonds and they are non-nucleophilic and non-basic. Finally, we have just met alkynes, which are among the most acidic of hydrocarbons, again because of the stability of an anion with its charge in an sp orbital.

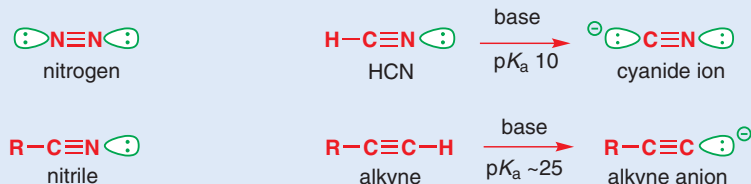

Halogen–metal exchange

Deprotonation is not the only way to use one simple organometallic reagent to generate another more useful one. Organolithiums can also remove halogen atoms from alkyl and aryl halides in a reaction known as halogen–metal exchange.

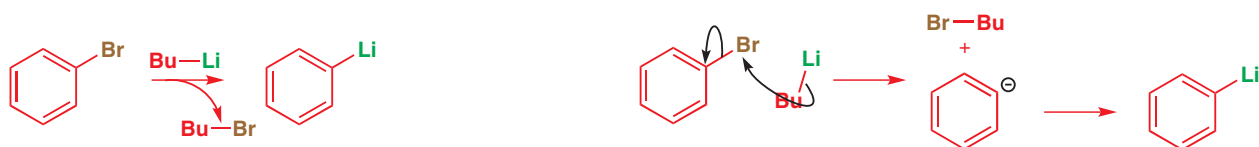

The bromine and the lithium simply swap places. As with many of these organometallic processes, the mechanism is not altogether clear, but can be represented as a nucleophilic attack on bromine by the butyllithium. But why does the reaction work? The product of our 'mechanism' is not PhLi and BuBr but a phenyl anion and a lithium cation. These could obviously combine to give PhLi and BuBr. But is this a reasonable interpretation and why does the reaction go that way and not the other? The key, again, is pK_a . We can think of the organolithiums as a complex between Li^+ and a carbanion.



■ The reason for this is again that the anion lies in an sp^2 orbital rather than an sp^3 orbital. See Chapter 8, p. 175.

The lithium cation is the same in all cases: only the carbanion varies. So the stability of the complex depends on the stability of the carbanion ligand. Benzene, (pK_a about 43) is more acidic than butane (pK_a about 50) so the phenyl complex is more stable than the butyl complex and the reaction is a way to make PhLi from available BuLi. Vinylolithiums (the lithium must be bonded directly to the alkene) can also be made this way and a R_2N- substituent is acceptable. Bromides or iodides react faster than chlorides.

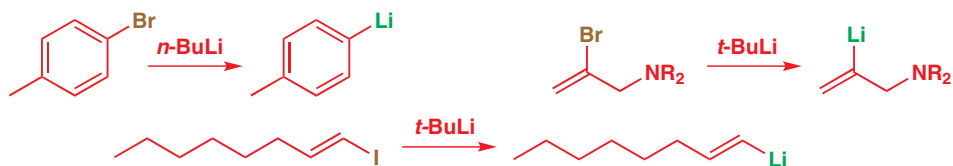

Halogen–metal exchange tolls the knell of one appealing way to make carbon–carbon bonds. It may already have occurred to you that we might make a Grignard or organolithium reagent and combine it with another alkyl halide to make a new carbon–carbon σ bond.



This reaction does not work because of transmetalation. The two alkyl bromides and their Grignard reagents will be in equilibrium with each other so that, even if the coupling were successful, three coupled products will be formed.



You will see later that transition metals are needed for this sort of reaction. The only successful reactions of this kind are couplings between metal derivatives of alkynes and alkyl halides. These do not exchange the metal as the alkynyl metal is much more stable than the alkyl metal.

A good example is the synthesis of a substituted alkyne starting from acetylene (ethyne) itself. One alkylation uses NaNH_2 as the base to make sodium acetylide and the other uses BuLi to make a lithium acetylide.

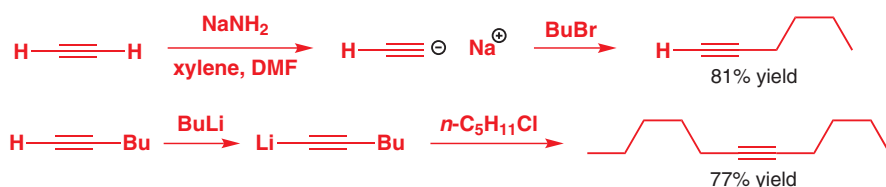

Transmetalation

Organolithiums can be converted to other types of organometallic reagents by transmetalation—simply treating with the salt of a less electropositive metal. The more electropositive Mg or Li goes into solution as an ionic salt, while the less electropositive metal such as Zn takes over the alkyl group.

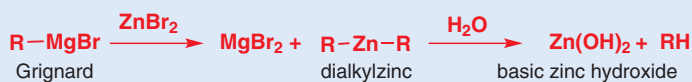

But why bother? Well, the high reactivity—and in particular the basicity—of Grignard reagents and organolithiums sometimes causes unwanted side reactions. Their combination with very strong electrophiles like acid chlorides usually results in a violent uncontrolled reaction. If a much less reactive organozinc compound is used instead, the reaction is more under control. These organozinc compounds can be made from either Grignard reagents or organolithium compounds. E. Negishi, a pioneer of organozinc chemistry, got the Nobel Prize for Chemistry in 2010 with R. F. Heck and A. Suzuki for their work on organometallic compounds.

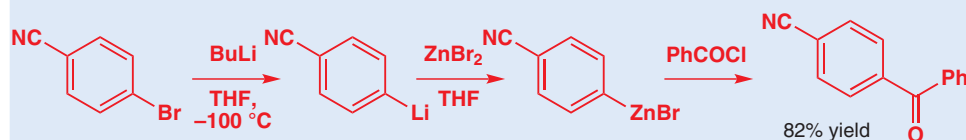

Using organometallics to make organic molecules

Now that you have met all of the most important ways of making organometallics (summarized here as a reminder), we shall move on to consider how to use them to make molecules:

what sorts of electrophiles do they react with and what sorts of products can we expect to get from their reactions? Having told you how you can make other organometallics, we shall really be concerned for the rest of this chapter only with Grignard reagents and organolithiums. In nearly all of the cases we shall talk about, the two classes of organometallics can be used interchangeably.

• Ways of making organometallics

- Oxidative insertion of Mg into alkyl halides

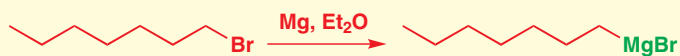

- Oxidative insertion of Li into alkyl halides



- Deprotonation of alkynes

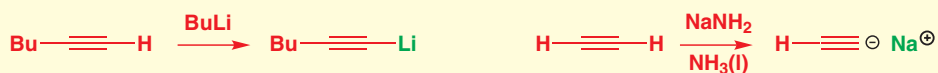

- Halogen-metal exchange

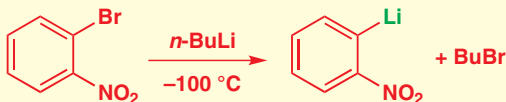

- Transmetalation

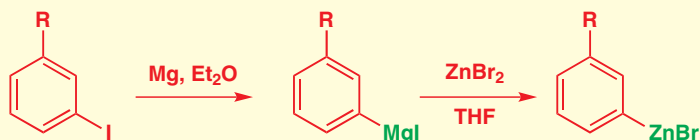

Making carboxylic acids from organometallics and carbon dioxide

Carbon dioxide reacts with organolithiums and Grignard reagents to give carboxylate salts. Protonating the salt with acid gives a carboxylic acid with one more carbon than the starting organometallic. The reaction is usually done by adding solid CO_2 to a solution of the organolithium in THF or ether, but it can also be done using a stream of dry CO_2 gas.

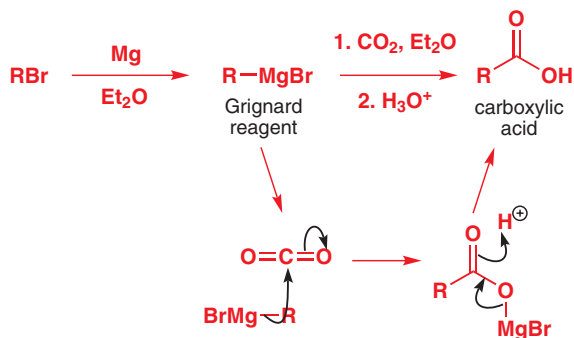

The example below shows the three stages of the reaction: (1) forming the organometallic, (2) reaction with the electrophile (CO_2), and (3) the acidic work-up or quench, which protonates the product and destroys any unreacted organometallic. The three stages of

the reaction have to be monitored carefully to make sure that each is finished before the next is begun. In particular it is absolutely essential that there is no water present during either of the first two stages—water must be added only at the end of the reaction, *after* the organometallic has all been consumed by reaction with the electrophile. You may occasionally see schemes written out without the quenching step included, but it is nonetheless always needed.

carboxylic acids from organometallics

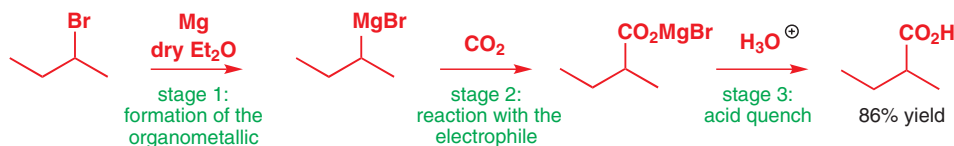

This next example shows that even very hindered chlorides can be used successfully. The significance of this will be clearer when you reach Chapter 15.

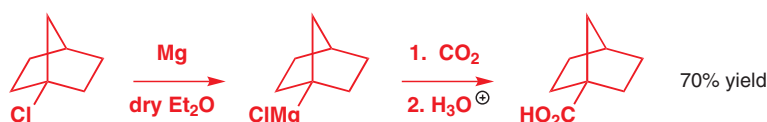

Making primary alcohols from organometallics and formaldehyde

You met formaldehyde, the simplest aldehyde, in Chapter 6, where we discussed the difficulties of using it in anhydrous reactions: it is either hydrated or a polymer paraformaldehyde, $(\text{CH}_2\text{O})_n$, and in order to get pure, dry formaldehyde it is necessary to heat ('crack') the polymer to decompose it. But formaldehyde is a remarkably useful reagent for making primary alcohols, in other words alcohols that have just one carbon substituent on the hydroxy-bearing C atom. Just as carbon dioxide adds one carbon and makes an acid, formaldehyde adds one carbon and makes an alcohol.

a primary alcohol from formaldehyde

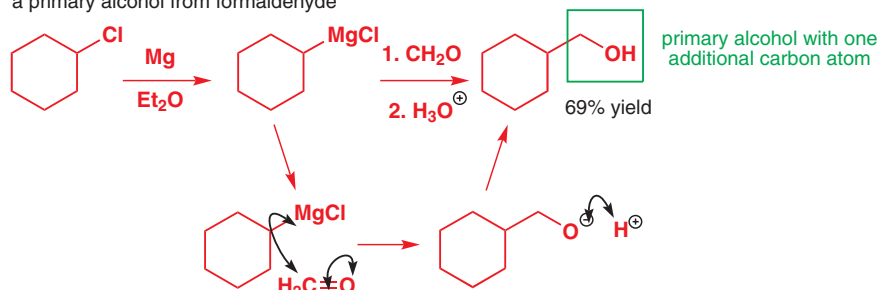

In the next two examples, formaldehyde makes a primary alcohol from two deprotonated alkynes. The second reaction here (for which we have shown organolithium formation, reaction, and quench simply as a series of three consecutive reagents) forms one of the last steps of the synthesis of *Cecropia* juvenile hormone, whose structure you met right at the beginning of the chapter.

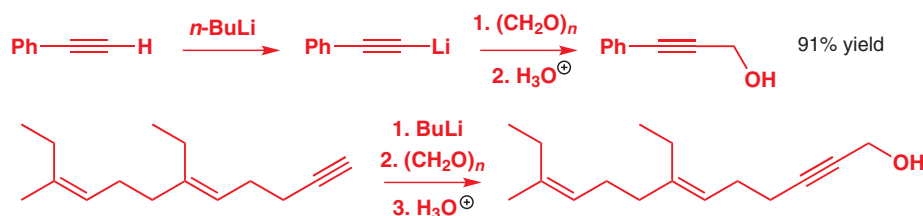

● **Something to bear in mind with all organometallic additions to carbonyl compounds is that the addition takes the oxidation level down one (oxidation levels were described in Chapter 2, p. 33). In other words, if you start with an aldehyde, you end up with an alcohol. More specifically,**

- additions to CO_2 give carboxylic acids

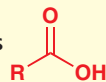

- additions to formaldehyde (CH_2O) give primary alcohols

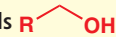

- additions to other aldehydes (RCHO) give secondary alcohols

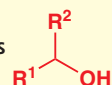

- additions to ketones give tertiary alcohols

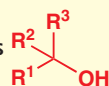

Secondary and tertiary alcohols: which organometallic, which aldehyde, which ketone?

Aldehydes and ketones react with organometallic reagents to form secondary and tertiary alcohols, respectively, and some examples are shown with the general schemes here.

secondary alcohols from aldehydes

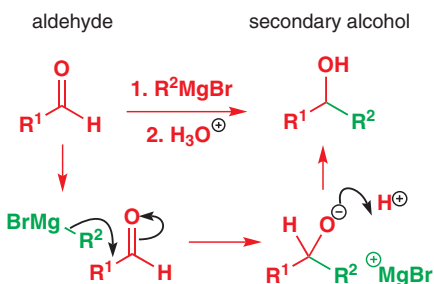

tertiary alcohols from ketones

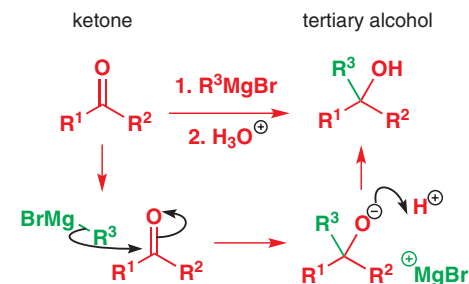

two examples of each:

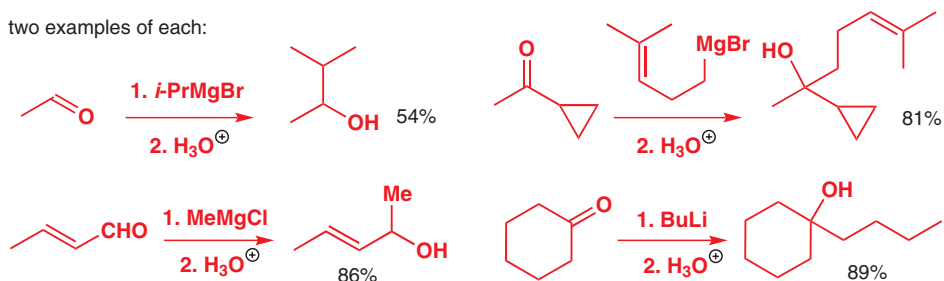

Fenarimol

Fenarimol is a fungicide that works by inhibiting the fungus's biosynthesis of important steroid molecules. It is made by reaction of a diarylketone with an organolithium derived by halogen–metal exchange.

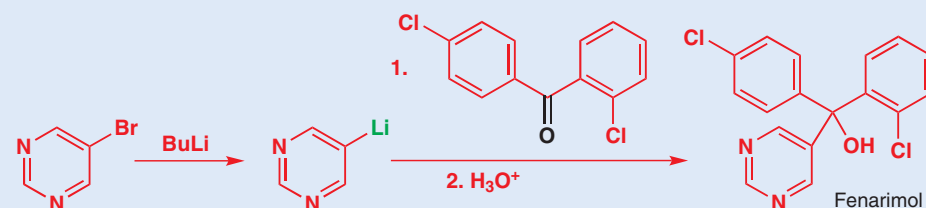

To make any secondary alcohol, however, there may be a choice of two possible routes, depending on which part of the molecule you choose to make the organometallic and which part you choose to make the aldehyde. For example, the first example here shows the synthesis of a secondary alcohol from isopropylmagnesium chloride and acetaldehyde. But it is

equally possible to make this same secondary alcohol from isobutyraldehyde and methyl-lithium or a methylmagnesium halide.

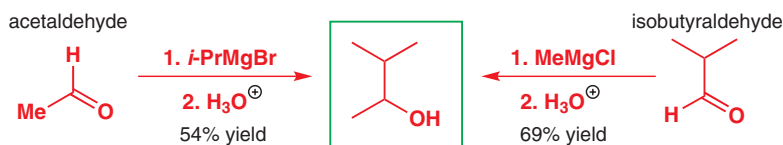

Indeed, back in 1912, when this alcohol was first described in detail, the chemists who made it chose to start with acetaldehyde, while in 1983, when it was needed as a starting material for a synthesis, it was made from isobutyraldehyde. Which way is better? The 1983 chemists probably chose the isobutyraldehyde route because it gave a better yield. But, if you were making a secondary alcohol for the first time, you might just have to try both in the laboratory and see which one gave a better yield.

Or you might be more concerned about which uses the cheaper, or more readily available, starting materials—this was probably also a factor in the choice of methylmagnesium chloride and the unsaturated aldehyde in the second example. Both can be bought commercially, while the alternative route to this secondary alcohol would require a vinyl lithium or vinylmagnesium bromide reagent that would have to be made from a vinyl halide, which is itself not commercially available, along with difficult-to-dry acetaldehyde.

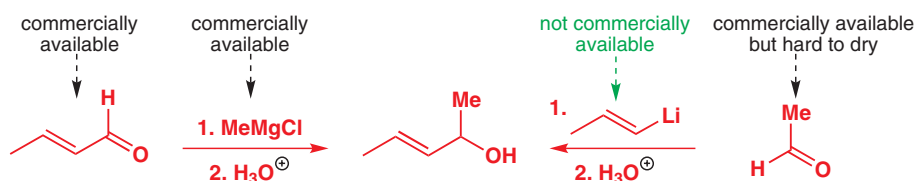

There is another choice for secondary alcohols: the reduction of a ketone. The ketone reacts with sodium borohydride to give a secondary alcohol. An obvious case where this would be a good route is the synthesis of a cyclic alcohol. This bicyclic ketone gives the secondary alcohol in good yield, and in the second example a diketone has both its carbonyl groups reduced.



Flexibility in the synthesis of alcohols

As an illustration of the flexibility available in making secondary alcohols, one synthesis of bongkreic acid, a highly toxic compound that inhibits transport across certain membranes in the cell, requires both of these (very similar) alcohols. The chemists making the compound at Harvard University chose to make each alcohol from quite different starting materials: an unsaturated aldehyde and an alkyne-containing organolithium in the first instance, and an alkyne-containing aldehyde and vinyl magnesium bromide in the second.

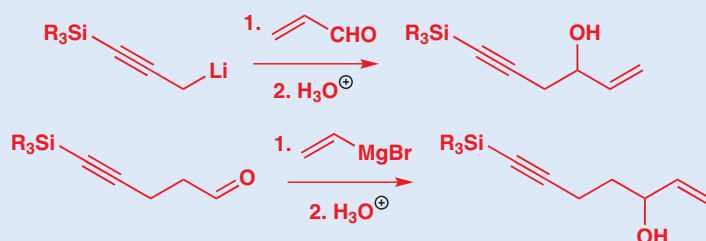

With tertiary alcohols, there is even more choice. The example below is a step in a synthesis of the natural product, nerolidol. But the chemists in Paris who made this tertiary alcohol

could in principle have chosen any of three routes. Note that we have dropped the aqueous quench step from these schemes to avoid cluttering them.

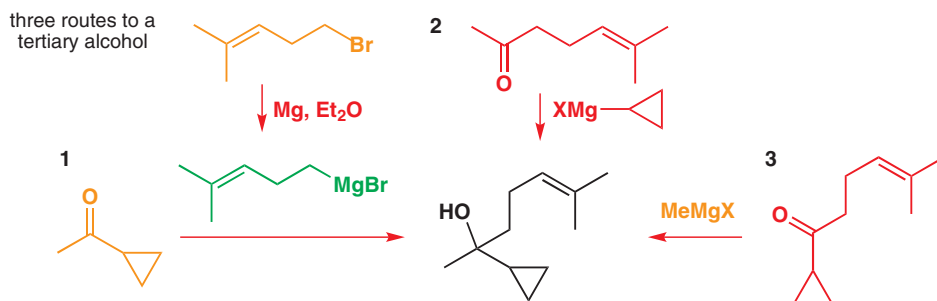

Only the reagents in orange are commercially available, but, as it happens, the green Grignard reagent can be made from an alkyl bromide, which is itself commercially available, making route 1 on the left the most reasonable.

Now, do not be dismayed! We are not expecting you to remember a chemical catalogue and to know which compounds you can buy and which you can't. All we want you to appreciate at this stage is that there are usually two or three ways of making any given secondary or tertiary alcohol, and you should be able to suggest alternative combinations of aldehyde or ketone and Grignard or organolithium reagent that will give the same product. You are not expected to be able to assess the relative merits of the different possible routes to a compound. That is a topic we leave for a much later chapter on retrosynthetic analysis, Chapter 28.

Oxidation of alcohols

So far the metals we have used have had one oxidation state other than zero: Li(I), Mg(II), and Zn(II). If we want to oxidize organic compounds we need metals that have at least two higher oxidation states and that means transition metals. The most important by far is chromium, with Cr(III) and Cr(VI) as the useful oxidation states. Orange Cr(VI) compounds are good oxidizing agents: they remove hydrogen from organic compounds and are themselves reduced to green Cr(III). There are many Cr(VI) reagents used in organic chemistry, some of the more important ones are related to the polymeric oxide CrO_3 . This is the anhydride of chromic acid and water breaks up the polymer to give a solution of chromic acid. Pyridine also breaks up the polymer to give a complex. This (Collins' reagent) was used to oxidize organic compounds but it is rather unstable and pyridinium dichromate (PDC) and pyridinium chlorochromate (PCC) are usually now preferred, especially as they are soluble in organic solvents such as CH_2Cl_2 .

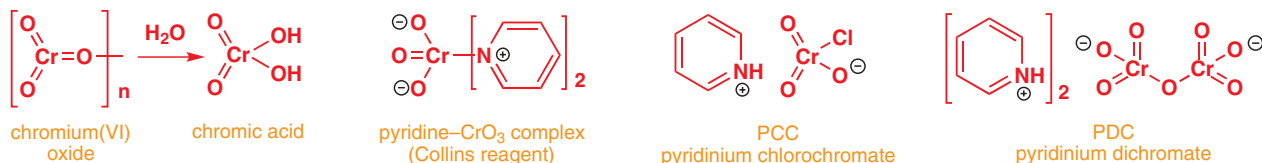

Oxidation by these reagents of the various primary and secondary alcohols we have been making in this chapter takes us to a higher oxidation level. Oxidation of primary alcohols gives aldehydes and then carboxylic acids, while oxidation of secondary alcohols gives ketones. Note that you can't oxidize tertiary alcohols (without breaking a C–C bond).

■ The symbol [O] means an unspecified oxidizing agent.

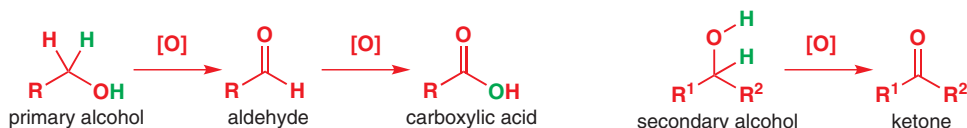

You will notice that the oxidation steps involve the removal of two hydrogen atoms and/or the addition of one oxygen atom. In Chapter 6 you saw that reduction meant the addition of hydrogen (and can also mean the removal of oxygen). Hiding behind these observations is the more fundamental idea that reduction requires the addition of electrons while oxidation requires the removal of electrons. If we used basic reagents, we could remove the OH proton from a primary alcohol, but to get the aldehyde we should have to remove a C–H proton as well *with a pair of electrons*. We should have to expel a hydride ion H^- and this doesn't happen. So we need some reagent that can remove a hydrogen atom *and a pair of electrons*. That defines an oxidizing agent.

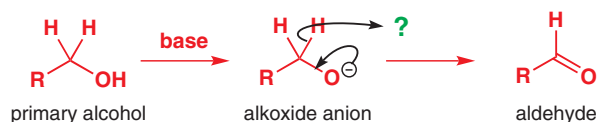

Here Cr(VI) can remove electrons to make Cr(III). It does so by a cyclic mechanism on a Cr(VI) ester. One hydrogen atom is removed (from the OH group) to make the ester and the second is removed (from carbon) in the cyclic mechanism. Notice how the arrows stop on the Cr atom and start again on the Cr=O bond, so two electrons are added to the chromium. This actually makes Cr(IV), an unstable oxidation state, but this gives green Cr(III) by further reactions.

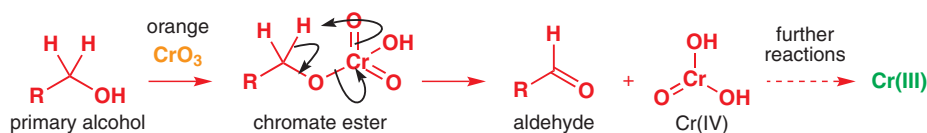

Interactive mechanism for chromium (VI) oxidation of alcohols

Two examples of the use of PCC in these oxidations come from Vogel. Hexanol is oxidized to hexanal in dichloromethane solution and commercial carveol (an impure natural product) to pure carvone with PCC supported on alumina in hexane solution. In both cases the pure aldehyde or ketone was isolated by distillation.

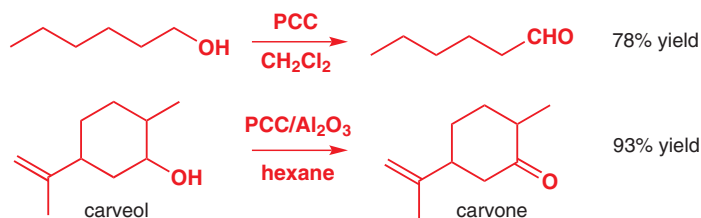

But a word of warning: stronger oxidizing agents like calcium hypochlorite or sodium hypochlorite (bleach) may oxidize primary alcohols all the way to carboxylic acids, especially in water. This is the case with *p*-chloro benzyl alcohol and the solid acid is easily isolated by the type of acid/base extraction we met in the previous chapter.

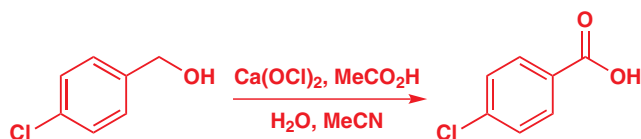

You will find further discussion of oxidizing agents in later chapters of the book. We have introduced them here so that you can see how primary and secondary alcohols, made by addition of organometallic reagents, can be oxidized to aldehydes or ketones so that the process can be repeated. A secondary alcohol, which could be made in two ways, can be oxidized with the pyridine–CrO₃ complex to the ketone and reacted with any Grignard or organolithium compound to give a range of tertiary alcohols.

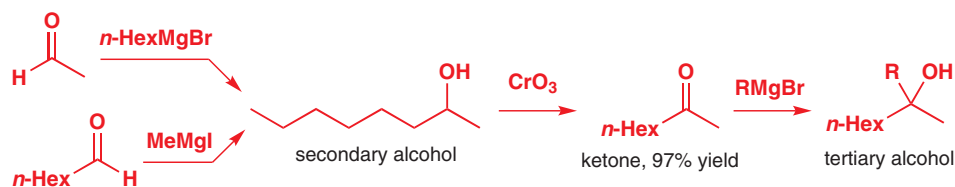

Looking forward

In this chapter we have covered interconversions between ketones, aldehydes, and alcohols by forming C–C bonds using organometallics. We looked at oxidation and reduction as ways of complementing these methods—you should now be able to suggest at least one way of making any primary, secondary, or tertiary alcohol from simple precursors. In the next two chapters we will broaden our horizons beyond aldehydes and ketones to look at the reactivity of other carbonyl compounds—carboxylic acids and their derivatives such as esters and amides—and other nucleophiles. But the idea that we study organic reactions not only for their own sake but also so we can use them to make things should stay with you. We will come back to how to design ways of making molecules in Chapter 28. Many of these methods will employ the organometallics you have just met. We will then devote Chapter 40 to a broader range of more complex organometallic methods.

Further reading

For more on the detailed structures of Grignard reagents, see P. G. Williard in *Comprehensive Organic Synthesis*, vol. 1, 1999, p. 1. The alkylation of alkynes is described by P. J. Garratt in *Comprehensive Organic Synthesis*, vol. 1, 3rd edn, 1999, p. 271. The examples come from T. F. Rutledge, *J. Org. Chem.*, 1959, **24**, 840, D. N. Brattesoni and C. H. Heathcock, *Synth. Commun.* 1973, **3**, 245, R. Giovannini and P. Knochel, *J. Am. Chem. Soc.*, 1998, **120**, 11186, C. E. Tucker, T. N. Majid, and P. Knochel, *J. Am. Chem. Soc.*, 1992, **114**, 3983. For a rather advanced review of organozinc compounds, see P. Knochel, J. J. Almerna Perea, and P. Jones, *Tetrahedron*, 1998, **54**, 8275.

Discovery of pyridinium chlorochromate (PCC): G. Piancatelli, A. Scettri, and M. D'Auria, *Synthesis*, 1982, 245; H. S. Kasmai, S. G. Mischke, and T. J. Blake, *J. Org. Chem.*, 1995, **60**, 2267 and PDC: E. J. Corey and J. W. Suggs, *Tetrahedron Lett.*, 1975, 2647. Details of oxidation experiments: B. S. Furniss, A. J. Hannaford, P. W. G. Smith, and A. R. Tatchell, *Vogel's Textbook of Practical Organic Chemistry*, 5th edn, Longman, Harlow, 1989, pp. 590 and 610; J. C. Gilbert and S. F. Martin, *Experimental Organic Chemistry*, Harcourt, Fort Worth, 2002, p. 507.

Check your understanding



To check that you have mastered the concepts presented in this chapter, attempt the problems that are available in the book's Online Resource Centre at <http://www.oxfordtextbooks.co.uk/orc/clayden2e/>

Nucleophilic substitution at the carbonyl group

10

Connections

➔ Building on

Drawing mechanisms [ch5](#)

Nucleophilic attack on carbonyl groups
[ch6 & ch9](#)

- Acidity and pK_a [ch8](#)

Grignard and RLi addition to C=O groups [ch9](#)

Arriving at

- Nucleophilic attack followed by loss of leaving group
- What makes a good nucleophile
- What makes a good leaving group
- There is always a tetrahedral intermediate
- How to make acid derivatives
- Reactivity of acid derivatives
- How to make ketones from acids
- How to reduce acids to alcohols

➔ Looking forward to

- Loss of carbonyl oxygen [ch11](#)
- Kinetics and mechanism [ch12](#)
- Reactions of enols [ch20](#), [ch25](#), & [ch26](#)
- Chemoselectivity [ch23](#)

You are already familiar with reactions of compounds containing carbonyl groups. Aldehydes and ketones react with nucleophiles at the carbon atom of their carbonyl group to give products containing hydroxyl groups. Because the carbonyl group is such a good electrophile, it reacts with a wide range of different nucleophiles: you have met reactions of aldehydes and ketones with (in Chapter 6) cyanide, water, and alcohols, and (in Chapter 9) organometallic reagents (organolithiums and organomagnesiums, or Grignard reagents).

In this chapter and Chapter 11 we shall look at some more reactions of the carbonyl group—and revisit some of the ones we touched on in Chapter 6. It is a tribute to the importance of this functional group for organic chemistry that we have devoted four chapters of this book to its reactions. Just like the reactions in Chapters 6 and 9, the reactions in Chapters 10 and 11 all involve attack of a nucleophile on a carbonyl group. The difference is that this step is followed by other mechanistic steps, which means that the overall reactions are not just *additions* but also *substitutions*.

The product of nucleophilic addition to a carbonyl group is not always a stable compound

Addition of a Grignard reagent to an aldehyde or ketone gives a stable alkoxide, which can be protonated with acid to produce an alcohol (you met this reaction in Chapter 9). The same is not true for addition of an alcohol to a carbonyl group in the presence of base—in Chapter 6 we drew a reversible, equilibrium arrow for this transformation and said that the product, a hemiacetal, is formed to a significant extent only if it is cyclic.

The reason for this instability is that RO^- is easily expelled from the molecule. We call groups that can be expelled from molecules, usually taking with them a negative charge, **leaving groups**. We'll look at leaving groups in more detail later in this chapter and again in Chapter 15.

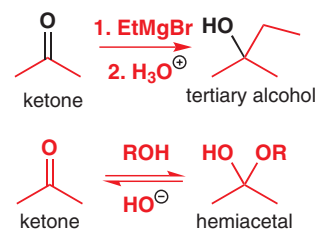

Online support. The icon  in the margin indicates that accompanying interactive resources are provided online to help your understanding: just type www.chemtube3d.com/clayden/123 into your browser, replacing **123** with the number of the page where you see the icon. For pages linking to more than one resource, type **123-1**, **123-2** etc. (replacing **123** with the page number) for access to successive links.

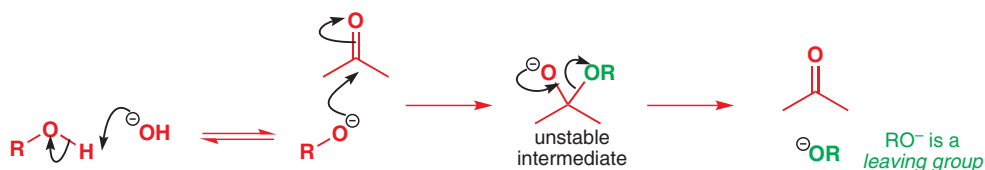

• Leaving groups

Leaving groups are anions such as Cl^- , RO^- , and RCO_2^- that can be expelled from molecules taking their negative charge with them.

So, if the nucleophile is also a leaving group, there is a chance that it will be lost again and that the carbonyl group will reform—in other words, the reaction will be reversible. The energy released in forming the $\text{C}=\text{O}$ bond (bond strength 720 kJ mol^{-1}) makes up for the loss of two $\text{C}-\text{O}$ single bonds (about 350 kJ mol^{-1} each), one of the reasons for the instability of the hemiacetal product in this case.

The same thing can happen if the starting carbonyl compound contains a potential leaving group. The unstable negatively charged intermediate in the red box below is formed when a Grignard reagent is added to an ester.

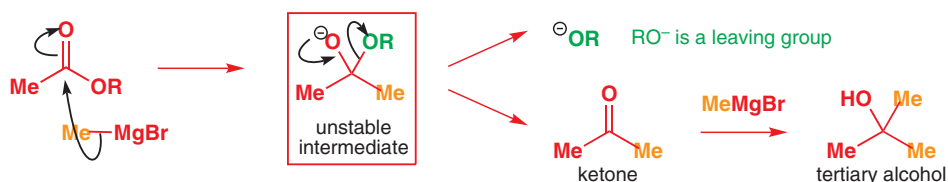

Again, it collapses with loss of RO^- as a leaving group. This time, though, we have not gone back to starting materials: instead we have made a new compound (a ketone) by a **substitution reaction**—the OR group of the starting material has been substituted by the Me group of the product. In fact the ketone product can react with the Grignard reagent a second time to give a tertiary alcohol. Later in this chapter we'll discuss why the reaction doesn't stop at the ketone.

Carboxylic acid derivatives

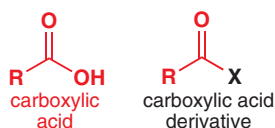

Most of the starting materials for, and products of, these substitutions will be carboxylic acid derivatives, with the general formula RCOX . You met the most important members of this class in Chapter 2: here they are again as a reminder.

Carboxylic acid derivatives

Carboxylic acid	Derivative of RCO_2H			
	acid chloride or acyl chloride*	ester	acid anhydride	amide

*We shall use these two terms interchangeably.

■ The reactions of alcohols with acid chlorides and with acid anhydrides are the most important ways of making esters, but not the only ways. We shall see later how carboxylic acids can be made to react directly with alcohols.

Acid chlorides and acid anhydrides react with alcohols to make esters

Acetyl chloride will react with an alcohol in the presence of a base to give an acetate ester and we get the same product if we use acetic anhydride.

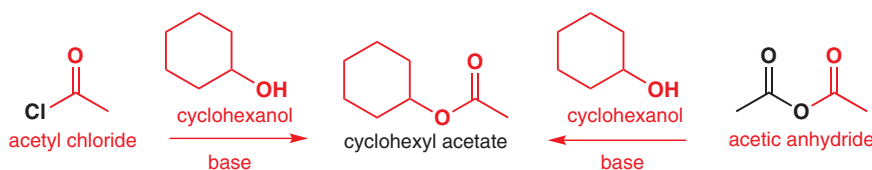

In each case, a substitution (of the black part of the molecule, Cl^- or AcO^- , by cyclohexanol) has taken place—but how? It is important that you learn not only the *fact* that acyl chlorides and acid anhydrides react with alcohols but also the *mechanism* of the reaction. In this chapter you will meet a lot of reactions, but relatively few mechanisms—once you understand one, you should find that the rest follow on quite logically.

The first step of the reaction is, as you might expect, addition of the nucleophilic alcohol to the electrophilic carbonyl group—we'll take the acyl chloride first. The base is important because it removes the proton from the alcohol once it attacks the carbonyl group. A base commonly used for this is pyridine. If the electrophile had been an aldehyde or a ketone, we would have got an unstable hemiacetal, which would collapse back to starting materials by eliminating the alcohol. With an acyl chloride, the alkoxide intermediate we get is also unstable. It collapses again by an elimination reaction, this time losing chloride ion, to form the ester. Chloride is the *leaving group* here—it leaves with its negative charge.

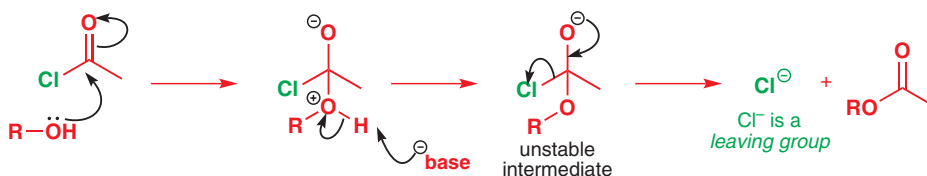

With this reaction as a model, you should be able to work out the mechanism of ester formation from acetic anhydride and an alcohol. Try to write it down without looking at the acyl chloride mechanism above, and certainly not at the answer below. Here it is, with pyridine as the base. Again, addition of the nucleophile gives an unstable intermediate, which undergoes an elimination reaction, this time losing a carboxylate anion to give an ester.

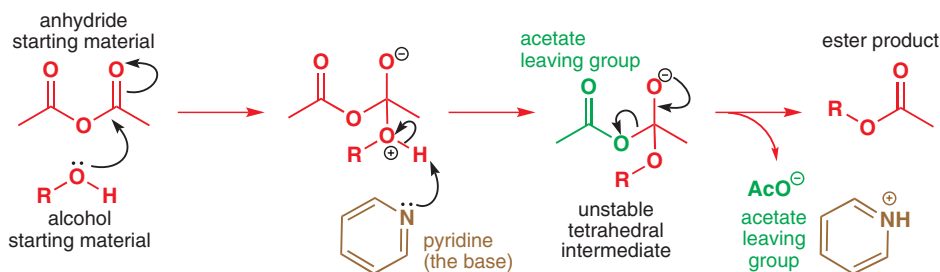

We call the unstable intermediate formed in these reactions the **tetrahedral intermediate** because the trigonal (sp^2) carbon atom of the carbonyl group has become a tetrahedral (sp^3) carbon atom.

● Tetrahedral intermediates

Substitutions at trigonal carbonyl groups go through a tetrahedral intermediate and then on to a trigonal product.

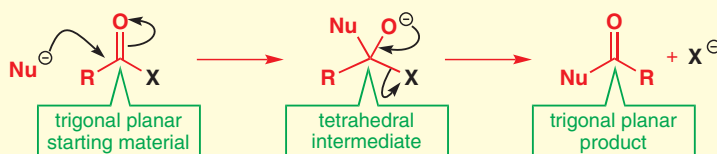

Remember the symbol for acetyl? $\text{Ac}=\text{CH}_3\text{CO}$. You can represent the acetate of an alcohol ROH as ROAc but not as RAc as this would be a ketone.

You will notice that the terms 'acid chloride' and 'acyl chloride' are used interchangeably.

More details of this reaction

Acylation with acyl chlorides in the presence of pyridine has more subtleties than first meet the eye. If you are reading this chapter for the first time, you might skip this box, as it is not essential to the general flow of what we are saying. There are three more points to notice.

Pyridine is consumed during both of these reactions, since it ends up protonated. One whole equivalent of pyridine is therefore necessary and, in fact, the reactions are often carried out with pyridine as solvent.

The observant among you may also have noticed that the (weak—pyridine) base catalyst in this reaction works very slightly differently from the (strong—hydroxide) base catalyst in the hemiacetal-forming reaction on p. 197: pyridine removes the proton *after* the nucleophile has added; hydroxide removes the proton *before* the nucleophile has added. This is deliberate, and will be discussed further in Chapters 12 and 40. The basicities of pyridine (pK_a for protonation 5.5) and hydroxide (pK_a of water 15.7) were discussed in Chapter 8.

Pyridine is, in fact, more nucleophilic than the alcohol, and it attacks the acyl chloride rapidly, forming a highly electrophilic (because of the positive charge) intermediate. It is then this intermediate that subsequently reacts with the alcohol to give the ester. Because pyridine is acting as a nucleophile to speed up the reaction, yet is unchanged by the reaction, it is called a **nucleophilic catalyst**.

nucleophilic catalysis in ester formation

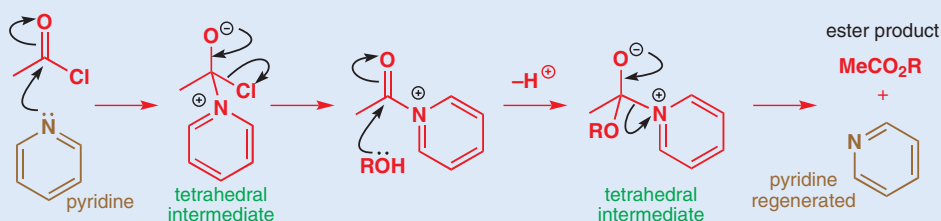

Interactive mechanism for pyridine nucleophilic catalysis

Why are the tetrahedral intermediates unstable?

The alkoxide formed by addition of a Grignard reagent to an aldehyde or ketone is stable, lasting long enough to be protonated on work-up in acid to give an alcohol as product.

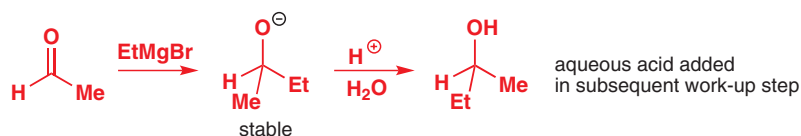

Tetrahedral intermediates are similarly formed by addition of a nucleophile, say ethanol, to the carbonyl group of acetyl chloride, but these tetrahedral intermediates are unstable. Why are they *unstable*? The answer is to do with leaving group ability. Once the nucleophile has added to the carbonyl compound, the stability of the product (or tetrahedral intermediate) depends on how good the groups attached to the new tetrahedral carbon atom are at leaving with the negative charge. In order for the tetrahedral intermediate to collapse (and therefore be just an intermediate and not the final product) one of the groups has to be able to leave and carry off the negative charge from the alkoxide anion formed in the addition.



The most stable anion will be the best leaving group. There were three choices for the leaving group: Cl^- , EtO^- , or Me^- . We can make MeLi but not Me^- because it is very unstable so Me^- must be a very bad leaving group. EtO^- is not so bad—alkoxide salts are stable, but they are still strong, reactive bases. But Cl^- is the best leaving group: Cl^- ions are perfectly stable and quite unreactive, and happily carry off the negative charge from the oxygen atom.

You probably eat several grams of Cl^- every day but you would be unwise to eat EtO^- or MeLi . So neither of these reactions occurs:



How do we know that the tetrahedral intermediate exists?

We don't expect you to be satisfied with the bland statement that tetrahedral intermediates are formed in these reactions: of course, you wonder how we know that this is true. The first evidence for tetrahedral intermediates in the substitution reactions of carboxylic acid derivatives was provided by Bender in 1951. He made carboxylic acid derivatives RCOX that had been 'labelled' with an isotope of oxygen, ^{18}O . This is a non-radioactive isotope that is detected by mass spectrometry. He then reacted these derivatives with water to make labelled carboxylic acids. By any reasonable mechanism, the products would have one ^{18}O atom from the labelled starting material. Because the proton on a carboxylic acid migrates rapidly from one oxygen to another, both oxygens are labelled equally.

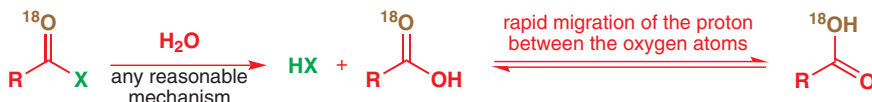

■ In Bender's original work, X was an alkoxy group (i.e. RCOX was an ester).

He then reacted these derivatives with insufficient water for complete consumption of the starting material. At the end of the reaction, he found that the proportion of labelled molecules in the *remaining starting material* had decreased significantly: in other words, it was no longer completely labelled with ^{18}O ; some contained 'normal' ^{16}O . The formation of the tetrahedral intermediate would be as before but rapid proton transfer would also mean that the two oxygen atoms would be the same. Now you may see the next step in the argument.

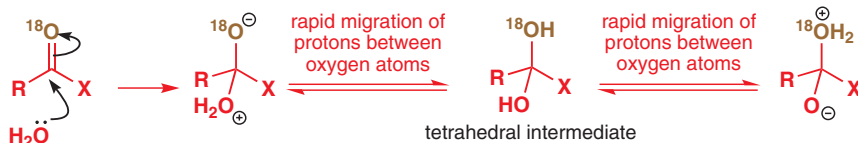

This result cannot be explained by direct substitution of X by H_2O , but is consistent with the existence of an intermediate in which the unlabelled ^{16}O and labelled ^{18}O can 'change places'. This intermediate is the *tetrahedral intermediate* for this reaction. Either isomer can lose X and in each case labelled carboxylic acid is formed.

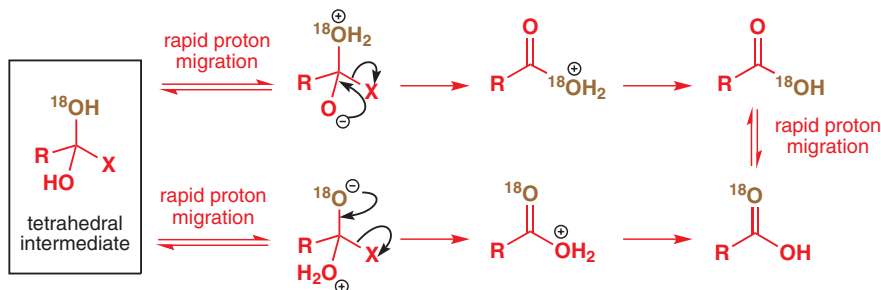

But either tetrahedral intermediate could lose water instead. In one case (top line below) the original starting material is regenerated complete with label. But in the second case, labelled water is lost and *unlabelled starting material is formed*. This result would be difficult to explain without a tetrahedral intermediate with a lifetime long enough to allow for proton exchange. This 'addition-elimination' mechanism is now universally accepted.

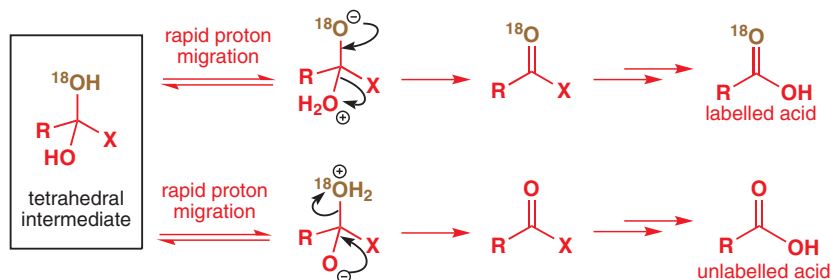

pK_a is a useful guide to leaving group ability

It's useful to be able to compare leaving group ability quantitatively. This is impossible to do exactly, but a good guide is the pK_a of the conjugate acid (Chapter 8). If X^- is the leaving group, the lower the pK_a of HX , the better X^- is as a leaving group. If we go back to the example of ester formation from acyl chloride plus alcohol, there's a choice of Me^- , EtO^- , and Cl^- . HCl is a stronger acid than EtOH , which is a much stronger acid than methane. So Cl^- is the best leaving group and EtO^- the next best. These observations apply only to reactions at the carbonyl group.

• Leaving group ability

The lower the pK_a of HX , the better the leaving group of X^- in carbonyl substitution reactions.

The most important substituents in carbonyl reactions are alkyl or aryl groups (R), amino groups in amides (NH_2), alkoxy groups in esters (RO^-), carboxylate groups (RCO_2^-) in anhydrides, and chloride (Cl^-) in acyl chlorides. The order of leaving group ability is then:

carboxylic acid derivative	leaving group, X^-	conjugate acid, HX	pK_a of HX	leaving group?
acyl chloride	Cl^-	HCl	<0	excellent
anhydride	RCOO^-	RCO_2H	about 5	good
ester	RO^-	ROH	about 15	poor
amide	NH_2^-	NH_3	about 25	very poor
alkyl or aryl derivative	R^-	RH	>40	not a leaving group

We can use pK_a to predict what happens if we react an acyl chloride with a carboxylate salt. We expect the carboxylate salt (here, sodium formate or sodium methanoate, HCO_2Na) to act as the nucleophile to form a tetrahedral intermediate, which could collapse in any one of three ways. We can straightaway rule out loss of Me^- and we might guess that Cl^- is a better leaving group than HCO_2^- as HCl is a much stronger acid than a carboxylic acid, and we'd be right. Sodium formate reacts with acetyl chloride to give a mixed anhydride.

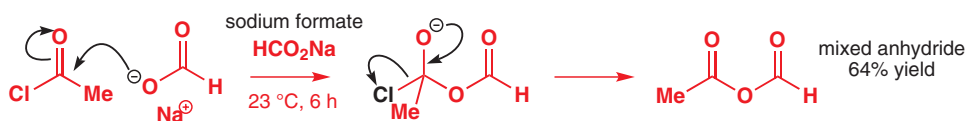

Amines react with acyl chlorides to give amides

Using the principles we've outlined above, you should be able to see how these compounds can be interconverted by substitution reactions with appropriate nucleophiles. We've seen that acid chlorides react with carboxylic acids to give acid anhydrides, and with alcohols to give esters. They also react with amines (such as ammonia) to give amides.

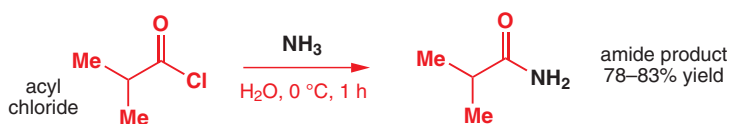

The mechanism is very similar to the mechanism of ester formation. Notice the second molecule of ammonia, which removes a proton, and the loss of chloride ion—the leaving group—to form the amide. Ammonium chloride is formed as a by-product in the reaction.

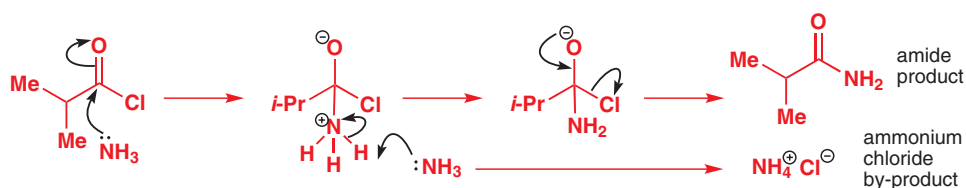

Interactive mechanism for amide formation

Here is another example, using a secondary amine, dimethylamine. Try writing down the mechanism now without looking at the one above. Again, two equivalents of dimethylamine are necessary, although the chemists who published this reaction added three for good measure.

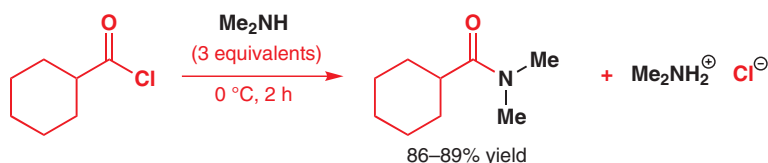

Schotten–Baumann synthesis of an amide

As these mechanisms show, the formation of amides from acid chlorides and amines is accompanied by production of one equivalent of HCl, which needs to be neutralized by a second equivalent of amine. An alternative method for making amides is to carry out the reaction in the presence of another base, such as NaOH, which then does the job of neutralizing the HCl. The trouble is, OH[−] also attacks acyl chlorides to give carboxylic acids. Schotten and Baumann, in the late nineteenth century, published a way round this problem by carrying out these reactions in two-phase systems of immiscible water and dichloromethane. The organic amine (not necessarily ammonia) and the acyl chloride remain in the (lower) dichloromethane layer, while the base (NaOH) remains in the (upper) aqueous layer. Dichloromethane and chloroform are two common organic solvents that are heavier (more dense) than water. The acyl chloride reacts only with the amine, but the HCl produced can dissolve in, and be neutralized by, the aqueous solution of NaOH.

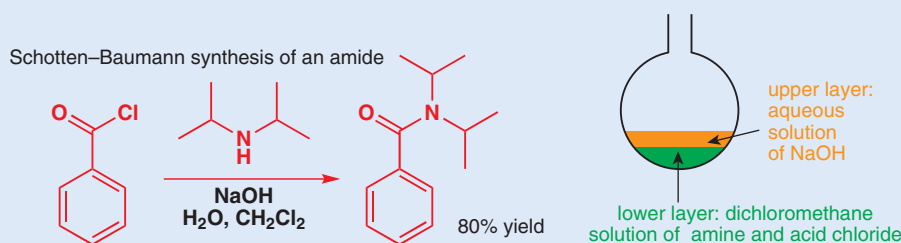

Using base strength to predict the outcome of substitution reactions of carboxylic acid derivatives

You saw that acid anhydrides react with alcohols to give esters: they will also react with amines to give amides. But would you expect esters to react with amines to give amides, or amides to react with alcohols to give esters? Both appear reasonable.

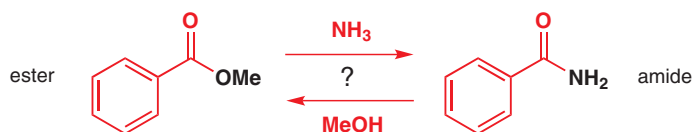

In fact only the top reaction works: amides can be formed from esters but esters cannot be formed from amides. The key question is: which group will leave from the common tetrahedral intermediate? The answer is MeO^- and not NH_2^- . You should have worked this out from the stability of the anions. Alkoxides are reasonably strong bases ($\text{p}K_{\text{a}}$ of ROH about 15) so they are not good leaving groups. But NH_2^- is a very unstable anion ($\text{p}K_{\text{a}}$ of NH_3 about 25) and is a very bad leaving group.

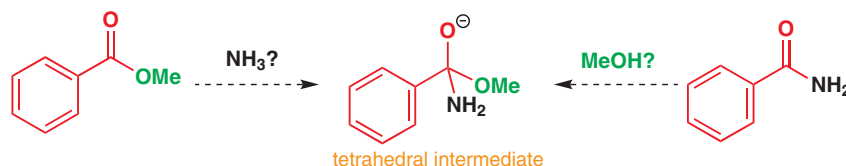

So MeO^- leaves and the amide is formed. The base used to deprotonate the first formed intermediate may be either the MeO^- produced in the reaction or, to start with, another molecule of NH_3 .

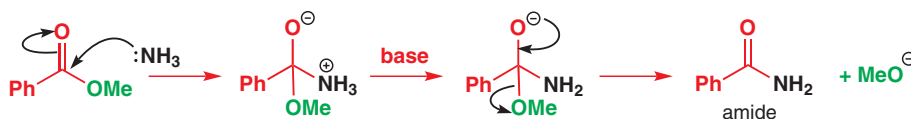

Here is a slightly unusual example in that there is a ketone present in the molecule as well. Later in the book we shall consider how to work out whether another functional group might interfere with the reaction we want to do.

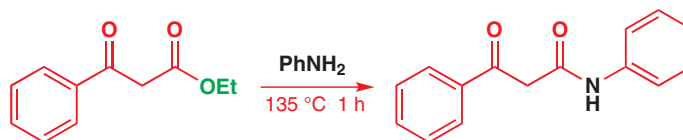

Factors other than leaving group ability can be important

In fact, the tetrahedral intermediate would simply never form from an amide and an alcohol; the amide is too bad an electrophile and the alcohol not a good enough nucleophile. We've looked at leaving group ability: next we'll consider the strength of the nucleophile Y and then the strength of the electrophile RCOX.

● Conditions for reaction

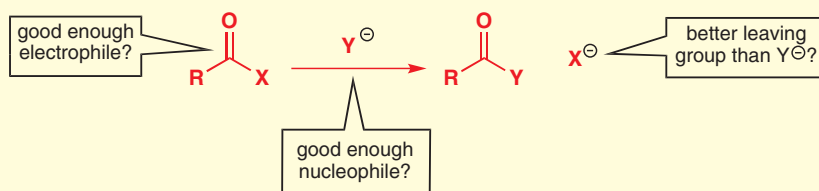

If this reaction is to go:

- 1 X⁻ must be a better leaving group than Y⁻ (otherwise the reverse reaction would take place).
- 2 Y⁻ must be a strong enough nucleophile to attack RCOX.
- 3 RCOX must be a good enough electrophile to react with Y⁻.

■ You will meet many more mechanisms like this, in which an unspecified base removes a proton from an intermediate. As long as you can satisfy yourself that there is a base available to perform the task, it is quite acceptable to write any of these shorthand mechanisms.

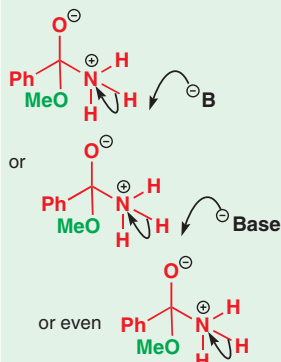

Strength of nucleophile and leaving group ability are related and pK_a is a guide to both

We have seen how pK_a gives us a guide to leaving group ability: it is also a good guide to how strong a nucleophile will be. These two properties are the reverse of each other: good nucleophiles are bad leaving groups. A stable anion is a good leaving group but a poor nucleophile. Anions of weak acids (HA has high pK_a) are bad leaving groups but good nucleophiles towards the carbonyl group.

➔ We will come back to this concept again in Chapter 15, where you will see that this principle does not apply to substitution at saturated carbon atoms.

● Guide to nucleophilicity

In general, the higher the pK_a of AH the better A^- is as a nucleophile.

But just a moment—we've overlooked an important point. We have sometimes used anions as nucleophiles (for example when we made acid anhydrides from acid chlorides plus carboxylate salts, we used an anionic nucleophile RCO_2^-) but on other occasions we have used neutral nucleophiles (for example when we made amides from acid chlorides plus amines, we used a neutral nucleophile NH_3). Anions are better nucleophiles for carbonyl groups than are neutral compounds so we can choose our nucleophilic reagent accordingly.

For proper comparisons, we should use the pK_a of NH_4^+ (about 10) if we are using neutral ammonia, but the pK_a of RCO_2H (about 5) if we're using the carboxylate anion. Ammonia is a good nucleophile and we don't usually need its anion but carboxylic acids are very weak nucleophiles and we often use their anions. You will see later in this chapter that we can alter this with acid catalysts. So this reaction works badly in either direction. We don't make or hydrolyse esters this way.

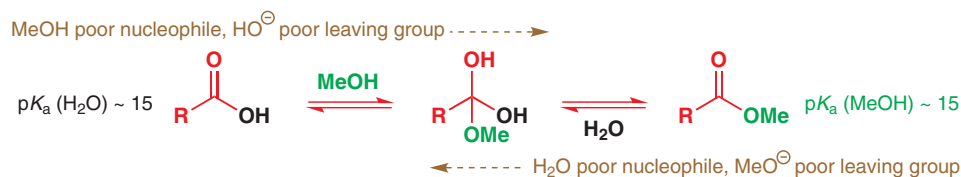

While amines react with acetic anhydride quite rapidly at room temperature (reaction complete in a few hours), alcohols react extremely slowly in the absence of a base. On the other hand, an alkoxide anion reacts with acetic anhydride extremely rapidly—the reactions are often complete within seconds at 0 °C. We don't have to deprotonate an alcohol completely to increase its reactivity: just a catalytic quantity of a weak base can do this job. All the pK_a s you need are in Chapter 8.

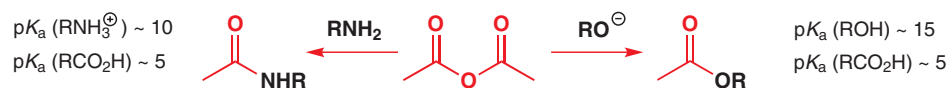

Not all carboxylic acid derivatives are equally reactive

We can list the common carboxylic acid derivatives in a 'hierarchy' of reactivity, with the most reactive at the top and the least reactive at the bottom. The nucleophile is the same in each case (water), as is the product, the carboxylic acid, but the electrophiles vary from very reactive to unreactive. The conditions needed for successful reaction show just how large is the variation on reactivity. Acid chlorides react violently with water. Amides need refluxing with 10% NaOH or concentrated HCl in a sealed tube at 100 °C overnight. We've seen that this hierarchy is partly due to how good the leaving group is (the ones at the top are best). But it also depends on the reactivity of the acid derivatives. Why is there such a large difference?

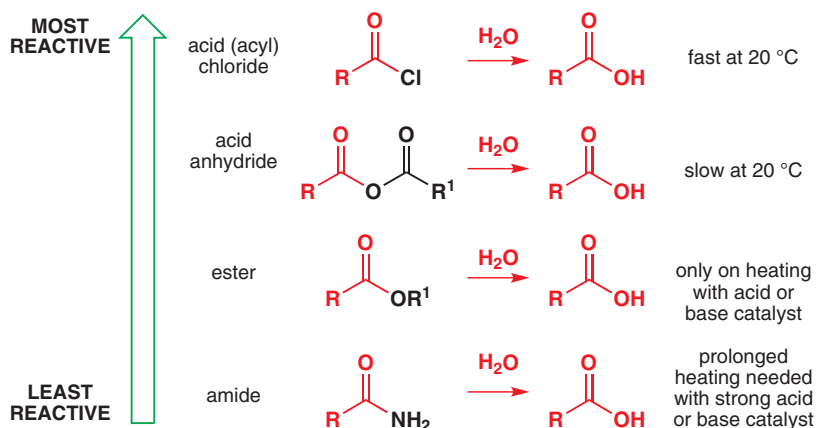

Delocalization and the electrophilicity of carbonyl compounds

Amides are the least reactive towards nucleophiles because they exhibit the greatest degree of delocalization. You met this concept in Chapter 7 and we shall return to it many times more. In an amide, the lone pair on the nitrogen atom can be stabilized by overlap with the π^* orbital of the carbonyl group—this overlap is best when the lone pair occupies a p orbital (in an amine, it would occupy an sp^3 orbital).

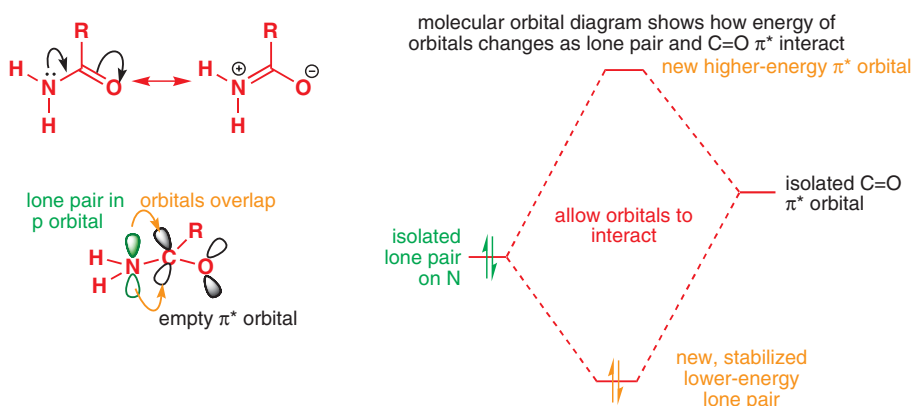

The molecular orbital diagram shows how this interaction both lowers the energy of the bonding orbital (the delocalized nitrogen lone pair), making it neither basic nor nucleophilic, and raises the energy of the π^* orbital, making it less ready to react with nucleophiles. Esters are similar, but because the oxygen lone pairs are lower in energy, the effect is less pronounced. The degree of delocalization depends on the electron-donating power of the substituent and increases along the series of compounds below from almost no delocalization from Cl to complete delocalization in the carboxylate anion, where the negative charge is equally shared between the two oxygen atoms.

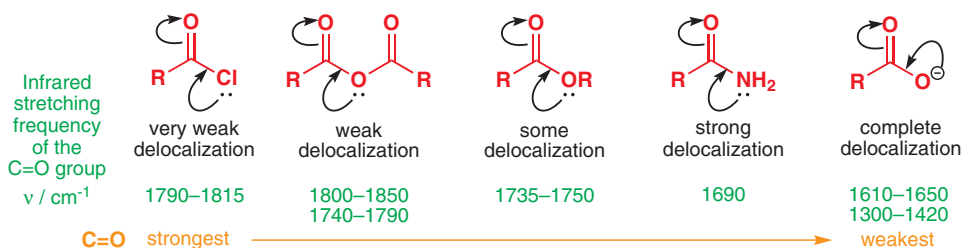

The greater the degree of delocalization, the weaker the C=O bond becomes. This is most clearly evident in the stretching frequency of the carbonyl group in the IR spectra of

carboxylic acid derivatives—remember that the stretching frequency depends on the force constant of the bond, itself a measure of the bond's strength. The carboxylate anion is included because it represents the limit of the series, with complete delocalization of the negative charge over the two oxygen atoms. There are two frequencies for the anhydride and the carboxylate anion because of symmetric and antisymmetric stretching of identical bonds.

Amides react as electrophiles only with powerful nucleophiles such as HO^- . Acid chlorides, on the other hand, react with even quite weak nucleophiles: neutral ROH , for example. They are more reactive because the electron-withdrawing effect of the chlorine atom increases the electrophilicity of the carbonyl carbon atom.

➔ Infrared spectroscopy was introduced in Chapter 3.

Bond strengths and reactivity

You may think that a weaker $\text{C}=\text{O}$ bond should be more reactive. This is not so because the partial positive charge on carbon is also lessened by delocalization and because the molecule as a whole is stabilized by the delocalization. Bond strength is not always a good guide to reactivity!

For example, in acetic acid the bond strengths are surprising. The strongest bond is the $\text{O}-\text{H}$ bond and the weakest is the $\text{C}-\text{C}$ bond. Yet very few reactions of acetic acid involve breaking the $\text{C}-\text{C}$ bond, and its characteristic reactivity, as an acid, involves breaking $\text{O}-\text{H}$, the strongest bond of them all!

The reason is that polarization of bonds and solvation of ions play an enormously important role in determining the reactivity of molecules. In Chapter 37 you will see that radicals are relatively unaffected by solvation and that their reactions follow bond strengths much more closely.

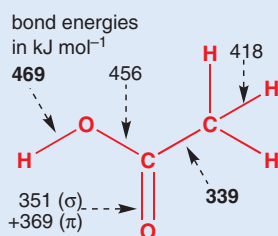

Carboxylic acids do not undergo substitution reactions under basic conditions

Substitution reactions of RCO_2H require a leaving group OH^- . The pK_a of water is about 15, so acids should be about as electrophilic as esters. Esters react well with ammonia to give amides. However, if we try to react carboxylic acids with amines to give amides no substitution occurs: an ammonium salt is formed because the amines themselves are basic and remove the acidic proton from the acid.

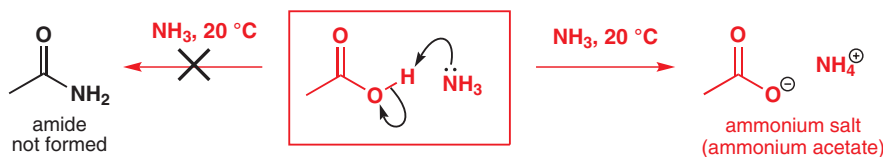

Once the carboxylic acid is deprotonated, substitutions are prevented because (almost) no nucleophile will attack the carboxylate anion. Under neutral conditions, alcohols are just not reactive enough to add to the carboxylic acid but, with *acid* catalysis, esters can be formed from alcohols and carboxylic acids.

Acid catalysts increase the reactivity of a carbonyl group

We saw in Chapter 6 that the lone pairs of a carbonyl group may be protonated by acid. Only strong acids are powerful enough to protonate carbonyl groups: the pK_a of protonated acetone is -7 so, for example, even 1M HCl ($\text{pH } 0$) would protonate only 1 in 10^7 molecules of acetone. However, even proportions as low as this are sufficient to increase the rate of substitution reactions at carbonyl groups enormously because those carbonyl groups that are protonated become extremely powerful electrophiles.

■ In fact, amides *can* be made from carboxylic acids plus amines, but only if the ammonium salt is heated strongly to dehydrate it. This is not usually a good way of making amides!

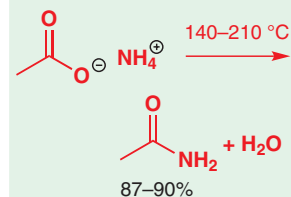

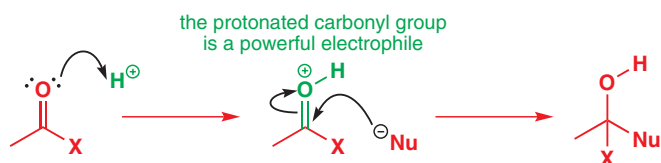

It is for this reason that alcohols will react with carboxylic acids under acid catalysis. The acid (usually HCl or H₂SO₄) reversibly protonates a small percentage of the carboxylic acid molecules, and the protonated carboxylic acids are extremely susceptible to attack by even a weak nucleophile such as an alcohol. This is the first half of the reaction:

acid-catalysed ester formation: forming the tetrahedral intermediate

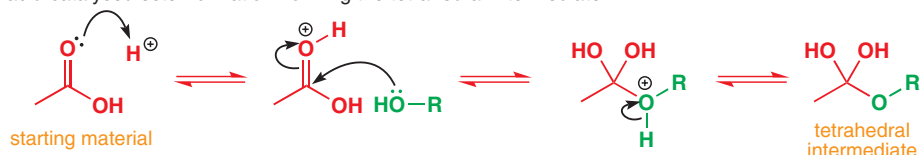

Acid catalysts can make bad leaving groups into good ones

This tetrahedral intermediate is unstable because the energy to be gained by re-forming a C=O bond is greater than that used in breaking two C–O bonds. As it stands, none of the leaving groups (R[−], HO[−], or RO[−]) is very good. However, help is again at hand in the acid catalyst. It can protonate any of the oxygen atoms reversibly. Again, only a very small proportion of molecules are protonated at any one time but, once the oxygen atom of, say, one of the OH groups is protonated, it becomes a much better leaving group (water instead of HO[−]). Loss of ROH from the tetrahedral intermediate is also possible: this leads back to starting materials—hence the equilibrium arrow in the scheme above. Loss of H₂O is more fruitful, and takes the reaction forwards to the ester product.

acid-catalysed ester formation: decomposition of the tetrahedral intermediate

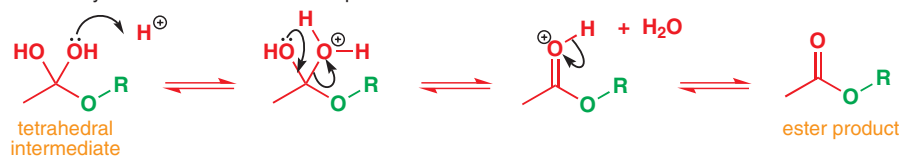

● Acid catalysts catalyse substitution reactions of carboxylic acids.

- They make the carbonyl group more electrophilic by protonation at *carbonyl oxygen*.
- They make the leaving group better by protonation there too.

Ester formation is reversible: how to control an equilibrium

Loss of water from the tetrahedral intermediate is reversible too: just as ROH will attack a protonated carboxylic acid, H₂O will attack a protonated ester. In fact, every step in the sequence from carboxylic acid to ester is an equilibrium, and the overall equilibrium constant is about 1. In order for this reaction to be useful, it is therefore necessary to ensure that the equilibrium is pushed towards the ester side by using an excess of alcohol or carboxylic acid (usually the reactions are done in a solution of the alcohol or the carboxylic acid). In this reaction, for example, no water is added and an excess of alcohol is used. Using less than three equivalents of ethanol gave lower yields of ester.

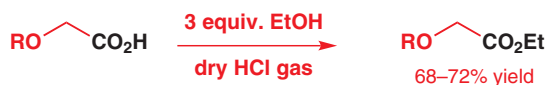

■ Average bond strength C=O
720 kJ mol^{−1}.
Average bond strength C–O
350 kJ mol^{−1}.

Alternatively, the reaction can be done in the presence of a dehydrating agent (concentrated H_2SO_4 , for example, or silica gel) or the water can be distilled out of the mixture as it forms.

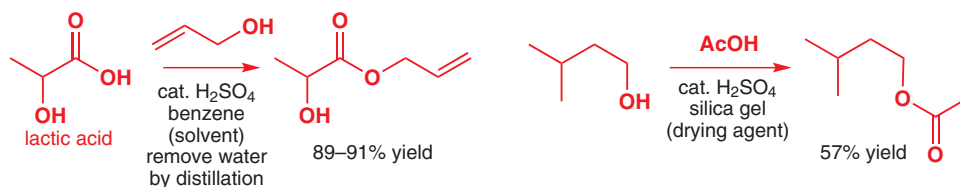

■ Lactic acid must be handled in solution in water. Can you see why, bearing in mind what we have said about the reversibility of ester formation?

● Making esters from alcohols

You have now met three ways of making esters from alcohols:

- with acyl chlorides
- with acid anhydrides
- with carboxylic acids.

Try to appreciate that different methods will be appropriate at different times. If you want to make a few milligrams of a complex ester, you are much more likely to work with a reactive acyl chloride or anhydride, using pyridine as a weakly basic catalyst, than to try to distil out a minute quantity of water from a reaction mixture containing a strong acid that may destroy the starting material. On the other hand, if you are a chemist making simple esters (such as those in Chapter 2, p. 31) for the flavouring industry on a scale of many tons, you might prefer the cheaper option of carboxylic acid and a strong acid (e.g. H_2SO_4) in alcohol solution.

Acid-catalysed ester hydrolysis and transesterification

By starting with an ester, an excess of water, and an acid catalyst we can persuade the reverse reaction to occur: formation of the carboxylic acid plus alcohol with consumption of water. Such a reaction is known as a hydrolysis reaction because water is used to break up the ester into carboxylic acid plus alcohol (*lysis*=breaking).

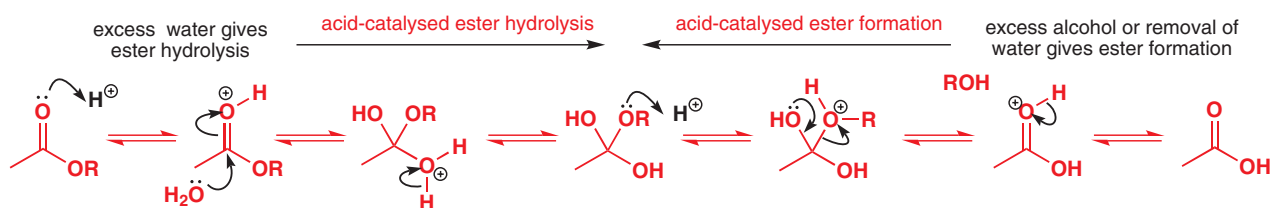

Acid-catalysed ester formation and hydrolysis are the exact reverse of one another: the only way we can control the reaction is by altering concentrations of reagents to drive the reaction the way we want it to go. The same principles can be used to convert an ester of one alcohol into an ester of another, a process known as transesterification. It is possible, for example, to force this equilibrium to the right by distilling methanol (which has a lower boiling point than the other components of the reaction) out of the mixture.

Interactive mechanism for acid-catalysed ester formation



The mechanism for this transesterification simply consists of adding one alcohol (here BuOH) and eliminating the other (here MeOH), both processes being acid-catalysed. Notice how easy it is now to confirm that the reaction is *catalytic* in H^+ .

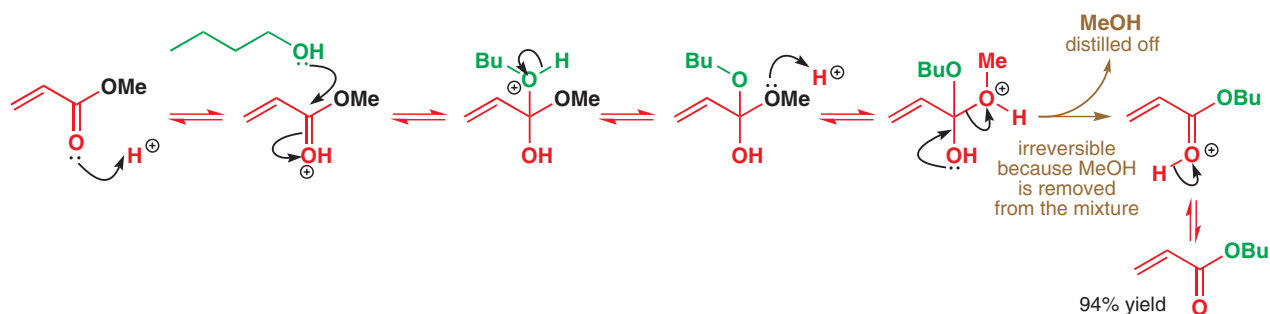

Polyester fibre manufacture

A transesterification reaction is used to make the polyester fibres that are used for textile production. Terylene, or Dacron, for example, is a polyester of the dicarboxylic acid terephthalic acid and the diol ethylene glycol.

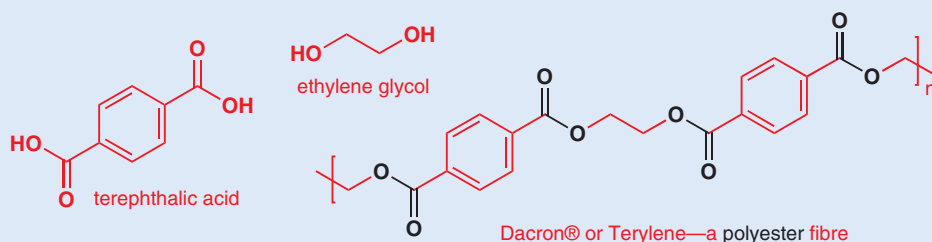

Terylene is actually made by ester exchange: dimethyl terephthalate is heated with ethylene glycol and an acid catalyst, distilling off the methanol as it is formed.

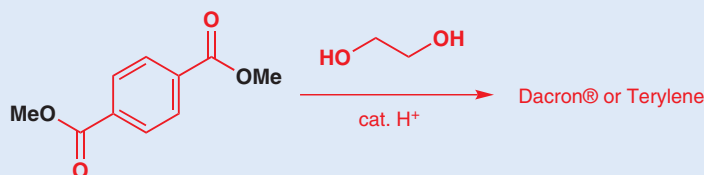

Interactive structure of polyester fibres

Base-catalysed hydrolysis of esters is irreversible

You can't make esters from carboxylic acids and alcohols under basic conditions because the base deprotonates the carboxylic acid (see p. 207). However, you can reverse that reaction and hydrolyse an ester to a carboxylic acid (more accurately, a carboxylate salt) and an alcohol.

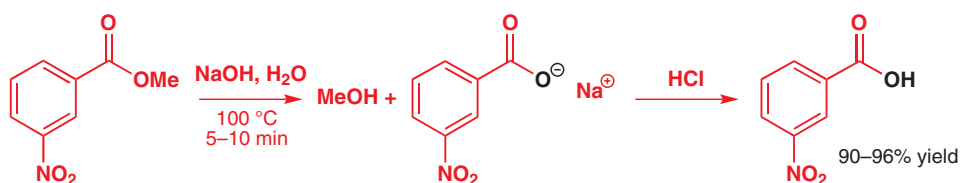

This time the ester is, of course, not protonated first as it would be in acid, but the unprotonated ester is a good enough electrophile because OH^- , and not water, is the nucleophile. The tetrahedral intermediate can collapse either way, giving back ester or going forward to acid plus alcohol.

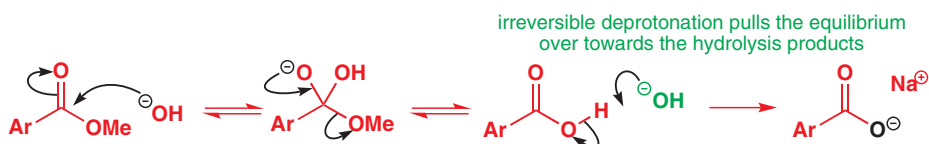

The backward reaction is impossible because the basic conditions straightaway deprotonate the acid to make a carboxylate salt (which, incidentally, consumes the base, making at least one equivalent of base necessary in the reaction). Carboxylate salts do not usually react with nucleophiles, even those a good deal stronger than alcohols.

How do we know this is the mechanism?

Ester hydrolysis is such an important reaction that chemists have spent a lot of time and effort finding out exactly how it works. Many of the experiments that tell us about the mechanism involve oxygen-18 labelling. The starting material is an ester enriched in the heavy oxygen isotope ^{18}O . By knowing where the heavy oxygen atoms start off, and following (by mass spectrometry—Chapter 3) where they end up, the mechanism can be established.

1. An ^{18}O label in the 'ether' oxygen of the ester ends up in the alcohol product.

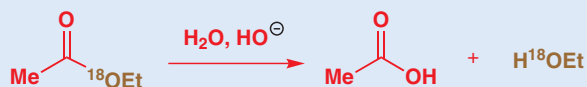

2. Hydrolysis with $^{18}\text{O}_2$ gives ^{18}O -labelled carboxylic acid, but no ^{18}O -labelled alcohol.



These experiments tell us that a displacement (substitution) has occurred at the carbonyl carbon atom, and rule out the alternative displacement at saturated carbon.

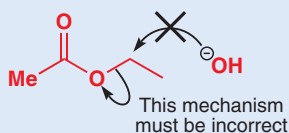

One further labelling experiment showed that a tetrahedral intermediate must be formed: an ester labelled with ^{18}O in its carbonyl oxygen atom passes some of its ^{18}O label to the water. We discussed this on p. 201.

There is more on the mechanism of ester hydrolysis in Chapter 12.

The saturated fatty acid tetradecanoic acid (also known as myristic acid) is manufactured commercially from coconut oil by hydrolysis in base. You may be surprised to learn that coconut oil contains more saturated fat than butter, lard, or beef dripping: much of it is the trimyristate ester of glycerol. Hydrolysis with aqueous sodium hydroxide, followed by reprotonation of the sodium carboxylate salt with acid, gives myristic acid. Notice how much longer it takes to hydrolyse this branched ester than it did to hydrolyse a methyl ester (p. 210).

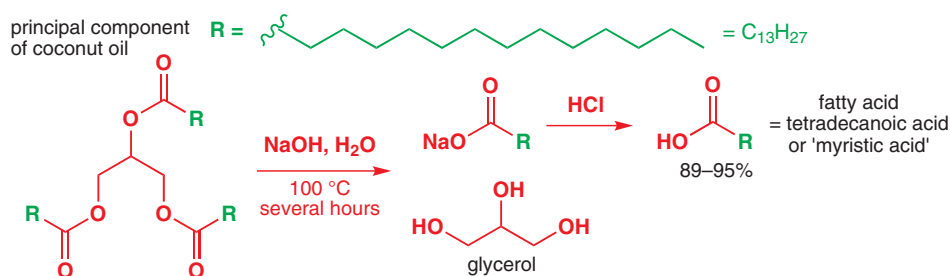

Saponification

The alkaline hydrolysis of esters to give carboxylate salts is known as saponification because it is the process used to make soap. Traditionally, beef tallow (the tristearate ester of glycerol—stearic acid is octadecanoic acid, $C_{17}H_{35}CO_2H$) was hydrolysed with sodium hydroxide to give sodium stearate, $C_{17}H_{35}CO_2Na$, the principal component of soap. Finer soaps are made from palm oil and contain a higher proportion of sodium palmitate, $C_{15}H_{31}CO_2Na$. Hydrolysis with KOH gives potassium carboxylates, which are used in liquid soaps. Soaps like these owe their detergent properties to the combination of polar (carboxylate group) and non-polar (long alkyl chain) properties.

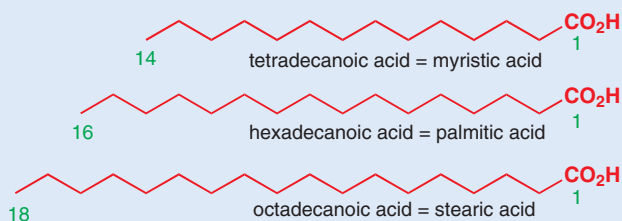

Amides can be hydrolysed under acidic or basic conditions too

In order to hydrolyse amides, the least reactive of the carboxylic acid derivatives, we have a choice: we can persuade the amine leaving group to leave by protonating it, or we can use brute force and forcibly eject it with concentrated hydroxide solution.

Amides are very unreactive as electrophiles, but they are also rather more basic than most carboxylic acid derivatives: a typical protonated amide has a pK_a of -1 ; most other carbonyl compounds are much less basic. You might therefore imagine that the protonation of an amide would take place on nitrogen—after all, *amine* nitrogen atoms are readily protonated. And, indeed, the reason for the basicity of amides is the nitrogen atom's delocalized lone pair, making the carbonyl group unusually electron rich. But amides are always protonated on the oxygen atom of the carbonyl group, never the nitrogen, because protonation at nitrogen would disrupt the delocalized system that makes amides so stable. Protonation at oxygen gives a delocalized cation (Chapter 8).

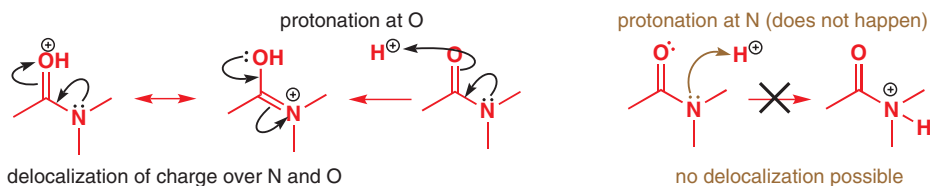

Protonation of the carbonyl group by acid makes the carbonyl group electrophilic enough for attack by water, giving a neutral tetrahedral intermediate. The amine nitrogen atom in the tetrahedral intermediate is much more basic than the oxygen atoms, so now *it* gets protonated, and the RNH_2 group becomes really quite a good leaving group. Once it has left, it will immediately be protonated again, and therefore become completely non-nucleophilic. The conditions are very vigorous—70% sulfuric acid for 3 hours at $100^\circ C$.

■ Notice that this means that one equivalent of acid is used up in this reaction—the acid is not solely a catalyst.

amide hydrolysis in acid

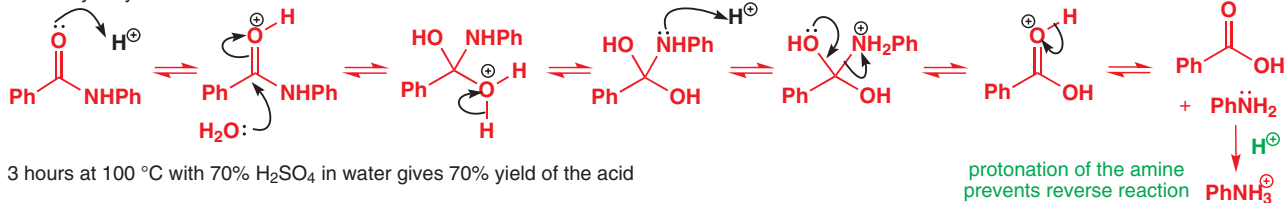

Hydrolysis of amides in base requires similarly vigorous conditions. Hot solutions of hydroxide are sufficiently powerful nucleophiles to attack an amide carbonyl group, although even when the tetrahedral intermediate has formed NH_2^- ($\text{p}K_{\text{a}}$ of the ammonium ion 35) has only a slight chance of leaving when HO^- ($\text{p}K_{\text{a}}$ of water 15) is an alternative. Nonetheless, at high temperatures amides are slowly hydrolysed by concentrated base since one product is the carboxylate salt and this does not react with nucleophiles. The 'base' for the irreversible step might be hydroxide or NH_2^- .

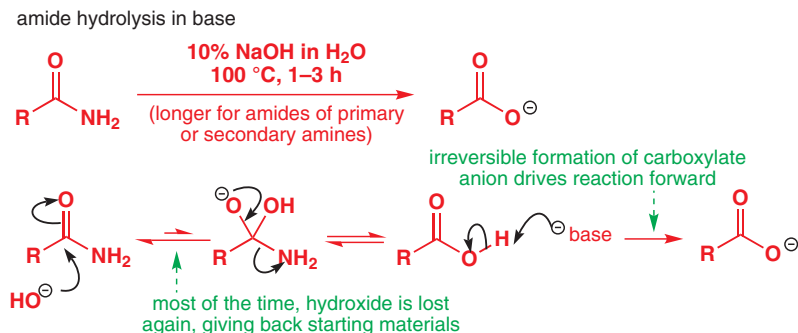

Secondary and tertiary amides hydrolyse much more slowly under these conditions. With all these amides a second mechanism kicks in if the hydroxide concentration is large enough. More hydroxide deprotonates the tetrahedral anion to give a dianion that must lose NH_2^- as the only alternative is O^{2-} . This leaving group deprotonates water so the second molecule of hydroxide ion is simply a catalyst.

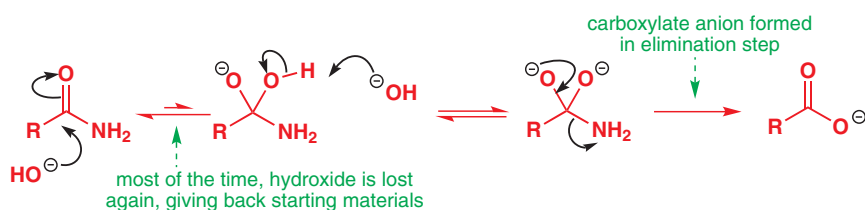

A similar mechanism is successful with only a little water and plenty of strong base. Then even tertiary amides can be hydrolysed at room temperature. Potassium *tert*-butoxide is a strong enough base ($\text{p}K_{\text{a}}$ of *t*-BuOH about 18) to deprotonate the tetrahedral intermediate.

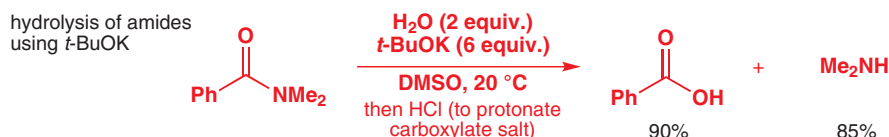

Hydrolysing nitriles: how to make the almond extract, mandelic acid

Closely related to the amides are nitriles. You can view them as primary amides that have lost one molecule of water and, indeed, they can be made by dehydrating primary amides.



They can be hydrolysed just like amides too. Addition of water to the protonated nitrile gives a primary amide, and hydrolysis of this amide gives carboxylic acid plus ammonia.

■ You've not seen the option of O^{2-} as a leaving group before but this is what you would need if you want to break the bond to O^- . Asking O^{2-} to be a leaving group is like asking HO^- to be an acid.

■ Don't be put off by the number of steps in this mechanism—look carefully and you will see that most of them are simple proton transfers. The only step that isn't a proton transfer is the addition of water.

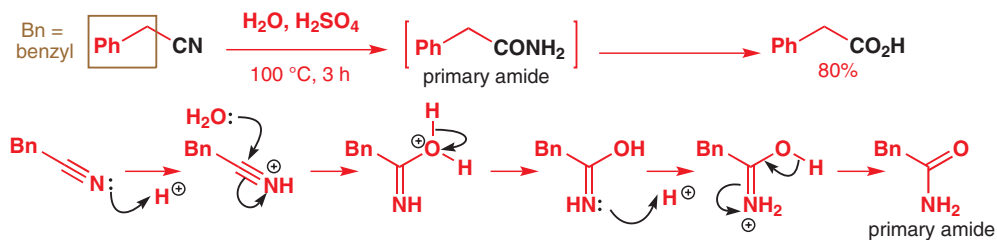

You met a way of making nitriles—from HCN (or NaCN + HCl) plus aldehydes—in Chapter 6: the hydroxynitrile products are known as **cyanohydrins**. With this in mind, you should be able to suggest a way of making mandelic acid, an extract of almonds, from benzaldehyde.

reminder from Chapter 6:



This is how some chemists did it.

■ You have just designed your first total synthesis of a natural product. We return to designing syntheses much later in this book, in Chapter 28.

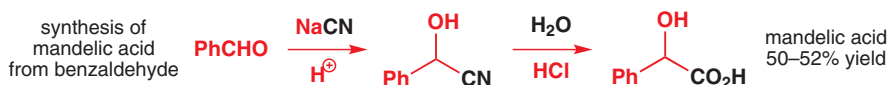

Acid chlorides can be made from carboxylic acids using SOCl_2 or PCl_5

We have looked at a whole series of interconversions between carboxylic acid derivatives and, after this next section, we shall summarize what you need to understand. We said that it is always easy to move down the series of acid derivatives we listed early in the chapter, and so far that is all we have done. But some reactions of carboxylic acids also enable us to move upwards in the series. What we need is a reagent that changes the bad leaving group HO^- into a good leaving group. Strong acid does this by protonating the OH^- , allowing it to leave as H_2O . In this section we look at two more reagents, SOCl_2 and PCl_5 , which convert the OH group of a carboxylic acid and also turn it into a good leaving group. Thionyl chloride, SOCl_2 , reacts with carboxylic acids to make acyl chlorides.

acid chlorides can be made from carboxylic acids with thionyl chloride

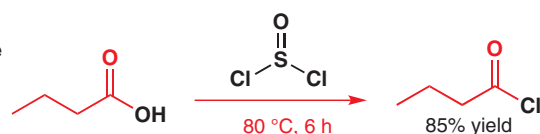

This volatile liquid with a choking smell is electrophilic at the sulfur atom (as you might expect with two chlorine atoms and an oxygen atom attached) and is attacked by carboxylic acids to give an unstable, and highly electrophilic, intermediate.

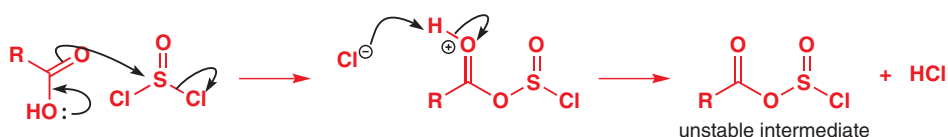

Reprotonation of the unstable intermediate (by the HCl just produced, i.e. reversal of the last step above) gives an electrophile powerful enough to react even with the weak nucleophile Cl^- (HCl is a strong acid, so Cl^- is a poor nucleophile). The tetrahedral intermediate collapses to the acyl chloride, sulfur dioxide, and hydrogen chloride. This step is irreversible because SO_2 and HCl are gases that are lost from the reaction mixture.

■ Note that it is the more nucleophilic carbonyl oxygen which actually attacks S. If you follow the fate of the two oxygens right through the mechanism you will see which fact it is the oxygen that starts off in the $\text{C}=\text{O}$ group which is replaced by Cl. You may also be surprised to see the way we substituted at $\text{S}=\text{O}$ without forming a 'tetrahedral intermediate'. Well, this trivalent sulfur atom is already tetrahedral (it still has one lone pair), and substitution can go by a direct substitution at sulfur.

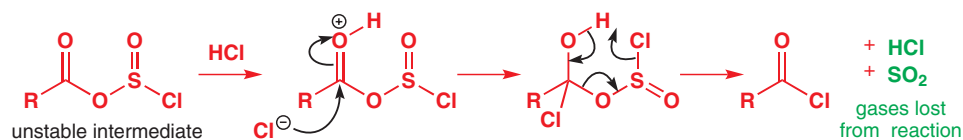

Interactive mechanism for acid chloride formation with SOCl_2

Although HCl is involved in this reaction, it cannot be used as the sole reagent for making acid chlorides. It is necessary to have a sulfur or phosphorus compound to remove the oxygen. An alternative reagent for converting RCO_2H into RCOCl is phosphorus pentachloride, PCl_5 . The mechanism is similar—try writing it out before looking at the scheme below.

acid chlorides can be made from carboxylic acids with phosphorus pentachloride

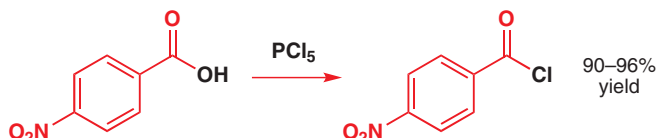

The mechanism is closely related to the previous one, except that the formation of a very stable $\text{P}=\text{O}$ bond is the vital factor rather than the loss of two gaseous reagents.

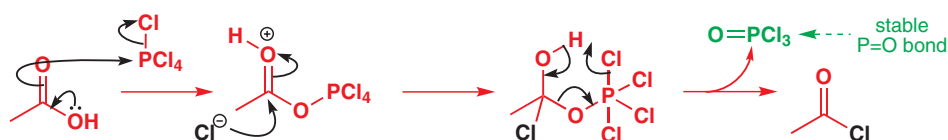

Interactive mechanism for acid chloride formation with PCl_5

These conversions of acids into acid chlorides complete all the methods we need to convert acids into any acid derivatives. You can convert acids directly to esters and now to acid chlorides, the most reactive of acid derivatives, and can make any other derivative from them. The chart below adds reaction conditions, relevant pK_a s, and infrared stretching frequencies to the reactivity order we met earlier.

We will explore the link between infrared stretching frequency and reactivity in Chapter 18.

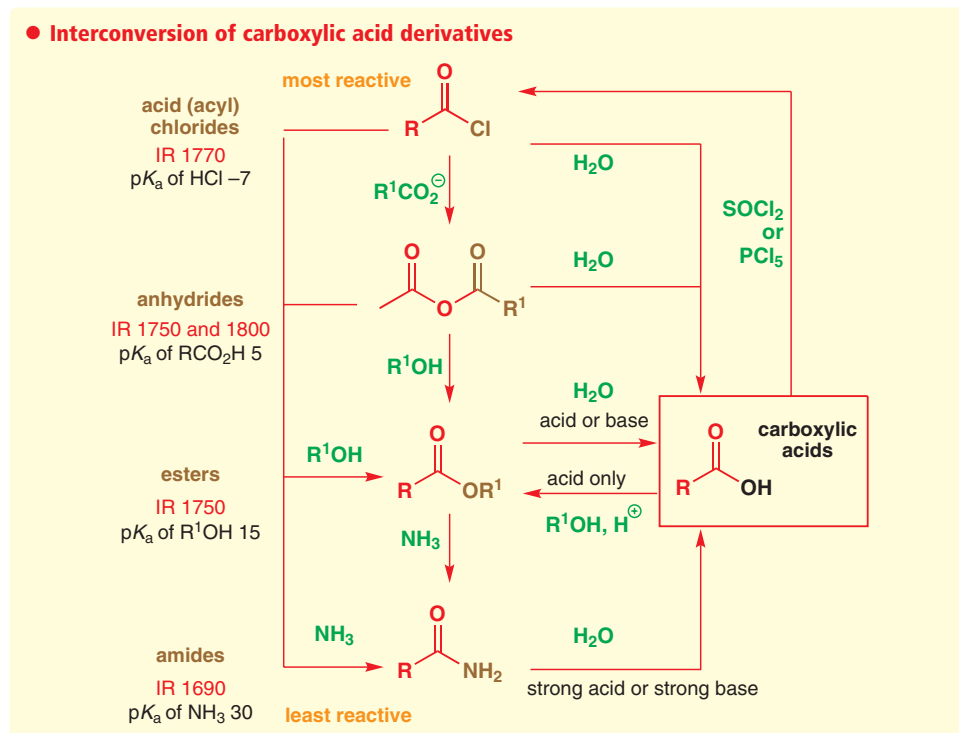

All these acid derivatives can, of course, be hydrolysed to the acid itself with water alone or with various levels of acid or base catalysis depending on the reactivity of the derivative.

To climb the reactivity order therefore, the simplest method is to hydrolyse to the acid and convert the acid into the acid chloride. You are now at the top of the reactivity order and can go down to whatever level you require.

Making other compounds by substitution reactions of acid derivatives

■ Five 'oxidation levels'—(1) hydrocarbon, (2) alcohol, (3) aldehyde and ketone, (4) carboxylic acid, and (5) CO_2 —were defined in Chapter 2.

We've talked at length about the interconversions of acid derivatives, explaining the mechanism of attack of nucleophiles such as ROH , H_2O , and NH_3 on acyl chlorides, acid anhydrides, esters, acids, and amines, with or without acid or base present. We shall now go on to talk about substitution reactions of acid derivatives that take us out of this closed company of compounds and allow us to make compounds containing functional groups at other oxidation levels, such as ketones and alcohols.

Making ketones from esters: the problem

Substitution of the OR group of an ester by an R group would give us a ketone. You might therefore think that reaction of an ester with an organolithium or Grignard reagent would be a good way of making ketones. However, if we try the reaction, something else happens, as you saw at the start of this chapter.



Two molecules of Grignard have been incorporated and we get an alcohol! If we look at the mechanism we can understand why this should be so. First, as you would expect, the nucleophilic Grignard reagent attacks the carbonyl group to give a tetrahedral intermediate. The only reasonable leaving group is RO^- , so it leaves to give us the ketone we set out to make.

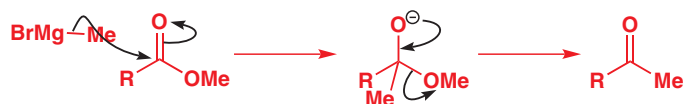

Now, the next molecule of Grignard reagent has a choice. It can react with either the ester starting material or the newly formed ketone. Ketones are more electrophilic than esters so the Grignard reagent prefers to react with the ketone in the manner you saw in Chapter 9. A stable alkoxide anion is formed, which gives the tertiary alcohol on acid work-up.

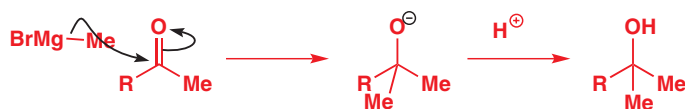

Making alcohols instead of ketones

In other words, the problem here lies in the fact that the ketone product is more reactive than the ester starting material. We shall meet more examples of this general problem later (in Chapter 23, for example): in the next section we shall look at ways of overcoming it. Meanwhile, why not see it as a useful reaction? This compound, for example, was needed by some chemists in the course of research into explosives.

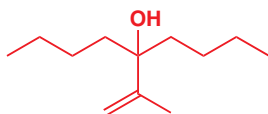

It is a tertiary alcohol with the hydroxyl group flanked by two identical R (= butyl) groups. The chemists who wanted to make the compound knew that an ester would react twice with the same organolithium reagent, so they made it from this unsaturated ester (known as methyl methacrylate) and butyllithium.

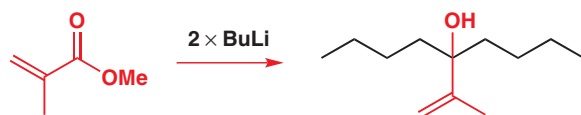

• Tertiary alcohol synthesis

Tertiary alcohols with two identical R² groups can be made from ester R¹CO₂R plus two equivalents of organolithium R²Li or Grignard reagent R²MgBr.

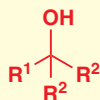

This reaction works in reduction too if we use lithium aluminium hydride, LiAlH₄. This is a powerful reducing agent that readily attacks the carbonyl group of an ester. Again, collapse of the tetrahedral intermediate gives a compound, this time an aldehyde, which is more reactive than the ester starting material, so a second reaction takes place and the ester is converted (reduced) into an alcohol. Sodium borohydride, often used for the reduction of ketones, does not usually reduce esters.

reduction of esters by LiAlH₄

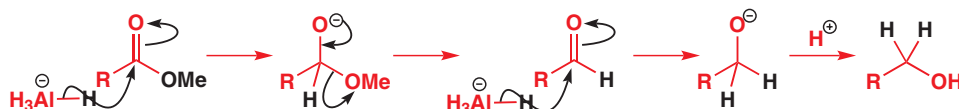

This is an extremely important reaction, and one of the best ways of making alcohols from esters. Stopping the reaction at the aldehyde stage is more difficult: we shall discuss this in Chapter 23.

A bit of shorthand

Before we go any further, we should introduce to you a little bit of chemical shorthand that makes writing many mechanisms easier. As you now appreciate, all substitution reactions at a carbonyl group go via a tetrahedral intermediate.

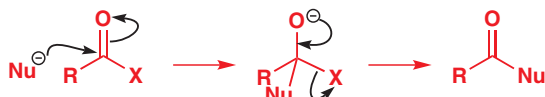

A convenient way to save writing a step is to show the formation and collapse of the tetrahedral intermediate in the same structure, by using a double-headed arrow, as in the diagrams below. Now, this is a useful shorthand, but it is not a substitute for understanding the true mechanism. Certainly, you must never ever write the reaction as a single step not involving the carbonyl group.



Here's the 'shorthand' at work in the LiAlH₄ reduction you have just met.

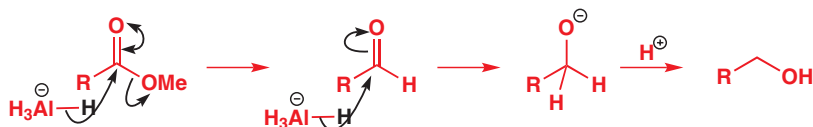

Making ketones from esters: the solution

We diagnosed the problem with our intended reaction as one of reactivity: the product ketone is more reactive than the starting ester. To get round this problem we need to do one of two things:

1. make the starting material more reactive *or*
2. make the product less reactive.

Making the starting materials more reactive

A more reactive starting material would be an acyl chloride: how about reacting one of these with a Grignard reagent? This approach can work—for example this reaction is successful.



Often, better results are obtained by transmetalating (see Chapter 9) the Grignard reagent, or the organolithium, with copper salts. Organocopper reagents are too unreactive to add to the product ketones, but they react well with the acyl chloride. Consider this reaction, for example: the product was needed for a synthesis of the antibiotic septamycin.



■ Notice how this reaction illustrates the difference in reactivity between an acyl chloride functional group and an ester functional group.

Making the products less reactive

This alternative solution is often better. With the right starting material, the tetrahedral intermediate can become stable enough not to collapse to a ketone during the reaction; it therefore remains completely unreactive towards nucleophiles. The ketone is formed only when the reaction is finally quenched with acid but the nucleophile is also destroyed by the acid and none is left for further addition.

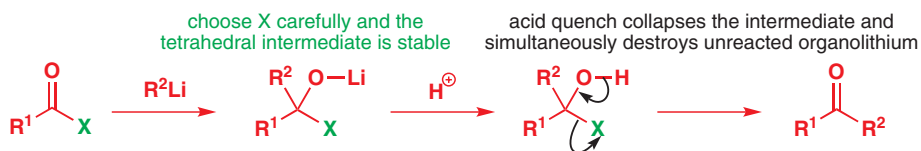

We can illustrate this concept with a reaction of an unlikely looking electrophile, a lithium carboxylate. Towards the beginning of the chapter we said that carboxylic acids were bad electrophiles and that carboxylate salts were even worse. Well, that is true, but with a sufficiently powerful nucleophile (an organolithium) it is just possible to get addition to the carbonyl group of a lithium carboxylate.

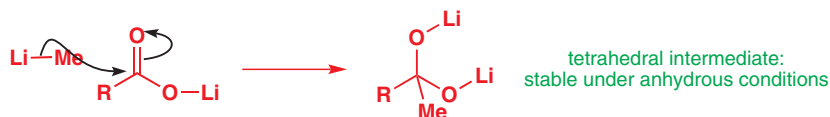

We could say that the affinity of lithium for oxygen means that the $\text{Li}-\text{O}$ bond has considerable covalent character, making the CO_2Li less of a true anion. And the intermediate after addition of MeLi is probably best represented as a covalent compound too. Anyway, the

product of this addition is a dianion of the sort that we met during one of the mechanisms of base-catalysed amide hydrolysis. But in this case there is no possible leaving group, so there the dianion sits. Only at the end of the reaction, when water is added, are the oxygen atoms protonated to give a hydrated ketone, which collapses immediately (remember Chapter 6) to give the ketone that we wanted. The water quench also destroys any remaining organolithium, so the ketone is safe from further attack.

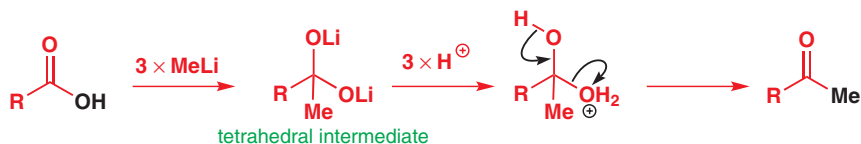

This method has been used to make some ketones that are important starting materials for making cyclic natural products known as macrolides.

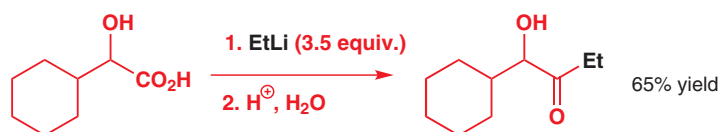

Another good set of starting materials that lead to non-collapsible tetrahedral intermediates is known as the **Weinreb amides**, after their inventor, S. M. Weinreb. Addition of organolithium or organomagnesium reagents to *N*-methoxy-*N*-methyl amides gives the tetrahedral intermediate shown, stabilized by *chelation* of the magnesium atom by the two oxygen atoms. Chelation means the coordination of more than one electron-donating atom in a molecule to a single metal atom.

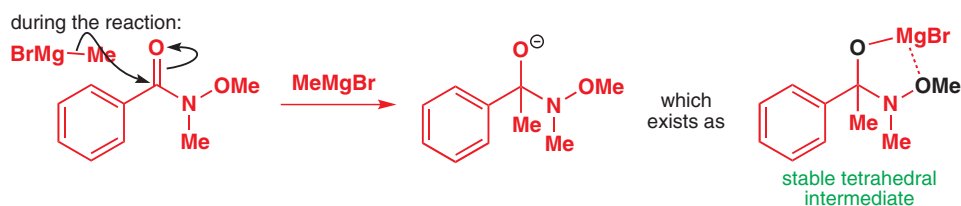

a Weinreb amide (an *N*-methoxy-*N*-methyl amide)

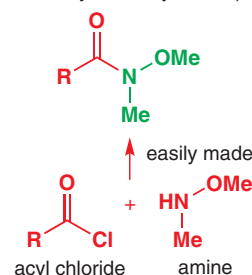

This intermediate collapses to give a ketone only when acid is added at the end of the reaction.

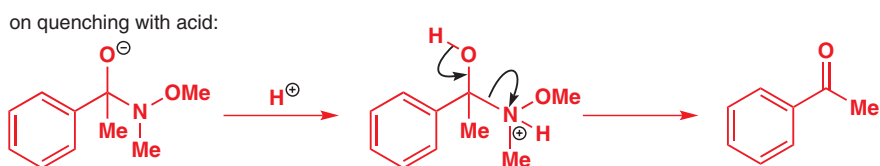

The mechanism looks complicated but the reaction is easy to do:

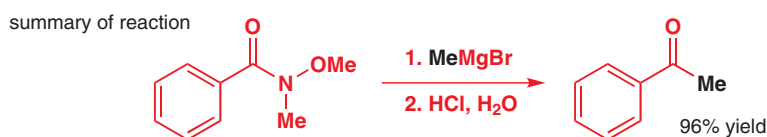

This strategy even works for making aldehydes, if the starting material is dimethylformamide (DMF, Me_2NCHO). This is an extremely useful way of adding electrophilic CHO groups to organometallic nucleophiles. Once again, the tetrahedral intermediate is stable until acid is added at the end of the reaction and the protonated tetrahedral intermediate collapses.

■ Notice that three equivalents of organolithium are needed in this reaction: one to deprotonate the acid, one to deprotonate the hydroxyl group, and one to react with the lithium carboxylate. These chemists added a further 0.5 for good measure.

■ The word chelation derives from *chela*, the Greek for 'claw'.

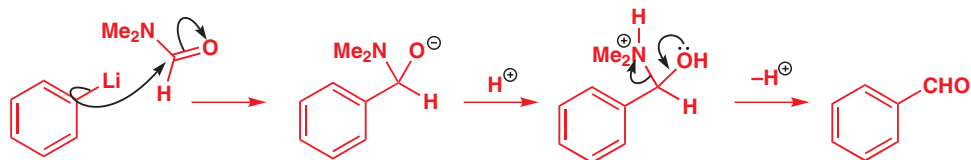

A final alternative is to use a nitrile instead of an ester. The intermediate is the anion of an imine (see Chapter 12 for more about imines), which is not electrophilic at all—in fact, it's quite nucleophilic, but there are no electrophiles for it to react with until the reaction is quenched with acid. It gets protonated and hydrolyses (we'll discuss this in the next chapter) to the ketone.

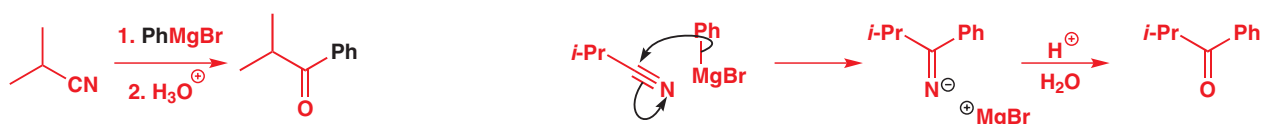

To summarize...

To finish, we should just remind you of what to think about when you consider a nucleophilic substitution at a carbonyl group.

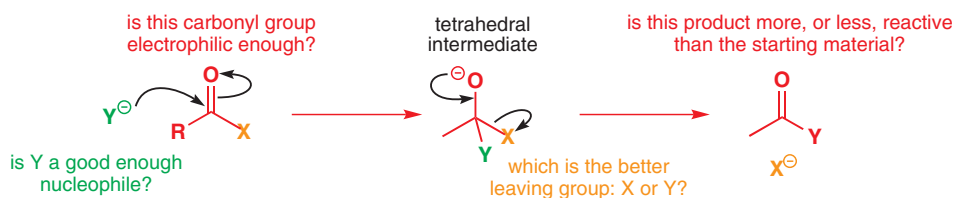

And to conclude...

In this chapter you have been introduced to some important reactions—you can consider them to be a series of facts if you wish, but it is better to see them as the logical outcome of a few simple mechanistic steps. Relate what you have seen to what you gathered from Chapters 6 and 9, when we first started looking at carbonyl groups. All we did in this chapter was to build some subsequent transformations on to the simplest organic reaction, addition to a carbonyl group. You should have noticed that the reactions of all acid derivatives are related and are very easily explained by writing out proper mechanisms, taking into account the presence of acid or base. In the next two chapters we shall see more of these acid- and base-catalysed reactions of carbonyl groups. Try to view them as closely related to the ones in this chapter—the same principles apply to their mechanisms.

Further reading

Section 2, 'Nucleophilic substitution to the carbonyl group' in S. Warren, *Chemistry of the Carbonyl Group*, Wiley, Chichester, 1974.

The dehydration of amides to give nitriles is described in *Vogel*, p. 716.

Check your understanding



To check that you have mastered the concepts presented in this chapter, attempt the problems that are available in the book's Online Resource Centre at <http://www.oxfordtextbooks.co.uk/orc/clayden2e/>

11

Nucleophilic substitution at C=O with loss of carbonyl oxygen

Connections

➔ Building on

- Nucleophilic attack on carbonyl groups [ch6](#)
- Acidity and pK_a [ch8](#)
- Nucleophilic substitution at carbonyl groups [ch10](#)

Arriving at

- Replacement of carbonyl oxygen
- Acetal formation
- Imine formation
- Stable and unstable imines
- The Strecker and Wittig reactions

➔ Looking forward to

- Rate and pH [ch12](#)
- Protecting groups [ch23](#)
- Acylation of enolates [ch26](#)
- Synthesis of alkenes [ch27](#)

Introduction

Nucleophiles add to carbonyl groups to give compounds in which the trigonal carbon atom of the carbonyl group has become tetrahedral.

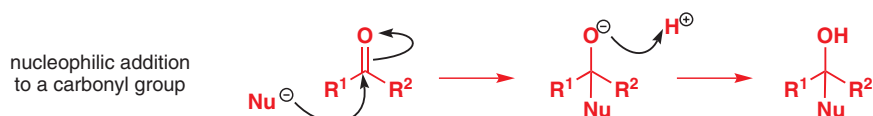



In Chapter 10 you saw that these compounds are not always stable: if the starting material contains a leaving group, the addition product is a **tetrahedral intermediate**, which collapses with loss of the leaving group to give back the carbonyl group, with overall substitution of the leaving group by the nucleophile.

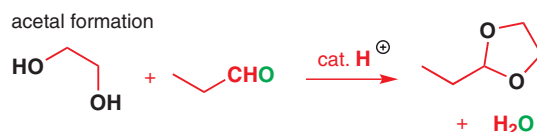
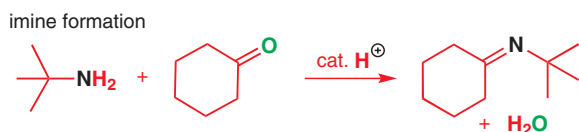

■ Acetals had walk-on parts in Chapters 2 and 6; in this chapter they are one of the stars. They are simply compounds with two oxygen atoms bound to the same saturated carbon atom. This example is cyclic, but others are not, for example $\text{CH}_2(\text{OMe})_2$.

In this chapter you will meet substitution reactions of a different type. Instead of losing a leaving group, the carbonyl group loses its oxygen atom. Here are two important examples: the carbonyl oxygen atom has been replaced by a nitrogen atom during imine formation and by two atoms of oxygen during acetal formation. Notice too the acid catalyst—we shall see shortly why it is required. These are examples of *nucleophilic substitution at the carbonyl group with loss of carbonyl oxygen*.



Online support. The icon  in the margin indicates that accompanying interactive resources are provided online to help your understanding: just type www.chemtube3d.com/clayden/123 into your browser, replacing 123 with the number of the page where you see the icon. For pages linking to more than one resource, type 123-1, 123-2 etc. (replacing 123 with the page number) for access to successive links.

You have, in fact, already met some less important reactions in which the carbonyl oxygen atom can be lost, but you probably didn't notice at the time. The equilibrium between an aldehyde or ketone and its hydrate (p. 134) is one such reaction.

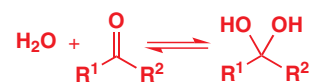

When the hydrate reverts to starting materials, either of its two oxygen atoms must leave: one came from the water and one from the carbonyl group, so 50% of the time the oxygen atom that belonged to the carbonyl group will be lost. Usually, this is of no consequence, but it can be useful. For example, in 1968 some chemists studying the reactions that take place inside mass spectrometers needed to label the carbonyl oxygen atom of a ketone with the isotope ^{18}O .

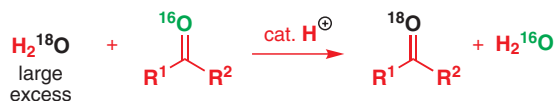

By stirring the 'normal' ^{16}O compound with a large excess of isotopically labelled water for a few hours in the presence of a drop of acid they were able to make the required labelled compound. Without the acid catalyst, the exchange is very slow. Acid catalysis speeds the reaction up by making the carbonyl group more electrophilic so that equilibrium is reached more quickly.

Aldehydes can react with alcohols to form hemiacetals

When acetaldehyde is dissolved in methanol, a reaction takes place: we know this because the IR spectrum of the mixture shows that a new compound has been formed. Most dramatically, the carbonyl frequency is no longer there. However, isolating the product is impossible: it decomposes back to acetaldehyde and methanol.

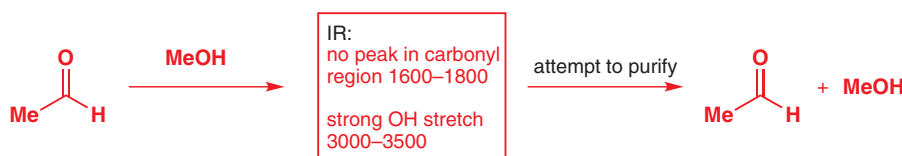

The product is in fact a hemiacetal. Like hydrates, most hemiacetals are unstable with respect to their parent aldehydes and alcohols, for example the equilibrium constant for reaction of acetaldehyde with simple alcohols is about 0.5.

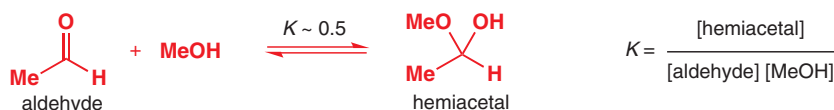

➔ You met the mechanism for this reversible reaction in Chapter 6.

So by making $[\text{MeOH}]$ very large (using it as the solvent, for example) we can turn most of the aldehyde into the hemiacetal. However, if we try to purify the hemiacetal by removing the methanol, more hemiacetal keeps decomposing to maintain the equilibrium constant. That is why we can never isolate such hemiacetals in a pure form.

Acid or base catalysts increase the rate of equilibration of hemiacetals with their aldehyde and alcohol parents

Acyclic hemiacetals form relatively slowly from an aldehyde or ketone plus an alcohol, but their rate of formation is greatly increased either by acid or by base. As you would expect from Chapters 6 and 10, acid catalysts work by increasing the electrophilicity of the carbonyl group.

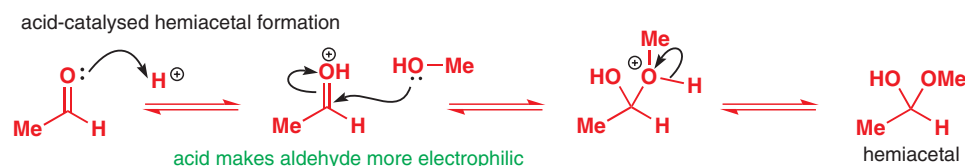

■ The exceptions are cyclic hemiacetals, as you saw in Chapter 6, in which the nucleophilic OH group is in the same molecule as the electrophilic carbonyl. We will explain how *entropy* accounts for this in Chapter 12.

Base catalysts, on the other hand, work by increasing the nucleophilicity of the alcohol by removing the OH proton before it attacks the C=O group. In both cases the energy of the starting materials is raised: in the acid-catalysed reaction the aldehyde is destabilized by protonation and in the base-catalysed reaction the alcohol is destabilized by deprotonation.

base-catalysed hemiacetal formation

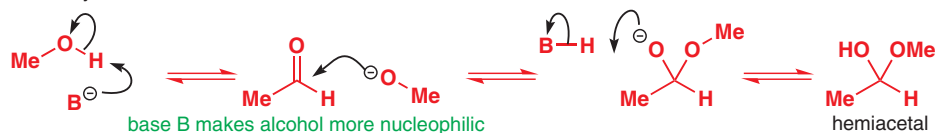

You can see why hemiacetals are unstable: they are essentially tetrahedral intermediates containing a leaving group and, just as acid or base catalyses the formation of hemiacetals, acid or base also catalyses their decomposition back to starting aldehyde or ketone and alcohol. That's why the title of this section indicated that acid or base catalysts increase the rate of equilibration of hemiacetals with their aldehyde and alcohol components—catalysts never change the position of that equilibrium!

acid-catalysed hemiacetal decomposition

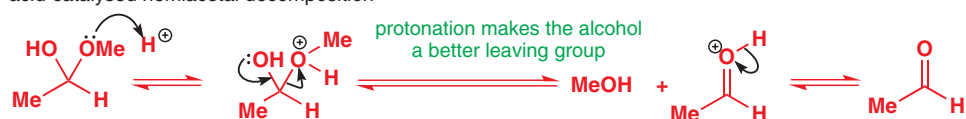

base-catalysed hemiacetal decomposition

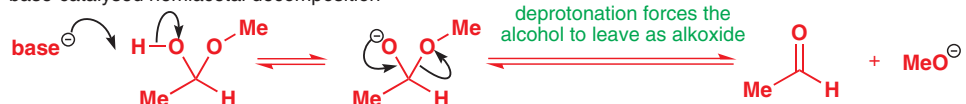

● **To summarize**

Hemiacetal formation and decomposition are catalysed by acid or base.

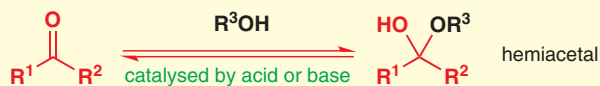

Acetals are formed from aldehydes or ketones plus alcohols in the presence of acid

We said that a solution of acetaldehyde in methanol contains a new compound: a hemiacetal. We've also said that the rate of formation of hemiacetals is increased by adding an acid (or a base) catalyst to the alcohol plus aldehyde mixture. But, if we add catalytic acid to our acetaldehyde–methanol mixture, we find not only that the rate of reaction of the acetaldehyde with the methanol increases, but also that a different product is formed. This product is an acetal; the hemiacetal is half-way there.

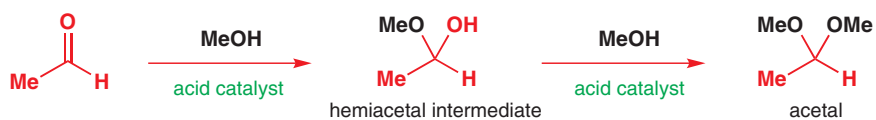

In the presence of acid (but not base!) hemiacetals can undergo an elimination reaction (different from the one that just gives back aldehyde plus alcohol), losing the oxygen atom that once belonged to the parent aldehyde's carbonyl group.

acid-catalysed acetal formation from hemiacetal

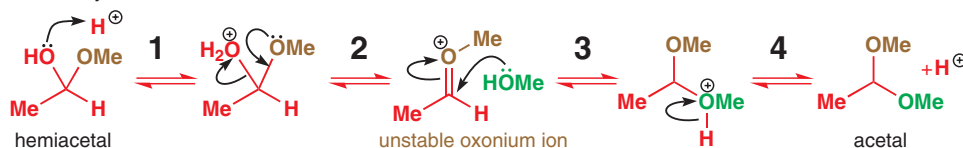

The stages are:

1. Protonation of the hydroxyl group of the hemiacetal.
2. Loss of water by elimination. This elimination leads to an unstable and highly reactive oxonium ion.
3. Addition of methanol to the oxonium ion (breaking the π bond and not the σ bond, of course).
4. Loss of a proton to give the acetal.

Oxonium ions

Oxonium ions have three bonds to a positively charged oxygen atom. All three bonds can be σ bonds, as in H_3O^+ or Meerwein's salt, trimethyloxonium fluoroborate, a stable (though reactive) alkylating agent, or one bond can be a π bond as in the acetal intermediate. The term 'oxonium ion' describes either of these structures. They are like alkylated ethers or *O*-alkylated carbonyl compounds.

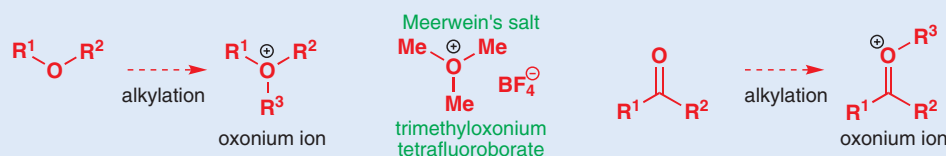

Just as protonated carbonyl groups are much more electrophilic than unprotonated ones, these oxonium ions are powerful electrophiles. They can react rapidly with a second molecule of alcohol to form the new, stable compounds known as acetals. An oxonium ion was also an intermediate in the formation of hemiacetals in acid solution. Before reading any further, it would be worthwhile to write out the whole mechanism of acetal formation from aldehyde or ketone plus alcohol through the hemiacetal to the acetal, preferably without looking at the fragments of mechanism above or the answer overleaf.

● Formation of acetals and hemiacetals

Hemiacetal formation is catalysed by acid or base, but acetal formation is possible only with an acid catalyst because an OH group must be made into a good leaving group.



The mechanism is the most complex you have met and it will help you to recall it if you see it in two halves, each very similar to the other. The reaction starts with a protonation on carbonyl oxygen and addition of an alcohol to the $\text{C}=\text{O}$ π bond. When you get to the temporary haven of the hemiacetal, you start again with protonation of that same oxygen then lose the OH group by breaking what was the $\text{C}=\text{O}$ σ bond to form an oxonium ion. Each half goes through an oxonium ion and the alcohol adds to each oxonium ion. The last step in the formation of both the acetal and the hemiacetal is the loss of a proton from the recently added alcohol. From your complete mechanism you should also be able to verify that acetal formation is indeed catalytic in acid.

Interactive mechanism for acetal formation

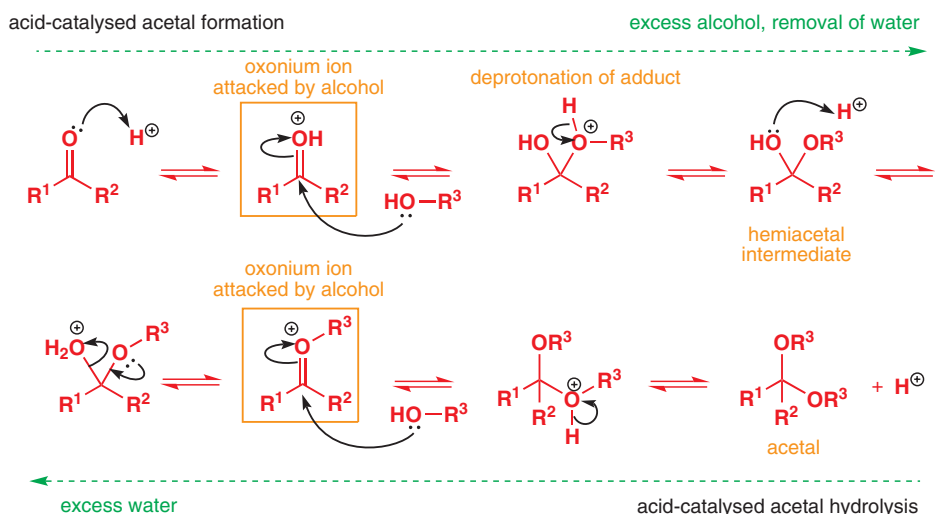

● Remember the oxonium ion!

When you wrote out your mechanism for acetal formation, we hope you didn't miss out the oxonium ion! It's easy to do so, but the mechanism most definitely does not go via a direct displacement of water by alcohol.

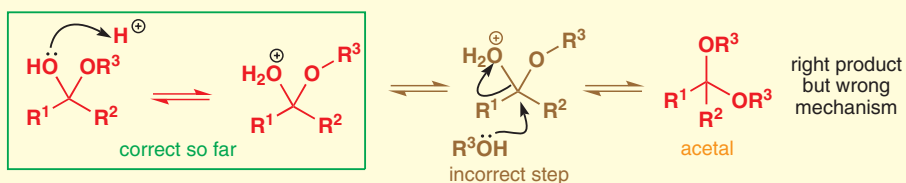

If you wonder how we know this, consult a specialized book on organic reaction mechanisms. After you have read Chapter 15 in this book, you will be able to spot that this substitution step goes via an S_N1 and not an S_N2 mechanism.

Making acetals

Just as with the ester formation and hydrolysis reactions we discussed in Chapter 10, every step in the formation of an acetal is reversible. To make acetals, therefore, we must use an excess of alcohol or remove the water from the reaction mixture as it forms, by distillation for example.

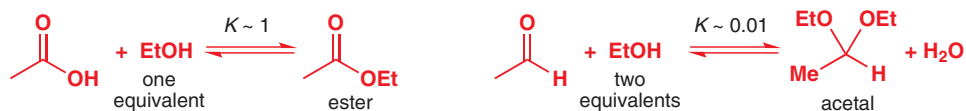

In fact, acetal formation is even more difficult than ester formation: while the equilibrium constant for acid-catalysed formation of ester from carboxylic acid plus alcohol is usually about 1, for acetal formation from an aldehyde and ethanol (shown above), the equilibrium constant is $K = 0.0125$. For ketones, the value is even lower: in fact, it is often very difficult to make the acetals of ketones (sometimes called ketals) unless they are cyclic (we consider cyclic acetals later in the chapter). However, there are several techniques that can be used to prevent the water produced in the reaction from hydrolysing the product.

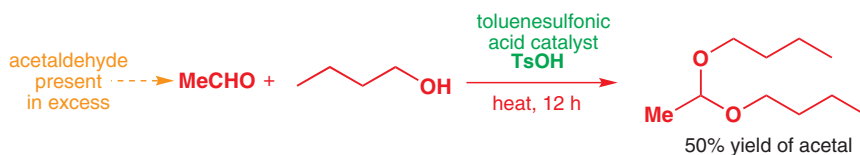

para-Toluenesulfonic acid

para-Toluenesulfonic acid is commonly used to catalyse reactions of this sort. It is a stable solid, yet is as strong an acid as sulfuric acid. It is widely available and cheap because it is produced as a by-product in the synthesis of saccharin (for more details, see Chapter 21).

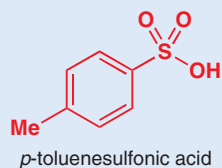

With the more reactive aldehyde, it was sufficient just to have an excess of one of the reagents (acetaldehyde) to drive the reaction to completion. Dry HCl gas can work too. With a less reactive ketone, molecular sieves (zeolite) were used to remove water from the reaction as it proceeded.

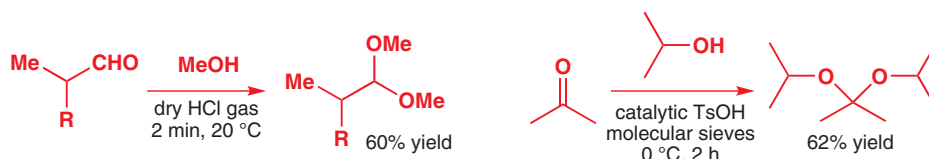

Molecular sieves are minerals that have very small cavities that can absorb only even smaller molecules. The ones used in acetal formation selectively absorb water. They are supplied as tiny cylinders of whitish material.

Acetals hydrolyse only in the presence of acid

Just as acetal formation requires acid catalysis, acetals can be hydrolysed only by using an acid catalyst. With aqueous acid, the hydrolysis of acyclic acetals is very easy. Our examples are the two acetals we made earlier.

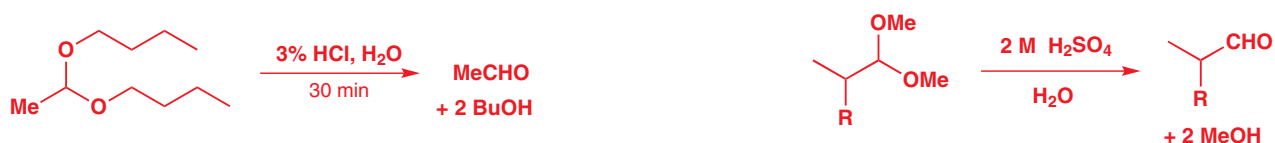
**● Acetal hydrolysis**

Acetals can be hydrolysed in acid but are stable to base.

We won't go through the mechanism again—you've already seen it as the reverse of acetal formation, but the fact that acetals are stable to base is really a very important point, which we will use on the next page and capitalize on further in Chapter 23.

Cyclic acetals are more stable than acyclic acetals

Of course you want us to prove it. Well, in this example the starting material has three acetals: an ordinary acetal formed from methanol (in black), a five-membered cyclic acetal, and a dithioacetal. Only the black acetal hydrolyses under these mild conditions.



The acetals you have met so far were formed by reaction of two molecules of alcohol with one of carbonyl compound. Cyclic acetals, formed by reaction of a single molecule of a diol, a compound containing two hydroxyl groups, are also important. When the diol is ethylene glycol (as in this example) the five-membered cyclic acetal is known as a **dioxolane**.

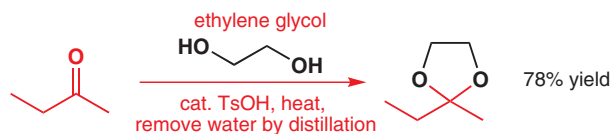

■ We hope you didn't make the mistake of missing out the oxonium ion steps!

Before looking at the answer below, try to write a mechanism for this reaction. If you need it, use the mechanism we gave for the formation of acyclic acetals.

acid-catalysed dioxolane formation

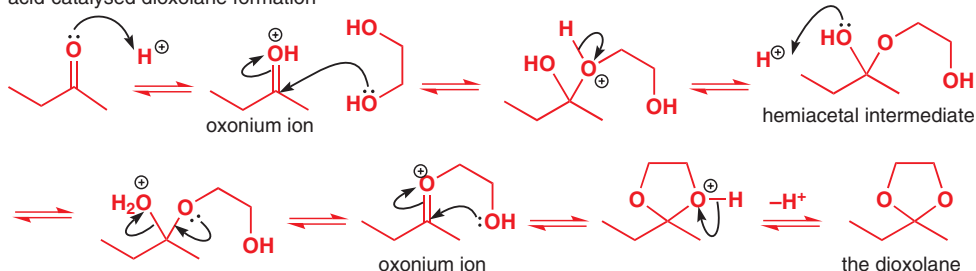

Interactive mechanism for cyclic acetal formation

■ Cyclic acetals like this are more resistant to hydrolysis than acyclic ones, and easier to make—they form quite readily even from ketones. One explanation for this is that whenever the second oxonium ion in this mechanism forms, the hydroxyl group is always held close by, ready to snap shut and give back the dioxolane; water gets less of a chance to attack it and hydrolyse the acetal. We will discuss in *entropic* terms why cyclic acetals and hemiacetals are more stable in Chapter 12.

Water is still generated, and needs to be got rid of: in the example above you can see that water was distilled out of the reaction mixture. This is possible with these diols because they have a boiling point above that of water (the boiling point of ethylene glycol is 197 °C). You can't distil water from a reaction mixture containing methanol or ethanol because the alcohols distil too! One very useful piece of equipment for removing water from reaction mixtures containing only reagents that boil at higher temperatures than water is called a Dean Stark head.

Dean Stark head

When a mixture of toluene and water boils, the vapour produced is a constant ratio mixture of toluene vapour and water vapour known as an **azeotrope**. If this mixture is condensed, the liquid toluene and water, being immiscible, separate out into two layers with the water below. By using a Dean Stark apparatus, or Dean Stark head, the toluene layer can be returned to the reaction mixture while the water is removed. Reactions requiring removal of water by distillation are therefore often carried out in refluxing toluene or benzene under a Dean Stark head.

Modifying reactivity using acetals

Why are acetals so important? Well, they're important to both nature and chemists because many carbohydrates are acetals or hemiacetals (see the box below). One important use that chemists have put them to is as *protecting groups*. One synthesis of the steroid class of compounds (about which more later) requires a Grignard reagent with an impossible structure. This compound cannot exist as the Grignard functional group would attack the ketone: it would react with itself. Instead, the protected Grignard reagent is used, made from the same bromoketone, but with an acetal-forming step.

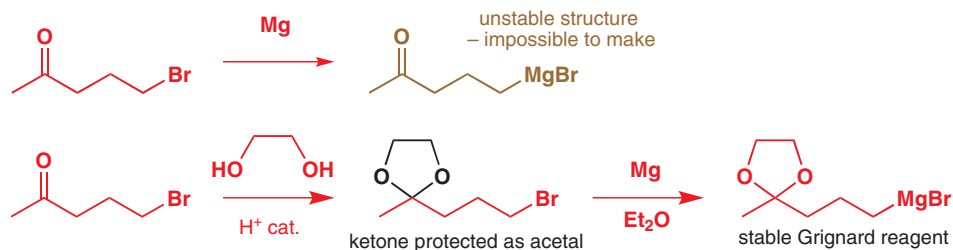

Acetals, as we stressed, are stable to base and to basic nucleophiles such as Grignard reagents, so we no longer have a reactivity problem. Once the Grignard reagent has reacted with an electrophile, the ketone can be recovered by hydrolysing the acetal in dilute acid. The acetal is functioning here as a protecting group because it protects the ketone from attack by the Grignard reagent. Protecting groups are extremely important in organic synthesis and we will return to them in Chapter 23.

Acetals in nature

We showed you glucose as on p.137 an example of a stable, cyclic hemiacetal. Glucose can, in fact, react with itself to form an acetal known as maltose. Maltose is a disaccharide (made of two sugar units) produced by the enzy-

matic hydrolysis of starch or cellulose, which are themselves polyacetals made up of a string of glucose units.

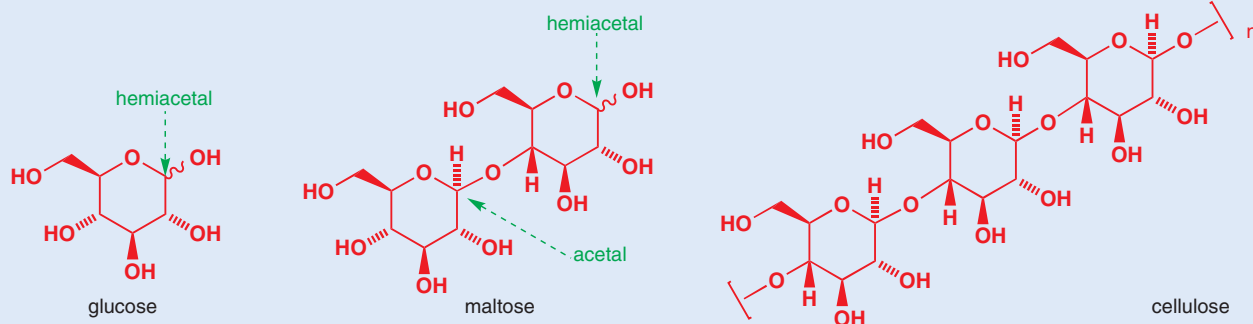

Amines react with carbonyl compounds

The ketone carbonyl group of pyruvic acid (or 2-oxopropanoic acid) has a stretching frequency of a typical ketone, 1710 cm^{-1} . When hydroxylamine is added to a solution of pyruvic acid, this stretching frequency slowly disappears. Later, a new IR absorption appears at 1400 cm^{-1} . What happens?

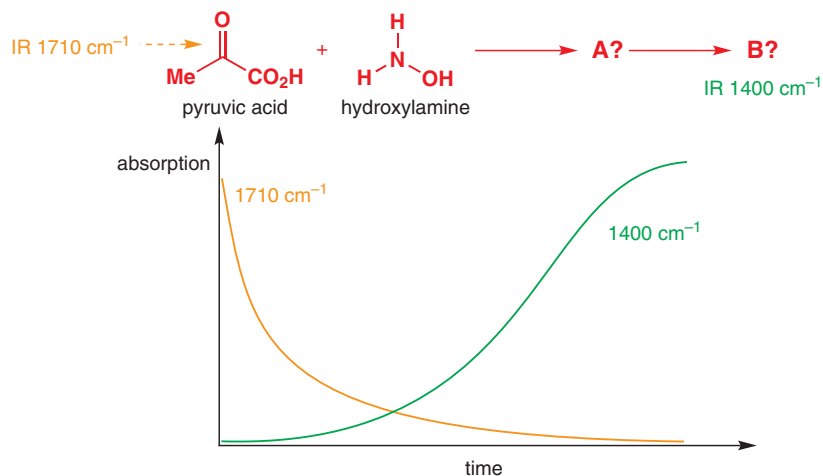

You can probably apply something of what you know from Chapters 6 and 10 about the reactivity of carbonyl compounds towards nucleophiles to work out what is happening in this reaction between a carbonyl compound and an amine. The hydroxylamine first adds to the ketone to form an unstable intermediate similar to a hemiacetal.

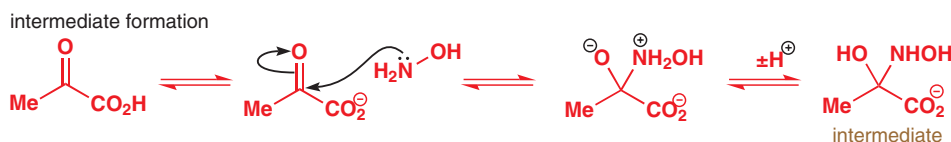

Notice that it is the more nucleophilic nitrogen atom, and not the oxygen atom, of hydroxylamine that adds to the carbonyl group. Like hemiacetals, these intermediates are unstable and can decompose by loss of water. The product is known as an oxime and it is this compound, with its $\text{C}=\text{N}$ double bond, that is responsible for the IR absorption at 1400 cm^{-1} .

dehydration of the intermediate to give oxime

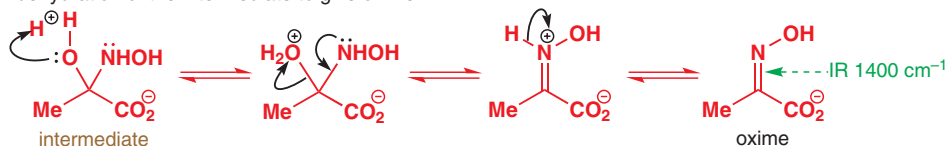

We know that the oxime is formed *via* an intermediate because the 1400 cm⁻¹ absorption hardly appears until after the 1710 cm⁻¹ absorption has almost completely gone. There must really be another curve to show the formation and the decay of the intermediate. The only difference is that the intermediate has no double bond to give an IR absorbance in this region of the spectrum. We come back to oximes later in the chapter.

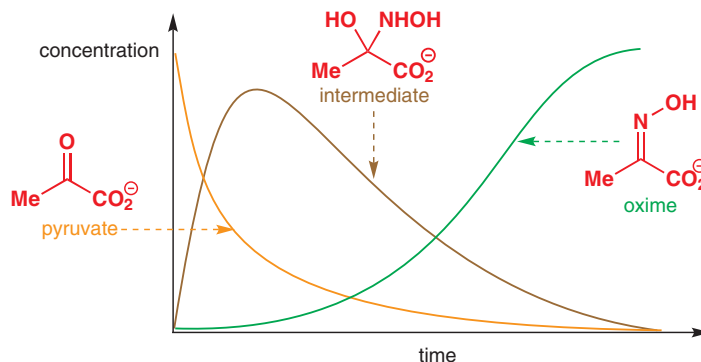

Imines are the nitrogen analogues of carbonyl compounds

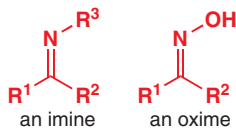

In fact, the oxime formed from a ketone and hydroxylamine is just a special example of an imine. All imines have a C=N double bond and are formed when any primary amine reacts with an aldehyde or a ketone under appropriate conditions, for example aniline and benzaldehyde.

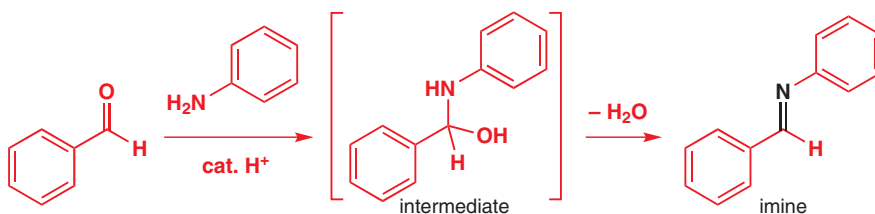

You shouldn't need us to tell you the mechanism of this reaction: even without looking at the mechanism we gave for the formation of the oxime it should come as no surprise to you by now. But as the reaction is very important in chemistry and biology, we'll discuss it in some depth. First, the amine attacks the aldehyde and the intermediate known as a hemiacetal is formed. Amines are good nucleophiles for carbonyl groups, and aldehydes and ketones are electrophilic. There is no need for any catalysis in this step. Indeed, addition of acid would slow the reaction down as the nucleophilic amine would be removed as a salt.

■ Acid would protonate the amine and remove it from the equilibrium and so slow this step down. Acid is not needed for the first step.

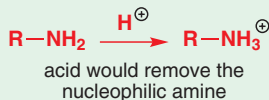

First step in imine formation:
the amine attacks the carbonyl group to form the hemiaminal intermediate:

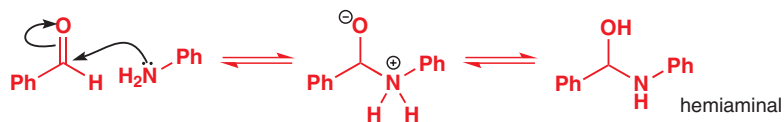

Dehydration of the hemiaminal gives the imine. Now there is some need for catalysis: acid must be added so that the OH group can become a good leaving group. This step resembles the conversion of hemiacetals to acetals. The difference is that the iminium ion can lose a proton and become a neutral imine.

Second step in imine formation: acid-catalysed dehydration of the hemiaminal intermediate:

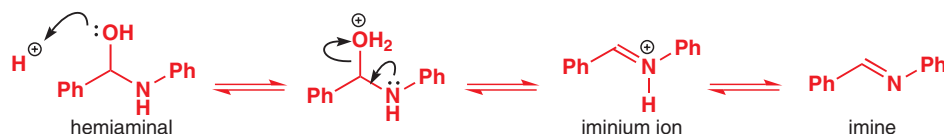

Interactive mechanism for imine formation

● **Imine formation requires acid catalysis.**

So acid is needed for the second step but hinders the first step. Clearly some compromise is needed. Without an acid catalyst, the reaction is very slow, although in some cases it may still take place. Imine formation is in fact fastest at about pH 4–6: at lower pH, too much amine is protonated and the rate of the first step is slow; above this pH the proton concentration is too low to allow protonation of the OH leaving group in the dehydration step. Imine formation is like a biological reaction: it is fastest near neutrality.

➔ The dependence of the rate of reactions on pH is discussed further in Chapter 12.

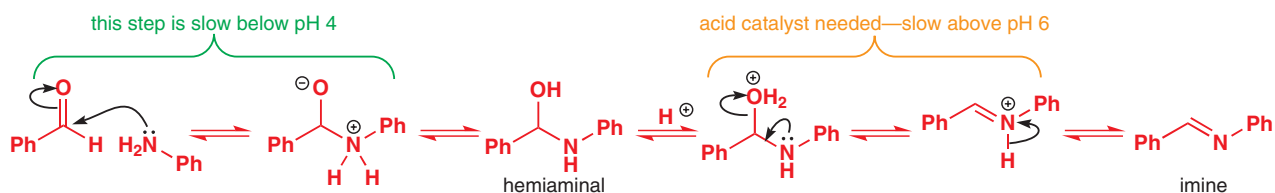

Imines are usually unstable and are easily hydrolysed

Like acetals, imines are unstable with respect to their parent carbonyl compound and amine, and must be formed by a method that allows removal of water from the reaction mixture.



Imines are formed from aldehydes or ketones with most primary amines. In general, they are stable enough to be isolated only if either the C or N of the imine double bond bears an aromatic substituent. Imines formed from ammonia are unstable, but can be detected in solution. $\text{CH}_2=\text{NH}$, for example, decomposes at temperatures above -80°C , but $\text{PhCH}=\text{NH}$ is detectable by UV spectroscopy in a mixture of benzaldehyde and ammonia in methanol.



■ Because it is made from an unsymmetrical ketone this imine can exist as a mixture of *E* and *Z* isomers, just like an alkene. When it is formed by this method the ratio obtained is 8:1 *E:Z*. Unlike the geometrical isomers of alkenes, however, those of an imine usually interconvert quite rapidly at room temperature. The geometrical isomers of oximes on the other hand are stable and can even be separated.

Imines are readily hydrolysed to the carbonyl compound and amine by aqueous acid—in fact, except for the particularly stable special cases we discuss below, most can be hydrolysed by water without acid or base catalysis. You have, in fact, already met an imine hydrolysis: at the end of Chapter 10 we talked about the addition of Grignard reagents to nitriles. The product is an imine that hydrolyses in acid solution to ketone plus ammonia.

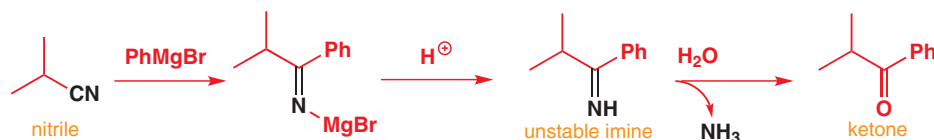

The mechanism of the hydrolysis is the reverse of imine formation, going through the same hemiaminal intermediate and the same iminium and oxonium ions. All these steps are reversible and this should remind you that the relative stability of the starting material and product is as important in imine formation and hydrolysis as it is in acetal formation and hydrolysis.

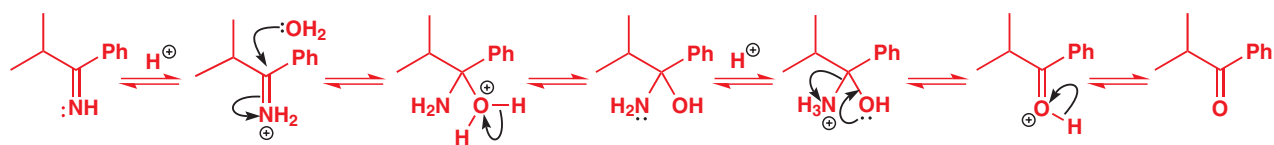

Some imines are stable

Imines in which the nitrogen atom carries an electronegative group are usually stable: examples include oximes, hydrazones, and semicarbazones.

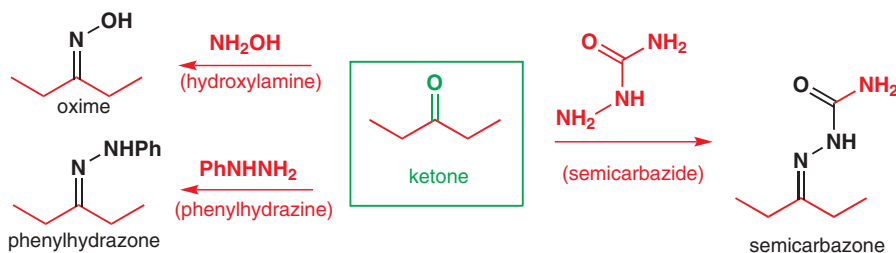

Interactive mechanism for hydrazone formation

These compounds are more stable than imines because the electronegative substituent can participate in delocalization of the imine double bond. Delocalization decreases the small positive charge on the carbon atom of the imine double bond and raises the energy of the LUMO, making it less susceptible to nucleophilic attack. Oximes, hydrazones, and semicarbazones require acid or base catalysis to be hydrolysed.



Historical note

Because the hydrazone and semicarbazone derivatives of carbonyl compounds are often stable, crystalline solids, they used to be used to confirm the supposed identity of aldehydes and ketones. For example, the boiling points of these

three isomeric five-carbon ketones are all similar and before the days of NMR spectroscopy it would have been hard to distinguish between them.

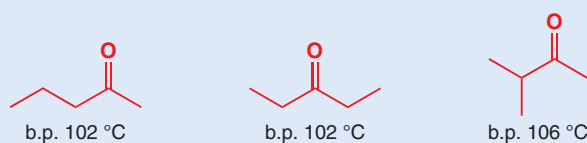

Their semicarbazones and 2,4-dinitrophenylhydrazones, on the other hand, all differ in their melting points. By making these derivatives of the ketones, identification was made much easier. Of course, all of this has been totally super-

seded by NMR! However, these crystalline derivatives are still useful in the purification of volatile aldehydes and ketones, and in solving structures by X-ray crystallography.

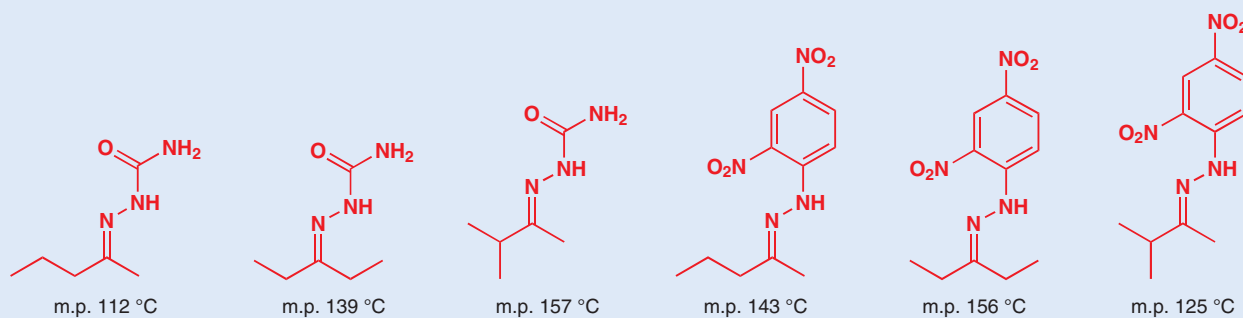

Iminium ions and oxonium ions

Let's return to the mechanism of imine formation, and compare it for a moment with that of acetal formation. The only difference to begin with is that there is no need for acid catalysis for the addition of the amine but there is need for acid catalysis in the addition of the alcohol, a much weaker nucleophile.

acid-catalysed imine formation

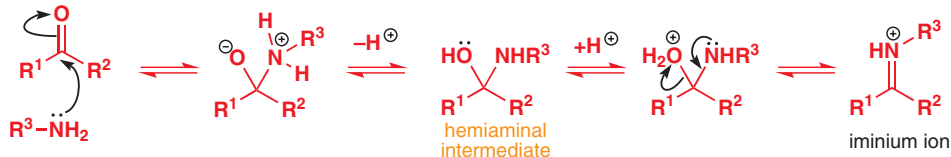

acid-catalysed acetal formation

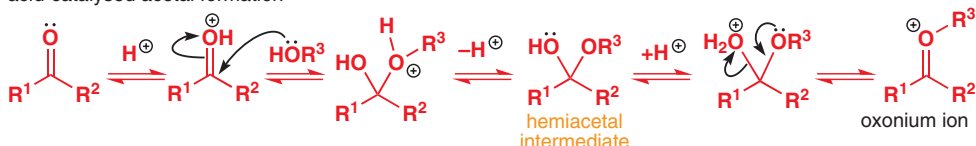

Up to this point, the two mechanisms follow a very similar path, with clear analogy between the hemiaminal and hemiacetal intermediates, and between the iminium and oxonium ions. Here, though, they diverge, because the iminium ion carries a proton, which the oxonium ion doesn't have. The iminium ion therefore acts as an acid, losing a proton to become the imine. The oxonium ion, on the other hand, acts as an electrophile, adding another molecule of alcohol to become the acetal.

iminium ion

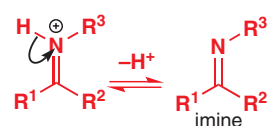

oxonium ion

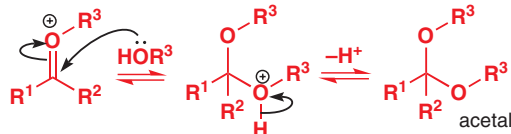

As you might guess, however, iminium ions can be persuaded to act as electrophiles, just like oxonium ions, provided a suitable nucleophile is present. We will spend the next few pages considering reactions in which an iminium ion acts as an electrophile. First, though, we will look at a reaction in which the iminium ion cannot lose an N–H proton because it has none.

Secondary amines react with carbonyl compounds to form enamines

Pyrrolidine, a secondary amine, reacts with isobutyraldehyde, under the sort of conditions you would use to make an imine, to give an enamine. The name enamine combines 'ene' (C=C double bond) and 'amine'.

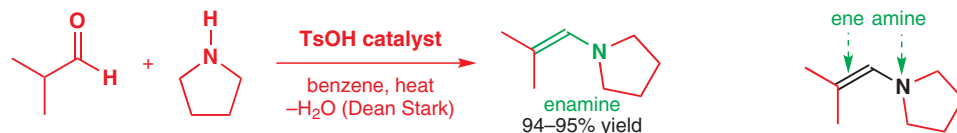

The mechanism consists of the same steps as those that take place when imines form from primary amines, up to formation of the iminium ion. This iminium ion has no N–H proton to lose, so it loses one of the C–H protons next to the C=N to give the enamine. Enamines, like imines, are unstable to aqueous acid.

Interactive mechanism for enamine formation

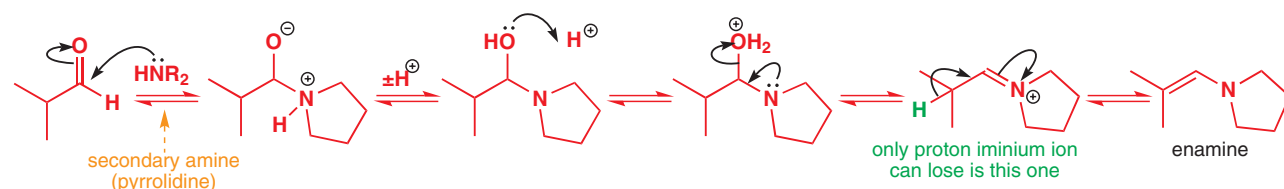

● Imines and enamines

- Imines are formed from aldehydes or ketones with primary amines.
- Enamines are formed from aldehydes or ketones with secondary amines.

Both require acid catalysis and removal of water.

Enamines of primary amines, or even of ammonia, also exist, but only in equilibrium with an imine isomer. The interconversion between imine and enamine is the nitrogen analogue of **enolization**, which is discussed in detail in Chapter 20.

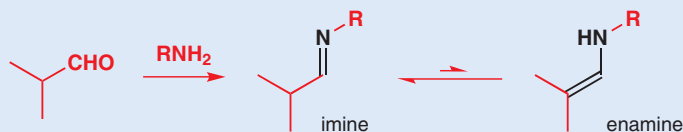

Iminium ions can react as electrophilic intermediates

We made the point above that the difference in reactivity between an iminium ion and an oxonium ion is that an iminium ion can lose H^+ and form an imine or an enamine, while an oxonium ion reacts as an electrophile. Iminium ions can, however, react as electrophiles provided suitable nucleophiles are present. In fact, they are very good electrophiles, and are significantly more reactive than carbonyl compounds. For example, iminium ions are reduced rapidly by the mild reducing agent sodium cyanoborohydride, $Na(CN)BH_3$, while carbonyl compounds are not. An alternative to $Na(CN)BH_3$ is $NaBH(OAc)_3$ (sodium triacetoxyborohydride)—somewhat safer because strong acid can release deadly HCN from $Na(CN)BH_3$.

Sodium cyanoborohydride contains the cyanoborohydride anion, whose structure has tetrahedral boron.

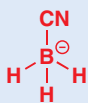

It is a 'toned down' version of sodium borohydride—the electron-withdrawing cyano group decreases the ease with which hydride is transferred.

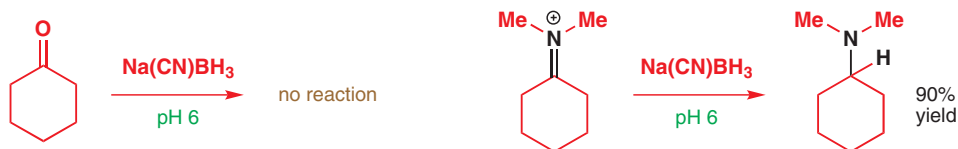

Amines from imines: reductive amination

A useful way of making amines is by reduction of imines (or iminium ions). This overall process, from carbonyl compound to amine, is called **reductive amination**. This is, in fact, one of the few successful ways, and the best way, of making secondary amines. This should be your first choice in amine synthesis.

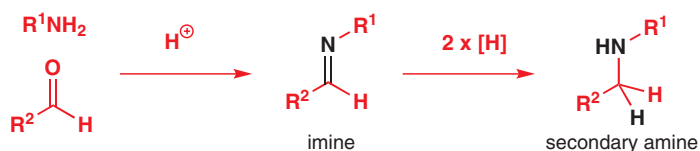

This can be done in two steps, provided the intermediate is stable, but, because the instability of many imines makes them hard to isolate, the most convenient way of doing it is to form and reduce the imine in a single reaction. The selective reduction of iminium ions (but not carbonyl compounds) by sodium cyanoborohydride makes this possible. When $Na(CN)BH_3$ is added to a typical imine-formation reaction it reacts with the iminium ion but not with the starting carbonyl compound nor with the imine. Here is an example of an amine synthesis using reductive amination.

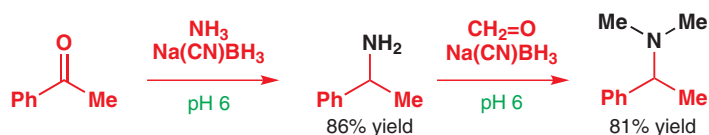

In the first step, the ketone and ammonia are in equilibrium with their imine, which, at pH 6, is partly protonated as an iminium ion. The iminium ion is rapidly reduced by the cyanoborohydride to give the amine. Reactions like this, using ammonia in a reductive amination, are often carried out with ammonium chloride or acetate as convenient sources of ammonia. At pH 6, ammonia will be mostly protonated anyway as the pK_a of NH_4^+ is about 10.

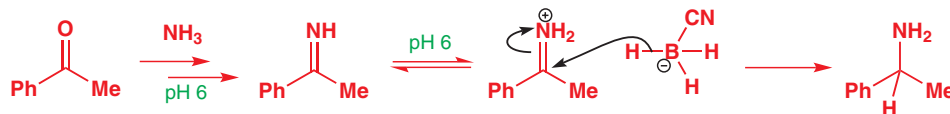

In the second step of the synthesis, amine plus formaldehyde gives an imine, present as its protonated iminium form, which gets reduced. Formaldehyde is so reactive that it reacts again with the secondary amine to give an iminium ion; this too is reduced to the amine.

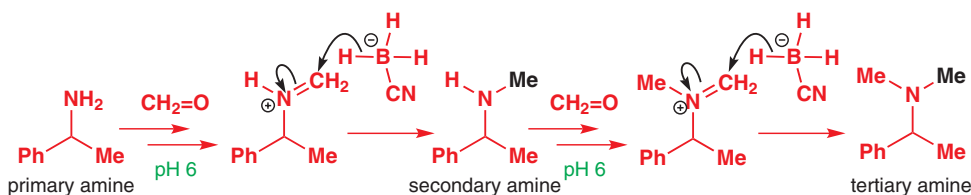

➔ You will again meet the highly electrophilic iminium ions produced by reaction of formaldehyde with amines in Chapter 26, where we introduce you to the Mannich reaction.

Living things make amino acids using imines

The amino acid alanine can be made in moderate yield in the laboratory by reductive amination of pyruvic acid.

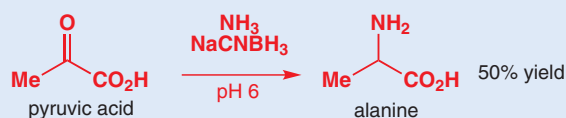

Living things use a very similar reaction to manufacture amino acids from keto acids, but do it much more efficiently. The key step is the formation of an imine between pyruvic acid and the vitamin B₆-derived amine pyridoxamine.

Nature's synthesis of alanine:
pyridoxamine

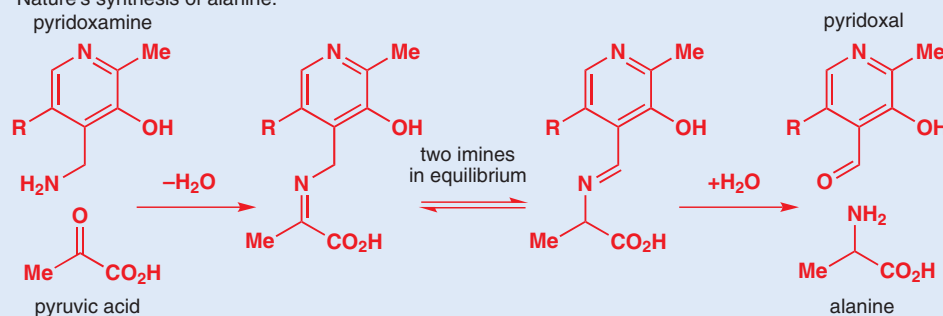

This imine (biochemists call imines Schiff bases) is in equilibrium with an isomeric imine, which can be hydrolysed to pyridoxal and alanine. These reactions are, of course, all controlled by enzymes and coupled to the degradation of unwanted amino acids (the latter process converts the pyridoxal back to pyridoxamine). Nature was doing reductive aminations a long time before sodium cyanoborohydride was invented! We will come back to this in Chapter 42.

An alternative method for reductive amination uses hydrogenation (hydrogen gas with a metal catalyst) to reduce the imine in the presence of the carbonyl compound. Most of these reductions do not require such high temperatures or pressures.

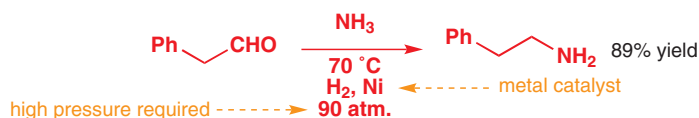

■ Hydrogenation is a good way of reducing a number of different functional groups, but not (usually) carbonyl groups. In Chapter 23 we will look in more detail at reducing agents (and other types of reagent) that demonstrate selectivity for one functional group over another (**chemoselectivity**).

Lithium aluminium hydride reduces amides to amines

We've talked about reduction of iminium ions formed from carbonyl compounds plus amines. Iminium ions can also be formed by reducing amides with lithium aluminium hydride. A tetrahedral intermediate is formed that collapses to the iminium ion.

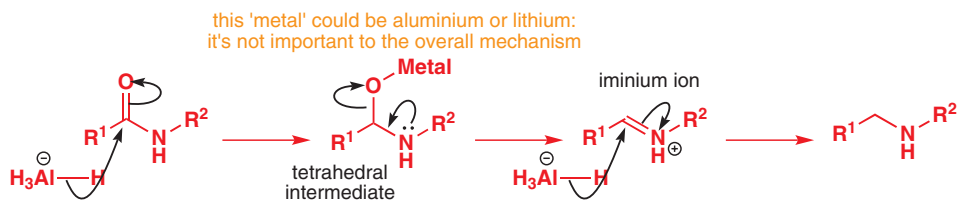

The iminium ion is, of course, more electrophilic than the starting amides (amide carbonyl groups are about the least electrophilic of any!), so it gets reduced to the secondary amine. This reaction can be used to make secondary amines from primary amines and acyl chlorides. A similar reduction with lithium aluminium hydride gives a primary amine from a nitrile.

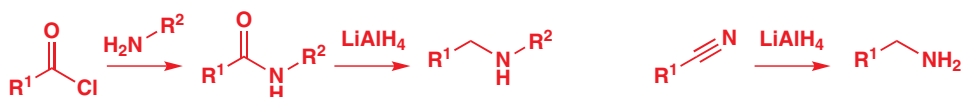

Cyanide will attack iminium ions: the Strecker synthesis of amino acids

Cyanide will react with iminium ions to form α amino nitriles. Although these compounds are relatively unimportant in their own right, a simple hydrolysis step produces α amino acids. This route to amino acids is known as the Strecker synthesis. Of course, it's not usually necessary to make the amino acids that Nature produces for us in living systems: they can be extracted from hydrolysed proteins. This Strecker synthesis is of phenylglycine, an amino acid not found in proteins. Cyanide reacts more rapidly with the iminium ion generated in the first step than it does with the starting benzaldehyde.

■ Make sure that you can write a mechanism for the hydrolysis of the nitrile to the carboxylic acid! (If you need reminding it is given in Chapter 10.)

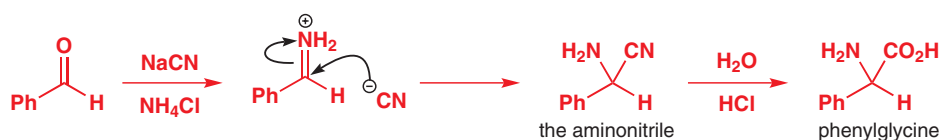

The synthesis of a spider toxin: reductive amination

This compound is the toxin used by the orb weaver spider to paralyse its prey. Notice that it has a guanidine at its right-hand end. These are stable imines,

and their powerful basicity was discussed in Chapter 8.

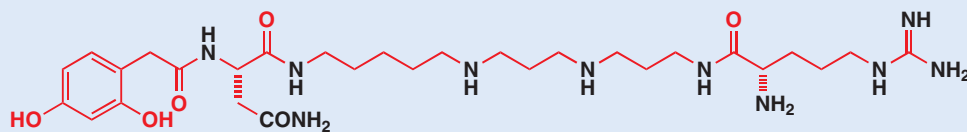

Since the spider produces only minute quantities of the compound, chemists at the University of Bath set about synthesizing it in the laboratory so that they could study its biological properties. The toxin contains several amide and

amine functional groups, and the chemists decided that the best way to make it was to link two molecules together at one of the secondary amine groups using a reductive amination.

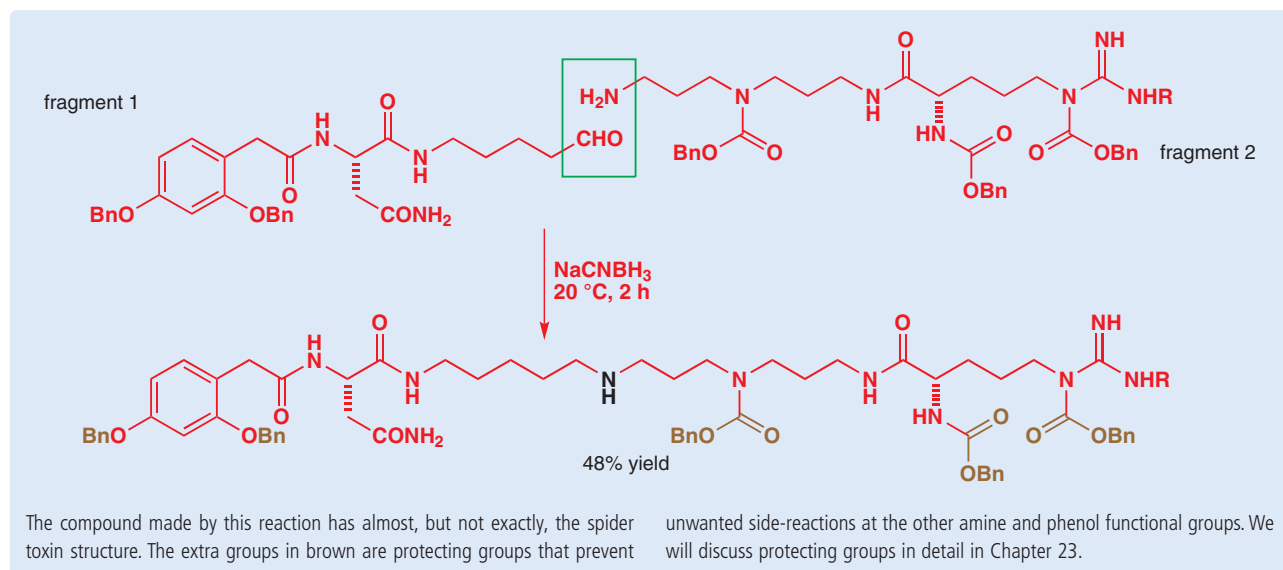

Substitution of C=O for C=C: a brief look at the Wittig reaction

Before we leave substitution reactions of carbonyl groups, there is one more reaction that we must introduce. It is an important one and we will come back to it again later in this book, particularly in Chapter 27. It also has a rather different mechanism from most you have met in recent chapters, but we talk about it here because the overall consequence of the **Wittig reaction** is the substitution of a C=C bond for a C=O bond.

We don't normally tell you the name of a reaction before even mentioning how to do it, but here we make an exception because the reagents are rather unusual and need explaining in detail. The Wittig reaction is a reaction between a carbonyl compound (aldehyde or ketone only) and a species known as a **phosphonium ylid**. An ylid (or ylide) is a species with positive and negative charges on adjacent atoms, and phosphonium ylids are made from **phosphonium** salts by deprotonating them with a strong base.

You have already met phosphonium salts in Chapter 5, where you saw the reaction of a phosphine (triphenylphosphine) with an alkyl halide (methyl iodide) to give the tetrahedral phosphonium salt.

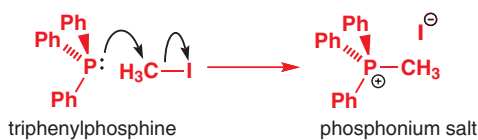

So here is a typical Wittig reaction: it starts with a phosphonium salt, which is treated with a strong base such as BuLi or sodium hydride, and then with a carbonyl compound; the alkene forms in 85% yield.

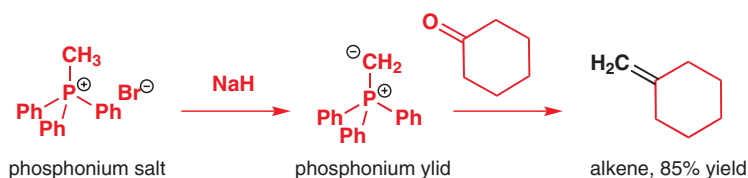

What about the mechanism? We warned you that the mechanism is rather different from all the others you have met in this chapter, but nonetheless it begins with attack on the

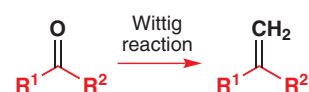

The Wittig reaction is named after its discoverer, the Nobel Prize winner Georg Wittig (1897–1987; Nobel Prize 1979).

■ The positively charged P atom stabilizes the negative charge on carbon, making phosphonium salts another class of 'carbon acids' (to add to those you met in Chapter 8) that can be deprotonated by strong base. The hydride ion H⁻ is the conjugate base of H₂ which has a pK_a of about 35.

carbonyl group by a nucleophile; the nucleophile is the carbanion part of the phosphonium ylid. This reaction generates a negatively charged oxygen that attacks the positively charged phosphorus and gives a four-membered ring called an oxaphosphetane.

formation of the four-membered ring

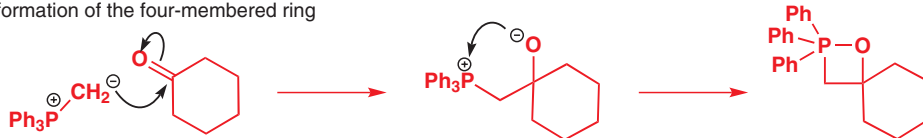

Now, this four-membered ring (like many others) is unstable, and it can collapse in a way that forms two double bonds. Here are the curly arrows: the mechanism is cyclic and gives the alkene, which is the product of the reaction along with a phosphine oxide.

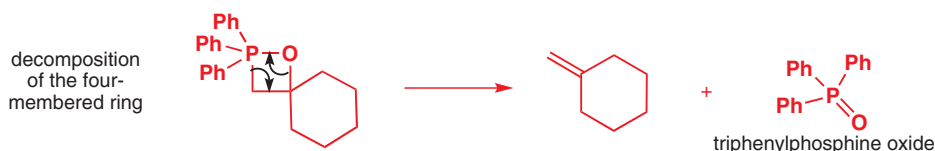

 Interactive mechanism for the Wittig reaction

➡ We will look at the Wittig reaction again in more detail in Chapter 27.

The chemistry of some elements is dominated by one particular property, and a theme running right through the chemistry of phosphorus is its exceptional affinity for oxygen. The P=O bond, with its bond energy of 575 kJ mol^{-1} , is one of the strongest double bonds in chemistry, and the Wittig reaction is irreversible and is driven forward by the formation of this P=O bond. No need here for the careful control of an equilibrium necessary when making acetals or imines.

Summary

In this chapter, as in Chapter 10, you have met a wide variety of reactions, but we hope you have again been able to see that they are all related mechanistically. Of course, we have not been exhaustive: it would be impossible to cover every possible reaction of a carbonyl group, but having read Chapters 6, 9, and 10 you should feel confident in writing a *reasonable mechanism* for any reaction involving nucleophilic attack on a carbonyl group. You could try thinking about this, for example.

■ Hint. Consider sulfur's location in the periodic table.

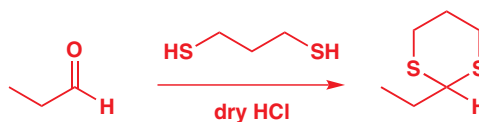

In the next chapter we examine in a little more detail the phrase 'a reasonable mechanism': how do we know what mechanisms are reasonable, and what can we do to understand them? We shall look in more detail at some of the topics raised in this chapter, such as equilibria and rates of reactions. Carbonyl groups next star in Chapter 20 where they reveal a thus far hidden *nucleophilic* side to their character.

Further reading

Section 3, 'Nucleophilic substitution to the carbonyl group with complete removal of carbonyl oxygen', in S. Warren, *Chemistry of the Carbonyl Group*, Wiley, Chichester, 1974.

Check your understanding



To check that you have mastered the concepts presented in this chapter, attempt the problems that are available in the book's Online Resource Centre at <http://www.oxfordtextbooks.co.uk/orc/clayden2e/>

12

Equilibria, rates, and mechanisms

Connections

➔ Building on

- Structure of molecules [ch4](#)
- Drawing mechanisms [ch5](#)
- Nucleophilic attack on carbonyl groups [ch6 & ch9](#)
- Acidity and pK_a [ch8](#)
- Substitutions at carbonyl groups [ch11 & ch12](#)

Arriving at

- What controls equilibria
- Free energy, enthalpy, and entropy
- What controls the rates of reactions
- Intermediates and transition states
- How catalysts work
- Effects of temperature on reactions
- Why the solvent matters
- Rate equations and their link to mechanism

➔ Looking forward to

- Substitution reactions at saturated C [ch15](#)
- Conformational equilibria [ch16](#)
- Elimination reactions [ch17](#)
- How mechanisms are discovered [ch39](#)

'One could no longer just mix things; sophistication in physical chemistry was the base from which all chemists—including the organic—must start.'
Christopher Ingold (1893–1970). Ingold uncovered many of the mechanisms we now take for granted in organic chemistry.

If you go into a chemistry laboratory, you will see some reactions being heated in boiling solvent (perhaps 80 to 120 °C), and you will see others being performed at maybe –80 °C or below. Some reactions are over in a few minutes; others are left for hours. In some reactions the amounts of reagents are critical; in others large excesses are used. Some reactions use water as a solvent; in others it must be rigorously excluded, and perhaps toluene, ether, ethanol, or DMF is essential for the success of the reaction. Why such a diverse range of conditions? How can conditions be chosen to favour the reaction we want? To explain all this we will need to work through some thermodynamic principles. We will take a practical, visual approach to the topic, and we will avoid detailed algebraic discussion: for that you are welcome to turn to a textbook of physical chemistry—there are some suggestions at the end of this chapter. In fact, we will use only two algebraic equations. Both are so important that you should memorize them; the second in particular can be extremely valuable when we think about how to get reactions to work.

How far and how fast?

In previous chapters we have said things about the *reversibility of reactions*:

'Cyanohydrin formation is reversible: just dissolving a cyanohydrin in water can give back the aldehyde or ketone you started with' (Chapter 6); 'HCl transfers its proton almost completely to water, and is a strong acid. But the transfer of protons to water from carboxylic acids is only partial' (Chapter 8); 'This step is irreversible because SO₂ and HCl are gases that are lost from the reaction mixture' (Chapter 10); 'The tetrahedral intermediate can collapse either way, giving back ester or going forward to acid plus alcohol.' (Chapter 10);

Online support. The icon  in the margin indicates that accompanying interactive resources are provided online to help your understanding: just type www.chemtube3d.com/clayden/123 into your browser, replacing **123** with the number of the page where you see the icon. For pages linking to more than one resource, type **123-1, 123-2** etc. (replacing **123** with the page number) for access to successive links.

about the *relative stability* of different compounds:

‘The most important factor in the strength of an acid is the stability of the conjugate base’ (Chapter 8); ‘F⁻ is much more stable than CH₃⁻ because fluorine is much more electronegative than carbon’ (Chapter 8); ‘Oximes are more stable than imines because the electronegative substituent can participate in delocalization of the imine double bond’ (Chapter 11);

and about the *rate of reactions*:

‘Benzaldehyde is reduced about 400 times faster than acetophenone in isopropanol’ (Chapter 6); ‘While amines react with acetic anhydride quite rapidly at room temperature (reaction complete in a few hours), alcohols react extremely slowly in the absence of a base’ (Chapter 10); ‘Secondary and tertiary amides are difficult to hydrolyse but a similar mechanism is successful with only a little water and plenty of a strong base’ (Chapter 10); ‘Acyclic hemiacetals form relatively slowly from an aldehyde or ketone plus an alcohol, but their rate of formation is greatly increased either by acid or by base’ (Chapter 11).

We are now going to consider in detail why some reactions can run forwards or backwards, why some form products irreversibly, why some reach an equilibrium, why some reactions go fast and some go slow, and what stability has to do with all of this. Understanding these factors will allow you to make the reactions you want to happen go faster and the reactions you don’t want to happen go slower, giving you a product in a useful yield. We shall be breaking reaction mechanisms down into steps and working out which step is the most important. But first we must consider what we really mean by the ‘stability’ of molecules and what determines how much of one substance you get when it is in equilibrium with another.

Stability and energy levels

So far we have been rather vague about the term ‘stability’, just saying things like ‘this compound is more stable than that compound’. What we really mean is that this compound has **less energy** than that one. For example, as you know from Chapters 4 and 7 alkenes can come in two forms we can call *cis* and *trans*. In general *trans*-alkenes are more stable than *cis*-alkenes. How do we know? Well, we can convert both *cis*- and *trans*-butene to the same alkane, butane, by adding a molecule of hydrogen. Energy is given out during the reaction, and if we measure how much energy we get from hydrogenation of *trans*-butene and compare it with the amount we get from *cis*-butene, we find that the *cis*-alkene give us about 2 kJ mol⁻¹ more. *Cis*-butene is higher in energy, and must therefore be less stable. We can represent this in the energy profile diagram on the right. The two red lines show the energies of the molecules, and the black arrows the amount of energy released when hydrogen is added.

This comparison of energy is most interesting when two compounds can interconvert. For example, as you saw in Chapter 7, rotation about the C–N bond of an amide is slow because delocalization of the N lone pair gives it some double-bond character.

The C–N bond can rotate, but the rotation is slow and can be measured by NMR spectroscopy. We might expect to find two forms of an amide of the type RNH–COR: one with the two R groups *trans* to one another, and one with them *cis*. Depending on the size of R we should expect one form to be more stable than the other and we can represent this on an energy profile diagram showing the relationship between the two molecules in energy terms.

➔ We looked at the problem of how to make ketones from esters by increasing the rate of one reaction at the expense of another in Chapter 10, p. 218.

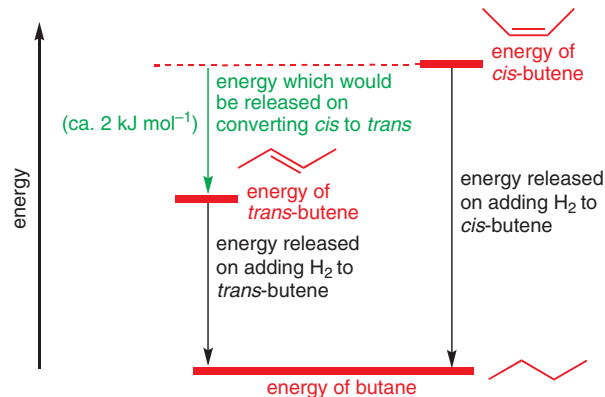

➔ We used a similar argument to compare the stabilities of benzene and cyclooctatetraene (see p. 157).

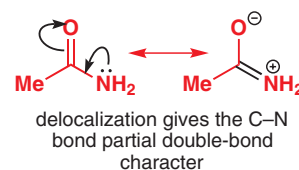

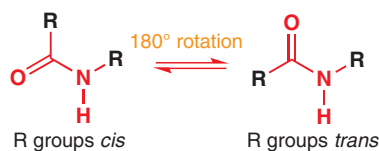

Energy profile diagram

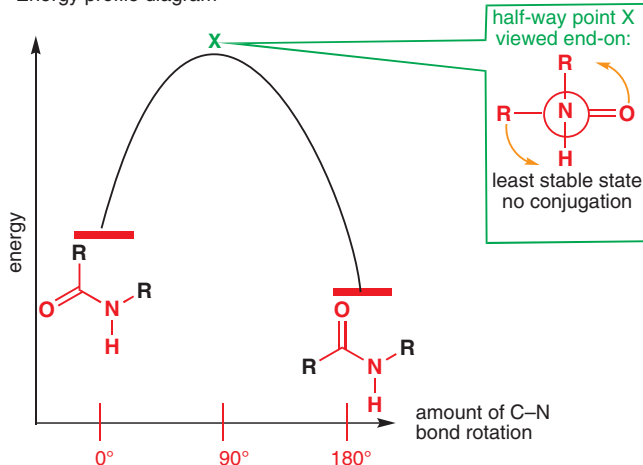

■ *Cis-* and *trans-*alkenes don't usually interconvert without catalysis. You can read more about this on p. 105.

This time there is an axis along the bottom indicating the extent of rotation about the C–N bond. The two red lines show the energies of the molecules and the curved black line shows what must happen in energy terms as the two forms interconvert. Energy goes up as the C–N bond starts to rotate and reaches a maximum at point X when rotation by 90° has removed the conjugation (the nitrogen lone pair can't delocalize into the C=O bond because it is perpendicular to the C=O π^* orbital) before falling again as the conjugation is regained.

The relative energies of the two states will depend on the nature of R. The situation we have shown, with the *cis* arrangement being much less stable than the *trans*, would apply to large R groups. We can define an equilibrium constant K for this process. For large R groups, K will be very large:

$$K = \frac{[\text{amide with R groups } \textit{trans}]}{[\text{amide with R groups } \textit{cis}]}$$

At the other extreme is the case when both substituents on nitrogen are H. Then the two arrangements would have equal energies. The process which interconverts the structures is the same but there is now no difference between them. If you could measure an equilibrium constant, it would now be exactly $K = 1$.

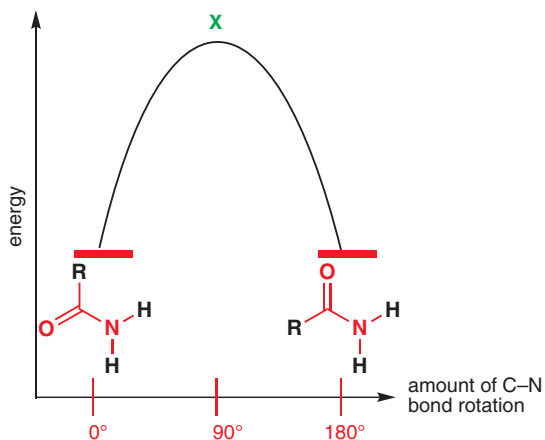

In more general terms, amide rotation is a simple example of an equilibrium reaction. If we replace 'amount of C–N bond rotation' with 'reaction coordinate' we have a picture of a typical reaction in which reagents and products are in equilibrium.

How the equilibrium constant varies with the difference in energy between reactants and products

You saw that when the energies of the two forms of the amide were the same, the equilibrium constant for their interconversion must be $K = 1$. When one was higher in energy than the other, we just said that K was 'large'. But we can be more specific. For any reaction in equilibrium, the equilibrium constant K is related to the difference in energy between the starting materials and the products by the following equation:

$$\Delta G = -RT \ln K$$

where ΔG (the **free energy** of the reaction) is the difference in energy between the two states (in kJ mol^{-1}), T is the temperature (in kelvin, not $^{\circ}\text{C}$), and R is a constant known as the **gas constant** and equal to $8.314 \text{ J K}^{-1} \text{ mol}^{-1}$.

This equation tells us that we can work out the **equilibrium composition** (how much of each component there is at equilibrium) provided we know the difference in energy between the products and reactants.

An example: hydration of an aldehyde

In Chapter 6 we showed you that water adds reversibly to the carbonyl group of an aldehyde: the aldehyde and the hydrate are in equilibrium. Here's the example with isobutyraldehyde (2-methylpropanal). The equilibrium constant is the concentration of hydrate at equilibrium divided by the concentration of aldehyde, also at equilibrium.

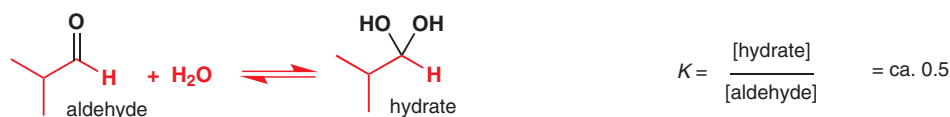

The concentrations of hydrate and aldehyde at equilibrium in water may be determined by measuring the UV absorption of known concentrations of aldehyde in water and comparing these with the absorptions in a solvent such as cyclohexane where no hydrate formation is possible. Such experiments reveal that the equilibrium constant for this reaction in water at 25°C is approximately 0.5 so that there is about twice as much aldehyde as hydrate in the equilibrium mixture.

Using the equation above, we find that the corresponding value for ΔG is $-8.314 \times 298 \times \ln(0.5) = +1.7 \text{ kJ mol}^{-1}$. In other words, the solution of the hydrate in water is 1.7 kJ mol^{-1} higher in energy than the solution of the aldehyde in water. All this can be shown on an energy profile diagram.

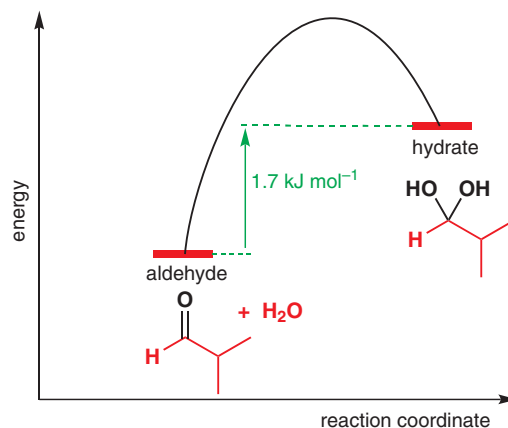

The sign of ΔG tells us whether products or reactants are favoured at equilibrium

In the equilibrium above, the hydrate is higher in energy than the aldehyde: at equilibrium there is more aldehyde than hydrate, and the equilibrium constant is therefore less than 1. Whenever this is the case (i.e. the equilibrium lies to the side of the reactants, rather than the

■ The *reaction coordinate* is simply an arbitrary measure of the progress of a molecule of starting material as it turns into a molecule of product. You will see it in several diagrams in this chapter.

This relationship was derived by the American physical chemist J. Willard Gibbs in the 1870s.

■ Although water is involved in the reaction, you saw on p. 169 that the concentration of neat water effectively remains constant at 55.5 mol dm^{-3} and is usually not included in the equilibrium constant.

■ The *reaction coordinate* is an arbitrary scale used for diagrammatic purposes only.

■ The sign of ΔG for a reaction tells us whether the starting materials or products are favoured at equilibrium, but it tells us nothing about how long it will take before equilibrium is reached. The reaction could take hundreds of years! This will be dealt with later.

products) K will be less than 1. This means that its logarithm must be negative and, because $\Delta G = -RT \ln K$, ΔG must be positive. Conversely, for a reaction in which products are favoured over reactants, K must be greater than 1, its logarithm will be positive, and hence ΔG must be negative. When K is exactly 1, since $\ln 1 = 0$, ΔG will be zero.

● **ΔG tells us about the position of equilibrium.**

- If ΔG for a reaction is negative, the products will be favoured at equilibrium.
- If ΔG for a reaction is positive, the reactants will be favoured at equilibrium.
- If ΔG for a reaction is zero, the equilibrium constant for the reaction will be 1.

A small change in ΔG makes a big difference in K

The tiny difference in energy between the hydrate and the aldehyde (1.7 kJ mol^{-1} is small: the strength of a typical C–C bond is about 350 kJ mol^{-1}) gave an appreciable difference in the equilibrium composition. This is because of the logarithm term in the equation $\Delta G = -RT \ln K$: relatively small energy differences have a very large effect on K . The table below shows the equilibrium constants, K , that correspond to energy differences, ΔG , between 0 and 50 kJ mol^{-1} . These are relatively small energy differences, but the equilibrium constants change by enormous amounts.

Energies in older or American books are sometimes quoted in kcal (kilocalories) mol^{-1} . $1 \text{ kcal} = 4.184 \text{ kJ}$. The ‘calories’ counted by nutritionists are in fact kilocalories; the typical energy output of a human adult is $10,000 \text{ kJ}$ per day.

Variation of K with ΔG

$\Delta G, \text{ kJ mol}^{-1}$	K	% of more stable state at equilibrium
0	1.0	50
1	1.5	60
2	2.2	69
3	3.5	77
4	5.0	83
5	7.5	88
10	57	98
15	430	99.8
20	3200	99.97
50	580 000 000	99.999998

In a typical chemical reaction, ‘driving an equilibrium over to products’ might mean getting, say, 98% of the products and only 2% of starting materials. You can see in the table that this requires an equilibrium constant of just over 50 and an energy difference of only 10 kJ mol^{-1} . This small energy difference is quite enough—after all, a yield of 98% is rather good!

How to make the equilibrium favour the product you want

The direct formation of esters

The formation and hydrolysis of esters was discussed in Chapter 10 where we established that acid and ester are in equilibrium and that the equilibrium constant is about 1. Since the position of the equilibrium favours neither the starting materials nor the products, how can we manipulate the conditions of the reaction if we actually want to make 100% ester?

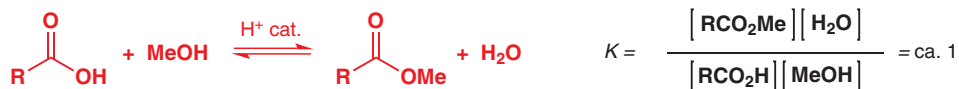

The important point is that, at any one particular temperature, the equilibrium constant is just that—*constant*. This gives us a means of forcing the equilibrium to favour the products (or reactants) since the ratio between them must remain constant. Imagine what happens if we add more methanol to the reaction above. $[\text{MeOH}]$ increases, but the overall value of K has to stay the same. The only way this can happen is if more of the ester converts to the acid. Alternatively, imagine removing water from the equilibrium. $[\text{H}_2\text{O}]$ goes down, so to bring K back to the value of 1, the concentrations of acid and methanol are going to have to go down too, by converting themselves to ester and water.

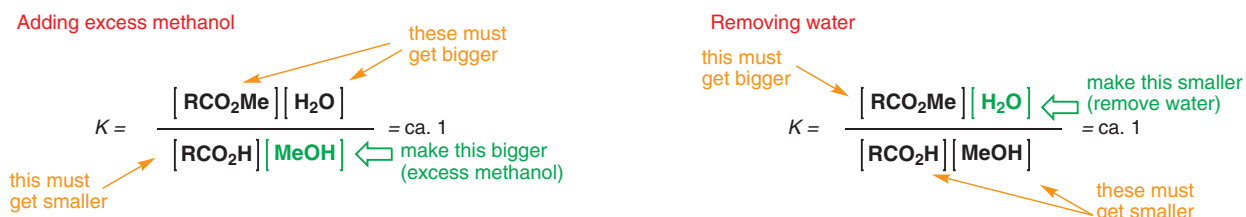

This is exactly how the equilibrium is manipulated in practice. One way to make esters in the laboratory is to use a large excess of the alcohol and remove water continually from the system as it is formed, for example by distilling it out. This means that in the equilibrium mixture there is a tiny quantity of water, lots of the ester, lots of the alcohol, and very little of the carboxylic acid; in other words, we have converted the carboxylic acid into the ester. We must still use an acid catalyst, but the acid must be anhydrous since we do not want any water present—commonly used acids are toluenesulfonic acid (tosic acid, TsOH), concentrated sulfuric acid (H_2SO_4), or gaseous HCl. The acid catalyst does not alter the position of the equilibrium; it simply speeds up the rate of the reaction, allowing equilibrium to be reached more quickly. This is an important point that we will come back to shortly.

➔ There is more on TsOH on p. 227.

Typical method for making an ester

Reflux the carboxylic acid with an excess of the alcohol (or the alcohol with an excess of the carboxylic acid) with about 3–5% of a mineral acid (usually HCl or H_2SO_4) as a catalyst and distil out the water that is formed in the reaction. For example, butanol was heated under reflux with a fourfold excess of acetic acid and a catalytic amount of concentrated H_2SO_4 to give butyl acetate in a yield of 70%.

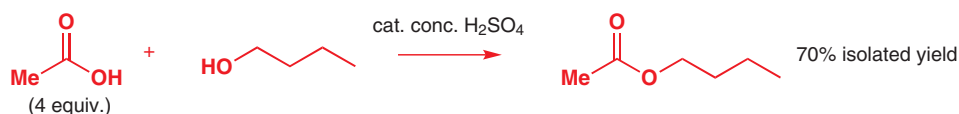

It may also help to distil out the water that is formed in the reaction: diethyl adipate (the diethyl ester of hexanedioic acid) can be made in toluene solution using a sixfold excess of ethanol, concentrated H_2SO_4 as catalyst, heating in toluene, and distilling out the water using a Dean Stark apparatus. You can tell from the yield that the equilibrium is very favourable.

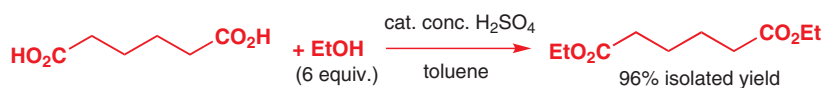

In these cases the equilibrium is made more favourable by using an excess of reagents and/or removing one of the products. The equilibrium *constant* remains the same.

■ 'Reflux' means boil underneath a condenser, so that the boiling solvent constantly runs back into the reaction and is not lost.

➔ The Dean Stark apparatus for removing water from a refluxing mixture is described on p. 228.

■ The high temperatures and acid catalysis are used to speed up *arrival* at equilibrium, which would otherwise take several days. This aspect of reactivity—the rate of the reaction, rather than the position of the equilibrium—will be dealt with shortly.

Typical method for hydrolysing an ester

Almost all methods for hydrolysing an ester in order to convert it back to an acid and an alcohol simply make use of excess water. Increasing $[\text{H}_2\text{O}]$ forces more acid and alcohol to form to restore the equilibrium, and in favourable situations high yields of the acid and alcohol are formed.

Entropy is important in determining equilibrium constants

The equation we introduced on p. 243 tells us that an equilibrium favours whichever of the reactants or products has lower energy. But you might reasonably ask this question: why does it just *favour* the components with lower energy? Why do you get *any* of the higher energy ones at all? For the hydration on p. 243, for example, the hydrate is 1.7 kJ mol^{-1} higher in energy than the starting aldehyde, so why does the aldehyde react at all? Surely the equilibrium would attain a lower energy state, not with just an excess of aldehyde over hydrate, but with no hydrate at all?

■ That equation again:

$$\Delta G = -RT \ln K$$

The answer is due to *entropy*, a measure of disorder. Even when there is a difference in energy between the starting materials and products in an equilibrium, you still get *some* of the less stable components. Put simply, having a mixture of components is favourable because a mixture has higher entropy than a pure compound, and equilibria tend to maximize overall entropy. This may be quite a new concept to you, so we will now work our way stepwise through these ideas.

Energy, enthalpy, and entropy: ΔG , ΔH , and ΔS

The equation in the margin just above tells us that the sign and magnitude of the energy ΔG are the only things that matter in deciding whether an equilibrium goes in one direction or another. If ΔG is negative the equilibrium will favour the products and if ΔG is large and negative the reaction can go to completion. The table on p. 244 tells us that it is enough for ΔG to be only about -10 kJ mol^{-1} to get complete reaction. But we haven't yet considered what ΔG actually corresponds to *physically*.

To do this we need to introduce our second equation. The free energy of a reaction, ΔG , is related to two other quantities, the enthalpy of reaction, ΔH , and the entropy of reaction, ΔS , by the equation:

$$\Delta G = \Delta H - T\Delta S$$

■ If you are interested in the derivation of this equation, which is an expression of the second law of thermodynamics, you will need to consult a textbook of physical chemistry. But you will be able to follow the explanations below without knowing the background to the equation.

As before, T is the temperature of the reaction in kelvin. Enthalpy, H , is a measure of heat, and the change in enthalpy, ΔH , in a chemical reaction is the **heat given out or taken up** in that reaction. Reactions which give out heat are called *exothermic*, and have negative ΔH ; reactions which take in heat are called *endothermic* and have positive ΔH . Since breaking bonds requires energy and making bonds liberates energy, the enthalpy change gives an indication of whether the products have more stable bonds than the starting materials or not.

Entropy, S , is a measure of the **disorder in the system**, so ΔS represents the entropy difference—the change in disorder—between the starting materials and the products. More disorder gives a positive ΔS ; less disorder a negative ΔS .

So ΔG represents a combination of heat and disorder. But what does this mean for you as a chemist wanting to get a reaction to work the way you want it to? We know that for a favourable change (i.e. an equilibrium favouring products) ΔG must be negative—in fact the more negative the better, as this gives a larger equilibrium constant. Since $\Delta G = \Delta H - T\Delta S$, we get a large, negative ΔG most readily if:

1. ΔH is negative, i.e. the reaction is exothermic.

and

2. ΔS is positive (and hence $-T\Delta S$ is negative), i.e. the reaction becomes more disordered.

Of course, we can still get a negative ΔG from an endothermic reaction (i.e. from a positive ΔH) but only if the reaction products are more disordered than the starting materials; likewise a reaction which becomes more ordered as it proceeds can still be favourable, but only if it is exothermic to compensate for the loss of entropy.

Because of the factor T multiplying the entropy term, both the equilibrium constant K (which depends on ΔG) and the relative importance of the two quantities (ΔH and ΔS) will vary with temperature (entropy changes are more important at higher temperatures). We'll now look at some examples to see how this works in practice.

Enthalpy versus entropy—some examples

Entropy dominates equilibrium constants in the difference between inter- and intramolecular reactions. In Chapter 6 we explained that hemiacetal formation is often an equilibrium, with neither starting materials nor products strongly favoured. The addition of ethanol to acetaldehyde shown below on the left, for example, has an equilibrium constant not far from 1. Overall, ΔG must therefore be approximately 0 (in fact it's very slightly positive). The *enthalpy* change associated with the reaction is the result of the change in bonding: in this case, a C=O double bond becomes two C–O single bonds, and these two single bonds are marginally more stable than the C=O double bond, therefore ΔH is slightly negative. But working against this is the fact that every molecule of hemiacetal that forms consumes two molecules of starting material. Decreasing the number of molecules (and moving from a mixture of aldehyde and alcohol towards pure hemiacetal) leads to an increase in the order of the mixture—in other words a *decrease* in entropy. ΔS is negative, so the $-T\Delta S$ is positive, just about counterbalancing the small negative ΔH , and giving a slightly positive ΔG .

A mixture has more entropy than a pure substance because there are many more ways of arranging a mixture. Imagine lining up every molecule in a mole of substance and a mole of a 1:1 mixture. For the pure substance, each member of the line of molecules has to be the same. For the mixture, at every position in the line there is a choice of two alternatives, giving a huge number of possible arrangements.

intermolecular hemiacetal formation

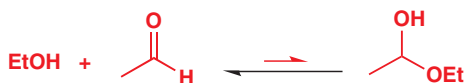

ΔH is small and negative because C=O double bond is slightly less stable than 2 x C–O single bonds

ΔS is negative because the one molecule of product is intrinsically less disordered than the two molecules of starting material

Since $\Delta G = \Delta H - T\Delta S$, ΔG is positive and the equilibrium lies to the left

intramolecular hemiacetal formation

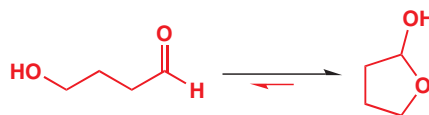

ΔH is again small and negative because C=O double bond is slightly less stable than 2 x C–O single bonds

ΔS is no longer negative: there is no decrease in the number of molecules in this reaction

Since $\Delta G = \Delta H - T\Delta S$, ΔG is negative and the equilibrium lies to the right

The reaction on the right is different because it is an *intramolecular* reaction: the hydroxyl group and aldehyde lie in the same molecule. ΔH will have essentially the same value as in the intermolecular reaction on the left, but as the intramolecular reaction progresses, one molecule stays one molecule—there is consequently a much less significant decrease in entropy. Our $T\Delta S$ term no longer weighs against the negative ΔH term, making ΔG negative overall and allowing the equilibrium to lie to the right.

In Chapter 11 we showed you how acetals can be used as base-stable protective groups to prevent nucleophiles attacking carbonyl groups. The acetals we chose to use were cyclic compounds known as dioxolanes, for a very good reason: cyclic acetals are more resistant to hydrolysis than their acyclic counterparts. They are also easier to make—they form quite readily, even from ketones. Again, we have entropic factors to thank for their stability. For the formation of an acyclic acetal (below on the left), three molecules go in and two come out, but for a cyclic one, a cyclic acetal, two molecules go in (ketone plus diol) and two molecules come out (acetal plus water), so the usually unfavourable ΔS factor is no longer against us.

acyclic acetal formation



cyclic acetal formation

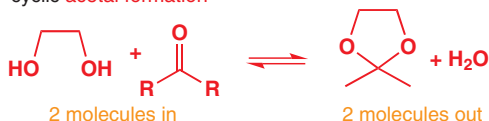

➔ Look back at p. 227 to remind yourself of this.

Overcoming entropy: orthoesters

There is a neat way of sidestepping the entropic problem associated with making acyclic acetals: we can use an *orthoester* as a source of alcohol. Orthoesters can be viewed as the ‘acetals of esters’, which are hydrolysed by water, when catalysed by acid, to an ordinary ester and two molecules of alcohol.

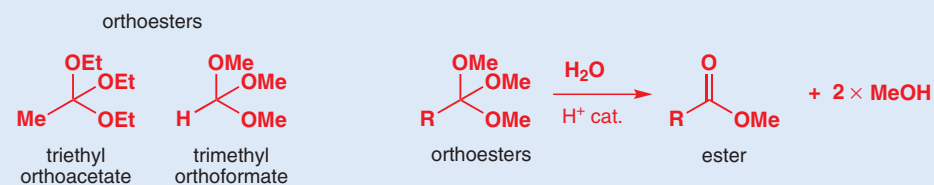

Here is the mechanism for the hydrolysis—you should be feeling quite familiar with this sort of thing by now.

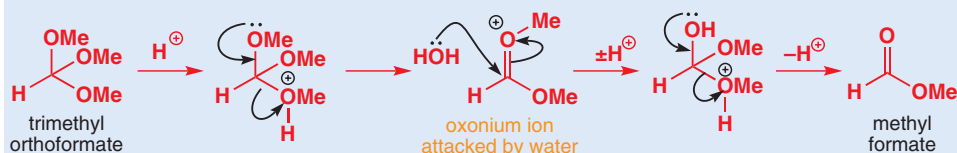

Ketones or aldehydes undergo acetal exchange with orthoesters. The mechanism starts off as if the orthoester is going to hydrolyse but the alcohol released adds to the ketone and acetal formation begins. The water produced is taken out of the equilibrium by hydrolysis of the orthoester, and we get two molecules from two: entropy is no longer our enemy.

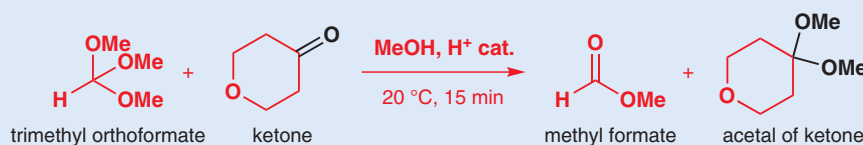

Equilibrium constants vary with temperature

We have said (p. 245) that the equilibrium constant is a constant only as long as the temperature does not change. We can work out exactly how the equilibrium constant varies with temperature by putting our two all-important equations $\Delta G = -RT \ln K$ and $\Delta G = \Delta H - T\Delta S$ together to make

$$-RT \ln K = \Delta H - T\Delta S$$

If we divide throughout by $-RT$ we have

$$\ln K = -\frac{\Delta H}{RT} + \frac{\Delta S}{R}$$

This equation separates the equilibrium constant K into enthalpy and entropy terms, but it is the enthalpy term that determines how K varies with temperature. Plotting $\ln K$ against $1/T$ would give us a straight line with slope $-\Delta H/R$ and intercept $\Delta S/R$. Since T (the temperature in kelvin) is always positive, whether the slope is positive or negative depends on the sign of ΔH : if ΔH is negative then, as temperature increases, $\ln K$ (and hence K) increases. In other words, if the reaction is exothermic (that is, gives out heat) then at higher temperatures the equilibrium constant will be smaller. For an endothermic reaction, as the temperature is increased, the equilibrium constant increases.

Some reactions are reversible on heating: cracking

Notice that the equation above also tells us that enthalpy becomes a less important contributor to the equilibrium constant as temperature increases, so the higher the temperature, the more important is the entropy term. This fact means that some reactions favour one side of the equilibrium at low temperature but the other at high temperature. Here is an example: the dimerization of cyclopentadiene. You will meet the mechanism of this reaction in Chapter 34, but for

now we can just treat it as a simple dimerization reaction in which two C=C π bonds are replaced by two C–C σ bonds—enthalpically a very favourable process because σ bonds are stronger than π bonds. On standing at low temperature, cyclopentadiene converts to the dimer even though two monomer molecules have more entropy than one molecule of the dimer.

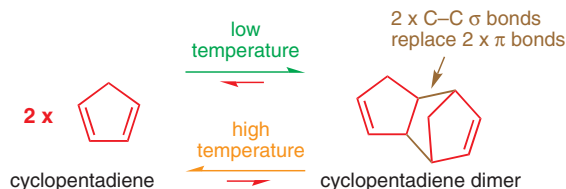

But on heating, the dimer breaks down to give monomeric cyclopentadiene: the equilibrium constant now favours the starting materials. As we predicted, because the reaction is exothermic, heating it makes it less favourable. You can also think of it in terms of our earlier equation $\Delta G = \Delta H - T\Delta S$: at low temperature, the large negative ΔH term dominates, and ΔG is large and negative too. But as T increases, the positive ΔS becomes more important, and eventually $T\Delta S$ overtakes ΔH and ΔG becomes positive, and the reaction now favours starting materials.

If you want to use cyclopentadiene, you have to heat the dimer to ‘crack’ it (‘cracking’ is the term used for getting monomers from dimers or polymers). If you lazily leave the monomer overnight and plan to do your reaction tomorrow, you will return in the morning to find dimer.

This idea becomes even more pointed when we look at polymerization. Polyvinyl chloride is the familiar plastic PVC and is made by reaction of large numbers of monomeric vinyl chloride molecules. There is, of course, an enormous decrease in entropy in this reaction any polymerization will not occur above a certain temperature. Some polymers can be depolymerized at high temperatures and this can be the basis for recycling.

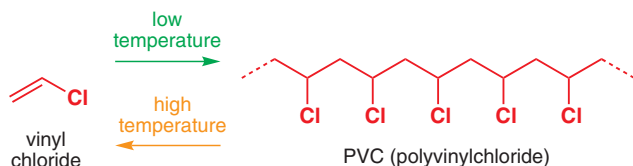

Everything decomposes at a high enough temperature eventually, giving atoms. This is because the entropy for lots of particles all mixed up is much greater than that of fewer larger particles.

● Summary: Practical points from thermodynamic theory

- The free energy change ΔG in a reaction is proportional to $\ln K$ (that is, $\Delta G = -RT \ln K$).
- ΔG and K are made up of enthalpy and entropy terms (that is, $\Delta G = \Delta H - T\Delta S$).
- The enthalpy change ΔH is the difference in stability (bond strength) of the reagents and products.
- The entropy change ΔS is the difference between the disorder of the reagents and that of the products.
- The enthalpy term alone determines how K varies with temperature.
- The entropy change come to dominate control of equilibrium as temperature is raised.

Le Châtelier's principle

You may well be familiar with a rule that helps to predict how a system at equilibrium responds to a change in external conditions—**Le Châtelier's principle**. This says that if we disturb a system at equilibrium it will respond so as to minimize the effect of the disturbance. An example of a disturbance is adding more starting material to a reaction mixture at equilibrium. What happens? More product is formed to use up this extra material. This is a consequence of the equilibrium constant being, well... constant and hardly needs anybody's principle.

Another disturbance is heating. If a reaction under equilibrium is heated, how the equilibrium changes depends on whether the reaction is exothermic or endothermic. If it is exothermic (that is, gives out heat), Le Châtelier's principle would predict that, since heat is consumed in the *reverse* reaction, more of the starting materials will be formed. Again no 'principle' is needed—this change occurs because the equilibrium constant is smaller at higher temperatures in an exothermic reaction. Avoid using principles and rules without understanding the science underneath them or you may find yourself playing with fire (which incidentally most definitely does not obey Le Châtelier's principle, for very good reasons...).

Introducing kinetics: how to make reactions go faster and cleaner

Although in chemistry laboratories you will see lots of reactions being heated, very rarely will this be to alter the equilibrium position. This is because most reactions are not carried out reversibly and so the ratio of products to reactants is not an equilibrium ratio. The main reason chemists heat up reactions is simple—it speeds them up. The study of the rates of reactions, as opposed to their equilibrium states, is known as **kinetics**.

- Thermodynamics is concerned with equilibria; kinetics is concerned with rates.

How fast do reactions go? Activation energies

The combustion of the hydrocarbon shown below, the major component of petrol (gasoline) trivially known as 'isooctane', proceeds with $\Delta G = -1000 \text{ kJ mol}^{-1}$ at 298 K.

■ 'Isooctane' is the trivial name of 2,2,4-trimethylpentane.

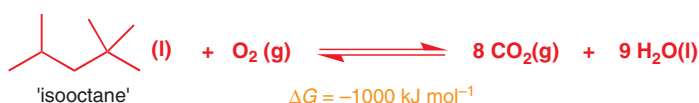

The table on p. 244 shows that even a ΔG of only -50 kJ mol^{-1} gives rise to a huge equilibrium constant: $-1000 \text{ kJ mol}^{-1}$ gives an equilibrium constant of 10^{175} (at 298 K), a number too vast to contemplate (there are 'only' about 10^{86} atoms in the observable universe). This value of ΔG (or the corresponding value for the equilibrium constant) suggests that isooctane simply could not exist in the presence of oxygen. Yet we put it into the fuel tanks of our cars every day—clearly something is wrong.

Since isooctane can exist in an atmosphere of oxygen despite the fact that the equilibrium position really would be completely on the side of the combustion products, the only conclusion we can draw must be that a mixture of isooctane and oxygen cannot be at equilibrium. A small burst of energy is needed to reach equilibrium: in a car engine, the spark plug provides this energy and combustion occurs. Without this burst of energy, the petrol is stable and no combustion occurs (as you will ruefully be aware if you have ever tried to start a car with a flat battery).

The mixture of petrol and oxygen is said to be *thermodynamically* unstable with respect to the products of the reaction, CO_2 and H_2O , but *kinetically* stable. We can be certain that they are thermodynamically unstable because even if the same small energy burst were applied to the products CO_2 and H_2O , they would never convert back to petrol and oxygen.

Kinetically stable means that although the mixture *could* convert to a more stable set of products, it doesn't do so because an energy barrier separates it from those products. An energy level diagram for a reaction such as the combustion of isooctane is shown below. The products are more stable (lower in energy) than the reactants, but to become the products, the reactants have to overcome a barrier to reaction. This barrier is called the **activation energy** and is usually given the symbol E_a or ΔG^\ddagger .

The differences between E_a and ΔG^\ddagger need not concern us here; you will find the details in a textbook of physical chemistry.

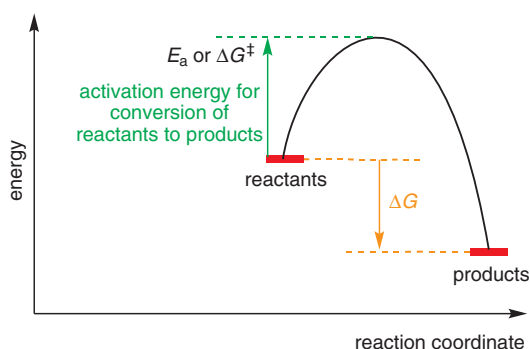

If a reaction cannot proceed until the reactants have sufficient energy to overcome the activation energy barrier, it is clear that, the smaller the barrier, the easier it will be for the reaction to proceed. Likewise, the more energy we give the starting materials in the form of temperature, the more likely it is that they will collide with sufficient combined energy to cross the activation energy barrier. Unlike equilibria, which can change in either direction, reaction rates *always* increase at higher temperatures.

A word of warning, however: heating is not all good for the chemist—not only does it speed up the reaction we want, it will also probably speed up lots of other reactions that we don't want, including perhaps decomposition of the product! We shall see how we can get round this, but first we shall take a closer look at what determines how fast a reaction takes place.

The route from reactants to products: the transition state

The combustion of kinetically stable fuel releases lots of energy by a very complex mechanism. To understand how energy is involved in the progress of a reaction we will need to take a much more simple and familiar mechanism. The reduction of a ketone to an alcohol with sodium borohydride will do. You met this reaction in Chapters 5 and 6 and it should by now be a familiar part of your chemical vocabulary. An example is shown in the margin: in this particular case, the ketone is rather hindered by the adjacent *tert*-butyl group, and the reaction must be heated to form the product. Evidently, then, there is an activation barrier that must be overcome.

Let's think about what that barrier might be. Although the final product is an alcohol, as you know well, the first step is transfer of a hydrogen atom from boron to the carbonyl group, as shown in the mechanism below. Overall, as shown in the energy profile diagram, the products of this step are more stable than the starting materials (ΔG is negative), but to get there the reaction has to pass through the activation energy barrier (ΔG^\ddagger). This barrier—the highest energy point on the profile—must correspond to some structure (which we have shown in square brackets) in which the hydrogen atom is only partly transferred from B to C, and the carbonyl group is only partly broken. We call this structure—the highest energy form through which the molecules must pass to get from reactants to products—the **transition state**. It is often represented in square brackets, frequently with a double dagger symbol \ddagger (to match the activation energy ΔG^\ddagger).

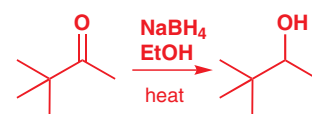

■ To draw a structure representing a transition state is easy: first put in all the bonds that are not affected by the reaction, then use dotted bonds for all those which break or form as the reaction proceeds. You will need to spread charge over appropriate atoms, putting a + or - in brackets to indicate a partial charge.

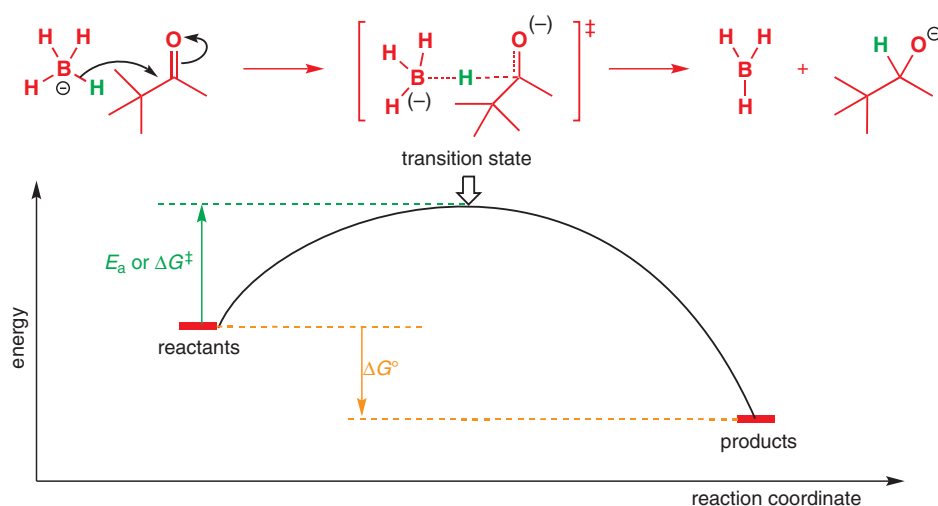

Notice that the transition state has some features of the reactants and some features of the products. The B-H bond is partly broken, so we represent it as a dotted line, and the new H-C bond is partly formed, so likewise that is dotted too, as is the breaking C=O bond. The negative charge, which starts associated with B and ends on the oxygen atom, is shown in brackets in both locations, to indicate that it is shared between them. It takes energy to get to the transition state because the H has to move away from the B without significant compensation.

Interactive mechanism for borohydride reduction

Conventionally, charges in brackets indicate a significant proportion, usually about 1/2, of a charge, unlike 'δ+' or 'δ-', which might represent only 1/10 or 1/5 of a charge.

But once the transition state is passed, the formation of a stable C–H bond and the migration of a charge to electronegative oxygen means that stability is regained.

A transition state is always unstable and can never be isolated: if the reaction proceeds just a little more forwards or backwards, the energy of the system is lower. Isolating a transition state would be like balancing a marble on top of a bowling ball.

● Transition state

A transition state is a structure that represents an energy maximum on passing from reactants to products. It is not a real molecule in that it may have partially formed or broken bonds and may have more atoms or groups around the central atom than allowed by valence bond rules. It cannot be isolated because it is an energy maximum and any change in its structure leads to a more stable arrangement. A transition state is often shown by putting it in square brackets with a double-dagger superscript.

Why some reactions are done at low temperature

So far in this chapter you have seen that while heating a reaction can change the position of an equilibrium, the usual reason for heating a reaction is to speed it up by giving the reactants more energy to allow them to overcome the activation barrier. But as we said in the introduction, in a typical laboratory you will see many reactions being carried out at low temperatures. Why might a chemist want to *slow a reaction down*?

Well, often molecules can react in several different ways. A good reaction will have a lower activation energy than these alternatives. But often there are other unavoidable reactions waiting in the wings that will compete with the one that is wanted if the molecules have enough energy. The ideal situation is to give the starting materials enough energy to do the reaction we want, but not enough to do anything else: and that means keeping the reaction cold.

A famous example of a reaction which must be kept cold is the diazotization of anilines to make diazonium salts. The reaction involves treating the amine with nitrous acid (HONO) made from NaNO_2 and HCl. You need not think about the mechanism at this stage—you will meet it in Chapter 22—but the key point is that the product is a rather unstable but very useful diazonium salt. The diazotization takes place readily at room temperature, but unfortunately so does the decomposition of the product to give a phenol. By lowering the temperature, we supply insufficient energy for the phenol formation, but the diazotization still works just fine.

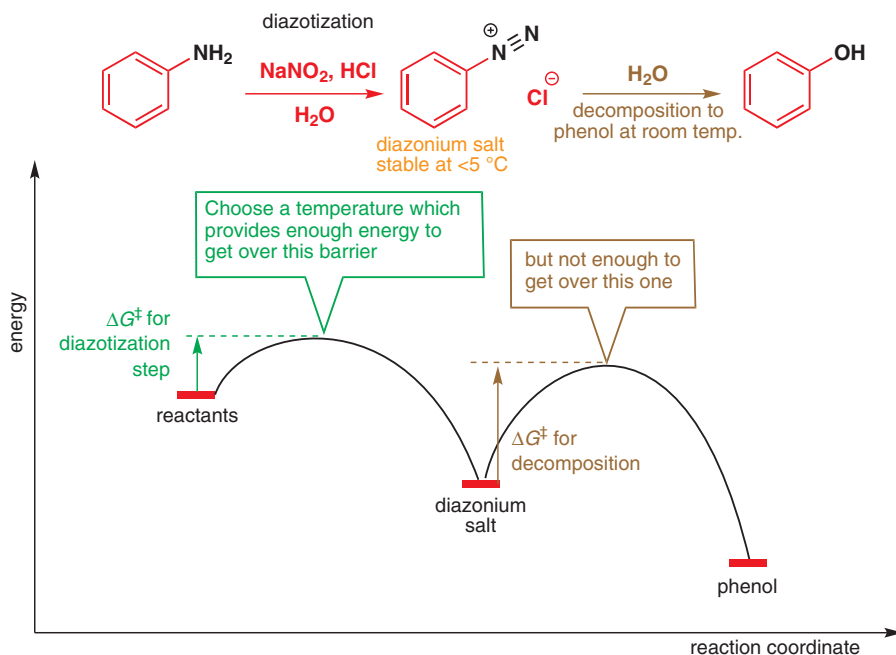

The use of organolithiums (which you saw in Chapter 9) typically involves low temperatures, often as low as $-78\text{ }^{\circ}\text{C}$. Organolithiums are very reactive, and the addition or deprotonation reactions they undergo have activation energies sufficiently low that they proceed even at such temperatures. However, they do also have a tendency to attack some of the solvents which they dissolve best in, such as THF. If lithiations are attempted at higher temperatures, THF also reacts with *s*-BuLi to give the surprising by-products discussed in Chapter 35.

Reaction intermediates

Our mechanism for reduction of the ketone with borohydride is of course not yet complete: there is another step to follow—the protonation of the alkoxide by the ethanol solvent. We can add this step to our energy profile diagram.

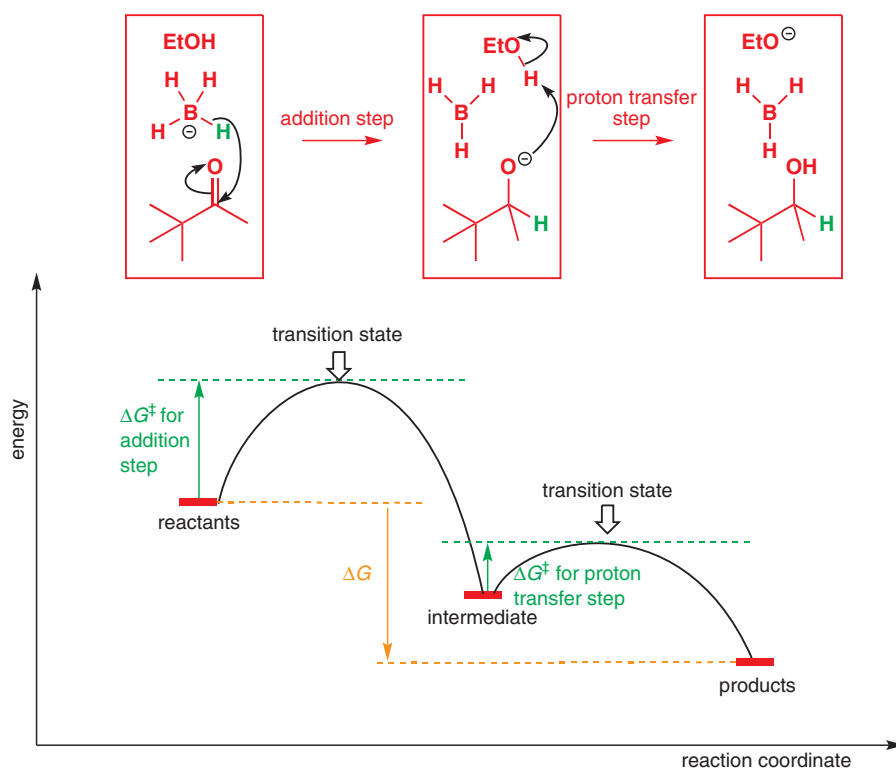

Now the product of the first stage of the reaction is the starting material for the second, which follows on straightaway because the activation energy for the second reaction, the proton transfer, is smaller than for the first one. Notice that we have now labelled the middle set of structures, which includes the alkoxide 'intermediate'. An intermediate is a staging post in a reaction pathway: it is stable for a finite (if short) period. Unlike a transition state it is a minimum rather than a maximum on the reaction energy profile, and therefore has a finite existence—an intermediate *could*, in principle, be isolated, and many have been (particularly at low temperature).

● Intermediates and transition states

- A **transition state** represents an energy maximum—any small displacement leads to a more stable product. It can never be isolated.
- An **intermediate** is a molecule or ion that represents a localized energy minimum—an energy barrier must be overcome before the intermediate forms something more stable. An intermediate can in principle be isolated (although in practice its high energy can make this difficult).

■ $-78\text{ }^{\circ}\text{C}$ is the convenient temperature of a bath of acetone containing pellets of slowly evaporating solid CO_2 .

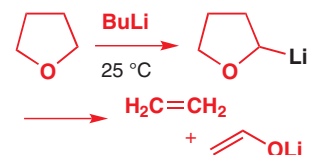

Interactive mechanism for borohydride reduction

■ You can think of the diazonium salt on p. 252 as an isolable intermediate en route to the phenol. Notice how the energy profile for that sequence matches the one here.

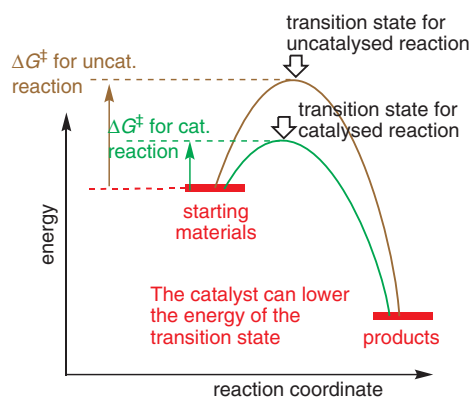

Catalysis

You've met the idea in several places in this book (and probably elsewhere) that a catalyst increases the rate of a reaction. From what you have just read, it must therefore be the case that a catalyst lowers the activation energy for a reaction. It can do this in one or both of two ways: it can lower the energy of the transition state (as shown in the diagram on the left, or it can raise the energy of the starting materials.

- Catalysts work by lowering the activation energy for a reaction.

To illustrate the point with one simple example, let's take a reaction which simply does not work without a catalyst: the isomerization of butene. As you saw on p. 105, *cis* but-2-ene is about 2 kJ mol^{-1} higher in energy than *trans* but-2-ene. This small energy difference would correspond to a 2.2:1, 70:30, *trans*:*cis* ratio of alkenes if they were in equilibrium. But it's a big *if*: the activation energy needed to get from one to the other is of the order of 260 kJ mol^{-1} , which is practically unattainable. A quick calculation predicts that the half-life for the reaction would be approximately 10^{25} years at room temperature, a time many orders of magnitude longer than the age of the universe. At 500°C , however, the half-life is a more reasonable 4 hours, but unfortunately, when most alkenes are heated to these sorts of temperatures other unwanted reactions occur.

In order to interconvert the *cis* and *trans* isomers we must use a different strategy: catalysis. You will meet several ways of doing this in Chapter 27, but for the moment we will use just one: catalytic acid. As you saw in Chapter 5, alkenes are nucleophiles, and either isomer of but-2-ene can react with H^+ from acid to form a transient species known as a carbocation. The activation energy for formation of the carbocation is much less than that for rotation about the $\text{C}=\text{C}$ bond. The carbocation can now easily lose a proton again, to reform either *cis*- or *trans*-but-2-ene, regenerating the catalyst and allowing the interconversion to take place. Overall, the activation energy is much lower than in the uncatalysed reaction. We will come back to other examples of catalysis later in the chapter.

Acid catalysed isomerization:

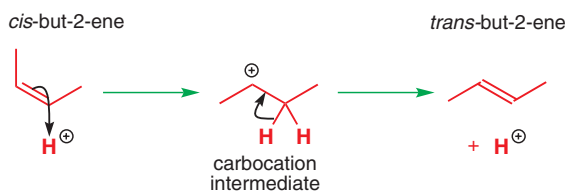

You have already seen a case in this chapter, and you met many in Chapter 9, where THF (or diethyl ether) was used as the solvent for organolithium reactions: it coordinates to Li and solubilizes the organometallic compounds. Alcohol solvents cannot be used with organolithiums because they are deprotonated by the strong organolithium bases.

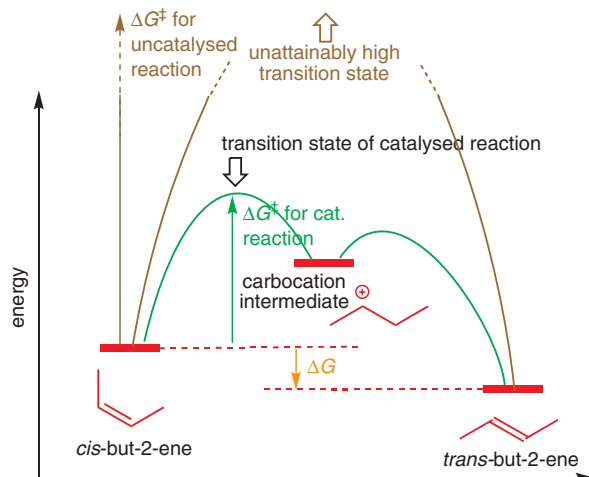

Solvents

The nature of the solvent used in reactions often has a profound effect on how the reaction proceeds. Sometimes, if the solvent is also a reagent, the choice is easy: it's a good idea to carry out hydrolyses of esters in water and formations of esters in the appropriate alcohol because

the large concentration of the solvent drives the reaction towards the product, as explained on p. 208. Likewise, the solvent may also catalyse a reaction: ester formation from an acid chloride and an alcohol is often carried out in pyridine as a solvent because pyridine acts as a base catalyst of the reaction (p. 199).

On occasions, the choice of solvent is limited by simple features of the starting materials and products, such as their solubility or reactivity. Simple examples are cases where an inorganic salt is a reagent: ionic compounds are relatively insoluble in most organic solvents. Sodium bromide, for example, dissolves well in water, reasonably well in methanol, a little in ethanol, and hardly at all in most other organic solvents.

Solubilities of sodium bromide in protic solvents

Solvent	Solubility, g/100 g of solvent
H ₂ O	90
MeOH	16
EtOH	6

The insolubility of some salts in organic solvents can be used to drive an equilibrium in the direction required. For example, in the synthesis of this alkyl iodide from the alkyl bromide by reaction with sodium iodide, acetone is used as the solvent. Why? Well, sodium iodide is rather more soluble in acetone than is sodium bromide, so as sodium bromide is removed from the equilibrium mixture, more of the starting materials have to convert to the products to restore the equilibrium constant. You will meet more on this reaction in Chapter 15.

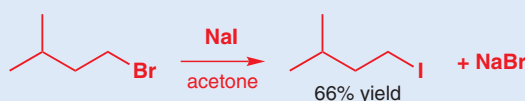

Water dissolves sodium bromide well because it solvates both cations and anions: electrostatic interactions with its δ^- oxygen atoms can stabilize the positive sodium ions, while attraction to its δ^+ hydrogen atoms can stabilize the negative bromide ion. Solvents which have polarized bonds like this are known as *polar*. Water and other alcohols are also called protic solvents because they have δ^+ protons that can interact readily with anions.

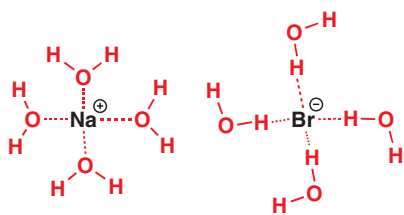

Water solvates cations and anions

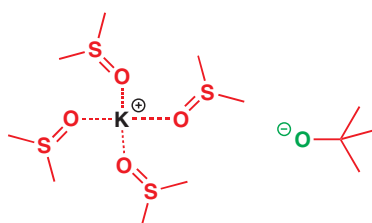

DMSO (a polar aprotic solvent) solvates only cations

Another group of polar solvents lack δ^+ protons: these are the polar aprotic solvents, such as DMSO or DMF. Although they have a localized δ^- at oxygen, which can solvate cations, they are much less good at solvating anions because their molecules do not have a localized accessible δ^+ region. In Chapter 10 (p. 213) you met a specific combination of *t*-BuOK and DMSO to help hydrolyse an amide. This is why DMSO is used here: it solvates the K^+ cation, leaving the *t*-BuO⁻ unstabilized by solvation. It is desperate to become neutral by finding a proton. Metal alkoxides in DMSO are extremely basic, and when even sodium chloride is dissolved in DMSO the usually innocuous chloride ion becomes quite a powerful nucleophile, as you will see in Chapter 25.

A third group of solvents are not polar at all, but may still dissolve organic molecules quite well. These include hydrocarbons, chlorinated solvents (chloroform), and aromatic solvents (toluene, benzene).

The table below groups common solvents in classes with shared features, and also indicates their polarity. Polarity is measured in various ways—here we give the ‘dielectric constants’—but you do not need to remember the numbers. Learning the general position of a solvent in this sequence of polarity will, however, be a wise investment of your time.

■ Alternatives for chloroform or benzene should be used where possible as there is evidence that these solvents have cancer-causing properties.

Polarity of some common solvents (dielectric constants)

Polar protic solvents		Polar aprotic solvents		Non-polar solvents	
water	80	DMSO	47	chloroform (CHCl ₃)	4.8
methanol	33	DMF	38	diethyl ether	4.3
ethanol	25	acetonitrile	38	toluene	2.4
acetic acid	6	acetone	21	benzene	2.3
		dichloromethane	9.1	cyclohexane	2.0
		tetrahydrofuran (THF)	7.5	hexane	1.9
		ethyl acetate	6.0	pentane	1.8

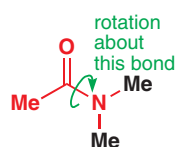

Rate constants for amide C–N bond rotation in dimethylacetamide

Solvent	ΔG^\ddagger , kJ mol ⁻¹
water	80.1
DMSO	76.5
acetone	74.5
cyclohexane	70.0

By virtue of their ability or inability to solvate charged species, solvents can affect the course of reactions by stabilizing or destabilizing a transition state or an intermediate. Here's a very simple example: the effect of solvent on one of the first 'reactions' in this chapter—the rotation about the C–N bond of an amide. The table in the margin shows the activation energy ΔG^\ddagger for C–N bond rotation in dimethylacetamide (DMA) in a range of solvents. You can immediately deduce that the rate of the rotation is fastest in the least polar solvent, cyclohexane, because the barrier is lowest. Why might this be?

To understand rates, we have to think about activation energies, in other words the difference in energy between the starting materials and the transition state. As you know, an amide in its ground state (in other words, its lowest energy state) is delocalized because of conjugation between the nitrogen's lone pair and the carbonyl group. This delocalization leads to a degree of charge separation and polarization of the amide. But as the C–N bond rotates, the conjugation is broken because the molecule has to pass through a transition state in which the N lone pair is perpendicular to the π system of the carbonyl group. The transition state is therefore less polar than the ground state.

Now, if we compare the effect on this rotation of a non-polar solvent and a polar solvent, this is what will happen. The polar ground state will be stabilized by the polar solvent, and so will be lower in energy, as you see on the right of the diagram below. But the less polar transition state will have about the same energy, whatever the polarity of the solvent. So, in a polar solvent, the amount of energy required to get from the ground state to the transition state (this is the activation energy, E_a or ΔG^\ddagger) is greater than in a non-polar solvent, and bond rotation is slower.

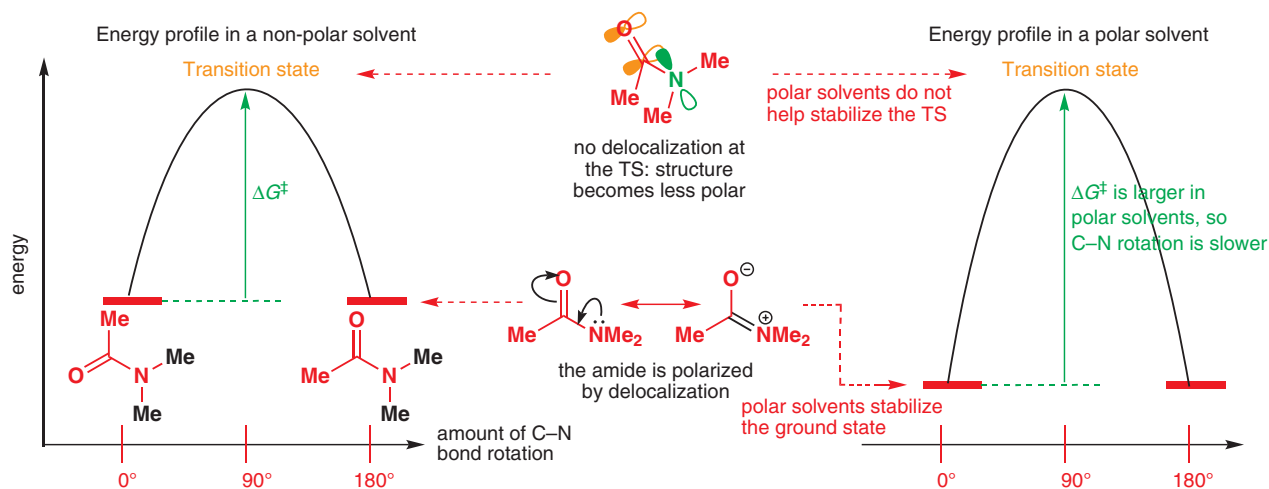

In Chapter 15 you will go on to meet a pair of mechanisms in which the polarity of the transition state is very different. You will now be prepared to expect some very significant solvent effects when such reactions take place.

● **Solvents can affect the rate of a reaction by:**

- participating as a reagent
- acting as a catalyst
- dissolving the reagents
- differentially stabilizing the ground state and transition state.

Rate equations

We've pointed out that reactions go faster at higher temperature because the starting materials have more energy. But temperature is not the sole controller of rate. Two molecules might well collide with plenty of energy, but unless they are two molecules that can actually react, that energy will be lost as heat. Going back again to the reduction of p. 251 (a reminder in the margin), it's obvious that only collisions between ketone (A) and borohydride (B) get us anywhere—there will be plenty of non-productive collisions between A and A or B and B. Obviously the chance of a collision between A and B is increased the more of each you have, and especially if you have lots of A *and* lots of B. In fact, the chance of a successful reaction is proportional to the product of the concentration of A and the concentration of B. We can express this in a simple *rate equation*:

$$\text{rate of reaction} = k \times [\text{A}] \times [\text{B}]$$

where the value k represents the *rate constant* for the reaction. The value of k is different for different reactions, and it also varies with temperature. The size of k also contains information about how likely it is that the molecules will collide with the right orientation. We call this analysis of the factors affecting the rate of the reactions the **kinetics** of the reaction.

There is of course a link between the activation energy of a reaction and its rate, and the connection between them is known as the Arrhenius equation, after the Swedish chemist Svante Arrhenius (1859–1927) who formulated it and won the Nobel Prize in 1903.

$$k = Ae^{-E_a/RT}$$

where k is the rate constant for the reaction, R is the gas constant (see p. 243), T is the temperature (in kelvin), and A is a quantity known as the pre-exponential factor. Because of the minus sign in the exponential term, the larger the activation energy, E_a , the slower the reaction but the higher the temperature, the faster the reaction.

As we discussed on p. 253, the reaction between borohydride and the ketone to make an alkoxide is only the first step of this reaction. Since ethanol likewise has to collide with the alkoxide for this second step to take place, you might very reasonably ask yourself why the rate of formation of the alcohol product does not also depend on [EtOH]: why is the rate equation not

$$\text{rate of reaction} = k \times [\text{ketone}] \times [\text{borohydride}] \times [\text{EtOH}] ?$$

The answer is hinted at in the energy profile diagram you saw on p. 253, which is reproduced below. The activation energy for the proton transfer step is lower than for the addition step, so it happens faster. In fact, it can happen fast *whatever the concentration of ethanol*, so ethanol does not appear in the rate equation. The overall rate of any reaction is determined only by what happens in the mechanistic step that is slowest, known as the **rate-determining step** or **rate-limiting step**. This is a general point about anything that happens in several

➔ We discussed the simple ideas about what must happen for a reaction to take place between two molecules at the start of Chapter 5. We're now adding more detail to those simple concepts.

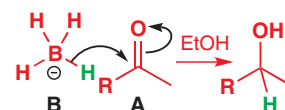

steps: if you want to empty a football stadium through a set of turnstiles, it is only the rate at which the turnstiles operate that limits the emptying speed—it doesn't matter how quickly or slowly people walk away after they are through.

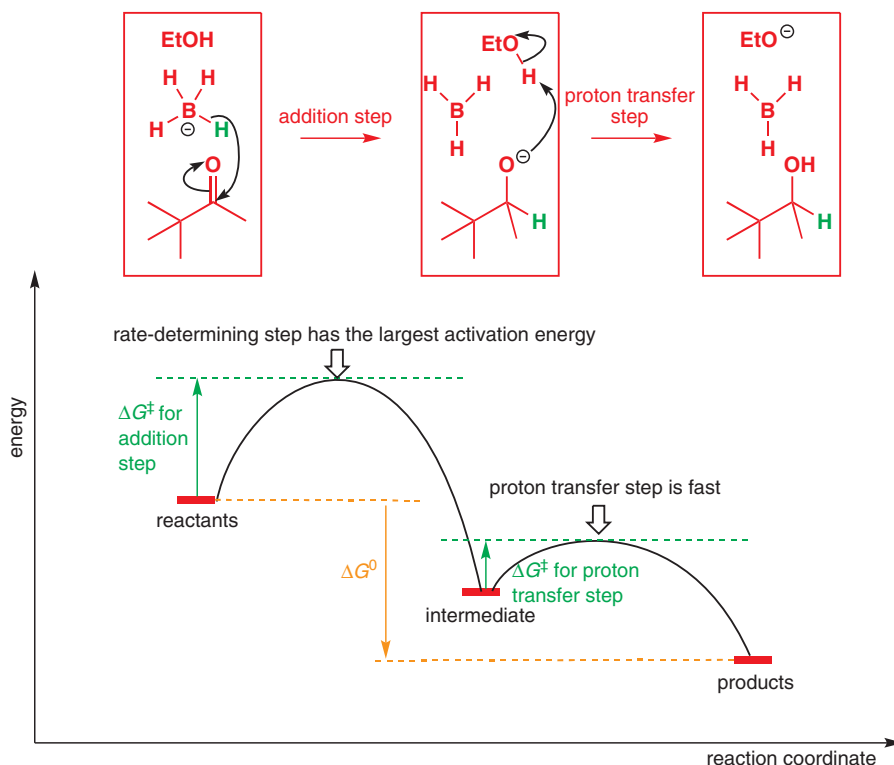

Proton transfers to or from carbon may be slow.

At several points in Chapters 6, 9, 10, and 11 we have said things like ‘don't worry about the details of the proton transfers’ and now you know why: proton transfers between N and O atoms are fast, and other steps are almost always rate determining. It doesn't really matter how you get a proton from one electronegative atom to another—in reality it will be flitting all over the place and any reasonable route is just as correct as any other.

- Proton transfers, particularly between O or N, are always fast and only rarely rate determining.

Kinetics gives us an insight into the mechanism of a reaction

In Chapters 10 and 11 you met some other multistep reactions with intermediates. Take this example: an alkoxide RO^- will react with an acid chloride to form an ester. If we measure how the rate of the formation of the ester varies with the concentration of the alkoxide and of the acid chloride, we discover a rate equation

$$\text{rate} = k[\text{MeCOCl}][\text{RO}^-]$$

Both the acid chloride and alkoxide must therefore be involved in the rate-determining step, which, as you know from Chapter 10, must be the formation of the tetrahedral intermediate. This intermediate is less stable than the starting materials, so the reaction energy profile takes the form shown below, with the highest transition state corresponding to the addition step.

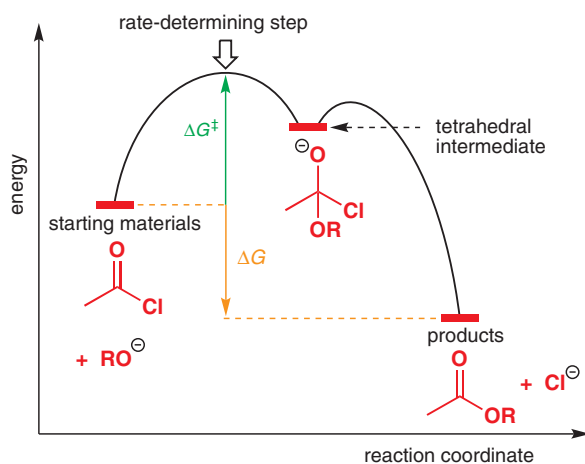

The presence of two species in the rate equation confirms that the reaction is bimolecular (i.e. it involves two molecules), and we call such rate equations *second order*.

Numerous kinetic studies have confirmed that this mechanism, with a tetrahedral intermediate, is the normal pathway by which substitution reactions at carbonyl groups take place, as we explained in Chapter 10. You could draw a similar pathway, and a similar energy profile, for all of the reactions shown on p. 215, adjusting the energies of the starting materials, products, and intermediates appropriately, but all of them are second order, with rate-limiting attack on the carbonyl group.

However, there are occasional exceptions. These are not important enough for you to consider them likely when you write substitution mechanisms, but they do illustrate the fact that *kinetics* tells us about *mechanism*.

Here is one: when an acid chloride is heated with an alcohol in the absence of base, an ester forms. However, it turns out that under these conditions the rate equation is first order: it does not matter how much or how little alcohol is added, the rate depends only on the concentration of the acid chloride:

$$\text{rate of reaction} = k[\text{R}^1\text{COCl}]$$

Evidently, from the rate equation, no collision between the acid chloride and the alcohol is required for this reaction to go. The rate-determining step must be *unimolecular*. What actually happens is that the acid chloride decomposes by itself to give a reactive cation with the loss of the good leaving group Cl^- .



■ This is not the recommended way to make an ester: the reaction is much better if a base is added, in which case it follows the usual addition–elimination mechanism.

Unusual unimolecular mechanism for ester formation

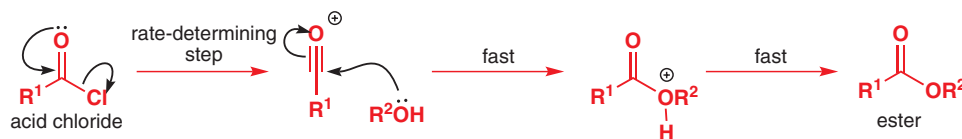

There are three steps in this reaction scheme, although the last is a trivial deprotonation. The energy barrier must be highest in the first step, which involves the acid chloride alone. The cation is an intermediate (although a short-lived one) with a real existence that reacts rapidly with the alcohol in a step that does not affect the rate of the reaction. The easiest way to picture this detail is in an energy profile diagram:

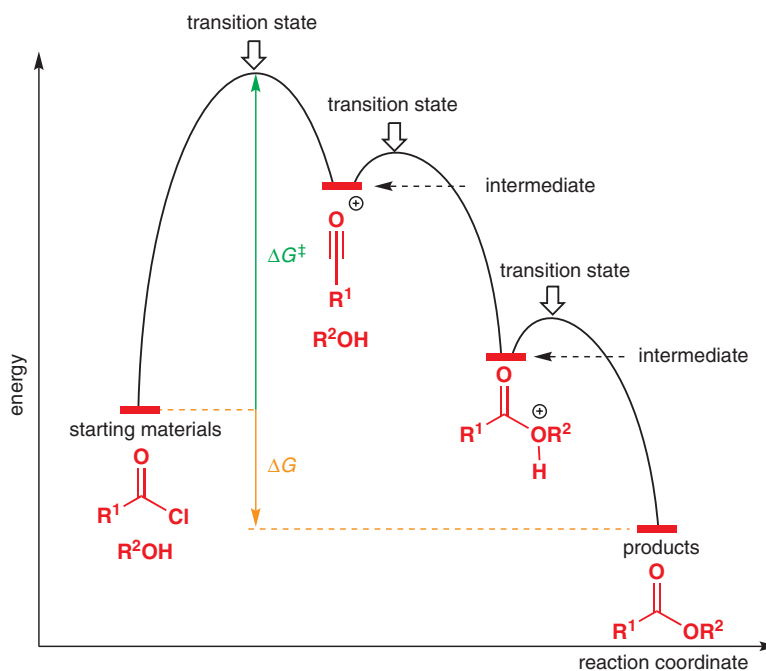

Notice that the products are again lower in energy than the starting materials, and although there are three transition states in this reaction, only the highest-energy transition state (the first one here) matters in determining the reaction rate. The reaction now passes through two intermediates (local minima). It is often the case that when intermediates are involved in a reaction, the highest-energy transition state is associated with the formation of the highest-energy intermediate.

What does third-order kinetics mean?

The first-order kinetics of this unusual substitution reaction is here to illustrate a point, but it should not distract you from the fact that most nucleophilic substitutions of carboxylic acid derivatives (the reactions you met in Chapter 10) are bimolecular reactions with rate-determining formation of the tetrahedral intermediate.

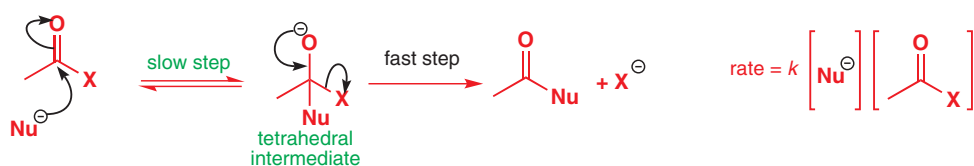

However, something different again happens when we come to reactions of amides. Because of the delocalization of the nitrogen lone pair into the carbonyl group, nucleophilic attack on the carbonyl group is very difficult. In addition, the leaving group (NH_2^- , with $\text{p}K_a$ of NH_3 about 35) is very bad indeed.

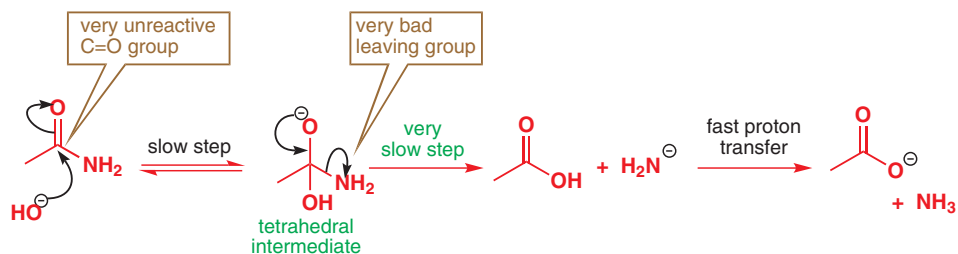

What happens as a consequence is that in the hydrolysis of amides the second step—the breakdown of the tetrahedral intermediate—becomes rate determining. But this offers the opportunity for base catalysis of this step. If a second hydroxide ion removes the proton from the tetrahedral intermediate, the loss of NH_2^- from what is now a dianion is made easier, and a stable carboxylate ion is formed directly.

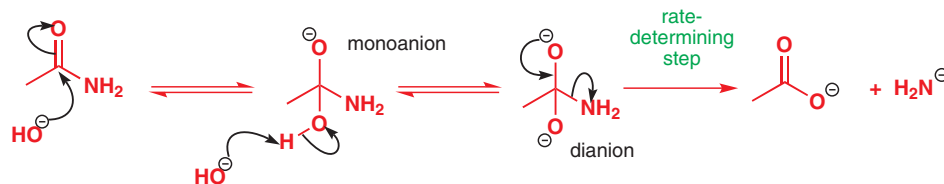

➔ In Chapter 10 (p. 213) you met a method for hydrolysing amides that exploits this second deprotonation.

Notice that in the first mechanism just one hydroxide ion is involved, whereas now two are involved: one is consumed to form product, but the second is in fact regenerated when the product NH_2^- anion reacts with water—in other words the second hydroxide ion is a catalyst.

The rate equation for the amide hydrolysis reflects this involvement of two hydroxide ions: the rate depends on the square of the hydroxide ion concentration and it is *third order*. We'll label the rate constant k_3 to emphasize this:

$$\text{rate} = k_3[\text{MeCONH}_2] \times [\text{HO}^-]^2$$

But you may be asking yourself where this third-order kinetics comes from, since the hydroxide ions are not actually involved in the rate-determining step. In fact, third-order kinetics hardly ever mean the real simultaneous termolecular collision of three molecules at once—such events are just too rare.

The rate-determining step here is actually unimolecular—the collapse of the dianion. So we expect

$$\text{rate} = k[\text{dianion}]$$

We don't know the concentration of the dianion but we do know that it's in equilibrium with the monoanion—we'll call this equilibrium constant K_2 :

$$K_2 = \frac{[\text{dianion}]}{[\text{monoanion}][\text{HO}^-]}$$

and so $[\text{dianion}] = K_2[\text{monoanion}][\text{HO}^-]$.

This sort of helps, but we still don't know what $[\text{monoanion}]$ is, other than that it's again in equilibrium, this time with the amide—we'll call this equilibrium constant K_1 :

$$K_1 = \frac{[\text{monoanion}]}{[\text{amide}][\text{HO}^-]}$$

and so $[\text{monoanion}] = K_1[\text{amide}][\text{HO}^-]$.

Substituting these values in the simple rate equation we discover that

$$\text{rate} = k[\text{dianion}] \text{ becomes}$$

$$\text{rate} = kK_1K_2[\text{amide}][\text{HO}^-]^2$$

The third-order kinetics result from two equilibria starting with the amide and involving two hydroxide ions, followed by a unimolecular rate-determining step, and the 'third-order rate constant' k_3 is actually a product of the two equilibrium constants and a first-order rate constant:

$$k_3 = k \times K_1 \times K_2$$

This often happens with reactions with late rate-determining steps: the rate constant can depend on the concentrations of any species involved before the rate-determining step (although not necessarily in that step itself) but never depends on species involved after the rate-determining step.

■ In Chapter 39 we will discuss in much more detail how such experiments are designed; much sooner, in Chapter 15, you will meet another pair of mechanisms—one first order and one second order—that tell us a lot about the reactivity of the molecules involved.

Just because a proposed mechanism gives a rate equation that fits the experimental data, it does not necessarily mean that it is the *right* mechanism; all it means is that it is consistent with the experimental facts so far, but there may be other mechanisms that also fit. It is then up to the experimenter to design cunning experiments to try to rule out other possibilities.

Mechanisms are given throughout this book—eventually you will learn to predict what mechanism to expect for a given type of reaction, but this is because earlier experimentalists have worked out the mechanisms by a study of kinetics and other methods.

Catalysis in carbonyl substitution reactions

The amide hydrolysis you have just met is much faster in base because base (in this case hydroxide) deprotonates the intermediate and makes it more reactive. The same is true for many other base-catalysed processes: often it is the nucleophile that is made more reactive by deprotonation to form an anion. For example, ester hydrolysis is faster at higher pH because the higher the pH the more hydroxide there is to act as a nucleophile.



We can plot this on a graph of rate vs. pH:

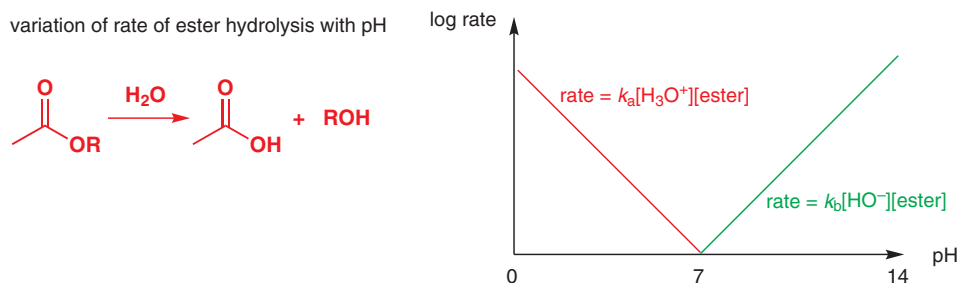

The rate equation at high pH is second order, as you expect, and depends on the concentration of hydroxide and the concentration of the ester. Notice, though, that below pH 7 the rate starts to increase again as the concentration of $[H^+]$ increases. This is because ester hydrolysis is also acid catalysed, as you saw in Chapter 10. At acidic pH, a new mechanism takes over in which protonation of the carbonyl group accelerates attack of weakly nucleophilic water.

■ Notice that the acid is truly catalytic as the proton (coloured green) is recycled.

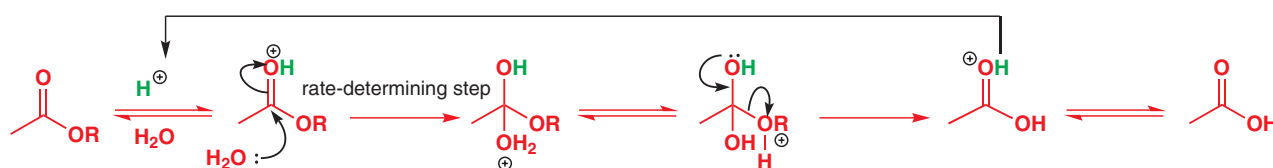

■ You will also see rate constants labelled in other ways—this is a matter of choice. A common method is to use k_1 for first-order, k_2 for second-order, and k_3 for third-order rate constants, for example.

The reaction is still bimolecular but the rate constant is different: we can represent the two processes by two rate equations, labelling the rate constants k_a and k_b with the suffixes 'a' for acid and 'b' for base to show more clearly what we mean:

$$\text{rate of ester hydrolysis in acid (pH} < 7) \text{ solution} = k_a[\text{MeCO}_2\text{R}][\text{H}_3\text{O}^+]$$

$$\text{rate of ester hydrolysis in basic (pH} > 7) \text{ solution} = k_b[\text{MeCO}_2\text{R}][\text{HO}^-]$$

This is typical acid–base catalysis, known as ‘specific acid–base catalysis’ because the specific acid and base involved are H^+ (or H_3O^+) and OH^- . The form of the pH dependence of the rate tells us that there is a choice of two mechanisms—the one that is faster is the one that is observed.

You met a reaction in Chapter 11 whose rate has a very different pH dependence: imine formation. To remind you, here is the mechanism again. We pointed out in Chapter 11 that

➔ This mechanism is discussed on p. 231.

the reaction is acid catalysed because acid is needed to help water leave. But too much acid is a problem because it protonates the starting amine and slows the reaction down.

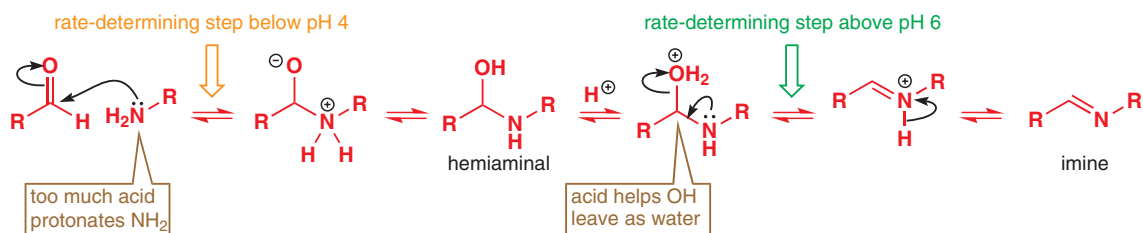

For these reasons, the pH–rate profile for imine formation looks like this: there is a maximum rate around pH 6, and either side the reaction goes more slowly.

Interactive mechanism for imine formation

variation of rate of imine formation with pH

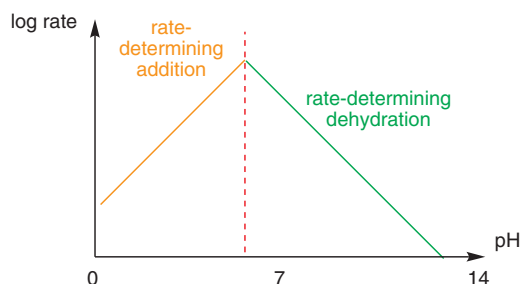
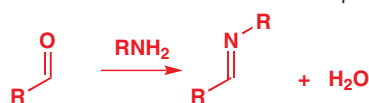

The difference now is that at low pH, the rate-determining step changes from being the dehydration step (which can then go very fast because of the high concentration of acid) to being the addition step, which is slowed down by protonation of the amine. Whereas a reaction will always go by the fastest of the available mechanisms, it is also bound to go at the rate of the slowest step in that mechanism.

• Multistep reaction rates

The overall rate of a multistep reaction is decided by:

- the *fastest* of the available mechanisms
- the *slowest* of the possible rate-determining steps.

Catalysis by weak bases

In Chapter 10 we used pyridine as a catalyst in carbonyl substitution reactions, even though it is only a weak base. Catalysis by pyridine involves two mechanisms, and is discussed on p. 200. Acetate ion is another weak base which can catalyse the formation of esters from anhydrides:

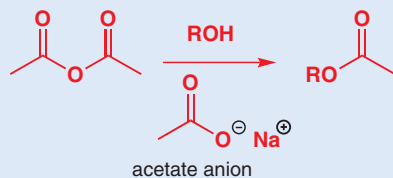

acetate is too weak to deprotonate ROH:

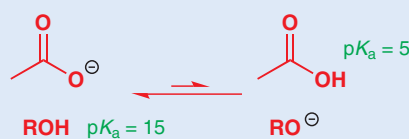

The problem is, it is far too weak a base (acetic acid has a $\text{p}K_a$ of 5) to deprotonate the alcohol ($\text{p}K_a$ 15), so it can't be forming alkoxide (in the way that hydroxide would for example). But what it can do is to remove the proton from the alcohol as *the reaction occurs*.

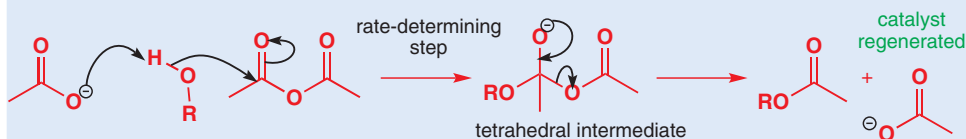

This type of catalysis, which is available to any base, not only strong bases, is called *general base catalysis* and will be discussed more in Chapter 39. It does not speed the reaction up very much but it does lower the energy of the transition state leading to the tetrahedral intermediate by avoiding the build-up of positive charge as the alcohol adds. The disadvantage of general base catalysis is that the first, rate-determining, step really is termolecular (unlike in the amide hydrolysis mechanism you met on p. 261). It is inherently unlikely that three molecules will collide with each other simultaneously. In this case, however, if ROH is the solvent, it will always be nearby in any collision so a termolecular step is just about acceptable.

Kinetic versus thermodynamic products

We started this chapter with a discussion of thermodynamics: the factors that govern equilibria. We then moved onto rates: the factors that determine the *rate* at which reactions proceed. Depending on the reaction, either may be more important, and in general:

- Reactions under **thermodynamic control** have outcomes that depend on the **position of an equilibrium** and therefore the relative stability of the possible products.
- Reactions under **kinetic control** have outcomes that depend on the rate at which the reaction proceeds, and therefore on the **relative energies of the transition states** leading to the alternative products.

➔ There are further examples of contrasting kinetic and thermodynamic control in Chapters 19 and 22.

■ Hydrogen chloride is a gas, but it can be absorbed onto the surface of the alumina for convenient handling.

■ It's worth taking a moment to think about the structure of the intermediate cation here: the cationic carbon is sp hybridized (linear) with an empty p orbital perpendicular to the p orbitals of the double bond (it is the p orbital that used to be involved in the second π bond of the alkyne).

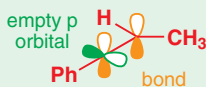

Before we leave this chapter, we will introduce an example of a reaction where thermodynamic control and kinetic control lead to different outcomes—in other words, where the fastest reaction does not give the most stable possible product.

The reaction is one you have not yet met, but it is quite a simple one, and it follows an unsurprising mechanism. It is the reaction of an alkyne with hydrogen chloride in the presence of alumina (Al_2O_3). The reaction produces two geometrical isomers of a chloroalkene.

Alkynes, like alkenes, are nucleophiles, and so the mechanism involves first of all attack by the alkyne on HCl, followed by recombination of the vinyl cation, which is formed with the chloride anion.

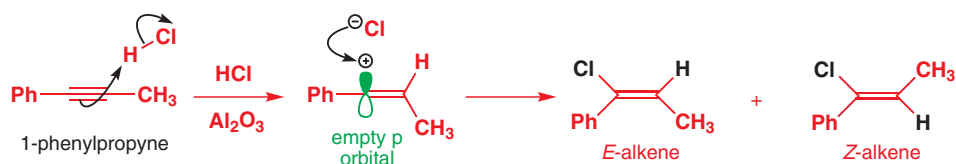

The two alkenes are labelled *E* and *Z*. After about 2 hours the main product is the *Z*-alkene. However, this is not the case in the early stages of the reaction. The graph below shows how the proportions of the starting material and the two products change with time.

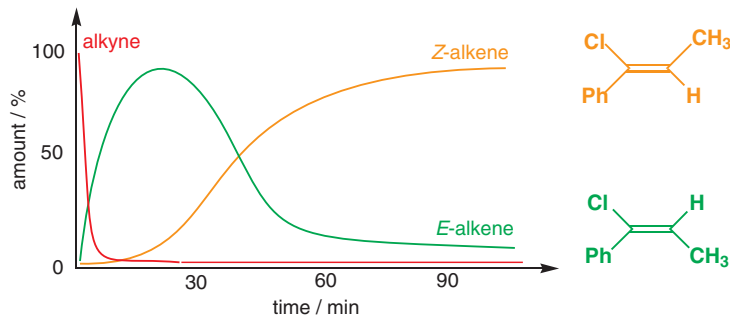

Points to note:

- When the alkyne concentration drops almost to zero (10 minutes), the only alkene that has been formed is the *E*-alkene.

- As time increases, the amount of *E*-alkene decreases as the amount of *Z*-alkene increases.
- Eventually, the proportions of *E*- and *Z*-alkene do not change.

Since it is the *Z*-alkene that dominates at equilibrium, this must be lower in energy than the *E*-alkene. Since we know the ratio of the products at equilibrium, we can work out the difference in energy between the two isomers:

ratio of *E*:*Z*-alkenes at equilibrium = 1:35

$$K_{\text{eq}} = \frac{[Z]}{[E]} = 35$$

$$\Delta G = -RT \ln K = -8.314 \times 298 \times \ln(35) = -8.8 \text{ kJ mol}^{-1}$$

that is, the *Z*-alkene is 8.8 kJ mol^{-1} lower in energy than the *E*-alkene.

However, although the *Z*-alkene is more stable, the *E*-alkene is formed faster under these conditions: the route to the *E*-alkene must have a smaller activation energy barrier than *trans* addition. This is quite easy to understand: the intermediate cation has no double-bond geometry because the cationic C is sp hybridized (linear). When chloride attacks, it prefers to attack from the side of the H atom rather than the (bigger) methyl group.

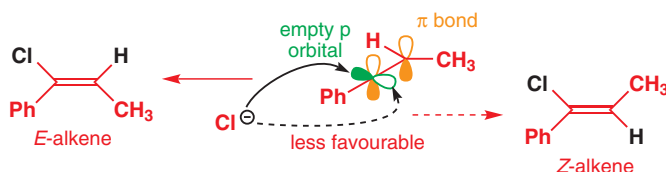

■ You might normally expect an *E*-alkene to be more stable than a *Z*-alkene—it just so happens here that Cl has a higher priority than Ph and the *Z*-alkene has the two largest groups (Ph and Me) *trans* (see p. 392 for rules of nomenclature).

There must then be some mechanism by which the quickly formed *E*-alkene is converted into the more stable *Z*-alkene. The conditions are acidic, so the most likely mechanism is the acid-catalysed alkene isomerization you saw earlier in the chapter:

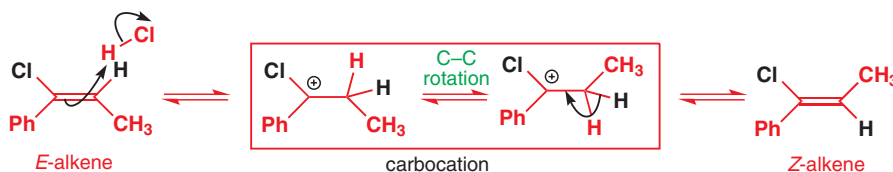

This information can be summarized on an energy profile diagram:

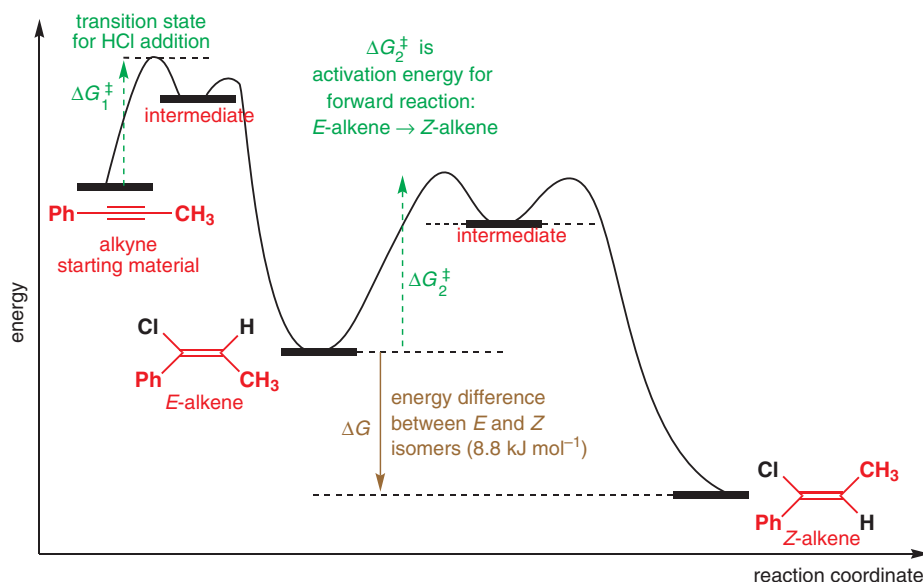

Initially, the alkyne is converted into the *E*-alkene via the intermediate linear cation. The activation energy for this step is labelled ΔG_1^\ddagger . The *E*-alkene can convert to the *Z* isomer via an intermediate, with activation energy ΔG_2^\ddagger . Since ΔG_1^\ddagger is smaller than ΔG_2^\ddagger , the *E*-alkene forms faster than it isomerizes, and all the alkyne is rapidly converted to the *E*-alkene. But over the course of the reaction, the *E*-alkene slowly isomerizes to the *Z*-alkene. An equilibrium is eventually reached that favours the *Z*-alkene because it is more stable (by 8.8 kJ mol^{-1} , as we calculated earlier). Why doesn't the *Z*-alkene form faster than the *E*? Well, as we suggested above, the transition state for its formation from the linear cation must be higher in energy than the transition state for formation of the *E*-alkene, because of steric hindrance.

● Kinetic and thermodynamic products

- The *E*-alkene is formed faster and is known as the **kinetic product** or the **product of kinetic control**.
- The *Z*-alkene is more stable and is known as the **thermodynamic product** or the **product of thermodynamic control**.

If we wanted to isolate the kinetic product, the *E*-alkene, we would carry out the reaction at low temperature and not leave it long enough for equilibration. If, on the other hand, we want the thermodynamic product, the *Z*-alkene, we would leave the reaction for longer at higher temperatures to make sure that the larger energy barrier yielding the most stable product can be overcome.

Summary of mechanisms from Chapters 6–12

In Chapter 5 we introduced basic arrow-drawing. A lot has happened since then and this is a good opportunity to pull some strands together. You may like to be reminded:

1. When molecules react together, one is the *electrophile* and one is the *nucleophile*.
2. Electrons flow from an electron-rich to an electron-poor centre.
3. Charge is conserved in each step of a reaction.

These three considerations will help you draw the mechanism of a reaction that you have not previously met.

Types of reaction arrows

1. Simple reaction arrows showing that a reaction goes from left to right or right to left.



2. Equilibrium arrows showing the extent and direction of equilibrium.

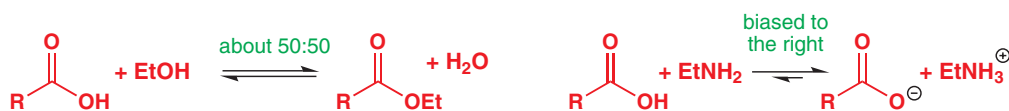

3. Delocalization or conjugation arrows showing two different ways to draw the same molecule. The two structures ('canonical forms' or 'resonance structures') must differ only in the position of electrons.



Using curly arrows

- The curly arrow should show clearly where the electrons come from and where they go to.

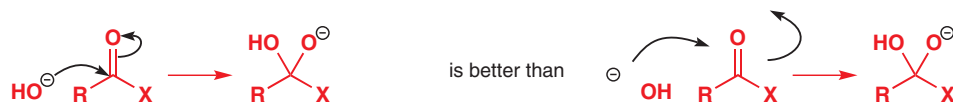

- If electrophilic attack on a π or σ bond leads to the bond being broken, the arrows should show clearly which atom bonds to the electrophile.

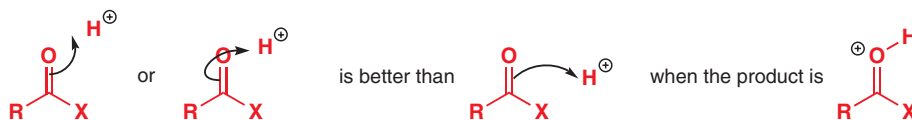

- Reactions of the carbonyl group are dominated by the breaking of the π bond. If you use this arrow first on an unfamiliar reaction of a carbonyl compound, you will probably find a reasonable mechanism.

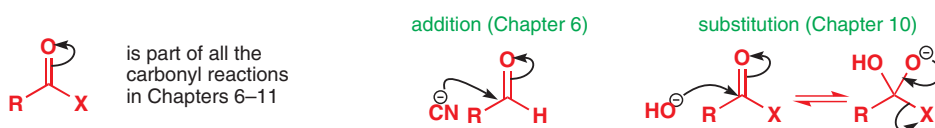

Shortcuts in drawing mechanisms

- The most important is the double-headed arrow on the carbonyl group used during a substitution reaction.

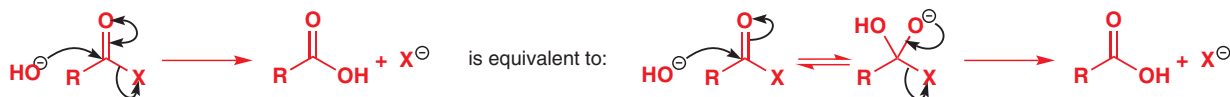

- The symbol $\pm H^+$ is shorthand for the gain and loss of a proton in the same step (usually involving N, O, or S: such steps are usually kinetically very fast).

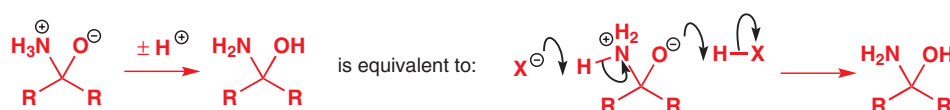

Further reading

For a more in-depth description of reaction pathways, see J. Keeler and P. Wothers, *Why Chemical Reactions Happen*, OUP, Oxford, 2003.

A physical chemistry text such as *Physical Chemistry*, 9th edn, by P. Atkins and J. de Paula, OUP, Oxford, 2011, will give you much more mathematical detail.

An excellent modern and rather more advanced physical organic book is E. V. Anslyn and D. A. Dougherty, *Modern Physical Organic*

Chemistry, University Science Books, South Orange New Jersey, 2005.

Equilibrium constants for hemiacetal formation: J. P. Guthrie *Can J. Chem.* 1975, 898.

Solvent dependence of bond rotation in amides: T. Drakenberg, K. I. Dahlqvist, and S. Forsen *J. Phys. Chem.*, 1972, 76, 2178.

Check your understanding



To check that you have mastered the concepts presented in this chapter, attempt the problems that are available in the book's Online Resource Centre at <http://www.oxfordtextbooks.co.uk/orc/clayden2e/>

^1H NMR: Proton nuclear magnetic resonance

13

Connections

➔ Building on

- X-ray crystallography, mass spectrometry, NMR, and infrared spectroscopy [ch3](#)

Arriving at

- Proton (or ^1H) NMR spectra and their regions
- How ^1H NMR compares with ^{13}C NMR: integration
- How 'coupling' in ^1H NMR provides most of the information needed to find the structure of an unknown molecule

➔ Looking forward to

- Using ^1H NMR with other spectroscopic methods to solve structures rapidly [ch18](#)
- Using ^1H NMR to investigate the detailed shape (stereochemistry) of molecules [ch31](#)
- ^1H NMR spectroscopy is referred to in most chapters of the book as it is the most important tool for determining structure; you must understand this chapter before reading further

The differences between carbon and proton NMR

We introduced nuclear magnetic resonance (NMR) in Chapter 3 as part of a three-pronged attack on the problem of determining molecular structure. We showed that mass spectrometry weighs the molecules, infrared spectroscopy tells us about functional groups, and ^{13}C and ^1H NMR tell us about the hydrocarbon skeleton. We concentrated on ^{13}C NMR because it's simpler, and we were forced to admit that we were leaving the details of the most important technique of all—proton (^1H) NMR—until a later chapter because it is more complicated than ^{13}C NMR. This is that chapter and we must now tackle those complications. We hope you will see ^1H NMR for the beautiful and powerful technique that it surely is. The difficulties are worth mastering for this is the chemist's primary weapon in the battle to solve structures.

- **We will make use of ^1H and ^{13}C NMR evidence for structure throughout this book, and it is essential that you are familiar with the explanations in this chapter before you read further.**

Proton NMR differs from ^{13}C NMR in a number of ways.

- ^1H is the major isotope of hydrogen (99.985% natural abundance), while ^{13}C is only a minor isotope (1.1%).
- ^1H NMR is quantitative: the area under the peak tells us the number of hydrogen nuclei, while ^{13}C NMR may give strong or weak peaks from the same number of ^{13}C nuclei.
- Protons interact magnetically ('couple') to reveal the connectivity of the structure, while ^{13}C is too rare for coupling between ^{13}C nuclei to be seen.

■ ' ^1H NMR' and 'proton NMR' are interchangeable terms. All nuclei contain protons of course, but chemists often use 'proton' specifically for the nucleus of a hydrogen atom, either as part of a molecule or in its 'free' form as H^+ . This is how it will be used in this chapter.

Online support. The icon  in the margin indicates that accompanying interactive resources are provided online to help your understanding: just type www.chemtube3d.com/clayden/123 into your browser, replacing **123** with the number of the page where you see the icon. For pages linking to more than one resource, type **123-1**, **123-2** etc. (replacing **123** with the page number) for access to successive links.

- ¹H NMR shifts give a more reliable indication of the local chemistry than that given by ¹³C spectra.

We shall examine each of these points in detail and build up a full understanding of proton NMR spectra.

Proton NMR spectra are recorded in the same way as ¹³C NMR spectra: radio waves are used to study the energy level differences of nuclei in a magnetic field, but this time they are ¹H and not ¹³C nuclei. Hydrogen nuclei in a magnetic field have two energy levels: they can be aligned either with or against the applied magnetic field.

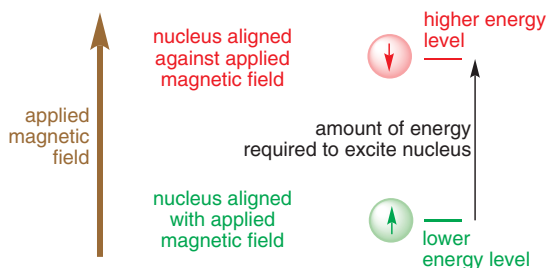

➔ In Chapter 3 we illustrated the alignment of nuclei using the analogy of a compass needle in a magnetic field.

■ All nuclei are characterized by their 'nuclear spin', a value known as I . The number of energy levels available to a nucleus of spin I is $2I + 1$. ¹H and ¹³C both have $I = 1/2$.

■ This 10 ppm scale is not the same as any part of the ¹³C NMR spectrum. It is at a different frequency altogether.

¹H and ¹³C spectra have many similarities: the scale runs from right to left and the zero point is given by the same reference compound, although it is the proton resonance of Me₄Si rather than the carbon resonance that defines the zero point. You will notice at once that the scale is much smaller, ranging over only about 10 ppm instead of the 200 ppm needed for carbon. This is because the variation in the chemical shift is a measure of the shielding of the nucleus by the electrons around it. There is inevitably less change possible in the distribution of two electrons around a hydrogen nucleus than in that of the eight valence electrons around a carbon nucleus. Here is the ¹H NMR spectrum of acetic acid, which you first saw in Chapter 3.

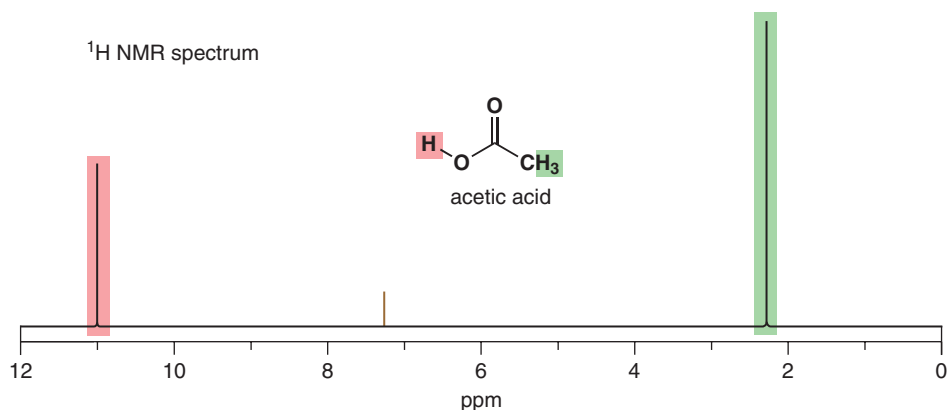

■ A reminder from Chapter 3: ignore the peak at 7.25 shown in brown. This is from the solvent, as explained on p.272.

Integration tells us the number of hydrogen atoms in each peak

You know from Chapter 3 that the position of a signal in an NMR spectrum tells us about its environment. In acetic acid the methyl group is next to the electron-withdrawing carbonyl group and so is slightly deshielded at about δ 2.0 ppm and the acidic proton itself, attached to O, is very deshielded at δ 11.2 ppm. The same factor that makes this proton acidic—the O–H bond is polarized towards oxygen—also makes it resonate at low field. So far things are much the same as in ¹³C NMR. Now for a difference. In ¹H NMR the *size* of the peaks is also important: the area under the peaks is exactly proportional to the number of protons. Proton spectra are normally integrated, that is, the area under the peaks is computed and recorded as a line with steps corresponding to the area, like this.

■ It is not enough simply to measure the relative heights of the peaks because, as here, some peaks might be broader than others. Hence the area under the peak is measured.

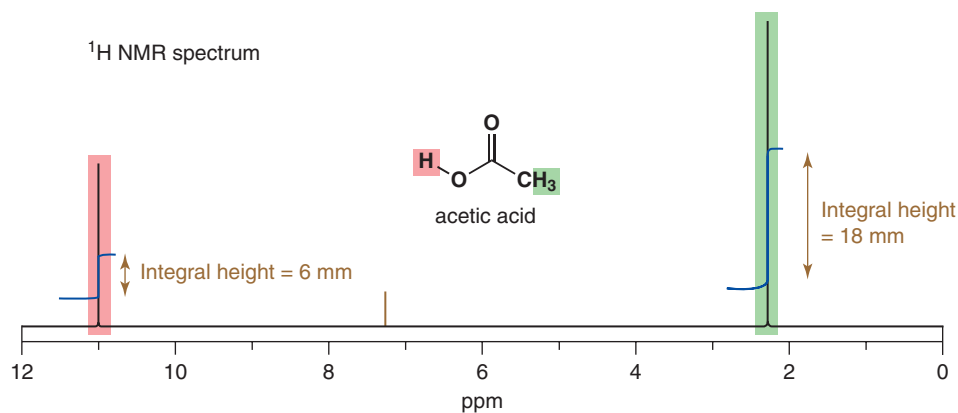

Simply measuring the height of the steps with a ruler gives you the *ratio* of the numbers of protons represented by each peak. In many spectra this will be measured for you and reported as a number at the bottom of the spectrum. Knowing the atomic composition (from the mass spectrum) we also know the distribution of protons of various kinds. Here the heights are 6 mm and 18 mm, a ratio of about 1:3. The compound is $C_2H_4O_2$ so, since there are four H atoms altogether, the peaks must contain $1 \times H$ and $3 \times H$, respectively.

In the spectrum of 1,4-dimethoxybenzene there are just two signals in the ratio of 3:2. This time the compound is $C_8H_{10}O_2$ so the true ratio must be 6:4. The positions of the two signals are exactly where you would expect them to be from our discussion of the regions of the NMR spectrum in Chapter 3: the 4H aromatic signal is in the left-hand half of the spectrum, between 5 and 10 ppm, where we expect to see protons attached to sp^2 C atoms, while the 6H signal is in the right-hand half of the spectrum, where we expect to see protons attached to sp^3 C atoms.

➔ We will come back to the regions of the ¹H NMR spectrum in more detail in just a moment, but we introduced them in Chapter 3 on p. 60.

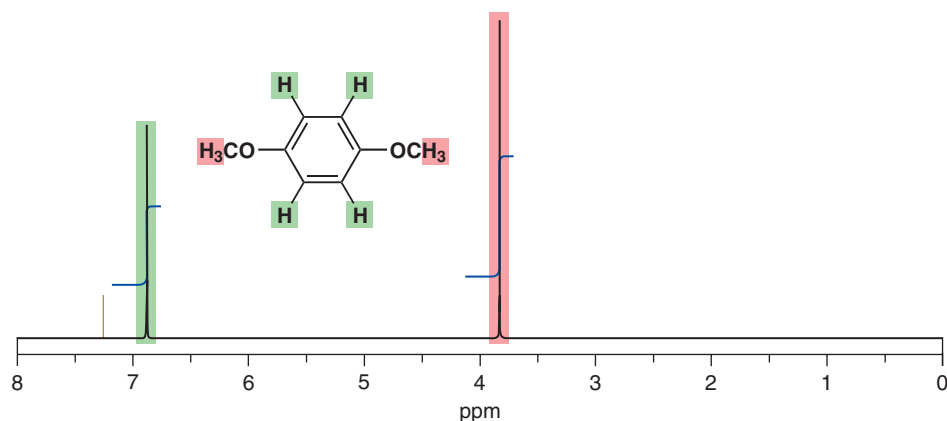

In this next example it is easy to assign the spectrum simply by measuring the steps in the integral. There are two identical methyl groups (CMe_2) with six Hs, one methyl group by itself with three Hs, the OH proton (1 H), the CH_2 group next to the OH (two Hs), and finally the CH_2CH_2 group between the oxygen atoms in the ring (four Hs).

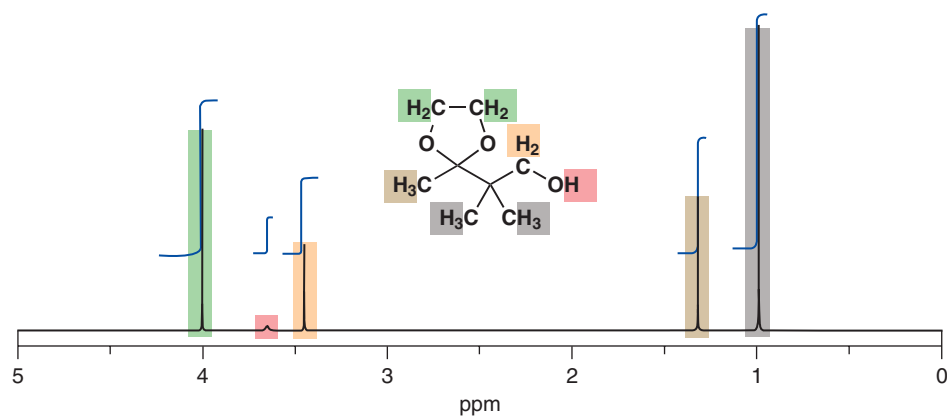

Before we go on, a note about the solvent peaks shown in brown in these spectra. Proton NMR spectra are generally recorded in solution in deuteriochloroform (CDCl_3)—that is, chloroform (CHCl_3) with the ^1H replaced by ^2H (deuterium). The proportionality of the size of the peak to the number of protons tells you why: if you ran a spectrum in CHCl_3 , you would see a vast peak for all the solvent Hs because there would be much more solvent than the compound you wanted to look at. Using CDCl_3 cuts out all extraneous protons. ^2H atoms have different nuclear properties and so don't show up in the ^1H spectrum. Nonetheless, CDCl_3 is always unavoidably contaminated with a small amount of CHCl_3 , giving rise to the small peak at 7.25 ppm. Spectra may equally well be recorded in other deuterated solvents such as water (D_2O), methanol (CD_3OD), or benzene (C_6D_6).

Regions of the proton NMR spectrum

All the H atoms in the last example were attached to sp^3 carbons, so you will expect them to fall between 0 and 5 ppm. However, you can clearly see that H atoms that are nearer to oxygen are shifted downfield within the 0–5 ppm region, to larger δ values (here as far as 3.3 and 3.9 ppm). We can use this fact to build some more detail into our picture of the regions of the ^1H NMR spectrum.

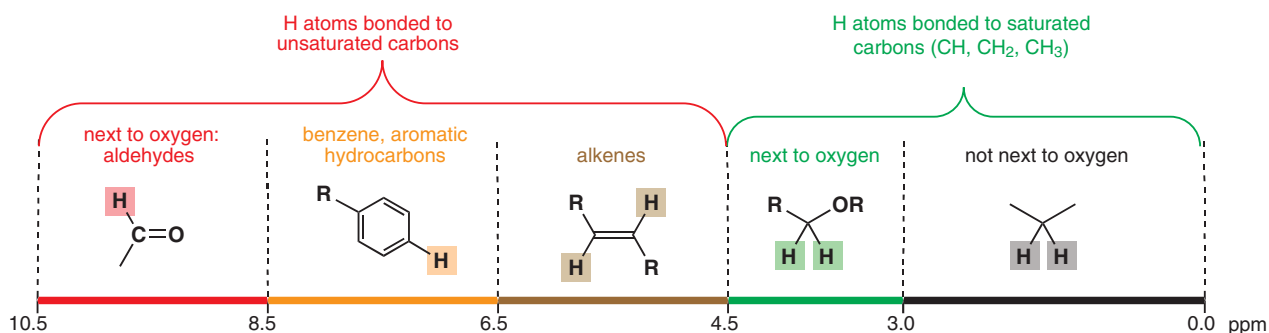

These regions hold for protons attached to C: protons attached to O or N can come almost anywhere on the spectrum. Even for C–H signals the regions are approximate and overlap quite a lot. You should use the chart as a basic guide, and you should aim to learn these regions. But you will also need to build up a more detailed understanding of the factors affecting proton chemical shift. To help you achieve this understanding, we now need to examine the classes of proton in more detail and examine the reasons for their particular shifts. It is important that you grasp these reasons.

In this chapter you will see a lot of numbers—chemical shifts and differences in chemical shifts. We need these to show that the ideas behind ^1H NMR are securely based in fact. *You do not need to learn these numbers.* Comprehensive tables can be found at the end of Chapter 18, which we hope you will find useful for reference while you are solving problems.

➔ These tables can be found on pp. 422–426.

Protons on saturated carbon atoms

Chemical shifts are related to the electronegativity of substituents

We shall start with protons on saturated carbon atoms. The top half of the diagram below shows how the protons in a methyl group are shifted more and more as the atom attached to them gets more electronegative.

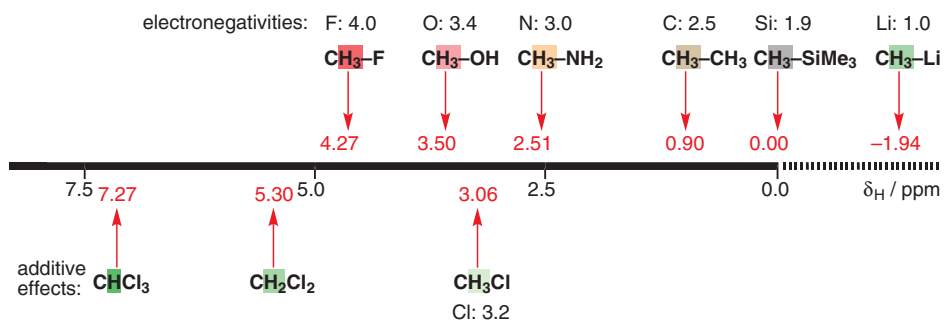

When we are dealing with single atoms as substituents, these effects are straightforward and more or less additive. If we go on adding electronegative chlorine atoms to a carbon atom, electron density is progressively removed from it and the carbon nucleus and the hydrogen atoms attached to it are progressively deshielded. You can see this in the bottom half of the diagram above. Dichloromethane, CH_2Cl_2 , and chloroform, CHCl_3 , are commonly used as solvents and their shifts will become familiar to you if you look at a lot of spectra.

Proton chemical shifts tell us about chemistry

The truth is that shifts and electronegativity are not perfectly correlated. The key property is indeed electron withdrawal but it is the electron-withdrawing power of the whole substituent in comparison with the carbon and hydrogen atoms in the CH skeleton that matters. Methyl groups joined to the same element—nitrogen, say—may have very different shifts if the substituent is an amino group ($\text{CH}_3\text{-NH}_2$ has δ_{H} for the CH_3 group = 2.41 ppm) or a nitro group ($\text{CH}_3\text{-NO}_2$ has δ_{H} 4.33 ppm). A nitro group is much more electron-withdrawing than an amino group.

What we need is a quick guide rather than some detailed correlations, and the simplest is this: all functional groups except very electron-withdrawing ones shift methyl groups from 1 ppm (where you find them if they are not attached to a functional group) downfield to about 2 ppm. Very electron-withdrawing groups shift methyl groups to about 3 ppm. This is the sort of thing it is worth learning.

■ You have seen δ used as a symbol for chemical shift. Now that we have two sorts of chemical shift—in the ^{13}C NMR spectrum and in the ^1H NMR spectrum—we need to be able to distinguish them. δ_{H} means chemical shift in the ^1H NMR spectrum, and δ_{C} is chemical shift in the ^{13}C NMR spectrum.

● Estimating the chemical shift of a methyl group

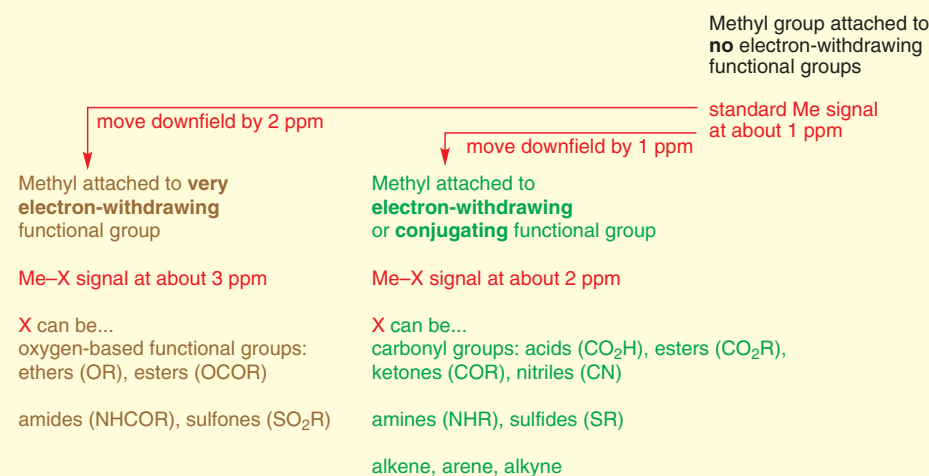

Rather than trying to fit these data to some atomic property, even such a useful one as electronegativity, we should rather see these shifts as a useful measure of the electron-withdrawing power of the group in question. The NMR spectra are telling us about the chemistry. The largest shift you are likely to see for a methyl group is that caused by the nitro group, 3.43 ppm, at least twice the size of the shift for a carbonyl group. This gives us our first hint of some important chemistry: one nitro group is worth two carbonyl groups when it come to electron-withdrawing power. You have already seen that electron withdrawal and acidity are related (Chapter 8) and in later chapters you will see that we can correlate the anion-stabilizing power of groups like carbonyl, nitro, and sulfone with proton NMR.

Methyl groups give us information about the structure of molecules

It sounds rather unlikely that the humble methyl group could tell us much that is important about molecular structure—but just you wait. We shall look at four simple compounds and their NMR spectra—just the methyl groups, that is.

The first compound, the acid chloride in the margin, shows just one methyl signal containing nine Hs at δ_{H} 1.10. This tells us two things. All the protons in each methyl group are identical,

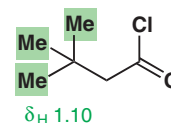

■ Rotation about single bonds is generally very fast (you are about to see an exception); rotation about double bonds is generally very, very slow (it just doesn't happen). We talked about rotation rates in Chapter 12.

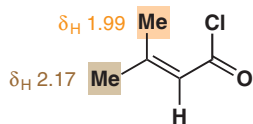

and all three methyl groups in the tertiary butyl (*t*-butyl, or Me₃C-) group are identical. This is because rotation about C–C single bonds, both about the CH₃–C bond and about the (CH₃)₃C–C bond, is fast. Although at any one instant the hydrogen atoms in one methyl group, or the methyl groups in the *t*-butyl group, may differ, on average they are the same. The time-averaging process is fast rotation about a σ bond.

The second compound shows two 3H signals, one at 1.99 and one at 2.17 ppm. Unlike a C–C bond, the C=C double bond does not rotate at all and so the two methyl groups are different. One is on the same side of the alkene as (or '*cis* to') the –COCl group while the other is on the opposite side (or '*trans*').

The next pair of compounds contain the CHO group. One is a simple aldehyde, the other an amide of formic acid: it is DMF, dimethylformamide. The first has two sorts of methyl group: a 3H signal at δ_H 1.81 for the SMe group and a 6H signal at δ_H 1.35 for the CMe₂ group. The two methyl groups in the 6H signal are the same, again because of fast rotation about a C–C σ bond. The second compound also has two methyl signals, at 2.89 and 2.98 ppm, each 3H, and these are the two methyl groups on nitrogen. Restricted rotation about the N–CO bond must be making the two Me groups different. You will remember from Chapter 7 (p. 155) that the N–CO amide bond has considerable double-bond character because of conjugation: the lone pair electrons on nitrogen are delocalized into the carbonyl group.

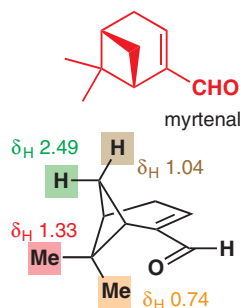
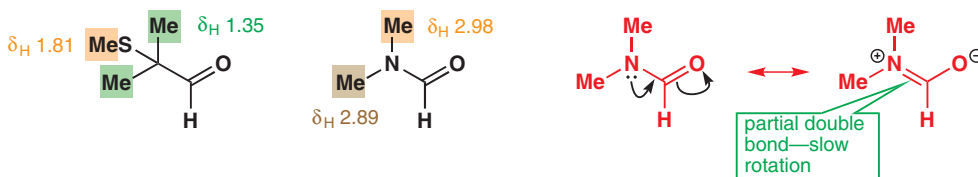

Like double bonds, cage structures prevent bond rotation and can make the two protons of a CH₂ group appear different. There are many flavouring compounds (terpenoids) from herbs that have structures like this. In the example here—myrtenal, from the myrtle bush—there is a four-membered ring bridged across a six-membered ring. The methyl groups on the other bridge are different because one is over the alkene while one is over the CH₂. No rotation of any bonds within the cage is possible, so these methyl groups resonate at different frequencies (0.74 and 1.33 ppm). The same is true for the two H atoms of the CH₂ group.

CH and CH₂ groups have higher chemical shift than CH₃ groups

Electronegative substituents have a similar effect on the protons of CH₂ groups and CH groups, but with the added complication that CH₂ groups have *two* other substituents and CH groups *three*. A simple CH₂ (methylene) group resonates at 1.3 ppm, about 0.4 ppm further downfield than a comparable CH₃ group (0.9 ppm), and a simple CH group resonates at 1.7 ppm, another 0.4 ppm downfield. Replacing each hydrogen atom in the CH₃ group by a carbon atom causes a small downfield shift as carbon is slightly more electronegative (C 2.5; H 2.2) than hydrogen and therefore shields less effectively.

● Chemical shifts of protons in CH, CH₂, and CH₃ groups with no nearby electron-withdrawing groups.

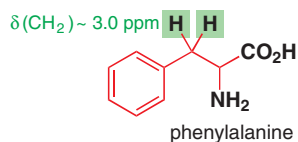
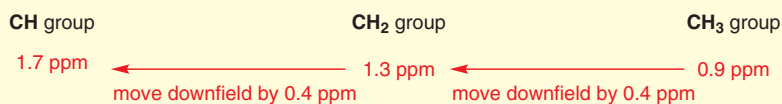

The benzyl group (PhCH₂-) is very important in organic chemistry. It occurs naturally in the amino acid phenylalanine, which you met in Chapter 2. Phenylalanine has its CH₂ signal at 3.0 ppm and is moved downfield from 1.3 ppm mostly by the benzene ring.

Amino acids are often 'protected' as the Cbz (carboxybenzyl) derivatives by reaction with an acid chloride (we'll discuss this more in Chapter 23). Here is a simple example together

with the NMR spectrum of the product. Now the CH₂ group has gone further downfield to 5.1 ppm as it is next to both oxygen and phenyl.

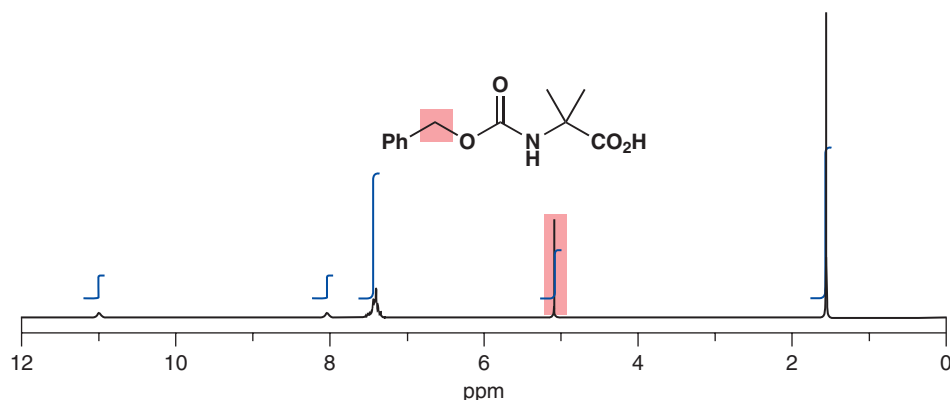
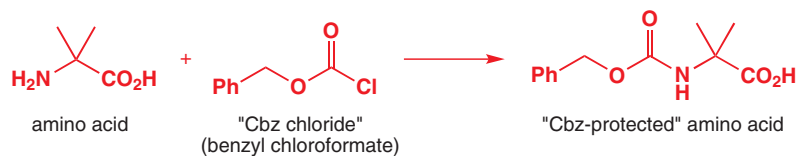

➔ You met this sort of amide-forming reaction in Chapter 10—here the amide is actually a carbamate as the C=O group is flanked by both O and N.

Chemical shifts of CH groups

A CH group in the middle of a carbon skeleton resonates at about 1.7 ppm—another 0.4 ppm downfield from a CH₂ group. It can have up to three substituents and these will cause further downfield shifts of about the same amount as we have already seen for CH₃ and CH₂ groups. Three examples from nature are nicotine, the methyl ester of lactic acid, and vitamin C. Nicotine, the compound in tobacco that causes the craving (although not the death, which is doled out instead by the carbon monoxide and tars in the smoke), has one hydrogen atom trapped between a simple tertiary amine and an aromatic ring at 3.24 ppm. The ester of lactic acid has a CH proton at 4.3 ppm. You could estimate this with reasonable accuracy using the guidelines in the two summary boxes on pp. 273 and 274. Take 1.7 (for the CH) and add 1.0 (for C=O) plus 2.0 (for OH) = 4.7 ppm—not far out. Vitamin C (ascorbic acid) has two CHs. One at 4.05 ppm is next to an OH group (estimate 1.7 + 2.0 for OH = 3.7 ppm) and one is next to a double bond and an oxygen atom at 4.52 ppm (estimate 1.7 + 1 for double bond + 2 for OH = 4.7 ppm). Again, not too bad for a rough estimate.

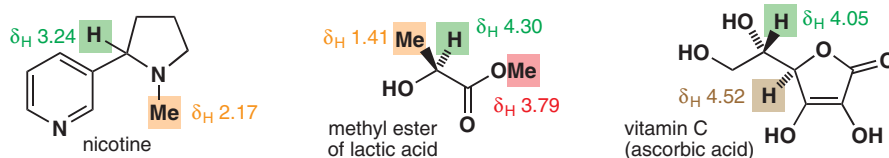

An interesting case is the amino acid phenylalanine whose CH₂ group we looked at a moment ago. It also has a CH group between the amino and the carboxylic acid groups. If we record the ¹H NMR spectrum in D₂O, in either basic (NaOD) or acidic (DCl) solutions, we see a large shift of that CH group. In basic solution the CH resonates at 3.60 ppm and in acidic solution it resonates at 4.35 ppm. There is a double effect here: CO₂H and NH₃⁺ are both more electron-withdrawing than CO₂⁻ and NH₂ so both move the CH group downfield.

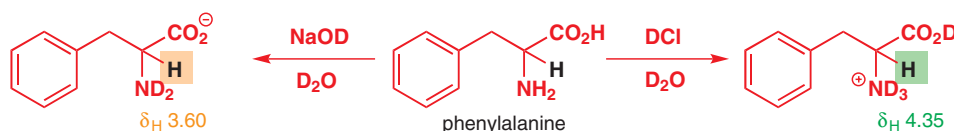

■ D₂O, NaOD, and DCl have to be used in place of their ¹H equivalents to avoid swamping the spectrum with H₂O protons. All acidic protons are replaced by deuterium in the process—more on this later.

• A simple guide to estimating chemical shifts

We suggest you start with a very simple (and therefore necessarily oversimplified) picture, which should be the basis for any further refinements. Start methyl groups at 0.9, methylenes (CH₂) at 1.3, and methines (CH) at 1.7 ppm. Any functional group is worth a 1 ppm downfield shift except oxygen and halogen which are worth 2 ppm. This diagram summarizes this approach.

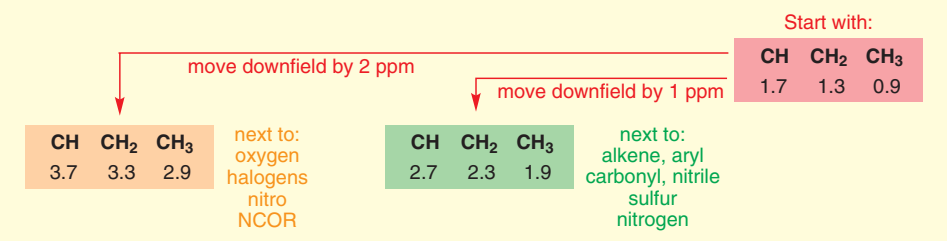

The guide above is very rough and ready, but is easily remembered and you should aim to learn it. However, if you want to, you can make it slightly more accurate by adding further subdivisions and separating out the very electron-withdrawing groups (nitro, ester OCOR, fluoride), which shift by 3 ppm. This gives us the summary chart on this page, which we suggest you use as a reference. If you want even more detailed information, you can refer to the tables in Chapter 18 or better still the more comprehensive tables in any specialized text (see the Further reading section).

Summary chart of proton NMR shifts

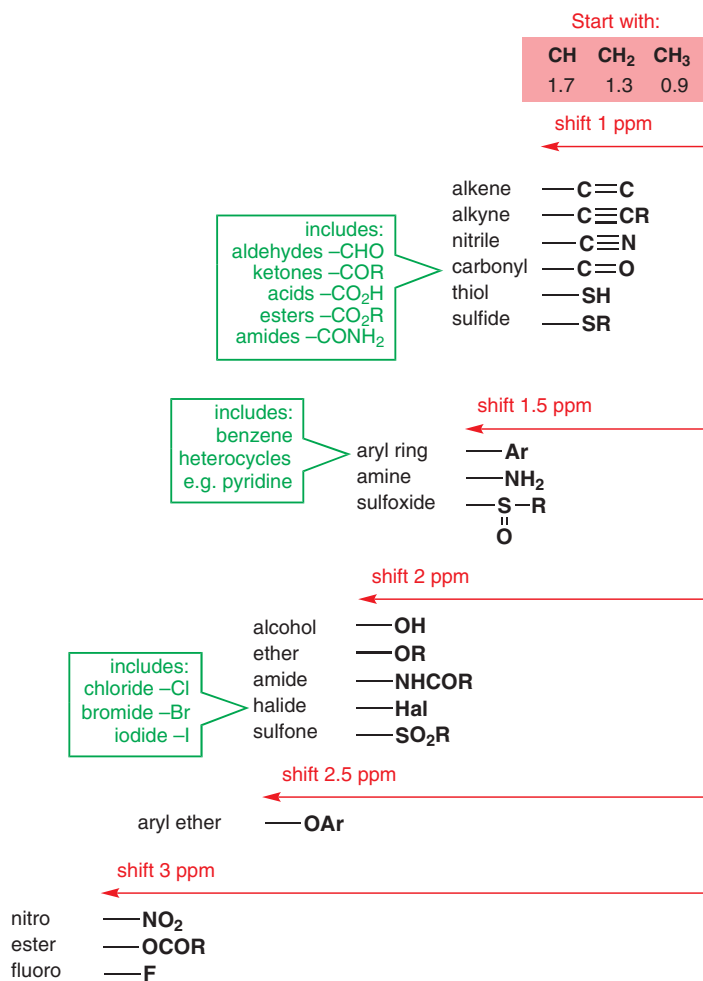

Answers deduced from this chart won't be perfect but will give a good guide. Remember—these shifts are additive. Take a simple example, the ketoester below. There are just three signals and the integration alone distinguishes the two methyl groups from the CH₂ group. One methyl has been shifted from 0.9 ppm by about 1 ppm, the other by more than 2 ppm. The first must be next to C=O and the second next to oxygen. More precisely, 2.14 ppm is a shift of 1.24 ppm from our standard value (0.9 ppm) for a methyl group, about what we expect for a methyl ketone, while 3.61 ppm is a shift of 2.71 ppm, close to the expected 3.0 ppm for an ester joined through the oxygen atom. The CH₂ group is next to an ester and a ketone carbonyl group and so we expect it at 1.3 + 1.0 + 1.0 = 3.3 ppm, an accurate estimate, as it happens. We shall return to these estimates when we look at the spectra of unknown compounds.

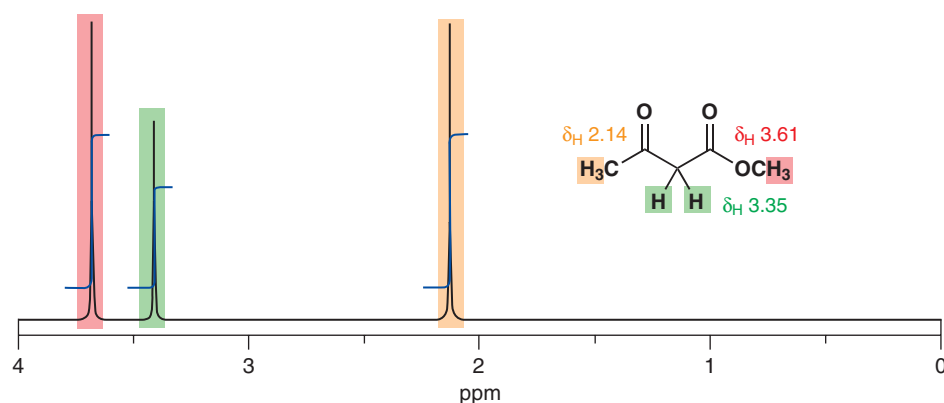

The alkene region and the benzene region

In ¹³C NMR, alkene and benzene carbons came in the same region of the spectrum, but in the ¹H NMR spectrum the H atoms attached to arene C and alkene C atoms sort themselves into two groups. To illustrate this point, look at the ¹³C and ¹H chemical shifts of cyclohexene and benzene, shown in the margin. The two carbon signals are almost the same (1.3 ppm difference, < 1% of the total 200 ppm scale) but the proton signals are very different (1.6 ppm difference = 16% of the 10 ppm scale). There must be a fundamental reason for this.

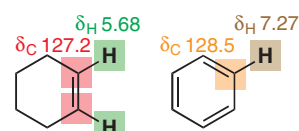

The benzene ring current causes large shifts for aromatic protons

A simple alkene has an area of low electron density in the plane of the molecule because the π orbital has a node there, and the carbons and hydrogen nuclei lying in the plane gain no shielding from the π electrons.

The benzene ring looks similar at first sight, and the plane of the molecule is indeed a node for all the π orbitals. However, as we discussed in Chapter 7, benzene is aromatic—it has extra stability because the six π electrons fit into three very stable orbitals and are delocalized round the whole ring. The applied field sets up a ring current in these delocalized electrons that produces a local field rather like the field produced by the electrons around a nucleus. Inside the benzene ring the induced field opposes the applied field, but outside the ring it reinforces the applied field. The carbon atoms are in the ring itself and experience neither effect, but the hydrogens are outside the ring, feel a stronger applied field, and appear less shielded (i.e. more deshielded; larger chemical shift).

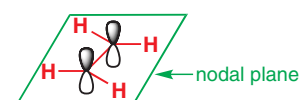

■ Magnetic fields produced by circulating electrons are all around you: electromagnets and solenoids are exactly this.

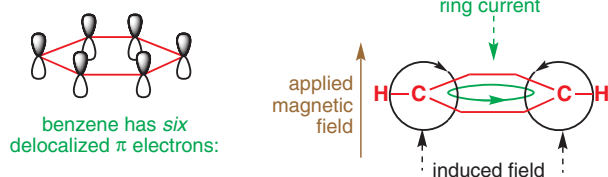

Cyclophanes and annulenes

You may think that it is rather pointless imagining what goes on inside an aromatic ring as we cannot have hydrogen atoms literally inside a benzene ring. However, we can get close. Compounds called cyclophanes have loops of saturated carbon atoms attached at both ends to the same benzene rings. You see here a structure for [7]-*para*-cyclophane, which has a string of seven CH₂ groups attached to the *para* positions of the same benzene ring. The four H atoms on the benzene ring itself appear as one signal at 7.07 ppm—a typical ring-current deshielded value for a benzene ring. The two CH₂ groups joined to the benzene ring (C1) are also deshielded by the ring current at 2.64 ppm. The next two sets of CH₂ groups on C2 and C3 are neither shielded nor deshielded at 1.0 ppm. But the middle CH₂ group in the chain (C4) must be pointing towards the ring in the middle of the π system and is heavily shielded by the ring current at -0.6 ppm).

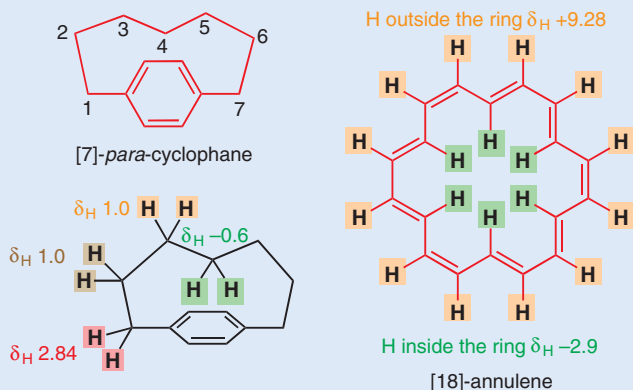

Interactive structures of cyclophane and annulene

With a larger aromatic ring it is possible actually to have hydrogen atoms inside the ring. Compounds are aromatic if they have $4n + 2$ delocalized electrons and this ring with nine double bonds, that is, 18 π electrons, is an example. The hydrogens outside the ring resonate in the aromatic region at rather low field (9.28 ppm) but the hydrogen atoms inside the ring resonate at an amazing -2.9 ppm, showing the strong shielding by the ring current. Such extended aromatic rings are called *annulenes*: you met them in Chapter 7.

Uneven electron distribution in aromatic rings

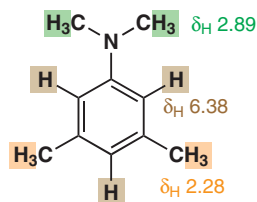

The greater electron density around the ring more than compensates for any change in the ring current.

The ¹H NMR spectrum of this simple aromatic amine has three peaks in the ratio 1:2:2, which must correspond to 3H:6H:6H. The 6.38 ppm signal clearly belongs to the protons round the benzene ring, but why are they at 6.38 and not at around 7.2 ppm? We must also distinguish the two methyl groups at 2.28 ppm from those at 2.89 ppm. The chart on p. 276 suggests that these should both be at about 2.4 ppm, close enough to 2.28 ppm but not to 2.89 ppm. The solution to both these puzzles is the distribution of electrons in the aromatic ring. Nitrogen feeds electrons into the π system, making it electron rich: the ring protons are more shielded and the nitrogen atom becomes positively charged and its methyl groups more deshielded. The peak at 2.89 ppm must belong to the NMe₂ group.

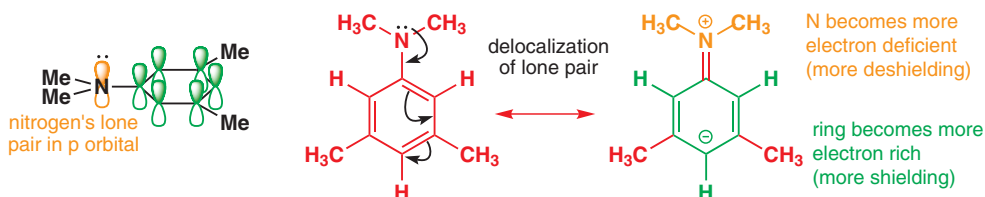

Why should you usually expect to see *three* types of protons for a monosubstituted phenyl ring?

Other groups, such as simple alkyl groups, hardly perturb the aromatic system at all and it is quite common for all five protons in an alkyl benzene to appear as one signal instead of the three we might expect. Here is an example with some non-aromatic protons too: there is another on p. 275—the Cbz-protected amino acid.

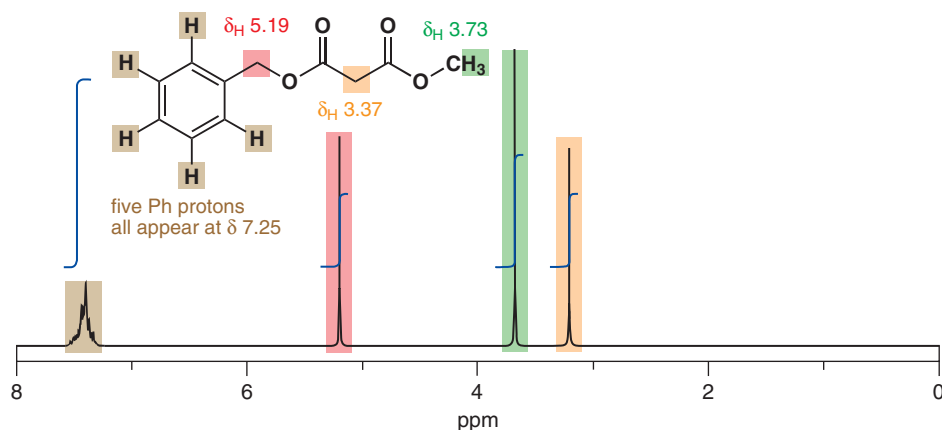

The five protons on the aromatic ring all have the same chemical shift. Check that you can assign the rest. The OCH₃ group (green) is typical of a methyl ester (the chart on p. 276 suggests 3.9 ppm). One CH₂ group (yellow) is between two carbonyl groups (compare 3.35 ppm for the similar CH₂ group on p. 277). The other (red) is next to an ester and a benzene ring: we calculate $1.3 + 1.5 + 3.0 = 5.8$ ppm for that—reasonably close to the observed 5.19 ppm. Notice how the Ph and the O together act to shift the Hs attached to this sp³ C downfield into what we usually expect to be the alkene region. Don't interpret the regions on p. 272 too rigidly!

How electron donation and withdrawal change chemical shifts

We can get an idea of the effect of electron distribution by looking at a series of benzene rings with the same substituent in the 1 and 4 positions. This pattern makes all four hydrogens on the ring identical. Here are a few compounds listed in order of chemical shift: largest shift (lowest field; most deshielded) first. Conjugation is shown by the usual curly arrows, and inductive effects by a straight arrow by the side of the group. Only one hydrogen atom and one set of arrows are shown.

➔ Conjugation, as discussed in Chapter 7, is felt through π bonds, while inductive effects are the result of electron withdrawal or donation felt simply by polarization of the σ bonds of the molecule. See p. 135.

the effect of electron-withdrawing groups
by conjugation

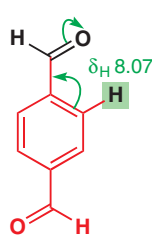
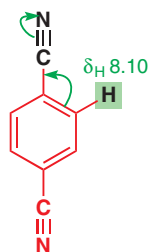
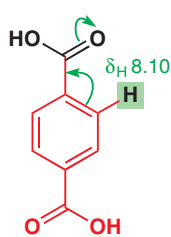
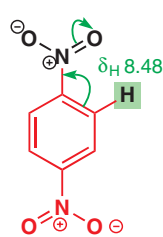

by inductive effects

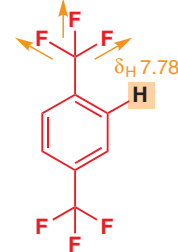

The largest shifts come from groups that withdraw electrons by conjugation. Nitro is the most powerful—this should not surprise you as we saw the same in non-aromatic compounds in both ¹³C and ¹H NMR spectra. Then come the carbonyl and nitrile group followed by groups showing simple inductive withdrawal. CF₃ is an important example of this kind of group—three fluorine atoms combine to exert a powerful effect.

➔ This all has very important consequences for the reactivity of differently substituted benzene rings: their reactions will be discussed in Chapter 21.

In the middle of our sequence, around the position of benzene itself at 7.27 ppm, come the halogens, whose inductive electron withdrawal and lone pair donation are nearly balanced.

balance between withdrawal by inductive effect and donation of lone pairs by conjugation

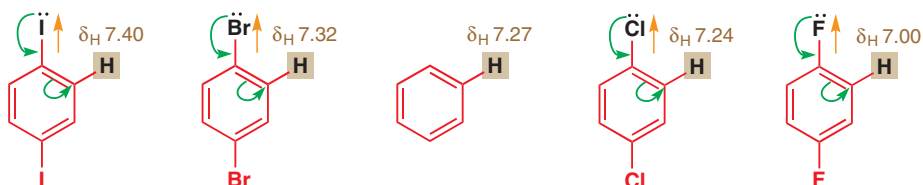

Alkyl groups are weak inductive donors, but the groups which give the most shielding—perhaps surprisingly—are those containing the electronegative atoms O and N. Despite being inductively electron withdrawing (the C–O and C–N σ bonds are polarized with δ^+ C), on balance conjugation of their lone pairs with the ring (as you saw on p. 278) makes them net electron donors. They *increase* the shielding at the ring hydrogens. Amino groups are the best. Note that one nitrogen-based functional group (NO_2) is the best electron withdrawer while another (NH_2) is the best electron donor.

the effect of electron-donating groups

by inductive effect

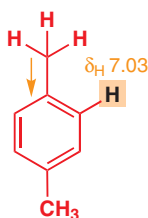

balance between withdrawal by inductive effect and donation of lone pairs by conjugation—electron donation wins

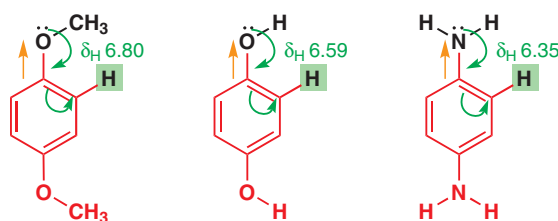

As far as the donors with lone pairs are concerned (the halogens plus O and N), two factors are important—the size of the lone pairs and the electronegativity of the element. If we look at the four halides at the top of this page the lone pairs are in 2p (F), 3p (Cl), 4p (Br), and 5p (I) orbitals. In all cases the orbitals on the benzene ring are 2p so the fluorine orbital is of the right size to interact well and the others too large. Even though fluorine is the most electronegative, it is still the best donor. The others don't pull so much electron density away, but they can't give so much back either.

If we compare the first row of the p block elements—F, OH, and NH_2 —all have lone pairs in 2p orbitals so now electronegativity is the only variable. As you would expect, the most electronegative element, F, is now the weakest donor.

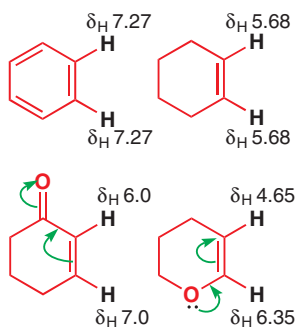

Electron-rich and electron-deficient alkenes

The same sort of thing happens with alkenes. We'll concentrate on cyclohexene so as to make a good comparison with benzene. The six identical protons of benzene resonate at 7.27 ppm; the two identical alkene protons of cyclohexene resonate at 5.68 ppm. A conjugating and electron-withdrawing group such as a ketone removes electrons from the double bond as expected—but unequally. The proton nearer the C=O group is only slightly downfield from cyclohexene but the more distant one is over 1 ppm downfield. The curly arrows show the electron distribution, *which we can deduce* from the NMR spectrum.

Oxygen as a conjugating electron donor is even more dramatic. It shifts the proton next to it downfield by the inductive effect but pushes the more distant proton upfield a whole 1 ppm by donating electrons. The separation between the two protons is nearly 2 ppm.

For both types of substituent, the effects are more marked on the more distant (β) proton. If these shifts reflect the true electron distribution, we should be able to deduce something about the chemistry of the following three compounds. You might expect that nucleophiles will attack the electron-deficient site in the nitroalkene, while electrophiles will be attacked by the electron-rich sites in silyl enol ethers and enamines. These are all important reagents and do indeed react as we predict, as you will see in later chapters. Look at the difference—there are nearly 3 ppm between the shifts of the same proton on the nitro compound and the enamine!

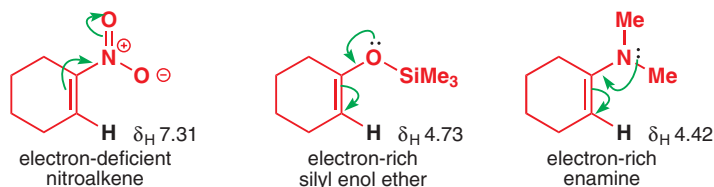

Structural information from the alkene region

Alkene protons on different carbon atoms can obviously be different if the carbon atoms themselves are different and we have just seen examples of that. Alkene protons can also be different if they are on the same carbon atom. All that is necessary is that the substituents at the other end of the double bond should themselves be different. The silyl enol ether and the unsaturated ester below both fit into this category. The protons on the double bond must be different, because each is *cis* to a different group. We may not be able to assign which is which, but the difference alone tells us something. The third compound is an interesting case: the different shifts of the two protons on the ring prove that the N–Cl bond is at an angle to the C=N bond. If it were in line, the two hydrogens would be identical. The other side of the C=N bond is occupied by a lone pair and the nitrogen atom is trigonal (sp^2 hybridized).

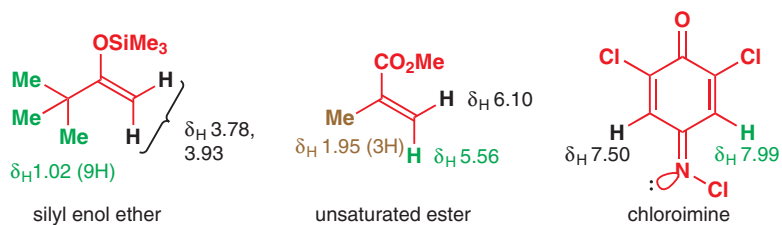

The aldehyde region: unsaturated carbon bonded to oxygen

The aldehyde proton is unique. It is directly attached to a carbonyl group—one of the most electron-withdrawing groups that exists—and is very deshielded, resonating with the largest shifts of any CH protons, in the 9–10 ppm region. The examples below are all compounds that we have met before. Two are just simple aldehydes—aromatic and aliphatic. The third is the solvent DMF. Its CHO proton is less deshielded than most—the amide delocalization that feeds electrons into the carbonyl group provides some extra shielding.

■ *Aliphatic* is a catch-all term for compounds that are not aromatic.

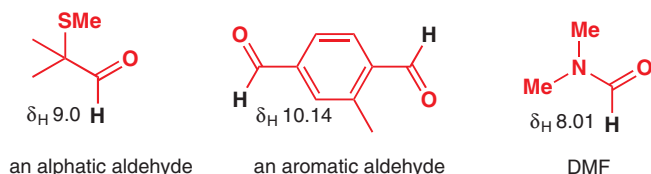

Conjugation with an oxygen lone pair has much the same effect—formate esters resonate at about 8 ppm—but conjugation with π bonds does not. The aromatic aldehyde above, simple conjugated aldehyde below, and myrtenal all have CHO protons in the normal region (9–10 ppm).

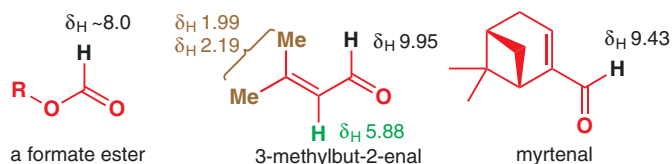

Non-aldehyde protons in the aldehyde region: pyridines

Two other types of protons resonate in the region around 9–10 ppm: some aromatic protons and some protons attached to heteroatoms like OH and NH. We will deal with NH and OH protons in the next section, but first we must look at some electron-deficient aromatic rings with distinctively large shifts.

Protons on double bonds, even very electron-deficient double bonds like those of nitroalkenes, hardly get into the aldehyde region. However, some benzene rings with very electron-withdrawing groups do manage it because of the extra downfield shift of the ring current, so look out for nitrobenzenes as they may have signals in the 8–9 ppm region.

More important molecules with signals in this region are the aromatic heterocycles such as pyridine, which you saw functioning as a base in Chapters 8 and 10. The NMR shifts clearly show that pyridine is aromatic: one proton is at 7.1 ppm, essentially the same as benzene, but the others are more downfield and one, at C2, is in the aldehyde region. This is not because pyridine is ‘more aromatic’ than benzene but because nitrogen is more electronegative than carbon. Position C2 is like an aldehyde—a proton attached to sp^2 C bearing a heteroatom—while C4 is electron deficient due to conjugation (the electronegative nitrogen is electron withdrawing). Isoquinoline is a pyridine and a benzene ring fused together and has a proton even further downfield at 9.1 ppm—this is an imine proton that experiences the ring current of the benzene ring.

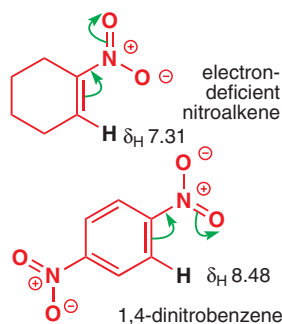

➔ There is more on the electron-withdrawing nature of the nitro group on p. 176.

■ Note that the alternative ‘conjugation’ shown in the structure below is wrong. The structure with two adjacent double bonds in a six-membered ring is impossible and, in any case, as you saw in Chapter 8, the lone pair electrons on nitrogen are in an sp^2 orbital orthogonal to the p orbitals in the ring. There is no interaction between orthogonal orbitals.

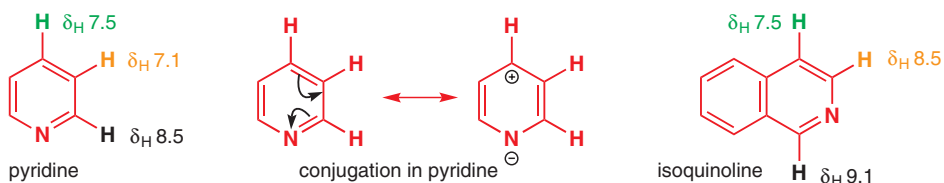
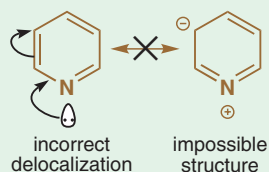

Protons on heteroatoms have more variable shifts than protons on carbon

Protons directly attached to O, N, or S (or any other heteroatom, but these are the most important) also have signals in the NMR spectrum. We have avoided them so far because the positions of these signals are less reliable and because they are affected by exchange.

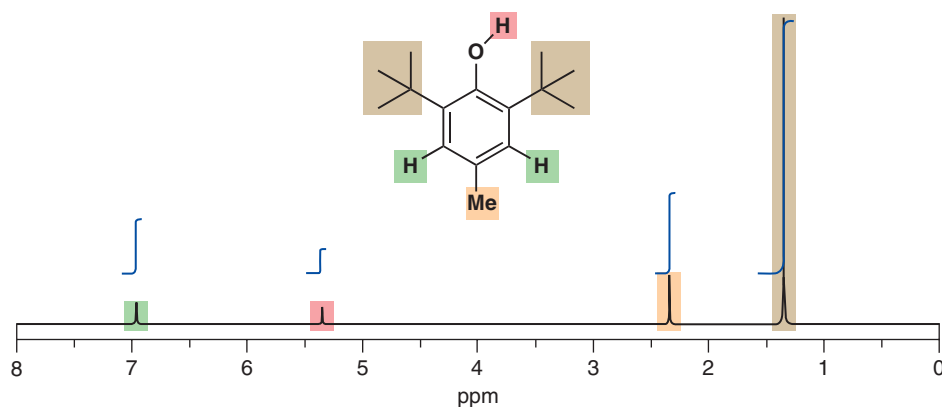

In Chapter 2 you met the antioxidant BHT. Its proton NMR is very simple, consisting of just four lines with integrals 2, 1, 3, and 18. The chemical shifts of the *tert*-butyl group (brown), the methyl group on the benzene ring (orange), and the two identical aromatic protons (green) should cause you no surprise. What is left, the 1 H signal at 5.0 ppm (pink), must be the OH. Earlier in this chapter we saw the spectrum of acetic acid, $\text{CH}_3\text{CO}_2\text{H}$, which showed an OH resonance at 11.2 ppm. Simple alcohols such as *tert*-butanol have OH signals in CDCl_3 (the usual NMR solvent) at around 2 ppm. Why such big differences?

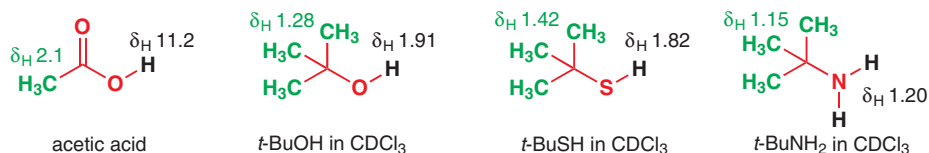

This is a matter of acidity. The more acidic a proton is—that is, the more easily it can escape as H^+ (this is the definition of acidity from Chapter 8)—the more the OH bond is polarized towards oxygen. The more the RO–H bond is polarized, the closer we are to free H^+ , which would have no shielding electrons at all, and so the further the proton goes downfield. The OH chemical shifts and the acidity of the OH group are—to a rough extent at least—related.

	ROH ^a	ArOH ^b	RCO ₂ H ^c
$\text{p}K_a$	16	10	5
$\delta_{\text{H}}(\text{OH})$, ppm	2.0	5.0	>10

^aalcohol ^bphenol ^ccarboxylic acid

Thiols (RSH) behave in a similar way to alcohols but are not so deshielded, as you would expect from the smaller electronegativity of sulfur (phenols are all about 5.0 ppm, PhSH is at 3.41 ppm). Alkane thiols appear at about 2 ppm and arylthiols at about 4 ppm. Amines and amides show a big variation, as you would expect for the variety of functional groups involved, and are summarized below. Amides are slightly acidic, as you saw in Chapter 8, and amide protons resonate at quite low fields. Pyrroles are special—the aromaticity of the ring makes the NH proton unusually acidic—and they appear at about 10 ppm.

chemical shifts of NH protons

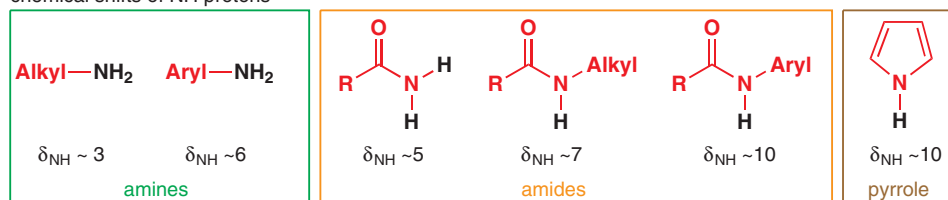

Exchange of acidic protons is revealed in proton NMR spectra

Compounds with very polar groups often dissolve best in water. NMR spectra are usually run in CDCl_3 , but heavy water, D_2O , is an excellent NMR solvent. Here are some results in that medium.

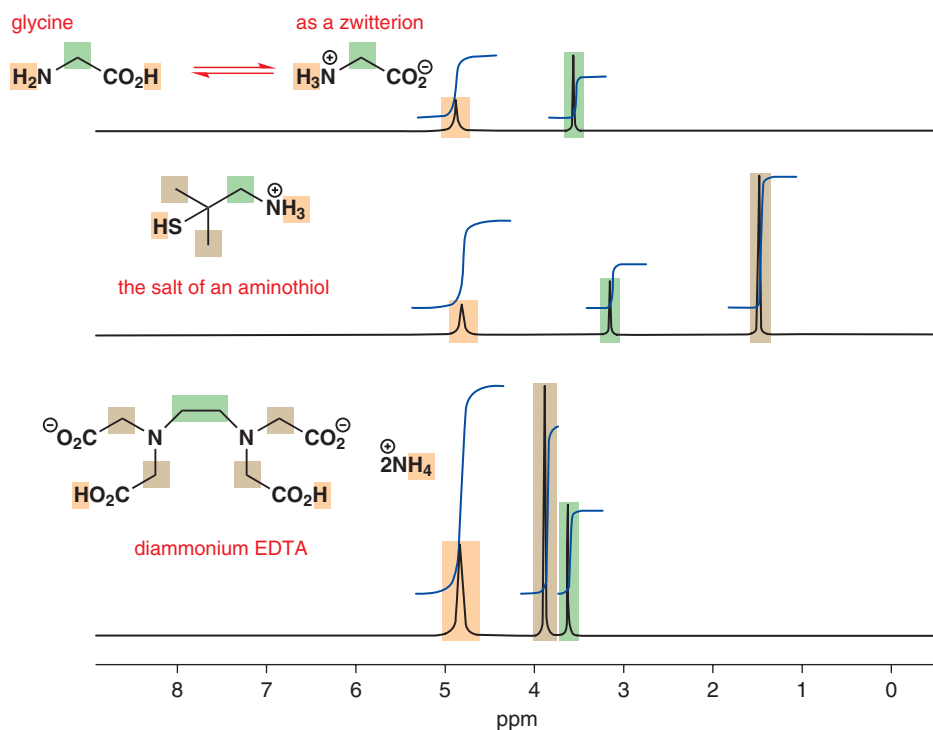

Glycine is expected to exist as a zwitterion (Chapter 8, p. 167). It has a 2H signal (green) for the CH₂ between the two functional groups, which would do for either form. The 3H signal at 4.90 ppm (orange) might suggest the NH₃⁺ group, but wait a moment before making up your mind.



The aminothiol salt has the CMe₂ and CH₂ groups about where we would expect them (brown and green), but the SH and NH₃⁺ protons appear as one 4H signal.

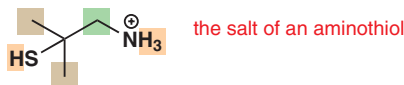

■ EDTA is ethylenediamine tetraacetic acid, an important complexing agent for metals. This is the salt formed with just two equivalents of ammonia.

The double salt of EDTA has several curious features. The two (green) CH₂ groups in the middle are fine, but the other four CH₂ (brown) groups all appear identical, as do all the protons on both the CO₂H and NH₃⁺ groups.

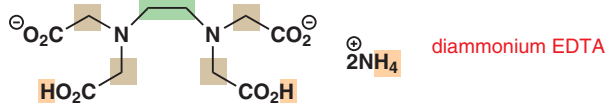

The best clue to why this is so comes from the strange coincidence of the chemical shifts of the OH, NH, and SH protons in these molecules. They are all the same within experimental error: 4.90 ppm for glycine, 4.80 ppm for the aminothiol, and 4.84 ppm for EDTA. In fact all correspond to the same species: HOD, or monodeuterated water. Exchange between XH (where X=O, N, or S) protons is extremely fast, and the solvent, D₂O, supplies a vast excess of exchangeable *deuteriums*. These immediately replace all the OH, NH, and SH protons in the molecules with D, forming HOD in the process. Recall that we do not see signals for deuterium atoms (that's why deuterated solvents are used). They have their own spectra at a different frequency.

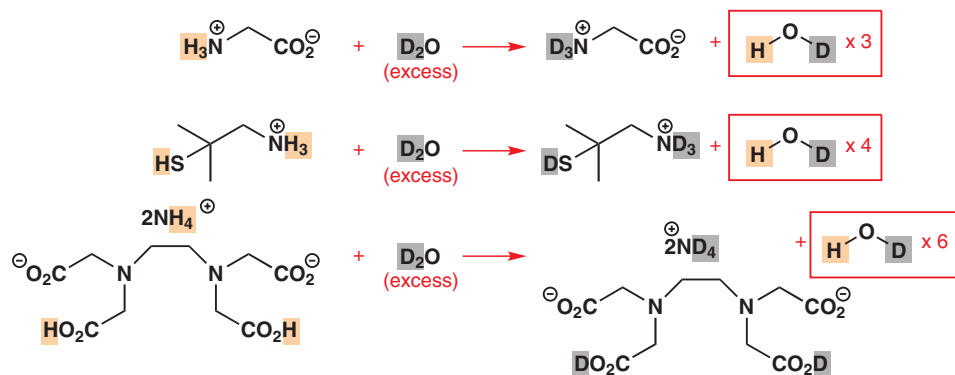

The same sort of exchange between OH or NH protons with each other or with traces of water in the sample means that the OH and NH peaks in most spectra in CDCl_3 are rather broader than the peaks for CH protons.

Two questions remain. First, can we tell whether glycine is a zwitterion in water or not? Not really: the spectra fit either or an equilibrium between both—other evidence leads us to expect the zwitterion in water. Second, why are all four CH_2CO groups in EDTA the same? This we can answer. As well as the equilibrium exchanging the CO_2H protons with the solvent, there will be an equally fast equilibrium exchanging protons between CO_2D and CO_2^- . This makes all four ‘arms’ of EDTA the same.

You should leave this section with an important chemical principle firmly established in your mind.

● **Proton exchange between heteroatoms is fast**

Proton exchange between heteroatoms, particularly O, N, and S, is a very fast process in comparison with other chemical reactions, and often leads to averaged peaks in the ^1H NMR spectrum.

➔ We mentioned this fact before in the context of the mechanism of addition to a $\text{C}=\text{O}$ group (p. 136), and we will continue to explore its mechanistic consequences throughout this book.

Coupling in the proton NMR spectrum

Nearby hydrogen nuclei interact and give multiple peaks

So far proton NMR has been not unlike carbon NMR on a smaller scale. However, we have yet to discuss the real strength of proton NMR, something more important than chemical shifts and something that allows us to look not just at individual atoms but also at the way the C–H skeleton is joined together. This is the result of the interaction between nearby protons, known as *coupling*.

An example we could have chosen in the last section is the nucleic acid component cytosine, which has exchanging NH_2 and NH protons giving a peak for HOD at 4.5 ppm. We didn’t choose this example because the other two peaks would have puzzled you. Instead of giving just one line for each proton, they give two lines each—doublets as you will learn to call them—and it is time to discuss the origin of this ‘coupling’.

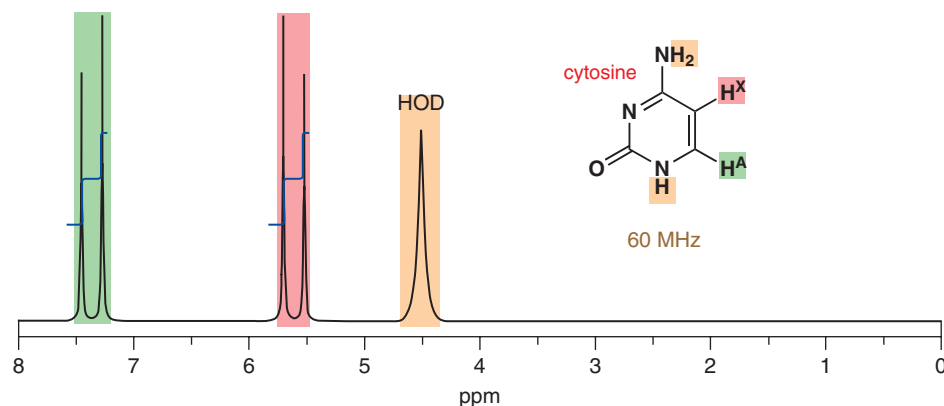

■ Cytosine is one of the four bases that, in combination with deoxyribose and phosphate, make up DNA. It is a member of the class of heterocycles called pyrimidines. We come back to the chemistry of DNA towards the end of this book, in Chapter 42.

You might have expected a spectrum like that of the heterocycle below, which like cytosine is also a pyrimidine. It too has exchanging NH₂ protons and two protons on the heterocyclic ring. But these two protons give the expected two lines instead of the four lines in the cytosine spectrum. It is easy to assign the spectrum: the green proton labelled H^A is attached to an aldehyde-like C=N and so comes at lowest field. The red proton labelled H^X is *ortho* to two electron-donating NH₂ groups and so comes at high field for an aromatic proton (p. 272). These protons do not couple with each other because they are too far apart. They are separated by five bonds whereas the ring protons in cytosine are separated by just three bonds.

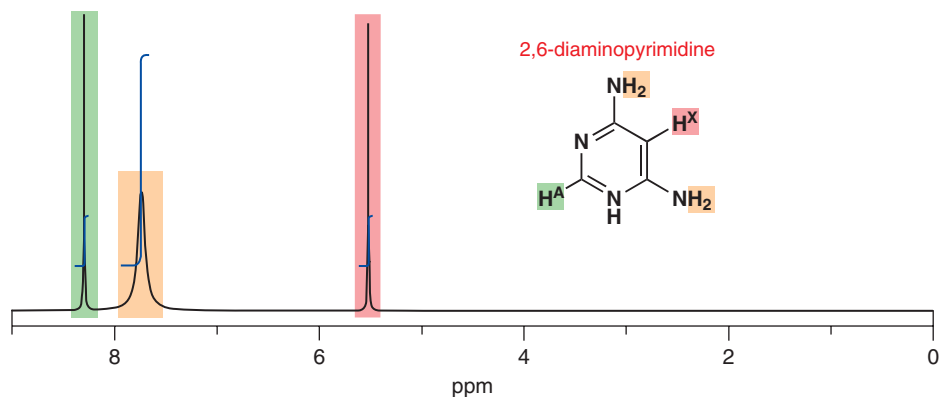

Understanding this phenomenon is so important that we are going to explain it in three different ways—you choose which appeals to you most. Each method offers a different insight.

The diaminopyrimidine spectrum you have just seen has two single lines (*singlets* we shall call them from now on) because each proton, H^A or H^X, can be aligned either with or against the applied magnetic field. The cytosine spectrum is different because each proton, say H^A, is near enough to experience the small magnetic field of the other proton H^X as well as the field of the magnet itself. The diagram shows the result.

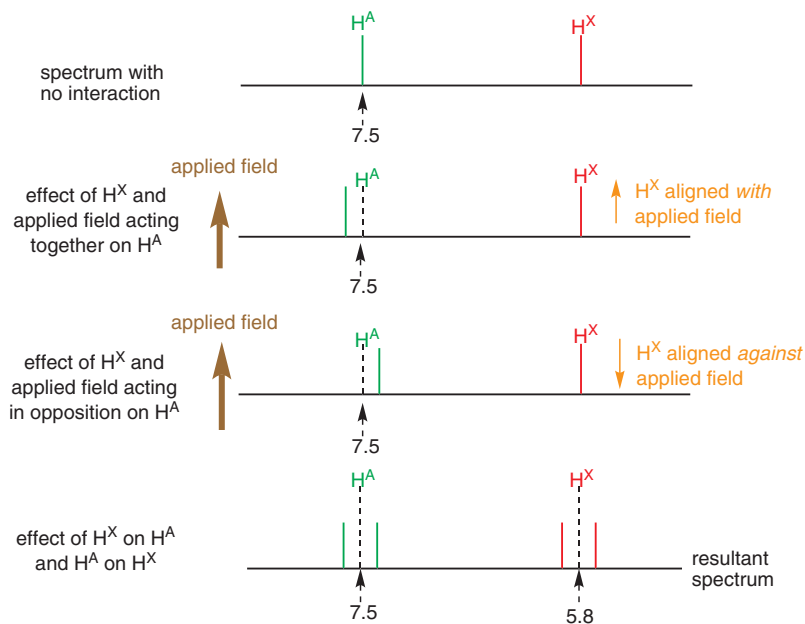

If each proton interacted only with the applied field we would get two singlets. But proton H^A actually experiences two slightly different fields: the applied field *plus* the field of

H^X or the applied field *minus* the field of H^X . H^X acts either to increase or decrease the field experienced by H^A . The position of a resonance depends on the field experienced by the proton so these two situations give rise to two slightly different peaks—a *doublet* as we shall call it. And whatever happens to H^A happens to H^X as well, so the spectrum has two doublets, one for each proton. Each couples with the other. The field of a proton is a very small indeed in comparison with the field of the magnet and the separation between the lines of a doublet is very small. We shall discuss the size of the coupling later (pp. 294–300).

The second explanation takes into account the energy levels of the nucleus. In Chapter 4, when we discussed chemical bonds, we imagined electronic energy levels on neighbouring atoms interacting with each other and splitting to produce new molecular energy levels, some higher in energy and some lower in energy than the original atomic energy levels. When hydrogen *nuclei* are near each other in a molecule, the nuclear energy levels also interact and split to produce new energy levels. If a single hydrogen nucleus interacts with a magnetic field, we have the picture on p. 270 of this chapter: there are *two* energy levels as the nucleus can be aligned with or against the applied magnetic field, there is one energy jump possible, and there is a resonance at one frequency. This you have now seen many times and it can be summarized as shown below.

energy levels for one isolated nucleus

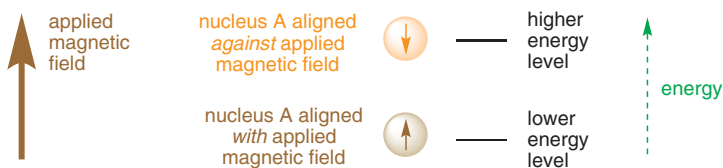

The spectrum of the pyrimidine on p. 286 shows exactly this situation: two protons well separated in the molecules and each behaving independently. Each has two energy levels, each gives a singlet, and there are two lines in the spectrum. But in cytosine, whose spectrum is shown on p. 285, the situation is different: each hydrogen atom has another hydrogen nucleus nearby and there are now *four* energy levels. Each nucleus H^A and H^X can be aligned with or against the applied field. There is one (lower) energy level where they are both aligned with the field and one (higher) level where they are both aligned against. In between there are two different energy levels in which one nucleus is aligned with the field and one against. Exciting H from alignment with to alignment against the applied field can be done in two slightly different ways, shown as A_1 and A_2 on the diagram. The result is two resonances very close together in the spectrum.

energy levels for two interacting nuclei

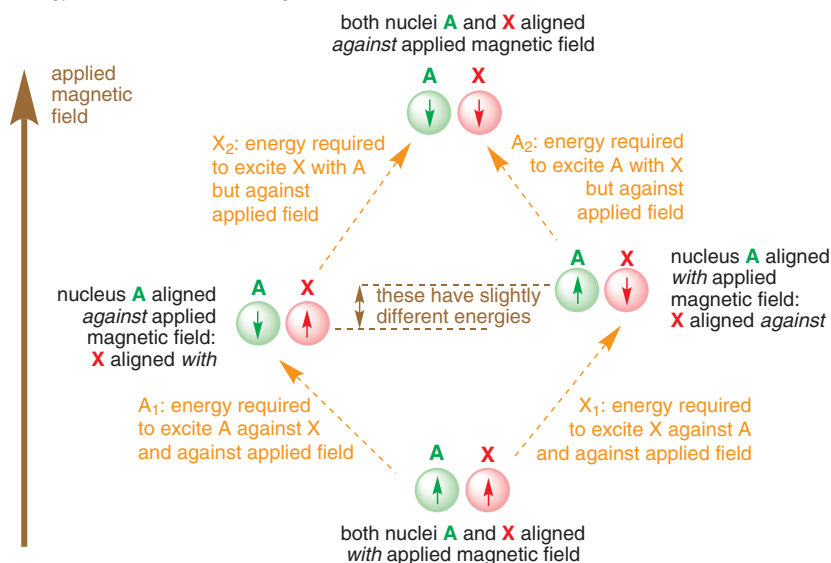

Please notice carefully that we cannot have this discussion about H^A without discussing H^X in the same way. If there are two slightly different energy jumps to excite H^A, there must also be two slightly different energy jumps to excite H^X. A₁, A₂, X₁, and X₂ are all different, but the *difference* between A₁ and A₂ is exactly the same as the *difference* between X₁ and X₂. Each proton now gives two lines (a doublet) in the NMR spectrum and the splitting of the two doublets is *exactly the same*. We describe this situation as coupling. We say 'A and X are coupled' or 'X is coupled to A' (and vice versa, of course). We shall be using this language from now on and so must you.

Now look back at the spectrum of cytosine at the beginning of this section. You can see the two doublets, one for each of the protons on the aromatic ring. Each is split by the same amount (this is easy to check with a ruler). The separation of the lines is the **coupling constant** and is called *J*. In this case *J* = 4 Hz. Why do we measure *J* in hertz and not in ppm? We pointed out on p. 55 (Chapter 3) that we measure chemical shifts in ppm because we get the same number regardless of the rating of the NMR machine in MHz. We measure *J* in Hz because we also get the same number regardless of the machine.

■ Spectrometers in common use typically have field strengths of 200–500 MHz.

The spectra below show ¹H NMR spectra of the same compound run on two different NMR machines—one a 90 MHz spectrometer and one a 300 MHz spectrometer (these are at the lower and upper ends of the range of field strengths in common use). Notice that the peaks stay in the same place on the chemical shift scale (ppm) but the size of the coupling appears to change because 1 ppm is worth 90 Hz in the top spectrum but 300 Hz in the bottom.

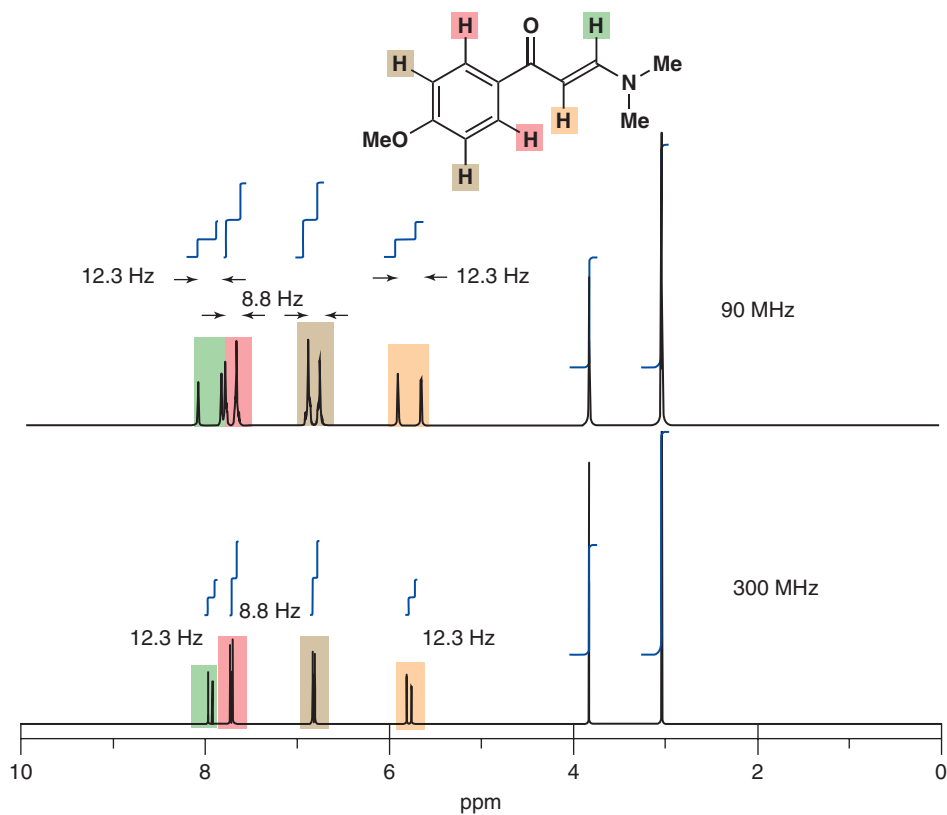

Measuring coupling constants in hertz

To measure a coupling constant it is essential to know the rating of the NMR machine in MHz (megahertz). This is why you are told that each illustrated spectrum is, say, a '400 MHz ¹H NMR spectrum'. Couplings may be marked on the spectrum, electronically, but if not then to measure the coupling, measure the distance between the lines by ruler or dividers and use the horizontal scale to find out the separation in ppm. The conversion is then easy—to turn parts per million of megahertz into hertz you just leave out the million! So 1 ppm on a 300 MHz machine is 300 Hz. On a 500 MHz machine, a 10 Hz coupling is a splitting of 0.02 ppm.

● Spectra from different machines

When you change from one machine to another, say, from a 200 MHz to a 500 MHz NMR machine, chemical shifts (δ) stay the same in ppm and coupling constants (J) stay the same in Hz.

Now for the third way to describe coupling. If you look again at what the spectrum would be like without interaction between H^A and H^X you will see the pattern on the right, with the chemical shift of each proton clearly obvious.

But you don't see this because each proton couples with the other and splits its signal by an equal amount either side of the true chemical shift. The true spectrum has a pair of doublets each split by an identical amount. Note that no line appears at the true chemical shift, but it is easy to measure the chemical shift by taking the midpoint of the doublet.

So this spectrum would be described as δ_H 7.5 (1H, d, J 4 Hz, H^A) and 5.8 (1H, d, J 4 Hz, H^X). The main number gives the chemical shift in ppm and then, in brackets, comes the integration as the number of Hs, the shape of the signal (here 'd' for doublet), the size of coupling constants in Hz, and the assignment, usually related to a diagram. The integration refers to the combined area under both peaks in the doublet. If the doublet is exactly symmetrical, each peak integrates to half a proton. The combined signal, however complicated, integrates to the right number of protons.

We have described these protons as A and X with a purpose in mind. A spectrum of two equal doublets is called an AX spectrum. A is always the proton you are discussing and X is another proton with a different chemical shift. The alphabet is used as a ruler: nearby protons (on the chemical shift scale—not necessarily nearby in the structure!) are called B, C, etc. and distant ones are called X, Y, etc. You will see the reason for this soon.

If there are more protons involved, the splitting process continues. Here is the NMR spectrum of a famous perfumery compound supposed to have the smell of 'green leaf lilac'. The compound is an acetal with five nearly identical aromatic protons at the normal benzene position (7.2–7.3 ppm) and six protons on two identical OMe groups.

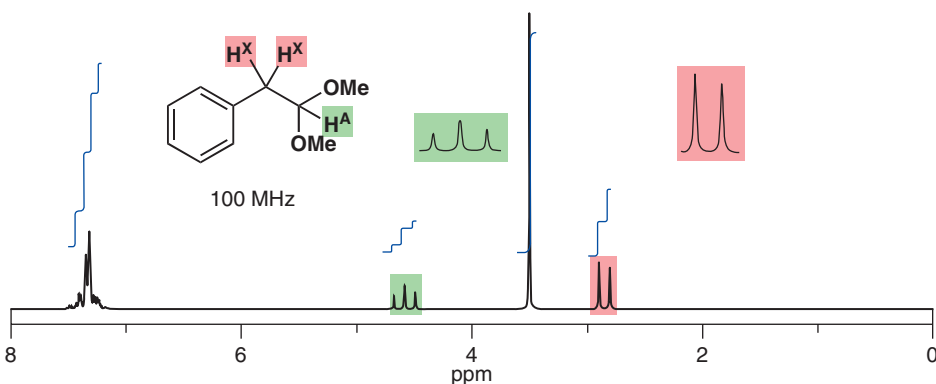

It is the remaining three protons that interest us. They appear as a 2H doublet at 2.9 ppm and a 1H *triplet* at 4.6 ppm. In NMR talk, triplet means three equally spaced lines in the ratio 1:2:1. The triplet arises from the three possible states of the two identical protons in the CH₂ group.

If one proton H^A interacts with two protons H^X , it can experience protons H^X in three different possible states. Both protons H^X can be aligned with the magnet or both against. These states will increase or decrease the applied field just as before. But if one proton H^X is aligned with and one against the applied field, there is no net change to the field experienced by H^A . There are two arrangements for this (see diagram overleaf). We'll therefore see a signal of double intensity for H^A at the correct chemical shift, one signal at higher field and one at lower field. In other words, a 1:2:1 triplet.

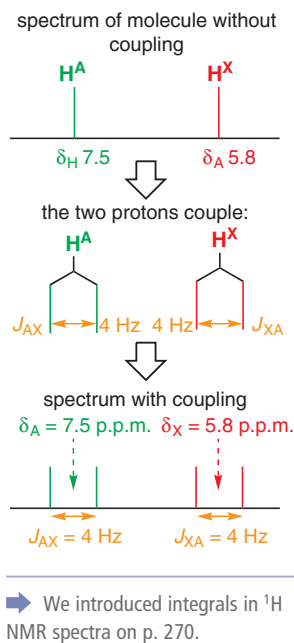

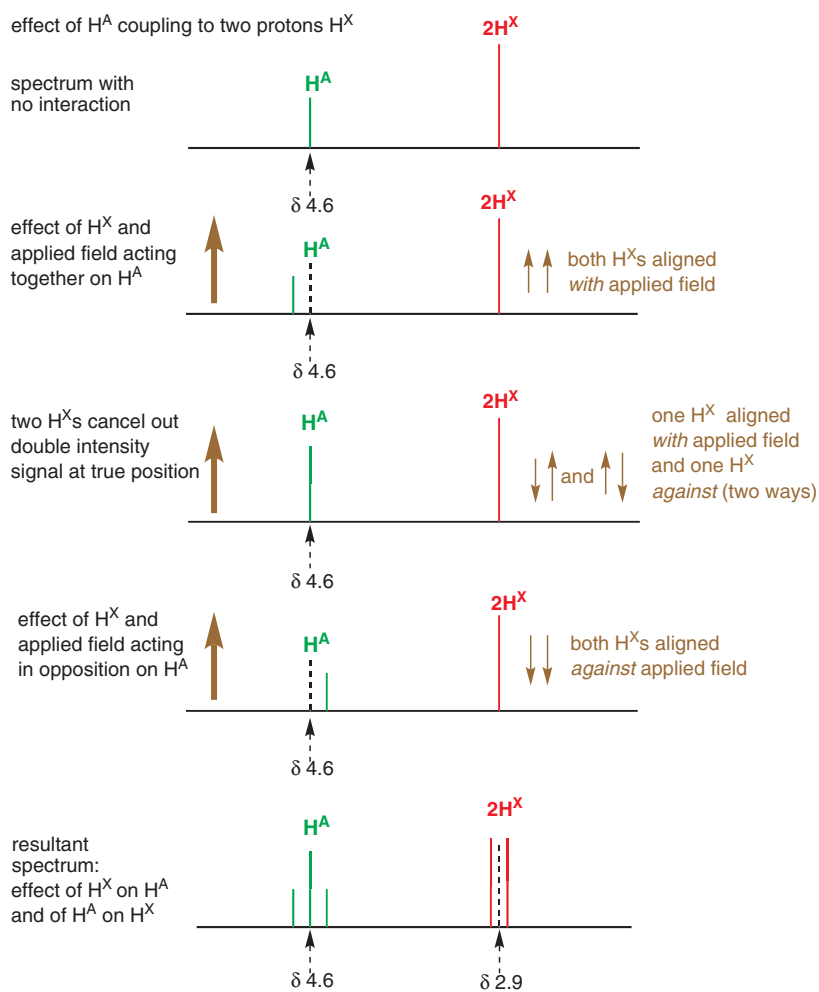

We could look at this result by our other methods too. There is one way in which both nuclei can be aligned with and one way in which both can be aligned against the applied field, but two ways in which they can be aligned one with and one against. Proton H^A interacts with each of these states. The result is a 1:2:1 triplet.

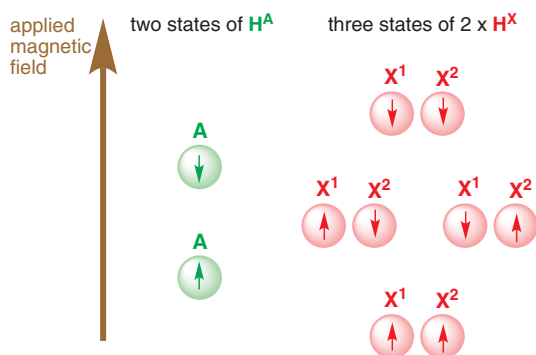

Using our third way of seeing coupling to see how the triplet arises, we can just make the peaks split in successive stages:

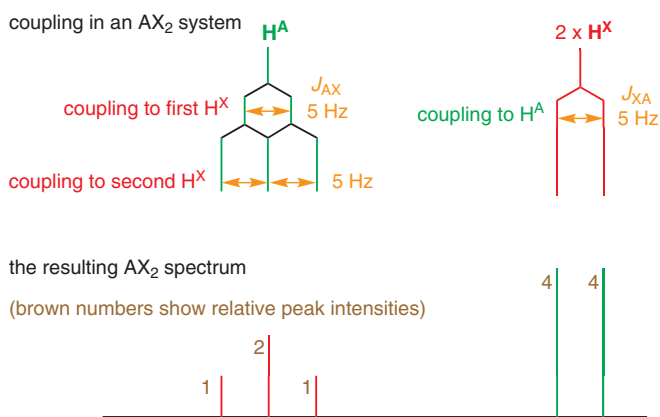

If there are more protons involved, we continue to get more complex systems, but the intensities can all be deduced simply from Pascal's triangle, which gives the coefficients in a binomial expansion. If you are unfamiliar with this simple device, here it is.

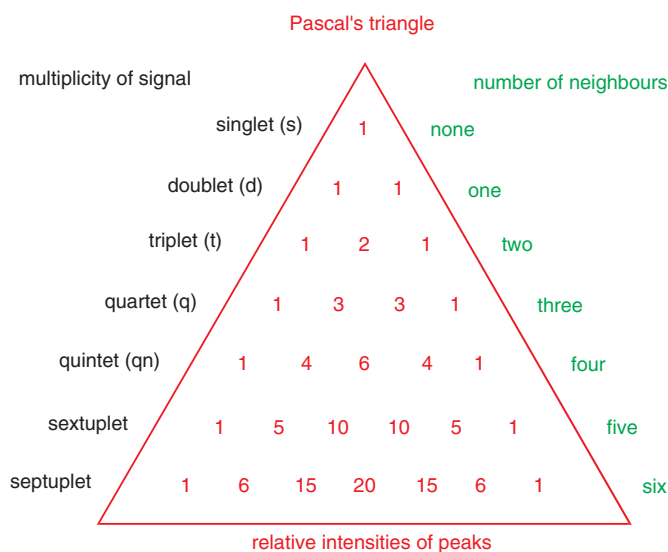

Constructing Pascal's triangle

Put '1' at the top and then add an extra number in each line by adding together the numbers on either side of the new number in the line above. If there is no number on one side, that counts as a zero, so the lines always begin and end with '1'.

You can read off from the triangle what pattern you may expect when a proton is coupled to n equivalent neighbours. There are always $n + 1$ peaks with the intensities shown by the triangle. So far, you've seen 1:1 doublets (line 2 of the triangle) from coupling to 1 proton, and 1:2:1 triplets (line 3) from coupling to 2. You will often meet ethyl groups (CH₃CH₂X), where the CH₂ group couples to three identical protons and appears as a 1:3:3:1 quartet and the methyl group as a 1:2:1 triplet. In isopropyl groups, (CH₃)₂CHX, the methyl groups appear as a 6H doublet and the CH group as a septuplet.

Here is a simple example: the four-membered cyclic ether oxetane. Its NMR spectrum has a 4H triplet for the two identical CH₂ groups next to oxygen and a 2H quintet for the CH₂ in the middle. Each proton H^X 'sees' four identical neighbours (H^A) and is split equally by them all to give a 1:4:6:4:1 quintet. Each proton H^A 'sees' two identical neighbours H^X and is split into a 1:2:1 triplet. The combined integral of all the lines in the quintet together is 2 and of all the lines in the triplet is 4.

Identical protons do not couple with themselves

Remember, the coupling comes only from the *neighbouring* protons: it doesn't matter how many protons form the signal itself (2 for H^X, 4 for H^A)—it's how many are next door (4 next to H^X, 2 next to H^A) that matters. The protons in each CH₂ group are identical and cannot couple with each other. It's *what you see* that counts not *what you are*.

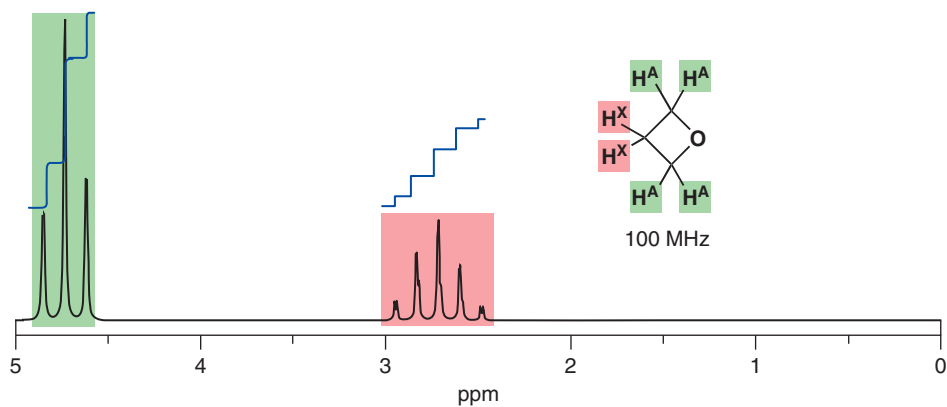

A slightly more complicated example is the diethyl acetal below. It has a simple AX pair of doublets for the two protons on the 'backbone' (red and green) and a typical ethyl group (2H quartet and 3H triplet). An ethyl group is attached to only one substituent through its CH₂ group, so the chemical shift of that CH₂ group tells us what it is joined to. Here the peak at 3.76 ppm can only be an OEt group. There are, of course, two identical CH₂ groups in this molecule.

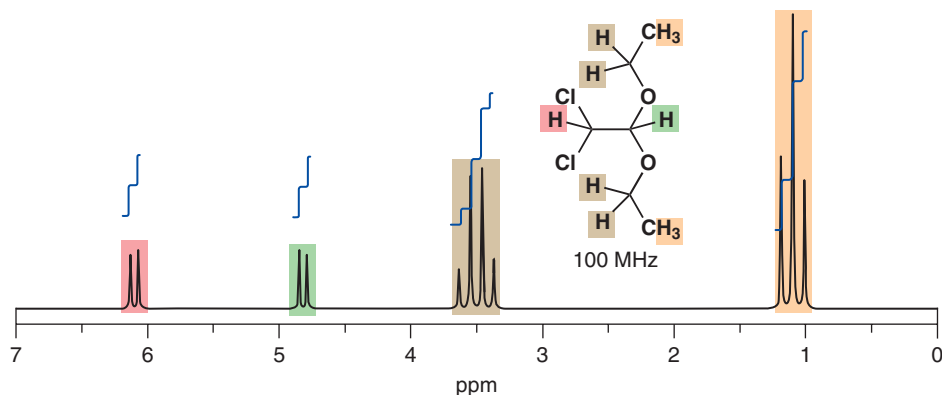

In all of these molecules, a proton may have had several neighbours, but all those neighbours have been the same. And therefore all the *coupling constants* have been the same. What happens when coupling constants differ? Chrysanthenic acid, the structural core of the insecticides produced by pyrethrum flowers, gives an example of the simplest situation—where a proton has two different neighbours.

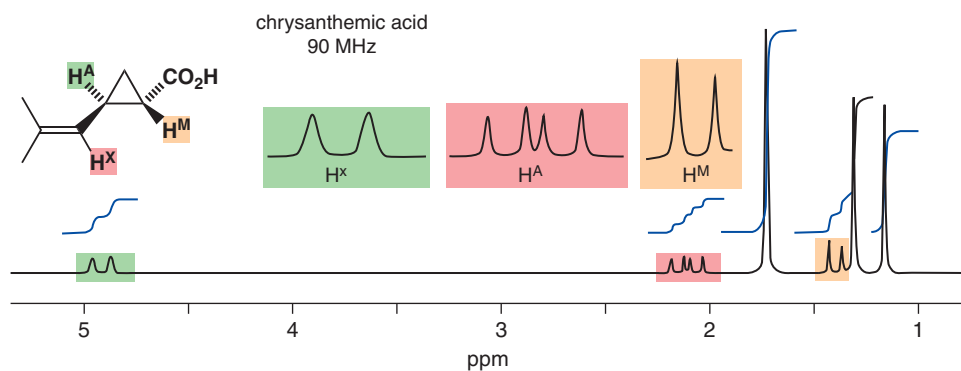

Chrysanthemic acid has a carboxylic acid, an alkene, and two methyl groups on the three-membered ring. Proton H^A has two neighbours, H^X and H^M . The coupling constant to H^X is 8 Hz, and that to H^M is 5.5 Hz. We can construct the splitting pattern as shown on the right.

The result is four lines of equal intensity called a **double doublet** (or sometimes a **doublet of doublets**), abbreviation dd. The smaller coupling constant can be read off from the separation between lines 1 and 2 or between lines 3 and 4, while the larger coupling constant is between lines 1 and 3 or between lines 2 and 4. The separation between the middle two lines is not a coupling constant. You could view a double doublet as an imperfect triplet where the second coupling is too small to bring the central lines together: alternatively, look at a triplet as a special case of a double doublet where the two couplings are identical and the two middle lines coincide.

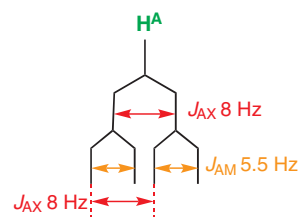

Abbreviations used for style of signal

Abbreviation	Meaning	Comments
s	singlet	
d	doublet	equal in height
t	triplet	should be 1:2:1
q	quartet	should be 1:3:3:1
dt	double triplet	other combinations too, such as dd, dq, tt
m	multiplet	a signal too complicated to resolve*

* Either because it contains a complex coupling pattern or because the signals from different protons overlap.

Coupling is a through-bond effect

Do neighbouring nuclei interact through space or through the electrons in the bonds? We know that coupling is in fact a 'through-bond effect' because of the way coupling constants vary with the shape of the molecule. The most important case occurs when the protons are at either end of a double bond. If the two hydrogens are *cis*, the coupling constant J is typically about 10 Hz, but if they are *trans*, J is much larger, usually 15–18 Hz. These two chloro acids are good examples.



If coupling were through space, the nearer *cis* hydrogens would have the larger J . In fact, coupling occurs *through the bonds* and the more perfect parallel alignment of the bonds in the *trans* compound provides better communication and a larger J .

Coupling is at least as helpful as chemical shift in assigning spectra. When we said (p. 280) that the protons on cyclohexenone had the chemical shifts shown, how did we know? It was coupling that told us the answer. The proton next to the carbonyl group (H^2 in the diagram) has one neighbour (H^3) and appears as a doublet with $J = 11$ Hz, just right for a proton on a double bond with a *cis* neighbour. The proton H^3 itself appears as a double triplet. Inside each triplet the separation of the lines is 4 Hz and the two triplets are 11 Hz apart.

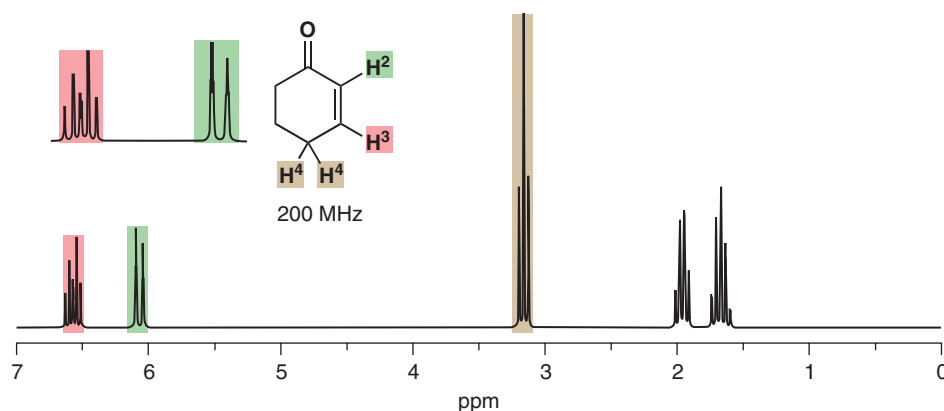

The coupling of H^3 is as complex as you have seen yet, but it can be represented diagrammatically by the same approach we have taken before.

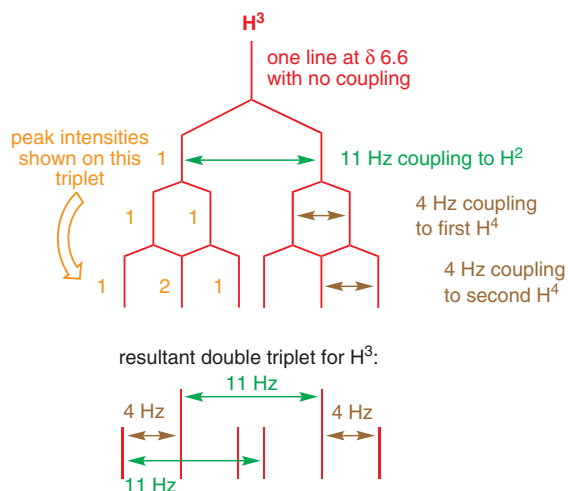

As coupling gets more and more complicated it can be hard to interpret the results, but *if you know what you are looking for* things do become easier. Here is the example of heptan-2-one. The green protons next to the carbonyl group are a 2H triplet (coupled to the two red protons) with J 7 Hz. The red protons themselves are next to four protons, and although these four protons are not identical the coupling constants are about the same: the red protons therefore appear as a 2H quintet, with a coupling constant also of 7 Hz. The brown signal is more complicated: we might call it a '4H multiplet' but in fact we know what it must be: the signals for the four brown protons on carbons 5 and 6 overlap, and must be made up of a 2H quintet (protons on C5) and a 2H sextet (protons on C6). We can see the coupling of the protons on C6 with the terminal methyl group because the methyl group (orange) is a 3H triplet (also with a 7 Hz coupling constant).

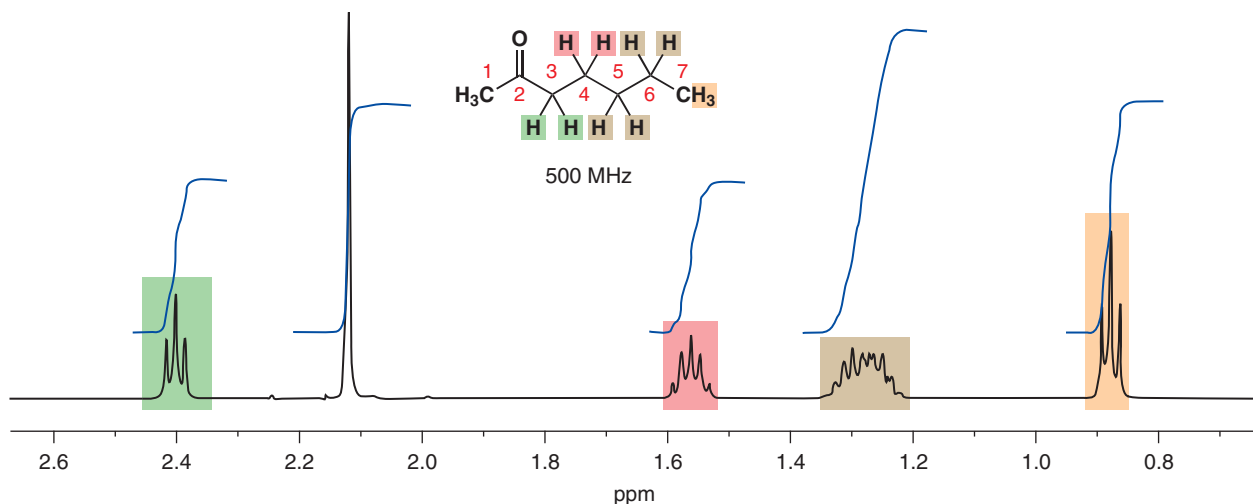

Coupling constants depend on three factors

The coupling constants in cyclohexenone were different, but all the coupling constants in heptanone are about the same—around 7 Hz. Why?

● Factors affecting coupling constants

- Through-bond distance between the protons.
- Angle between the two C–H bonds.
- Electronegative substituents.

The coupling constants we have seen so far have all been between hydrogen atoms on neighbouring carbon atoms—in other words, the coupling is through three bonds (H–C–C–H) and is designated ${}^3J_{\text{HH}}$. These coupling constants ${}^3J_{\text{HH}}$ are usually about 7 Hz in an open-chain, freely rotating system such as we have in heptanone. The C–H bonds vary little in length but in cyclohexenone the C–C bond is a double bond, significantly shorter than a single bond. Couplings (${}^3J_{\text{HH}}$) across double bonds are usually larger than 7 Hz (11 Hz in cyclohexenone). ${}^3J_{\text{HH}}$ couplings are called *vicinal couplings* because the protons concerned are on neighbouring carbon atoms.

Something else is different too: in an open-chain system we have a time average of all rotational conformations (we will look at this in the next chapter). But across a double bond there is no rotation and the angle between the two C–H bonds is fixed: they are always in the same plane. In the plane of the alkene, the C–H bonds are either at 60° (*cis*) or 180° (*trans*) to each other. Coupling constants in benzene rings are slightly less than those across *cis* alkenes because the bond is longer (bond order 1.5 rather than 2).

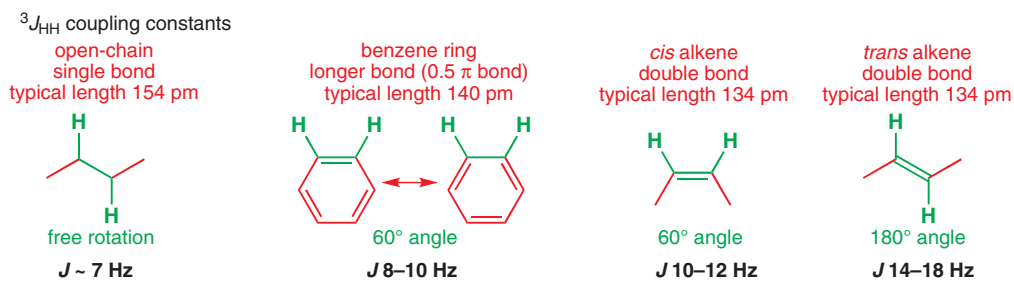

In naphthalenes, there are unequal bond lengths around the two rings. The bond between the two rings is the shortest, and the lengths of the others are shown. Coupling across the shorter bond (8 Hz) is significantly stronger than coupling across the longer bond (6.5 Hz).

The effect of the third factor, electronegativity, is easily seen in the comparison between ordinary alkenes and alkenes with alkoxy substituents, known as enol ethers. We are going to compare two pairs of compounds with a *cis* or a *trans* double bond. One pair has a phenyl group at one end of the alkene and the other has an OPh group. For either pair, the *trans* coupling is larger than the *cis*, as you would now expect. But if you compare the two pairs, the enol ethers have much smaller coupling constants. The *trans* coupling for the enol ethers is only just larger than the *cis* coupling for the alkenes. The electronegative oxygen atom is withdrawing electrons from the C–H bond in the enol ethers and weakening communication through the bonds.

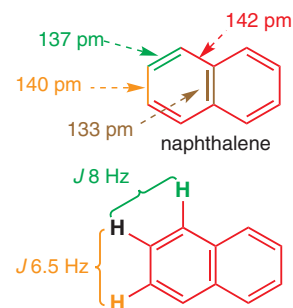

➔ Conjugation in naphthalene was discussed in Chapter 7, p. 161.

effect of electronegative substituents on ${}^3J_{\text{HH}}$ – alkenes and enol ethers



Long-range coupling

When the through-bond distance gets longer than three bonds, coupling is not usually seen. To put it another way, four-bond coupling ${}^4J_{\text{HH}}$ is usually zero. However, it is seen in some special cases, the most important being *meta* coupling in aromatic rings and allylic coupling in alkenes. In both, the orbitals between the two hydrogen atoms can line up in a zig-zag

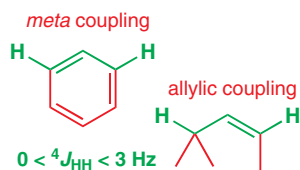

fashion to maximize interaction. This arrangement looks rather like a letter 'W' and this sort of coupling is called W-coupling. Even with this advantage, values of ${}^4J_{\text{HH}}$ are usually small, about 1–3 Hz.

Meta coupling is very common when there is *ortho* coupling as well, but here is an example where there is no *ortho* coupling because none of the aromatic protons have immediate neighbours—the only coupling is *meta* coupling. There are two identical H^As, which have one *meta* neighbour and appear as a 2H doublet. Proton H^X between the two MeO groups has two identical *meta* neighbours and so appears as a 1H triplet. The coupling is small ($J \sim 2.5 \text{ Hz}$).

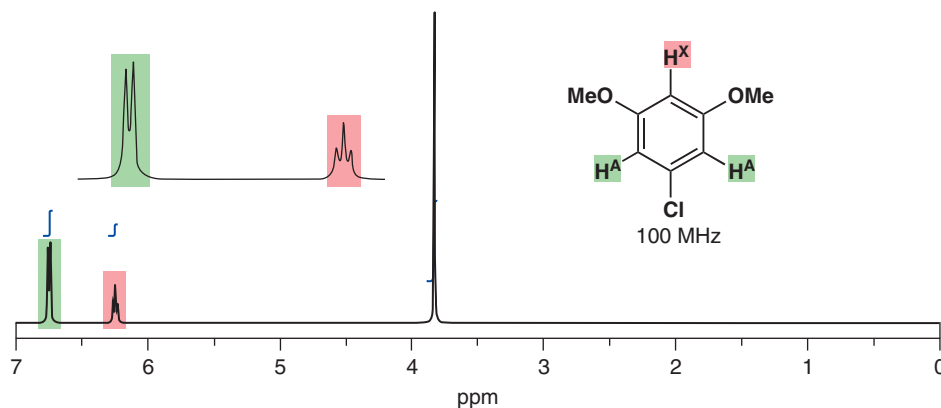

We have already seen a molecule with allylic coupling. We discussed in some detail why cyclohexenone has a double triplet for H³. But it also has a less obvious double triplet for H². The triplet coupling is less obvious since J is small (about 2 Hz) because it is ${}^4J_{\text{HH}}$ —allylic coupling to the CH₂ group at C4. Here is a diagram of the coupling, which you would be able to spot in an expansion of the cyclohexenone spectrum on p. 293.

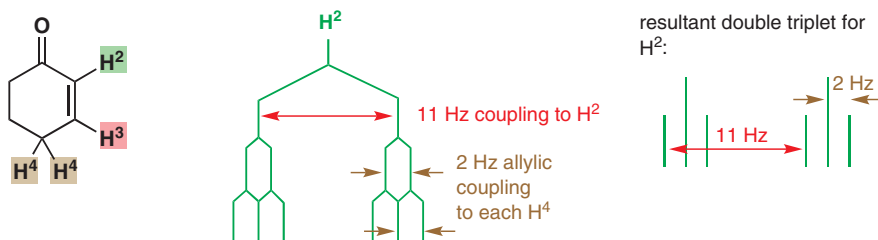

Coupling between similar protons

Identical protons do not couple with each other. The three protons in a methyl group may couple to some other protons, but *never* couple with each other. They are an A₃ system. Identical neighbours do not couple either. Turn back to p. 271 and you'll see that even though each of the four protons on the *para*-disubstituted benzenes has one neighbour, they appear as one singlet because every proton is identical to its neighbour.

We have also seen how two different protons forming an AX system give two separate doublets. Now we need to see what happens to protons in between these two extremes. What happens to two similar neighbours? As two protons get closer and closer together, do the two doublets you see in the AX system suddenly collapse to the singlet of the A₂ system? You have probably guessed that they do not. The transition is gradual. Suppose we have two different neighbours on an aromatic ring. The spectra below show what we see. These are all 1,4-disubstituted benzene rings with different groups at the 1 and 4 positions.

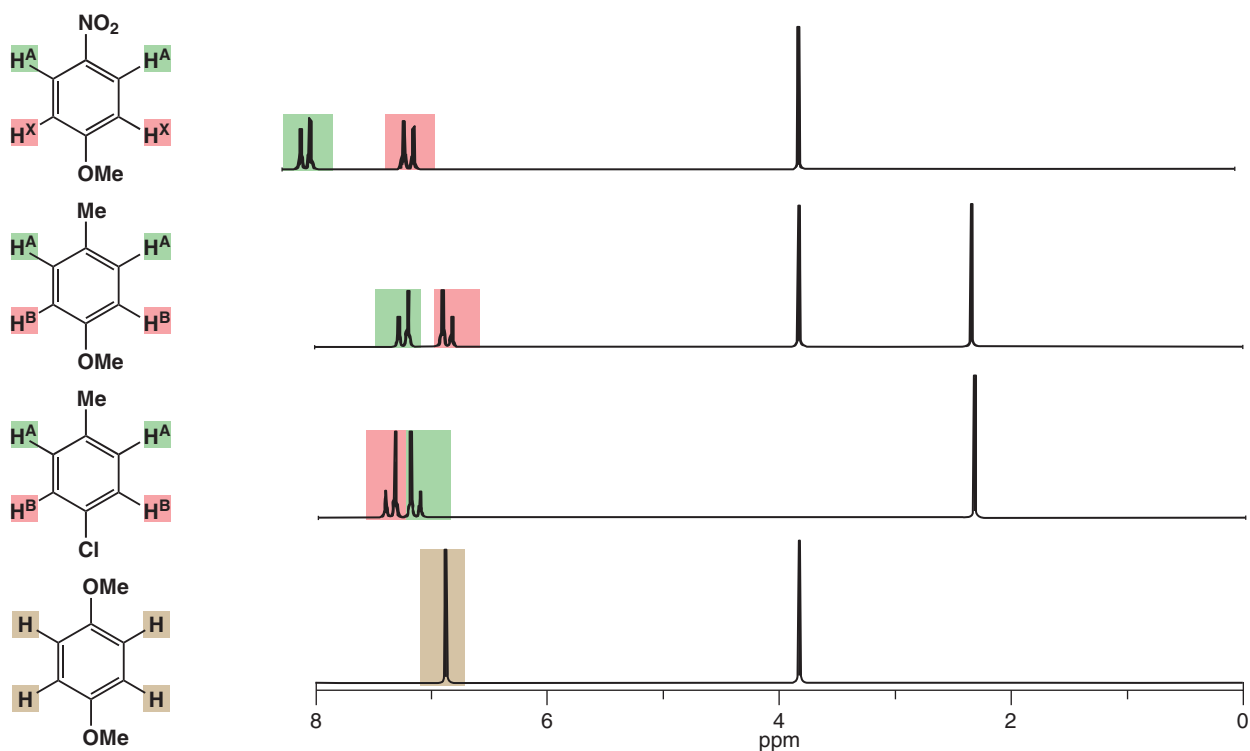

You'll notice that when the two doublets are far apart, as in the first spectrum, they look like normal doublets. But as they get closer together the doublets get more and more distorted, until finally they are identical and collapse to a 4H singlet.

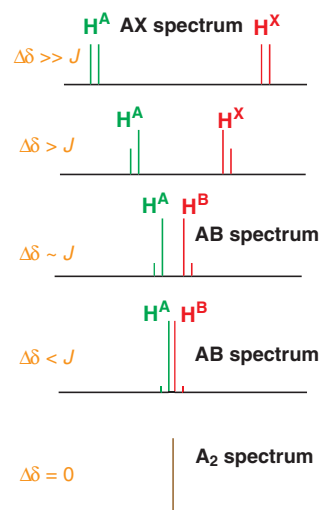
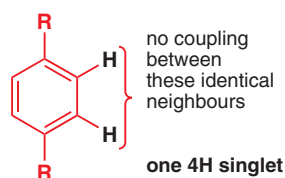
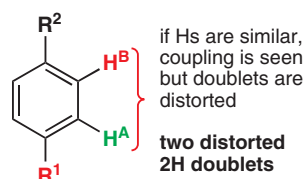
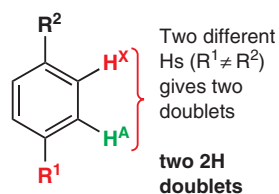

The critical factor in the shape of the peak is how the difference between the chemical shifts of the two protons ($\Delta\delta$) compares with the size of the coupling constant (J) for the machine in question. If $\Delta\delta$ is much larger than J there is no distortion: if, say, $\Delta\delta$ is 2 ppm at 500 MHz (= 1000 Hz) and the coupling constant is a normal 7 Hz, then this condition is fulfilled and we have an AX spectrum of two 1:1 doublets. As $\Delta\delta$ approaches J in size, so the inner lines of the two doublets increase and the outer lines decrease until, when $\Delta\delta$ is zero, the outer lines vanish away altogether and we are left with the two superimposed inner lines—a singlet or an A_2 spectrum. You can see this progression in the diagram on the right.

■ You may see this situation described as an 'AB quartet'. It isn't! A quartet is an exactly equally spaced 1:3:3:1 system arising from coupling to three identical protons, and you should avoid this misleading usage.

We call the last stages, where the distortion is great but the protons are still different, an AB spectrum because you cannot really talk about H^A without also talking about H^B. The two inner lines may be closer than the gap between the doublets or the four lines may all be equally spaced. Two versions of an AB spectrum are shown in the diagram—there are many more variations.

It is a generally useful tip that a distorted doublet 'points' towards the protons with which it is coupled.

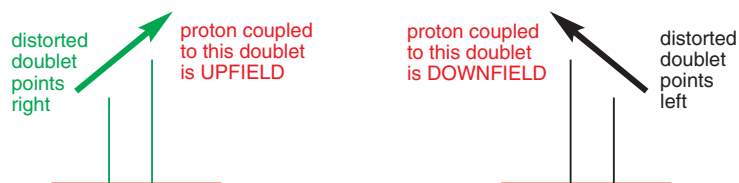

Or, to put it another way, the AB system is 'roofed' with the usual arrangement of low walls and a high middle to the roof. Look out for doublets (or any other coupled signals) of this kind.

We shall end this section with a final example illustrating *para*-disubstituted benzenes and roofing as well as an ABX system and an isopropyl group. The aromatic ring protons form a pair of distorted doublets (2H each), showing that the compound is a *para*-disubstituted benzene. Then the alkene protons form the AB part of an ABX spectrum. They are coupled to each other with a large (*trans*) $J = 16$ Hz and one is also coupled to another distant proton. The large doublets are distorted (AB) but the small doublets within the right-hand half of the AB system are equal in height. The distant proton X is part of an *i*-Pr group and is coupled to H^B and the six identical methyl protons. Both J s are nearly the same so it is split by seven protons and is an octuplet. It looks like a sextuplet because the intensity ratios of the lines in an octuplet would be 1:7:21:35:35:21:7:1 (from Pascal's triangle) and it is hardly surprising that the outside lines disappear.

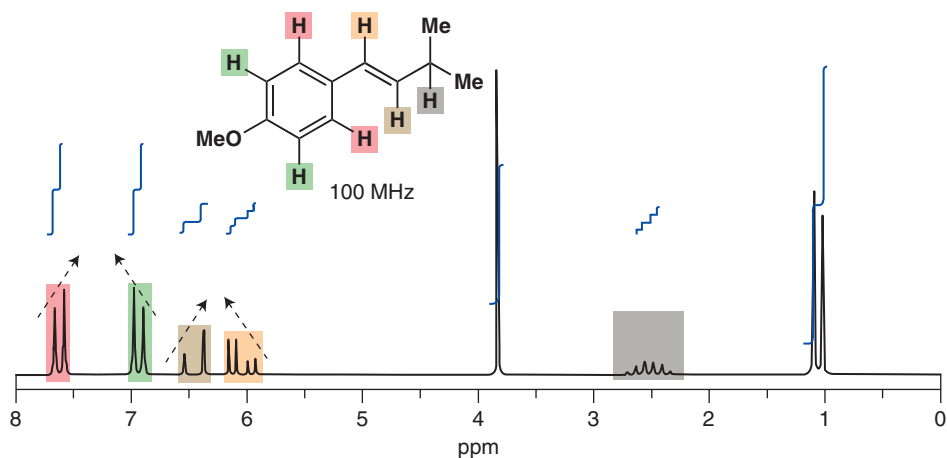

Coupling can occur between protons on the same carbon atom

We have seen cases where protons on the same carbon atom are different: compounds with an alkene unsubstituted at one end. If these protons are different (and they are certainly near to each other), then they should couple. They do, but in this case the coupling constant is usually very small. Here is the spectrum of an example you met on p. 281.

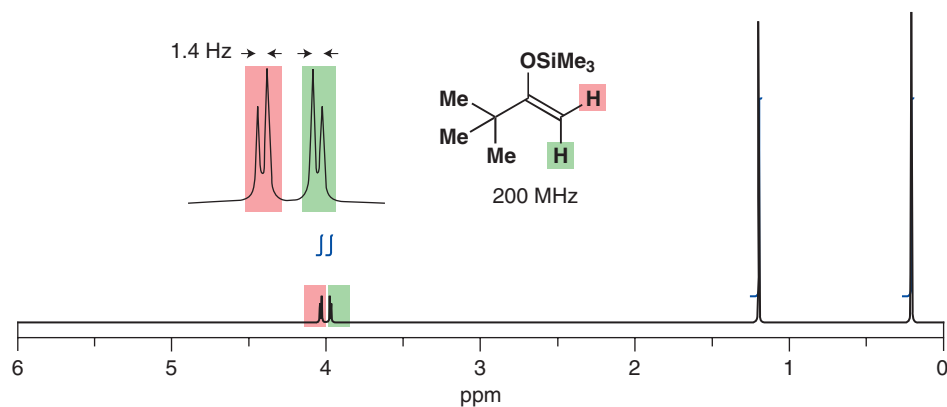

The small 1.4 Hz coupling is a $^2J_{\text{HH}}$ coupling between two protons on the same carbon that are different because there is no rotation about the double bond. $^2J_{\text{HH}}$ coupling is called *geminal coupling*.

This means that a monosubstituted alkene (a vinyl group) will have characteristic signals for each of the three protons on the double bond. Here is the example of ethyl acrylate (ethyl propenoate, a monomer for the formation of acrylic polymers). The spectrum looks rather complex at first, but it is easy to sort out using the coupling constants.

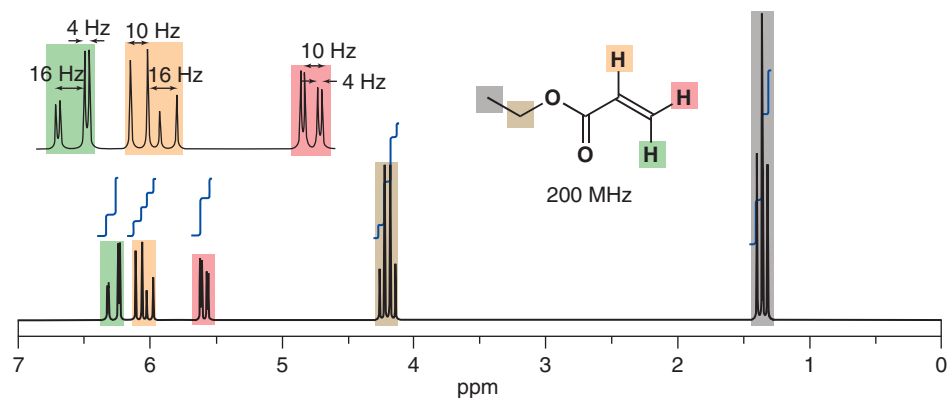

The largest J (16 Hz) is obviously between the orange and green protons (*trans* coupling), the medium J (10 Hz) is between the orange and red (*cis* coupling), and the small J (4 Hz) must be between the red and green (geminal). This assigns all the protons: red, 5.60 ppm; green, 6.40 ppm; orange, 6.11 ppm. Assignments based on coupling are more reliable than those based on chemical shift alone.

● Coupling constants in a vinyl group

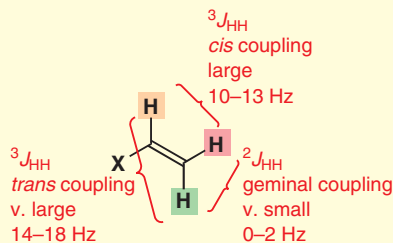

Ethyl vinyl ether is a reagent used for the protection of alcohols. All its coupling constants are smaller than is usual for an alkene because of the electronegativity of the oxygen atom, which is now joined directly to the double bond. It is still a simple matter to assign the protons of the vinyl group because couplings of 13, 7, and 2 Hz must be *trans*, *cis*, and geminal, respectively. In addition, the orange H is on a carbon atom next to oxygen and so goes downfield while the red and green protons have extra shielding from the conjugation of the oxygen lone pairs (see p. 281).

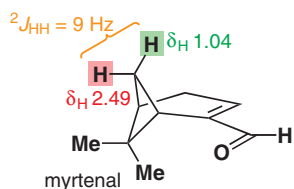
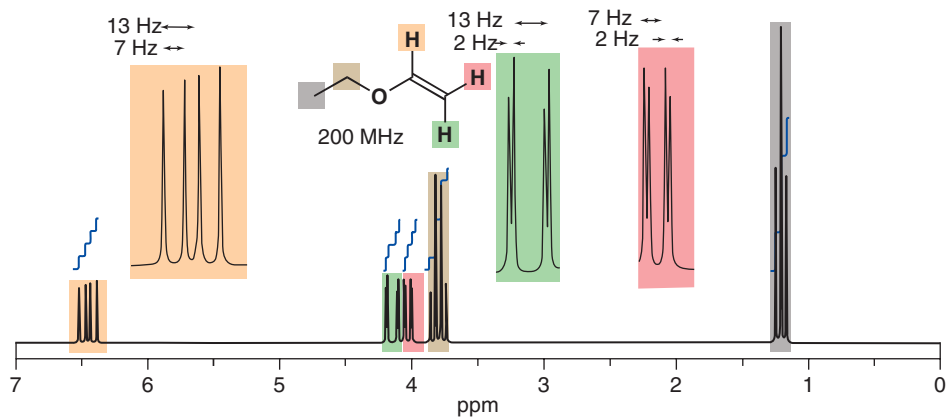

Geminal coupling on saturated carbons can be seen only if the hydrogens of a CH₂ group are different. The bridging CH₂ group of myrtenal (p. 274) provides an example. The coupling constant for the protons on the bridge, J_{AB} , is 9 Hz. Geminal coupling constants in a saturated system can be much larger (typically 10–16 Hz) than in an unsaturated one.

• Typical coupling constants

• geminal $^2J_{HH}$

saturated



10–16 Hz

unsaturated

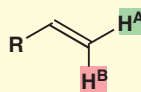

0–3 Hz

• vicinal $^3J_{HH}$

saturated

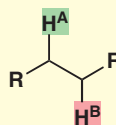

6–8 Hz

unsaturated *trans*

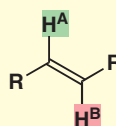

14–18 Hz

unsaturated *cis*

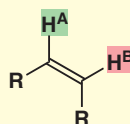

10–12 Hz

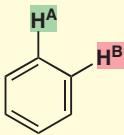
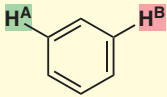
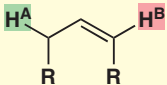
unsaturated aromatic		8–10 Hz
• long-range $^4J_{\text{HH}}$ meta		1–3 Hz
allylic		1–2 Hz

To conclude

You have now met, in Chapter 3 and this chapter, all of the most important spectroscopic techniques available for working out the structure of organic molecules. We hope you can now appreciate why proton NMR is by far the most powerful of these techniques, and we hope you will be referring back to this chapter as you read the rest of the book. We shall talk about proton NMR a lot, and specifically we will come back to it in detail in Chapter 18, where we will look at using all of the spectroscopic techniques in combination, and in Chapter 31, when we look at what NMR can tell us about the shape of molecules.

Further reading

A reminder: you will find it an advantage to have one of the short books on spectroscopic analysis to hand as they give explanations, comprehensive tables of data, and problems. We recommend *Spectroscopic Methods in Organic Chemistry* by D. H. Williams and Ian Fleming, McGraw-Hill, London, 6th edn, 2007.

A simple introduction is the Oxford Primer *Introduction to Organic Spectroscopy*, L. M. Harwood and T. D. W. Claridge, OUP, Oxford, 1996. A more advanced source of practical uses of stereochemistry is the Oxford Primer *Stereoselectivity in Organic Synthesis*, Garry Procter, OUP, Oxford, 1998.

Check your understanding



To check that you have mastered the concepts presented in this chapter, attempt the problems that are available in the book's Online Resource Centre at <http://www.oxfordtextbooks.co.uk/orc/clayden2e/>

14

Stereochemistry

Connections

➔ Building on

- Drawing organic molecules [ch2](#)
- Organic structures [ch4](#)
- Nucleophilic addition to the carbonyl group [ch6](#)
- Nucleophilic substitution at carbonyl groups [ch10 & ch11](#)

Arriving at

- Three-dimensional shape of molecules
- Molecules with mirror images
- Molecules with symmetry
- How to separate mirror-image molecules
- Diastereoisomers
- Shape and biological activity
- How to draw stereochemistry

➔ Looking forward to

- Nucleophilic substitution at saturated C [ch15](#)
- Conformation [ch16](#)
- Elimination [ch18](#)
- Controlling alkene geometry [ch27](#)
- Controlling stereochemistry with cyclic compounds [ch32](#)
- Diastereoselectivity [ch33](#)
- Asymmetric synthesis [ch41](#)
- Chemistry of life [ch42](#)

Some compounds can exist as a pair of mirror-image forms

One of the very first reactions you met, back in Chapter 6, was between an aldehyde and cyanide. The product was a compound containing a nitrile group and a hydroxyl group.

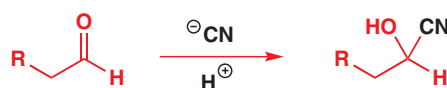

How many products are formed in this reaction? Well, the straightforward answer is one—there's only one aldehyde, only one cyanide ion, and only one reasonable way in which they can react. But this analysis is not *quite* correct. One point that we ignored when we first talked about this reaction, because it was irrelevant at that time, is that the carbonyl group of the aldehyde has two faces. The cyanide ion could attack either from the front face or the back face, giving, in each case, a distinct product.

 Interactive results of cyanide addition to carbonyls

■ The bold wedges represent bonds coming towards you, out of the paper, and the cross-hatched bonds represent bonds going away from you, into the paper.

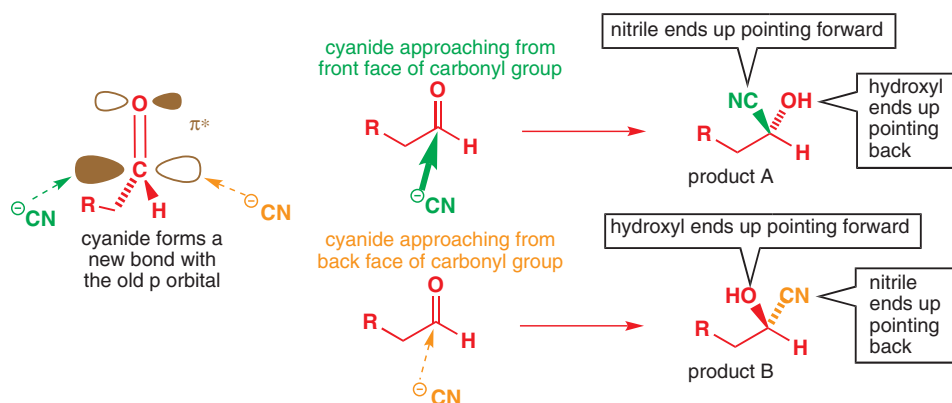

Online support. The icon  in the margin indicates that accompanying interactive resources are provided online to help your understanding: just type www.chemtube3d.com/clayden/123 into your browser, replacing **123** with the number of the page where you see the icon. For pages linking to more than one resource, type **123-1, 123-2** etc. (replacing **123** with the page number) for access to successive links.

As we explained in Chapter 6 (pp. 125–7), the cyanide attacks the π^* orbital of the aldehyde more or less at right angles to the plane of the molecule as it forms a new bond with the old p orbital on C. This translates into ‘front’ and ‘back’ on a diagram on paper. Compare the diagram on the left with the others to make sure this is clear.

Are these two products different? If we lay them side by side and try to arrange them so that they look identical, we find that we can’t—you can verify this by making models of the two structures. The structures are non-superimposable—so they are not identical. In fact, they are mirror images of each other: if we reflected one of the structures, A, in a mirror, we would get a structure that is identical with B.

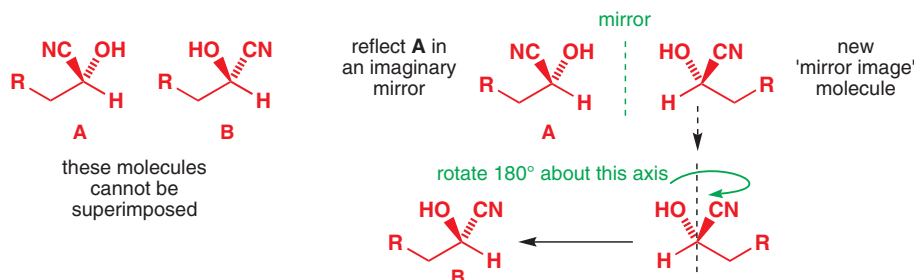

We call two structures that are not identical but are mirror images of each other (like these two) **enantiomers**. Structures that are not superimposable on their mirror image, and can therefore exist as two enantiomers, are called **chiral**. In this reaction, the cyanide ions are just as likely to attack the ‘front’ face of the aldehyde as they are the ‘back’ face, so we get a 50:50 mixture of the two enantiomers.

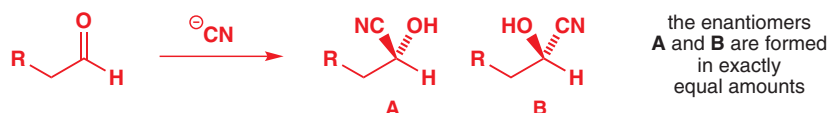

● Enantiomers and chirality

- Enantiomers are structures that are not identical, but are *mirror images* of each other.
- Structures are *chiral* if they cannot be superimposed on their mirror image.

Now consider another similar reaction—the addition of cyanide to acetone.



Again an adduct (a cyanohydrin) is formed. You might imagine that attacking the front or the back face of the acetone molecule could again give two structures, C and D.

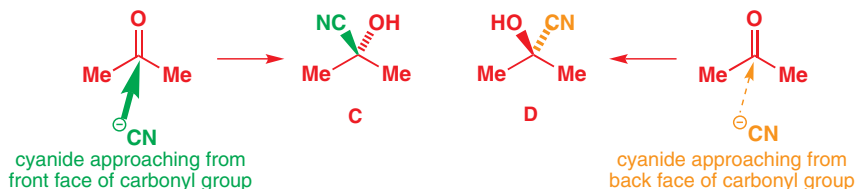

However, this time rotating one to match the other shows that they are superimposable and therefore identical.

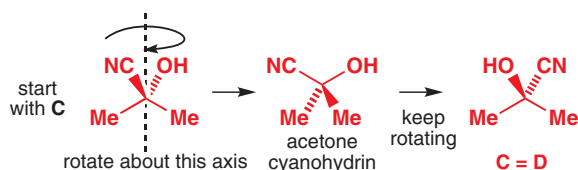

■ In reading this chapter, you will have to do a lot of mental manipulation of three-dimensional shapes. Because we can represent these shapes in the book only in two dimensions, we suggest that you make models, using a molecular model kit, of the molecules we talk about. With some practice, you will be able to imagine the molecules you see on the page in three dimensions.

Interactive aldehyde cyanohydrin structures—chiral

Interactive acetone cyanohydrin structure—achiral

Make sure that you are clear about this: C and D are identical molecules, while A and B are mirror images of each other. Reflection in a mirror makes no difference to C or D; they are superimposable on their own mirror images and therefore cannot exist as two enantiomers. Structures that are superimposable on their mirror images are called achiral.

- **Achiral structures are superimposable on their mirror images.**

Chiral molecules have no plane of symmetry

What is the essential difference between these two compounds that means one is superimposable on its mirror image and one is not? The answer is *symmetry*. Acetone cyanohydrin has a plane of symmetry running through the molecule. This plane cuts the central carbon and the OH and CN groups in half, and has one methyl group on each side. All planar molecules (such as our simple aldehyde) cannot be chiral as the plane of the molecule must be a plane of symmetry. Cyclic molecules may have a plane of symmetry passing through two atoms of the ring, as in the cyclohexanone below. The plane passes through both atoms of the carbonyl group and bisects the methyl group as well as the hydrogen atom (not shown) on the same carbon atom. The bicyclic acetal looks more complicated but a plane of symmetry passes between the two oxygen atoms and the two ring-junction carbon atoms while bisecting the two methyl groups. None of these molecules is chiral.

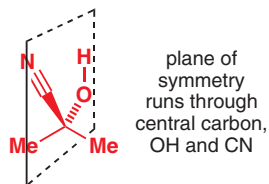

Interactive molecules with a plane of symmetry

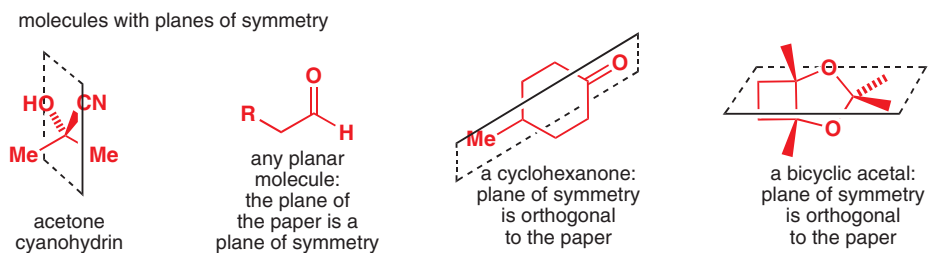

On the other hand, the aldehyde cyanohydrin has no plane of symmetry: the plane of the paper has OH on one side and CN on the other while the plane at right angles to the paper has H on one side and RCH₂ on the other. This compound has no plane of symmetry (has *asymmetry*) and has two enantiomers.

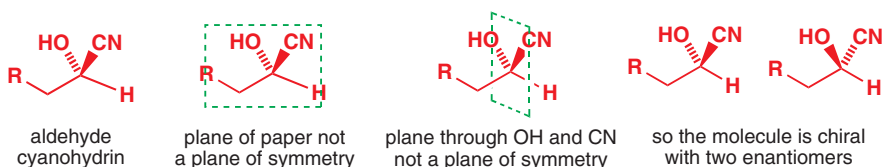

Later in this chapter we shall meet a much less important type of symmetry that also means molecules are not chiral if they possess it. This is a centre of symmetry.

Planes of symmetry and chirality

- Any structure that has no plane of symmetry is chiral and can exist as two mirror-image forms (*enantiomers*).
- Any structure with a plane of symmetry is not chiral and cannot exist as two enantiomers.

By 'structure', we don't just mean chemical structure: the same rules apply to everyday objects. Some examples from among more familiar objects in the world around us should help make these ideas clear. Look around you and find a chiral object—a pair of scissors, a screw (but not the screwdriver), a car, and anything with writing on it, like this page. Look again for achiral objects with planes of symmetry—a plain mug, saucepan, chair, most simple manufactured objects without writing on them. The most significant chiral object near you is the hand you write with.

Gloves, hands, and socks

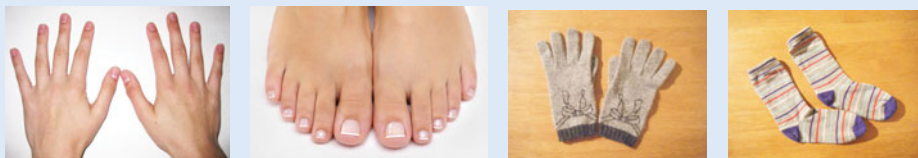

Most gloves exist in pairs of non-identical mirror-image forms: only a left glove fits a left hand and only a right glove fits a right hand. This property of gloves and of the hands inside them gives us the word 'chiral'—*cheir* is Greek for 'hand'. Hands and gloves are chiral; they have no plane of symmetry, and a left glove is not superimposable on its mirror image (a right glove). Feet are chiral too, as are shoes. But socks (usually!) are not. Although we all sometimes have problems finding two socks of a matching colour, once you've found them, you never have to worry about which sock goes on which foot because socks are achiral. A pair of socks is manufactured as two identical objects, each of which has a mirror plane.

The ancient Egyptians had less care for the chirality of hands and their paintings often show people, even Pharaohs, with two left hands or two right hands—they just didn't seem to notice.



Tennis racquets and golf clubs



If you are left-handed and want to play golf, you either have to play in a right-handed manner or get hold of a set of left-handed golf clubs. Golf clubs are clearly therefore chiral; they can exist as either of two enantiomers. You can tell this just by looking at a golf club. It has no plane of symmetry, so it must be chiral. But left-handed tennis players have no problem using the same racquets as right-handed tennis players and tennis players of either chirality sometimes swap the racquet from hand to hand. Look at a tennis racquet: it has a plane of symmetry (indeed, usually two), so it's achiral. It can't exist as two mirror-image forms.

■ These statements are slightly incomplete but will serve you well in almost all situations: we will come to centres of symmetry shortly (p. 321).

● To summarize

- A structure *with* a plane of symmetry is *achiral* and *superimposable* on its mirror image and *cannot* exist as two enantiomers.
- A structure *without* a plane of symmetry is *chiral* and *not superimposable* on its mirror image and *can* exist as two enantiomers.

Stereogenic centres

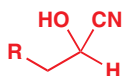

Back to chemistry, and the product from the reaction of an aldehyde with cyanide. We explained above that this compound, being chiral, can exist as two enantiomers. Enantiomers are clearly isomers; they consist of the same parts joined together in a different way. In particular, enantiomers are a type of isomer called **stereoisomers** because the isomers differ not in the connectivity of the atoms, but only in the overall shape of the molecule.

● Stereoisomers and constitutional isomers

Isomers are compounds that contain the same atoms bonded together in different ways. If the connectivity of the atoms in the two isomers is different, they are constitutional isomers. If the connectivity of the atoms in the two isomers is the same,

they are stereoisomers. Enantiomers are stereoisomers, and so are *E* and *Z* double bonds. We shall meet other types of stereoisomers shortly.

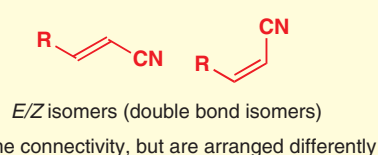
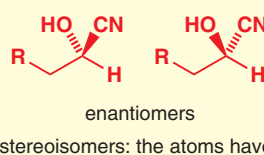
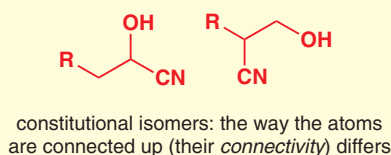

We should also introduce you briefly to another pair of concepts here, which you will meet again in more detail in Chapter 16: *configuration* and *conformation*. Two stereoisomers really are different molecules: they cannot be interconverted without breaking a bond somewhere. We therefore say that they have different configurations. But any molecule can exist in a number of conformations: two conformations differ only in the temporary way the molecule happens to arrange itself, and can easily be interconverted just by rotating around bonds. Humans all have the same *configuration*: two arms joined to the shoulders. We may have different *conformations*: arms folded, arms raised, pointing, waving, etc.

● Configuration and conformation

- Changing the *configuration* of a molecule always means that bonds are broken.
- A different configuration is a different molecule.
- Changing the *conformation* of a molecule means rotating about bonds, but not breaking them.
- Conformations of a molecule are readily interconvertible, and are all the same molecule.

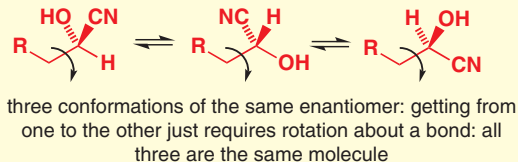
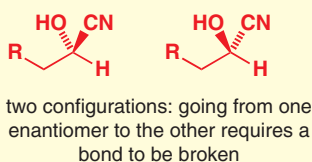

Interactive cyanohydrin conformations

The aldehyde cyanohydrin is chiral because it does not have a plane of symmetry. In fact, it *cannot* have a plane of symmetry because it contains a tetrahedral carbon atom carrying four different groups: OH, CN, RCH₂, and H. Such a carbon atom is known as a **stereogenic** or **chiral centre**. The product of cyanide and acetone is not chiral; it has a plane of symmetry and no chiral centre because two of the groups on the central carbon atom are the same.

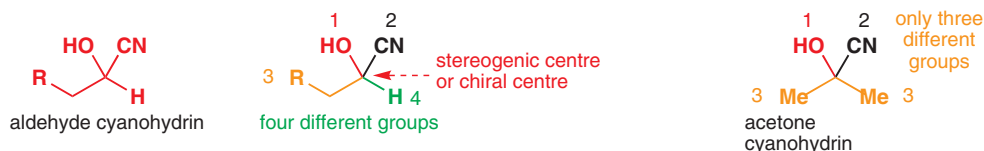

- If a molecule contains one carbon atom carrying four different groups it will not have a plane of symmetry and must therefore be chiral. A carbon atom carrying four different groups is a **stereogenic or chiral centre**.

We saw how the two enantiomers of the aldehyde cyanohydrin arose by attack of cyanide on the two faces of the carbonyl group of the aldehyde. We said that there was nothing to favour one face over the other, so the enantiomers must be formed in equal quantities. A mixture of equal quantities of a pair of enantiomers is called a **racemic mixture**.

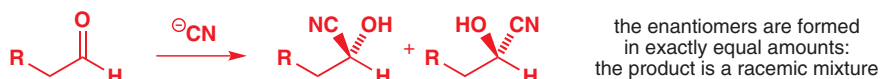

- A **racemic mixture** is a mixture of two enantiomers in equal proportions. This principle is very important. If all the starting materials and reagents in a reaction are achiral and the products are chiral they will be formed as a racemic mixture of two enantiomers.

Here are some more reactions you have come across that make chiral products from achiral starting materials. In each case, the principle must hold—equal amounts of the two enantiomers (racemic mixtures) are formed.

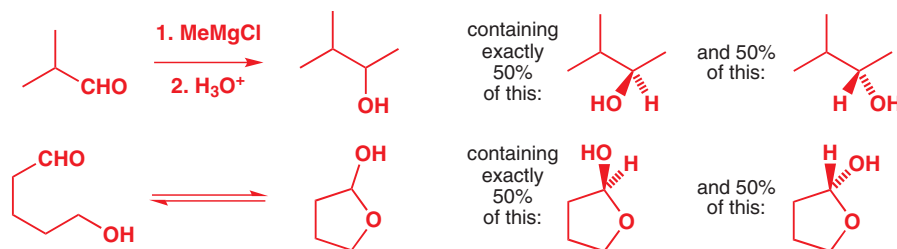

Many chiral molecules are present in nature as single enantiomers

Let's turn to some simple, but chiral, molecules—the natural amino acids. All amino acids have a carbon carrying an amino group, a carboxyl group, a hydrogen atom, and the R group, which varies from amino acid to amino acid. So unless R=H (this is the case for glycine), amino acids always contain a chiral centre and lack a plane of symmetry.



It is possible to make amino acids quite straightforwardly in the laboratory. The scheme below shows a synthesis of alanine, for example. It is a version of the Strecker synthesis you met in Chapter 11.

laboratory synthesis of racemic alanine from acetaldehyde



■ You will see shortly that compounds with *more than one* chiral centre are not always chiral.

■ When we don't show bold and dashed bonds to indicate the three-dimensional structure of the molecule, we mean that we are talking about both enantiomers of the molecule. Another useful way of representing this is with wiggly bonds. Wiggly bonds are in fact slightly ambiguous: here the wiggly bond means both stereoisomers. Elsewhere a wiggly bond might mean just one stereoisomer, but with unknown stereochemistry.

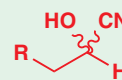

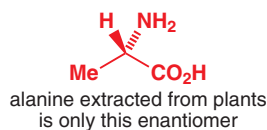

Alanine made in this way must be racemic because the starting material and all reagents are achiral. However, if we isolate alanine from a natural source—by hydrolysing vegetable protein, for example—we find that this is not the case. Natural alanine is solely one enantiomer, the one drawn in the margin. Samples of chiral compounds that contain only one enantiomer are called **enantiomerically pure**. We know that ‘natural’ alanine contains only this enantiomer from X-ray crystal structures.

Enantiomeric alanine

In fact, nature does sometimes (but very rarely) use the other enantiomer of alanine, for example in the construction of bacterial cell walls. Some antibiotics (such as vancomycin) owe their selectivity to the way they can recognize these ‘unnatural’ alanine components and destroy the cell wall that contains them.

Chiral and enantiomerically pure

Before we go further, we should just mention one common point of confusion. Any compound whose molecules do not have a plane of symmetry is chiral. Any sample of a chiral compound that contains molecules all of the same enantiomer is enantiomerically pure. *All* alanine is chiral (the structure has no plane of symmetry) but *laboratory-produced* alanine is racemic (a 50:50 mixture of enantiomers) whereas *naturally isolated* alanine is enantiomerically pure.

● ‘Chiral’ does not mean ‘enantiomerically pure’.

Most of the molecules we find in nature are chiral—a complicated molecule is much more likely not to have a plane of symmetry than to have one. Nearly all of these chiral molecules in living systems are found not as racemic mixtures, but as single enantiomers. This fact has profound implications, for example in the chemistry of drug design, and we will come back to it later.

R and S can be used to describe the configuration of a chiral centre

Before going on to talk about single enantiomers of chiral molecules in more detail, we need to explain how chemists describe which enantiomer they’re talking about. We can, of course, just draw a diagram, showing which groups go into the plane of the paper and which groups come out of the plane of the paper. This is best for complicated molecules. Alternatively, we can use the following set of rules to assign a letter, *R* or *S*, to describe the configuration of groups at a chiral centre in the molecule.

Here again is the enantiomer of alanine you get if you extract alanine from living things.

1. Assign a priority number (1–4) to each substituent at the chiral centre. Atoms with higher atomic numbers get higher priority.

Alanine’s chiral centre carries one N atom (atomic number 7), two C atoms (atomic number 6), and one H atom (atomic number 1). So, we assign priority 1 to the NH₂ group, because N has the highest atomic number. Priorities 2 and 3 will be assigned to the CO₂H and the CH₃ groups, and priority 4 to the hydrogen atom; but we need a way of deciding which of CO₂H and CH₃ takes priority over the other. If two (or more) of the atoms attached to the chiral centre are identical, then we assign priorities to these two by assessing the atoms attached to those atoms. In this case, one of the carbon atoms carries oxygen atoms (atomic number 8) and one carries only hydrogen atoms (atomic number 1). So CO₂H is higher priority than CH₃; in other words, CO₂H gets priority 2 and CH₃ priority 3.

2. Arrange the molecule so that the lowest priority substituent is pointing away from you. In our example, naturally extracted alanine, H is priority 4, so we need to look at the molecule with the H atom pointing into the paper, like this.

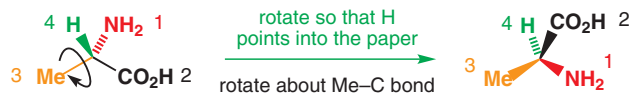

■ Remember—we use the word *configuration* to describe the arrangement of bonds around an atom. Configurations cannot be changed without breaking bonds.

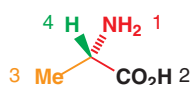
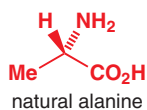

Interactive configuration assignment

■ These priority rules are also used to assign *E* and *Z* to alkenes, and are sometimes called the Cahn–Ingold–Prelog (CIP) rules, after their devisors. You can alternatively use atomic weights—for isotopes you have to (D has a higher priority than H)—apart from in the vanishingly rare case of a chiral centre bearing Te and I (look at the data in the periodic table at the front of this book to see why).

3. Mentally move from substituent priority 1 to 2 to 3. If you are moving in a clockwise manner, assign the label *R* to the chiral centre; if you are moving in an anticlockwise manner, assign the label *S* to the chiral centre.

A good way of visualizing this is to imagine turning a steering wheel in the direction of the numbering. If you are turning your car to the right, you have *R*; if you are turning to the left you have *S*. For our molecule of natural alanine, if we move from NH_2 (1) to CO_2H (2) to CH_3 (3) we're going anticlockwise (turning to the left), so we call this enantiomer (*S*)-alanine.

You can try working the other way, from the configurational label to the structure. Take lactic acid as an example. Lactic acid is produced by bacterial action on milk; it's also produced in your muscles when they have to work with an insufficient supply of oxygen, such as during bursts of vigorous exercise. Lactic acid produced by fermentation is often racemic, although certain species of bacteria produce solely (*R*)-lactic acid. On the other hand, lactic acid produced by anaerobic respiration in muscles has the *S* configuration.

As a brief exercise, try drawing the three-dimensional structure of (*R*)-lactic acid. You may find this easier if you draw both enantiomers first and then assign a label to each.

You should have drawn:

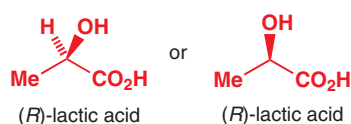

Remember that, if we had made lactic acid in the laboratory from simple achiral starting materials, we would have got a racemic mixture of (*R*)- and (*S*)-lactic acid. Reactions in living systems can produce enantiomerically pure compounds because they make use of enzymes, themselves enantiomerically pure compounds of (*S*)-amino acids.

Is there a chemical difference between two enantiomers?

The short answer is *no*.^{*} Take (*S*)-alanine (in other words, alanine extracted from plants) and (*R*)-alanine (the enantiomer found in bacterial cell walls) as examples. They have identical NMR spectra, identical IR spectra, and identical physical properties with a single important exception. If you shine plane-polarized light through a solution of (*S*)-alanine, you will find that the light is rotated to the right. A solution of (*R*)-alanine rotates plane-polarized light to the left and by the same amount. Racemic alanine doesn't rotate such light at all.

The rotation of plane-polarized light is known as optical activity

Observation of the rotation of plane-polarized light is known as polarimetry; it is a straightforward way of finding out if a sample is racemic or if it contains more of one enantiomer than the other. Polarimetric measurements are carried out in a polarimeter, which has a single-wavelength (monochromatic) light source with a plane-polarizing filter, a sample holder, where a cell containing a solution of the substance under examination can be placed, and a detector with a read-out that indicates by how much the light is rotated. Rotation to the right is given a positive value, rotation to the left a negative one.

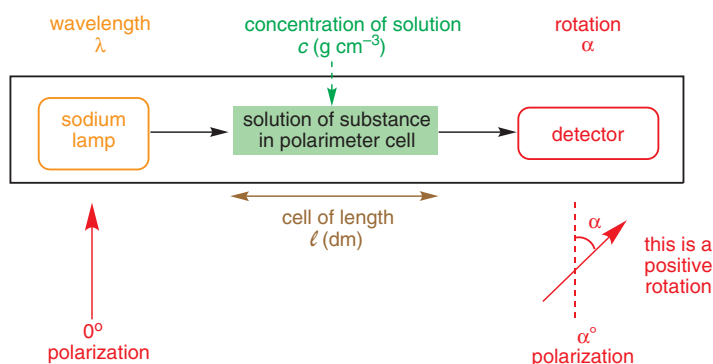

^{*} The longer answer is more involved, and we go into it in more detail in Chapter 41.

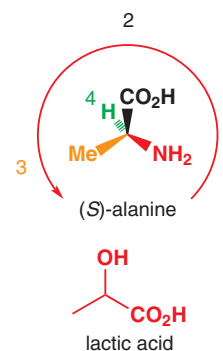

Remember how, in Chapter 2 (p. 21) we showed you that hydrogen atoms at stereogenic centres (we didn't call them that then) could be missed out—we just assume that they take up the fourth vertex of the imagined tetrahedron at the stereogenic centre.

This also brings us to another point about drawing stereogenic centres: always try to have the carbon skeleton lying in the plane of the paper: in other words,

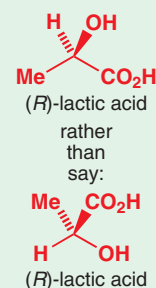

Both are correct but the first will make things a lot easier when we are talking about molecules with several chiral centres!

Plane-polarized light can be considered as a beam of light in which all of the light waves have their direction of vibration aligned parallel. It is produced by shining light through a polarizing filter.

The angle through which a sample of a compound (usually a solution) rotates plane-polarized light depends on a number of factors, the most important ones being the path length (how far the light has to pass through the solution), concentration, temperature, solvent, and wavelength. Typically, optical rotations are measured at 20 °C in a solvent such as ethanol or chloroform, and the light used is from a sodium lamp, with a wavelength of 589 nm.

The observed angle through which the light is rotated is given the symbol α . By dividing this value by the path length (in dm) and the concentration c (in g cm^{-3}) we get a value, $[\alpha]$, which is specific to the compound in question. Indeed, $[\alpha]$ is known as the compound's **specific rotation**. The choice of units is eccentric and arbitrary but is universal so we must live with it.

$$[\alpha] = \frac{\alpha}{c}$$

Most $[\alpha]$ values are quoted as $[\alpha]_{\text{D}}$ (where the D indicates the wavelength of 589 nm, the 'D line' of a sodium lamp) or $[\alpha]_{\text{D}}^{20}$, the 20 indicating 20 °C. These define the remaining variables.

Here is an example. A simple acid, known as mandelic acid, can be obtained from almonds in an enantiomerically pure form. When 28 mg was dissolved in 1 cm^3 of ethanol and the solution placed in a 10-cm-long polarimeter cell, an optical rotation α of -4.35° was measured (that is, 4.35° to the left) at 20 °C with light of wavelength 589 nm. What is the specific rotation of the acid?

First, we need to convert the concentration to grammes per cubic centimetre: 28 mg in 1 cm^3 is the same as 0.028 g cm^{-3} . The path length of 10 cm is 1 dm, so

$$[\alpha]_{\text{D}}^{20} = \frac{\alpha}{c} = \frac{-4.35}{0.028 \times 1} = -155.4$$

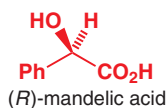

■ Note that the units of a measured optical rotation α are degrees, but, by convention, specific rotation $[\alpha]$ is quoted without units.

■ $[\alpha]_{\text{D}}$ values can be used as a guide to the enantiomeric purity of a sample, in other words, to how much of each enantiomer it contains. We will come back to this in Chapter 41.

Enantiomers can be described as (+) or (–)

We can use the fact that two enantiomers rotate plane-polarized light in opposite directions to assign each a label that doesn't depend on knowing its configuration. We call the enantiomer that rotates plane-polarized light to the right (gives a positive rotation) the (+)-enantiomer (or the *dextrorotatory* enantiomer) and the enantiomer that rotates plane-polarized light to the left (gives a negative rotation) the (–)-enantiomer (or the *laevorotatory* enantiomer). The direction in which light is rotated is not dependent on whether a stereogenic centre is *R* or *S*. An (*R*) compound is equally as likely to be (+) as (–)—of course, if it is (+) then its (*S*) enantiomer must be (–). The enantiomer of mandelic acid we have just discussed, for example, is (*R*)-(–)-mandelic acid because its specific rotation is negative, and (*S*)-alanine happens to be (*S*)-(+)-alanine. The labels (+) and (–) were more useful before the days of X-ray crystallography, when chemists did not know the actual configuration of the molecules they studied, and could distinguish two enantiomers only by the signs of their specific rotations.

Enantiomers can be described as D or L

Long before the appearance of X-ray crystallography as an analytical tool, chemists had to discover the detailed structure and stereochemistry of molecules by a complex series of degradations. A molecule was gradually broken down into its constituents, and from the products that were formed the overall structure of the starting molecule was deduced. As far as stereochemistry was concerned, it was possible to measure the specific rotation of a compound, but not to determine its configuration. However, by using series of degradations it was possible to tell whether certain compounds had the same or opposite configurations.

Glyceraldehyde is one of the simplest chiral compounds in nature. Because of this, chemists took it as the standard against which the configurations of other compounds could be compared. The two enantiomers of glyceraldehyde were given the labels D (for dextro—because it was the (+)-enantiomer) and L (for laevo—because it was the (–)-enantiomer). Any enantiomerically pure compound that could be related, by a series of chemical degradations and transformations, to D-(+)-glyceraldehyde was labelled D, and any compound that could be

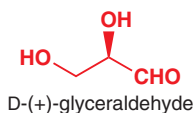

related to L-(–)-glyceraldehyde was labelled L. The processes concerned were slow and laborious (the scheme below shows how (–)-lactic acid was shown to be D-(–)-lactic acid) and are never used today. D and L are now used only for certain well-known natural molecules, where their use is established by tradition, for example, the L-amino acids or the D-sugars. These labels, D and L, are in *small capital* letters.

- Remember that the *R/S*, *+/-*, and *D/L* nomenclatures all arise from different observations and the fact that a molecule has, say, the *R* configuration gives no clue as to whether it will have *+* or *-* optical activity or be labelled *D* or *L*. Never try and label a molecule as *D/L* or *+/-* simply by working it out from the structure. Likewise, never try and predict whether a molecule will have a *+* or *-* specific rotation by looking at the structure.

The correlation between D-(–)-lactic acid and D-(+)-glyceraldehyde

Here, for example, is the way that (–)-lactic acid was shown to have the same configuration as D-(+)-glyceraldehyde. We do not expect you to have come across the reactions used here.

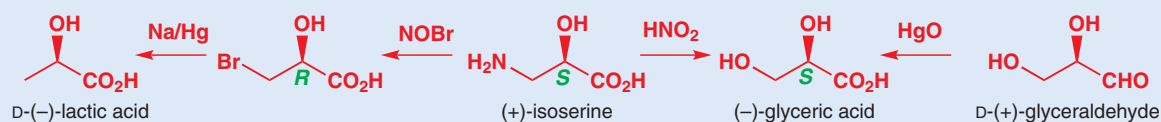

Notice from this scheme that the three intermediates all have the 'same' stereochemistry and yet one is (*R*) and two are (*S*). This is merely the consequence of the priority of the elements. (*R*) can be *D* or *L* and (*+*) or (*-*).

Diastereoisomers are stereoisomers that are not enantiomers

Two enantiomers are chemically identical because they are mirror images of one another. Other types of stereoisomers may be chemically (and physically) quite different. These two alkenes, for example, are geometrical isomers (or *cis-trans* isomers). Their physical chemical properties are different, as you would expect, since they are quite different in shape. Neither is chiral of course as they are planar molecules.

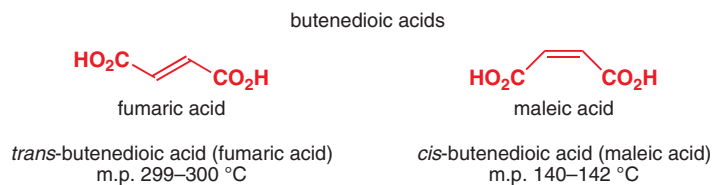

A similar type of stereoisomerism can exist in cyclic compounds. In one of these, 4-*t*-butylcyclohexanols, the two substituents are on the same side of the ring; in the other, they are on opposite sides of the ring. Again, the two compounds have chemical and physical properties that are quite different.

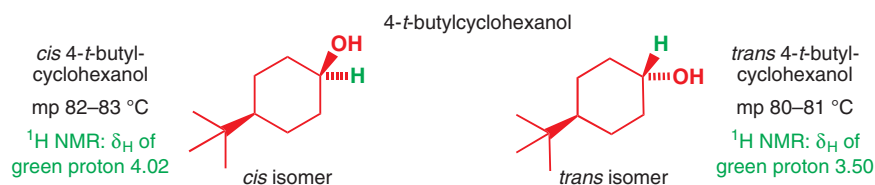

Notice that we do not always write in all the hydrogen atoms. If the *t*-butyl group is forward, as in these diagrams, the hydrogen atom must be back.

Stereoisomers that are not mirror images of one another are called *diastereoisomers*. Both of these pairs of isomers fall into this category. Notice how the physical and chemical properties of a pair of diastereoisomers differ.

- The physical and chemical properties of enantiomers are identical; the physical and chemical properties of diastereoisomers differ. 'Diastereoisomer' is sometimes shortened to 'diastereomer'.

Diastereoisomers can be chiral or achiral

This pair of epoxides was produced by chemists in Pennsylvania in the course of research on drugs intended to alleviate the symptoms of asthma. Clearly, they are again diastereoisomers, and again they have different properties. Although the reaction they were using to make these compounds gave some of each diastereoisomer, the chemists working on these compounds only wanted to use the first (*trans*) epoxide. They were able to separate it from its *cis* diastereoisomer by chromatography because the diastereoisomers differ in polarity.

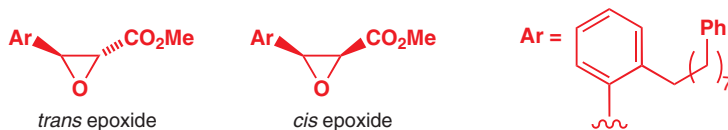

This time, the diastereoisomers are a little more complex than the examples above. The first two pairs of diastereoisomers we looked at were achiral—they each had a plane of symmetry through the molecule.

two pairs of achiral diastereoisomers

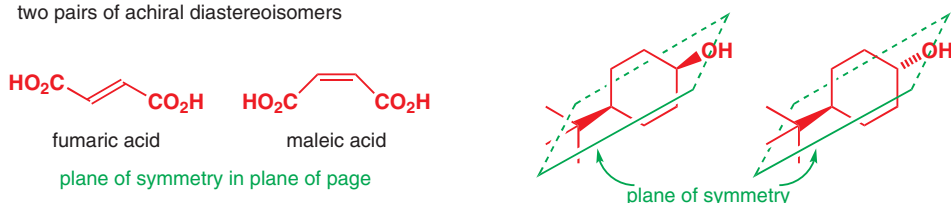

Interactive structures of achiral diastereoisomers

The epoxide diastereoisomers, on the other hand, are chiral. We know this because they do not have a plane of symmetry and we can check that by drawing the mirror image of each one: it is not superimposable on the first structure.

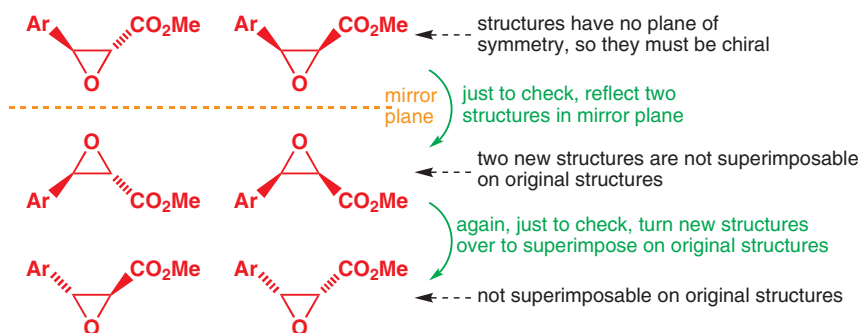

If a compound is chiral, it can exist as two enantiomers. We've just drawn the two enantiomers of each of the diastereoisomers of our epoxide. This set of four structures contains two diastereoisomers (stereoisomers that are not mirror images). These are the two different chemical compounds, the *cis* and *trans* epoxides, that have different properties. Each can exist as two enantiomers (stereoisomers that are mirror images) indistinguishable except for rotation. We have two pairs of diastereoisomers, each being a pair of enantiomers. When you are considering the stereochemistry of a compound, always distinguish the diastereoisomers first and then split these into enantiomers if they are chiral.

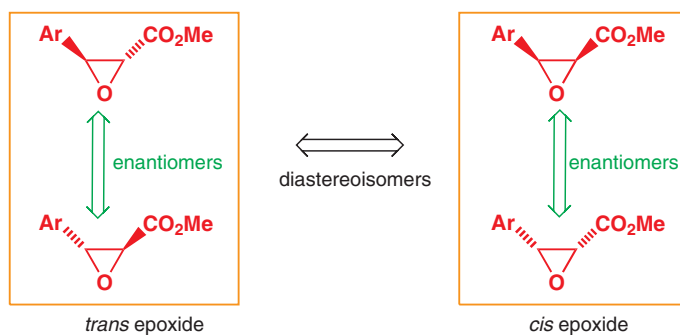

Interactive structures of epoxide diastereoisomers

In fact, the chemists working on these compounds wanted only one enantiomer of the *trans* epoxide—the top left stereoisomer. They were able to separate the *trans* epoxide from the *cis* epoxide by chromatography because they are diastereoisomers. However, because they had made both diastereoisomers in the laboratory from achiral starting materials, both diastereoisomers were racemic mixtures of the two enantiomers. Separating the top enantiomer of the *trans* epoxide from the bottom one was much harder because enantiomers have identical physical and chemical properties. To get just the enantiomer they wanted the chemists had to develop some completely different chemistry, using enantiomerically pure compounds derived from nature.

➔ We shall discuss how chemists make enantiomerically pure compounds later in this chapter, and in more detail in Chapter 41.

Absolute and relative stereochemistry

When we talk about two chiral diastereoisomers, we have no choice but to draw the structure of one enantiomer of each diastereoisomer because we need to include the stereochemical information to distinguish them, even if we're talking about a racemic mixture of the two enantiomers. To avoid confusion, it's best to write something definite under the structure, such as '±' (meaning racemic) under a structure if it means 'this diastereoisomer' but not 'this enantiomer of this diastereoisomer'. So in this case we should say that the chemists were able to separate these two diastereoisomers, but wanted only one enantiomer of the *trans* diastereoisomer and that this could not be separated by physical means.

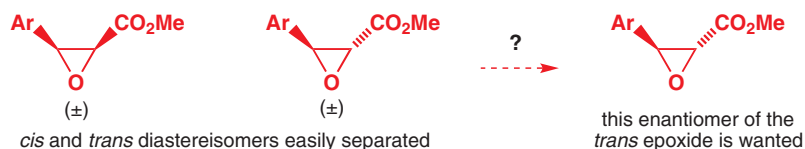

When the stereochemistry drawn on a molecule means 'this diastereoisomer', we say that we are representing **relative stereochemistry**; when it means 'this enantiomer of this diastereoisomer' we say we are representing its **absolute stereochemistry**. Relative stereochemistry tells us only how the stereogenic centres *within a molecule* relate to each other.

● Enantiomers and diastereoisomers

- **Enantiomers** are stereoisomers that are mirror images. A pair of enantiomers are mirror-image forms of the same compound and have opposite **absolute stereochemistry**.
- **Diastereoisomers** are stereoisomers that are not mirror images. Two diastereoisomers are different compounds, and have different **relative stereochemistry**.
- Diastereoisomers may be achiral (have a plane of symmetry) or they may be chiral (have no plane of symmetry).

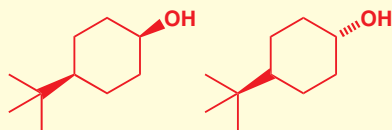

these diastereoisomers are *achiral*

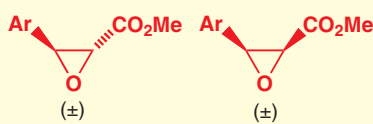

these diastereoisomers are *chiral*

Diastereoisomers can arise when structures have more than one stereogenic centre

Let's analyse our set of four stereoisomers a little more closely. You may have already noticed that these structures all contain stereogenic centres—two in each case. Go back to the diagram of the four structures at the bottom of p. 312 and, without looking at the structures overleaf, assign an *R* or *S* label to each of the stereogenic centres.

You should have made assignments of *R* and *S* like this.

➔ You need to know, and be able to use, the rules for assigning *R* and *S*; they were explained on p. 308. If you get any of the assignments wrong, make sure you understand why.

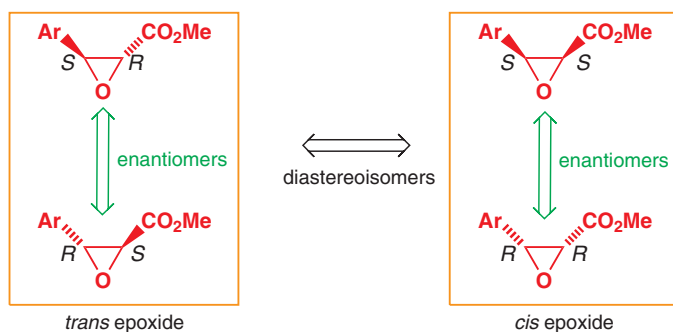

● **Converting enantiomers and diastereoisomers**

- To go from one *enantiomer* to another, *both* stereogenic centres are inverted.
- To go from one *diastereoisomer* to another, only *one* of the two is inverted.

■ If you are asked to explain some stereochemical point in an examination, choose a cyclic example—it makes it much easier.

All the compounds that we have talked about so far have been cyclic because the diastereoisomers are easy to visualize: two diastereoisomers can be identified because the substituents are either on the same side or on opposite sides of the ring (*cis* or *trans*). But acyclic compounds can exist as diastereoisomers too. Take these two, for example. Both ephedrine and pseudoephedrine are members of the amphetamine class of stimulants, which act by imitating the action of the hormone adrenaline.

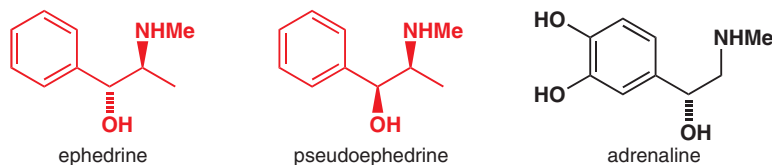

Ephedrine and pseudoephedrine are stereoisomers that are clearly not mirror images of each other—only one of the two stereogenic centres in ephedrine is inverted in pseudoephedrine—so they must be diastereoisomers. Thinking in terms of stereogenic centres is useful because, just as this compound has two stereogenic centres and can exist as two diastereoisomers, any compound with more than one stereogenic centre can exist in more than one diastereoisomeric form.

Both ephedrine and pseudoephedrine are produced in enantiomerically pure form by plants, so, unlike the anti-asthma intermediates above, in this case we are talking about single enantiomers of single diastereoisomers. Adrenaline (also known as epinephrine) is also chiral. In nature it is a single enantiomer but it cannot exist as other diastereoisomers as it has only one stereogenic centre.

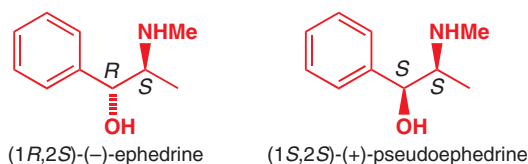

Ephedrine and pseudoephedrine

Ephedrine is a component of the traditional Chinese remedy 'Ma Huang', extracted from *Ephedra* species. It is also used in nasal sprays as a decongestant. Pseudoephedrine is the active component of the decongestant Sudafed.

The 'natural' enantiomers of the two diastereoisomers are (-)-ephedrine and (+)-pseudoephedrine, which does not tell you which is which, or (1*R*,2*S*)-(-)-ephedrine and (1*S*,2*S*)-(+)-

pseudoephedrine, which does. From that you should be able to deduce the corresponding structures.

Here are some data on (1*R*,2*S*)-(-)-ephedrine and (1*S*,2*S*)-(+)-pseudoephedrine and their 'unnatural' enantiomers (which have to be made in the laboratory), (1*S*,2*R*)-(+)-ephedrine and (1*R*,2*R*)-(-)-pseudoephedrine.

	(1 <i>R</i> ,2 <i>S</i>)-(-)-ephedrine	(1 <i>S</i> ,2 <i>R</i>)-(+)-ephedrine	(1 <i>S</i> ,2 <i>S</i>)-(+)-pseudoephedrine	(1 <i>R</i> ,2 <i>R</i>)-(-)-pseudoephedrine
mp	40–40.5 °C	40–40.5 °C	117–118 °C	117–118 °C
$[\alpha]_D^{20}$	-6.3	+6.3	+52	-52

Remember that (+) and (-) refer to the sign of the specific rotation, while *R* and *S* are derived simply by looking at the structure of the compounds. There is no simple connection between the two!

- The two diastereoisomers are different compounds with different names and different properties, while the pairs of enantiomers are the same compound with the same properties, differing only in the direction in which they rotate polarized light.

We can illustrate the combination of two stereogenic centres in a compound by considering what happens when you shake hands with someone. Hand-shaking is successful only if you each use the same hand! By convention, this is your right hand, but it's equally possible to shake left hands. The overall pattern of interaction between two right hands and two left hands is the same: a right-handshake and a left-handshake are enantiomers of one another; they differ only in being mirror images. If, however, you misguidedly try to shake your right hand with someone else's left hand you end up holding hands. Held hands consist of one left and one right hand; a pair of held hands have totally different interactions from a pair of shaking hands; we can say that holding hands is a diastereoisomer of shaking hands. We can summarize the situation when we have two hands, or two chiral centres, each one *R* or *S*.

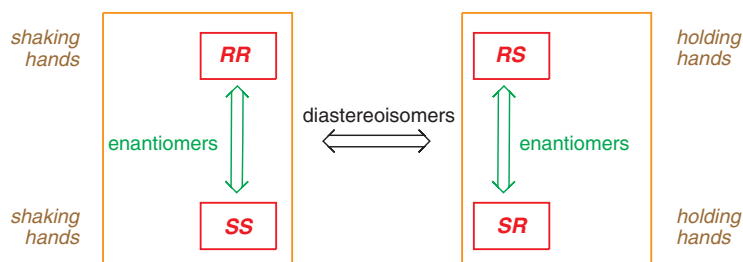

What about compounds with more than two stereogenic centres? The family of sugars provides lots of examples. Ribose is a five-carbon sugar that contains three stereogenic centres. The enantiomer shown here is the one used in the metabolism of all living things and, by convention, is known as D-ribose. The three stereogenic centres of D-ribose have the *R* configuration. For convenience, we will consider ribose in its open-chain form, but more usually it would be cyclic, as shown underneath.

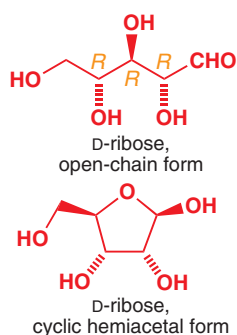

In theory we can work out how many 'stereoisomers' there are of a compound with three stereogenic centres simply by noting that there are $8 (= 2^3)$ ways of arranging Rs and Ss.

<i>RRR</i>	<i>RRS</i>	<i>RSR</i>	<i>RSS</i>
<i>SSS</i>	<i>SSR</i>	<i>SRS</i>	<i>SRR</i>

But this method blurs the all-important distinction between diastereoisomers and enantiomers. In each case, the combination in the top row and the combination directly below it are enantiomers (all three centres are inverted); the four columns are diastereoisomers. Three stereogenic centres therefore give four diastereoisomers, each a pair of two enantiomers. Going back to the example of the C_5 aldoses, each of these diastereoisomers is a different sugar. In these diagrams each diastereoisomer is in a frame but the top line shows one enantiomer (D) and the bottom line the other (L).

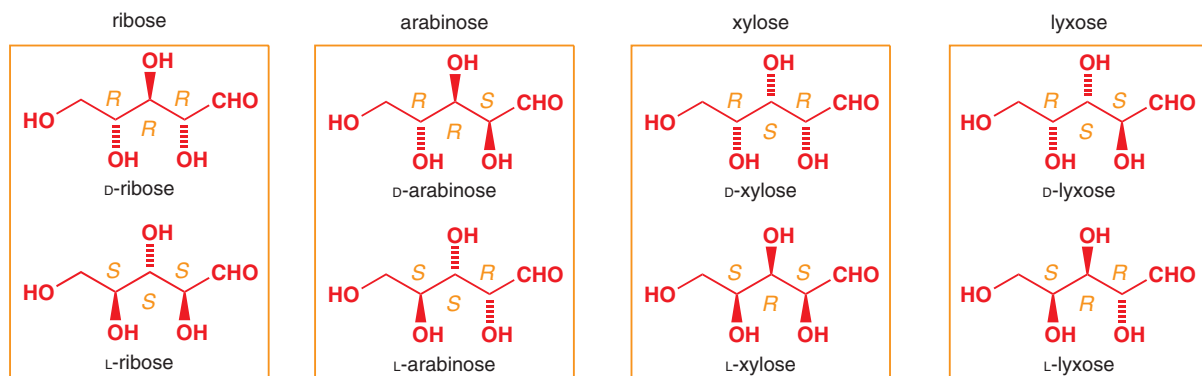

■ You do not need to remember the names of these sugars.

Structure of sugars

A sugar has the empirical formula $C_nH_{2n}O_n$, and consists of a chain of carbon atoms, one being a carbonyl group and the rest carrying OH groups. If the carbonyl group is at the end of the chain (in other words, it is an aldehyde), the sugar is an aldose. If the carbonyl group is not at the end of the chain, the sugar is a ketose. We come back to all this in detail in Chapter 42. The number of carbon atoms, n , can be 3–8: aldoses have $n - 2$ stereogenic centres and ketoses $n - 3$ stereogenic centres. In fact, most sugars exist as an equilibrium mixture of this open-chain structure and a cyclic hemiacetal isomer (Chapter 6).

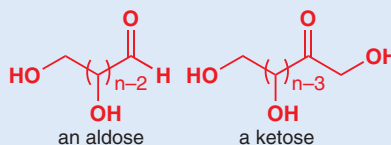

■ This is an oversimplification to be used cautiously because it works only if all diastereoisomers are chiral and fails with the sort of symmetrical molecules we are about to describe.

You've probably recognized that there's a simple mathematical relationship between the number of stereogenic centres and the number of stereoisomers a structure can have. **Usually**, a structure with n stereogenic centres can exist as 2^n stereoisomers. These stereoisomers consist of 2^{n-1} diastereoisomers, each of which has a pair of enantiomers.

Fischer projections

The stereochemistry of sugars used to be represented by Fischer projections. The carbon backbone was laid out in a vertical line and twisted in such a way that all the substituents pointed towards the viewer. Fischer projections are so unlike real molecules that you should never use them. However, you may see them in older books, and you should have an idea about how to interpret them. Just remember that all the branches down the side of the central trunk are effectively bold wedges (coming towards the viewer), while the central trunk lies in the plane of the paper. By mentally twisting the backbone into a realistic zig-zag shape you should end up with a reasonable representation of the sugar molecule.

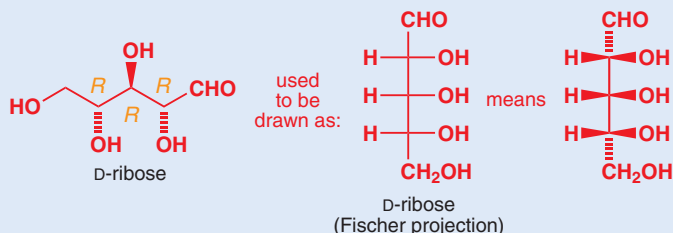

Why only usually?—achiral compounds with more than one stereogenic centre

Sometimes, symmetry in a molecule can cause some stereoisomers to be degenerate, or 'cancel out'—there aren't as many stereoisomers as you'd expect. Take tartaric acid, for example. This stereoisomer of tartaric acid is found in grapes, and its salt, potassium hydrogen tartrate, can precipitate out as crystals at the bottom of bottles of wine. It has two stereogenic centres, so you'd expect $2^2 = 4$ stereoisomers; two diastereoisomers, each a pair of enantiomers.

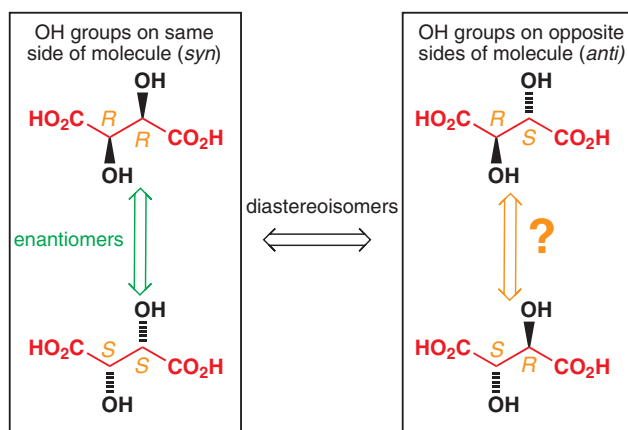
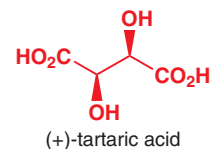

Interactive stereoisomers of tartaric acid

While the pair of structures on the left are certainly enantiomers, if you look carefully at the pair of structures on the right, you'll see that they are, in fact, not enantiomers but identical structures. To prove it, just rotate the top one through 180° in the plane of the paper.

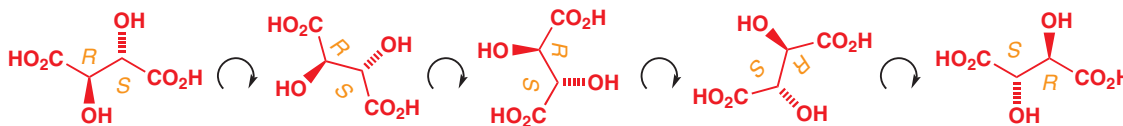

(1*R*,2*S*)-Tartaric acid and (1*S*,2*R*)-tartaric acid are not enantiomers, but they are identical because, even though they contain stereogenic centres, they are achiral. By drawing (1*R*,2*S*)-tartaric acid after a 180° rotation about the central bond, you can easily see that it has a mirror plane, and so must be achiral. Since the molecule has a plane of symmetry, and *R* is the mirror image of *S*, the *R,S* diastereoisomer cannot be chiral.

Interactive display of meso form of tartaric acid

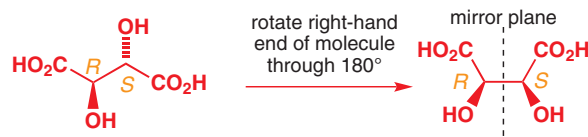

These two structures are the same molecule drawn in two different conformations—to get from one to the other just rotate half of the molecule about the central bond.

- Compounds that contain stereogenic centres but are themselves achiral are called *meso* compounds. This means that there is a plane of symmetry with *R* stereochemistry on one side and *S* stereochemistry on the other.

So tartaric acid can exist as two diastereoisomers, one with two enantiomers and the other achiral (a *meso* compound). It's worth noting that the formula stating that a compound with n stereogenic centres has 2^{n-1} diastereoisomers has worked but not the formula that states there are 2^n 'stereoisomers'. In general, it's safer not to count up total 'stereoisomers' but to work out first how many diastereoisomers there are, and then to decide whether or not each one is chiral, and therefore whether or not it has a pair of enantiomers.

Meso hand-shaking

We can extend our analogy between hand-shaking and diastereoisomers to *meso* compounds as well. Imagine a pair of identical twins shaking hands. They could be shaking their left hands or their right hands and there would be a way to tell the two handshakes apart because they are enantiomers. But if the twins hold hands, you will not be able to distinguish left holds right from right holds left, because the twins themselves are indistinguishable—this is the *meso* hand-hold!

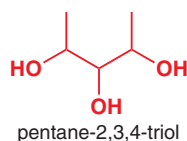
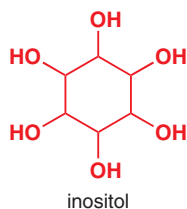

■ *syn* and *anti*: These refer to substituents on the same side (*syn*) or on opposite (*anti*) sides of a chain or ring. They must be used only in reference to a diagram.

	Chiral diastereoisomer		Achiral diastereoisomer
	(+)-tartaric acid	(-)-tartaric acid	meso-tartaric acid
$[\alpha]_D^{20}$	+12	-12	0
m.p.	168–170 °C	168–170 °C	146–148 °C

Meso diastereoisomers of inositol

Look out for *meso* diastereoisomers in compounds that have a degree of symmetry in their overall structure. Inositol, one of whose diastereoisomers is an important growth factor, has six stereogenic centres. It's a challenge to work out how many diastereoisomers it has—in fact all but one of them are *meso*.

Investigating the stereochemistry of a compound

When you want to describe the stereochemistry of a compound our advice is to identify the diastereoisomers and then think about whether they are chiral or not. Don't just count up 'stereoisomers'—to say that a compound with two stereogenic centres has four 'stereoisomers' is rather like saying that 'four hands are getting married'. Two people are getting married, each with two hands.

Let's work through how you might think about the stereochemistry of a simple example, the linear triol 2,3,4-trihydroxypentane or pentane-2,3,4-triol.

This is what you should do.

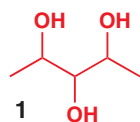

1. Draw the compound with the carbon skeleton in the usual zig-zag fashion running across the page, 1.

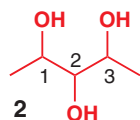

2. Identify the chiral centres, 2.

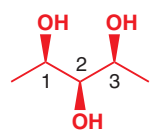

all up or *syn, syn*

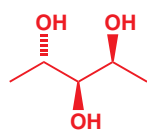

outside one down, others up or *anti, syn*

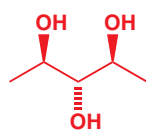

inside one down, others up or *anti, anti*

3. Decide how many diastereoisomers there are by putting the substituents at those centres up or down. It often helps to give each diastereoisomer a 'tag' name. In this case there are three diastereoisomers. The three OH groups can be all on the same side or else one of the end OHs or the middle one can be on the opposite side to the rest. We can call the first *syn, syn* because the two pairs of chiral centres (1 & 2, and 2 & 3) groups are both arranged with the OHs on the same side of the molecule (*syn*).

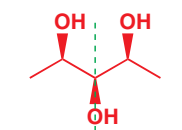

plane of symmetry
achiral (*meso*)

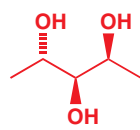

chiral

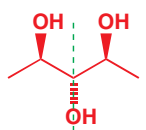

plane of symmetry
achiral (*meso*)

4. By checking on possible planes of symmetry, see which diastereoisomers are chiral. In this case only the plane down the centre can be a plane of symmetry.

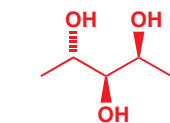

the two enantiomers of the *anti, syn* diastereoisomer

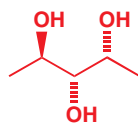

5. Draw the enantiomers of any chiral diastereoisomer by inverting *all* the stereogenic centres. This can easily be achieved by reflecting the molecule in the plane of the paper, as if it were a mirror. Everything that was 'up' is now 'down' and vice versa.

6. Announce the conclusion. You could have said that there are four 'stereoisomers' but the following statement is much more helpful. There are three diastereoisomers, the *syn, syn*, the *syn, anti*, and the *anti, anti*. The *syn, syn* and the *anti, anti* are achiral (*meso*) compounds but the *syn, anti* is chiral and has two enantiomers.

The mystery of Feist's acid

It is hard nowadays to realize how difficult structure solving was before the days of spectroscopy. A celebrated case was that of 'Feist's acid', discovered by Feist in 1893 from a deceptively simple reaction. Early work without spectra led to two suggestions for its structure, both based on a three-membered ring, which gave the compound some fame because unsaturated three-membered rings were rare. The favoured structure was the cyclopropene.

The argument was still going on in the 1950s when the first NMR spectrometers appeared. Although infrared appeared to support the cyclopropene structure, one of the first problems resolved by the primitive 40 MHz instruments available was that of Feist's acid, which had no methyl group signal but did have two protons on a double bond and so had to be the exomethylene isomer after all.

This structure has two chiral centres, so how will we know which diastereoisomer we have? The answer was simple: the stereochemistry has to be *trans* because Feist's acid is chiral: it can be resolved (see later in this chapter) into two enantiomers. Now, the *cis* diacid would have a plane of symmetry, and so would be achiral—it would be a *meso* compound. The *trans* acid on the other hand is chiral. If you do not see this, try superimposing it on its mirror image—you will find that you cannot. In fact, Feist's acid has an *axis* of symmetry, and you will see shortly that axes of symmetry *are* compatible with chirality.

Modern NMR spectra make the structure easy to deduce. There are only two proton signals as the CO₂H protons exchange in the DMSO solvent needed. The two protons on the double bond are identical (5.60 ppm) and so are the two protons on the three-membered ring, which come at the expected high field (2.67 ppm). There are four carbon signals: the C=O at 170 ppm, two alkene signals between 100 and 150 ppm, and the two identical carbons in the three-membered ring at 25.45 ppm.

modern ¹³C NMR of Feist's acid
170.3, 129.8, 105.05, 25.45

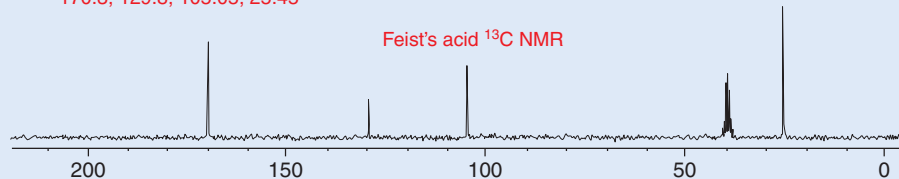

modern ¹H NMR of Feist's acid
2.67 (2H, s), 5.60 (2H, s)

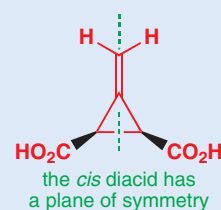
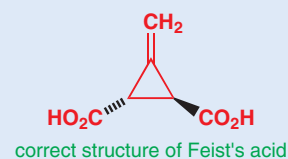
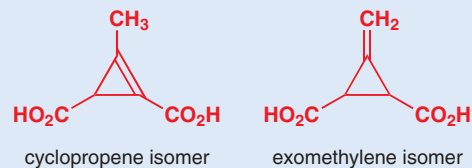
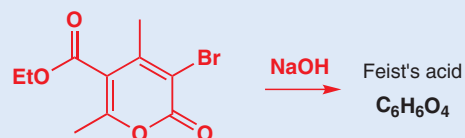
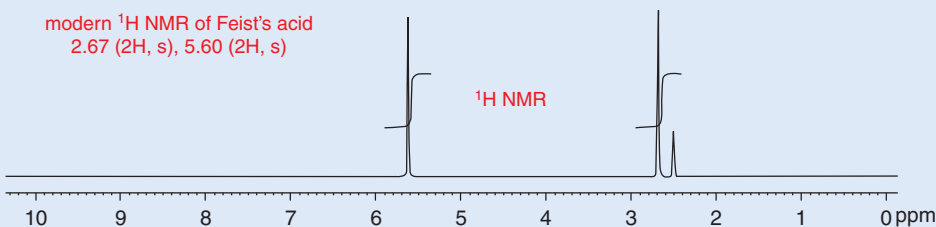

Chiral compounds with no stereogenic centres

A few compounds are chiral, yet have no stereogenic centres. Try making a model of the allene in the margin. It has no stereogenic centre, but these mirror images are not superimposable and so the allene is chiral: the structures shown are enantiomers. Similarly, some biaryl compounds, such as the important bisphosphine below, known as BINAP, exist as two separate enantiomers because rotation about the green bond is restricted. If you were to look at this molecule straight down along the green bond, you would see that the two flat rings are at right angles to each other and so the molecule has a twist in it rather like the 90° twist in the allene. Compounds that are chiral because of restricted rotation about a single bond are called *atropisomers* (from the Greek for 'won't turn').

Interactive possible structures for Feist's acid

a chiral allene

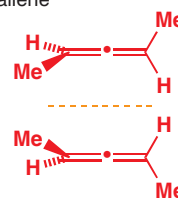

Interactive chiral compounds without stereogenic centres— allene

➔ We come back to BINAP in Chapter 41.

🖱 Interactive chiral compounds without stereogenic centres—BINAP

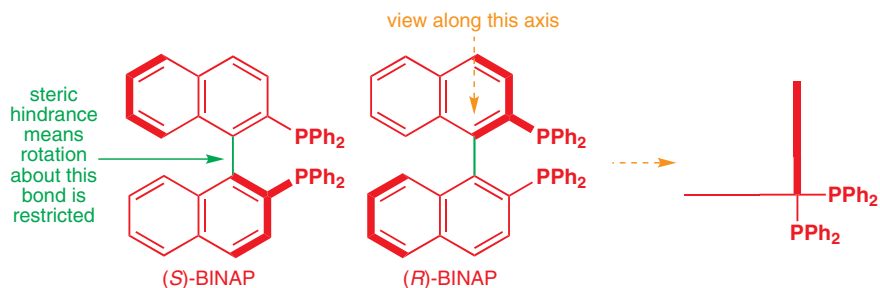

These two examples rely on the rigidity of π systems but this simple saturated system is also chiral. These two rings have to be orthogonal because of the tetrahedral nature of the central carbon atom. There is no chiral centre, but there is no plane of symmetry. Cyclic compounds like this with rings joined at a single C atom are called spiro compounds. Spiro compounds are often chiral even when at a first glance they look quite symmetrical, and you should look particularly carefully for planes of symmetry when you think about their stereochemistry.

🖱 Interactive chiral compounds without stereogenic centres—spiro amide

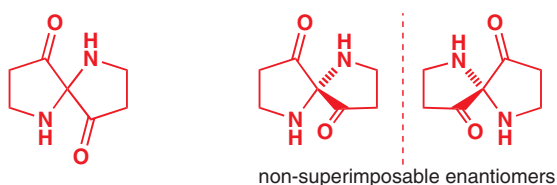

Axes and centres of symmetry

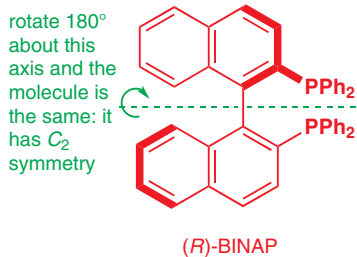

🖱 Interactive BINAP showing C_2 axis of symmetry

■ The subscript 2 means twofold axis of symmetry. Other orders of axial symmetry are possible in chemistry but are much rarer in simple organic compounds.

🖱 Interactive epoxide diastereoisomers showing plane of symmetry

■ We warned you that these statements (pp. 304 and 312) were incomplete: we are now about to complete them.

The fact that the three compounds we have just introduced (along with Feist's acid in the box on p. 319) were chiral might have surprised you, because at first glance they do look quite 'symmetrical'. In fact, they do all have an element of symmetry, and it is only one which is compatible with chirality: an *axis* of symmetry. If a molecule can be rotated through 180° about an axis to give exactly the same structure then it has twofold axial symmetry, or C_2 symmetry. Compounds with an axis of symmetry will still be chiral, provided they lack either a plane or a centre of symmetry.

C_2 symmetry is common in many more everyday molecules than the ones in the last section. Below is an example of a compound with two diastereoisomers. One (we call it the *syn* diastereoisomer here—the two phenyl rings are on the same side) has a plane of symmetry—it must be achiral (and as it nonetheless has chiral centres we can also call it the *meso* diastereoisomer). The other has some degree of symmetry, but it has axial symmetry and can therefore be chiral. The C_2 axis of symmetry is shown in orange. Rotating 180° gives back the same structure, but reflecting in a mirror plane (brown) gives a non-superimposable mirror image.

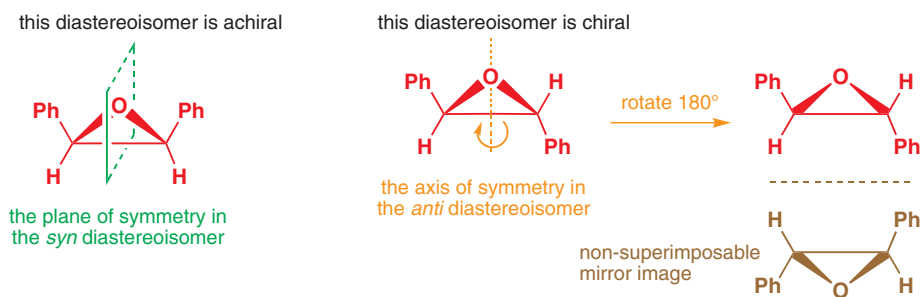

So far we have used a *plane of symmetry* as the defining characteristic of an achiral molecule: we have said several times that a molecule is chiral if it lacks a plane of symmetry. We are now

going to introduce a second type of symmetry that is not compatible with chirality. If a molecule has a *centre of symmetry* it is not chiral. We will now explain how to spot a centre of symmetry.

The diamide skeleton in the margin has a plane of symmetry in the plane of the page and also a plane of symmetry at right angles to that plane passing through the two saturated carbon atoms (represented by the green dotted line). If we add substituents R to this structure we can have two diastereoisomers with the two R groups on the same side (*syn*) of the flat ring or on opposite (*anti*) sides. Although the plane of the paper is no longer a plane of symmetry, neither isomer is chiral as the other plane bisects the substituents and is still a plane of symmetry. So far nothing new.

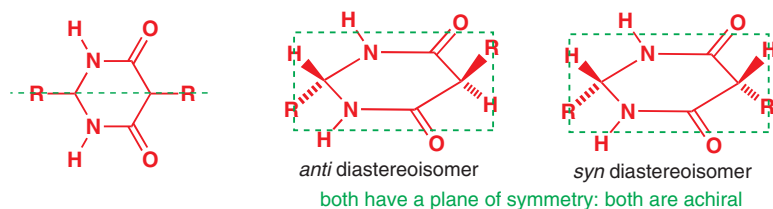
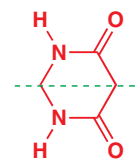

Now consider the related double amide below. The plane of the page is again a plane of symmetry but there is now no plane of symmetry at right angles. This heterocycle is called a 'diketopiperazine' and can be made by dimerizing an amino acid: the compound in the margin is the dimer of glycine. With substituted amino acids, such as those below where $R \neq H$, there are again two diastereoisomers, *syn* and *anti*. But their symmetry properties are different. The *syn* isomer is chiral but the *anti* isomer is not.

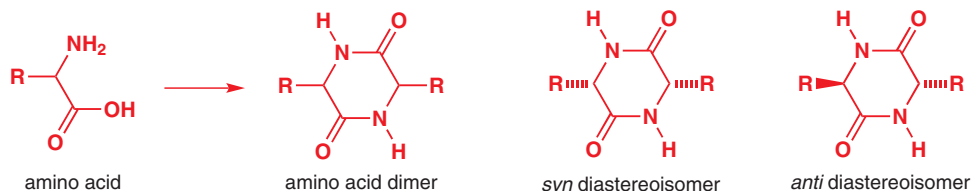
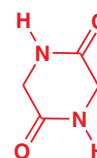

The *syn* diastereoisomer has no plane of symmetry but you should be able to spot a C_2 axis of symmetry running straight through the middle of the ring. The axis is compatible with chirality of course. In this compound both chiral centres are *S* and it has an enantiomer where both are *R*.

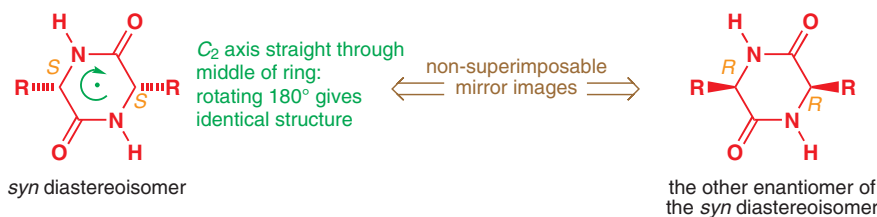

Interactive diamides showing centre of symmetry

The *anti* diastereoisomer has no plane of symmetry, nor does it have an axis. Instead it has a *centre of symmetry*. This is marked with a black dot in the middle of the molecule and means that if you go in any direction from this centre and meet, say, an R group, you will meet the same thing if you go in the opposite direction (green arrows). The same thing applies to the brown arrows and, of course, to the ring itself. There is no centre of symmetry in the *syn* isomer as the green or brown arrows would point to R on one side and H on the other. The *anti* isomer is superimposable on its mirror image and is achiral.

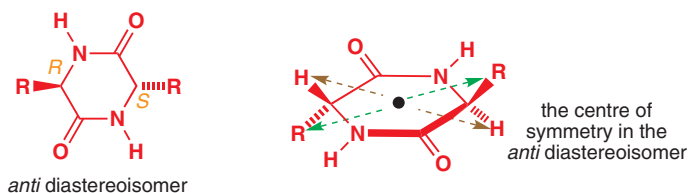

● **Chirality in terms of planes, centres, and axes of symmetry**

- Any molecule which has a *plane* of symmetry or a *centre* of symmetry is *achiral*.
- Any molecule which has an *axis* of symmetry is *chiral*, provided it does not also have a plane or a centre of symmetry. An axis of symmetry is the only symmetry element compatible with chirality.

Separating enantiomers is called resolution

Early in this chapter we said that most of the molecules in Nature are chiral, and that Nature usually produces these molecules as single enantiomers. We've talked about the amino acids, the sugars, ephedrine, pseudoephedrine, and tartaric acid—all compounds that can be isolated from natural sources as single enantiomers. On the other hand, in the laboratory, if we make chiral compounds from achiral starting materials we are doomed to get racemic mixtures. So how do chemists ever isolate compounds as single enantiomers, other than by extracting them from natural sources? We'll consider this question in much more detail in Chapter 41, but here we will look at the simplest way: using Nature's enantiomerically pure compounds to help us separate the components of a racemic mixture into its two enantiomers. This process is called resolution. Imagine the reaction between a chiral, but racemic, alcohol and a chiral, but racemic, carboxylic acid, to give an ester in an ordinary acid-catalysed esterification (Chapter 10).

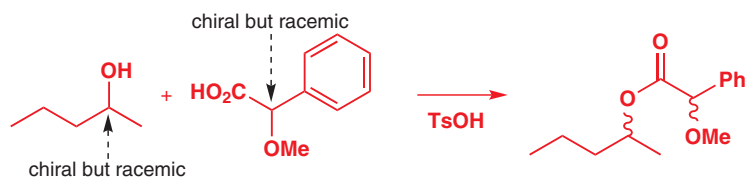

The product contains two chiral centres, so we expect to get two diastereoisomers, each a racemic mixture of two enantiomers. Diastereoisomers have different physical properties, so they should be easy to separate, for example by chromatography.

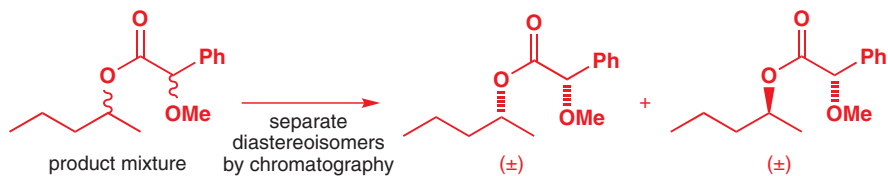

We could then reverse the esterification step and hydrolyse either of these diastereoisomers, to regenerate racemic alcohol and racemic acid.

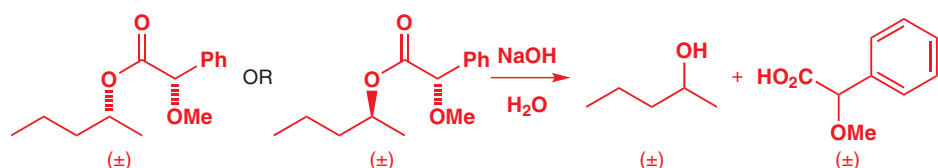

■ Remember that (±) means the compounds are racemic: we're showing only relative, not absolute, stereochemistry.

If we repeat this reaction, this time using an enantiomerically pure sample of the acid, available from (*R*)-mandelic acid, the almond extract you met on p. 310, we will again get two diastereoisomeric products, but this time each one will be enantiomerically pure. Note that the stereochemistry shown here *is* absolute stereochemistry.

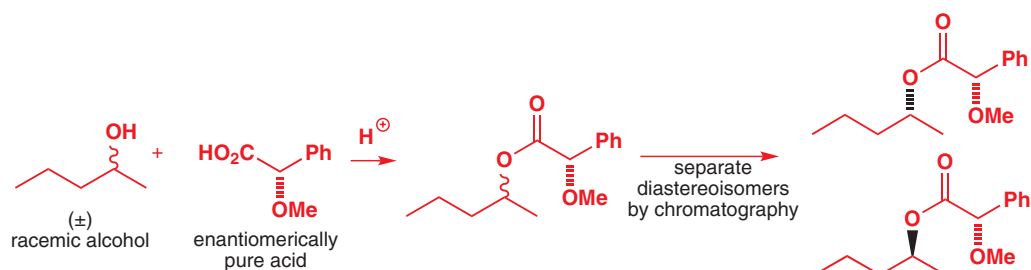

If we now hydrolyse each diastereoisomer separately, we have done something rather remarkable: we have managed to separate two enantiomers of the starting alcohol.

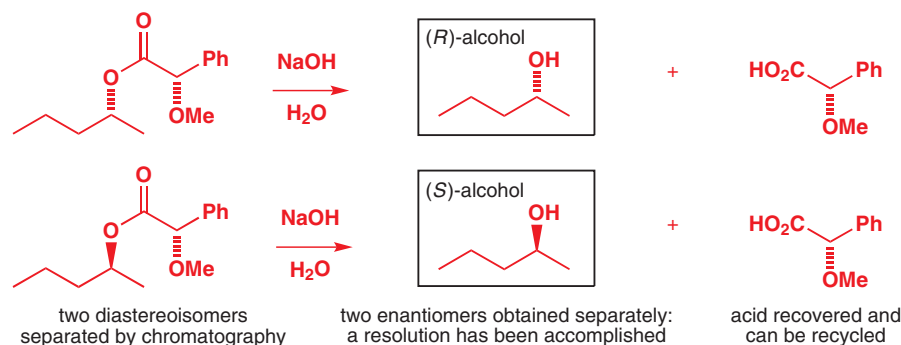

A separation of two enantiomers is called a **resolution**. Resolutions can be carried out only if we make use of a component that is already enantiomerically pure: it is very useful that Nature provides us with such compounds; resolutions nearly always make use of compounds derived from nature.

Natural chirality

Why Nature uses only one enantiomer of most important biochemicals is an easier question to answer than how this asymmetry came about in the first place, or why L-amino acids and D-sugars were the favoured enantiomers, since, for example, proteins made out of racemic samples of amino acids would be complicated by the possibility of enormous numbers of diastereomers. Some have suggested that life arose on the surface of single chiral quartz crystals, which provided the asymmetric environment needed to make life's molecules enantiomerically pure. Or perhaps the asymmetry present in the spin of electrons released as gamma rays acted as a source of molecular asymmetry. Given that enantiomerically pure living systems should be simpler than racemic ones, maybe it was just chance that the L-amino acids and the D-sugars won out.

Now for a real example. Chemists studying the role of amino acids in brain function needed to obtain each of the two enantiomers of the amino acid in the margin. They made a racemic sample using the Strecker synthesis of amino acids that you met in Chapter 11. The racemic amino acid was treated with acetic anhydride to make the mixed anhydride and then with the sodium salt of naturally derived, enantiomerically pure alcohol menthol to give two diastereoisomers of the ester.

One of the diastereoisomers turned out to be more crystalline (that is, to have a higher melting point) than the other and, by allowing the mixture to crystallize, the chemists were able to isolate a pure sample of this diastereoisomer. Evaporating the diastereoisomer left in solution (the 'mother liquors') gave them the less crystalline diastereoisomer.

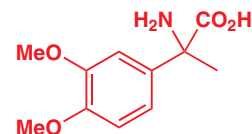

Next the esters were hydrolysed by boiling them in aqueous KOH. The acids obtained were enantiomers, as shown by their (nearly) opposite optical rotations and similar melting points. Finally, a more vigorous hydrolysis of the amides (boiling for 40 hours with 20% NaOH) gave them the amino acids they required for their biological studies (see bottom of p. 322).

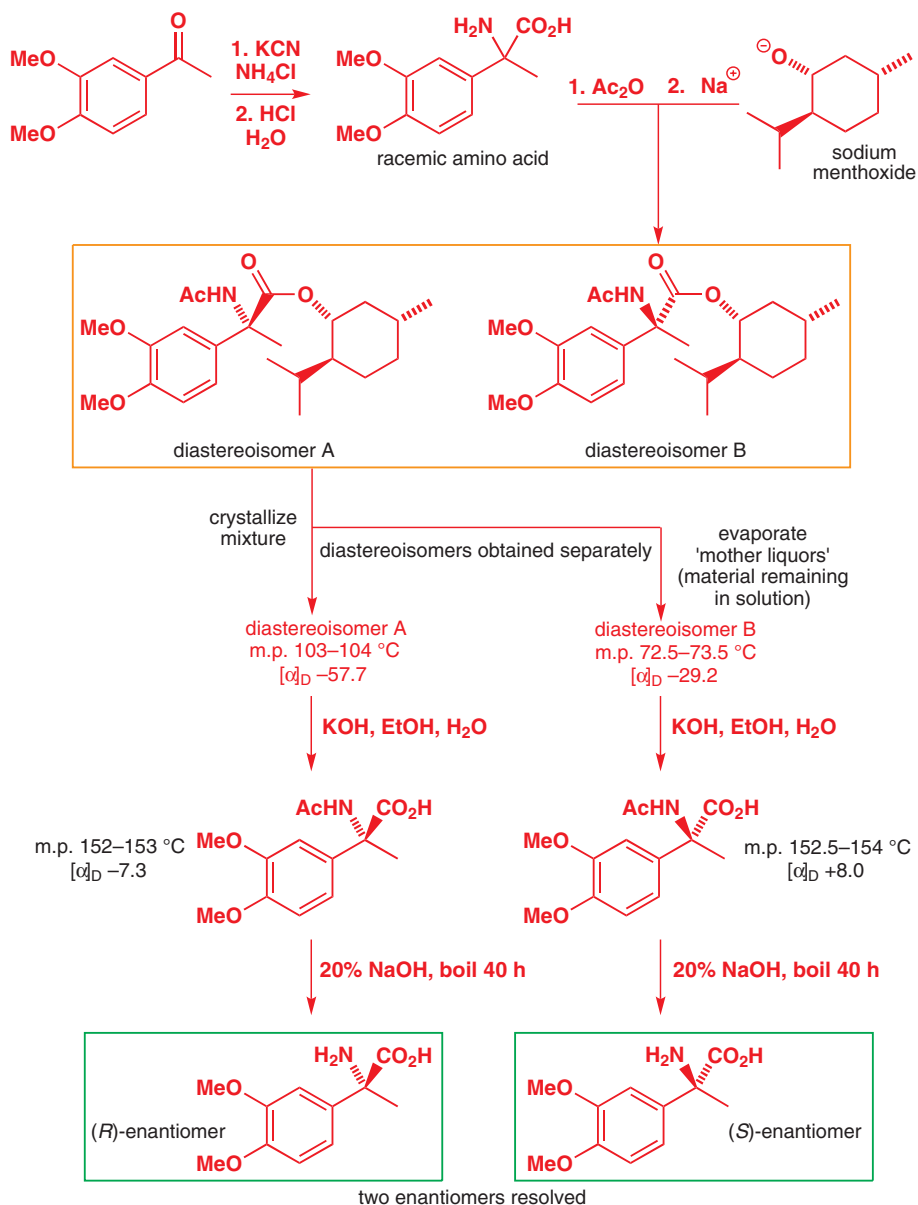

■ Note that the rotations of the pure diastereoisomers were not equal and opposite. These are single enantiomers of different compounds and there is no reason for them to have the same rotation.

Resolutions using diastereoisomeric salts

The key point about resolution is that we must bring together two stereogenic centres in such a way that there is a degree of interaction between them: separable diastereoisomers are created from inseparable enantiomers. In the last two examples, the stereogenic centres were brought together in covalent compounds, esters. Ionic compounds will do just as well—in fact, they are often better because it is easier to recover the compound after the resolution.

An important example is the resolution of the enantiomers of naproxen. Naproxen is a member of a family of compounds known as non-steroidal anti-inflammatory drugs (NSAIDs) which are 2-aryl propionic acids. This class also includes ibuprofen, the painkiller developed by Boots and marketed as Nurofen.

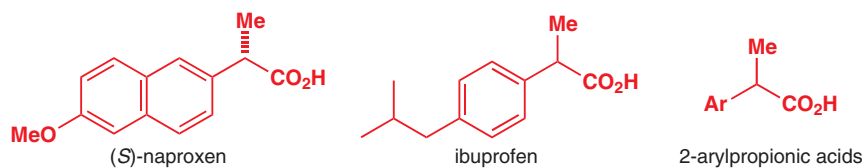

Both naproxen and ibuprofen are chiral but, while both enantiomers of ibuprofen are effective painkillers, and the drug is sold as a racemic mixture (and anyway racemizes in the body) only the (S) enantiomer of naproxen has anti-inflammatory activity. When the American pharmaceutical company Syntex first marketed the drug they needed a way of resolving the racemic naproxen they synthesized in the laboratory.

Since naproxen is a carboxylic acid, they chose to make the carboxylate salt of an enantiomerically pure amine, and found that the most effective was a glucose derivative. Crystals were formed, which consisted of the salt of the amine and (S)-naproxen, the salt of the amine with (R)-naproxen (the diastereoisomer of the crystalline salt) being more soluble and so remaining in solution. These crystals were filtered off and treated with base, releasing the amine (which can later be recovered and reused) and allowing the (S)-naproxen to crystallize as its sodium salt. This is an unusual resolving agent as a simpler amine might usually be preferred. However, it makes the point that many resolving agents may have to be tried before one is found that works.

resolution of naproxen via an amine salt

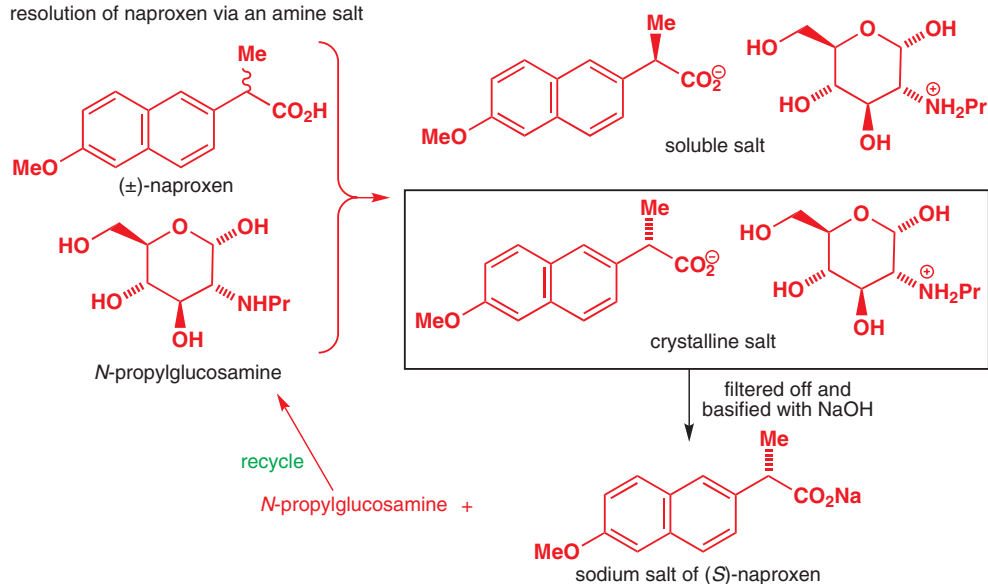

Chiral drugs

You may consider it strange that it was necessary to market naproxen as a single enantiomer, in view of what we have said about enantiomers having identical properties. The two enantiomers of naproxen do indeed have identical properties in the laboratory, but once they are inside a living system they, and any other chiral molecules, are differentiated by interactions with the enantiomerically pure molecules they find there. An analogy is that of a pair of gloves—the gloves weigh the same, are made of the same material, and have the same colour—in these respects they are identical. But interact them with a chiral environment, such as a hand, and they become differentiable because only one fits.

The way in which drugs interact with receptors mirrors this hand-and-glove analogy quite closely. Drug receptors, into which drug molecules fit like hands in gloves, are nearly always protein molecules, which are enantiomerically pure because they are made up of just L-amino acids. One enantiomer of a drug is likely to interact much better than the other, or perhaps in a different way altogether, so the two enantiomers of chiral drugs often have quite different pharmacological effects. In the case of naproxen, the (*S*)-enantiomer is 28 times as effective as the (*R*). Ibuprofen, on the other hand, is still marketed as a racemate because the compound racemizes in the bloodstream.

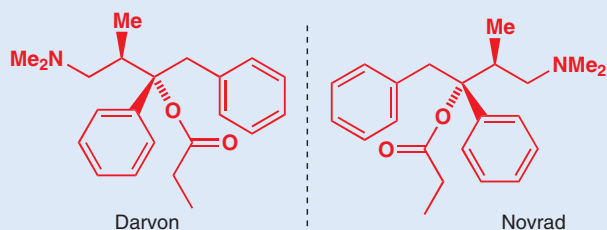

Sometimes, the enantiomers of a drug may have completely different therapeutic properties. One example is Darvon, which is a painkiller. Its enantiomer, known as Novrad, is an anticough agent. Notice how the enantiomeric relationship between these two drugs extends beyond their chemical structures! In Chapter 41 we will talk about other cases where two enantiomers have quite different biological effects.

Resolutions can be carried out by chromatography on chiral materials

■ Silica, SiO_2 , is a macromolecular array of silicon and oxygen atoms. Its surface is covered with free OH groups, which can be used as an anchor for chiral derivatizing agents.

Interactions even weaker than ionic bonds can be used to separate enantiomers. Chromatographic separation relies on a difference in affinity between a stationary phase (often silica) and a mobile phase (the solvent travelling through the stationary phase, known as the eluent) mediated by, for example, hydrogen bonds or van der Waals interactions. If the stationary phase is made chiral by bonding it with an enantiomerically pure compound (often a derivative of an amino acid), chromatography can be used to separate enantiomers.

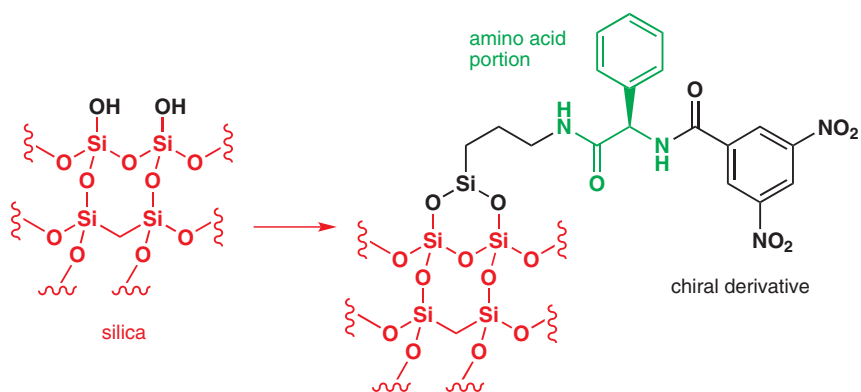

Chromatography on a chiral stationary phase is especially important when the compounds being resolved have no functional groups suitable for making the derivatives (usually esters or salts) needed for the more classical resolutions described above. For example, the two enantiomers of an analogue of the tranquillizer Valium were found to have quite different biological activities.

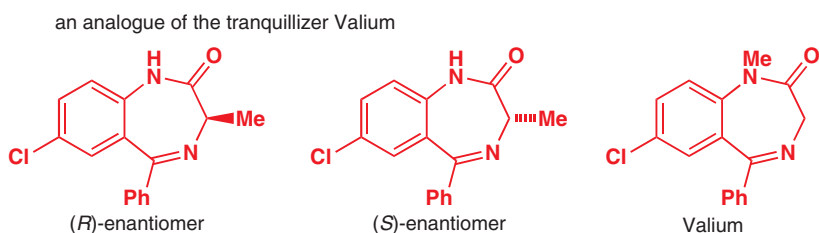

In order to study these compounds further, it was necessary to obtain them in enantiomerically pure form. This was done by passing a solution of the racemic compound through a column of silica bonded to an amino-acid-derived chiral stationary phase. The (*R*)-(-)-enantiomer showed a lower affinity for the stationary phase and therefore was eluted from the column first, followed by the (*S*)-(+)-enantiomer.

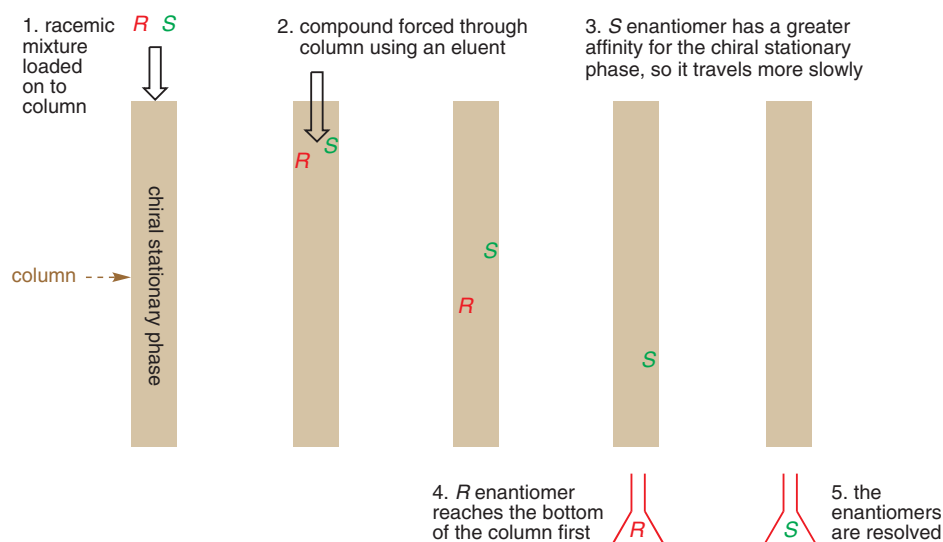

Two enantiomers of one molecule may be the same compound, but they are clearly different, although only in a limited number of situations. They can interact with biological systems differently, for example, and can form salts or compounds with different properties when reacted with a single enantiomer of another compound. In essence, enantiomers behave identically *except* when they are placed in a chiral environment. In Chapter 41 we will see how to use this fact to make single enantiomers of chiral compounds, but next we move on to three classes of reactions in which stereochemistry plays a key role: substitutions, eliminations, and additions.

Further reading

There are very many books on stereochemistry. The most comprehensive is probably E. L. Eliel and S. H. Wilen, *Stereochemistry of Organic Compounds*, Wiley Interscience, Chichester, 1994. But you may find this too comprehensive at this stage. A more accessible introduction is the Oxford Primer *Organic Stereochemistry*, M. J. T. Robinson, OUP, Oxford, 2001.

The first announcement of the correct structure of Feist's acid was by M. G. Ettinger, *J. Am. Chem. Soc.*, 1952, 74, 5805 and an interesting follow-up article gives the NMR spectrum: W. E. von Doering and H. D. Roth, *Tetrahedron*, 1970, 26, 2825.

■ You can think about chiral chromatography like this. Put yourself in this familiar situation: you want to help out a pensioner friend of yours who sadly lost his left leg in the war. A local shoe shop donates to you all their spare odd shoes, left and right, in his size (which happens to be the same as yours). You set about sorting the lefts from the rights, but are plunged into darkness by a power cut. What should you do? Well, you try every shoe on your right foot. If it fits you keep it; if not it's a left shoe and you throw it out.

Now this is just what chromatography on a chiral stationary phase is about. The stationary phase has lots of 'right feet' (one enantiomer of an adsorbed chiral molecule) sticking out of it and, as the mixture of enantiomers of 'shoes' flows past, 'right shoes' fit, and stick but 'left shoes' do not and flow on down the column, reaching the bottom first.

Check your understanding



To check that you have mastered the concepts presented in this chapter, attempt the problems that are available in the book's Online Resource Centre at <http://www.oxfordtextbooks.co.uk/orc/clayden2e/>

15

Nucleophilic substitution at saturated carbon

Connections

➔ Building on

- Attack of nucleophiles on carbonyl groups [ch6 & ch9](#)
- Substitution at carbonyl groups [ch10](#)
- Substitution of the oxygen atom of carbonyl groups [ch11](#)
- Reaction mechanisms [ch12](#)
- ^1H NMR [ch13](#)
- Stereochemistry [ch14](#)

Arriving at

- Nucleophilic attack on saturated carbon atoms, leading to substitution reactions
- How substitution at a saturated carbon atom differs from substitution at $\text{C}=\text{O}$
- Two mechanisms of nucleophilic substitution
- Intermediates and transition states in substitution reactions
- How substitution reactions affect stereochemistry
- What sort of nucleophiles can substitute, and what sort of leaving groups can be substituted
- The sorts of molecules that can be made by substitution, and what they can be made from

➔ Looking forward to

- Elimination reactions [ch17](#)
- Substitution reactions with aromatic compounds as nucleophiles [ch21](#)
- Substitution reactions with enolates as nucleophiles [ch25](#)
- Retrosynthetic analysis [ch28](#)
- Participation, rearrangement, and fragmentation reactions [ch36](#)

Mechanisms for nucleophilic substitution

Chapter 10...

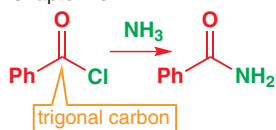

This chapter...

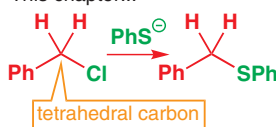

Substitution is the replacement of one group by another. You met such reactions in Chapter 10, and an example is shown in the margin. This reaction is a substitution because the Cl group is replaced by the NH_2 group. You learnt to call the molecule of ammonia (NH_3) the **nucleophile** and the chloride you called the **leaving group**. In Chapter 10, the substitution reactions always took place at the *trigonal* (sp^2) carbon atom of a carbonyl group.

In this chapter we shall be looking at reactions such as the second reaction in the margin. These are substitution reactions, because the Cl group is replaced by the PhS group. But the CH_2 group at which the reaction takes place is a *tetrahedral* (sp^3), or *saturated*, carbon atom, rather than a $\text{C}=\text{O}$ group. This reaction and the one above may look superficially the same but they are quite different in mechanism. The requirements of good reagents are also different in substitutions at carbonyl groups and at saturated carbon—that's why we changed the nucleophile from NH_3 to PhS^- : ammonia would not give a good yield of PhCH_2NH_2 in the second reaction.

Let's have a look at why the mechanisms of the two substitutions must be different. Here's a summary of the mechanism of the first reaction.

Online support. The icon  in the margin indicates that accompanying interactive resources are provided online to help your understanding: just type www.chemtube3d.com/clayden/123 into your browser, replacing **123** with the number of the page where you see the icon. For pages linking to more than one resource, type **123-1, 123-2** etc. (replacing **123** with the page number) for access to successive links.

mechanism of nucleophilic substitution at the carbonyl group

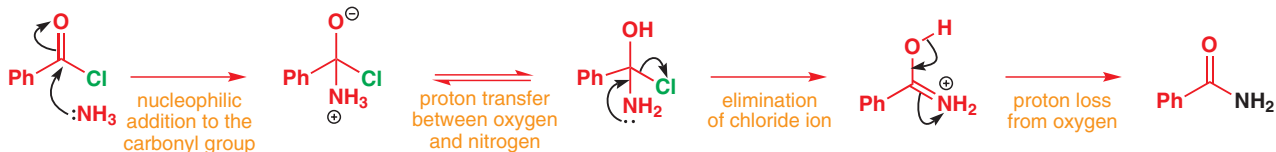

In the first step the nucleophile attacks the C=O π bond. It's immediately obvious that the first step is no longer possible at a saturated carbon atom. The electrons cannot be added to a π bond as the CH_2 group is fully saturated. In fact there is no way for the nucleophile to add before the leaving group departs (as it did in the reaction above) because this would give an impossible five-valent carbon atom.

Instead, two new and different mechanisms become possible. Either the leaving group goes first and the nucleophile comes in later, or the two events happen at the same time. The first of these possibilities you will learn to call the $\text{S}_{\text{N}}1$ mechanism. The second mechanism, which shows how the neutral carbon atom can accept electrons provided it loses some at the same time, you will learn to call the $\text{S}_{\text{N}}2$ mechanism. You will see later that both mechanisms are possible with this molecule, benzyl chloride.

the $\text{S}_{\text{N}}1$ mechanism

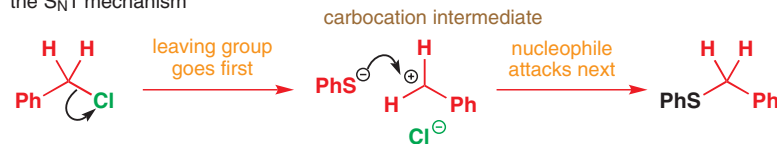

the $\text{S}_{\text{N}}2$ mechanism

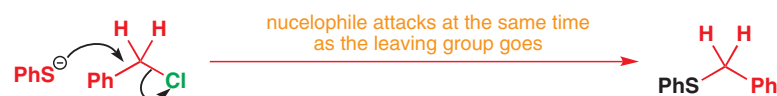

Interactive mechanism for amide formation

Interactive mechanisms for $\text{S}_{\text{N}}1$ and $\text{S}_{\text{N}}2$

Why is it important to know about the two mechanisms for substitution?

If we know which mechanism a compound reacts by, we know what sort of conditions to use to get good yields in substitutions. For example, if you look at a commonly used nucleophilic substitution, the replacement of OH by Br, you'll find that two quite different reaction conditions are used depending on the structure of the alcohol. *Tertiary* alcohols react rapidly with HBr to give tertiary alkyl bromides. *Primary* alcohols, on the other hand, react only very slowly with HBr and are usually converted to primary alkyl bromides with PBr_3 . The reason is that the first example is an $\text{S}_{\text{N}}1$ reaction while the second is an $\text{S}_{\text{N}}2$ reaction: by the end of this chapter you will have a clear picture of how to predict which mechanism will apply and how to choose appropriate reaction conditions.

substitution of a tertiary alcohol



substitution of a primary alcohol

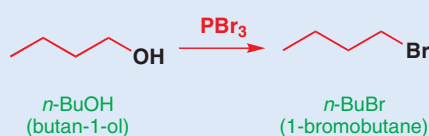

For $\text{CH}_3\text{CH}_2\text{CH}_2\text{CH}_2\text{Br}$ the reaction is **second order** (its rate depends on both $[\text{R-Br}]$ and $[\text{OH}^-]$)

For tert-butyl-Br the reaction is **first order** (its rate depends only on $[\text{R-Br}]$ and not on $[\text{OH}^-]$)

Kinetic evidence for the $\text{S}_{\text{N}}1$ and $\text{S}_{\text{N}}2$ mechanisms

Before we go any further we are going to look in a bit more detail at these two mechanisms because they allow us to explain and predict many aspects of substitution reactions. The evidence that convinced chemists that there are two different mechanisms for substitution at saturated carbon is kinetic: it relates to the rate of reactions such as the displacement of bromide by hydroxide, as shown in the margin.

It was discovered, chiefly by Hughes and Ingold in the 1930s, that some nucleophilic substitutions are first order (that is, the rate depends only on the concentration of the alkyl halide

Edward David Hughes (1906–63) and Sir Christopher Ingold (1893–1970) worked at University College, London in the 1930s. They first thought of many of the mechanistic ideas that chemists now take for granted.

■ There is more about the relationship between reaction rates and mechanisms in Chapter 12. Quantities in square brackets represent concentrations and the proportionality constant k is called the rate constant.

■ Please note how this symbol is written. The S and the N are both capitals and the N is a subscript.

and does not depend on the concentration of the nucleophile), while others are second order (the rate depends on the concentrations of both the alkyl halide and the nucleophile). How can we explain this result? In what we called the 'S_N2 mechanism' on p. 329 there is just one step. Here's the one-step S_N2 mechanism for substitution of *n*-butyl bromide by hydroxide:



With only one step, that step must be the **rate-determining step**. The rate of the overall reaction depends only on the rate of this step, and kinetic theory tells us that the rate of a reaction is proportional to the concentrations of the reacting species:

$$\text{rate of reaction} = k[\textit{n}\text{-BuBr}][\text{HO}^-]$$

If this mechanism is right, then the rate of the reaction will be simply and linearly proportional to both $[\textit{n}\text{-BuBr}]$ and $[\text{HO}^-]$. And it is. Ingold measured the rates of reactions like these and found that they were proportional to the concentration of each reactant—in other words they were second order. He called this mechanism Substitution, Nucleophilic, 2nd order; S_N2 for short. The rate equation is usually given like this, with k_2 representing the second-order rate constant.

$$\text{rate} = k_2[\textit{n}\text{-BuBr}][\text{HO}^-]$$

Significance of the S_N2 rate equation

This equation is useful for two reasons. Firstly, it gives us a test for the S_N2 mechanism. Let's illustrate this with another example: the reaction between NaSMe (an ionic solid—the nucleophile will be the anion MeS[−]) and MeI to give Me₂S, dimethyl sulfide.

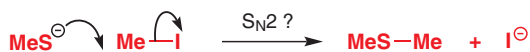

To study the rate equation, first, we keep the concentration of NaSMe constant and in a series of experiments vary that of MeI and see what happens to the rate. Then in another set of experiments we keep the concentration of MeI constant and vary that of MeSNa and see what happened to the rate. If the reaction is indeed S_N2 we should get a linear relationship in both cases: the graphs in the margin show a typical set of results.

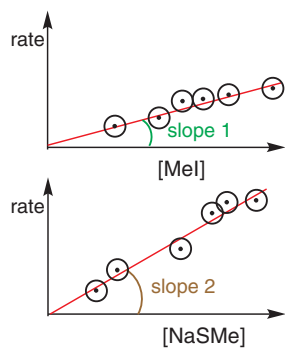

The first graph tells us that the rate is proportional to $[\text{MeI}]$, that is, $\text{rate} = k_a[\text{MeI}]$ and the second graph that it is proportional to $[\text{MeSNa}]$, that is, $\text{rate} = k_b[\text{MeSNa}]$. But why are the slopes different? If you look at the rate equation for the reaction, you will see that we have incorporated a constant concentration of one of the reagents into what appears to be the rate constant for the reaction. The true rate equation is

$$\text{rate} = k_2[\text{MeSNa}][\text{MeI}]$$

If $[\text{MeSNa}]$ is constant, the equation becomes

$$\text{rate} = k_a[\text{MeI}], \text{ where } k_a = k_2[\text{MeSNa}]$$

If $[\text{MeI}]$ is constant, the equation becomes

$$\text{rate} = k_b[\text{MeSNa}], \text{ where } k_b = k_2[\text{MeI}]$$

If you examine the graphs you will see that the slopes are different because

$$\text{slope 1} = k_a = k_2[\text{MeSNa}], \text{ but slope 2} = k_b = k_2[\text{MeI}]$$

We can easily measure the true rate constant k_2 from these slopes because we know the constant values for $[\text{MeSNa}]$ in the first experiment and for $[\text{MeI}]$ in the second. The value of k_2

from both experiments should be the same. The mechanism for this reaction is indeed S_N2 : the nucleophile MeS^- attacks as the leaving group I^- leaves.

The second reason that the S_N2 rate equation is useful is that it confirms that the performance of an S_N2 reaction depends **both on the nucleophile and on the carbon electrophile**. We can therefore make a reaction go better (speed it up or improve its yield) by changing either. For example, if we want to displace I^- from MeI using an oxygen nucleophile we might consider using any of those in the table below.

Oxygen nucleophiles in the S_N2 reaction

Oxygen nucleophile	$\text{p}K_a$ of conjugate acid	Rate in S_N2 reaction
HO^-	15.7 (H_2O)	fast
RCO_2^-	about 5 (RCO_2H)	moderate
H_2O	-1.7 (H_3O^+)	slow
RSO_2O^-	0 (RSO_2OH)	slow

The same reasons that made hydroxide ion basic (chiefly that it is unstable as an anion and therefore reactive) make it a good nucleophile. Basicity can be viewed as nucleophilicity towards a proton, and nucleophilicity towards carbon must be related. So if we want a fast reaction, we should use NaOH rather than, say, Na_2SO_4 to provide the nucleophile. Even at the same concentration, the rate constant k_2 with HO^- as the nucleophile is much greater than the k_2 with SO_4^{2-} as the nucleophile.

But that is not our only option. The reactivity and hence the structure of the carbon electrophile matter too. If we want reaction at a methyl group we can't change the carbon skeleton, but we can change the leaving group. The table below shows what happens if we use the various methyl halides in reaction with NaOH . The best choice for a fast reaction (greatest value of k_2) will be to use MeI and NaOH to give methanol.

Halide leaving groups in the S_N2 reaction

Halide X in MeX	$\text{p}K_a$ of conjugate acid HX	Rate of reaction with NaOH
F	+3	very slow indeed
Cl	-7	moderate
Br	-9	fast
I	-10	very fast

● **The rate of an S_N2 reaction depends on:**

- the nucleophile
- the carbon skeleton
- the leaving group

along with the usual factors of temperature and solvent.

Significance of the S_N1 rate equation

If we replace the substitution of *n*-butyl bromide with a substitution of *t*-butyl bromide, we get the reaction shown in the margin. It turns out that, kinetically, this reaction is first order: its rate depends only on the concentration of *tert*- BuBr —it doesn't matter how much hydroxide you add: the rate equation is simply

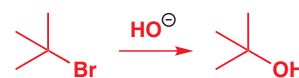

➔ See Chapter 8 for discussion of $\text{p}K_a$ values.

You saw in Chapter 10 that nucleophilicity towards the carbonyl group is closely related to basicity. The same is not quite so true for nucleophilic attack on the saturated carbon atom, as we shall see, but there is a relationship nonetheless.

■ We shall discuss nucleophilicity and leaving group ability in more detail later.

$$\text{rate} = k_1[t\text{-BuBr}]$$

The reason for this is that the reaction happens in two steps: first the bromide leaves, to generate a carbocation, and only then does the hydroxide ion move in to attack, forming the alcohol.

the S_N1 mechanism: reaction of $t\text{-BuBr}$ with hydroxide ion



In the S_N1 mechanism, the formation of the cation is the rate-determining step. This makes good sense: a carbocation is an unstable species and so it will be formed slowly from a stable neutral organic molecule. But once formed, being very reactive, all its reactions will be fast, regardless of the nucleophile. The rate of disappearance of $t\text{-BuBr}$ is therefore simply the rate of the slow first step: the hydroxide nucleophile is not involved in this step and therefore does not appear in the rate equation and hence cannot affect the rate. If this is not clear to you, think of a crowd of people trying to leave a railway station or a football match through some turnstiles. It doesn't matter how fast they walk, run, or are driven away in taxis afterwards, it is only the rate of struggling through the turnstiles that determines how fast the station or stadium empties.

Once again, this rate equation is useful because we can determine whether a reaction is S_N1 or S_N2 . We can plot the same graphs as we plotted before. If the reaction is S_N2 , the graphs look like those we have just seen. But if it is S_N1 , the graphs in the margin show what happens when we vary $[t\text{-BuBr}]$ at constant $[\text{NaOH}]$ and then vary $[\text{NaOH}]$ at constant $[t\text{-BuBr}]$.

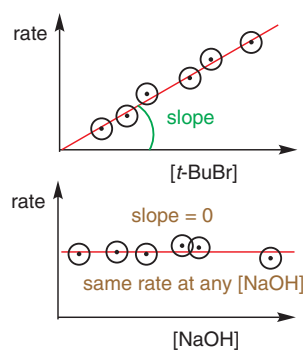

The slope of the first graph is simply the first-order rate constant because $\text{rate} = k_1[t\text{-BuBr}]$. But the slope of the second graph is zero. The rate-determining step does not involve NaOH so adding more of it does not speed up the reaction. The reaction shows first-order kinetics (the rate is proportional to one concentration only) and the mechanism is called S_N1 , that is, Substitution, Nucleophilic, 1st order.

This observation is very significant. The fact that the nucleophile does not appear in the rate equation means that not only does its *concentration* not matter—its *reactivity* doesn't matter either! We are wasting our time opening a tub of NaOH to add to this reaction—water will do just as well. All the oxygen nucleophiles in the table above react at the *same* rate with $t\text{-BuBr}$ although they react at very different rates with MeI . Indeed, S_N1 substitution reactions are generally best done with weaker, non-basic nucleophiles to avoid the competing elimination reactions discussed in Chapter 17.

● **The rate of an S_N1 reaction depends on:**

- the carbon skeleton
- the leaving group

along with the usual factors of temperature and solvent.

But NOT the nucleophile.

How can we decide which mechanism (S_N1 or S_N2) will apply to a given organic compound?

So, substitution reactions at saturated C go via one of two alternative mechanisms, each with a very different dependence on the nature of the nucleophile. It's important to be able to predict which mechanism is likely to apply to any reaction, and rather than doing the kinetic experiments to find out, we can give you a few simple pointers to predict which will operate

in which case. The factors that affect the mechanism of the reaction also help to explain why that mechanism operates.

The most important factor is **the structure of the carbon skeleton**. A helpful generalization is that compounds that can form relatively stable carbocations generally do so and react by the S_N1 mechanism, while the others have no choice but to react by the S_N2 mechanism. As you will see in a moment, the most stable carbocations are the ones that have the most substituents, so the more carbon substituents at the reaction centre, the more likely the compound is to react by the S_N1 mechanism.

As it happens, the structural factors that make cations stable usually also lead to slower S_N2 reactions. Heavily substituted compounds are good in S_N1 reactions, but bad in an S_N2 reaction because the nucleophile would have to squeeze its way into the reaction centre past the substituents. It is better for an S_N2 reaction if there are only hydrogen atoms at the reaction centre—methyl groups react fastest by the S_N2 mechanism. The effects of the simplest structural variations are summarized in the table below (where R is a simple alkyl group like methyl or ethyl).

● S_N1 or S_N2 ?

Simple structures and choice of S_N1 or S_N2 mechanism

Structure type	$\text{Me}-\text{X}$			
S_N1 reaction?	no	no	moderate	excellent
S_N2 reaction?	good	good	moderate	no

forms carbocation reluctantly

readily forms carbocation

The only doubtful case is the secondary alkyl derivative, which can react by either mechanism, although it is not very good at either. The first question you should ask when faced with a new nucleophilic substitution is this ‘Is the carbon electrophile methyl, primary, secondary, or tertiary?’ This will start you off on the right foot, which is why we introduced these important structural terms in Chapter 2.

Later in this chapter we will look in more detail at the differences between the two mechanisms and the structures that favour each, but all of what we say will build on the table above.

A closer look at the S_N1 reaction

In our discussion of the S_N1 reaction above, we proposed the *t*-butyl carbocation as a reasonable intermediate formed by loss of bromide from *t*-butyl bromide. We now need to explain the evidence we have that carbocations can indeed exist, and the reasons why the *t*-butyl carbocation is much more stable than, for example, the *n*-butyl cation.

In Chapter 12 we introduced the idea of using a reaction energy profile diagram to follow the progress of a reaction from starting materials to products, via transition states and any intermediates. The energy profile diagram for the S_N1 reaction between *t*-butyl bromide and water looks something like this:

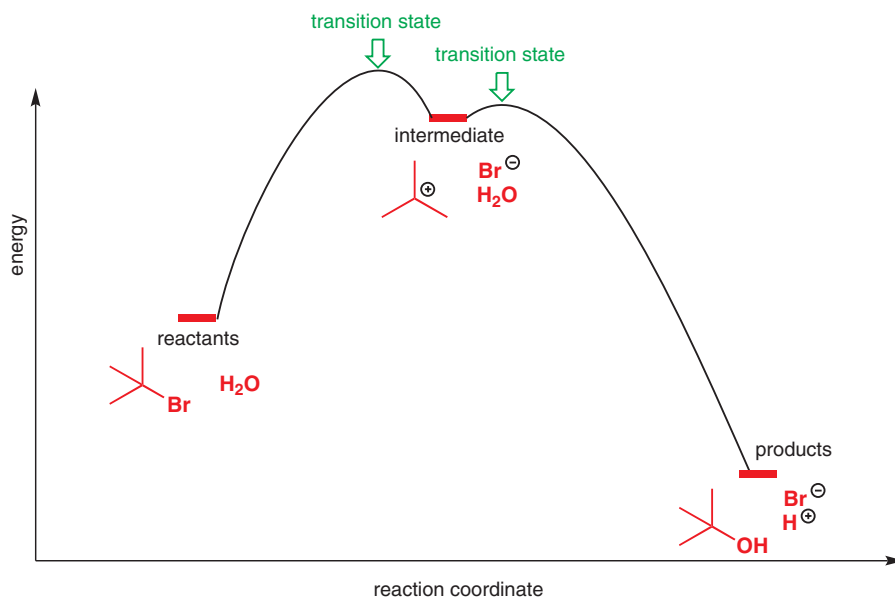

The carbocation is shown as an intermediate—a species with a finite (if short) lifetime for reasons we shall describe shortly. And because we know that the first step, the formation of the carbocation, is slow, that must be the step with the higher energy transition state. The energy of that transition state, which determines the overall rate of the reaction, is closely linked to the stability of the carbocation intermediate, and it is for this reason that the most important factor in determining the efficiency of an S_N1 reaction is the stability or otherwise of any carbocation that might be formed as an intermediate.

Shape and stability of carbocations

We discussed the planar shape of the methyl cation in Chapter 4 (p. 103), and the *tert*-butyl cation is similar in structure: the electron-deficient central carbon atom has only six electrons, which it uses to form three σ bonds, and therefore also carries an empty p orbital. Any carbocation will have a planar carbon atom with an empty p orbital. Think of it this way: only filled orbitals contribute to the energy of a molecule, so if you have to have an unfilled orbital (which a carbocation always does) it is best to make that unfilled orbital as high in energy as possible to keep the filled orbitals low in energy. p orbitals are higher in energy than s orbitals (or hybrid sp, sp², or sp³ orbitals for that matter) so the carbocation always keeps the p orbital empty.

Carbocation stability

The *t*-butyl carbocation is *relatively* stable as far as carbocations go, but you would not be able to keep it in a bottle on the shelf! The concept of more and less stable carbocations is important in understanding the S_N1 reaction, but it is important to realize that these terms are all relative: even 'stable' carbocations are highly reactive electron-deficient species.

correct planar structure
for the *t*-butyl cation

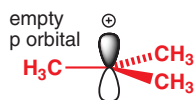

less repulsion
between
bonding pairs of
electrons

incorrect tetrahedral structure
for the *t*-butyl cation

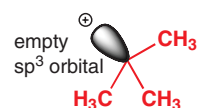

more repulsion
between
bonding pairs of
electrons

We know that the *t*-butyl cation is stable enough to observe because of the work of George Olah, who won the Nobel Prize for Chemistry in 1994. The challenge is that carbocations are very reactive electrophiles, so Olah's idea was to have a solution containing no nucleophiles. Any cation must have an anion to balance the charge, so the important advance was to find anions, consisting of a negatively charged atom surrounded by tightly held halogen atoms, which are just too stable to be nucleophilic. Examples include BF_4^- , PF_6^- , and Sb_6^- . The first is small and tetrahedral and the others are larger and octahedral.

In these anions, the negative charge does not correspond to a lone pair of electrons (they are like BH_4^- in this respect) and there is no orbital high enough in energy to act as a nucleophile. By using a non-nucleophilic solvent, liquid SO_2 , at low temperature, Olah was able to turn alcohols into carbocations with these counterions. This is what happens when *tert*-butanol is treated with SbF_5 and HF in liquid SO_2 . The acid protonates the hydroxyl group, allowing it to

non-nucleophilic anions

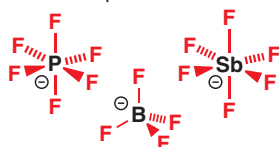

leave as water, while the SbF₅ grabs the fluoride ion, preventing it from acting as a nucleophile. The cation is left high and dry.

Olah's preparation of the *t*-butyl cation in liquid SO₂

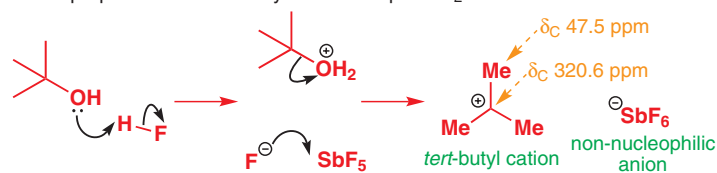

The proton NMR of this cation showed just one signal for the three methyl groups at 4.15 ppm, quite far downfield for C–Me groups. The ¹³C spectrum also showed downfield Me groups at 47.5 ppm, but the key evidence that the cation was formed was the shift of the central carbon atom, which came at an amazing 320.6 ppm, way downfield from anything you have met before. This carbon is very deshielded—it is positively charged and extremely electron deficient.

From Olah's work we know what the *t*-butyl cation looks like by NMR, so can we use NMR to try to detect it as an intermediate in substitution reactions? If we mix *t*-BuBr and NaOH in an NMR tube and let the reaction run inside the NMR machine, we see no signals belonging to the cation. But this proves nothing. We would not expect a reactive intermediate to be present in any significant concentration. There is a simple reason for this. If the cation is unstable, it will react very quickly with any nucleophile around and there will never be any appreciable amount of cation in solution. Its rate of formation will be much slower than its rate of reaction.

Alkyl substituents stabilize a carbocation

Olah found that he could measure the spectrum of the *tert*-butyl cation, but he was never able to observe the methyl cation in solution. Why do those extra substituents stabilize the cationic centre?

Any charged organic intermediate is inherently unstable because of the charge. A carbocation can be formed only if it has some extra stabilization, and extra stabilization can come to the planar carbocation structure from weak donation of σ bond electrons into the empty p orbital of the cation. In the *t*-butyl cation, three of these donations occur at any one time: it doesn't matter if the C–H bonds point up or down; one C–H bond of each methyl group must be parallel to one lobe of the empty p orbital at any one time. The first diagram shows one overlap in orbital terms and the second and third diagrams, three as dotted lines.

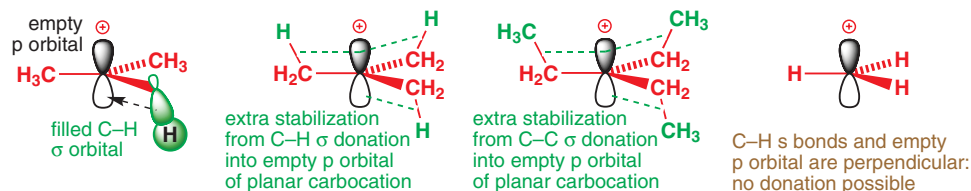

There is nothing special about the C–H bond donating electrons into an empty orbital: a C–C bond is just as good and some bonds are better (C–Si, for example). But there must be a bond of some sort—a hydrogen atom by itself has no lone pairs and no σ bonds so it cannot stabilize a cation.

Planarity is so important to the structure of a carbocation that if a tertiary cation cannot become planar, it is not formed. A classic case is the structure in the margin, which does not react with nucleophiles either by S_N1 or by S_N2. It does not react by S_N1 because the cation cannot become planar, nor by S_N2 because the nucleophile cannot approach the carbon atom from the right direction.

In general, though, simple tertiary structures undergo efficient S_N1 substitution reactions. With good leaving groups such as halides, substitutions can be done under neutral conditions; with less good leaving groups such as alcohols or ethers, acid catalysis is required. The following group of reactions give an idea of the types of S_N1 reactions that work well.

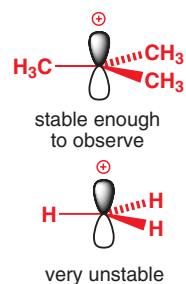

Interactive display of stability and structure of carbocations

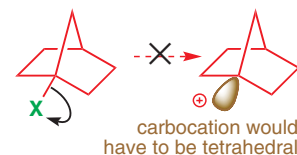

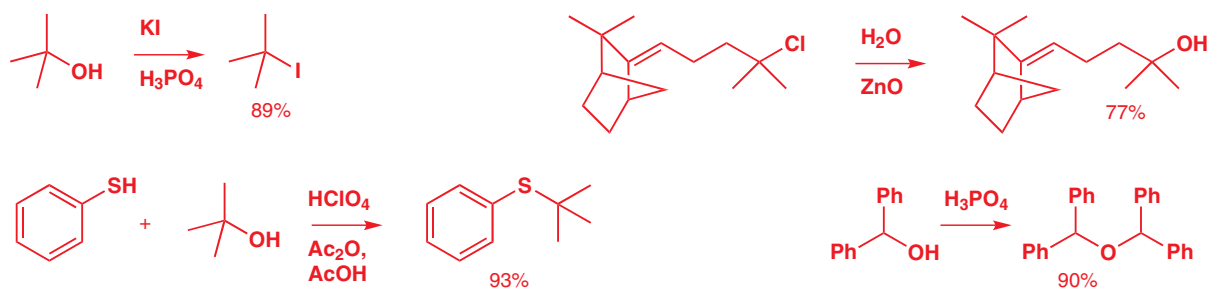

An adjacent C=C π system stabilizes a carbocation: allylic and benzylic carbocations

► We discussed conjugation in allyl cations in Chapter 7.

Tertiary carbocations are more stable than primary ones, but powerful stabilization is also provided when there is genuine conjugation between the empty p orbital and adjacent π or lone pair electrons. The allyl cation has a filled (bonding) orbital containing two electrons delocalized over all three atoms and an important empty orbital with coefficients on the end atoms only. It's this orbital that is attacked by nucleophiles. The curly arrow picture tells us the same thing.

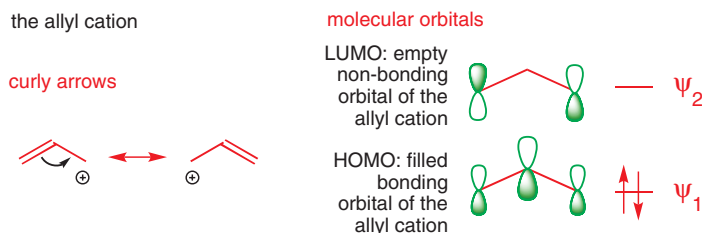

Allylic electrophiles react well by the S_N1 mechanism because the allyl cation is relatively stable. Here's an example of a reaction working in the opposite direction from most of those you have seen so far—we start with the alcohol and form the bromide. Treatment of cyclohex-enol with HBr gives the corresponding allylic bromide.

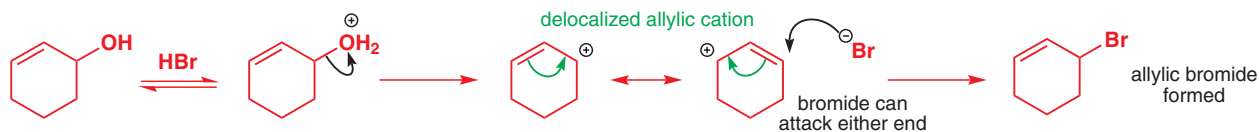

In this case, only one compound is formed because attack at either end of the allylic cation gives the same product. But when the allylic cation is unsymmetrical this can be a nuisance as a mixture of products may be formed. It doesn't matter which of these two butenols you treat with HBr, you get the same delocalized allylic cation.

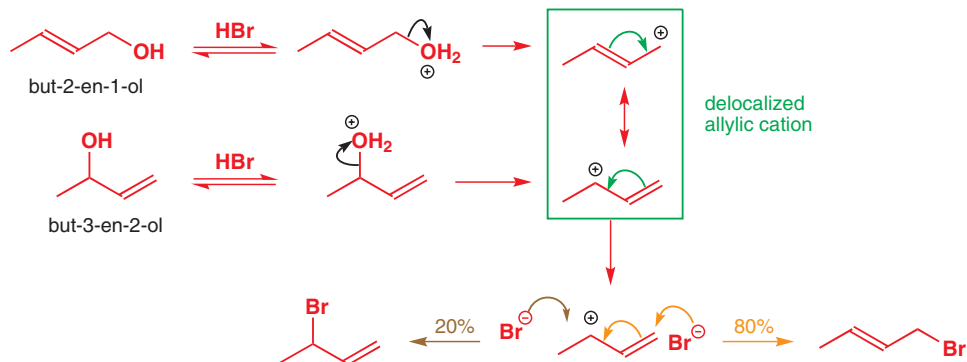

When this cation reacts with Br⁻, about 80% goes to one end and 20% to the other, giving a mixture of butenyl bromides. This **regioselectivity** (where the nucleophile attacks) is determined by steric hindrance: attack is faster at the less hindered end of the allylic system.

Sometimes this ambiguity is useful. The tertiary allylic alcohol 2-methylbut-3-en-2-ol is easy to prepare and reacts well by the S_N1 mechanism because it can form a stable carbocation that is both tertiary and allylic. The allylic carbocation intermediate is unsymmetrical and reacts only at the less substituted end to give 'prenyl bromide'.

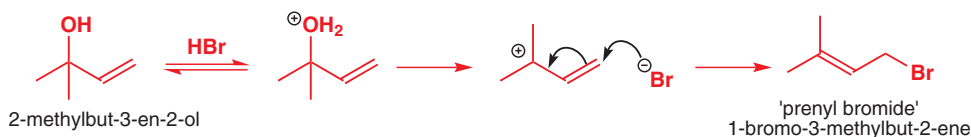

The benzyl cation is about as stable as the allyl cation but lacks its ambiguity of reaction. Although the positive charge is delocalized around the benzene ring, to three positions in particular, the benzyl cation always reacts on the side chain so that aromaticity is preserved.

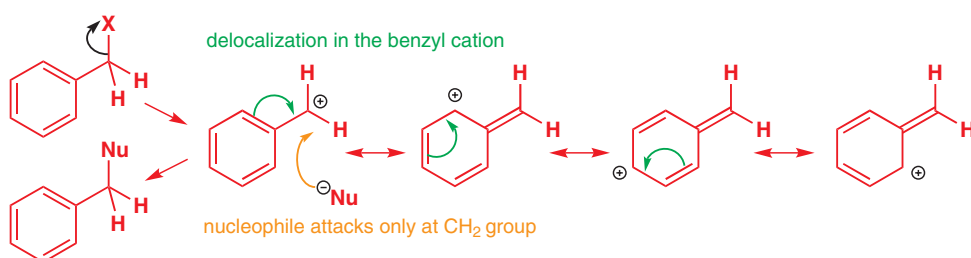

An exceptionally stable cation is formed when three benzene rings can help to stabilize the same positive charge. The result is the triphenylmethyl cation or, for short, the trityl cation. Trityl chloride is used to form an ether with a primary alcohol group by an S_N1 reaction. You will notice that pyridine is used as solvent for the reaction. Pyridine (a weak base: the pK_a of its conjugate acid is 5.5—see Chapter 8) is not strong enough to remove the proton from the primary alcohol (pK_a about 15), and there would be no point in using a base strong enough to make RCH₂O⁻ as the nucleophile makes no difference to an S_N1 reaction. Instead the TrCl ionizes first to trityl cation, which now captures the primary alcohol and finally pyridine is able to remove the proton from the oxonium ion. Pyridine does not catalyse the reaction; it just stops it becoming too acidic by removing the HCl formed. Pyridine is also a convenient polar organic solvent for ionic reactions.

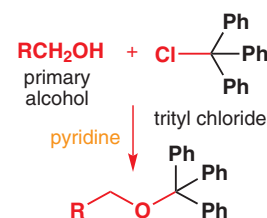



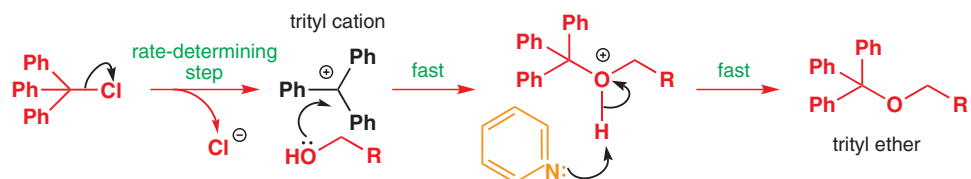



■ The symbol Tr refers to the group Ph₃C.

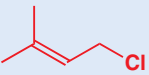

The table below shows the rates of solvolysis (i.e. a reaction in which the solvent acts as the nucleophile) in 50% aqueous ethanol for substituted allylic chlorides compared with benzylic chlorides and simple alkyl chlorides. The values give you an idea of the relative reactivity towards substitution of the different classes of compound. These rates are mostly S_N1, but there will be some S_N2 reactivity with the primary compounds.

Rates of solvolysis of alkyl chlorides in 50% aqueous ethanol at 44.6 °C

Compound	Relative rate	Comments
	0.07	primary chloride: probably all S _N 2
	0.12	secondary chloride: can do S _N 1 but not very well
	2100	tertiary chloride: very good at S _N 1
	1.0	primary but allylic: S _N 1 all right
	91	allylic cation is secondary at one end
	130000	allylic cation is tertiary at one end: compare with 2100 for simple tertiary
	7700	primary but allylic and benzylic

Carbocations are stabilized by an adjacent lone pair

The alkyl chloride known as methyl chloromethyl ether, MeOCH_2Cl , reacts very well with alcohols to form ethers. Being a primary alkyl chloride, you might think that its reactions would follow an S_N2 mechanism, but in fact it has characteristic S_N1 reactivity. As usual, the reason for its preference for the S_N1 mechanism is its ability to form a stabilized carbocation. Loss of the chloride ion is assisted by the adjacent lone pair, and we can draw the resulting cation either as an oxonium ion or as a carbocation.

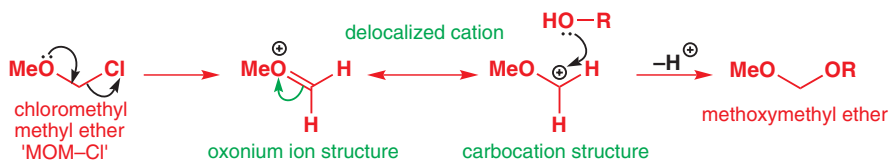

The methoxymethyl cation

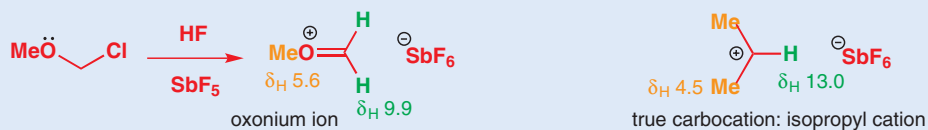

Olah has used the methods described above to make the methoxymethyl cation in solution. Although this cation can be drawn either as an oxonium ion or as a primary carbocation, the oxonium ion structure is the more realistic. The proton NMR spectrum of the cation compared with that of the isopropyl cation (this is the best comparison we can make) shows that the protons on the CH₂ group resonate at 9.9 ppm instead of at the 13.0 ppm of the true carbocation.

If you think back to Chapter 11, you will recall that the first step in the hydrolysis of an acetal is a similar reaction, with one alkoxy group replaced by water to give a hemiacetal. We considered the mechanism for this reaction in Chapter 11 but did not then concern ourselves with a label for the first step. It is in effect an S_N1 substitution reaction: the decomposition of the protonated acetal to give an oxonium ion. If you compare this step with the reaction of the chloroether we have just described you will see that they are very similar in mechanism.

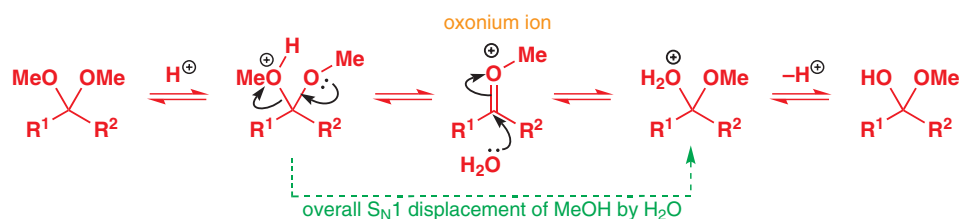

Interactive mechanism for acetal hydrolysis

A common mistake

Don't be tempted to shortcut this mechanism by drawing the displacement of the first molecule of methanol by water as an S_N2 reaction.

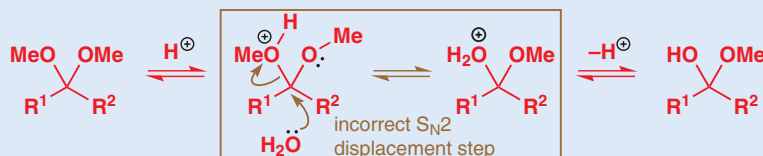

An S_N2 mechanism is unlikely at such a crowded carbon atom. However, the main reason why the S_N2 mechanism is wrong is that the S_N1 mechanism is so very efficient, with a neighbouring MeO group whose lone pair can stabilize the carbocation intermediate. The S_N2 mechanism doesn't get a chance.

This mechanism for the S_N1 replacement of one electronegative group at a carbon atom by a nucleophile where there is another electronegative group at the same carbon atom is very general. You should look for it whenever there are two atoms such as O, N, S, Cl, or Br joined to the same carbon atom. The better leaving groups (such as the halogens) need no acid catalyst but the less good ones (N, O, S) usually need acid.



➔ Think back to the formation and reactions of iminium ions in Chapter 11 for further examples.

We now have in the box below a complete list of the sorts of structures that normally react by the S_N1 mechanism rather than by the S_N2 mechanism.

Stable carbocations as intermediates in S_N1 reactions

Type of cations	Example 1	Example 2
simple alkyl	tertiary (good) t-butyl cation $\text{Me}_3\text{C}^{\oplus} = \text{Me}-\text{C}^{\oplus}(\text{Me})_2$	secondary (not so good) i-propyl cation $\text{Me}_2\text{CH}^{\oplus} = \text{H}-\text{C}^{\oplus}(\text{Me})_2$
conjugated	allylic 	benzylic
heteroatom-stabilized	oxygen-stabilized (oxonium ions) 	nitrogen-stabilized (iminium ions)

A closer look at the S_N2 reaction

■ Notice that we said *simple* alkyl groups: of course, primary allylic, benzylic, and RO or R₂N substituted primary derivatives may react by S_N1!

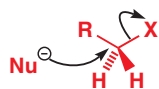

uncluttered approach of nucleophile in S_N2 reactions of methyl compounds (R=H) and primary alkyl compounds (R=alkyl)

Among simple alkyl groups, methyl and primary alkyl groups always react by the S_N2 mechanism and never by S_N1. This is partly because the cations are unstable and partly because the nucleophile can push its way in easily past the hydrogen atoms.

A common way to make ethers is to treat an alkoxide anion with an alkyl halide. If the alkyl halide is a methyl compound, we can be sure that the reaction will go by the S_N2 mechanism. A strong base, here NaH, will be needed to form the alkoxide ion, since alcohols are weak acids (pK_a about 16). Methyl iodide is a suitable electrophile.

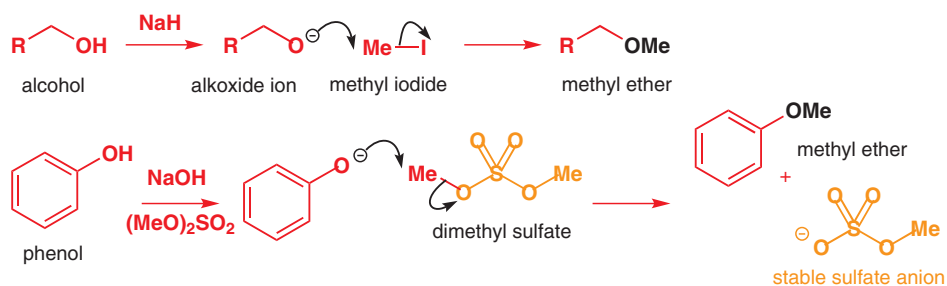

With the more acidic phenols (pK_a about 10), NaOH is a strong enough base and dimethyl sulfate, the dimethyl ester of sulfuric acid, is often used as the electrophile. It is worth using a strong base to make the alcohol into a better nucleophile because as we discussed on p. 331 the rate equation for an S_N2 reaction tells us that the strength and concentration of the nucleophile affects the rate of the reaction.

The transition state for an S_N2 reaction

➔ We introduced the terms *transition state* and *intermediate* in Chapter 12.

Another way to put this would be to say that the nucleophile, the methyl group, and the leaving group are all present in the transition state for the reaction. The transition state is the highest energy point on the reaction pathway. In the case of an S_N2 reaction it will be the point where the new bond from the nucleophile is partly formed while the old bond to the leaving group is not yet completely broken. It will look something like this:

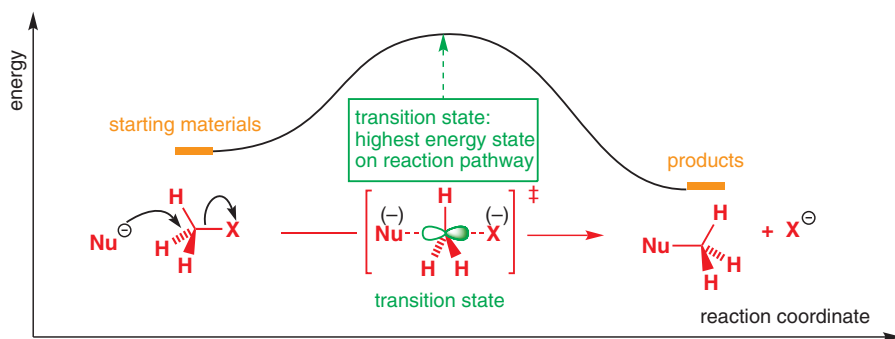

The dashed bonds in the transition state indicate partial bonds (the C–Nu bond is partly formed and the C–X bond partly broken) and the charges in brackets indicate substantial partial charges (about half a minus charge each in this case). Transition states are often shown in square brackets and marked with the symbol ‡.

Another way to look at this situation is to consider the orbitals. The nucleophile must have lone-pair electrons, which will interact with the σ* orbital of the C–X bond.

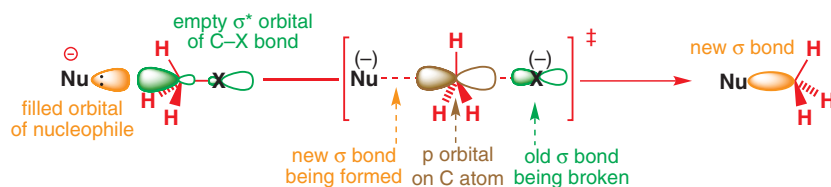

🖱 Interactive mechanism for simple S_N2

In the transition state the carbon atom in the middle has a p orbital that shares one pair of electrons between the old and the new bonds. Both these pictures suggest that the transition state for an S_N2 reaction has a more or less planar carbon atom at the centre with the nucleophile and the leaving group arranged at 180° to each other. This picture can help us explain two important observations concerning the S_N2 reaction—firstly the types of structures that react efficiently, and secondly the stereochemistry of the reaction.

Adjacent C=C or C=O π systems increase the rate of S_N2 reactions

We have already established that methyl and primary alkyl compounds react well by the S_N2 mechanism, while secondary alkyl compounds undergo S_N2 reactions only reluctantly. But there are other important structural features that also encourage the S_N2 mechanism. Two of these, allyl and benzyl groups, also encourage the S_N1 mechanism.

Allyl bromide reacts well with alkoxides to make ethers, and shown below is the typical S_N2 mechanism for this reaction. Also shown is the transition state for this reaction. Allyl compounds react rapidly by the S_N2 mechanism because the π system of the adjacent double bond can stabilize the transition state by conjugation. The p orbital at the reaction centre (shown in brown, and corresponding to the brown orbital in the diagram on p. 340) has to make two partial bonds with only two electrons—it is electron deficient, and so any additional electron density it can gather from an adjacent π system will stabilize the transition state and increase the rate of the reaction.

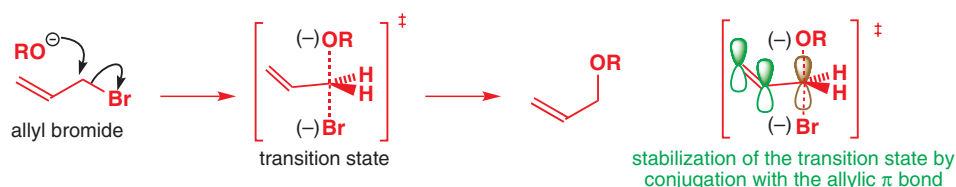

Interactive S_N2 mechanism at allylic and benzylic centres

The benzyl group acts in much the same way using the π system of the benzene ring for conjugation with the p orbital in the transition state. Benzyl bromide reacts very well with alkoxides to make benzyl ethers.

Among the fastest of all S_N2 reactions are those where the leaving group is adjacent to a carbonyl group. With α-bromo carbonyl compounds, two neighbouring carbon atoms are both powerfully electrophilic sites. Each has a low-energy empty orbital—π* from C=O and σ* from C–Br (this is what makes them electrophilic)—and these can combine to form a new LUMO (π* + σ*) lower in energy than either. Nucleophilic attack will occur easily where this new orbital has its largest coefficient, shown in orange on the diagram.

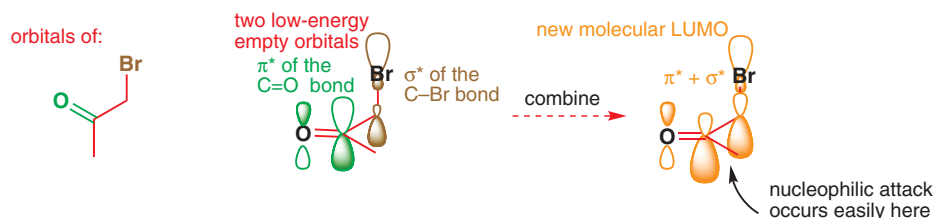
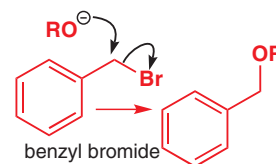

The effect of this interaction between antibonding orbitals is that each group becomes more electrophilic because of the presence of the other—the C=O group makes the C–Br bond more reactive and the Br makes the C=O group more reactive. In fact, it may well be that the nucleophile will attack the carbonyl group, but this will be reversible whereas displacement of bromide is irreversible.

There are many examples of this type of reaction. Reactions with amines go well and the aminoketone products are widely used in the synthesis of drugs.

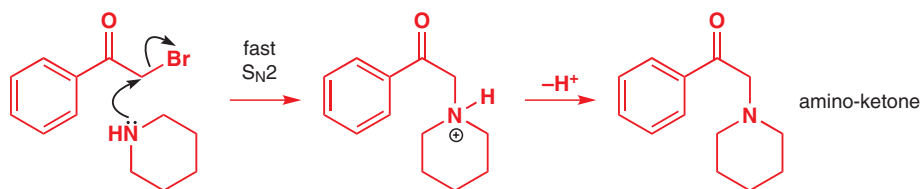

Quantifying structural effects on S_N2 reactions

Some actual data may help at this point. The rates of reaction of the following alkyl chlorides with KI in acetone at 50 °C broadly illustrate the patterns of S_N2 reactivity we have just analysed. These are relative rates with respect to *n*-BuCl as a 'typical primary halide'. You should not take too much notice of precise figures but rather observe the trends and notice that the variations are quite large—the full range from 0.02 to 100,000 is eight powers of ten.

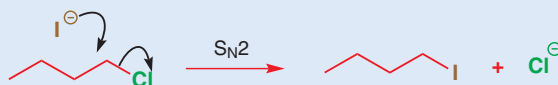

Relative rates of substitution reactions of alkyl chlorides with the iodide ion

Alkyl chloride	Relative rate	Comments
	200	least hindered alkyl chloride
	0.02	secondary alkyl chloride; slow because of steric hindrance
	79	allyl chloride accelerated by π conjugation in transition state
	200	benzyl chloride a bit more reactive than allyl: benzene ring slightly better at π conjugation than isolated double bond
	920	conjugation with oxygen lone pair accelerates reaction (this is an S_N1 reaction)
	100,000	conjugation with carbonyl group much more effective than with simple alkene or benzene ring; these α -halo carbonyl compounds are the most reactive of all

Contrasts between S_N1 and S_N2

You have now met the key features of both important mechanisms for substitution. You should at this stage in the chapter have a grasp of the kinetics, the nature of the intermediates and transition states, and the simple steric and electronic factors that control reactivity in S_N1 and S_N2 reaction pathways.

We are now going to look in more detail at some other aspects where there are significant contrasts between the mechanisms, either because they lead to different outcomes or because they lead to a change in reactivity towards one or the other of the two pathways.

A closer look at steric effects

We have already pointed out that having more alkyl substituents at the reaction centre makes a compound more likely to react by S_N1 than by S_N2 for two reasons: firstly they make a carbocation more stable, so favouring S_N1 , and secondly they make it hard for a nucleophile to get close to the reaction centre in the rate-determining step, disfavouring S_N2 . Let's look in more detail at the transition state for the slow steps of the two reactions and see how steric hindrance affects both.

In the approach to the S_N2 transition state, the carbon atom under attack gathers in another substituent and becomes (transiently) five-coordinate. The angles between the substituents decrease from tetrahedral to about 90°.

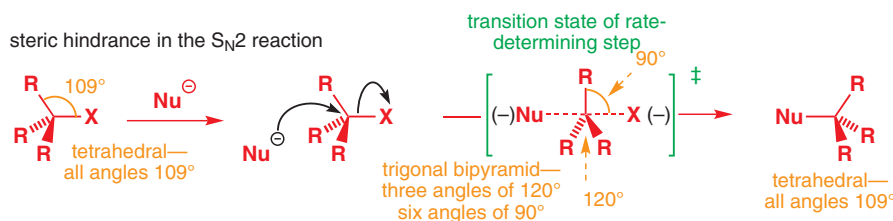

In the starting material there are four angles of about 109°. In the transition state (enclosed in square brackets and marked ‡ as usual) there are three angles of 120° and six angles of 90°, a significant increase in crowding. The larger the substituents R, the more serious this is, and the greater the increase in energy of the transition state. We can easily see the effects of steric hindrance if we compare these three structural types:

- methyl: CH₃–X: very fast S_N2 reaction
- primary alkyl: RCH₂–X: fast S_N2 reaction
- secondary alkyl: R₂CH–X: slow S_N2 reaction.

The opposite is true of the S_N1 reaction. The rate-determining step is simply the loss of the leaving group, and the transition state for this step will look something like the structure shown below—with a longer, weaker, and more polarized C–X bond than the starting material. The starting material is again tetrahedral (four angles of about 109°) and in the intermediate cation there are just three angles of 120°—fewer and less serious interactions. The transition state will be on the way towards the cation, and because the R groups are further apart in the transition state than in the starting material, large R groups will actually *decrease* the energy of the transition state relative to the starting material. S_N1 reactions are therefore accelerated by alkyl substituents both for this reason and because they stabilize the cation.

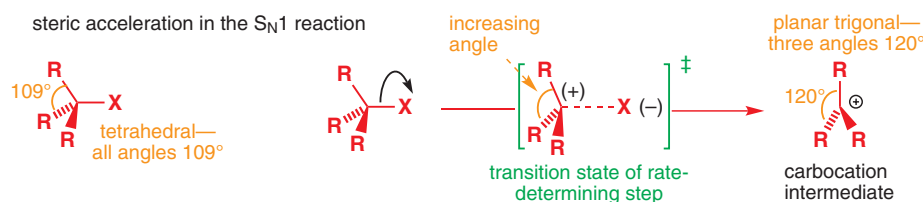

Stereochemistry and substitution

Look back at the scheme we showed you for the S_N2 reaction on p. 340. It shows the nucleophile attacking the carbon atom on the opposite side from the leaving group. Look carefully at the carbon atom it is attacking and you see that its substituents end up turning inside out as the reaction goes along, just like an umbrella in a high wind. If the carbon atom under attack is a stereogenic centre (Chapter 14), the result will be inversion of configuration. Something very different happens in the S_N1 reaction, and we will now illustrate the difference with a simple sequence of reactions.

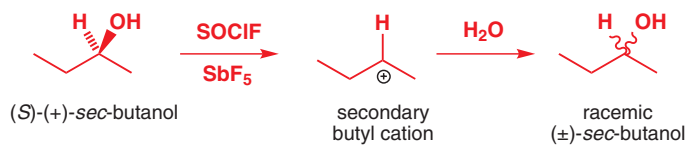

Starting with the optically active secondary alcohol *sec*-butanol (or butan-2-ol, but we want to emphasize that it is *secondary*), the secondary cation can be made by the method described on p. 338. Quenching this cation with water regenerates the alcohol but without any optical

You may hear it said that *tert*-alkyl compounds do not react by the S_N2 mechanism because the steric hindrance would be too great. In fact *t*-alkyl compounds react so fast by the S_N1 mechanism that the S_N2 mechanism wouldn't get a chance *even if it went as fast as it goes with methyl compounds*. You can see the figures that show this in the box on p. 338. Some tertiary alkyl compounds will react by slow S_N2 if, for example, S_N1 is prevented by an adjacent electron-withdrawing carbonyl group.

Likewise, primary alkyl halides that experience steric hindrance for other reasons react neither by S_N1 (because they are primary) nor S_N2 (because they are hindered)—a notorious example is the unreactivity of 'neopentyl halides'.

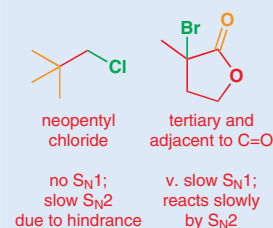

Notice how the transition state for the S_N1 reaction is really very close in structure to the carbocation, and you can see that they also lie very close to one another in the energy profile diagram on p. 334. When we say that the rate of an S_N1 reaction is increased by stabilization of the carbocation, what we really mean of course is that the rate is increased by stabilization of the transition state leading to the carbocation. However, they are so similar in structure that you can assume that steric and electronic effects on the carbocation will be very similar to those on the carbocation.

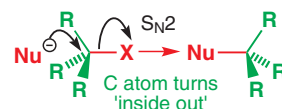

activity. Water must attack the two faces of the planar cation with exactly equal probability: the product is an exactly 50:50 mixture of (*S*)-butanol and (*R*)-butanol. It is *racemic*.

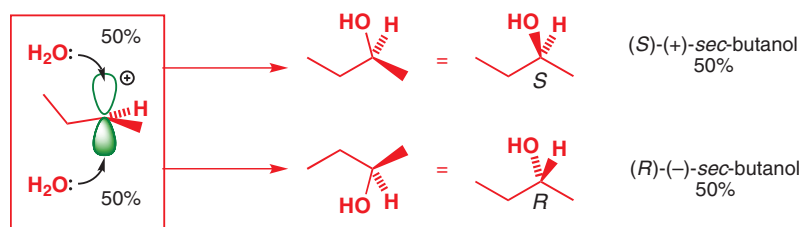

Alternatively, we can first make the hydroxyl group into a good enough leaving group to take part in an S_N2 reaction. The leaving group we shall use, a sulfonate ester, will be introduced to you in a few pages' time, but for now you just need to accept that nucleophilic attack of the OH group on a sulfonyl chloride in pyridine solution gives the sulfonate ester shown below in orange: no bonds have been formed or broken at the chiral carbon atom, which still has (*S*) stereochemistry.

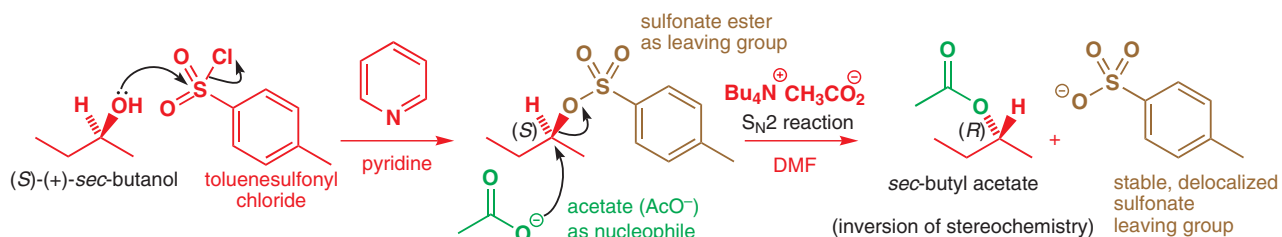

Now we can carry out an S_N2 reaction on the sulfonate with an acetate anion. A tetra-alkyl ammonium salt is used in the solvent DMF to avoid solvating the acetate, making it as powerful a nucleophile as possible and getting a clean S_N2 reaction. This is the key step and we don't want any doubt about the outcome. The sulfonate is an excellent leaving group—the charge is delocalized across all three oxygen atoms.

The product *sec*-butyl acetate is optically active and we can measure its optical rotation. But this tells us nothing. Unless we know the true rotation for pure *sec*-butyl acetate, we don't yet know whether it is optically pure nor even whether it really is inverted. We expect it to have (*R*) stereochemistry, but we can easily find out for sure. All we have to do is to hydrolyse the ester and get the original alcohol back again. We know the true rotation of the alcohol—it was our starting material—and we know that ester hydrolysis (Chapter 10) proceeds by attack at the carbonyl carbon—it can't affect the stereochemistry of the chiral centre.

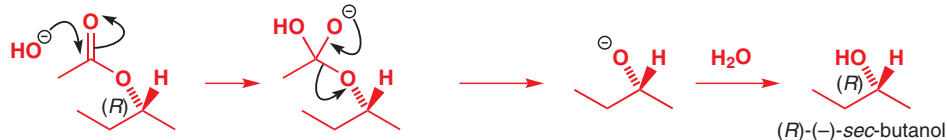

Now we really know where we are. This new sample of *sec*-butanol has the same rotation as the original sample, *but with the opposite sign*. It is (-)-(*R*)-*sec*-butanol. It is optically pure and inverted. Somewhere in this sequence there has been an inversion, and we know it wasn't in the formation of the sulfonate or the hydrolysis of the acetate as no bonds are formed or broken at the stereogenic centre in these steps. It must have been in the S_N2 reaction itself.

- An S_N2 reaction goes with inversion of configuration at the carbon atom under attack but an S_N1 reaction generally goes with racemization.

The effect of solvent

Why was the S_N2 reaction we have just shown you carried out in DMF? You will generally find S_N2 reactions are carried out in aprotic, and often less polar, solvents. S_N1 reactions are

➔ Optical rotation is described on p. 309.

➔ The different types of solvents were discussed in Chapter 12.

typically carried out in polar, protic solvents. A common solvent for an S_N2 reaction is acetone—just polar enough to dissolve the ionic reagents, but not as polar as, say, acetic acid, a common solvent for the S_N1 reaction.

It is fairly obvious why the S_N1 reaction needs a polar solvent: the rate-determining step involves the formation of ions (usually a negatively charged leaving group and a positively charged carbocation) and the rate of this process will be increased by a polar solvent that can solvate these ions. More precisely, the transition state is more polar than the starting materials (note the charges in brackets in the scheme above) and so is stabilized by the polar solvent. Hence solvents like water or carboxylic acids (RCO₂H) are ideal.

It is less obvious why a less polar solvent is better for the S_N2 reaction. The most common S_N2 reactions use an anion as the nucleophile. The transition state is then less polar than the localized anion as the charge is spread between two atoms. Here's an example: the formation of an alkyl iodide from an alkyl bromide. Acetone fails to solvate the iodide well, making it more reactive; the transition state is less in need of solvation, so overall the reaction is faster.

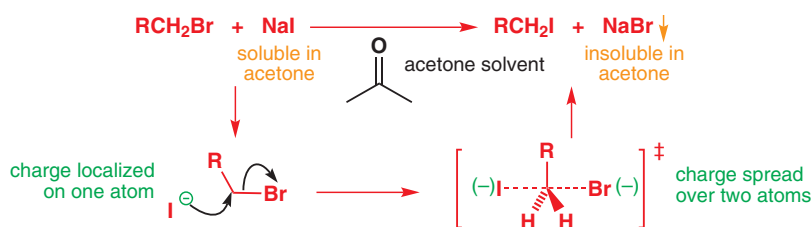

■ Acetone also assists this reaction because it dissolves sodium iodide but not the sodium bromide product, which precipitates from solution and prevents bromide acting as a competing nucleophile.

DMF and DMSO, the polar aprotic solvents we discussed in Chapter 12 (p. 255) are also good solvents for S_N2 reactions because they dissolve ionic compounds well but fail to solvate anions well, making them more reactive. The choice of Bu₄N⁺—a large, non-coordinating cation—as the counterion for the reaction on p. 344 was also made with this in mind.

Quantifying the rates of S_N1 and S_N2 reactions

The data below illustrate the effect of structure on the rates of S_N1 and S_N2 reactions. The green curve on the graph shows the rates (k_1) of an S_N1 reaction: the conversion of alkyl bromides to alkyl formate esters in formic acid at 100 °C. Formic acid is a polar solvent and a weak nucleophile: perfect for an S_N1 reaction. The red curve shows the rates of displacement of Br⁻ by radioactive ⁸²Br⁻ in acetone at 25 °C. Acetone solvent and the good nucleophile Br⁻ favour S_N2. The rates (k_2) are multiplied by 10⁵ to bring both curves onto the same graph.

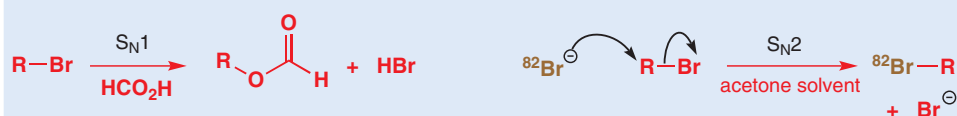

Both curves are plotted on a log scale, the log₁₀ of the actual rate being used on the y-axis. The x-axis has no real significance; it just shows the four points corresponding to the four basic structures: MeBr, EtBr, *i*-PrBr, and *t*-BuBr.

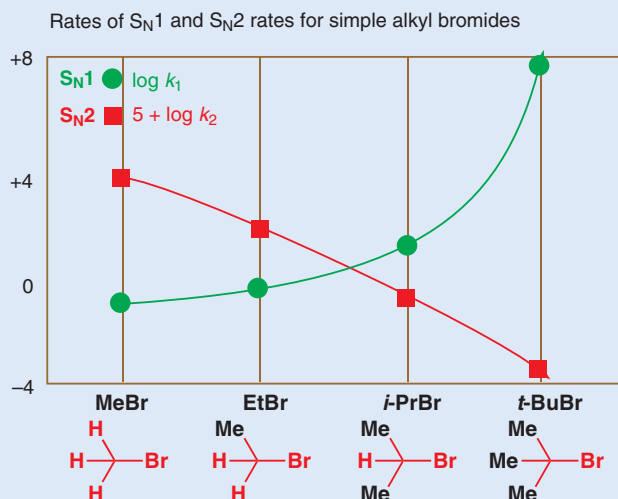

The values are also summarized in the table below, which gives the relative rates compared with that of the secondary halide, *i*-PrBr, set at 1.0 for each reaction.

Rates of S_N1 and S_N2 reactions of simple alkyl bromides

alkyl bromide type	CH ₃ Br methyl	CH ₃ CH ₂ Br primary	(CH ₃) ₂ CHBr secondary	(CH ₃) ₃ CBr tertiary
k_1 (s ⁻¹)	0.6	1.0	26	10 ⁸
$10^5 k_2$ (M ⁻¹ dm ⁻³ s ⁻¹)	13,000	170	6	0.0003
relative k_1	2×10^{-2}	4×10^{-2}	1	4×10^6
relative k_2	6×10^3	30	1	5×10^{-5}

Although the reactions were chosen to give as much S_N1 reaction as possible in one case and as much S_N2 reaction as possible in the other, of course you will understand that we cannot prevent the molecules doing the 'wrong' reaction! The values for the ' S_N1 ' reaction of MeBr and MeCH₂Br are actually the low rates of S_N2 displacement of the bromide ion by the weak nucleophile HCO₂H, while the ' S_N2 ' rate for *t*-BuBr may be the very small rate of ionization of *t*-BuBr in acetone.

A closer look at electronic effects

We mentioned above that adjacent π systems increase the rate of the S_N2 reaction by stabilizing the transition state, and likewise increase the rate of S_N1 reactions by stabilizing the carbocation. The effect on the S_N2 reaction applies to both C=C (electron-rich) and C=O (electron-deficient) π systems, but only C=C π systems increase the rate of S_N1 reactions. Adjacent C=O groups in fact significantly decrease the reactivity of alkyl halides towards S_N1 reactions because the electron-withdrawing effect of the carbonyl group greatly destabilizes the carbocation.

Electron-withdrawing or -donating groups can also tip finely balanced cases from one mechanism to another. For example, benzylic compounds react well by either S_N1 or S_N2 , and a change of solvent, as just discussed, might switch them from one mechanism to another. Alternatively, a benzylic compound that has a well-placed electron-donating group able to stabilize the cation will also favour the S_N1 mechanism. Thus 4-methoxybenzyl chloride reacts by S_N1 for this reason: here we show the methoxy group stabilizing the cation intermediate by assisting departure of the chloride.

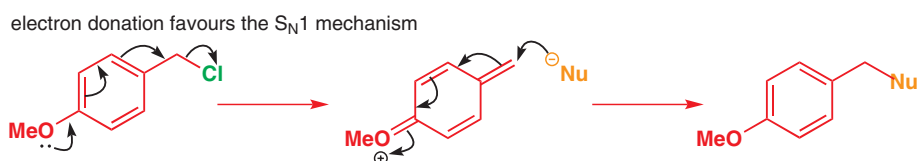

On the other hand, an electron-withdrawing group, such as a nitro group, within the benzylic compound will decrease the rate of the S_N1 reaction and allow the S_N2 mechanism to take over.

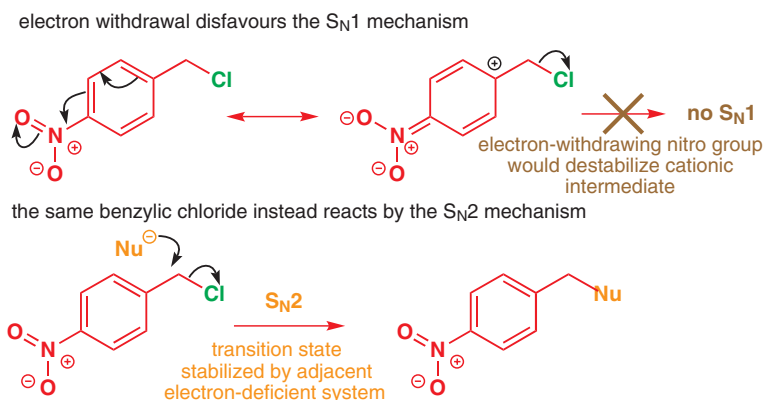

Rate measurements for benzylic chlorides illustrate the importance of this effect. We can force them all to react by S_N1 by using methanol as the solvent (methanol is a poor nucleophile and a polar solvent: both disfavour S_N2). Comparing with the rate of substitution of benzyl chloride itself, PhCH₂Cl, 4-methoxybenzyl chloride reacts with methanol about 2500 times faster and the 4-nitrobenzyl chloride about 3000 times more slowly.

● Summary of structural variations and nucleophilic substitution

We are now in a position to summarize the structural effects on both mechanisms we have been discussing over the last few pages. The table lists the structural types and rates each reaction qualitatively.

Electrophile	Me-X				
	methyl	primary	secondary	tertiary	'neopentyl'
S _N 1 mechanism?	bad	bad	poor	excellent	bad
S _N 2 mechanism?	excellent	good	poor	bad	bad
Electrophile					
	allylic	benzylic	α-alkoxy (adj. lone pair)	α-carbonyl	α-carbonyl and tertiary
S _N 1 mechanism?	good	good	good	bad	bad
S _N 2 mechanism?	good	good	okay but S _N 1 better	excellent	possible

We have considered the important effects of the basic carbon skeleton and of solvent on the course of S_N1 and S_N2 reactions and we shall now look at two final structural factors: the nucleophile and the leaving group. We shall tackle the leaving group first because it plays an important role in both S_N1 and S_N2 reactions.

The leaving group in S_N1 and S_N2 reactions

The leaving group is important in both S_N1 and S_N2 reactions because departure of the leaving group is involved in the rate-determining step of both mechanisms.

The leaving group in the S_N1 reaction

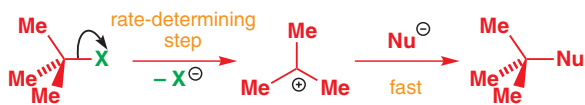

The leaving group in the S_N2 reaction

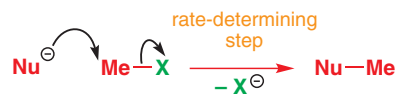

So far you have mostly seen halides and water (from protonated alcohols) as leaving groups. Leaving groups involving halides or oxygen atoms are by far the most important, and now we need to establish the principles that make for good and bad leaving groups. As a chemist, we want leaving groups to have some staying power, so that our compounds are not too unstable, but we also don't want them to outstay their welcome—they must have just the right level of reactivity.

Halides as leaving groups

With halide leaving groups two main factors are at work: the strength of the C–halide bond and the stability of the halide ion. The strengths of the C–X bonds can be measured easily, but how can we measure anion stability? One way, which you met in Chapter 8, was to use the pK_a values of the acids HX. pK_a quantifies the stability of an anion relative to its conjugate acid. We want to know about the stability of an anion relative to that anion bonded to C, not H, but pK_a will do as a guide.

Halide leaving groups in the S_N1 and S_N2 reactions

Halide (X)	Strength of C–X bond, kJ mol ⁻¹	pK _a of HX
fluorine	118	+3
chlorine	81	-7
bromine	67	-9
iodine	54	-10

■ You were given the same message in Chapter 10 in relation to substitutions at C=O: hydroxide is never a leaving group. There is one exception to this rule, in the E1cb reaction, which you will meet in Chapter 17, but it's rare enough to ignore at this stage.

The table in the margin shows both bond strengths and pK_a. It is clearly easiest to break a C–I bond and most difficult to break a C–F bond. Iodide sounds like the best leaving group. We get the same message from the pK_a values: HI is the strongest acid, so it must ionize easily to H⁺ and I⁻. This result is quite correct—iodide is an excellent leaving group and fluoride a very bad one, with the other halogens in between.

Nucleophilic substitutions on alcohols: how to get an OH group to leave

Now what about leaving groups joined to the carbon atom by a C–O bond? There are many of these but the most important are OH itself, the carboxylic esters, and the sulfonate esters. First we must make one thing clear: alcohols themselves do *not* react with nucleophiles. In other words, OH⁻ is never a leaving group. Why not? For a start hydroxide ion is very basic, and if the nucleophile were strong enough to displace hydroxide ion it would be more than strong enough to remove the proton from the alcohol.

S_N2 displacement of hydroxide never happens...



If the nucleophile reacts, it attacks the *proton* instead



But we do want to use alcohols in nucleophilic substitution reactions because they are easily made (by the reactions in Chapter 9, for example). The simplest solution is to protonate the OH group with strong acid. This will work only if the nucleophile is compatible with strong acid, but many are. The preparation of *t*-BuCl from *t*-BuOH simply by shaking it with concentrated HCl is a good example. This is obviously an S_N1 reaction with the *t*-butyl cation as intermediate.

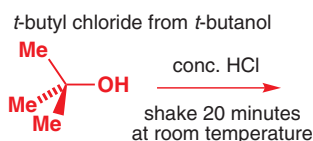

the mechanism

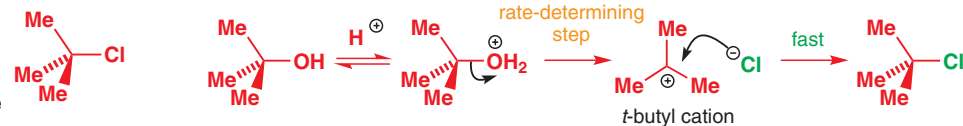

Similar methods can be used to make secondary alkyl bromides with HBr alone and primary alkyl bromides using a mixture of HBr and H₂SO₄.

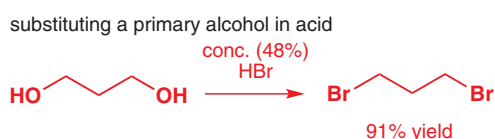
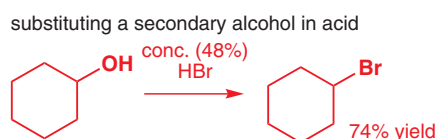

The second of these two reactions must be S_N2 , with substitution of the protonated hydroxyl group by bromide.

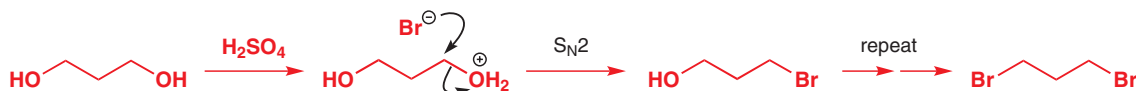

Another way to approach the substitution of OH is to make it a better leaving group by combination with an element that forms very strong bonds to oxygen. The most popular choices are phosphorus and sulfur. Making primary alkyl bromides with PBr₃ usually works well.

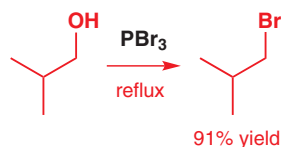

The phosphorus reagent is first attacked by the OH group (an S_N2 reaction at phosphorus) and the displacement of an oxyanion bonded to phosphorus is now a good reaction because of the anion stabilization by phosphorus.

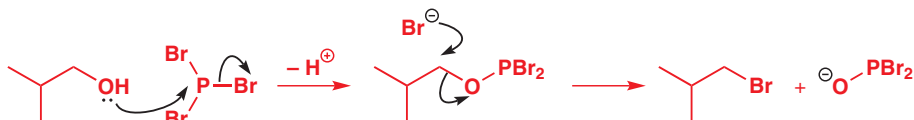

Sulfonate esters—tosylates and mesylates—from alcohols

The most widely used way of making a hydroxyl group into a good leaving group is to make it into a sulfonate ester. Primary and secondary alcohols are easily converted to sulfonate esters by treating with sulfonyl chlorides and base. The sulfonate esters are often crystalline, and are so widely used that they have been given trivial names—*tosylates* for *p*-toluenesulfonates and *mesylates* for methanesulfonates—and the functional groups have been allocated the ‘organic element’ symbols Ts and Ms.

Tosylates (*p*-toluenesulfonates) are made by treating alcohols with *p*-toluenesulfonyl chloride (or tosyl chloride) in the presence of pyridine. A similar reaction (but with a different mechanism, which we will discuss in Chapter 17) with methanesulfonyl chloride (mesyl chloride) gives a mesylate (methanesulfonate).

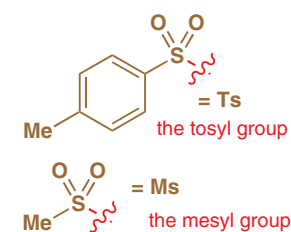
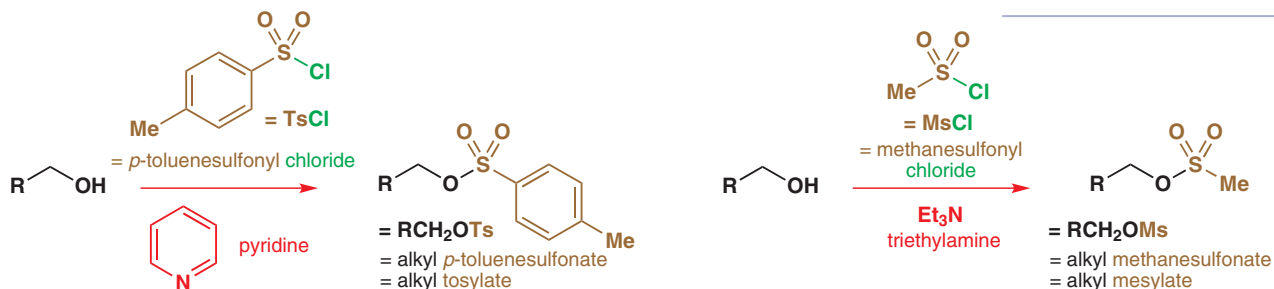

➔ The mechanism by which sulfonate esters are formed is discussed in more detail in Chapter 17.

Sulfonic acids RSO_3H are strong acids ($\text{p}K_a$ around 0) and so any sulfonate RSO_3^- is a good leaving group: tosylates and mesylates can be displaced by almost anything. As you saw in Chapter 8, the lithium derivative of an alkyne can be prepared by deprotonation with the very strong base butyllithium. In the example below, the tosyl derivative of a primary alcohol reacts with this lithium derivative in an S_N2 reaction. Note that the tosylate leaving group is represented as TsO^- (not Ts^- !).

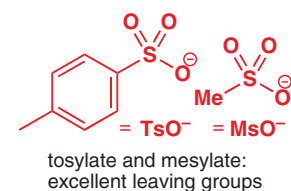
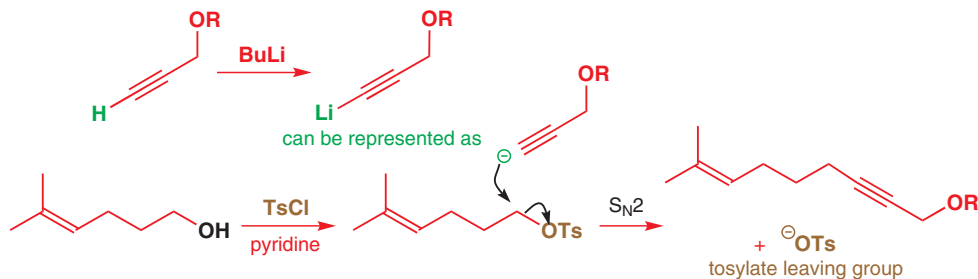

On p. 344 you saw a tosylate (we just called it a sulfonate ester then) being displaced by acetate in an S_N2 reaction. Acetate is not a very good nucleophile, and it is a testament to the power of the sulfonate esters that they are willing to act as leaving groups even with acetate, which is usually too weak to react by S_N2.

Substituting alcohols with the Mitsunobu reaction

Rather than use two steps to convert the OH group first to a sulfonate ester, and then displace it, it is possible to use a method that allows us to put an alcohol straight into a reaction mixture and get an S_N2 product in one operation. This is the Mitsunobu reaction. In this reaction, the alcohol becomes the electrophile, the nucleophile is usually relatively weak (the conjugate base of a carboxylic acid, for example), and there are two other reagents.

a Mitsunobu reaction

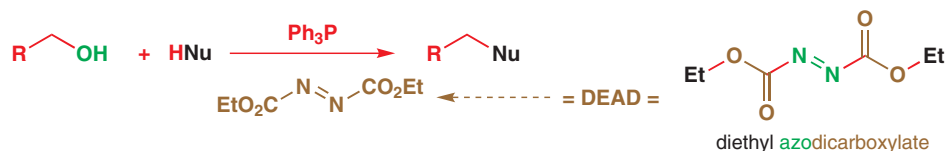

Oyo Mitsunobu (1934–2003) worked at the Aoyama Gakuin University in Tokyo. Western chemists often misspell his name: make sure you don't!

Azo compounds

The 'azo' in the name of DEAD refers to two nitrogen atoms joined together by a double bond and compounds such as azobenzene are well known. Many dyestuffs have an azo group in them—you saw some in Chapter 1. Diazo compounds, such as diazomethane, which we discuss in Chapter 38, also have two nitrogens, but only one is bonded to carbon.

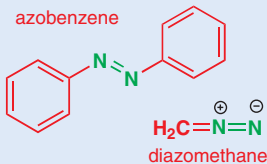

One of these reagents, Ph_3P , triphenylphosphine, is the simple phosphine you met in Chapter 11. Phosphines are nucleophilic, but not basic like amines. The other reagent deserves more comment. Its full name is diethyl azodicarboxylate, or DEAD.

So how does the Mitsunobu reaction work? It's a long mechanism, but don't be discouraged: there is a logic to each step and we will guide you through it gently. The first stage involves neither the alcohol nor the added nucleophile. The phosphine adds to the weak $\text{N}=\text{N}$ π bond to give an anion stabilized by one of the ester groups.

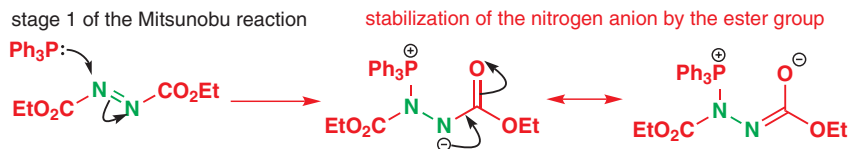

You will note that the nucleophile has been added as its conjugate acid 'HNu'—often this might be a carboxylic acid, for example benzoic acid. The anion produced by this first stage is basic enough to remove a proton from this acid, generating Nu^- ready for reaction.

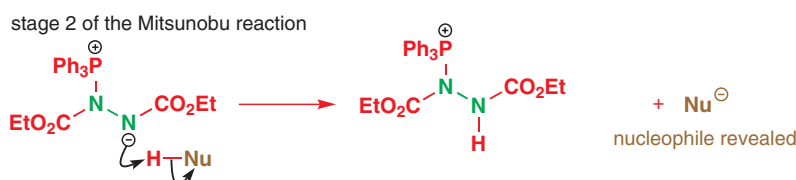

Oxygen and phosphorus have a strong affinity, as we saw in the conversion of alcohols to bromides with PBr_3 (p. 348) and in the Wittig reaction (Chapter 11, pp. 237–8), and the positively charged phosphorus is now attacked by the alcohol, displacing a second nitrogen anion in an $\text{S}_{\text{N}}2$ reaction at phosphorus. The nitrogen anion generated in this step is stabilized by conjugation with the ester, but rapidly removes the proton from the alcohol to give an electrophilic $\text{R}-\text{O}-\text{PPh}_3^+$ species and a by-product, the reduced form of DEAD.

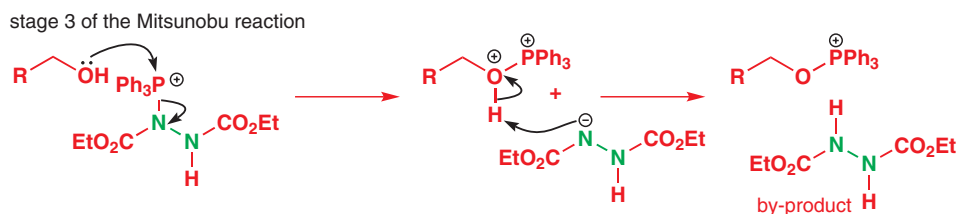

Finally, the anion of the nucleophile can now attack this phosphorus derivative of the alcohol in a normal $\text{S}_{\text{N}}2$ reaction at carbon with the phosphine oxide as the leaving group. We have arrived at the products.



 Interactive mechanism for the Mitsunobu reaction

The whole process takes place in one operation. The four reagents are all added to one flask and the products are the phosphine oxide, the reduced azo diester with two NH bonds replacing the $\text{N}=\text{N}$ double bond, and the product of an $\text{S}_{\text{N}}2$ reaction on the alcohol. Another way to look at this reaction is that a molecule of water must formally be lost: OH must be removed from the alcohol and H from the nucleophile. These atoms end up in very stable molecules—the $\text{P}=\text{O}$ and $\text{N}-\text{H}$ bonds are strong where the $\text{N}=\text{N}$ bond was weak, compensating for the sacrifice of the strong $\text{C}-\text{O}$ bond in the starting alcohol.

If this is all correct, then the vital $\text{S}_{\text{N}}2$ step should lead to inversion as it always does in $\text{S}_{\text{N}}2$ reactions. This turns out to be one of the great strengths of the Mitsunobu reaction—it is a

reliable way to replace OH by a nucleophile with inversion of configuration. The most dramatic example is probably the formation of esters from secondary alcohols with inversion. Normal ester formation leads to retention as the C–O bond of the alcohol is not broken: compare these two reactions and note the destination of the coloured oxygen (and hydrogen) atoms.

ester formation from a secondary alcohol with inversion by the Mitsunobu reaction

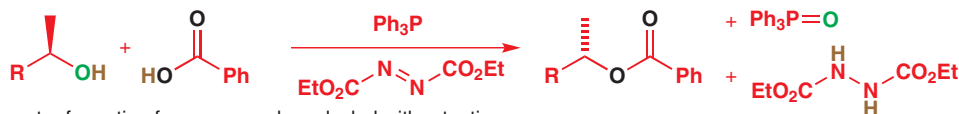

ester formation from a secondary alcohol with retention



Ethers as electrophiles

Ethers are stable molecules that do not react with nucleophiles: THF and Et₂O are widely used as solvents for this reason. To make them react, we need to make the oxygen positively charged so that it can accept electrons more readily, and we also need to use a very good nucleophile. A good way of doing both is to treat with HBr or HI, which protonate the oxygen. Iodide and bromide are excellent nucleophiles in S_N2 reactions (see below), and attack will occur preferentially at the carbon atom more susceptible to S_N2 reactions (usually the less hindered one). Aryl alkyl ethers cleave only on the alkyl side—you cannot get attack through the benzene ring.

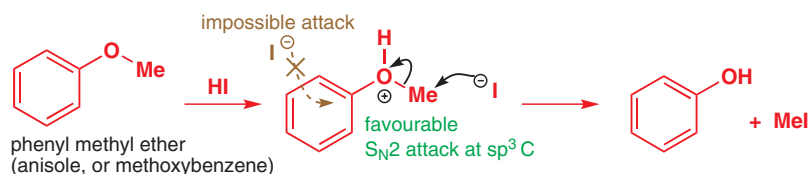

So far we have used only protic acids to help oxygen atoms to leave. But Lewis acids—species other than H⁺ that also have an empty orbital capable of accepting a lone pair—work well too, and the cleavage of aryl alkyl ethers with BBr₃ is a good example. Trivalent boron compounds have an empty p orbital so they are very electrophilic and prefer to attack oxygen. The resulting oxonium ion can be attacked by Br[−] in an S_N2 reaction.

BBr₃ acts as a Lewis acid—empty p orbital accepts a lone pair of electrons

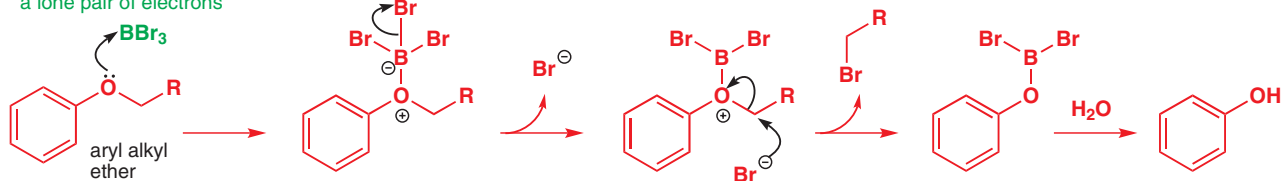

➔ Lewis acids were introduced in Chapter 8, p. 180.

Epoxides as electrophiles

One family of ethers reacts in nucleophilic substitution even without protic or Lewis acids. They are the three-membered cyclic ethers called epoxides (or oxiranes). The leaving group is genuinely an alkoxide anion RO[−], so obviously some special feature must be present in these ethers making them unstable. This feature is ring strain, which comes from the angle between the bonds in the three-membered ring that has to be 60° instead of the ideal tetrahedral angle of 109°. You could subtract these numbers and say that there is '49° of strain' at each carbon atom, making about 150° of strain in the molecule. This is a lot: the molecule would be much

➔ You will see how to make epoxides from alkenes in Chapter 19.

more stable if the strain were released by opening up to restore the ideal tetrahedral angle at all atoms. This can be done by one nucleophilic attack.

➔ Ring strain is discussed further in Chapter 16 on p. 368.

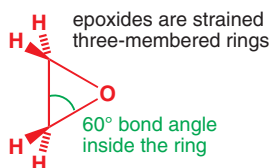

S_N2 attack on epoxides relieves ring strain



Epoxides react cleanly with amines to give amino alcohols. We have not so far featured amines as nucleophiles because their reactions with alkyl halides are often bedeviled by overreaction (see the next section), but with epoxides they give good results.

■ When epoxides are substituted differently at either end, the nucleophile has a choice of which end to attack. The factors that control this will be discussed in Chapter 24.

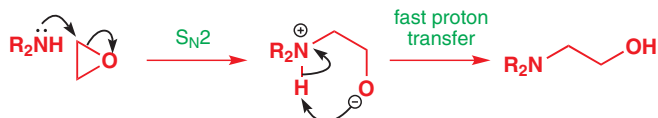

It is easy to see that inversion occurs in these S_N2 reactions when the epoxide is attached to (or 'fused with') another ring. With this five-membered ring nucleophilic attack with inversion gives the *trans* product. As the epoxide in the starting material is *up*, attack has to come from underneath. The new C–N bond is *down* and inversion has occurred.

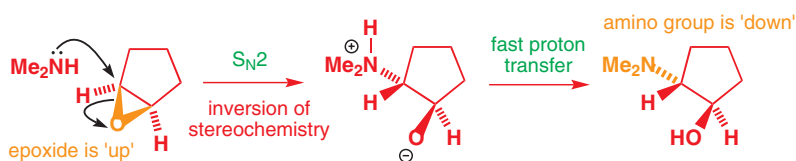

The nucleophile in S_N1 reactions

We established earlier that in an S_N1 reaction the nucleophile is not important with regard to *rate*. The rate-determining step of the reaction is loss of the leaving group, so good and bad nucleophiles all give products. We don't need to deprotonate the nucleophile to make it more reactive (water and hydroxide work just as well as each other) and this means that S_N1 reactions are often carried out under acidic conditions, to assist departure of a leaving group.

Compare, for example, these typical conditions used to make a methyl ether and a *tert*-butyl ether. The methyl ether is made, as you saw on p. 340, using methyl iodide in an S_N2 reaction. It needs a good nucleophile, so the alcohol is deprotonated to make an alkoxide with sodium hydride in DMF, which, as you saw on p. 345, is a good solvent for S_N2 reactions. The *tert*-butyl ether on the other hand is made simply by stirring the alcohol with *tert*-butanol and a little acid. No base is needed, and the reaction proceeds rapidly to give the *tert*-butyl ether.

making a methyl ether

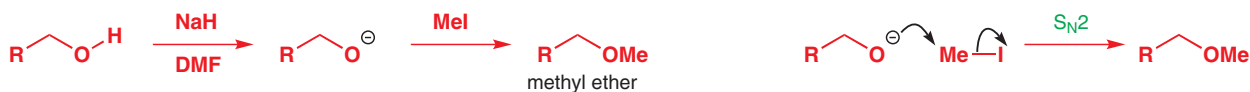

making a *tert*-butyl ether



A very bad nucleophile in a good S_N1 reaction: the Ritter reaction

An interesting result of the unimportance of the nucleophile to the rate (and therefore the usefulness) of an S_N1 reaction is that very poor nucleophiles indeed may react in the absence of anything better. Nitriles, for example, are very poorly basic and nucleophilic because the lone pair of electrons on the nitrogen atom is in a low-energy sp orbital. However, if *t*-butanol is dissolved in a nitrile as solvent and strong acid is added, a reaction does take place. The acid does not protonate the nitrile, but does protonate the alcohol to produce the *t*-butyl cation in the usual first step of an S_N1 reaction. This cation is reactive enough to combine with even such a weak nucleophile as the nitrile.

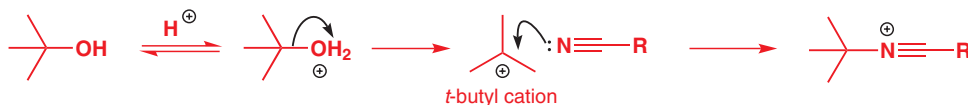

The resulting cation is captured by the water molecule released in the first step and an exchange of protons leads to a secondary amide. The overall process is called the Ritter reaction and it is one of the few reliable ways to make a C–N bond to a tertiary centre.

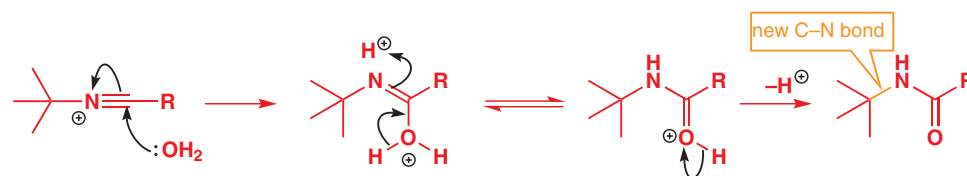

nitriles are very weak bases and poor nucleophiles



The nucleophile in the S_N2 reaction

In an S_N2 reaction, a good nucleophile is essential. We finish this chapter with a survey of effective choices for forming new bonds to sp³ by S_N2 reactions, and a description of the factors that determine how good a nucleophile will be.

Nitrogen nucleophiles: a problem and a solution

Amines are good nucleophiles, but reactions between ammonia and alkyl halides rarely lead cleanly to single products. The problem is that the product of the substitution is at least as nucleophilic as the starting material, so it competes for reaction with the alkyl halide.

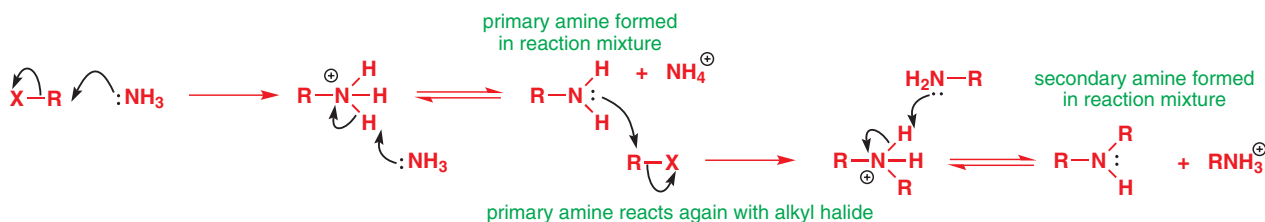

Even this is not all! The alkylation steps keep going, forming the secondary and tertiary amines, and stopping only when the non-nucleophilic tetra-alkylammonium ion R₄N⁺ is formed. The problem is that the extra alkyl groups push more and more electron density onto N, making each product more reactive than the previous. The quaternary ammonium salt could probably be made cleanly if a large excess of alkyl halide RX is used, but other more controlled methods are needed for the synthesis of primary, secondary, and tertiary amines.

One solution for primary amines is to replace ammonia with azide ion N₃⁻. This linear triatomic species, nucleophilic at both ends, is a slender rod of electrons able to insert itself into almost any electrophilic site. It is available as the water-soluble sodium salt NaN₃.

Sometimes these alkylations can work, but usually only if the alkylating agent or the amine is very hindered, or the alkylating agent contains an inductive electron-withdrawing group (such as the hydroxyl group generated when an epoxide is opened: epoxides are reliable alkylating agents for amines). With amine alkylations, you should nonetheless always expect the worst.

structure of azide ion N_3^-

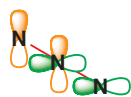

■ Azide is isoelectronic with carbon dioxide, and has the same linear shape.

Azide reacts only once with alkyl halides because the product, an alkyl azide, is no longer nucleophilic. However, rarely is the azide product required: it is usually reduced to a primary amine by catalytic hydrogenation (H_2 over a Pd catalyst—see Chapter 23), LiAlH_4 , or triphenylphosphine.

A warning about azides

Azides can be converted by heat—or even sometimes just by a sharp blow—suddenly into nitrogen gas. In other words they are potentially explosive, particularly inorganic (that is, ionic) azides and low molecular weight covalent organic azides.



Azides react with epoxides too. This epoxide is one diastereoisomer (*trans*) but racemic and the symbol (\pm) under each structure reminds you of this (Chapter 14). Azide attacks at either end of the three-membered ring (the two ends are the same) to give the hydroxy-azide. The reaction is carried out in a mixture of water and an organic solvent with ammonium chloride as buffer to provide a proton for the intermediate. Triphenylphosphine in water is used for reduction to the primary amine.

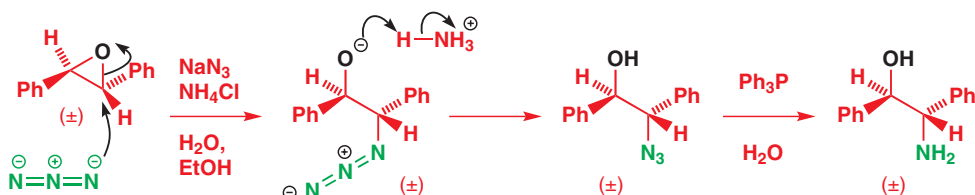

➔ The mechanism of the reduction of azides by triphenylphosphine can be found on p. 1176.

Sulfur nucleophiles are better than oxygen nucleophiles in $\text{S}_{\text{N}}2$ reactions

Thiolate anions RS^- make excellent nucleophiles in $\text{S}_{\text{N}}2$ reactions on alkyl halides. It is enough to combine the thiol, sodium hydroxide, and the alkyl halide to get a good yield of the sulfide.



Thiols are more acidic than water ($\text{p}K_{\text{a}}$ of RSH is typically 9–10, $\text{p}K_{\text{a}}$ of PhSH is 6.4, $\text{p}K_{\text{a}}$ of H_2O is 15.7) and rapid proton transfer from sulfur to oxygen gives the thiolate anion that acts as a nucleophile in the $\text{S}_{\text{N}}2$ reaction.

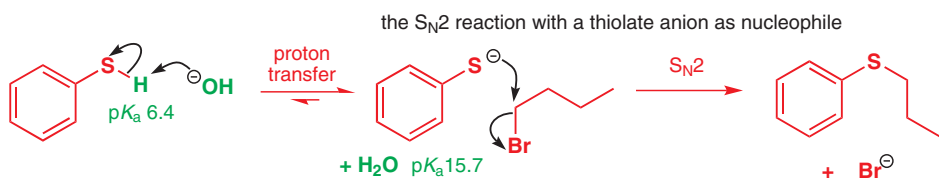

But how do you make a thiol in the first place? The obvious way to make aliphatic thiols would be by an $\text{S}_{\text{N}}2$ reaction using NaSH on the alkyl halide.

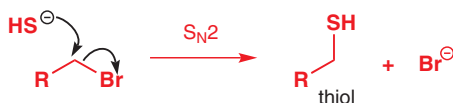

This works well but, unfortunately, the product easily exchanges a proton and the reaction normally produces the symmetrical sulfide—this should remind you of what happened with amines!

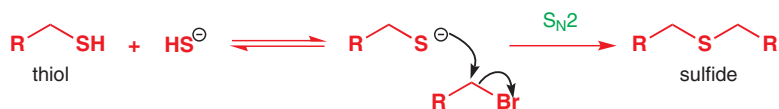

The solution is to use the anion of thioacetic acid, usually the potassium salt. This reacts cleanly through the more nucleophilic sulfur atom and the resulting ester can be hydrolysed in base to liberate the thiol.

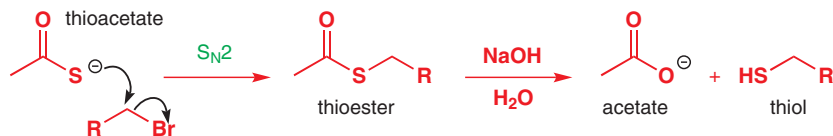

Effectiveness of different nucleophiles in the S_N2 reaction

In Chapter 10 we pointed out that basicity is nucleophilicity towards protons. At that stage we said that nucleophilicity towards the carbonyl group parallels basicity almost exactly. We are able to use pK_a as a guide to the effectiveness of nucleophilic substitution reactions **at the carbonyl group**.

During this chapter you have had various hints that nucleophilicity towards saturated carbon is not so straightforward. Now we must look at this question seriously and try to give you helpful guidelines.

1. If the atom that is forming the new bond to carbon is the same over a range of nucleophiles—it might be oxygen, for example, and the nucleophiles might be HO^- , PhO^- , AcO^- , and TsO^- —then nucleophilicity does parallel basicity. The anions of the weakest acids are the best nucleophiles. The order for the nucleophiles we have just mentioned will be: $\text{HO}^- > \text{PhO}^- > \text{AcO}^- > \text{TsO}^-$. The actual values for the rates of attack of the various nucleophiles on MeBr in EtOH relative to the rate of reaction with water (= 1) are given in the table below.

Relative rates (water = 1) of reaction with MeBr in EtOH

Nucleophile X ⁻	pK _a of HX	Relative rate
HO ⁻	15.7	1.2 × 10 ⁴
PhO ⁻	10.0	2.0 × 10 ³
AcO ⁻	4.8	9 × 10 ²
H ₂ O	-1.7	1.0
ClO ₄ ⁻	-10	0

2. If the atoms that are forming the new bond to carbon are *not* the same over the range of nucleophiles we are considering, then another factor is important. In the very last examples we have been discussing we have emphasized that RS^- is an excellent nucleophile for saturated carbon. Let us put that another way: RS^- is a better nucleophile for saturated carbon than RO^- , even though RO^- is more basic than RS^- (see table below).

Relative rates (water = 1) of reaction with MeBr in EtOH

Nucleophile X ⁻	pK _a of HX	Relative rate
PhS ⁻	6.4	5.0 × 10 ⁷
PhO ⁻	10.0	2.0 × 10 ³

Sulfur is plainly a better nucleophile than oxygen for saturated carbon. Why should this be? As we discussed back in Chapter 5, there are two main factors controlling bimolecular reactions: (1) electrostatic attraction (simple attraction of opposite charges or partial charges) and (2) bonding interactions between the HOMO of the nucleophile and the LUMO of the electrophile.

pK_a of HNu is a good guide to the rate of this sort of reaction

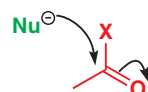

nucleophilic attack on C=O

but the story with this sort of reaction is more complicated

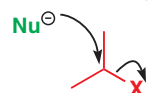

nucleophilic substitution at saturated C

A proton is, of course, positively charged, so electrostatic attraction is the more important factor in nucleophilicity towards H^+ , or pK_a . The carbonyl group too has a substantial positive charge on the carbon atom, arising from the uneven distribution of electrons in the $C=O$ π bond, and reactions of nucleophiles with carbonyl groups are also heavily influenced by electrostatic attraction, with HOMO–LUMO interactions playing a smaller role.

Electronegativities:

C: 2.55 I: 2.66 Br: 2.96 O: 3.44

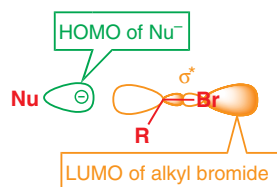

When it comes to saturated carbon atoms carrying leaving groups, polarization is typically much less important. There is, of course, some polarity in the bond between a saturated carbon atom and, say, a bromine atom, but the electronegativity difference between C and Br is less than half that between C and O. In alkyl iodides, one of the best classes of electrophiles in S_N2 reactions, there is in fact almost no dipole at all—the electronegativity of C is 2.55 and that of I is 2.66.

● Electrostatic attraction is often unimportant in S_N2 reactions.

What does matter is the strength of the HOMO–LUMO interaction. In a nucleophilic attack on the carbonyl group, the nucleophile adds in to the low-energy π^* orbital. In a nucleophilic attack on a saturated carbon atom, the nucleophile must donate its electrons to the σ^* orbital of the $C-X$ bond, as illustrated in the margin for an alkyl bromide reacting with the non-bonding lone pair of a nucleophile.

σ^* antibonding orbitals are, of course, higher in energy than non-bonding lone pairs, but the higher the energy of the nucleophile's lone pair, the better the overlap. The $3sp^3$ lone-pair electrons of sulfur overlap better with the high-energy σ^* orbital of the $C-X$ bond than do the lower energy $2sp^3$ lone-pair electrons on oxygen because the higher energy of the sulfur electrons brings them closer in energy to the $C-X$ σ^* orbital. The conclusion is that nucleophiles from lower down the periodic table are more effective in S_N2 reactions than those from the top rows.

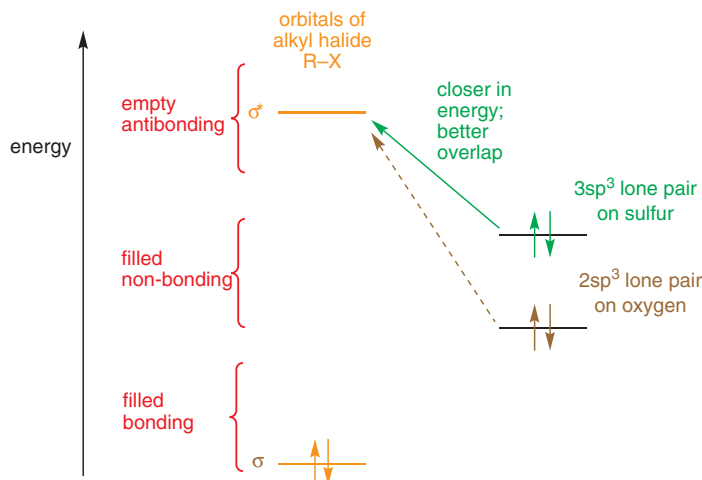

● Typically, nucleophilic power towards saturated carbon goes like this:

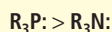
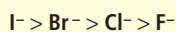

Nucleophiles in substitution reactions

Relative rates (water = 1) of reaction of nucleophiles with MeBr in EtOH

nucleophile	F^-	H_2O	Cl^-	Et_3N	Br^-	PhO^-	EtO^-	I^-	PhS^-
relative rate	0.0	1.0	1100	1400	5000	2.0×10^3	6×10^4	1.2×10^5	5.0×10^7

Hard and soft nucleophiles

The fact that some nucleophiles, like $R_3P:$ and RS^- , react very fast at saturated C atoms (they have high-energy lone pairs), but very poorly at C=O groups (they are either uncharged or have charge spread diffusely over large orbitals) gives them a different type of character from strongly basic nucleophiles like HO^- that attack C=O groups rapidly. We call nucleophiles that react well at saturated carbon **soft** nucleophiles; those that are more basic and react well with carbonyl groups are referred to as **hard** nucleophiles. These are useful and evocative terms because the soft nucleophiles are indeed rather large and flabby with diffuse high-energy electrons while the hard nucleophiles are small and spiky with closely held electrons and high charge density.

When we say 'hard' (nucleophile or electrophile) we refer to species whose reactions are dominated by electrostatic attraction and when we say 'soft' (nucleophile or electrophile) we refer to species whose reactions are dominated by HOMO–LUMO interactions.

■ Just to remind you: reactions dominated by electrostatic attraction also need to pass electrons from HOMO to LUMO, but reactions that are dominated by HOMO–LUMO interactions need have no contribution from electrostatic attraction.

● Summary of the characteristics of the two types of nucleophile.

Hard nucleophiles X	Soft nucleophiles Y
small	large
charged	neutral
basic (HX weak acid)	not basic (HY strong acid)
low-energy HOMO	high-energy HOMO
like to attack C=O	like to attack saturated carbon
such as RO^- , NH_2^- , MeLi	such as RS^- , I^- , R_3P

Nucleophiles and leaving groups compared

In Chapter 10 we explained that, in a nucleophilic attack on the carbonyl group, a good nucleophile is a bad leaving group and vice versa. We set you the challenge of predicting which way the following reaction would go.

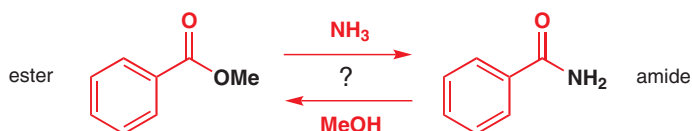

You should by now understand well that the reaction goes from ester to amide rather than the other way round, because NH_3 is a better nucleophile than $MeOH$ and NH_2^- is a worse leaving group than MeO^- .

The S_N2 reaction is different: some of the best nucleophiles are also the best leaving groups. The most important examples of this are bromide and iodide. As the table on p. 356 showed, iodide ion is one of the best nucleophiles towards saturated carbon because it is at the bottom of its group in the periodic table and its lone-pair electrons are very high in energy. Alkyl iodides are readily formed from alkyl chlorides or tosylates. Here are two examples. The first is assisted by the solvent, acetone, which allows $NaCl$ to precipitate and drives the reaction forward.

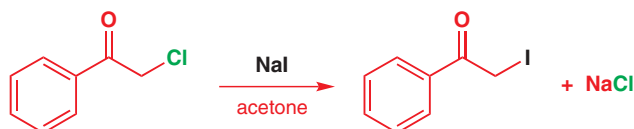

The second example is from the preparation of a phosphonium salt used in a synthesis of terpenes. An unsaturated primary alcohol was first made into its tosylate, the tosylate was converted into the iodide, and the iodide into the phosphonium salt.

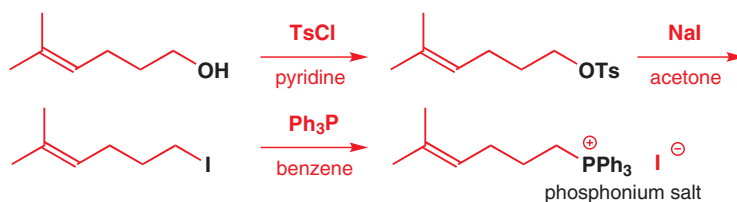

■ We explained on p. 347 why I^- is such a good leaving group: the C–I bond is particularly weak. The poor overlap between the atomic orbitals on C and on I also mean that the σ^* is low lying and easily accessible to the nucleophile's HOMO.

The solvent 'xylene' needs some explanation. Xylene is the trivial name for dimethyl benzene and there are three isomers. Mixed xylenes are isolated cheaply from oil and often used as a relatively high boiling solvent (b.p. about 140 °C) for reactions at high temperature. In this case, the starting materials are soluble in xylene but the product is a salt and conveniently precipitates out during the reaction. Non-polar xylene favours the S_N2 reaction (p. 345).

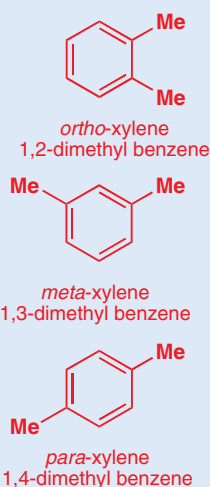

A nucleophilic catalyst speeds up a reaction by acting as both a good nucleophile and a good leaving group. You saw pyridine performing a similar function in substitution reactions at the C=O group of acid anhydrides in Chapter 10.

But why this roundabout route via the iodide? The answer is that as well as being an excellent nucleophile, iodide is such a good leaving group that alkyl iodides are often used as intermediates to encourage substitution with other nucleophiles. Yields are often higher if the alkyl iodide is prepared than if the eventual nucleophile is reacted directly with the alkyl tosylate or chloride.

However, iodine is expensive, and a way round that problem is to use a catalytic amount of iodide. The phosphonium salt below is formed slowly from benzyl bromide but the addition of a small amount of LiI speeds up the reaction considerably.

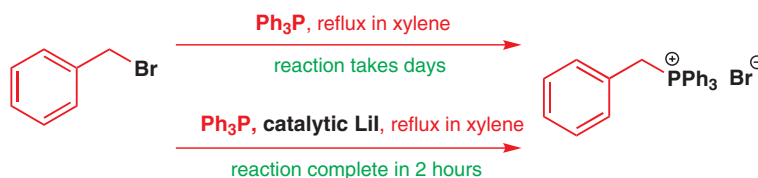

The iodide reacts both as a better nucleophile than Ph_3P and then as a better leaving group than Br^- . Each iodide ion goes round the cycle many times as a **nucleophilic catalyst**.

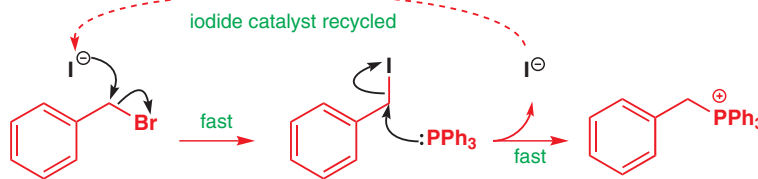

Looking forward: elimination and rearrangement reactions

Simple nucleophilic substitutions at saturated carbon atoms are fundamental reactions found wherever organic chemistry is practised. They are used in industry on an enormous scale and in pharmaceutical laboratories to make important drugs. They are worth studying for their importance and relevance.

There is another side to this simple picture. These were among the first reactions whose mechanisms were thoroughly investigated by Ingold in the 1930s and since then they have probably been studied more than any other reactions. All our understanding of organic mechanisms begins with S_N1 and S_N2 reactions, and you need to understand these basic mechanisms properly.

The carbocations you met in this chapter are reactive intermediates not only in S_N1 substitutions but in other reactions too. One of the most convincing pieces of evidence for their formation is that they undergo reactions other than simple addition to nucleophiles. For example, the carbon skeleton of the cation may *rearrange*, as we will discuss in Chapter 36.

a rearrangement reaction

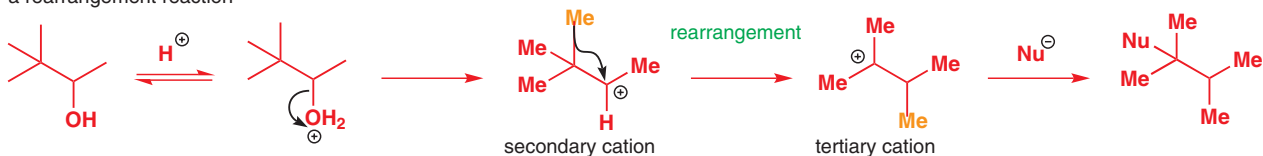

Another common fate of cations, and something that may also happen instead of an intended $\text{S}_{\text{N}}1$ or $\text{S}_{\text{N}}2$ reaction, is *elimination*. Here an alkene is formed by the nucleophile acting as a base to remove HX instead of adding to the molecule.

an elimination reaction (E1)

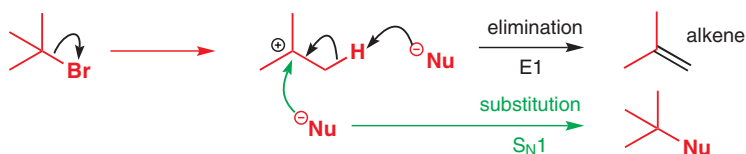

You will meet elimination reactions in the next chapter but one (17) after some further exploration of stereochemistry.

Further reading

This subject is treated in every organic chemistry textbook, often as the first reaction described. Good examples include: J. Keeler and P. Wothers, *Why Chemical Reactions Happen*, OUP, Oxford, 2003,

chapter 11 and F. A. Carey and R. J. Sundberg, *Advanced Organic Chemistry A, Structure and Mechanisms*, 5th edn, Springer, 2007, chapter 4.

Check your understanding



To check that you have mastered the concepts presented in this chapter, attempt the problems that are available in the book's Online Resource Centre at <http://www.oxfordtextbooks.co.uk/orc/clayden2e/>

16

Conformational analysis

Connections

➔ Building on

- How to determine a molecule's structure [ch3 & ch13](#)
- How some molecules can exist as stereoisomers [ch14](#)

Arriving at

- If I could see a molecule, what would its three-dimensional shape (conformation) be?
- What effect does a molecule's shape have on its reactions?
- How single bonds are free to rotate, but spend most of their time in just two or three well-defined arrangements
- How rings of atoms are usually not planar, but 'puckered'
- How 'puckered' six-membered rings have the most well-defined arrangements of atoms
- How to draw six-membered rings accurately
- How to use the known arrangements of the atoms in a six-membered ring to predict and explain their reactions

➔ Looking forward to

- How conformation, and the alignment of atoms, can affect elimination reactions [ch17](#)
- How NMR spectroscopy backs up what we have said in this chapter [ch31](#)
- How the conformation of molecules dictates how they react, e.g. from which direction they will be attacked by reagents [ch32 & ch33](#)
- How the alignment of bonds can allow groups in molecules to move around (rearrangement reactions) or allow C–C bonds to break (fragmentation reactions) [ch36](#)
- How the alignment of orbitals controls reactivity (stereoelectronics) [ch31](#)
- The accurate drawing of rings as transition states is necessary [ch32, ch34, & ch35](#)

Bond rotation allows chains of atoms to adopt a number of conformations

Several chapters of this book have considered how to find out the structure of molecules. We have seen X-ray crystallography pictures, which reveal exactly where the atoms are in crystals; we have looked at IR spectroscopy, which gives us information about the bonds in the molecule, and at NMR spectroscopy, which gives us information about the atoms themselves and how they are joined up. Up to now, we have mainly been interested in determining which atoms are bonded to which other atoms and also the shapes of small localized groups of atoms. For example, a methyl group has three hydrogen atoms bonded to one carbon atom and the atoms around this carbon are located at the corners of a tetrahedron; a ketone consists of a carbon atom bonded to two other carbon atoms and doubly bonded to an oxygen atom, with all these atoms in the same plane.

But, on a slightly larger scale, shape is not usually so well defined. Rotation is possible about single bonds and this rotation means that, while the localized arrangement of atoms stays the same (every saturated carbon atom is still always tetrahedral), the molecule as a whole can adopt a number of different shapes. Shown on the next page are several snapshot views of one molecule—it happens to be a pheromone used by pea moths to attract a mate. Although the structures look dissimilar, they differ from one another only by rotation about one or more single bonds. Whilst the overall shapes differ, the localized structure is still the

Online support. The icon  in the margin indicates that accompanying interactive resources are provided online to help your understanding: just type www.chemtube3d.com/clayden/123 into your browser, replacing **123** with the number of the page where you see the icon. For pages linking to more than one resource, type **123-1, 123-2** etc. (replacing **123** with the page number) for access to successive links.

same: tetrahedral sp^3 carbons; trigonal planar sp^2 carbons. Notice another point too, which we will pick up on later: the arrangement about the double bond always remains the same because double bonds can't rotate.

■ This point is also discussed in Chapters 4 and 12.

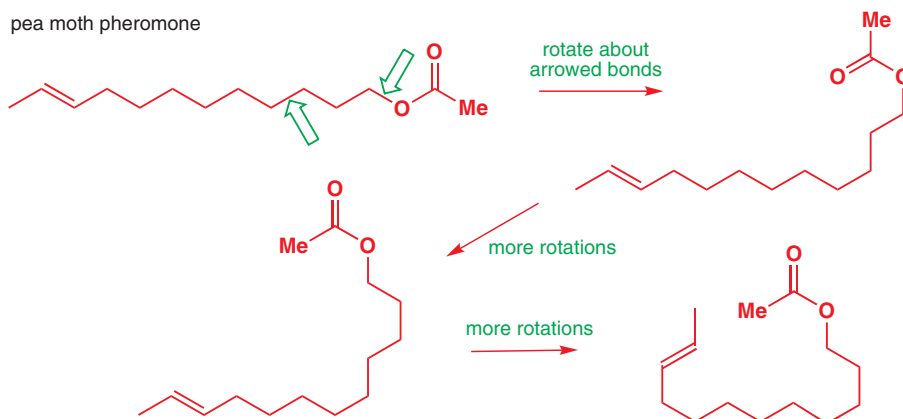

Interactive conformations of pea moth pheromone

At room temperature in solution, all the single bonds in the molecule are constantly rotating—the chances that two molecules will have exactly the same shape at any one time are quite small.

Yet, even though no two molecules have exactly the same shape at any one time, they are still all the same chemical compound—they have all the same atoms attached in the same way. We call the different shapes of molecules of the same compound different **conformations**.

Conformation and configuration

To get from one conformation to another, we can rotate about as many single bonds as we like. The one thing we can't do though is to break any bonds. This is why we can't rotate about a double bond—to do so we would need to break the π bond. Below are some pairs of structures that can be interconverted by rotating about single bonds: they are all different conformations of the same molecule.

three compounds, each shown in two conformations

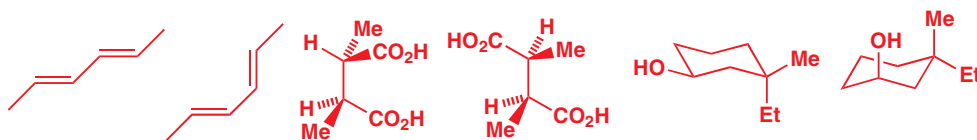

The next block of molecules is something quite different: these pairs can only be interconverted by breaking a bond. This means that they have different **configurations**—configurations can be interconverted only by breaking bonds. Compounds with different configurations are called **stereoisomers** and we dealt with them in Chapter 14.

three pairs of stereoisomers: each member of a pair has a different configuration

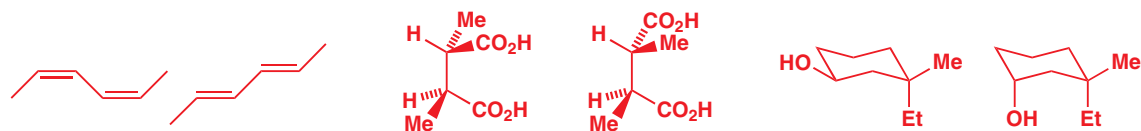

● Rotation or bond breaking?

- Structures that can be interconverted simply by rotation about single bonds are **conformations** of the same molecule.
- Structures that can be interconverted only by breaking one or more bonds have different **configurations**, and are stereoisomers.

■ Make models

If you find this hard to see, get a set of molecular models and build the first one of each pair. You should be able to rotate it straightforwardly into the second without breaking your model. Our advice throughout this chapter, certainly with things that you find difficult to understand from the two-dimensional drawings to which we are limited, is to make models.

Conformation and configuration

Different conformations of a person – Some more stable than others ...

A different configuration

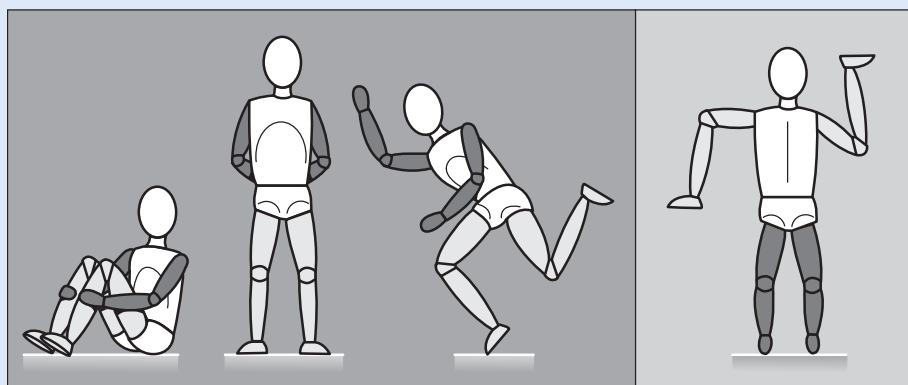

Barriers to rotation

We saw in Chapter 7 that rotation about the C–N bond in an amide is relatively slow at room temperature—the NMR spectrum of DMF clearly shows two methyl signals (p. 156). In Chapter 12 you learned that the rate of a chemical process is associated with an energy barrier (this holds both for reactions and simple bond rotations): the lower the rate, the higher the barrier. Rotation about single bonds is fast at room temperature, but there is nonetheless a barrier to rotation in ethane (A), for example, of about 12 kJ mol^{-1} .

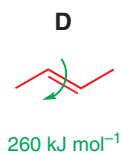
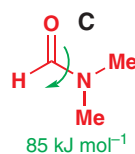
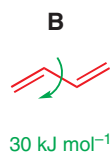
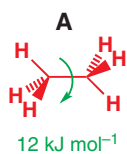

The energy barrier for rotation about the single bond in butadiene (B) is slightly larger because of the weak conjugation between the double bonds, but the barrier to rotation about the genuine double bond in but-2-ene (D) is enormous and no rotation is seen. The energy barrier to the rotation about the C–N bond in an amide such as DMF (C) is usually about 80 kJ mol^{-1} , translating into a rate of about 0.1 s^{-1} at 20°C . The conjugation in amides is well developed, and the C–N bond has significant double-bond character.

Rates and barriers

It can be useful to remember some simple guidelines to the way in which energy barriers relate to rates of rotation, as discussed in Chapter 12. For example:

- A barrier of 73 kJ mol^{-1} allows one rotation every second at 25°C (that is, the rate is 1 s^{-1}).
- Every 6 kJ mol^{-1} changes the rate at 25°C by about a factor of 10.

To see signals in an NMR spectrum for two different conformations, they must interconvert no faster than (very roughly) 1000 s^{-1} —a barrier of about 55 kJ mol^{-1} at 25°C . This is why NMR shows two methyl signals for DMF, but only one set of signals for butadiene. See p. 374 for more on this.

For conformations to interconvert slowly enough for them to exist as different compounds, the barrier must be over 100 kJ mol^{-1} . The barrier to rotation about a $\text{C}=\text{C}$ double bond is 260 kJ mol^{-1} —which is why we can separate *E* and *Z* isomers.

Conformations of ethane

Why should there be an energy barrier in the rotation about a single bond? In order to answer this question, we should start with the simplest $\text{C}-\text{C}$ bond possible—the one in ethane. Ethane has two extreme conformations called the staggered and eclipsed conformations. Three different views of these are shown below.

the two extreme conformations of ethane, staggered and eclipsed, each shown from three different viewpoints

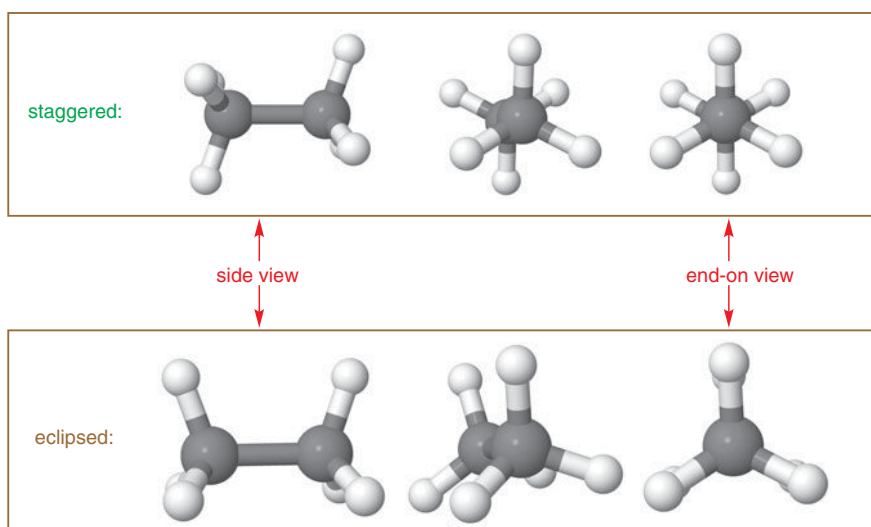

You can see why the conformations have these names by looking at the end-on views in the diagram. In the eclipsed case the near $\text{C}-\text{H}$ bonds completely block the view of the far bonds, just as in a solar eclipse the Moon blocks the Sun as seen from the Earth. In the staggered conformation, the far $\text{C}-\text{H}$ bonds appear in the gaps between the near $\text{C}-\text{H}$ bonds—the bonds are staggered.

Chemists often want to draw these two conformations quickly and two different methods are commonly used, each with its own merits. In the first method, shown on the right, we simply draw the side view of the molecule and use wedged and hashed lines to show bonds not in the plane of the paper (as you saw in Chapter 14). Particular attention must be paid to which of the bonds are in the plane and which go into and out of the plane.

In the second method we draw the end-on view, looking along the $\text{C}-\text{C}$ bond. This view is known as a Newman projection, and Newman projections are subject to a few conventions:

- The carbon atom nearer the viewer is at the junction of the front three bonds.
- The carbon further away (which can't in fact be seen in the end-on view) is represented by a large circle. This makes the perspective inaccurate, but this doesn't matter.

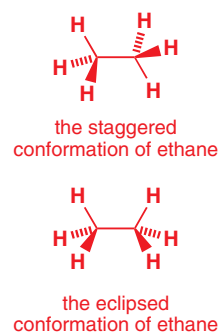

- Bonds attached to this further carbon join the *edge* of the circle and do not meet in the centre.
- Eclipsed bonds are drawn slightly displaced for clarity—as though the bond were rotated by a tiny fraction.

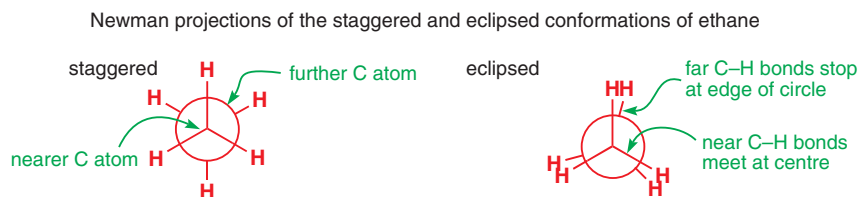

■ Picturing dihedral angles is sometimes hard—one way to do it is to imagine the two C–H bonds drawn on two facing pages of a book. The dihedral angle is then the angle between the pages, measured perpendicular to the spine. See Chapter 31.

The staggered and eclipsed conformations of ethane are not identical in energy: the staggered conformation is lower in energy than the eclipsed by 12 kJ mol^{-1} , the value of the rotational barrier. Of course, there are other possible conformations too with energies in between these extremes, and we can plot a graph to show the change in energy of the system as the C–C bond rotates. We define the dihedral angle, θ (sometimes called the torsion angle), to be the angle between a C–H bond at the nearer carbon and a C–H bond at the far carbon. In the staggered conformation, $\theta = 60^\circ$ whilst in the eclipsed conformation, $\theta = 0^\circ$.

The energy level diagram shows the staggered conformation as a potential energy minimum whilst the eclipsed conformation represents an energy maximum. This means that the eclipsed conformation is not a stable conformation since any slight rotation will lead to a conformation lower in energy. The molecule will actually spend the vast majority of its time in a staggered or nearly staggered conformation and only briefly pass through the eclipsed conformation *en route* to another staggered conformation.

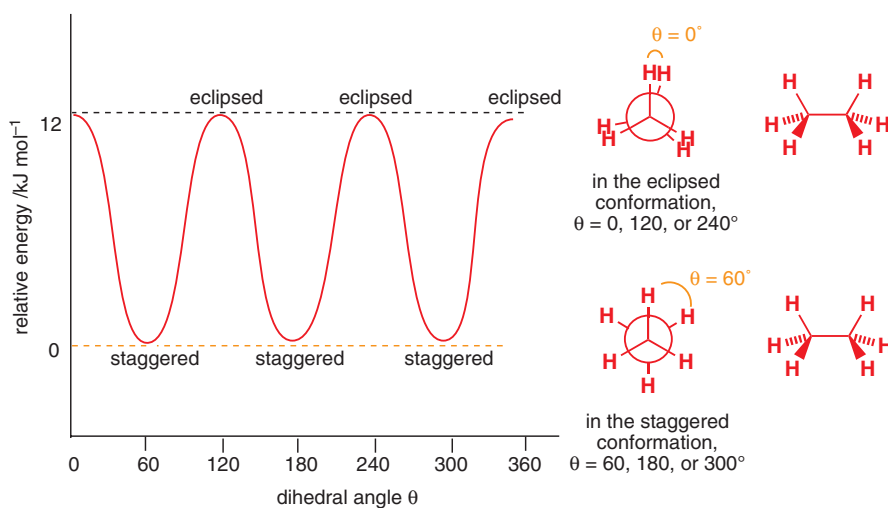

Interactive conformations of ethane

But *why* is the eclipsed conformation higher in energy than the staggered conformation? There are two reasons. The first is that the electrons in the bonds repel each other and this repulsion is at a maximum when the bonds are aligned in the eclipsed conformation. The second is that there may be some stabilizing interaction between the C–H σ bonding orbital on one carbon and the C–H σ^* antibonding orbital on the other carbon, which is greatest when the two orbitals are exactly parallel: this only happens in the staggered conformation. The same effects—repulsion between filled orbitals (a form of steric effect, see p. 129) and stabilization by donation into antibonding orbitals—govern the favoured conformations about all rotating bonds.

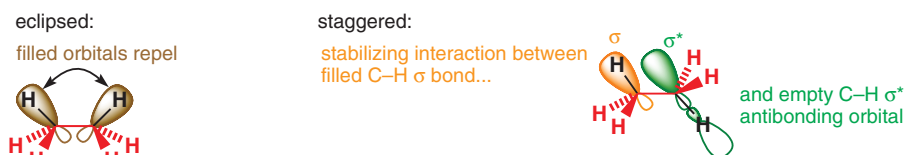

Conformations of propane

Propane is the next simplest hydrocarbon. Before we consider what conformations are possible for propane we should first look at its geometry. The C–C–C bond angle is not 109.5° (the tetrahedral angle, see Chapters 2 and 4) as we might expect, but 112.4° . Consequently, the H–C–H bond angle on the central carbon is smaller than the ideal angle of 109.5° , only 106.1° . This does not necessarily mean that the two methyl groups on the central carbon clash in some way, but instead that two C–C bonds repel each other more than two C–H bonds do.

As in the case of ethane, two extreme conformations of propane are possible—in one the C–H and C–C bonds are staggered, in the other they are eclipsed.

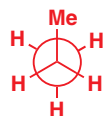

the staggered conformation of propane

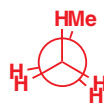
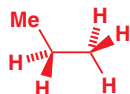

the eclipsed conformation of propane

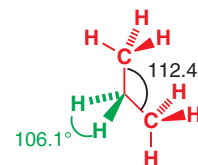
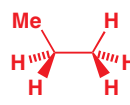

there is greater repulsion between two C–C bonds than between two C–H bonds

■ Notice that when we draw the eclipsed conformation we have to offset the front and back bonds slightly to see the substituents clearly. In reality, one is right behind the other.

The rotational barrier is now slightly higher than for ethane: 14 kJ mol^{-1} as compared to 12 kJ mol^{-1} . This again reflects the greater repulsion of electrons in the coplanar bonds in the eclipsed conformation rather than any steric interactions. The energy graph for bond rotation in propane would look exactly the same as that for ethane except that the barrier is now 14 kJ mol^{-1} .

Conformations of butane

With butane things start to get slightly more complicated. Now we have effectively replaced two hydrogen atoms in ethane by larger methyl groups. These are large enough to get in the way of each other, and steric repulsion becomes a significant contribution to the rotational energy barriers. However, the main complication is that, as we rotate about the central C–C bond, not all the staggered conformations are the same, and neither are all the eclipsed conformations. The six conformations that butane can adopt as the central C–C bond is rotated in 60° intervals are shown below. The green Me group and the brown hydrogens are rotating while the substituents on the other carbon atom remain still.

conformations of butane

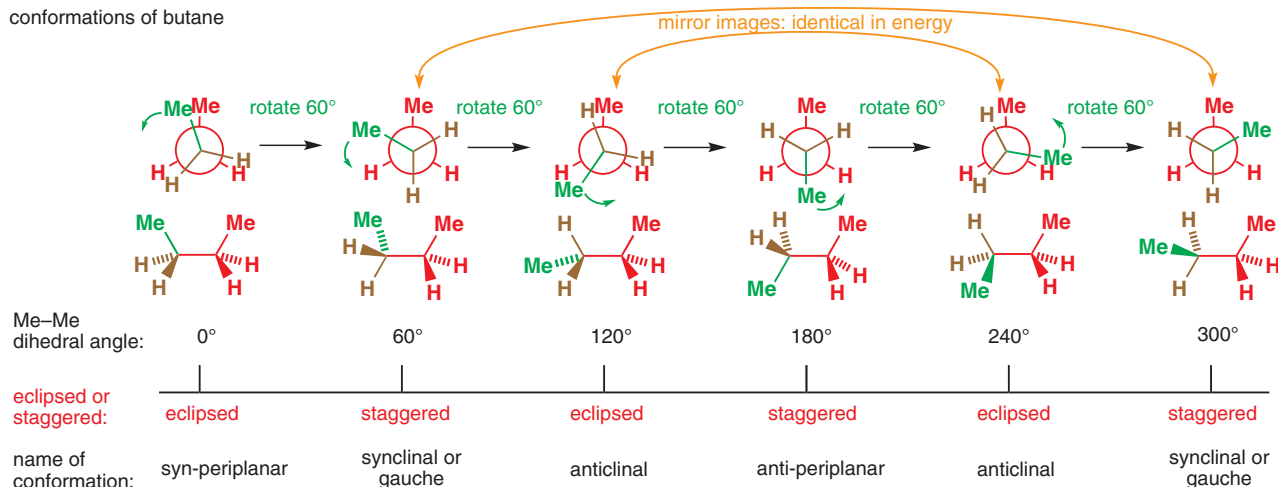

Look closely at these different conformations. The conformations with dihedral angles 60° and 300° are actually mirror images of each other, as are the conformations with angles 120° and 240° . This means that we really only have four different maxima or minima in energy as we rotate about the central C–C bond: two types of eclipsed conformation, which will represent maxima in the energy–rotation graph, and two types of staggered conformation, which will represent minima. These four different conformations have names, shown in the bottom row of the diagram. In the syn-periplanar and anti-periplanar conformations the two C–Me bonds lie in the same plane; in the synclinal (or gauche) and anticlinal conformations they slope towards (*syn*) or away from (*anti*) one another.

Before we draw the energy–rotation graph, let's just stop and think what it might look like. Each of the eclipsed conformations will be energy maxima but the syn-periplanar conformation ($\theta = 0^\circ$) will be higher in energy than the two anticlinal conformations ($\theta = 120^\circ$ and 240°): in the syn-periplanar conformation two methyl groups are eclipsing each other whereas in the anticlinal conformations each methyl group is eclipsing only a hydrogen atom. The staggered conformations will be energy minima but the two methyl groups are furthest from each other in the anti-periplanar conformation so this will be a slightly lower minimum than the two synclinal (gauche) conformations.

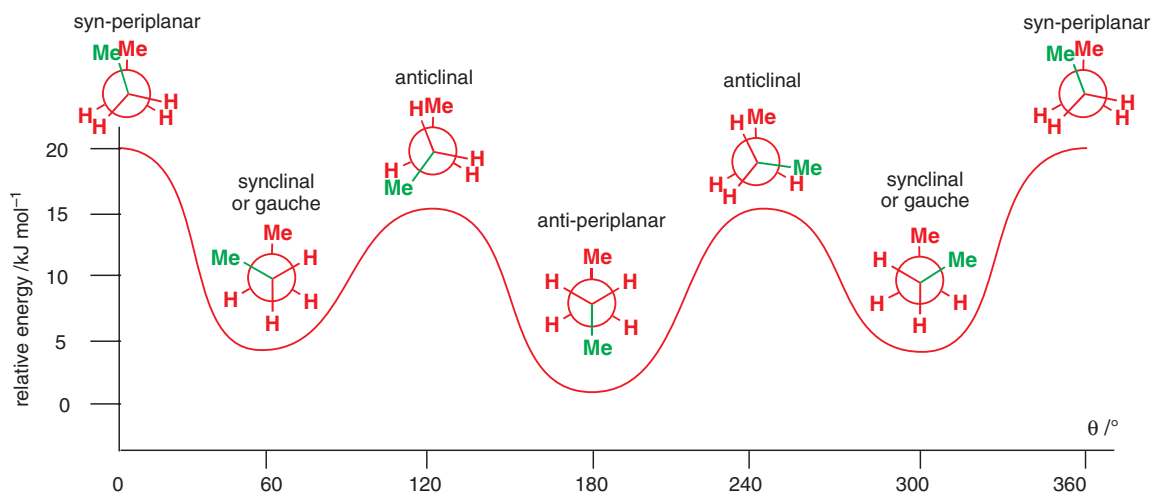

 Interactive conformations of butane

■ The rotation is very rapid indeed: the barrier of 20 kJ mol^{-1} corresponds to a rate at room temperature of $2 \times 10^9 \text{ s}^{-1}$. This is far too fast for the different conformers to be detected by NMR (see p. 363): the NMR spectrum of butane shows only one set of signals representing an average of all the conformations.

■ You will see why such detailed conformational analysis of acyclic compounds is so important in Chapter 17 on eliminations, where the products of elimination reactions can be explained only by considering the conformations of the reactants and the transition states. But first we want to use these ideas to explain another branch of organic chemistry—the conformation of ring structures.

As in ethane, the eclipsed conformations are not stable since any rotation leads to a more stable conformation. The staggered conformations are stable since they each lie in a potential energy well. The anti-periplanar conformation, with the two methyl groups opposite each other, is the most stable of all. We can therefore think of a butane molecule as rapidly interconverting between synclinal and anti-periplanar conformations, passing quickly through the eclipsed conformations on the way. The eclipsed conformations are energy maxima, and therefore represent the transition states for interconversion between conformations.

If we managed to slow down the rapid interconversions in butane (by cooling to very low temperature, for example), we would be able to isolate the three stable conformations—the anti-periplanar and the two synclinal conformations. These different stable conformations of butane are some sort of isomers. They are called *conformational isomers* or *conformers* for short.

● Conformations and conformers

Butane can exist in an infinite number of *conformations* (we have chosen to show only the six most significant) but has only three *conformers* (potential energy minima)—the two synclinal (gauche) conformations and the anti-periplanar conformation.

You now have a more thorough explanation of the zig-zag arrangement of carbon chains, first introduced in Chapter 2 when we showed you how to draw molecules realistically. This is the shape you get if you allow all the C–C bonds to take up the anti-periplanar conformation, and it will be the most stable conformation for any linear alkane.

Ring strain

Up to now, we haven't given an entirely accurate impression of rings. We have been drawing them all as though they were planar, although this is actually not the case. In this section you will learn how to draw rings more accurately and to understand the properties of the different conformations adopted.

If we assume that in fully saturated carbocyclic rings each carbon is sp^3 hybridized, then each bond angle would ideally be 109.5° . However, in a planar ring, the carbon atoms don't

have the luxury of choosing their bond angles: internal angle depends only on the number of atoms in the ring. If this angle differs from the ideal 109.5° , there will be some sort of strain in the molecule. This is best seen in the picture below, where the atoms are forced planar. The more strained the molecules are, the more the bonds curve—in a strain-free molecule, the bonds are straight.

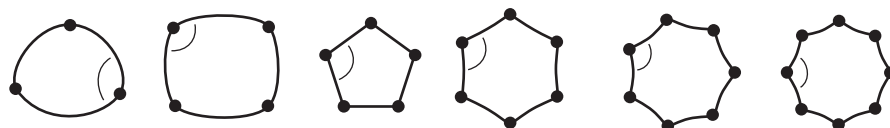

All internal angles 109.5°

Notice how in the smaller rings the bonds curve outwards, whilst in the larger rings the bonds curve inwards. The table gives values for the internal angles for regular planar polygons and an indication of the strain per carbon atom due to the deviation of this angle from the ideal tetrahedral angle of 109.5° .

These data are best presented as a graph, and the ring strain per carbon atom in planar rings for ring sizes up to 17 are shown on the next page. Whether the bonds are strained inwards or outwards is not important so only the magnitude of the strain is shown.

From these figures (represented in the graph on p. 368), note:

- These are calculated data for hypothetical planar rings. As you will see, real rings are rather different.
- The calculated ring strain is largest for three-membered rings but rapidly decreases through a four-membered ring and reaches a minimum for a five-membered ring.
- The calculated ring strain increases again (although less rapidly) as the rings get larger after the minimum at 5.

But what we really need is a measure of the strain in actual compounds, not just a theoretical prediction in planar rings, so that we can compare this with the theoretical angle strain. A good measure of the strain in real rings is obtained using heats of combustion. Look at the following heats of combustion for some straight-chain alkanes. What is striking is that the difference between any two in the series is very nearly constant at around -660 kJ mol^{-1} .

Heats of combustion for some straight-chain alkanes

Straight-chain alkane	$\text{CH}_3(\text{CH}_2)_n\text{CH}_3$, $n =$	$-\Delta H_{\text{combustion}}$, kJ mol^{-1}	Difference, kJ mol^{-1}
ethane	0	1560	
propane	1	2220	660
butane	2	2877	657
pentane	3	3536	659
hexane	4	4194	658
heptane	5	4853	659
octane	6	5511	658
nonane	7	6171	660
decane	8	6829	658
undecane	9	7487	658
dodecane	10	8148	661

If we assume (as is reasonable) that there is no strain in the straight-chain alkanes, then each extra methylene group, $-\text{CH}_2-$, contributes on average an extra $658.7 \text{ kJ mol}^{-1}$ to the heat of combustion for the alkane. A cycloalkane $(\text{CH}_2)_n$ is simply a number of methylene groups joined together. If the cycloalkane is strain-free, then its heat of combustion should be $n \times 658.7 \text{ kJ mol}^{-1}$. If, however, there is some strain in the ring that makes the ring less stable (that is, raises its energy) then more energy is given out on combustion. Now, let's put all this together in a graph showing, for each ring size: (a) angle strain per CH_2 group and (b) heat of combustion per CH_2 group.

■ We have used ring strain a number of times to explain the reactivity of cyclic molecules (p. 352).

Number of atoms in ring	Internal angle in planar ring	$109.5^\circ - \text{internal angle}^a$
3	60°	49.5°
4	90°	19.5°
5	108°	1.5°
6	120°	-10.5°
7	128.5°	-19°
8	135°	-25.5°

^a A measure of strain per carbon atom.

■ A similar measurement was used in Chapter 7 to demonstrate the stabilization of benzene due to its aromaticity.

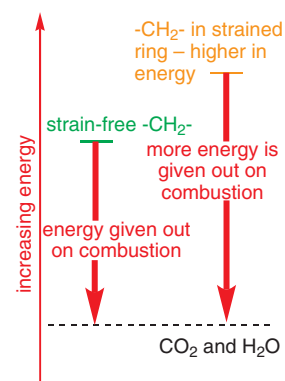

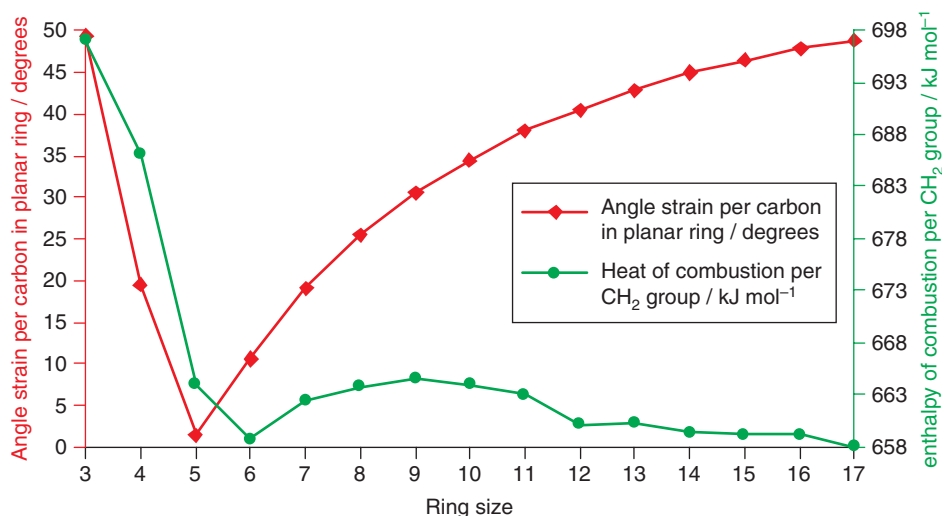

Points to notice in graph above:

- The greatest strain by far is in the three-membered ring, cyclopropane ($n = 3$).
- The strain decreases rapidly with ring size but reaches a minimum for cyclohexane, *not* cyclopentane as you might have predicted from the angle calculations.
- The strain then increases but not nearly as quickly as the angle calculation suggested: it reaches a maximum at around $n = 9$ and then decreases once more.
- The strain does not go on increasing as ring size increases but instead remains roughly constant after about $n = 14$.
- Cyclohexane ($n = 6$) and the larger cycloalkanes ($n \geq 14$) all have heats of combustion per $-\text{CH}_2$ group of around 658 kJ mol^{-1} , the same value as that of a $-\text{CH}_2$ group in a straight-chain alkane, that is, *they are essentially strain-free*.

You might ask yourself some questions now:

Why are six-membered rings and large rings virtually strain-free?

Why is there still some strain in five-membered rings even though the bond angles in a planar structure are almost 109.5° ?

The answer to both these questions, as you may already have guessed, is that the assumption that the rings are planar is simply not correct. It is easy to see how large rings can fold up into many different conformations as easily as acyclic compounds do. It is less clear to predict what happens in six-membered rings.

Six-membered rings

If you were to join six tetrahedral carbon atoms together, you would probably find that you ended up with a shape like this.

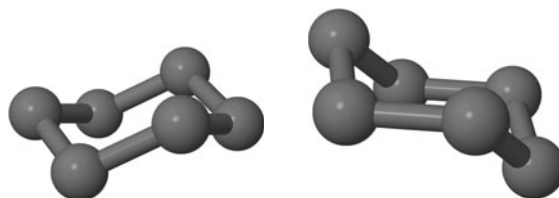

All the carbon atoms are certainly not in the same plane, and there is no strain because all the bond angles are 109.5° . If you squash the model against the desk, forcing the atoms to lie in the same plane, it springs back into this shape as soon as you let go. If you view the model from one side (the second picture above) you will notice that four carbon atoms lie in the same plane, with the fifth above the plane and the sixth below it (although it's important to realize that all six are identical—you can check this by rotating your model). The slightly overly imaginative name for this conformation—the **chair conformation**—derives from this view.

Chemists class rings as small, normal, medium, or large depending on their size.

small, $n = 3$ or 4

normal, $n = 5, 6$, or 7

medium, $n = 8$ to about 14

large, $n >$ about 14

This is because these different classes all have different properties and synthetic routes to making them. The groupings are evident in the graph above.

■ By far the easiest way to get to grips with these different shapes is by building models. We strongly recommend you do this!

There is another conformation of cyclohexane that you might have made that looks like this.

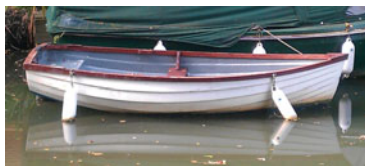
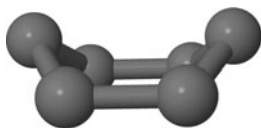

This conformation is known as the **boat conformation**. In this conformation there are still four carbon atoms in one plane, but the other two are both above this plane. Now all the carbon atoms are not the same—the four in the plane are different from the ones above. However, this is not a stable conformation of cyclohexane, even though there is no bond angle strain (all the angles are 109.5°). In order to understand why not, we must go back a few steps and answer our other question: why is cyclopentane strained even though a planar conformation has virtually no angle strain?

Smaller rings (three, four, and five members)

The three carbon atoms in cyclopropane must lie in a plane since it is always possible to draw a plane through any three points. All the C–C bond lengths are the same, which means that the three carbon atoms are at the corners of an equilateral triangle. From the large heat of combustion per methylene group (p. 368) we know that there is considerable strain in this molecule. Most of this is due to the bond angles deviating so greatly from the ideal tetrahedral value of 109.5° . Most—but not all. If we view along one of the C–C bonds we can see a further cause of strain—all the C–H bonds are eclipsed.

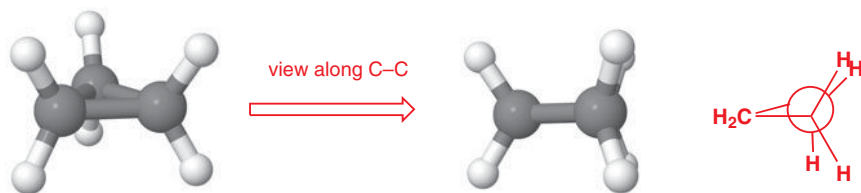

a side-on view of cyclopropane

viewing cyclopropane along a C–C bond shows that all the C–H bonds are eclipsed

The eclipsed conformation of ethane is an energy maximum and any rotation leads to a more stable conformation. In cyclopropane it is not possible to rotate any of the C–C bonds and so all the C–H bonds are forced to eclipse their neighbours. In fact, in any planar conformation all the C–H bonds will be eclipsed with their neighbours. In cyclobutane, the ring distorts from a planar conformation in order to reduce the eclipsing interactions, even though this reduces the bond angles further and so increases the bond angle strain. Cyclobutane adopts a puckered or 'wing-shaped' conformation.

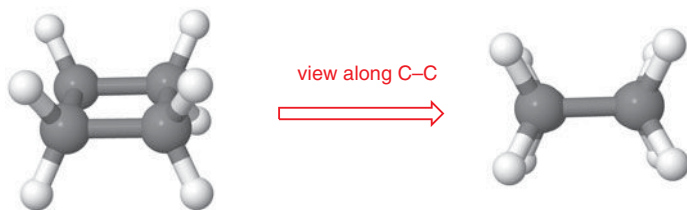

planar cyclobutane (not the real conformation)

side-on view of planar cyclobutane shows eclipsing C–H bonds



the puckered 'wing' conformation of cyclobutane

C–H bonds no longer fully eclipsed

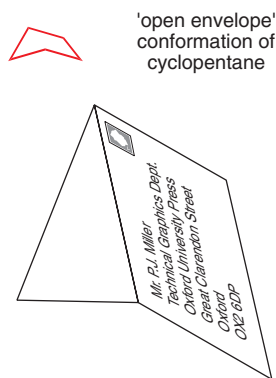

This explains why cyclopentane is not entirely strain-free even though in a planar conformation the C–C–C bond angles are close to 109.5° . The heat of combustion data give us an indication of the total strain in the molecule, not just the contribution of angle strain. There is strain in planar cyclopentane caused by the eclipsing of adjacent C–H bonds. As in cyclobutane, the ring distorts to reduce the eclipsing interactions but this increases the angle strain. Whatever happens, there is always going to be some strain in the system. The minimum energy conformation adopted is a balance of the two opposing effects. Cyclopentane adopts a shape approximating to an 'open envelope', with four C atoms in a plane and one above or below it. The atoms in the ring rapidly take turns not to be in the plane, and cyclopentanes have much less well-defined conformational properties than cyclohexanes, to which we shall now return.

A closer look at cyclohexane

■ We shall consider the conformations, and reactions, of cyclopentanes in Chapter 32.

The heats of combustion data on p. 368 show that cyclohexane is virtually strain-free. This must mean that not only is there no angle strain, but there is also no strain from eclipsing interactions either. A model of the chair conformation of cyclohexane including all the hydrogen atoms looks like this.

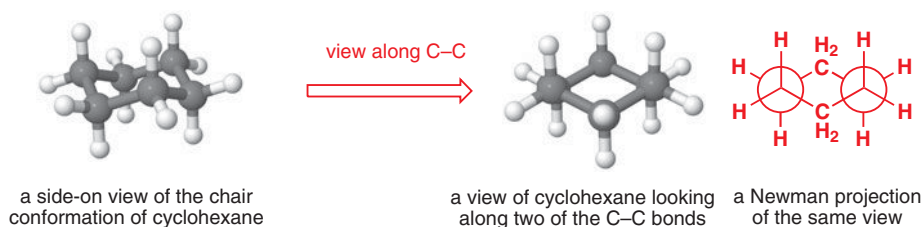

The view along two of the C–C bonds clearly shows that there are no eclipsing C–H bonds in the chair conformation of cyclohexane—in fact, all the bonds are fully staggered, giving the lowest energy possible. This is why cyclohexane is strain-free. Contrast this with the boat conformation. Now four pairs of C–H bonds are eclipsed, and there is a particularly bad interaction between the 'flagstaff' C–H bonds.

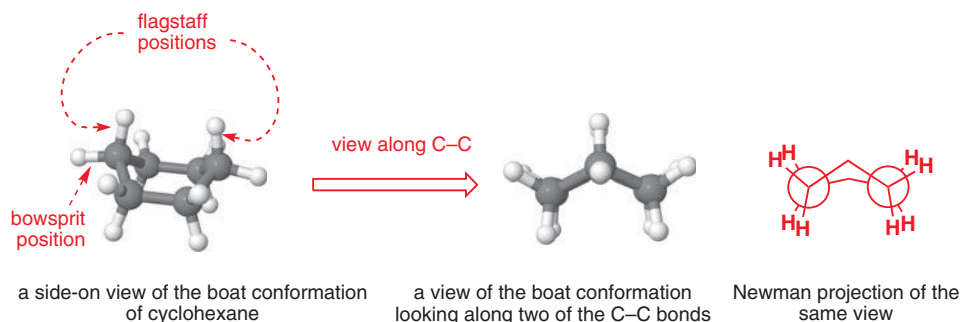

This explains why the boat conformation is much less important than the chair conformation. Even though both are free from angle strain, the eclipsing interactions in the boat conformation make it approximately 25 kJ mol^{-1} higher in energy than the chair conformation. In fact, as we shall see later, the boat conformation represents an energy maximum in cyclohexane whilst the chair conformation is an energy minimum. Earlier we saw how the eclipsing interactions in planar cyclobutane and cyclopentane could be reduced by distortion of the ring. The same is true for the boat conformation of cyclohexane. The eclipsing interactions can be relieved slightly if the two 'side' C–C bonds twist relative to each other.

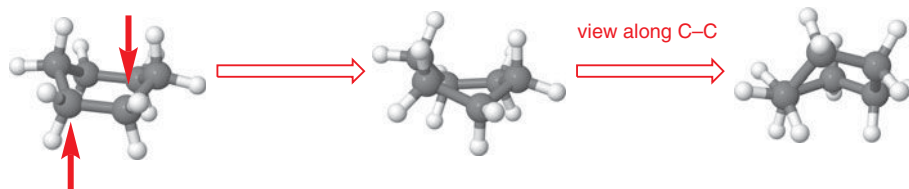

pushing these two carbon atoms in the direction shown... gives a slightly different conformation in which the eclipsing interactions have been reduced: the 'twist-boat' conformation

... gives a slightly different conformation in which the eclipsing interactions have been reduced: the 'twist-boat' conformation

an end-on view of the twist-boat conformation shows the reduced eclipsing interactions

This twisting gives rise to a slightly different conformation of cyclohexane called the **twist-boat conformation**, which, although not as low in energy as the chair form, is lower in energy (by 4 kJ mol^{-1}) than the boat form and is a local energy minimum, as we shall see later. Cyclohexane has two stable conformers, the chair and the twist-boat. The chair form is approximately 21 kJ mol^{-1} lower in energy than the twist-boat form.

Axial and equatorial

Take another look at the chair conformation on p. 368. All six carbon atoms are identical, but there are two types of protons—one type stick either vertically up or down and are called **axial** hydrogen atoms; the other sort stick out sideways and are called **equatorial** hydrogen atoms. As you go round the ring, notice that each of the CH_2 groups has one hydrogen sticking up and one sticking down. However, all the 'up' ones alternate between axial and equatorial, as do all the 'down' ones.

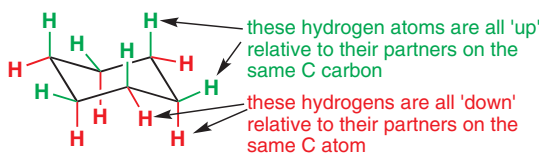
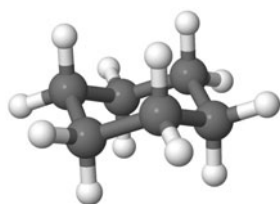

Before going any further, it's important that you learn how to draw cyclohexane properly. Without cluttering the structure with Cs and Hs, a chemist would draw cyclohexane as one of these three structures.



Up to now, we have simply used the hexagon A to represent cyclohexane. We shall see that, whilst this is the least informative of the three, it is nonetheless still useful. The more informative structures B and C (which are actually just different views of the same molecule) take some practice to draw properly, but you need to be able to draw convincing cyclohexanes and it is worth taking the time to learn how to now.

Guidelines for drawing cyclohexane

The carbon skeleton

Trying to draw the chair conformation of cyclohexane in one continuous line can lead to some dreadful diagrams. The easiest way to draw a chair conformation is by starting off with one end.

Next draw in two parallel lines of equal length.

At this stage, the top of the new line should be level with the top of the original pair.

Finally, the last two lines should be added. These lines should be parallel to the first pair of lines as shown and the lowest points should also be level.

■ A **local energy minimum** is the bottom of the potential energy well, but not necessarily the deepest possible well, which is the **global energy minimum**. Small changes in conformation will increase the energy, although a large change may be able to decrease the energy further. As an example, the synclinal (gauche) conformation of butane is a *local* energy minimum; the anti-periplanar conformation is the *global* energy minimum.

■ Compare the equator and axis of the Earth: equatorial bonds are around the equator of the molecule. Note the spelling (**not** equitorial!).

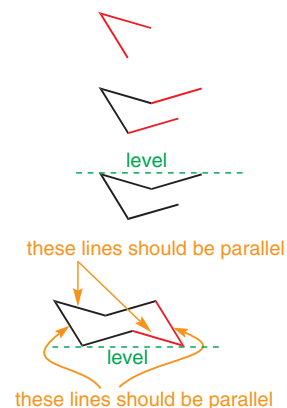

Adding the hydrogen atoms

This is often the trickiest part. Just remember that you are trying to make each of the carbon atoms look tetrahedral. (Note that we don't normally use wedged and hashed bonds in these chair-shaped diagrams; otherwise things get really messy.)

The axial bonds are relatively easy to draw in. They should all be vertically aligned and alternate up and down all round the ring.

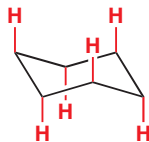

The equatorial bonds require a little more care to draw. The thing to remember is that each equatorial bond must be parallel to two C–C bonds.

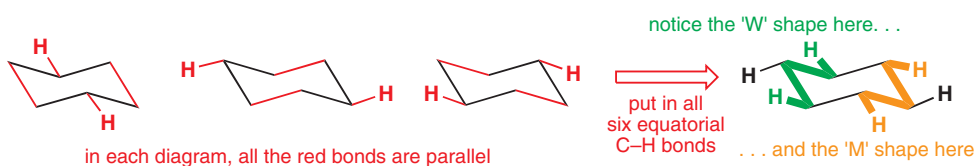

The complete diagram with all the hydrogen atoms should look like this. Most of the time you won't want to draw in *all* the Hs but you need to know how to orientate them in case you do need to.

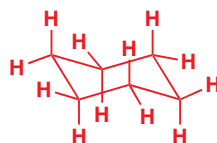

Common mistakes

If you follow all the guidelines above, you will soon be drawing good conformational diagrams. However, a few common mistakes have been included to show you what not to do!

how *not* to draw cyclohexanes...

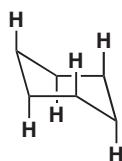

The chair has been drawn with the middle bonds horizontal, so the upper points of the chair are not level. This means the axial hydrogens can no longer be drawn correctly vertical.

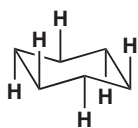

The axial hydrogens have been drawn alternating up and down on the wrong carbons. This structure is impossible because none of the carbons can be tetrahedral.

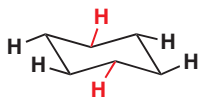

The red hydrogens have been drawn at the wrong angles—look for the parallel lines and the 'W' and 'M'.

The ring inversion (flipping) of cyclohexane

Given that this chair conformer is the preferred conformation for cyclohexane, what would you expect its ^{13}C NMR spectrum to look like? All six carbon atoms are the same so there should only be one signal (and indeed there is, at 25.2 ppm). But what about the ^1H NMR spectrum? The two different sorts of protons (axial and equatorial) ought to resonate at different frequencies, so two signals should be seen (each with coupling to neighbouring protons). In fact, there is only *one* resonance in the proton spectrum, at 1.40 ppm. In a monosubstituted cyclohexane there should be two isomers detectable—one with the substituent axial, the other with the substituent equatorial. But again at room temperature only one set of signals is seen.

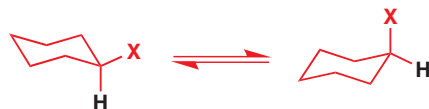

ring inversion of a monosubstituted cyclohexane
notice that the hydrogen atom shown changes from axial to equatorial

This changes when the NMR spectrum is run at low temperature. Now two isomers are visible, and this gives us a clue as to what is happening: the two isomers are conformers that interconvert—rapidly at room temperature, but more slowly when the temperature is lowered. Recall that NMR does not distinguish between the three different stable conformers of butane (two synclinal and one anti-periplanar) because they are all rapidly interconverting so fast that only an average is seen. The same happens with cyclohexane—just by rotating bonds (that is, without breaking any!) cyclohexane can ring invert or ‘flip’. After ring inversion has taken place, all the bonds that were axial are now equatorial and vice versa.

The whole inversion process can be broken down into the conformations shown below. The green arrows show the direction in which the individual carbon atoms should move in order to get to the next conformation.

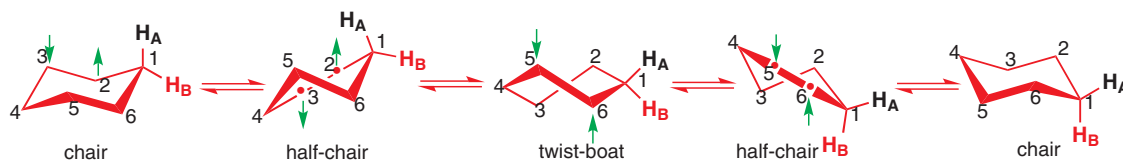

The energy profile (below) for this ring inversion shows that the half-chair conformation is the energy maximum on going from a chair to a twist-boat. The true boat conformation is the energy maximum on interchanging between two mirror-image twist-boat conformers, the second of which is converted to the other chair conformation through another half-chair.

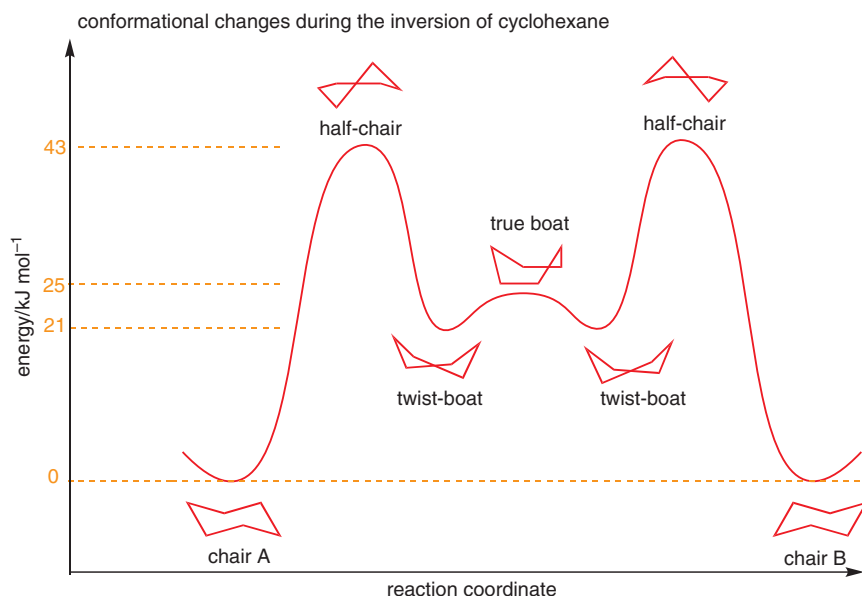

■ Make a model of cyclohexane and try the ring inversion for yourself.

Interactive conformations of cyclohexane

■ This would be a good point to remind you again of Chapter 12. This energy profile shows the conversion of one chair to another via two twist-boat *intermediates* (local energy minima). In between the energy minima are energy maxima, which are the *transition states* for the process. The progress of the ring-flipping ‘reaction’ is shown along an arbitrary ‘reaction coordinate’.

Drawing other cyclohexane conformations

In the **half-chair** conformation of cyclohexane, four adjacent carbon atoms are in one plane with the fifth above this plane and the sixth below it. You will meet this conformation again later—it represents the energy minimum for cyclohexene, for example.

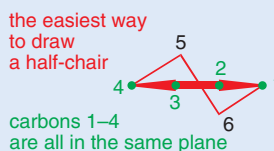

There are also a number of ways of drawing a twist-boat conformer but the easiest is this:

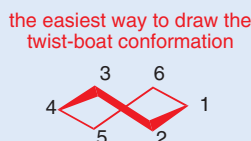

It's clear from the diagram that the barrier to ring inversion of cyclohexane is 43 kJ mol^{-1} , a rate at 25°C of about $2 \times 10^5 \text{ s}^{-1}$. Ring inversion also interconverts the axial and equatorial protons, so these are also exchanging at a rate of $2 \times 10^5 \text{ s}^{-1}$ at 25°C —too fast for them to be detected individually by NMR, which is why they appear as an averaged signal.

Rates and spectroscopy

NMR spectrometers behave like cameras with a shutter speed of about $1/1000\text{s}$. Anything happening faster than that, and we get a blurred picture; things happening more slowly give a sharp picture. In fact, a more exact number for the 'shutter speed' of an NMR machine (not a real shutter speed—just figuratively speaking!) is given by the equation

$$k = \pi \Delta\nu / \sqrt{2} = 2.22 \times \Delta\nu$$

where k is the fastest exchange rate that still gives individual signals and $\Delta\nu$ is the separation of those signals in the NMR spectrum measured in hertz. For example, on a 400 MHz spectrometer, two signals separated by 0.5 ppm are 100 Hz apart, so any process exchanging with a rate slower than 222 s^{-1} will still allow the NMR machine to show two separate signals; if they exchange with a rate faster than 222 s^{-1} only an averaged signal will be seen.

The equation above holds for any spectroscopic method, provided we think in terms of differences between signals or peaks measured in hertz. So, for example, a difference between two IR absorptions of 100 cm^{-1} can be represented as a wavelength of 0.01 cm ($1 \times 10^{-4} \text{ m}$) or a frequency of $3 \times 10^{12} \text{ s}^{-1}$. IR can detect changes happening a lot faster than NMR can—its 'shutter speed' is of the order of one-trillionth of a second.

■ In a monosubstituted cyclohexane there is only one type of equatorial conformer and one type of axial conformer. Convince yourself that these drawings are exactly the same conformation just viewed from different vantage points:

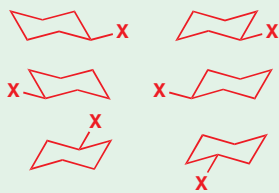

➔ We discussed the relationship between energy differences and equilibrium constants in Chapter 12.

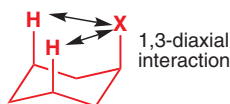

Substituted cyclohexanes

In a monosubstituted cyclohexane, there can exist two different chair conformers: one with the substituent axial, the other with it equatorial. The two chair conformers will be in rapid equilibrium (by the process we have just described) but they will not have the same energy. In almost all cases, *the conformer with the substituent axial is higher in energy*, which means there will be less of this form present at equilibrium.



For example, in methylcyclohexane ($\text{X}=\text{CH}_3$), the conformer with the methyl group axial is 7.3 kJ mol^{-1} higher in energy than the conformer with the methyl group equatorial. This energy difference corresponds to a 20:1 ratio of equatorial:axial conformers at 25°C .

There are two reasons why the axial conformer is higher in energy than the equatorial conformer. The first is that the axial conformer is destabilized by the repulsion between the axial group X and the two axial hydrogen atoms on the same side of the ring. This interaction is known as the 1,3-diaxial interaction. As the group X gets larger, this interaction becomes more severe and there is less of the conformer with the group axial. The second reason is that

in the equatorial conformer the C–X bond is anti-periplanar to two C–C bonds, while, for the axial conformer, the C–X bond is synclinal (gauche) to two C–C bonds.

equatorially substituted cyclohexane:

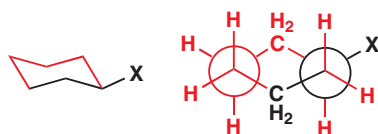

the black bonds are anti-periplanar (only one pair shown for clarity)

axially substituted cyclohexane:

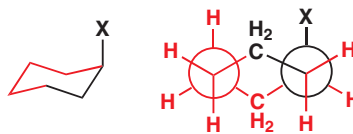

the black bonds are synclinal (gauche) (only one pair shown for clarity)

The table shows the preference of a number of substituted cyclohexanes for the equatorially substituted conformer over the axially substituted conformer at 25 °C.

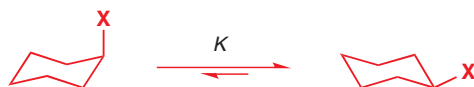

$$K = \frac{\text{concentration of equatorial conformer}}{\text{concentration of axial conformer}}$$

X	Equilibrium constant, K	Energy difference between axial and equatorial conformers, kJ mol^{-1}	Percentage with substituent equatorial
H	1	0	50
OMe	2.7	2.5	73
Me	19	7.3	95
Et	20	7.5	95
<i>i</i> -Pr	42	9.3	98
<i>t</i> -Bu	>3000	>20	>99.9
Ph	110	11.7	99

Note the following points (also referred to in Chapter 12).

- The three columns in the table are three different ways of expressing the same information. However, just looking at the percentages column, it is not immediately obvious to see how much more of the equatorial conformer there is—after all, the percentages of equatorial conformer for methyl, ethyl, isopropyl, *t*-butyl, and phenylcyclohexanes are all 95% or more. Looking at the equilibrium constants gives a much clearer picture.
- The amount of equatorial conformer present does increase in the order $\text{Me} < \text{Et} < i\text{-Pr} < t\text{-Bu}$, but perhaps not quite as expected. The ethyl group *must* be physically larger than a methyl group but there is hardly any difference in the equilibrium constants. The increase in the proportion of equatorial conformer on going from Et to *i*-Pr is only a factor of two, but for *t*-butylcyclohexane it is estimated that there is about 3000 times more of the equatorial conformer than the axial conformer.
- The same anomaly occurs with the methoxy group—there is a much greater proportion of the conformer with a methoxy group axial than with a methyl group axial. This is despite the fact that a methoxy group is physically larger than a methyl group.
- The equilibrium constant does not depend on the actual size of the substituent, but rather its interaction with the neighbouring axial hydrogens. In the axial conformer of methylcyclohexane there is a direct interaction between the methyl group and the axial hydrogen atoms.
- In the case of the methoxy group, the oxygen acts as link and removes the methyl group away from the ring, lessening the interaction.

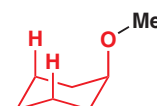
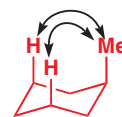

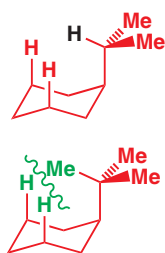

- The groups Me, Et, *i*-Pr, and *t*-Bu all need to point some atom towards the other axial hydrogens, and for Me, Et, and *i*-Pr this can be H.
- Only for *t*-Bu must a methyl group be pointing straight at the axial hydrogens, so *t*-Bu has a much larger preference for the equatorial position than the other alkyl groups. In fact, the interactions between an axial *t*-Bu group and the axial hydrogen atoms are so severe that the group virtually always stays in the equatorial position. As we shall see later, this can be very useful.

What happens with more than one substituent on the ring?

When there are two or more substituents on the ring, stereoisomerism is possible. For example, there are two isomers of 1,4-cyclohexanediol—in one (the *cis* isomer) both the substituents are either above or below the cyclohexane ring; in the other (the *trans* isomer) one hydroxyl group is above the ring whilst the second is below. For a *cis* 1,4-disubstituted cyclohexane with both the substituents the same, ring inversion leads to a second identical conformation, while for the *trans* configuration there is one conformation with both groups axial and one with both groups equatorial.

■ Ring inversion interconverts all of the axial and equatorial substituents, but it does not change which face of the ring a substituent is on. If an equatorial substituent starts off above the ring (that is, 'up' relative to its partner on the same C atom) it will end up above the ring, but now axial. Axial and equatorial are *conformational* terms; which side of the ring a substituent is on depends on the compound's *configuration*.

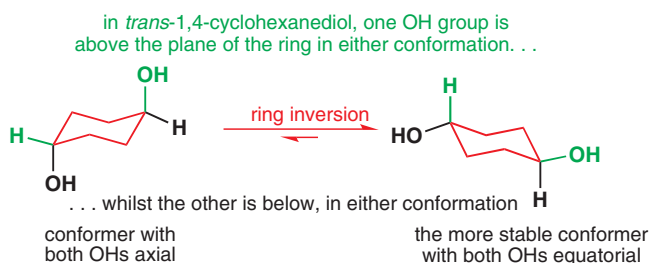
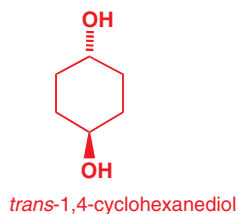
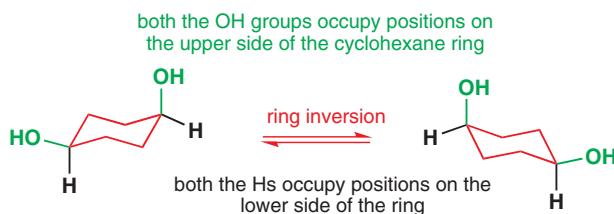
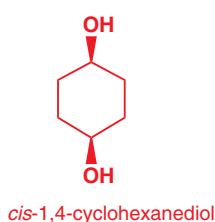

■ The *cis* and *trans* compounds are different diastereoisomers. Consequently, they have different chemical and physical properties and cannot interconvert simply by rotating bonds.

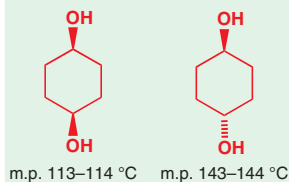

This contrasts with the two conformers of *trans*-1,4-hydroxycyclohexane (diaxial or diequatorial), which rapidly interconvert at room temperature without breaking any bonds.

The chair-structure diagrams contain much more information than the simple 'hexagon' diagrams that we have used up to now. The former show both configuration and conformation—they show which stereoisomer (*cis* or *trans*) we are talking about and also (for the *trans* compound) the conformation adopted (diaxial or the more stable diequatorial). In contrast, the simpler hexagon diagrams carry no information about the conformation—only information about which isomer we are dealing with. This can be useful because it enables us to talk about one configuration of a compound without specifying the conformation. When you are solving a problem requiring conformational diagrams to predict the configuration of a product, always start and finish with a configurational (hexagon) drawing.

The chair conformer of *cis*-1,4-disubstituted cyclohexane has one substituent equatorial, the other axial. This will not necessarily be the case for other substitution patterns, for example the chair conformer of a *cis*-1,3-disubstituted cyclohexane has either both substituents axial or both equatorial. Remember, the '*cis*' and '*trans*' prefixes merely indicate that both groups are on the same 'side' of the cyclohexane ring. Whether the substituents are both axial/equatorial or one axial and the other equatorial depends on the substitution pattern. Each time you meet a molecule, draw the conformation or make a model to find out which bonds are axial and which are equatorial.

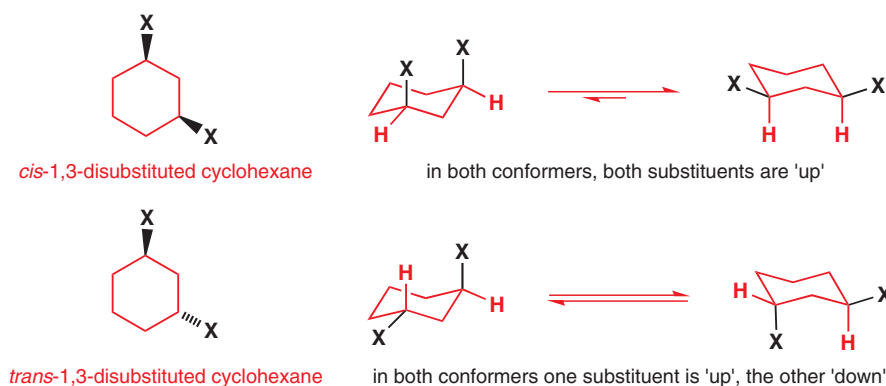

■ It is not always easy to decide if an equatorial substituent is 'up' or 'down'. The key is to compare it with its axial partner on the same C atom—axial substituents very clearly point 'up' or 'down'. If the axial partner is 'up', the equatorial substituent must be 'down' and vice versa.

What if the two substituents on the ring are different? For the *cis*-1,3-disubstituted example above, there is no problem because the favoured conformation will still be the one that places these two different substituents equatorial. But when one substituent is axial and the other equatorial (as they happen to be in the *trans* diastereoisomer above) the preferred conformation will depend on what those substituents are. In general, the favoured conformation will place the maximum number of substituents equatorial. If both conformations have the same number of equatorial substituents, the one with the larger substituent equatorial will win out, and the smaller group will be forced to be axial. Various possibilities are included in the examples below.

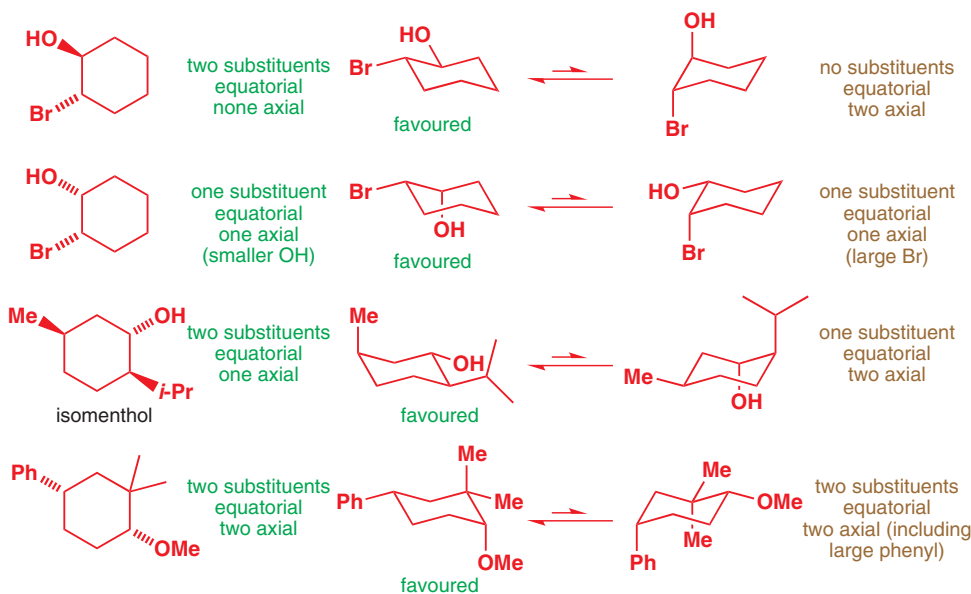

This is only a guideline, and in many cases it is not easy to be sure. Instead of concerning ourselves with these uncertainties, we shall move on to some differentially substituted cyclohexanes for which it is absolutely certain which conformer is preferred.

Locking groups—*t*-butyl groups, decalins, and steroids

We have already seen how a *t*-butyl group always prefers an equatorial position in a ring. This makes it very easy to decide which conformation the two different compounds below will adopt.

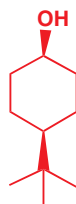
cis-4-*t*-butylcyclohexanol

in the *cis* diastereoisomer, the hydroxyl group is forced into an axial position

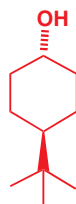

in both compounds, the *t*-butyl group is equatorial

trans-4-*t*-butylcyclohexanol

in the *trans* diastereoisomer, the hydroxyl group is forced into an equatorial position

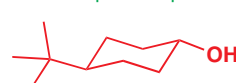

in both compounds, the *t*-butyl group is equatorial

Cis-1,4-di-*t*-butylcyclohexane

An axial *t*-butyl group really is very uncomfortable. In *cis*-1,4-di-*t*-butylcyclohexane, one *t*-butyl group would be forced axial if the compound existed in a chair conformation. To avoid this, the compound prefers to pucker into a twist-boat so that the two large groups can both be in equatorial positions (or 'pseudoequatorial', since this is not a chair).

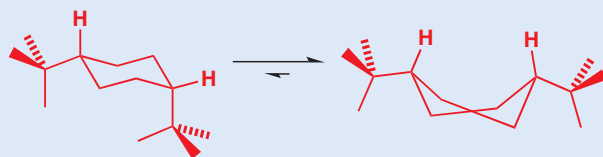
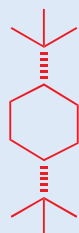
cis-1,4-di-*t*-butylcyclohexane

the twist-boat conformer (with both *t*-butyl groups in pseudoequatorial positions) is lower in energy than the chair conformer.

Decalins

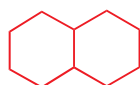

decalin

It is also possible to lock the conformation of a cyclohexane ring by joining another ring to it. Decalin is two cyclohexane rings fused at a common C–C bond. Two diastereoisomers are possible, depending on whether the hydrogen atoms at the ring junction are *cis* or *trans*. For *cis*-decalin, the second ring has to join the first so that it is axial at one point of attachment and equatorial at the other; for *trans*-decalin, the second ring can be joined to the first in the equatorial position at both attachment points.

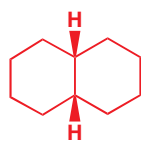
*cis*-decalin

this bond is equatorial on the black ring

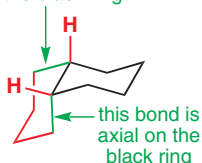

this bond is axial on the black ring

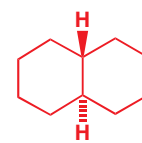
*trans*-decalin

both green bonds are equatorial on the black ring

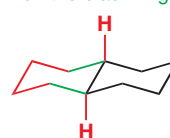

Interactive conformations of decalins

When a cyclohexane ring inverts, the substituents that were equatorial become axial and vice versa. This is fine for *cis*-decalin, which has an axial–equatorial junction, but it means that ring inversion is not possible for *trans*-decalin. For *trans*-decalin to invert, the junction would have to become axial–axial, and it's not possible to link the axial positions to form a six-membered ring. *Cis*-decalin, on the other hand, ring inverts easily.

Flipping *cis*-decalin: not so difficult once you know how

If you find it hard to visualize the ring inversion of *cis*-decalin, you are not alone! The best way to think about it is to ignore the second ring until the very end: just concentrate on what happens to one ring (black in this diagram), the hydrogens at the ring junction, and the (orange) bonds next to these hydrogens that form the 'stumps' of the second ring. Flip the black ring, and the 'stumps', and the hydrogens swap from axial to equatorial and vice versa. Draw the result, but don't fill in the second ring yet or it will usually just come out looking like a flat hexagon (as in diagram A). Instead, rotate the complete (black) ring 60° about a vertical axis so that both of the orange 'stumps' can form part of a chair, which can now be filled in (diagram B). To make a chair (and not a hexagon) they must be pointing in a convergent direction, as the orange bonds are in B but not A.

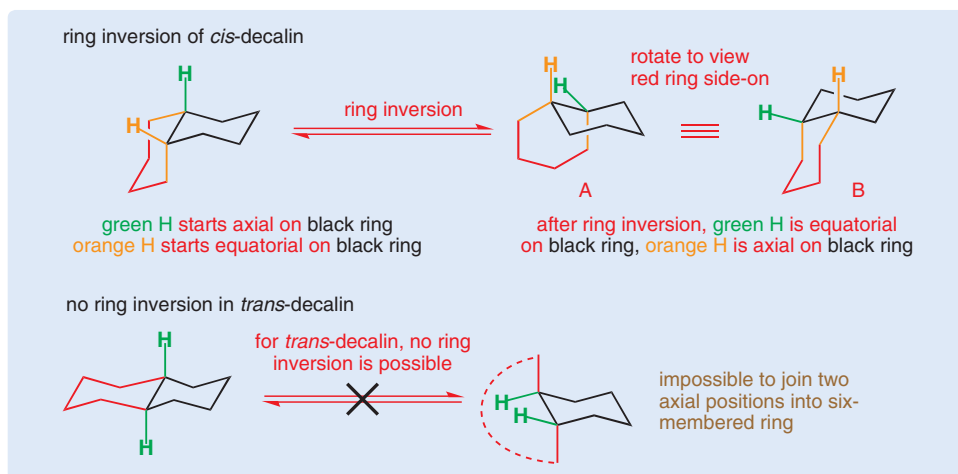

Interactive ring inversion of *cis*-decalin

Steroids

Steroids are an important class of compounds occurring in all animals and plants, which have many important functions from regulating growth (anabolic steroids) and sex drive (all sex hormones are steroids) to acting as a self-defence mechanism in plants, frogs, and even sea cucumbers. A steroid is defined by its structure: all steroids contain a basic carbon framework consisting of four fused rings—three cyclohexane rings and one cyclopentane ring—labelled and joined together as shown in the margin.

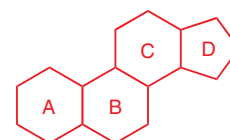

the steroid skeleton

Just as in the decalin system, each ring junction could be *cis* or *trans*, but it turns out that all steroids have all *trans*-junctions except where rings A and B join, which is sometimes *cis*. Examples are cholesterol (all *trans*) and coprostanol (A and B fused *cis*).

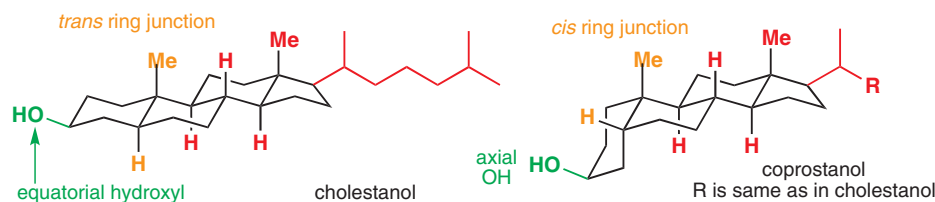

Because steroids (even those with a *cis* A–B ring junction) are essentially substituted *trans*-decalins, they can't ring-flip. This means, for example, that the hydroxyl group in cholesterol is held equatorial on ring A while the hydroxyl group in coprostanol is held axial on ring A. The steroid skeleton really is remarkably stable—samples of sediment 1.5×10^9 years old have been found to contain steroids still with the same ring-junction stereochemistry.

Axially and equatorially substituted rings react differently

We shall be using ring structures throughout the rest of the book, and you will learn how their conformation affects their chemistry extensively. In many reactions of six-membered rings, the outcome may depend on whether a functional group is axial or equatorial. We shall conclude this chapter with two examples in which a functional group will be held in its axial or equatorial position by 'locking' the ring using a *t*-butyl group or a fused ring system such as *trans*-decalin.

In the last chapter we looked at two mechanisms for nucleophilic substitution: S_N1 and S_N2 . We saw that the S_N2 reaction involved an inversion at the carbon centre. Recall that the incoming nucleophile had to attack the σ^* orbital of the C–X bond. This meant that it had to approach the leaving group directly from behind, leading to inversion of configuration.

It was a desire to explain the reactions of steroids that led Sir Derek Barton (1918–98) to discover, in the 1940s and 1950s, the principles of conformational analysis described in this chapter. It was for this work that he shared the Nobel Prize for Chemistry in 1969.

■ These locking groups work because the *t*-butyl group can never be axial (p. 375) and the *trans*-decalin can never ring-flip (p. 378).

inversion during nucleophilic substitution at saturated carbon

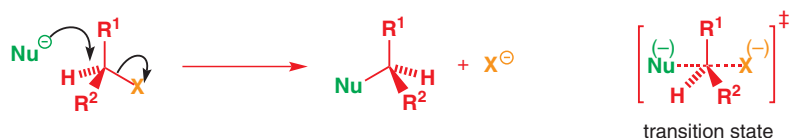

What do you think would happen if a cyclohexane derivative underwent an S_N2 reaction? If the conformation of the molecule is fixed by a locking group, the inversion mechanism of the S_N2 reaction means that, if the leaving group is axial, then the incoming nucleophile will end up equatorial and vice versa.

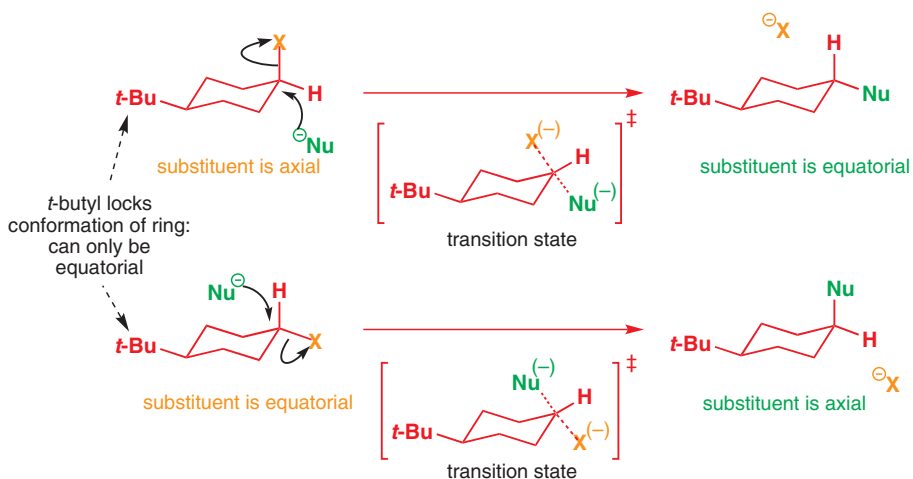

Substitution reactions are not very common for substituted cyclohexanes. The electrophilic carbon in a cyclohexane ring is a secondary centre—in the last chapter we saw that secondary centres do not react well via either S_N1 or S_N2 mechanisms (p. 347). To encourage an S_N2 mechanism, we need a good attacking nucleophile and a good leaving group. One such example is shown—the substitution of tosylate by PhS^- .

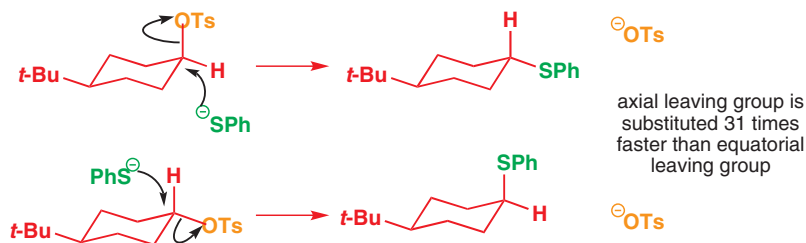

The substitution of an axial substituent proceeds faster than the substitution of an equatorial substituent. There are several contributing factors making up this rate difference, but the most important is the direction of approach of the nucleophile. The nucleophile must attack the σ^* of the leaving group, that is, directly behind the C–X bond. In the case of an equatorially substituted compound, this line of attack is hindered by the (green) axial hydrogens—it passes directly through the region of space they occupy. For an axial leaving group, the direction of attack is parallel with the (orange) axial hydrogens anti-periplanar to the leaving group, and approach is much less hindered.

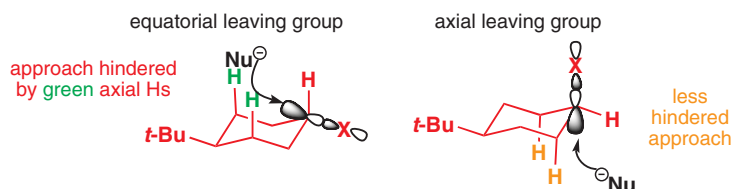

We must assume that this holds even for simple unsubstituted cyclohexanes, and that substitution reactions of cyclohexyl bromide, for example, occur mainly on the minor, axial conformer. This slows down the reaction because before it can react, the prevalent equatorial conformer must first flip to the axial.

If this flip to an axial leaving group is not possible, it may be that the reaction just won't happen at all. This is exactly what happens in a *trans*-decalin. There are two diastereoisomers of this simple substituted *trans*-decalin: one with an equatorial and one with an axial leaving group (X could be Br, OTs, etc.).

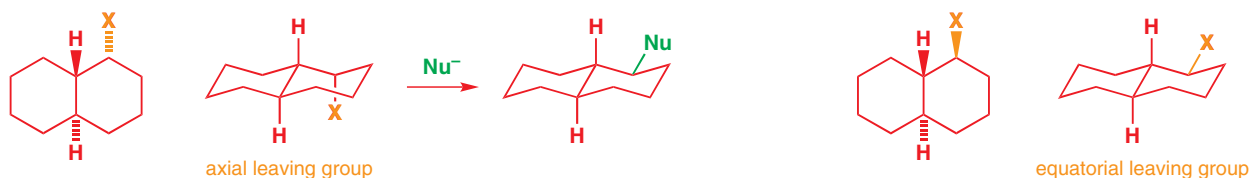

Attack by a nucleophile on the compound with the axial leaving group is straightforward. The nucleophile can approach along the axis of the C–X bond and normal S_N2 reaction occurs with inversion—the product is the equatorial compound. The equatorial leaving group, on the other hand, would require the nucleophile to approach through the middle of the molecule and that cannot be achieved. A totally different reaction occurs—a rearrangement that you will meet in Chapter 36.

To conclude...

You may wonder why we have spent most of this chapter looking at six-membered rings, ignoring other ring sizes almost totally. Apart from the fact that six is the most widespread ring size in organic chemistry, the reactions of six-membered rings are also the easiest to explain and to understand. The conformational principles we have outlined for six-membered rings (relief of ring strain, staggered favoured over eclipsed, equatorial favoured over axial, direction of attack) hold, in modified form, for other ring sizes as well. These other rings are less well behaved than six-membered rings because they lack the well-defined strain-free conformations that cyclohexane is blessed with. We shall now leave stereochemistry in rings for some time, but we come back to these more difficult rings—and how to tame them—in two chapters on stereochemistry in cyclic compounds, Chapters 31 and 32.

Further reading

A major resource for conformation is E. L. Eliel and S. H. Wilen, *Stereochemistry of Organic Compounds*. Wiley, New York, 1994.

For a more detailed analysis of reasons for the conformational preferences of alkanes, see V. Pophristic and L. Goodman, *J. Phys. Chem. A*, 2002, 106, 1642–1646.

Check your understanding



To check that you have mastered the concepts presented in this chapter, attempt the problems that are available in the book's Online Resource Centre at <http://www.oxfordtextbooks.co.uk/orc/clayden2e/>

17

Elimination reactions

Connections

➔ Building on

- Stereochemistry **ch14**
- Mechanisms of nucleophilic substitution at saturated carbon **ch15**
- Conformation **ch16**

Arriving at

- Elimination reactions
- What factors favour elimination over substitution
- The three important mechanisms of elimination reactions
- The importance of conformation in elimination reactions
- How to use eliminations to make alkenes (and alkynes)

➔ Looking forward to

- Electrophilic additions to alkenes (the reverse of the reactions in this chapter) **ch19**
- How to control double-bond geometry **ch27**

Substitution and elimination

➔ Remember the turnstiles at the railway station (see p. 332).

Substitution reactions of *t*-butyl halides, you will recall from Chapter 15, invariably follow the S_N1 mechanism. In other words, the rate-determining step of their substitution reactions is unimolecular—it involves only the alkyl halide. This means that, no matter what the nucleophile is, the reaction goes at the same rate. You can't speed this S_N1 reaction up, for example, by using hydroxide instead of water, or even by increasing the concentration of hydroxide. You'd be wasting your time, we said (see p. 332).

nucleophilic substitution reactions of *t*-BuBr

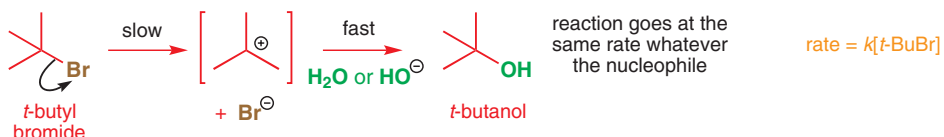

You'd also be wasting your alkyl halide. This is what actually happens if you try the substitution reaction with a *concentrated* solution of sodium hydroxide.

reaction of *t*-BuBr with concentrated solution of NaOH

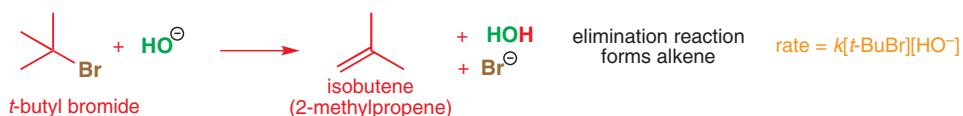

Online support. The icon  in the margin indicates that accompanying interactive resources are provided online to help your understanding: just type www.chemtube3d.com/clayden/123 into your browser, replacing **123** with the number of the page where you see the icon. For pages linking to more than one resource, type **123-1**, **123-2** etc. (replacing **123** with the page number) for access to successive links.

The reaction stops being a substitution and an alkene is formed instead. Overall, HBr has been lost from the alkyl halide, and the reaction is called an **elimination**.

In this chapter we will talk about the mechanisms of elimination reactions—as in the case of substitutions, there is more than one mechanism for eliminations. We will compare eliminations with substitutions—either reaction can happen from almost identical starting materials, and you will learn how to predict which is the more likely. Much of the mechanistic discussion relates very closely to Chapter 15, and we suggest that you make sure you understand all of the points in that chapter before tackling this one. This chapter will also tell you about uses for elimination reactions. Apart from a brief look at the Wittig reaction in Chapter 11, this is the first time you have met a way of making simple alkenes.

Elimination happens when the nucleophile attacks hydrogen instead of carbon

The elimination reaction of *t*-butyl bromide happens because the nucleophile is *basic*. You will recall from Chapter 10 that there is *some* correlation between basicity and nucleophilicity: strong bases are usually good nucleophiles. Being a good nucleophile doesn't get hydroxide anywhere in the substitution reaction because it doesn't appear in the first-order rate equation. But being a good base does get it somewhere in the elimination reaction because hydroxide is involved in the rate-determining step of the elimination, and so it appears in the rate equation. This is the mechanism.

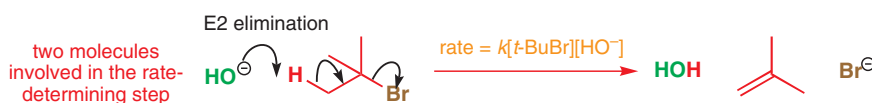

The hydroxide is behaving as a base because it is attacking the hydrogen atom, instead of the carbon atom it would attack in a substitution reaction. The hydrogen atom is not acidic, but proton removal can occur because bromide is a good leaving group. As the hydroxide attacks, the bromide is forced to leave, taking with it the negative charge. Two molecules—*t*-butyl bromide and hydroxide—are involved in the rate-determining step of the reaction. This means that the concentrations of both appear in the rate equation, which is therefore second-order and this mechanism for elimination is termed E2, for *elimination, bimolecular*.

$$\text{rate} = k_2 [\text{t-BuBr}][\text{HO}^-]$$

Now let's look at another sort of elimination. We can approach it again by thinking about another $\text{S}_{\text{N}}1$ substitution reaction, the reverse of the one at the beginning of the chapter: an alcohol is converted into an alkyl halide.

nucleophilic substitution of *t*-BuOH with HBr

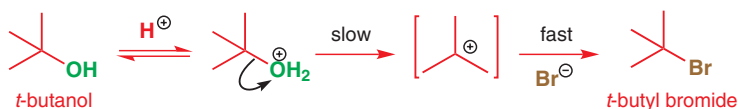

Bromide, the nucleophile, is not involved in the rate-determining step, so we know that the rate of the reaction will be independent of the concentration of Br^- . Indeed the first step, to form the cation, will happen just as fast even if there is *no bromide at all*. But what happens to the carbocation in such a case? To find out, we need to use an acid whose counterion is such a weak nucleophile that it won't even attack the positive carbon of the carbocation. Here is an example—*t*-butanol in sulfuric acid doesn't undergo substitution, but undergoes elimination instead.

■ The correlation between basicity and nucleophilicity is best for attack at $\text{C}=\text{O}$. In Chapter 15 you met examples of nucleophiles that are good at substitution at saturated carbon (such as I^- , Br^- , PhS^-) but that are not strong bases.

■ Note: No subscripts or superscripts, just plain old E2.

Interactive E1 elimination mechanism

E1 elimination of *t*-BuOH in H₂SO₄

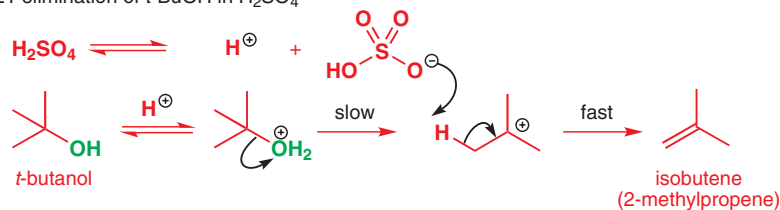

The HSO₄⁻ anion is not involved in the rate-determining formation of the carbocation, and is also a very bad nucleophile, so it does not attack the C atom of the carbocation. Neither is it basic, but you can see from the mechanism that it does behave as a base (that is, it removes a proton). It does this only because it is even more feeble as a nucleophile. The rate equation will not involve the concentration of HSO₄⁻, and the rate-determining step is the same as that in the S_N1 reaction—unimolecular loss of water from the protonated *t*-BuOH. This elimination mechanism is therefore called E1.

We will shortly come back to these two mechanisms for elimination, plus a third, but it is worth noting at this stage that the choice between E1 and E2 is not based on the same grounds as the choice between S_N1 and S_N2: you have just seen both E1 and E2 elimination from a substrate that would only undergo S_N1. The difference between the two reactions was the strength of the base, so first we need to answer the question: when does a nucleophile start behaving as a base?

Elimination in carbonyl chemistry

We have left detailed discussion of the formation of alkenes until this chapter, but we used the term ‘elimination’ in Chapters 10 and 11 to describe the loss of a leaving group from a tetrahedral intermediate. For example, the final steps of acid-catalysed ester hydrolysis involve E1 elimination of ROH to leave a double bond: C=O rather than C=C.

E1 elimination of ROH during ester hydrolysis

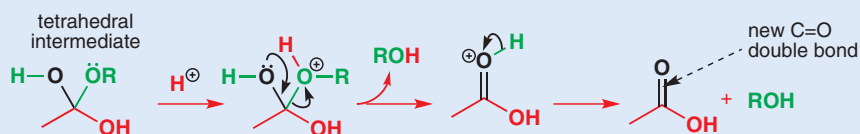

In Chapter 11 you even saw an E1 elimination giving an alkene. That alkene was an enamine—here is the reaction.

E1 elimination of H₂O during enamine formation

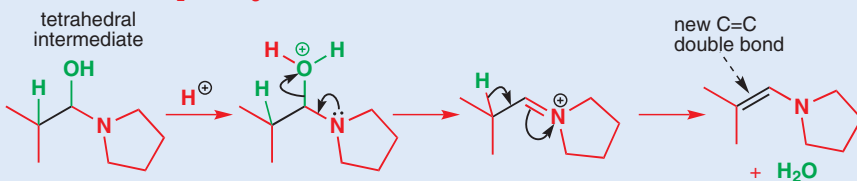

How the nucleophile affects elimination versus substitution

Basicity

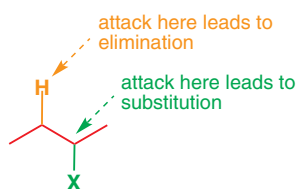

You have just seen molecules bearing leaving groups being attacked at two distinct electrophilic sites: the carbon to which the leaving group is attached, and the hydrogen atoms on the carbon adjacent to the leaving group. Attack at carbon leads to substitution; attack at hydrogen leads to elimination. Since strong bases attack protons, it is generally true that, the more basic the nucleophile, the more likely that elimination is going to replace substitution as the main reaction of an alkyl halide.

Here is an example of this idea at work: a weak base (EtOH) leads to substitution while a strong base (ethoxide ion) leads to elimination.

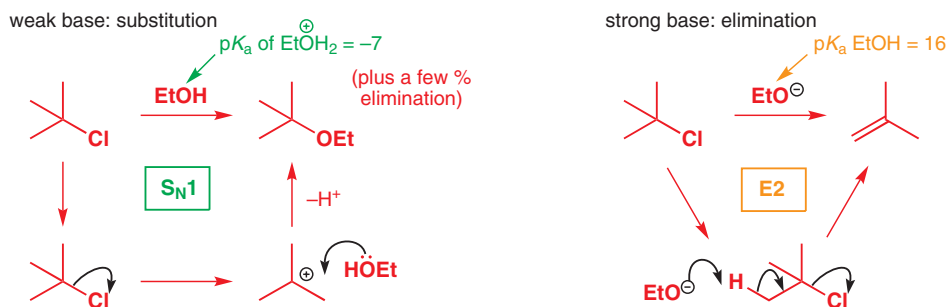

Elimination, substitution, and hardness

We can also rationalize selectivity for elimination versus substitution, or attack on H versus attack on C in terms of hard and soft electrophiles (p. 357). In an $\text{S}_{\text{N}}2$ substitution, the carbon centre is a soft electrophile—it is essentially uncharged, and with leaving groups such as halide the $\text{C}-\text{X}$ σ^* is a relatively low-energy LUMO. Substitution is therefore favoured by nucleophiles whose HOMOs are best able to interact with this LUMO—in other words soft nucleophiles. In contrast, the $\text{C}-\text{H}$ σ^* is higher in energy because the atoms are less electronegative. This, coupled with the hydrogen's small size, makes the $\text{C}-\text{H}$ bond a hard electrophilic site, and as a result hard nucleophiles favour elimination.

Size

For a nucleophile, attacking a carbon atom means squeezing past its substituents—and even for unhindered primary alkyl halides there is still one alkyl group attached. This is one of the reasons that $\text{S}_{\text{N}}2$ is so slow on hindered alkyl halides—the nucleophile has difficulty getting to the reactive centre. Getting at a more exposed hydrogen atom in an elimination reaction is much easier, and this means that, as soon as we start using basic nucleophiles that are also bulky, elimination becomes preferred over substitution, even for primary alkyl halides. One of the best bases for promoting elimination and avoiding substitution is potassium *t*-butoxide. The large alkyl substituent makes it hard for the negatively charged oxygen to attack carbon in a substitution reaction, but it has no problem attacking hydrogen.

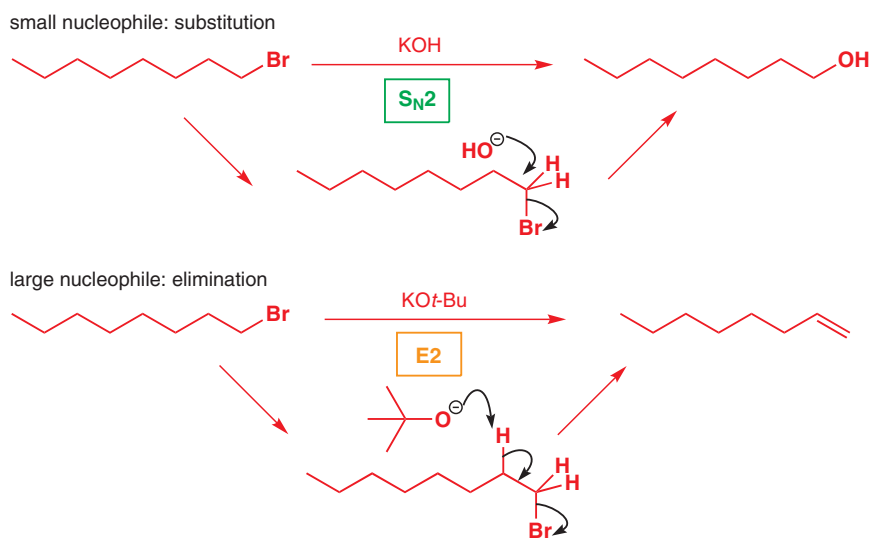

Temperature

Temperature has an important role to play in deciding whether a reaction is an elimination or a substitution. In an elimination, two molecules become three (count them). In a substitution, two molecules form two new molecules. The two reactions therefore differ in the change in entropy during the reaction: ΔS is greater for elimination than for substitution. In Chapter 12, we discussed the equation

■ This explanation is simplified because what matters is the rate of the reaction, not the stability of the products. A detailed discussion is beyond the scope of the book, but the general argument still holds.

$$\Delta G = \Delta H - T\Delta S$$

This equation says that a reaction in which ΔS is positive becomes more favourable (ΔG becomes more negative) at higher temperature. Eliminations should therefore be favoured at high temperature, and this is indeed the case: most eliminations you will see are conducted at room temperature or above.

➔ For a related example see Chapter 12, p. 247

● Elimination versus substitution

- Nucleophiles that are strong bases favour elimination over substitution.
- Nucleophiles (or bases) that are bulky favour elimination over substitution.
- High temperatures favour elimination over substitution.

E1 and E2 mechanisms

Now that you have seen a few examples of elimination reactions, it is time to return to our discussion of the two mechanisms for elimination. To summarize what we have said so far:

- E1 describes an elimination reaction (E) in which the rate-determining step is unimolecular (1) and does not involve the base. The leaving group leaves in this step, and the proton is removed in a separate second step.

general mechanism for E1 elimination

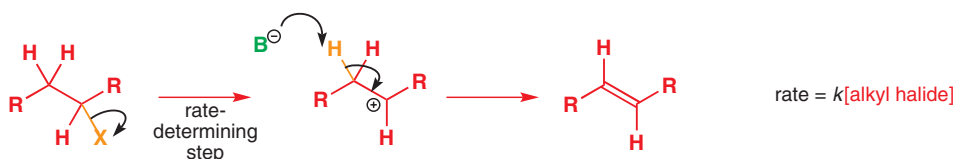

■ In E2 eliminations the loss of the leaving group and removal of the proton are **concerted**.

- E2 describes an elimination (E) that has a bimolecular (2) rate-determining step that must involve the base. Loss of the leaving group is simultaneous with removal of the proton by the base.

general mechanism for E2 elimination

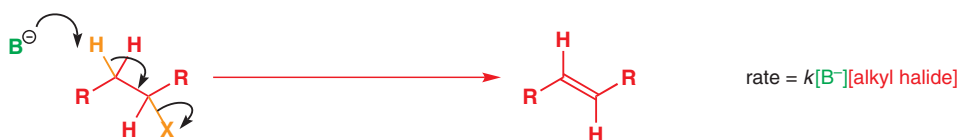

There are a number of factors that affect whether an elimination goes by an E1 or E2 mechanism. One is immediately obvious from the rate equations: only the E2 is affected by the concentration of base, so at high base concentration E2 is favoured. The rate of an E1 reaction is not even affected by what base is present—so E1 is just as likely with weak as with strong bases, while E2 goes faster with strong bases than weak ones: strong bases at whatever concentration will favour E2 over E1. If you see that a strong base is required for an elimination, it is certainly an E2 reaction. Take the first elimination in this chapter as an example.

reaction of *t*-butyl bromide with concentrated hydroxide



With less hindered alkyl halides hydroxide would not be a good choice as a base for an elimination because it is rather small and still very good at S_N2 substitutions (and even with tertiary alkyl halides, substitution outpaces elimination at low concentrations of hydroxide). So what are good alternatives?

We have already mentioned the bulky *t*-butoxide—ideal for promoting E2 as it's both bulky and a strong base (pK_a of *t*-BuOH = 18). Here it is at work converting a dibromide to a diene with two successive E2 eliminations. Since dibromides can be made from alkenes (you will see how in the next chapter), this is a useful two-step conversion of an alkene to a diene.

synthesis of a diene by a double E2 elimination

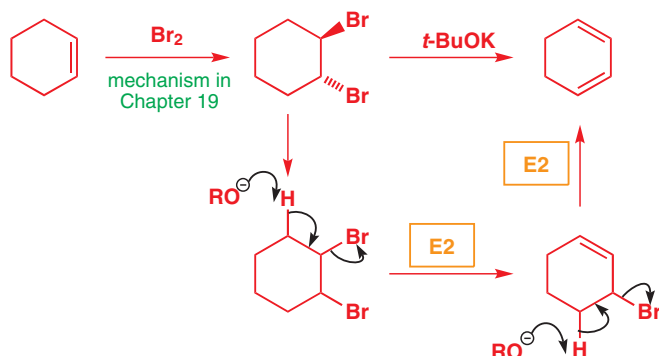

Interactive mechanism for double E2 to form diene

The product of the next reaction is a 'ketene acetal'. Unlike most acetals, this one can't be formed directly from ketene (ketene, $\text{CH}_2=\text{C}=\text{O}$, is too unstable), so instead the acetal is made by the usual method from bromoacetaldehyde and then HBr is eliminated using *t*-BuOK.

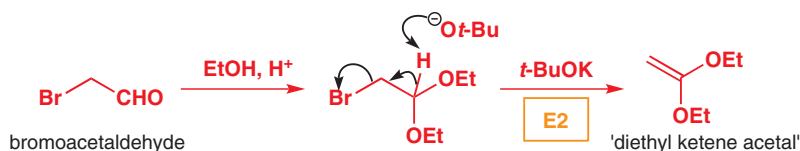

You will meet ketene, briefly, in the next chapter.

Among the most commonly used bases for converting alkyl halides to alkenes is one that you met in Chapter 8: DBU. This base is an amidine—delocalization of one nitrogen's lone pair onto the other, and the resulting stabilization of the protonated amidinium ion, makes it particularly basic, with a pK_a (of the protonated amidine) of about 12.5. There is not much chance of getting those voluminous fused rings into tight corners—so they pick off the easy-to-reach protons rather than attacking carbon atoms in substitution reactions.

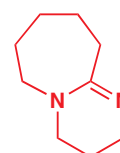

DBU

1,8-diazabicyclo-[5.4.0]undecene-7

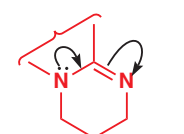

delocalization in the amidine system

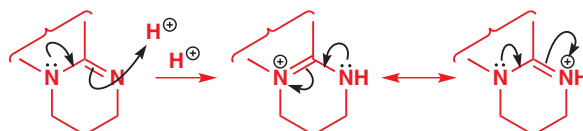

protonation of the amidine system

delocalization stabilizes the protonated amidinium ion

See p. 175 for more on DBU.

DBU will generally eliminate HX from alkyl halides to give alkenes. In these two examples, the products were used as intermediates in the synthesis of natural products.

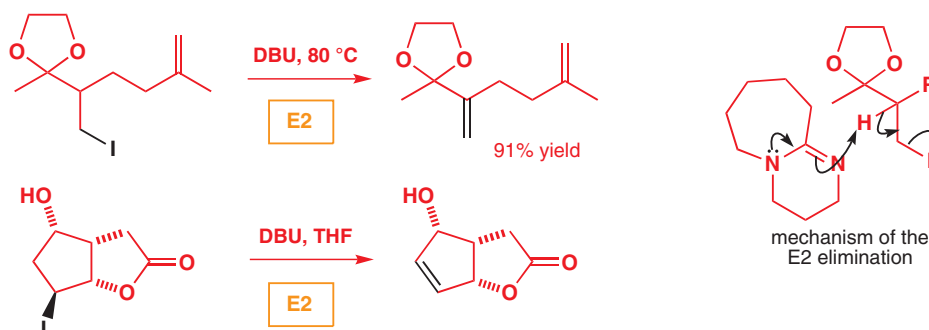

Note the use of high temperature to drive the elimination.

Substrate structure may allow E1

The first elimination of the chapter (*t*-BuBr plus hydroxide) illustrates something very important: the starting material is a tertiary alkyl halide and would therefore *substitute* only by S_N1 , but it can *eliminate* by either E2 (with strong bases) or E1 (with weak bases). The steric factors that disfavour S_N2 at hindered centres don't exist for eliminations. Nonetheless, E1 can occur *only* with substrates that can ionize to give relatively stable carbocations—tertiary, allylic, or benzylic alkyl halides, for example. Secondary alkyl halides may eliminate by E1, while primary alkyl halides only ever eliminate by E2 because the primary carbocation required for E1 would be too unstable. The chart below summarizes the types of substrate that can undergo E1—but remember that any of these substrates, under the appropriate conditions (in the presence of strong bases, for example), may also undergo E2. For completeness, we have also included in this chart three alkyl halides that cannot eliminate by either mechanism simply because they do not have any hydrogens to lose from carbon atoms adjacent to the leaving group.

substrates that readily eliminate by E1

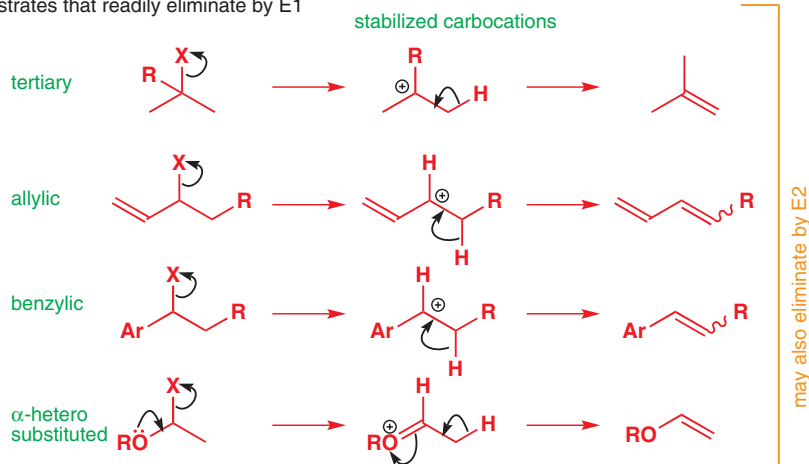

substrates that may eliminate by E1

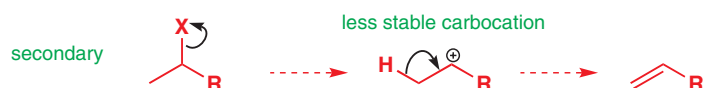

substrates that never eliminate by E1

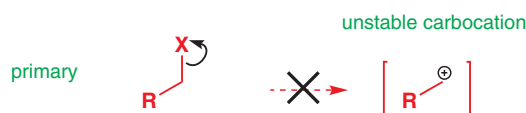

substrates that cannot eliminate by either mechanism—no appropriately placed hydrogens

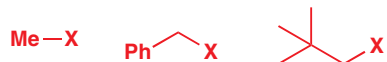

Can a proton just 'fall off' a cation?

In E1 mechanisms, once the leaving group has departed almost anything will serve as a base to remove a proton from the intermediate carbocation. Weakly basic solvent molecules (water or alcohols), for example, are quite sufficient, and you will often see the proton just 'falling off' in reaction mechanisms, with the assumption that there is a weak base somewhere to capture it. We showed the loss of a proton like this in the last example, and in the chart on this page.

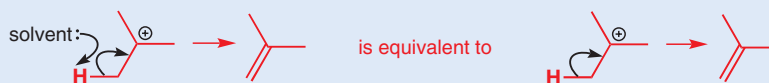

In very rare cases, such as the superacid solutions we described in Chapter 15 (p. 335), the cation is stable because counterions such as BF_4^- and SbF_6^- are not only non-nucleophilic but also so non-basic that they won't even accept a proton. This fact tells us that despite this common way of writing the E1 mechanism, *some* sort of weak base is necessary even for E1.

Polar solvents also favour E1 reactions because they stabilize the intermediate carbocation. E1 eliminations from alcohols in aqueous or alcohol solution are particularly common and very useful. An acid catalyst is used to promote loss of water, and in dilute H_2SO_4 , H_3PO_4 , or HCl the absence of good nucleophiles ensures that substitution does not compete. With phosphoric acid, for example, the secondary alcohol cyclohexanol gives cyclohexene.

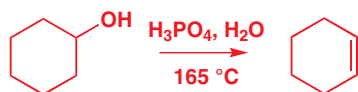

But the best E1 eliminations of all are with tertiary alcohols. The alcohols can be made using the methods of Chapter 9: nucleophilic attack by an organometallic on a carbonyl compound. Nucleophilic addition, followed by E1 elimination, is an excellent way of making this substituted cyclohexene, for example. Note that the proton required in the first step is recovered in the last—the reaction requires only catalytic amounts of acid.

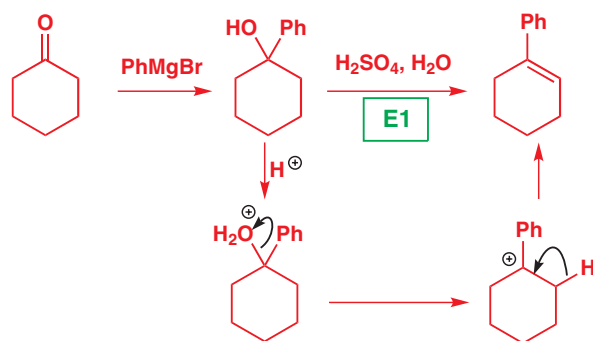

Cedrol is important in the perfumery industry—it has a cedar wood fragrance. Corey's synthesis includes this step—the acid (toluenesulfonic acid, see p. 227) catalyses both the E1 elimination and the hydrolysis of the acetal.

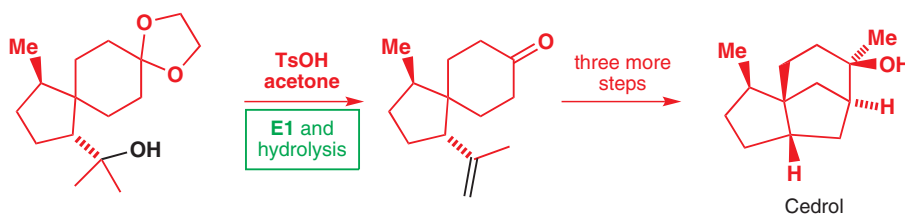

At the end of the last chapter you met some bicyclic structures. These sometimes pose problems for elimination reactions. For example, this compound will not undergo elimination by either an E1 or an E2 mechanism.

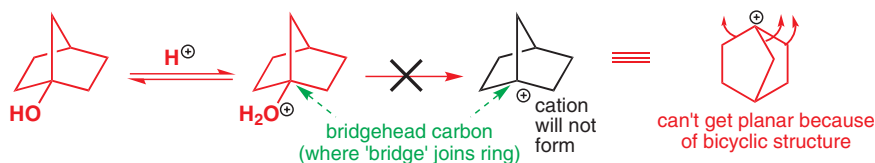

We shall see shortly what the problem with E2 is, but for E1 the hurdle to be overcome is the formation of a planar carbocation. The bicyclic structure prevents the bridgehead carbon becoming planar so, although the cation would be tertiary, it is very high in energy and does not form. You could say that the non-planar structure forces the cation to have an empty sp^3 orbital instead of an empty p orbital, and we saw in Chapter 4 that it is always best to leave the orbitals with the highest possible energy empty.

➔ On p. 335 (Chapter 15) you saw a related example of an impossible $\text{S}_{\text{N}}1$ reaction with a non-planar cation.

Bredt's rule

The impossibility of planar bridgehead carbons means that double bonds can almost never be formed to bridgehead carbons in bicyclic systems. This principle is known as Bredt's rule, but, as with all rules, it is much more important to know the reason than to know the name, and Bredt's rule is simply a consequence of the strain induced by a planar bridgehead carbon.

The role of the leaving group

We haven't yet been very adventurous with our choice of leaving groups for eliminations: all you have seen so far are E2 from alkyl halides and E1 from protonated alcohols. This is deliberate: the vast majority of the two classes of eliminations use one of these two types of starting materials. But since the leaving group is involved in the rate-determining step of both E1 and E2, in general any good leaving group will lead to a fast elimination. You may, for example, see amines acting as leaving groups in eliminations of quaternary ammonium salts.

eliminations from quaternary ammonium ions

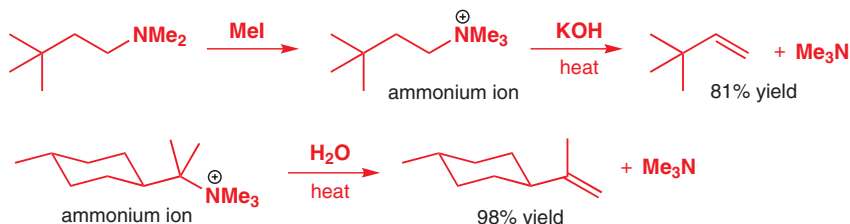

Both E1 and E2 are possible, and from what you have read so far you should be able to spot that there is one of each here: in the first example, a stabilized cation cannot be formed (so E1 is impossible), but a strong base is used, allowing E2. In the second, a stabilized tertiary cation could be formed (so *either* E1 or E2 might occur), but no strong base is present, so the mechanism must be E1.

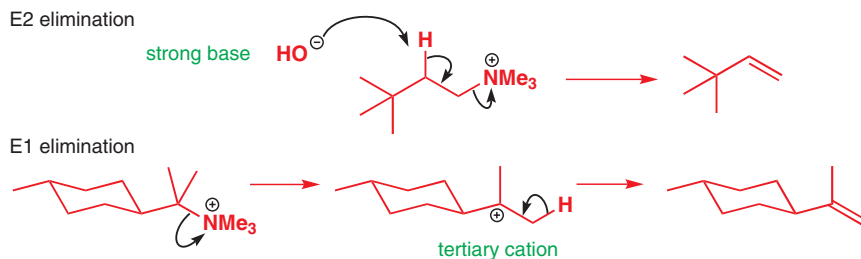

You have just seen that hydroxyl groups can be turned into good leaving groups in acid, but this is only useful for substrates that can react by E1 elimination. The hydroxyl group is *never* a leaving group in E2 eliminations, since they have to be done in base. A strong base would remove the proton from the OH group instead.

- **OH⁻ is never a leaving group in an E2 reaction.**

For primary and secondary alcohols, the hydroxyl is best made into a leaving group for elimination reactions by sulfonation with *para*-toluenesulfonyl chloride (tosyl chloride, TsCl) or methanesulfonyl chloride (mesyl chloride, MeSO₂Cl or MsCl).

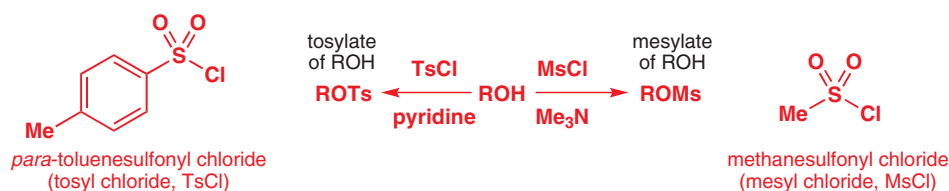

➔ You met the sulfonate esters—tosylates and mesylates—in Chapter 15 (p. 344).

Toluenesulfonate esters (tosylates) can be made from alcohols (with TsCl, pyridine). We introduced tosylates in Chapter 15 because they are good electrophiles for substitution reactions with *non-basic* nucleophiles. With strong bases such as *t*-BuOK, NaOEt, or DBU they undergo very efficient elimination reactions. Here are two examples.

E2 eliminations of tosylates



Methanesulfonyl esters (or mesylates; Chapter 15) can be eliminated using DBU, but a good way of using MsCl to convert alcohols to alkenes is to do the mesylation and elimination steps in one go, using the same base (Et_3N) for both. Here are two examples making biologically important molecules. In the first, the mesylate is isolated and then eliminated with DBU to give a synthetic analogue of uracil, one of the nucleotide bases present in RNA. In the second, the mesylate is formed and eliminated in the same step using Et_3N , to give a precursor to a sugar analogue.

➔ There is more about RNA bases and sugars in Chapter 42.

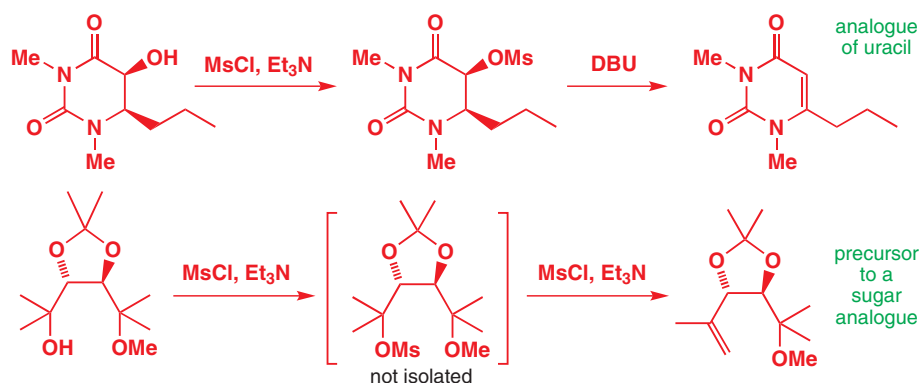

The second example here involves (overall) the elimination of a tertiary alcohol—so why couldn't an acid-catalysed E1 reaction have been used? The problem here, nicely solved by the use of the mesylate, is that the molecule contains an acid-sensitive acetal functional group. An acid-catalysed reaction would also have risked eliminating methanol from the other tertiary centre.

E1 reactions can be stereoselective

For some eliminations only one product is possible. For others, there may be a choice of two (or more) alkene products that differ either in the location or stereochemistry of the double bond. We shall now move on to discuss the factors that control the stereochemistry (geometry—*cis* or *trans*) and regiochemistry (that is, where the double bond is) of the alkenes, starting with E1 reactions.

only one alkene possible

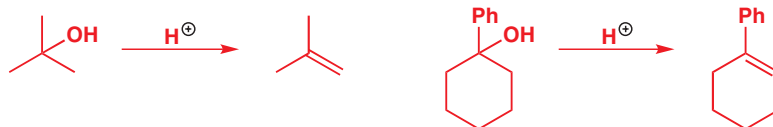

two regioisomeric alkenes possible

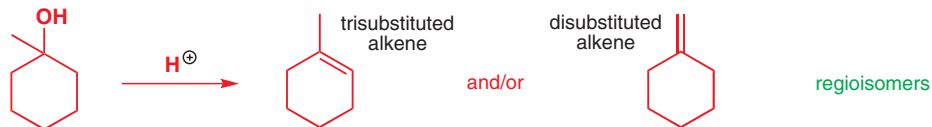

two stereoisomeric alkenes possible

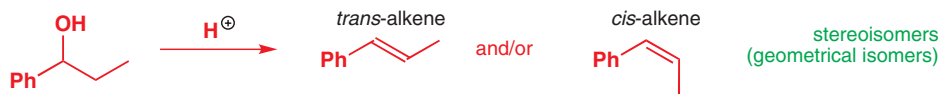

E and Z alkenes

You met the idea that alkenes can exist as geometrical *cis* and *trans* isomers in Chapters 3 and 7, and now that you have read Chapter 14 we can be more precise with our definitions. *cis* and *trans* are rather loosely defined terms (like *syn* and *anti*), although no less useful for it. But for formal assignment of geometry, we use the stereochemical descriptors *E* and *Z*. For disubstituted alkenes, *E* corresponds to *trans* and *Z* corresponds to *cis*. To assign *E* or *Z* to tri- or tetrasubstituted alkenes, the groups at either end of the alkene are given an order of priority according to the same rules as those outlined for *R* and *S* in Chapter 15. If the two higher priority groups are *cis*, the alkene is *Z*; if they are *trans* the alkene is *E*. Of course, molecules don't know these rules, and sometimes (as in the second example here) the *E* alkene is less stable than the *Z*.

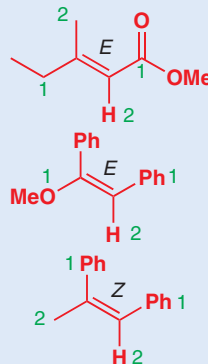

E alkenes (and transition states leading to *E* alkenes) are usually lower in energy than *Z* alkenes (and the transition states leading to them) for steric reasons: the substituents can get further apart from one another. A reaction that can choose which it forms is therefore likely to favour the formation of *E* alkenes. For alkenes formed by *E1* elimination, this is exactly what happens: the less hindered *E* alkene is favoured. Here is an example.

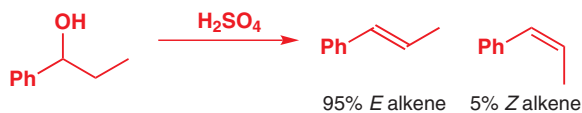

The geometry of the product is determined at the moment that the proton is lost from the intermediate carbocation. The new π bond can only form if the vacant p orbital of the carbocation and the breaking C–H bond are aligned parallel. In the example shown there are two possible conformations of the carbocation with parallel orientations, but one is more stable than the other because it suffers less steric hindrance. The same is true of the transition states on the route to the alkenes—the one leading to the *E* alkene is lower in energy, and more *E* alkene than *Z* alkene is formed. The process is stereoselective because the reaction chooses to form predominantly one of two possible stereoisomeric products.

► In Chapter 39 we shall discuss why the transition states for the decomposition of high-energy intermediates like carbocations are very similar in structure to the carbocations themselves.

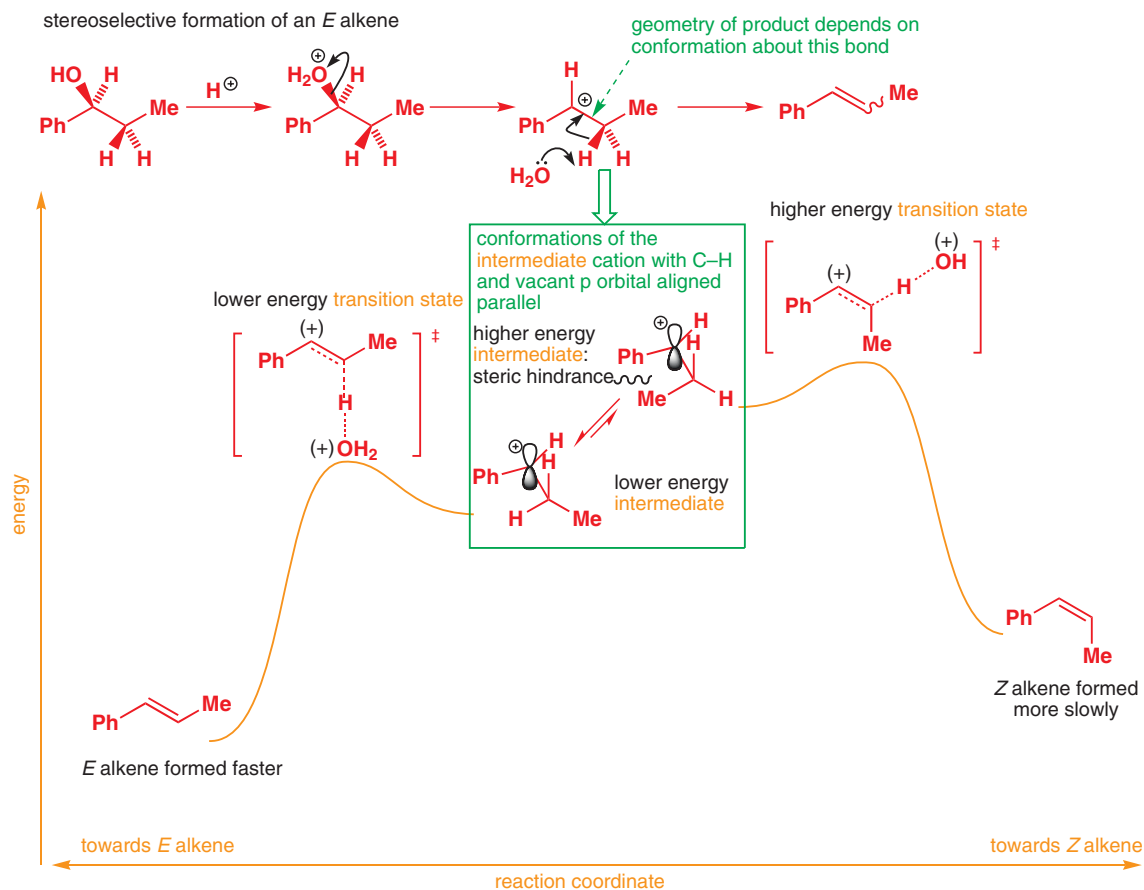

Tamoxifen

Tamoxifen is an important drug in the fight against breast cancer, one of the most common forms of cancer. It works by blocking the action of the female sex hormone oestrogen. The tetrasubstituted double bond can be introduced by an E1 elimination: there is no ambiguity about where the double bond goes, although the two stereoisomers form in about equal amounts. Tamoxifen is the *Z* isomer.

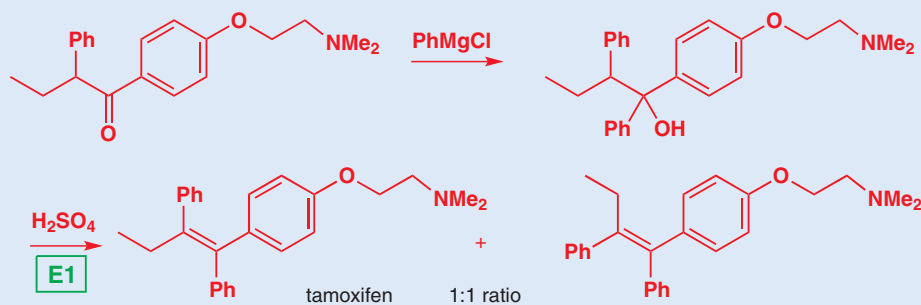

➔ We will come back to the most useful ways of controlling the geometry of double bonds in Chapter 27.

E1 reactions can be regioselective

We can use the same ideas when we think about E1 eliminations that can give more than one regioisomeric alkene. Here is an example. The major product is the alkene that has the more substituents because this alkene is the more stable of the two possible products.

- More substituted alkenes are more stable.

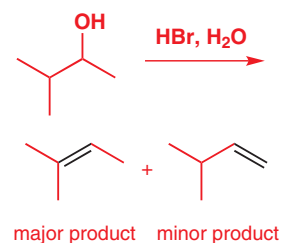

This is quite a general principle. But why should it be true? The reason for this is related to the reason why more substituted carbocations are more stable. In Chapter 15 we said that the carbocation is stabilized when its empty p orbital can interact with the filled orbitals of parallel C–H and C–C bonds. The same is true of the π system of the double bond—it is stabilized when the empty π^* antibonding orbital can interact with the filled orbitals of parallel C–H and C–C bonds. The more C–C or C–H bonds there are, the more stable the alkene.

■ This explanation of both stereo and regioselectivity in E1 reactions is based on *kinetic* arguments—which alkene forms faster. But it is also true that some E1 eliminations are reversible: the alkenes may be protonated in acid to re-form carbocations, as you will see in the next chapter. This reprotonation allows the more stable product to form preferentially under *thermodynamic* control. In any individual case, it may not be clear which is operating. However, with E2 reactions, which follow, only kinetic control applies: E2 reactions are never reversible.

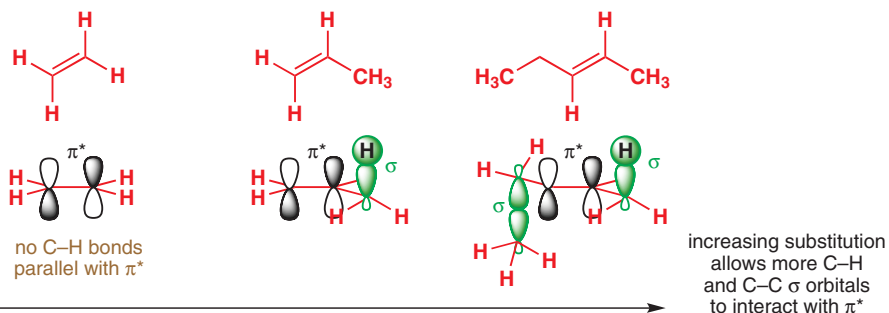

The more substituted alkene is more stable, but this does not necessarily explain why it is the one that forms faster. To do that, we should look at the transition states leading to the two alkenes. Both form from the same carbocation, but which one we get depends on which proton is lost. Removal of the proton on the right (brown arrow) leads to a transition state in which there is a monosubstituted double bond partly formed. Removal of the proton on the left (orange arrow) leads to a partial double bond that is trisubstituted. This is more stable—the transition state is lower in energy, and the more substituted alkene forms faster.

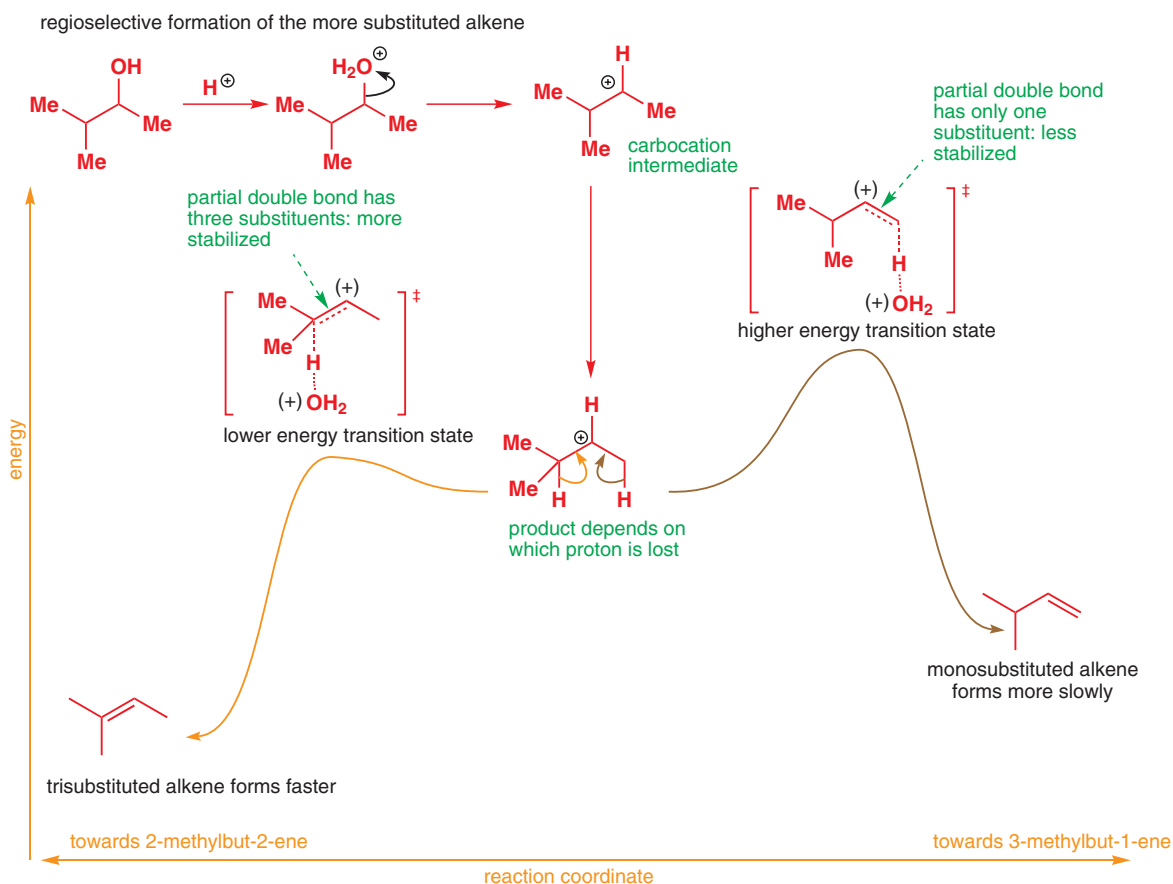

E2 eliminations have anti-periplanar transition states

Although E1 reactions show some stereo and regioselectivity, the level of selectivity in E2 reactions can be much higher because of the more stringent demands on the transition state for E2 elimination. In an E2 elimination, the new π bond is formed by overlap of the C–H σ bond with the C–X σ^* antibonding orbital. The two orbitals have to lie in the same plane for best overlap, and now there are two conformations that allow this. One has H and X syn-periplanar, the other anti-periplanar. The anti-periplanar conformation is more stable because it is staggered (the syn-periplanar conformation is eclipsed) but, more importantly, only in the anti-periplanar conformation are the bonds (and therefore the orbitals) truly parallel.

➔ Look back to p. 365 if you need reminding of the shapes of the conformations of C–C single bonds.

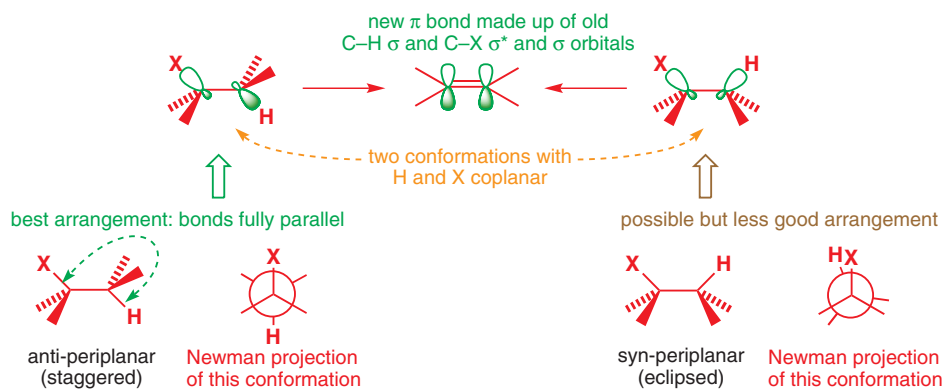

➔ Newman projections illustrate the conformation of molecules viewed along the length of a bond. See p. 364 if you need reminding of how to draw and interpret them.

E2 eliminations therefore take place preferentially from the anti-periplanar conformation. We shall see shortly how we know this to be the case, but first we consider an E2 elimination that gives mainly one of two possible stereoisomers. 2-Bromobutane has two conformations with H and Br anti-periplanar, but the one that is less hindered leads to more of the product, and the *E* alkene predominates.

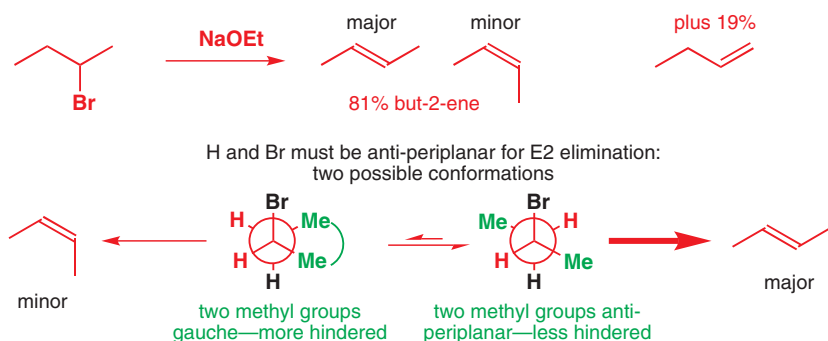

There is a choice of protons to be eliminated—the stereochemistry of the product results from which proton is anti-periplanar to the leaving group when the reaction takes place, and the reaction is stereoselective as a result.

Interactive mechanism for stereoselective E2

E2 eliminations can be stereospecific

In the next example there is only one proton that can take part in the elimination. Now there is no choice of anti-periplanar transition states. Whether the product is *E* or *Z*, the E2 reaction has only one course to follow. And the outcome depends on which diastereoisomer of the starting material is used. When the first diastereoisomer is drawn with the proton and

bromine anti-periplanar, as required, and in the plane of the page, the two phenyl groups have to lie one in front and one behind the plane of the paper. As the hydroxide attacks the C–H bond and eliminates Br^- , this arrangement is preserved and the two phenyl groups end up *trans* (the alkene is *E*). This is perhaps easier to see in the Newman projection of the same conformation.

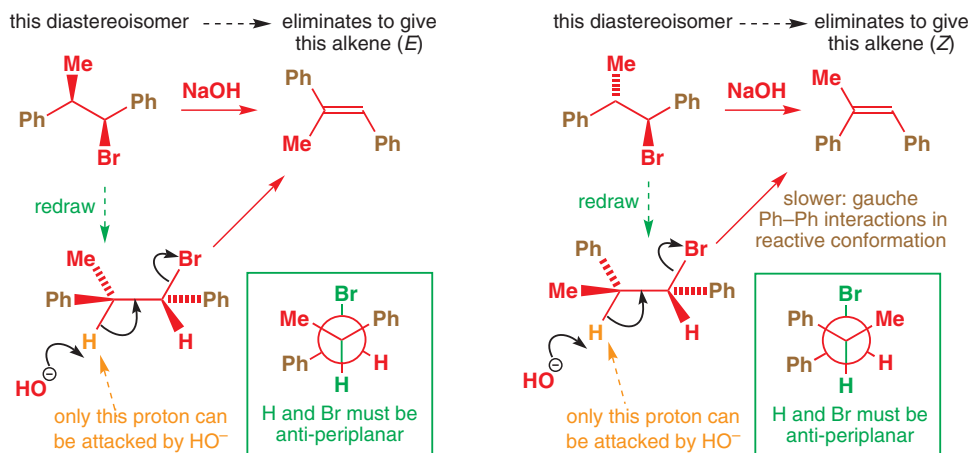

Interactive mechanism for stereospecific E2

The second diastereoisomer forms the *Z* alkene for the same reasons: the two phenyl groups are now on the same side of the H–C–C–Br plane in the reactive anti-periplanar conformation (again, this is clear in the Newman projection) and so they end up *cis* in the product. Each diastereoisomer gives a different alkene geometry, and they do so at different rates. The first reaction is about ten times as fast as the second because, although this anti-periplanar conformation is the only reactive one, it is not necessarily the most stable. The Newman projection for the second reaction shows clearly that the two phenyl groups have to lie synclinal (*gauche*) to one another: the steric interaction between these large groups will mean that, at any time, a relatively small proportion of molecules will adopt the right conformation for elimination, slowing the process down.

Reactions in which the stereochemistry of the product is determined by the stereochemistry of the starting material are called **stereospecific**.

■ A stereospecific reaction is not simply a reaction that is very stereoselective! The two terms have different mechanistic meanings, and are not just different degrees of the same thing.

● Stereoselective or stereospecific?

- **Stereoselective reactions** give one predominant product because the reaction pathway has a choice. Either the pathway of lower activation energy is preferred (kinetic control) or the more stable product is preferred (thermodynamic control).
- **Stereospecific reactions** lead to the production of a single isomer as a direct result of the mechanism of the reaction and the stereochemistry of the starting material. There is no choice. The reaction gives a different diastereoisomer of the product from each stereoisomer of the starting material.

E2 eliminations from cyclohexanes

The stereospecificity of the reactions you have just met is very good evidence that E2 reactions proceed through an anti-periplanar transition state. We know with which diastereoisomer we started, and we know which alkene we get, so there is no question over the course of the reaction.

More evidence comes from the reactions of substituted cyclohexanes. You saw in Chapter 16 that substituents on cyclohexanes can be parallel with one another only if they are both axial. An equatorial C–X bond is anti-periplanar only to C–C bonds and cannot take part in an elimination. For mono-substituted cyclohexyl halides treated with base, this is not a problem because, although the axial conformer is less stable, there is still a significant amount present (see the table on p. 375), and elimination can take place from this conformer.

➔ In the next chapter (p. 415) you will see how the fact that pairs of axial bonds have overlapping orbitals also gives rise to distinctively large ^1H NMR coupling constants.

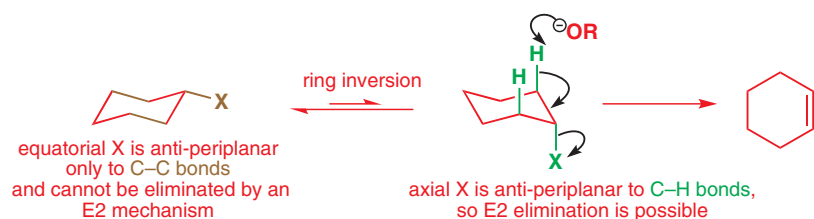

● For E2 elimination in cyclohexanes, both C-H and C-X must be axial.

These two diastereoisomeric cyclohexyl chlorides derived from menthol react very differently under the same conditions with sodium ethoxide as base. Both eliminate HCl but diastereoisomer A reacts rapidly to give a mixture of products, while diastereoisomer B (which differs only in the configuration of the carbon atom bearing chlorine) gives a single alkene product but very much more slowly. We can safely exclude E1 as a mechanism because the same cation would be formed from both diastereoisomers, and this would mean the ratio of products (although not necessarily the rate) would be the same for both.

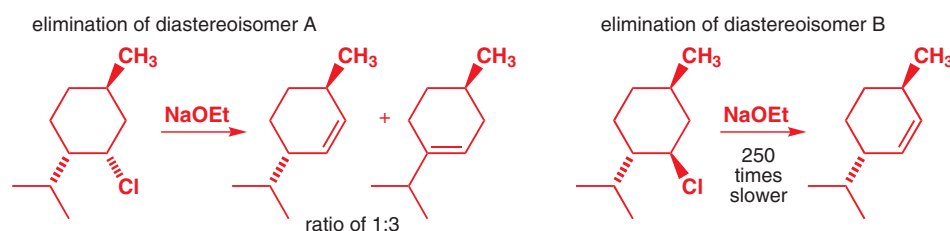

The key to explaining reactions like this is to draw the conformation of the molecules. Both will adopt a chair conformation, and generally the chair having the largest substituent equatorial (or the largest *number* of substituents equatorial) is the more stable. In these examples the isopropyl group is most influential—it is branched and will have very severe 1,3-diaxial interactions if it occupies an axial position. In both diastereoisomers, an equatorial *i*-Pr also means an equatorial Me: the only difference is the orientation of the chlorine. For diastereoisomer A, the chlorine is forced axial in the major conformer: there is no choice because the relative configuration is fixed in the starting material. It's less stable than equatorial Cl, but is ideal for E2 elimination and there are two protons that are anti-periplanar available for removal by the base. The two alkenes are formed as a result of each of the possible protons with a 3:1 preference for the more substituted alkene.

For diastereoisomer B, the chlorine is equatorial in the lowest-energy conformation. Once again there is no choice. But equatorial leaving groups cannot be eliminated by E2: in this conformation there is no anti-periplanar proton. This accounts for the difference in rate between the two diastereoisomers. A has the chlorine axial virtually all the time ready for E2, while B has an axial leaving group only in the minute proportion of the molecules that happen not to be in the lowest-energy conformation, but that have all three substituents axial. The all-axial conformer is much higher in energy, but only in this conformer can Cl⁻ be eliminated. The concentration of reactive molecules is low, so the rate is also low. There is only one proton anti-periplanar and so elimination gives a single alkene.

conformation of diastereoisomer A

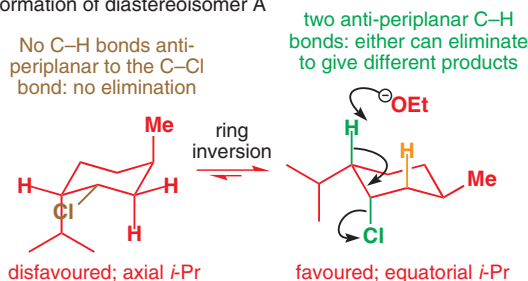

conformation of diastereoisomer B

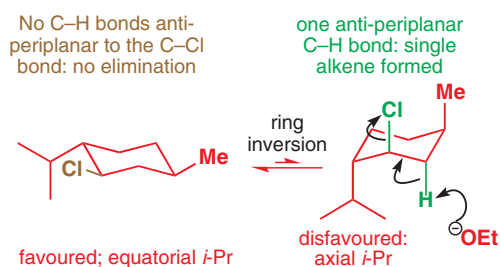

■ This would be a good time to make sure you can reliably sketch a cyclohexane in the chair conformation. Our guidelines for helping you do this are on pp. 371–2.

Interactive mechanism for diastereoisomer A

Interactive mechanism for diastereoisomer B

E2 elimination from vinyl halides: how to make alkynes

An anti-periplanar arrangement of C–Br and C–H is attainable with a vinylic bromide too, provided the Br and H are *trans* to one another. E2 elimination from the *Z* isomer of a vinyl bromide gives an alkyne rather faster than elimination from the *E* isomer because in the *E* isomer the C–H and C–Br bonds are syn-periplanar.

■ The base used here is LDA (lithium diisopropylamide) made by deprotonating *i*-Pr₂NH with BuLi (see p. 174). LDA is very basic (p*K*_a of *i*-Pr₂NH is about 35) but too hindered to be nucleophilic—ideal for promoting E2 elimination.

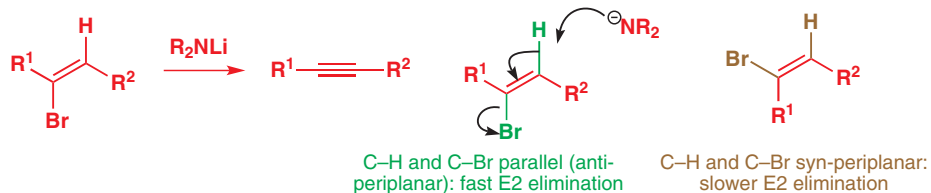

Vinyl bromides can themselves be made by elimination reactions of 1,2-dibromoalkanes. Watch what happens when 1,2-dibromopropane is treated with three equivalents of R₂NLi: first, elimination to the vinyl halide, then elimination of the vinyl halide to the alkyne. The terminal alkyne is amply acidic enough to be deprotonated by R₂NLi, and this is the role of the third equivalent. Overall, the reaction makes a lithiated alkyne (ready for further reactions) from a fully saturated starting material. This may well be the first reaction you have met that makes an alkyne from a starting material that doesn't already contain a triple bond.

making an alkyne from 1,2-dibromopropane

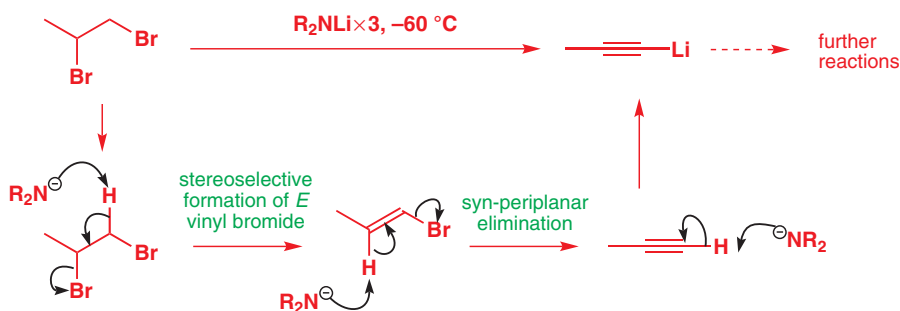

The regioselectivity of E2 eliminations

Here are two deceptively similar elimination reactions. The leaving group changes and the reaction conditions are very different but the overall process is elimination of HX to produce one of two alkenes.

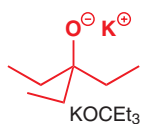

In the first example acid-catalysed elimination of water from a tertiary alcohol produces a trisubstituted alkene. Elimination of HCl from the corresponding tertiary alkyl chloride promoted by a very hindered alkoxide base (more hindered than *t*-BuOK because all the ethyl groups have to point away from one another) gives exclusively the less stable disubstituted alkene.

The reason for the two different regioselectivities is a change in mechanism. As we have already discussed, acid-catalysed elimination of water from tertiary alcohols is usually E1, and you already know the reason why the more substituted alkene forms faster in E1 reactions (p. 394). It should come as no surprise to you now that the second elimination, with a strong, hindered base, is an E2 reaction. But why does E2 give the less substituted product? This time, there is no problem getting C–H bonds anti-periplanar to the leaving group: in the conformation

with the Cl axial there are two equivalent ring hydrogens available for elimination, and removal of either of these would lead to the trisubstituted alkene. Additionally, any of the three equivalent methyl hydrogens are in a position to undergo E2 elimination to form the disubstituted alkene whether the Cl is axial or equatorial—and yet it is these and only these that are removed by the hindered base. The diagram summarizes two of the possibilities.

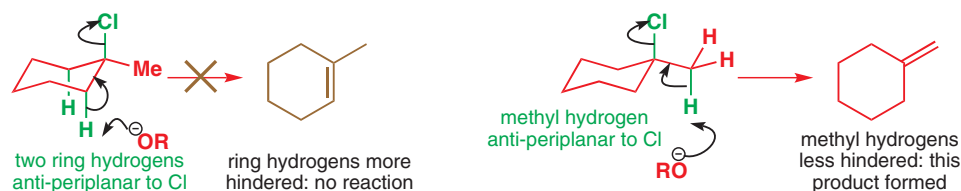

The base attacks the methyl hydrogens because they are less hindered—they are attached to a primary carbon atom, well away from the other axial hydrogens. E2 eliminations with hindered bases typically give the less substituted double bond because the fastest E2 reaction involves deprotonation at the least-substituted site. The hydrogens attached to a less substituted carbon atom are also more acidic. Think of the conjugate bases: a *t*-butyl anion is more basic (because the anion is destabilized by the three electron-donating alkyl groups) than a methyl anion, so the corresponding alkane must be less acidic. Steric factors are evident in the following E2 reactions, where changing the base from ethoxide to *t*-butoxide alters the major product from the more to the less substituted alkene.

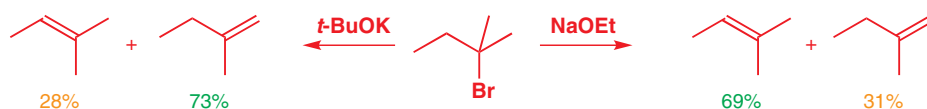

● Elimination regioselectivity

- E1 reactions give the more substituted alkene.
- E2 reactions may give the more substituted alkene, but become more regioselective for the less substituted alkene with more hindered bases.

Hofmann and Saytsev

Traditionally, these two opposite preferences—for the more or the less substituted alkenes—have been called Saytsev's rule and Hofmann's rule, respectively. You will see these names used (along with a number of alternative spellings—acceptable for Saytsev, whose name is transliterated from Russian, but not for Hofmann: this Hofmann had one f and two n's), but there is little point remembering which is which (or how to spell them)—it is far more important to understand the reasons that favour formation of each of the two alkenes.

Anion-stabilizing groups allow another mechanism—E1cB

To finish this chapter, we consider a reaction that at first sight seems to go against what we have told you so far. It's an elimination catalysed by a strong base (KOH), so it looks like E2. But the leaving group is hydroxide, which we categorically (and truthfully) stated cannot be a leaving group in E2 eliminations.



The key to what is going on is the carbonyl group. In Chapter 8 you met the idea that negative charges are stabilized by conjugation with carbonyl groups, and the list on p. 176 demonstrated how acidic a proton adjacent to a carbonyl group is. The proton that is removed in this elimination reaction is adjacent to the carbonyl group, and is therefore also rather acidic (pK_a about 20). This means that the base can remove it without the leaving group departing at the

■ This delocalized anion is called an enolate, and we will discuss enolates in more detail in Chapter 20 and beyond.

same time—the anion that results is stable enough to exist because it can be delocalized on to the carbonyl group.

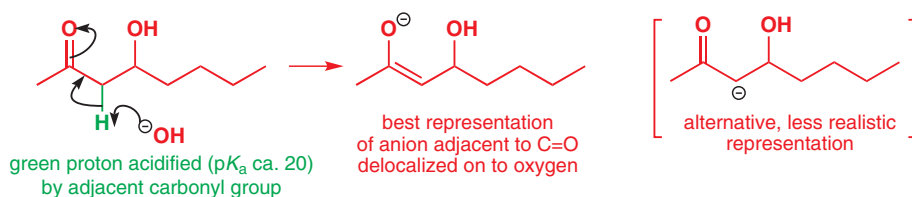

Although the anion is stabilized by the carbonyl group, it still prefers to lose a leaving group and become an alkene. This is the next step.

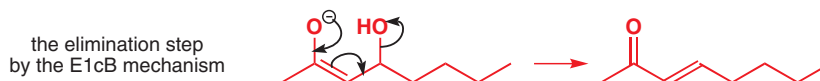

This step is also the rate-determining step of the elimination—the elimination is unimolecular and so is some kind of E1 reaction. The leaving group is not lost from the starting molecule, but from the *conjugate base* of the starting molecule, so this sort of elimination, which starts with a deprotonation, is called E1cB (cB for conjugate base). Here is the full mechanism, generalized for other carbonyl compounds.

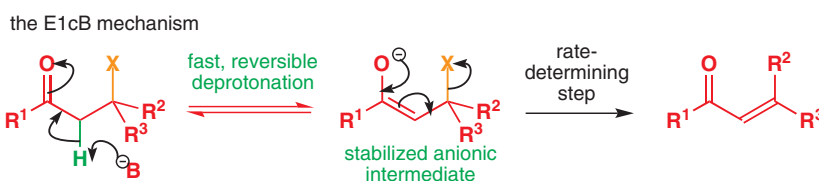

Interactive mechanism for E1cB elimination

■ 'E1cB' is written with no super- or subscripts, a lower-case c, and an upper-case B.

It's important to note that, while HO^- is never a leaving group in E2 reactions, it can be a leaving group in E1cB reactions. The anion it is lost from is already an alkoxide—the oxyanion does not need to be created as the HO^- is lost. The establishment of conjugation in the product also assists loss of HO^- . As the scheme above implies, other leaving groups are possible too. Here are two examples with methanesulfonate leaving groups.

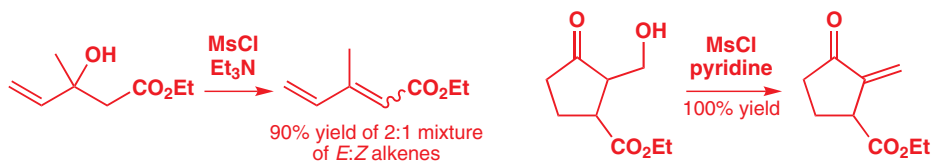

The first looks E1 (stabilized cation), the second E2—but in fact both are E1cB reactions. The most reliable way to spot a likely E1cB elimination is to see whether the alkene in the product is conjugated with a carbonyl group. If it is, the mechanism is probably E1cB.

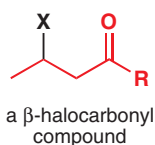
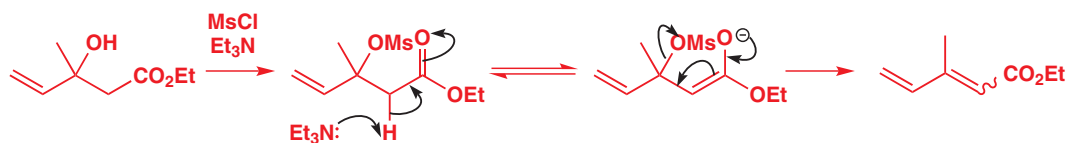

β -Halocarbonyl compounds can be rather unstable: the combination of a good leaving group and an acidic proton means that E1cB elimination is extremely easy. This mixture of diastereoisomers is first of all lactonized in acid (Chapter 10), and then undergoes E1cB

elimination with triethylamine to give a product known as a butenolide. Butenolides are common structures in naturally occurring compounds.

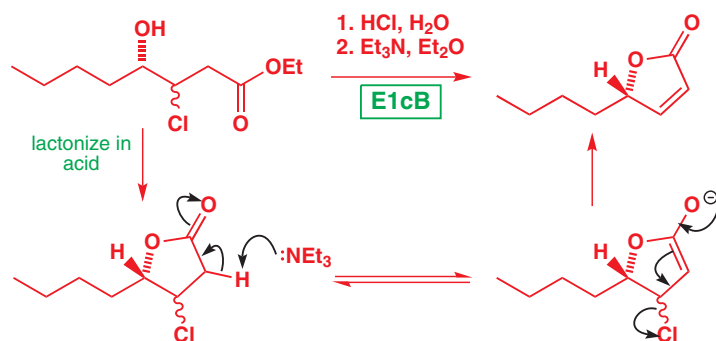

You will have noticed that we have shown the deprotonation step in the last few mechanisms as an equilibrium. Both equilibria lie rather over to the left-hand side because neither triethylamine ($\text{p}K_{\text{a}}$ of Et_3NH^+ about 10) nor hydroxide ($\text{p}K_{\text{a}}$ of H_2O 15.7) is basic enough to remove completely a proton next to a carbonyl group ($\text{p}K_{\text{a}} > 20$). However, because the loss of the leaving group is essentially irreversible, only a small amount of deprotonated carbonyl compound is necessary to keep the reaction going. The important point about substrates that undergo E1cB is that there is some form of anion-stabilizing group next to the proton to be removed—it doesn't have to stabilize the anion very well but, as long as it makes the proton more acidic, an E1cB mechanism has a chance. Here is an important example with two phenyl rings helping to stabilize the anion, and a carbamate anion ($\text{R}_2\text{N}-\text{CO}_2^-$) as the leaving group.

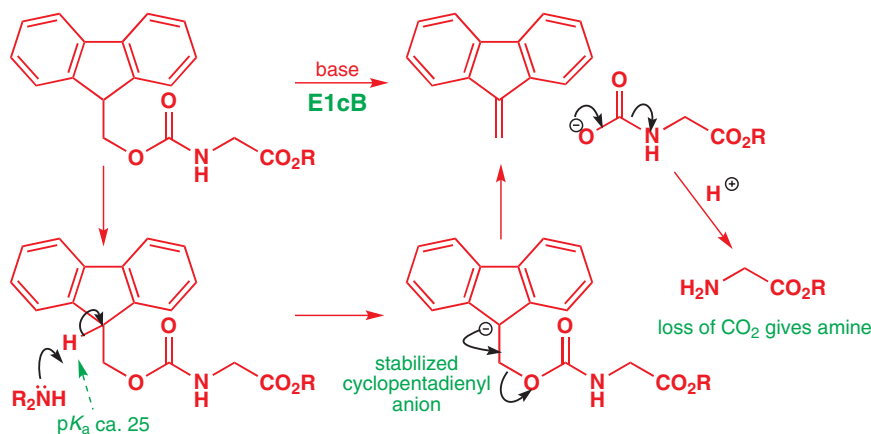

The proton to be removed has a $\text{p}K_{\text{a}}$ of about 25 because its conjugate base is an aromatic cyclopentadienyl anion (we discussed this in Chapter 8). The E1cB elimination takes place with a secondary or tertiary amine as the base. Spontaneous loss of CO_2 from the eliminated product gives an amine, and you will meet this class of compounds again in Chapter 23, where we discuss the Fmoc protecting group.



The E1cB rate equation

The rate-determining elimination step in an E1cB reaction is unimolecular, so you might imagine it would have a first-order rate equation. In fact, the rate is also dependent on the concentration of base. This is because the unimolecular elimination involves a species—the anion—whose concentration is itself determined by the concentration of base by the equilibrium we have just been discussing. Using the following general E1cB reaction, the concentration of the anion can be expressed as shown.

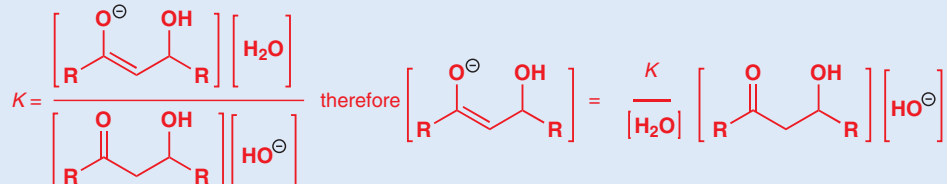
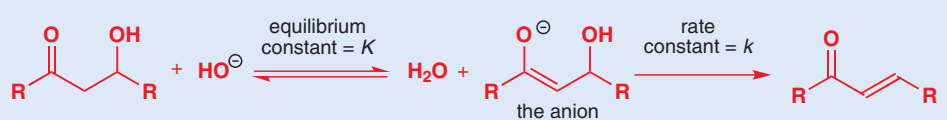

The rate is proportional to the concentration of the anion, and we now have an expression for that concentration. We can simplify it further because the concentration of water is effectively constant.

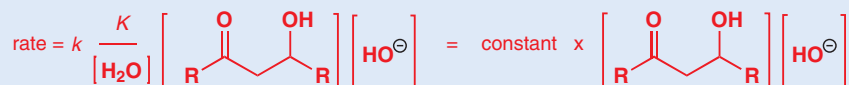

➔ You met this idea in Chapter 12 in the context of *third-order* rate equations.

Just because the base (hydroxide) appears in this rate equation doesn't mean to say it is involved in the rate-determining step. Increasing the concentration of base makes the reaction go faster by increasing the amount of anion available to eliminate.

E1cB eliminations in context

We can also compare the E1cB mechanism with the other elimination reactions you have met by thinking of the relative timing of proton removal and leaving group departure. E1 is at one end of the scale: the leaving group goes first and proton removal follows in a second step. In E2 reactions, the two events happen at the same time: the proton is removed as the leaving group leaves. In E1cB the proton removal moves in front of leaving group departure.

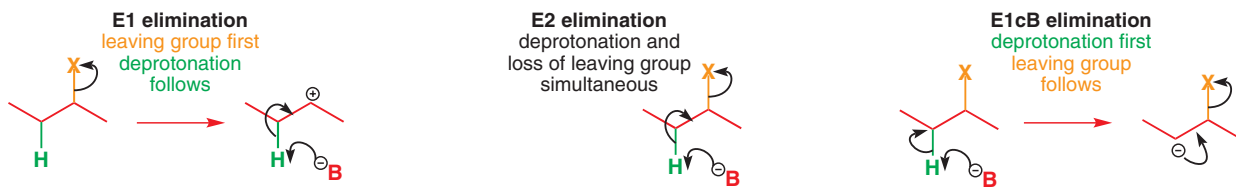

We talked about regio- and stereoselectivity in connection with E1 and E2 reactions. With E1cB, the regioselectivity is straightforward: the location of the double bond is defined by the position of (a) the acidic proton and (b) the leaving group.

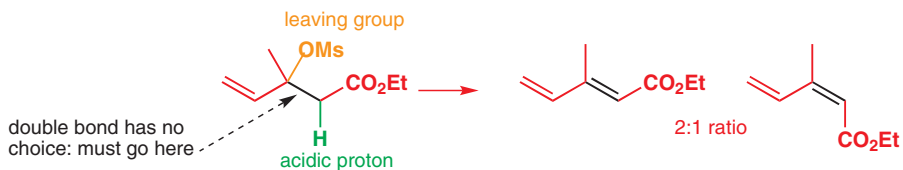

E1cB reactions may be stereoselective—the one above, for example, gives mainly the *E* alkene product (2:1 with *Z*). The intermediate anion is planar, so the stereochemistry of the starting materials is irrelevant, the less sterically hindered (usually *E*) product is preferred. This double E1cB elimination, for example, gives only the *E,E* product.



To finish this chapter we need to tell you about two E1cB eliminations that you may meet in unexpected places. We have saved them till now because they are unusual in that the leaving group is actually part of the anion-stabilizing group itself. First of all, try spotting the E1cB elimination in this step from the first total synthesis of penicillin V.

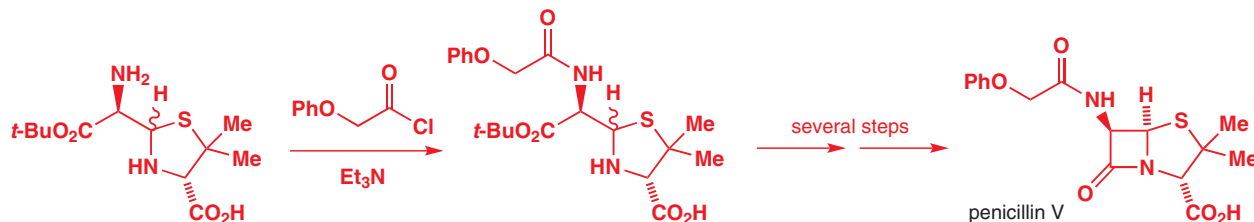

The reaction is deceptively simple—formation of an amide in the presence of base—and you would expect the mechanism to follow what we told you in Chapter 10. But the acyl chloride is, in fact, set up for an E1cB elimination—and you should expect this whenever you see an acyl chloride *with acidic protons next to the carbonyl group* used in the presence of a base such as triethylamine.

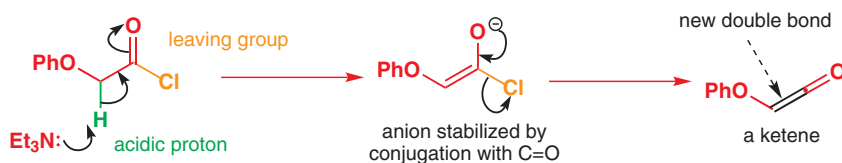

The product of the elimination is a substituted ketene—a highly reactive species whose parent structure is the molecule $\text{CH}_2=\text{C}=\text{O}$ that you will meet in the next chapter. It is the ketene that reacts with the amine to form the amide.

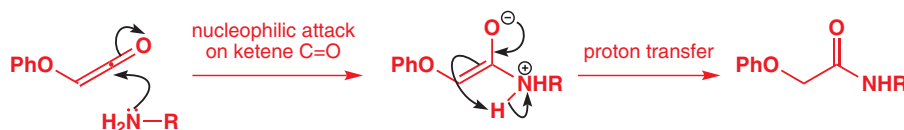

The second ‘concealed’ E1cB elimination is disguised in the mechanism of formation of methanesulfonates (mesylates). When we introduced sulfonate esters in Chapter 15, and revisited them on p. 391 of this chapter, we avoided (uncharacteristically, you may say) explaining the mechanism by which they are formed from sulfonyl chlorides. This was deliberate because, while TsCl reacts with alcohols by the mechanism you might predict, the reaction with MsCl involves an elimination step.

Here is the mechanism by which alkyl tosylates are formed from alcohols. The alcohol acts as a nucleophile towards the electrophilic sulfonyl chloride, and pyridine removes a proton to give the product.

formation of toluenesulfonates (tosylates): reagents ROH + TsCl + pyridine

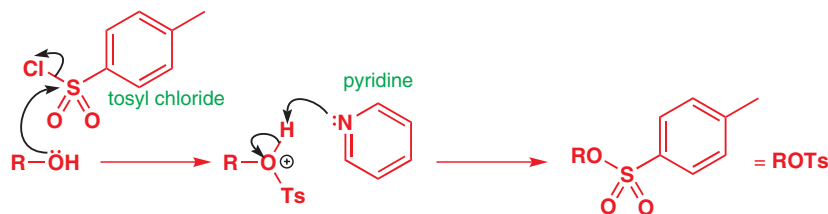

Methanesulfonyl chloride by contrast has a feature it shares with the acyl chlorides just above: a relatively acidic proton that can be removed by base. This deprotonation, followed by loss of chloride, is the first step in the formation of a mesylate ester. It is an E1cB elimination and the product is called a sulfene.

formation of methanesulfonates (mesylates): reagents ROH + MsCl + triethylamine

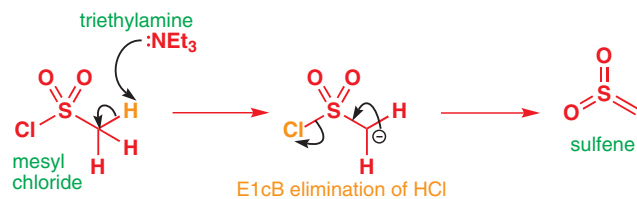

The sulfene is electrophilic in a slightly odd way: the alcohol acts as a nucleophile for sulfur and generates an anion of carbon which undergoes a proton transfer to give the mesylate. It is not uncommon for anions to form adjacent to sulfur, as you will see again in Chapter 27. Notice how similar the overall mechanism is to the acylation mechanism we showed you above.

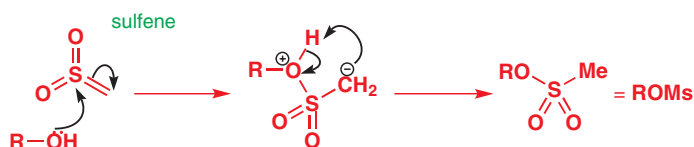

To conclude

We finish with brief summaries of three important discussions we have had in this chapter.

Elimination *versus* substitution

The table below summarizes the general pattern of reactivity expected from various structural classes of alkyl halides (or tosylates, mesylates) in reactions with a representative range of nucleophiles (which may behave as bases).

		Poor nucleophile (e.g. H ₂ O, ROH)	Weakly basic nucleophile (e.g. I ⁻ , RS ⁻)	Strongly basic, unhindered nucleophile (e.g. RO ⁻)	Strongly basic, hindered nucleophile (e.g. DBU, <i>t</i> -BuO ⁻)
methyl	$\text{H}_3\text{C}-\text{X}$	no reaction	S _N 2	S _N 2	S _N 2
primary (unhindered)		no reaction	S _N 2	S _N 2	E2
primary (hindered)		no reaction	S _N 2	E2	E2
secondary		S _N 1, E1 (slow)	S _N 2	E2	E2
tertiary		E1 or S _N 1	S _N 1, E1	E2	E2
β to anion-stabilizing group		E1cB	E1cB	E1cB	E1cB

Some points about the table:

- Methyl halides cannot eliminate as there are no appropriately placed protons.
- Increasing branching favours elimination over substitution and strongly basic hindered nucleophiles always eliminate unless there is no option.
- Good nucleophiles undergo substitution by S_N2 unless the substrate is tertiary and then the intermediate cation can eliminate by E1 as well as substitute by S_N1 .
- High temperatures favour elimination by gearing up the importance of entropy in the free energy of reaction ($\Delta G = \Delta H - T\Delta S$). This is a good way of ensuring E1 in ambiguous cases.

Summary of the stabilities of types of alkene

Alkenes are stabilized by:

- **conjugation**—anything that can conjugate with an alkene stabilizes it, including carbonyl groups, nitriles, benzene rings, RO or RNH groups, or another alkene. This is the strongest stabilization and usually dominates.
- **substitution**—alkyl groups stabilize alkenes weakly by σ -conjugation, so the more alkyl groups the better—but beware of the next point.
- **lack of steric hindrance**—as alkenes are planar, large, especially branched, substituents arranged *syn* on the alkene destabilize it, so tetra-substituted alkenes are usually less stable than tri-substituted ones. If the alkene is in a stable ring, this does not apply as the ring substituents have to be *syn* for the ring to exist.

Alkene stereochemistry: a summary of terminology

The official way of assigning alkene geometry is *E* and *Z*. *Z* comes from the German *zusammen* (together) and means that the two highest ranking substituents (by the same rules introduced in Chapter 14 for *R* and *S*) are on the same side of the alkene. The letter *Z* is a particularly unfortunate choice as it looks like a *trans* alkene! *E* comes from the German *entgegen* (opposed) and means that the two highest ranking substituents are on opposite sides (and, if anything also unfortunately looks like a *cis* alkene). The green numbers in the structures below show the relative rankings of the two substituents at each end of the alkene and the consequent assignment of geometry.

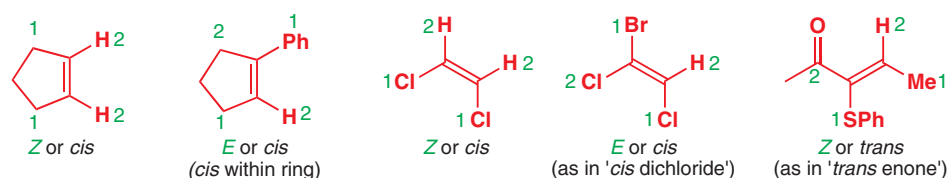

But possibly the most common method of referring to alkene geometry is to use *cis* and *trans*. These require a diagram as they refer to two substituents being on the same (*cis*) or opposite (*trans*) sides of the alkene. There is no specified order of priority and the speaker chooses substituents that are significant to the structure or to the reaction under discussion, making this a more flexible and versatile way of talking about alkenes. We have assigned *cis* and *trans* to the alkenes above to indicate their most important features, but notice the ambiguities that may occur.

■ This terminology may be used only for alkenes and not for three-dimensional stereochemistry.

■ Much the same are the terms *syn* and *anti*, introduced on p. 317 and used for relative three-dimensional stereochemistry. There is no formal definition, and a diagram is needed for clarity.

Further reading

See J. Keeler and P. Wothers, *Why Chemical Reactions Happen*, OUP, Oxford, 2003, chapter 11 for a comparison between substitution and elimination and F. A. Carey and R. J. Sundberg, *Advanced Organic Chemistry A, Structure and Mechanisms*, 5th edn, Springer 2007, chapter 5.

DBU and other strong bases are described in T. Ishikawa, ed. *Superbases for organic synthesis: guanidines, amidines and phosphazenes and related organocatalysts*, Wiley, Chichester, 2009. The trityl protecting group, along with many others is described in P. J. Kocienski, *Protecting Groups*, 3rd edn, Thieme, 2003.

Check your understanding



To check that you have mastered the concepts presented in this chapter, attempt the problems that are available in the book's Online Resource Centre at <http://www.oxfordtextbooks.co.uk/orc/clayden2e/>

Connections

➔ Building on

- Mass spectrometry [ch3](#)
- Infrared spectroscopy [ch3](#)
- ^{13}C NMR [ch3](#)
- ^1H NMR [ch13](#)
- Stereochemistry [ch14](#)
- Conformation [ch16](#)
- Elimination [ch17](#)
- Carbonyl chemistry [ch10](#) and [ch12](#)

Arriving at

- How spectroscopy explains the reactions of the C=O group
- How spectroscopy tells us about the reactivity of, and reaction products from, conjugated C=C and C=O bonds
- How spectroscopy tells us about the size of rings
- How spectroscopy solves the structure of unknown compounds
- Some guidelines for solving unknown structures

➔ Looking forward to

- A final review of spectroscopy, including what it tells us about the stereochemistry of molecules [ch31](#)
- Spectroscopy is an essential tool and will be referred to throughout the rest of the book

This is the first of two review chapters on spectroscopic methods taken as a whole. In Chapter 31 we shall tackle the complete identification of organic compounds, including the vital aspect of stereochemistry, introduced in Chapters 14 and 17. In this chapter we gather together some of the ideas introduced in previous chapters on spectroscopy and mechanism, and show how they are related. We shall explain the structure of the chapter as we go along.

There are three reasons for this chapter

1. To review the methods of structure determination we met in Chapters 3 and 13, to extend them a little further, and to consider the relationships between them.
2. To show how these methods may be combined to determine the structure of unknown molecules.
3. To provide useful tables of data for you to use when you are attempting to determine unknown structures.

The main tables of data appear at the end of the chapter (pp. 423–425) so that they are easy to refer to when you are working on problems. You may also wish to look at them, along with the tables in the text, as you work through this chapter.

We shall deal with points 1 and 2 together, looking first at the interplay between the chemistry of the carbonyl group (as discussed in Chapters 10 and 11) and spectroscopy, solving some structural problems, then moving on to discuss, for example, NMR of more

than one element in the same compound, doing some more problems, and so on. We hope that the lessons from each section will help in your overall understanding of structure solving. The first section deals with the assignment of carbonyl compounds to their various classes.

Spectroscopy and carbonyl chemistry

Chapters 10 and 11 completed our systematic survey of carbonyl chemistry, and we can now put together chemistry and spectroscopy on this most important of all functional groups.

We have divided carbonyl compounds into two main groups:

1. **aldehydes** (RCHO) and **ketones** (R¹COR²)
2. **acids** (RCO₂H) and their derivatives (in order of reactivity):
 - acid chlorides** (RCOCl)
 - anhydrides** (RCO₂COR)
 - esters** (R¹CO₂R²)
 - amides** (RCONH₂, R¹CONMe₂, etc.).

Which spectroscopic methods most reliably distinguish these two groups? Which help us to separate aldehydes from ketones? Which allow us to distinguish the various acid derivatives? Which offer the most reliable evidence on the chemistry of the carbonyl group? These are the questions we tackle in this section.

Distinguishing aldehydes and ketones from acid derivatives

The most consistently reliable method for doing this is ¹³C NMR. It doesn't much matter whether the compounds are cyclic or unsaturated or have aromatic substituents, they all give carbonyl ¹³C shifts in about the same regions. There is a selection of examples on the facing page which we now discuss. First, look at the shifts arrowed into the carbonyl group on each structure. All the aldehydes and ketones fall between 191 and 208 ppm regardless of structure, whereas all the acid derivatives (and these are very varied indeed!) fall between 164 and 180 ppm. These two sets do not overlap and the distinction is easily made. Assigning the spectrum of the ketoacid in the margin, for example, is easy.

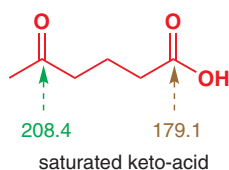

● ¹³C NMR distinguishes acid derivatives from aldehydes and ketones

The carbonyl carbons of all aldehydes and ketones resonate at about 200 ppm, while acid derivatives usually resonate at about 175 ppm.

¹³C NMR shifts of carbonyl groups

Carbonyl group	δ _c , ppm
aldehydes	195–205
ketones	195–215
acids	170–185
acid chlorides	165–170
acid anhydrides	165–170
esters	165–175
amides	165–175

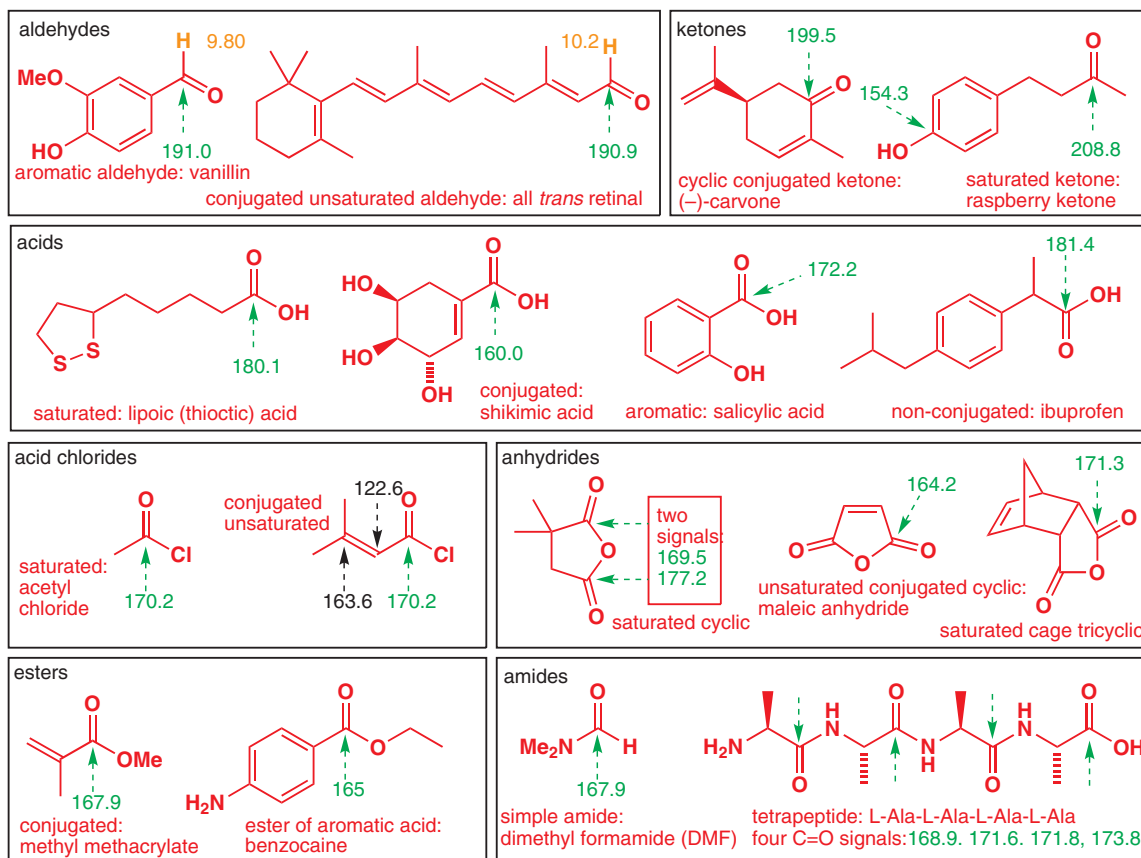

More on these structures

Aldehydes and ketones

The first aldehyde is vanillin, which comes from the vanilla pod and gives the characteristic vanilla flavour in, for example, ice cream. Vanilla is the seed pod of a South American orchid. 'Vanilla essence' is made with synthetic vanillin and tastes slightly different because the vanilla pod contains other flavour components in small quantities. The second aldehyde is retinal. As you look at this structure your eyes use the light reaching them to interconvert *cis* and *trans* retinal in your retina to create nervous impulses (see also Chapter 27).

The two ketones are all flavour compounds too. The first, (-)-carvone, is the chief component (70%) of spearmint oil. Carvone is an interesting compound: in Chapter 14 you met the mirror-image isomers known as enantiomers, and (-)-carvone's mirror image, (+)-carvone, is the chief component (35%) of dill oil. Our taste can tell the difference, although an NMR machine can't and both carvones have *identical NMR spectra*. See Chapter 14 for more detail! The second ketone is 'raspberry ketone', which is largely responsible for the flavour of raspberries. It is entirely responsible for the flavour of some 'raspberry' foods. The signal for the aromatic carbon joined to OH is at 154.3 ppm (in the 100–150 ppm region because it is an unsaturated carbon atom joined to oxygen) and cannot possibly be confused with the ketone signal at 208.8 ppm. Both ketones have C=O shifts at about 200 ppm, and both lack any signals in the proton NMR of $\delta > 8$.

Acid derivatives

Lipoic acid uses its S–S bond in redox reactions (Chapter 42), while shikimic acid is an intermediate in the formation of compounds with benzene rings, such as phenylalanine, in living things (Chapter 42). Salicylic acid's acetate ester is aspirin, which is, of course, like the last example ibuprofen, a painkiller.

The first acid chloride is a popular reagent for the synthesis of acetate esters and you have seen its reactions in Chapter 10. We have chosen three cyclic anhydrides as examples because they are all related to an important reaction (the Diels–Alder reaction), which you will meet in Chapter 34.

The first ester, methyl methacrylate, is a bulk chemical. It is the monomer whose polymerization gives Perspex, the rigid transparent plastic used in windows and roofs. The second ester is an important local anaesthetic used for minor operations.

One amide is the now-familiar DMF, but the other is a tetrapeptide and so contains one carboxylic acid group at the end and three amide groups. Although the four amino acids in this peptide are identical (alanine, Ala for short), the carbon NMR faithfully picks up four different C=O signals, all made different by being different distances from the end of the chain.

The distinction can be vital in structural problems. The symmetrical alkyne diol below cyclizes in acid with Hg(II) catalysis to a compound having, by proton NMR, the structural fragments shown. The product is unsymmetrical in that the two CMe₂ groups are still present, but they are now different. In addition, the chemical shift of the CH₂ group shows that it is next to C=O but not next to oxygen. This leaves us with two possible structures. One is an ester and one a ketone. The C=O shift is 218.8 ppm and so there is no doubt that the second structure is correct.

■ You need not, at this stage, worry about *how* the reaction works. It is more important that you realize how spectroscopy enables us to work out *what* has happened even before we have any idea *how*. Nonetheless, it is true that the second structure here also makes more sense chemically as the carbon skeleton is the same as in the starting material.

a reaction with an unknown product

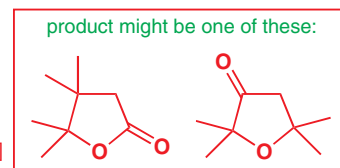
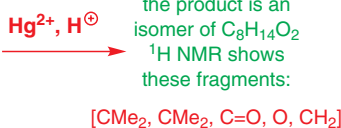
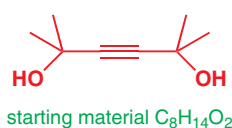

Distinguishing aldehydes from ketones is simple by proton NMR

Now look at the first two groups, the aldehydes and ketones. The two aldehydes have smaller carbonyl shifts than the two ketones, but they are too similar for this distinction to be reliable. What distinguishes the aldehydes very clearly is the characteristic proton signal for CHO at 9–10 ppm. So you should identify aldehydes and ketones by C=O shifts in carbon NMR and then separate the two by proton NMR.

- **Aldehyde protons are characteristic**
 A proton at 9–10 ppm indicates an aldehyde.

Distinguishing acid derivatives by carbon NMR is difficult

Now examine the other panels on p. 409. The four carboxylic acids are all important biologically or medicinally. Their C=O shifts are very different *from each other* as well as from those of the aldehydes or ketones.

The next five compounds (two acid chlorides and three anhydrides) are all reactive acid derivatives, and the five esters and amides below them are all unreactive acid derivatives and yet the C=O shifts of all ten compounds fall in the same range. The C=O chemical shift is obviously *not* a good way to check on chemical reactivity.

What the carbon NMR fails to do is distinguish these types of acid derivative. There is more variation between the carboxylic acids on display than between the different classes of acid derivatives. This should be obvious if we show you some compounds containing two acid derivatives. Would you care to assign these signals?

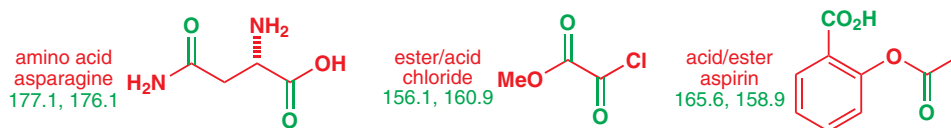

No, neither would we. In each case the difference between the carbonyl signals is only a few ppm. Although acid chlorides are extremely reactive in comparison with esters or amides, the electron deficiency at the carbon nucleus as measured by deshielding in the NMR spectrum evidently does not reflect this. Carbon NMR reliably distinguishes acid derivatives as a group from aldehydes and ketones as another group but it fails to distinguish even very reactive (for

➡ The relative reactivity of carboxylic acid derivatives was discussed in Chapter 10.

example, acid chlorides) from very unreactive (for example, amides) acid derivatives. So how do we distinguish acid derivatives?

Acid derivatives are best distinguished by infrared

A much better measure is the difference in IR stretching frequency of the C=O group. We discussed this in Chapter 10 (p. 206), where we noted a competition between conjugation by lone-pair electron donation *into* the carbonyl from OCOR, OR, or NH₂ and inductive withdrawal *from* the C=O group because of the electronegativity of the substituent. Conjugation donates electrons into the π* orbital of the π bond and so lengthens and weakens it. The C=O bond becomes more like a single bond and its stretching frequency moves towards the single-bond region, that is, it goes *down*. The inductive effect removes electrons from the π orbital and so shortens and strengthens the π bond. It becomes more like a full double bond and moves *up* in frequency.

➔ For a reminder of the distinction between conjugation and inductive effects, see Chapter 8, p. 176.

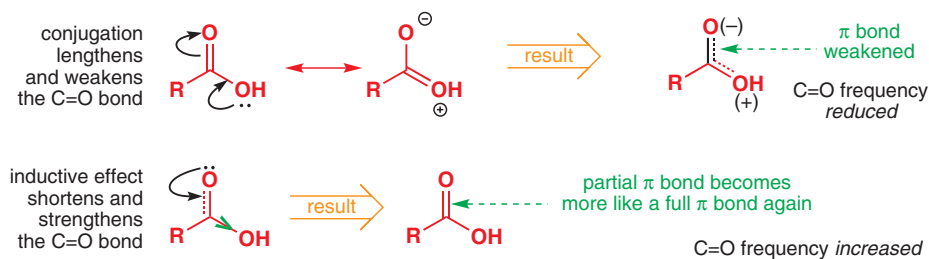

These effects are balanced in different ways according to the substituent. Chlorine is poor at lone-pair electron donation (its lone pair is in a large 3p orbital and overlaps badly with the 2p orbital on carbon) but strongly electron-withdrawing so acid chlorides absorb at high frequency, almost in the triple-bond region. Anhydrides have an oxygen atom between two carbonyl groups. Inductive withdrawal is still strong but conjugation is weak because the lone pairs are pulled both ways. Esters have a well-balanced combination with the inductive effect slightly stronger (oxygen donates from a compatible 2p orbital but is very electronegative and so withdraws electrons strongly as well). Finally, amides are dominated by conjugation as nitrogen is a much stronger electron donor than oxygen because it is less electronegative.

Acid chlorides	Anhydrides	Esters	Amides
inductive effect dominates	tug-of-war for lone pair: inductive effect dominates	inductive effect slightly dominates	conjugation strongly dominates
1815 cm ⁻¹	two peaks: ~1790, 1810 cm ⁻¹	1745 cm ⁻¹	~ 1650 cm ⁻¹

■ The two peaks for anhydrides are the symmetrical and anti-symmetrical stretches for the two C=O groups; see Chapter 3, p. 70.

Conjugation with π electrons or lone pairs affects IR C=O stretches

We need to see how conjugation works when it is with a π bond rather than with a lone pair. This will make the concept more general as it will apply to aldehydes and ketones as well as to acid groups. How can we detect whether an unsaturated carbonyl compound is conjugated or not? Well, compare these two unsaturated aldehydes.

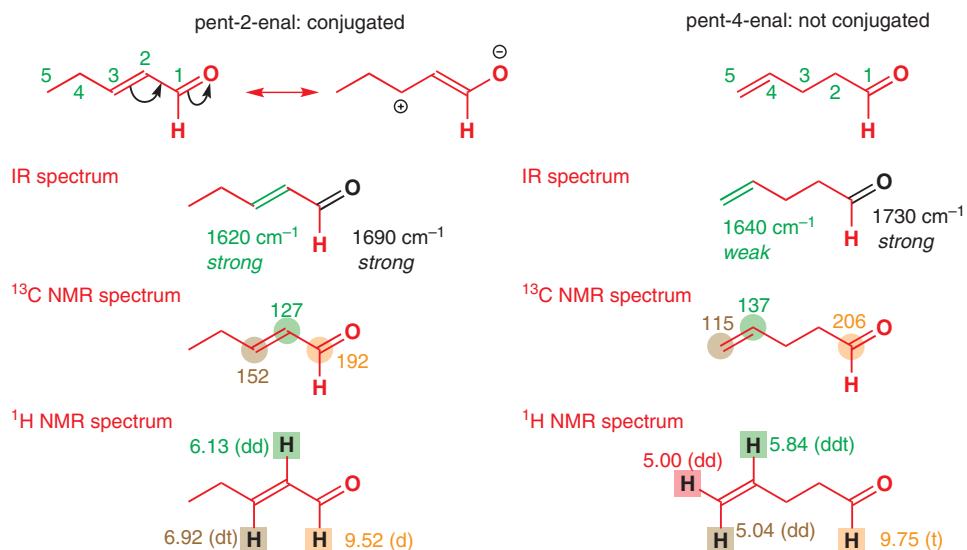

The key differences are the frequency of the C=O stretch (lowered by 40 cm⁻¹ by conjugation) and the strength (that is, the intensity) of the C=C stretch (increased by conjugation) in the IR. In the ¹³C NMR, C3 in the conjugated enal is moved out of the alkene region just into the carbonyl region, showing how electron-deficient this carbon atom must be. In the proton NMR there are many effects but the downfield shift of the protons on the alkene, especially C3 (again!), is probably the most helpful.

• Summary of the effects of substituents on C=O stretching frequency

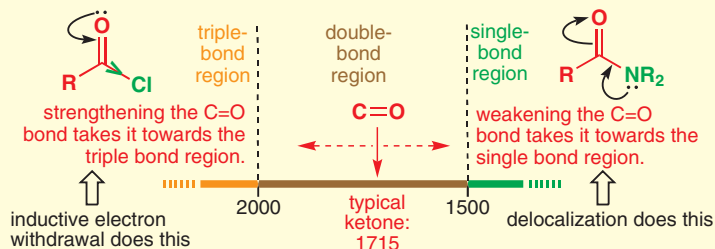

Because the infrared carbonyl frequencies follow such a predictable pattern, it is possible to make a simple list of correlations using just three factors. Two are the ones we have been discussing—conjugation (frequency-lowering) and the inductive effect (frequency-raising). The third is the effect of small rings and this we next need to consider in a broader context.

Small rings introduce strain inside the ring and higher s character outside it

■ The three-membered ring is, of course, flat. The others are not. Even the four-membered ring is slightly puckered, the five and especially the six-membered rings more so. This is all discussed, along with analysis of ring strain, in Chapter 16.

Cyclic ketones can achieve the perfect 120° angle at the carbonyl group only if the ring is at least six-membered. The smaller rings are 'strained' because the orbitals have to overlap at a less than ideal angle.

For a four-membered ring, the actual angle is 90°, so there is 120° - 90° = 30° of strain at the carbonyl group. The effects of this strain on five-, four-, and three-membered rings are shown here.

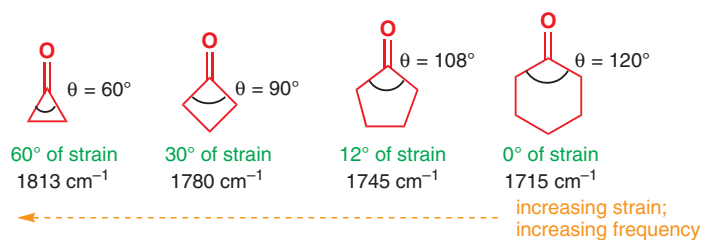

But why should strain raise the frequency of a carbonyl group? It is evidently shortening and strengthening the C=O bond as it moves it towards the triple-bond region (higher frequency), not towards the single-bond region (lower frequency). In a six-membered ring, the sp^2 orbitals forming the σ framework around the carbonyl group can overlap perfectly with the sp^3 orbitals on neighbouring carbon atoms because the orbital angle and the bond angle are the same. In a four-membered ring the orbitals do not point towards those on the neighbouring carbon atoms, but point too far out, effectively forcing the bonds to be bent and lowering the degree of overlap.

Ideally, we should like the orbitals to have an angle of 90° as this would make the orbital angle the same as the bond angle. In theory it *would* be possible to have a bond angle of 90° if we used pure p orbitals instead of sp^2 hybrid orbitals. The diagram in the margin shows this hypothetical situation. If we did this, we should leave a pure s orbital for the σ bond to oxygen. This extreme is not possible, but a compromise is. *Some* more p character goes into the ring bonds—maybe they become $s^{0.8}p^{3.2}$ —so that they can approach the 90° angle needed, and the same amount of extra s character goes into the σ bond to oxygen. The more s character there is in the orbital, the shorter it gets as s orbitals are much smaller than p orbitals.

Simple calculations of C=O stretching frequencies in IR spectra

The best way is to relate all our carbonyl frequencies to those for saturated ketones (1715 cm^{-1}). We can summarize what we have just learned in a table.

Notice in this simple table (for full details you should refer as usual to a specialist book) that the adjustment ' 30 cm^{-1} ' appears quite a lot (-30 cm^{-1} for both alkene and aryl, for example), that the increment for small rings is 35 cm^{-1} each time (30 to 65 cm^{-1} and then 65 to 100 cm^{-1}), and that the extreme effects of Cl and NH_2 are $+85$ and -85 cm^{-1} , respectively. These effects are additive. If you want to estimate the C=O frequency of a proposed structure, just add or subtract all the adjustments to 1715 cm^{-1} and you will get a reasonable result.

Effects of substituents on IR carbonyl frequencies

Effect	Group	C=O stretch, cm ⁻¹	Frequency change ^a , cm ⁻¹
inductive effect	Cl	1800	+ 85
	OCOR	1765, 1815	+ 50, +100
	OR	1745	+ 30
	H	1730	+ 15
conjugation	C=C	1685	-30
	aryl	1685	-30
	NH ₂	1630	-85
ring strain	five-membered ring	1745	+ 30
	four-membered ring	1780	+ 65
	three-membered ring	1815	+ 100

^aDifference between stretching frequency of C=O and stretching frequency of a typical saturated ketone (1715 cm^{-1}).

Lactam C=O stretching frequencies

A further good example is the difference between C=O stretching frequencies in cyclic amides, or lactams. The penicillin class of antibiotics all contain a four-membered ring amide known as a β -lactam. The carbonyl stretching frequency in these compounds is way above the 1680 cm^{-1} of the six-membered lactam, which is what you might expect for an unstrained amide.

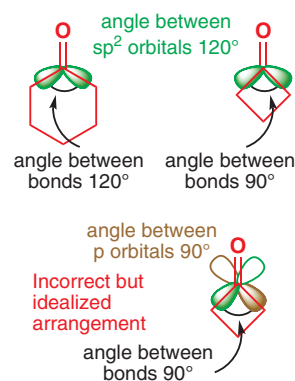
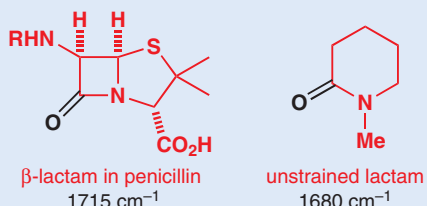

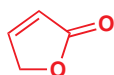

Try this out with the five-membered unsaturated (and conjugated) lactone (cyclic ester) in the margin. We must add 30 cm^{-1} for the ester, subtract 30 cm^{-1} for the double bond, and add 30 cm^{-1} for the five-membered ring. Two of those cancel out, leaving just $1715 + 30 = 1745\text{ cm}^{-1}$. These compounds absorb at $1740\text{--}1760\text{ cm}^{-1}$. Not bad!

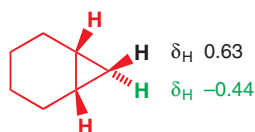
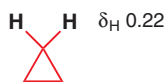

NMR spectra of alkynes and small rings

This idea that small rings have more p character in the ring and more s character outside the ring also explains the effects of small rings on proton NMR shifts. These hydrogens, particularly on three-membered rings, resonate at unusually high fields, between 0 and 1 ppm in cyclopropanes instead of the 1.3 ppm expected for CH_2 groups, and may even appear at negative δ values. High p character in the framework of small rings also means high s character in C–H bonds outside the ring and this will mean shorter bonds, greater shielding, and small δ values.

Three-membered rings and alkynes

You have also seen the same argument used in Chapter 8 to justify the unusual acidity of C–H protons on triple bonds (such as alkynes and HCN), and alluded to in Chapter 3 to explain the stretching frequency of the same C–H bonds. Like alkynes, three-membered rings are also unusually easy to deprotonate in base.

Here is an example where deprotonation occurs at a different site in two compounds identical except for a C–C bond closing a three-membered ring. The first is an ortholithiation of the type discussed in Chapter 24.

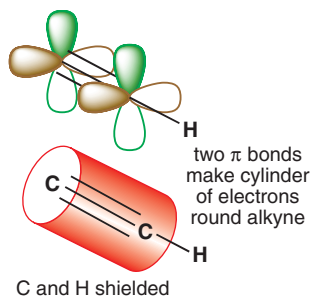
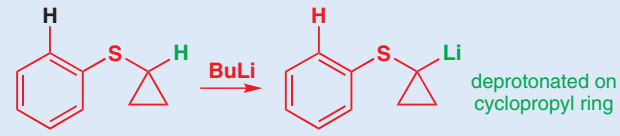
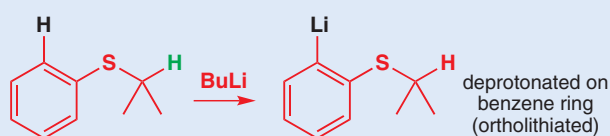

Now what about the NMR spectra of alkynes? By the same argument, protons on alkynes ought to appear in the NMR at quite high field because the C atom is sp hybridized, so it makes its σ bonds with sp orbitals (i.e. 50% s character). Protons on a typical alkene have δ_{H} about 5.5 ppm, while the proton on an alkyne comes right in the middle of the protons on saturated carbons at about δ_{H} 2–2.5 ppm. This is rather a large effect just for increased s character and some of it is probably due to better shielding by the triple bond, which surrounds the linear alkyne with π bonds without a nodal plane.

This means that the carbon atoms also appear at higher field than expected, not in the alkene region but from about δ_{C} 60–80 ppm. The s character argument is important, however, because shielding can't affect IR stretching frequencies, yet $\text{C}\equiv\text{C}\text{--H}$ stretches are strong and at about 3300 cm^{-1} , just right for a strong C–H bond.

A simple example is the ether 3-methoxyprop-1-yne. Integration alone allows us to assign the spectrum and the ^1H signal at 2.42 ppm, the highest field signal, is clearly the alkyne proton. Notice also that it is a triplet and that the OCH_2 group is a doublet. This $^4J_{\text{HH}}$ is small (about 2 Hz) and, although there is nothing like a letter 'W' in the arrangement of the bonds, coupling of this kind is often found in alkynes.

➔ In Chapter 13, p. 296, you saw that bonds aligned in a 'W' arrangement can give rise to a small $^4J_{\text{HH}}$ coupling.

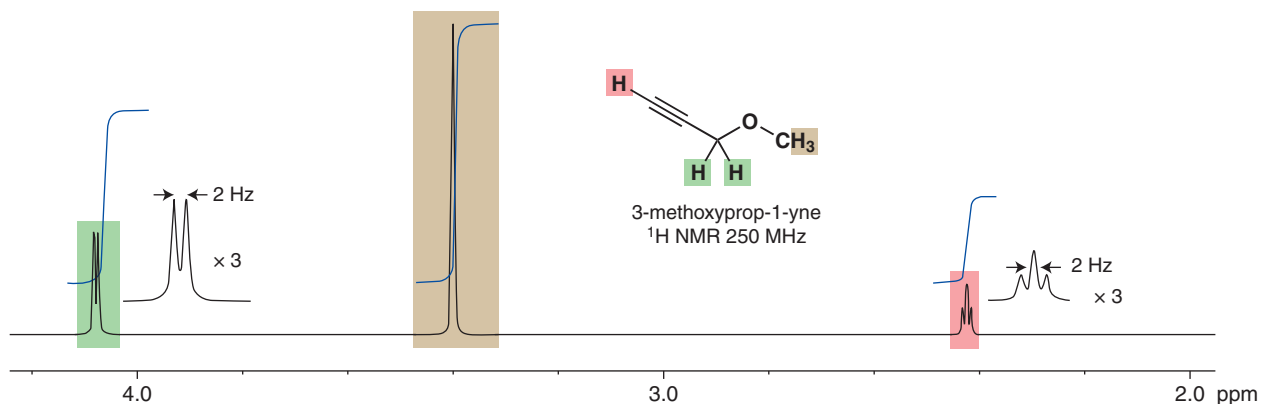

A more interesting example comes from the base-catalysed addition of methanol to buta-1,3-diyne (diacetylene). The compound formed has one double and one triple bond and the ^{13}C NMR shows clearly the greater deshielding of the double bond.

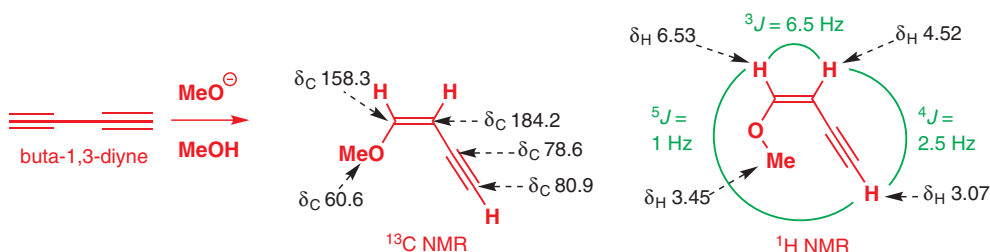

You may have noticed that we have drawn the double bond with the *cis* (*Z*) configuration. We know that this is true because of the proton NMR, which shows a 6.5 Hz coupling between the two alkene protons (much too small for a *trans* coupling; see p. 295). There is also the longer-range coupling ($^4J = 2.5$ Hz) just described and even a small very long-range coupling ($^5J = 1$ Hz) between the alkyne proton and the terminal alkene proton.

Proton NMR distinguishes axial and equatorial protons in cyclohexanes

Coupling is a through-bond phenomenon, as we know from the couplings in *cis* and *trans* alkenes, where *trans* alkenes have much larger coupling constants as their orbitals are perfectly parallel. Another case of perfectly parallel orbitals occurs with *trans*-diaxial protons in cyclohexanes. Typical coupling constants are 10–12 Hz for *trans*-diaxial protons, but much smaller (2–5 Hz) for axial/equatorial and equatorial/equatorial protons.

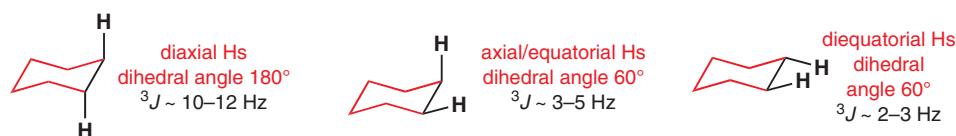

This makes assignment of conformation easy. The simple ester below has a triple triplet for the black H, with two large coupling constants (8.8 Hz) that must be to axial protons (green) and two small coupling constants (3.8 Hz) that must be to equatorial Hs (brown). This is possible only if the black H is axial and the ester group must therefore be equatorial. The acetal ester on the right is very different: it is a simple triplet with two small coupling constants (3.2 Hz), which is too small for an axial/axial coupling. The only possibility therefore is that the black proton is equatorial, and one of the 3.2 Hz couplings is to its equatorial neighbour, and the other to its axial neighbour. The ester group must be axial in this compound.

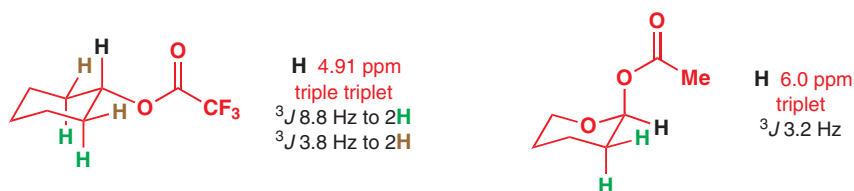

Interactions between different nuclei can give enormous coupling constants

We have looked at coupling between hydrogen atoms and you may have wondered why we have ignored coupling between other NMR active nuclei. Why does ^{13}C not cause similar couplings? In this section we are going to consider not only couplings between the same kind of nuclei,

➔ Coupling in alkenes is explained on p. 295.

➔ Proton–proton coupling in alkenes is discussed in Chapter 13 and the conformation of cyclohexanes is discussed in Chapter 16. The Karplus relationship, explaining precisely what affects the couplings in cyclohexanes, is discussed in Chapter 31.

➔ You will see in Chapter 31 why the ester group might prefer to be axial in this compound.

such as two protons, called **homonuclear coupling**, but also coupling between different nuclei, such as a proton and a fluorine atom or ^{13}C and ^{31}P , called **heteronuclear coupling**.

Two nuclei are particularly important, ^{19}F and ^{31}P , since many organic compounds contain these elements and both are at essentially 100% natural abundance and have spin $I = 1/2$. We shall start with organic compounds that have just one of these nuclei and see what happens to both the ^1H and the ^{13}C spectra. In fact, it is easy to find a ^{19}F or a ^{31}P atom in a molecule because these elements couple to all nearby carbon and hydrogen atoms. Since they can be directly bonded to either, 1J coupling constants such as $^1J_{\text{CF}}$ or $^1J_{\text{PH}}$ become possible, as well as the more 'normal' couplings such as $^2J_{\text{CF}}$ or $^3J_{\text{PH}}$, and these 1J coupling constants can be enormous.

We shall start with a simple phosphorus compound, the dimethyl ester of phosphorous acid (H_3PO_3). There is an uncertainty about the structure of both the acid and its esters. They could exist as P(III) compounds with a lone pair of electrons on phosphorus, or as P(V) compounds with a P=O double bond.

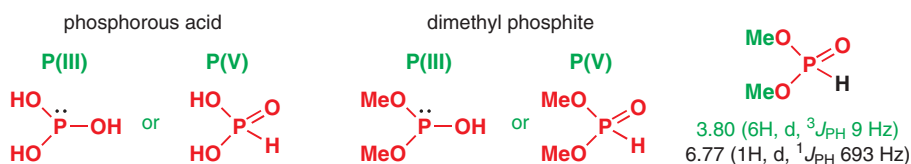

In fact, dimethyl phosphite has a ^1H doublet with the amazing coupling constant of 693 Hz: on a 250 MHz machine the two lines are over 2 ppm apart and it is easy to miss that they are two halves of the same doublet. This can only be a $^1J_{\text{PH}}$ as it is so enormous. The compound has to have a P–H bond and the P(V) structure is correct. The coupling to the protons of the methyl group is much smaller but still large for a three-bond coupling ($^3J_{\text{PC}}$ of 18 Hz).

Next, consider the phosphonium salt you met at the end of Chapter 11 for use in the Wittig reaction, turning aldehydes and ketones to alkenes. It has a $^2J_{\text{PH}}$ of 18 Hz. There is no doubt about this structure—it is just an illustration of coupling to phosphorus. There is coupling to phosphorus in the carbon spectrum too: the methyl group appears at δ_{C} 10.6 ppm with a $^1J_{\text{PC}}$ of 57 Hz, somewhat smaller than typical $^1J_{\text{PH}}$. We haven't yet talked about couplings to ^{13}C : we shall now do so.



methyltriphenylphosphonium
bromide

aromatic protons and
 δ_{H} 3.25 (3H, d, $^2J_{\text{PH}}$ 18 Hz)

Coupling in carbon NMR spectra

We shall use coupling with fluorine to introduce this section. Fluorobenzenes are good examples because they have a number of different carbon atoms all coupled to the fluorine atom.

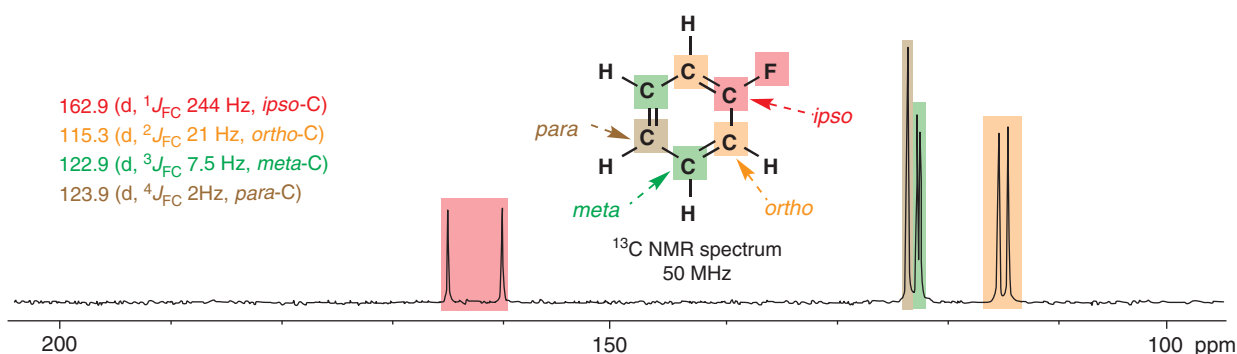

■ *Ipsa* can join the list (*ortho*, *meta*, *para*) of trivial names for positions on a substituted benzene ring. The *ipso* carbon is the one directly attached to a substituent.

The carbon directly joined to fluorine (the *ipso* carbon) has a very large $^1J_{\text{CF}}$ value of about 250 Hz. More distant coupling is evident too: all the carbons in the ring couple to the fluorine in PhF with steadily diminishing J values as the carbons become more distant.

Trifluoroacetic acid is an important strong organic acid (Chapter 8) and a good solvent for ^1H NMR. The carbon atom of the CF_3 group is coupled equally to all the three fluorines and so appears as a quartet with a large $^1J_{\text{CF}}$ of 283 Hz, about the same as in PhF. Even the carbonyl

group is also a quartet, although the coupling constant is much smaller ($^2J_{CF}$ is 43 Hz). Notice too how far downfield the CF_3 carbon atom is!

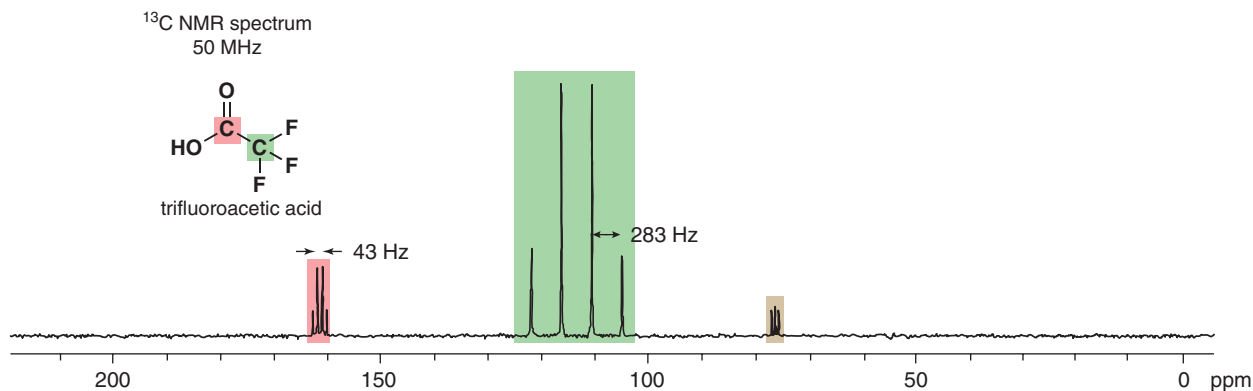

Coupling between protons and ^{13}C

In view of all this, you may ask why we don't apparently see couplings between ^{13}C and 1H in either carbon or proton spectra. In proton spectra the answer is simple: we don't see coupling to ^{13}C because of the low abundance (1.1%) of ^{13}C . Most protons are bonded to ^{12}C : only 1.1% of protons are bonded to ^{13}C . If you look closely at proton spectra with very flat baselines, you may see small peaks either side of strong peaks at about 0.5% peak height. These are the ^{13}C 'satellites' for those protons that are bonded to ^{13}C atoms.

As an example, look again at the 500 MHz 1H NMR spectrum of heptan-2-one that we saw on p. 294. When the baseline of this spectrum is vertically expanded, the ^{13}C satellites may be seen. The singlet due to the methyl protons is actually in the centre of a tiny doublet due to the 1% of protons coupling to ^{13}C . Similarly, each of the triplets in the spectrum is flanked by two tiny triplets. The two tiny triplets on either side make up a doublet of triplets with a large 1J coupling constant to the ^{13}C (around 130 Hz) and smaller 3J coupling to the two equivalent protons.

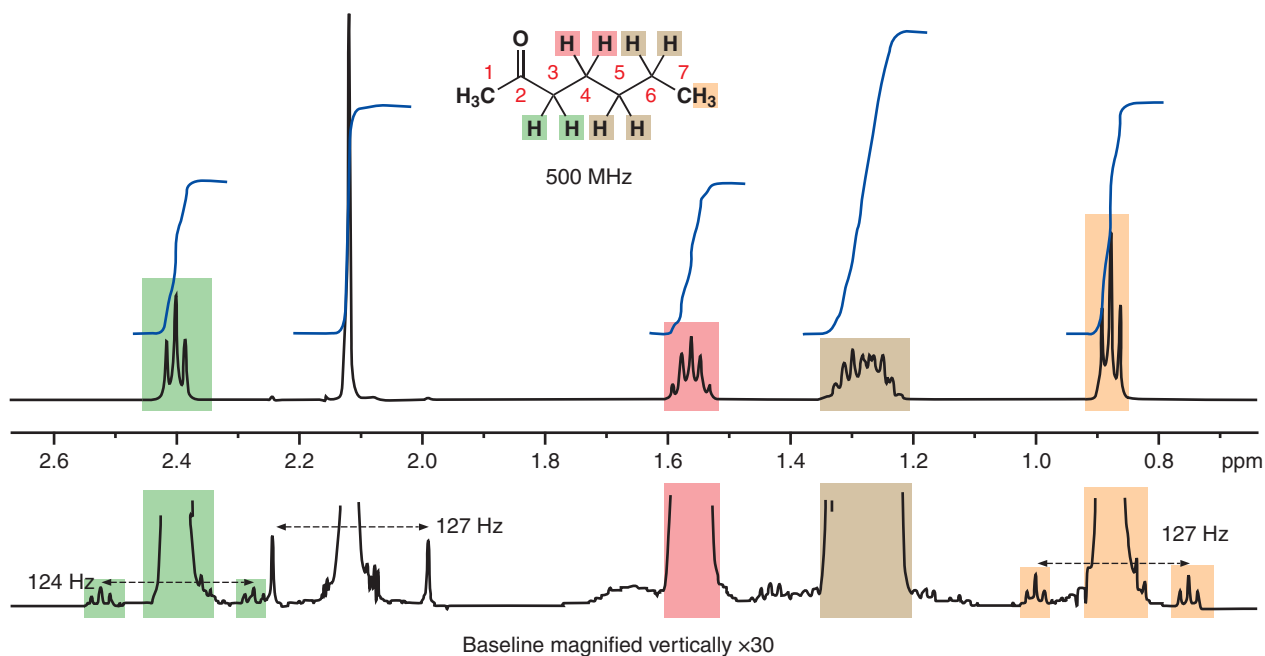

^{13}C satellites are usually lost in the background noise of the spectrum and need concern us no further. You do, however, see coupling in the 1H NMR spectrum with compounds deliberately labelled with ^{13}C because the ^{13}C abundance can then approach 100%. The same Wittig reagent we saw a moment ago shows a 3H doublet of doublets with the typically enormous $^1J_{CH}$ of 135 Hz when labelled with pure ^{13}C in the methyl group.

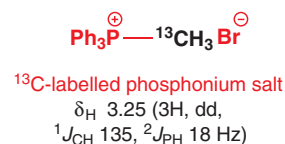

But this begs the question—where is the 135 Hz coupling in the ^{13}C NMR? Surely we should see this coupling to the protons in the ^{13}C NMR spectrum too?

Why is there no coupling to protons in normal ^{13}C NMR spectra?

We get the singlets consistently seen in carbon spectra because of the way we record the spectra. The values of J_{CH} are so large that, if we recorded ^{13}C spectra with all the coupling constants, we would get a mass of overlapping peaks. When run on the same spectrometer, the frequency at which ^{13}C nuclei resonate turns out to be about a quarter of that of the protons. Thus a '400 MHz machine' (remember that the magnet strength is usually described by the frequency at which the protons resonate) gives ^{13}C spectra at 100 MHz. Coupling constants (J_{CH}) of 100–250 Hz would cover 2–5 ppm and a CH_3 group with J_{CH} of about 125 Hz would give a quartet covering nearly 8 ppm (see the example on the previous page).

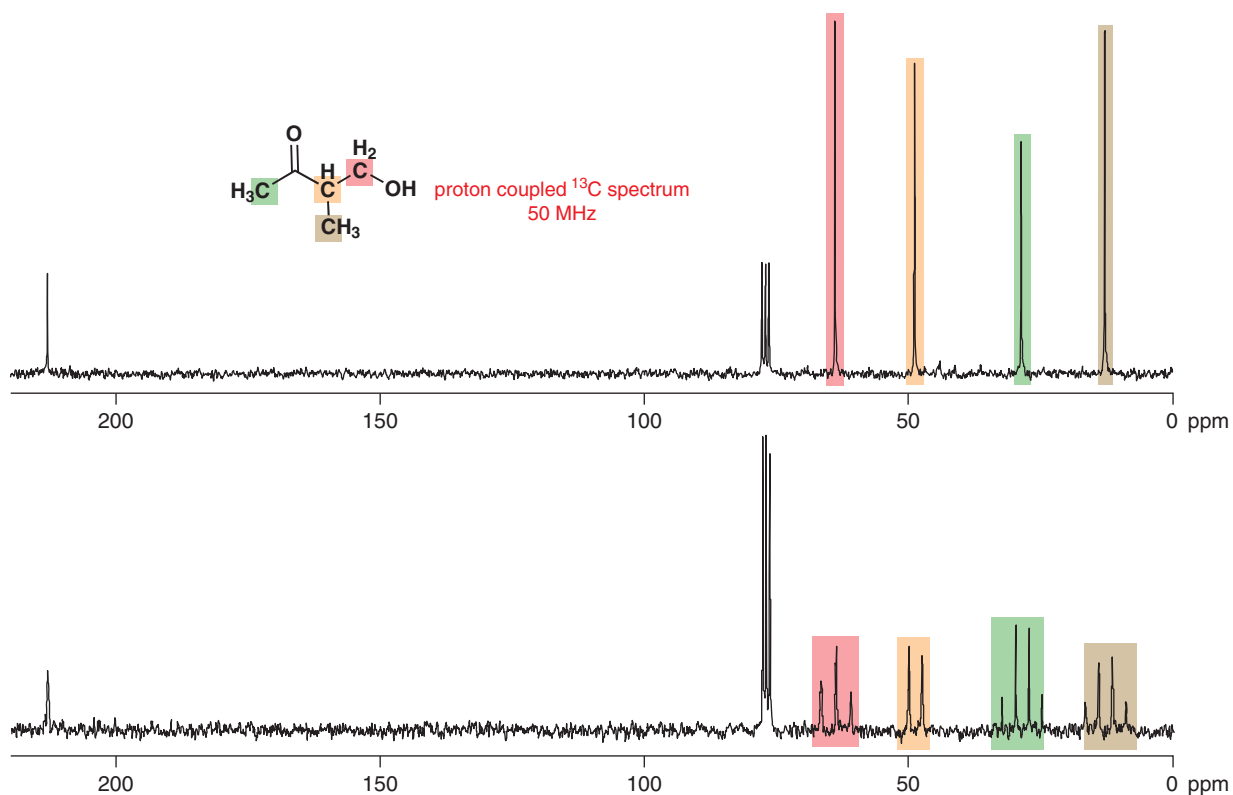

Since the proton-coupled ^{13}C spectrum can so easily help us to distinguish CH_3 , CH_2 , CH , and quaternary carbons, you might wonder why they are not used more. The above example was chosen very carefully to illustrate proton-coupled spectra at their best. Unfortunately, this is not a typical example. More usually, the confusion from overlapping peaks makes this just not worthwhile. So ^{13}C NMR spectra are recorded while the whole 10 ppm proton spectrum is being irradiated with a secondary radio frequency source. The proton energy levels are equalized by this process and all coupling disappears. Hence the singlets we are used to seeing.

For the rest of this chapter we shall not be introducing new theory or new concepts; we shall be applying what we have told you to a series of examples where spectroscopy enables chemists to identify compounds.

Identifying products spectroscopically

An ambiguous reaction product

In Chapter 3 we gave an example of a compound which was misidentified because an O atom and an N atom were mistaken for one another, even in the X-ray crystal structure.

➡ This was the case of diazamide A (p. 45).

Another famous case of ambiguity between structures containing O or N arises in the identification of the product of addition of hydroxylamine (NH_2OH) to a simple enone. This condensation reaction gives a compound with the formula $\text{C}_6\text{H}_{11}\text{NO}$. But what is its structure? We can first of all think about what we expect to happen: it is not always necessary to do this in order to identify a structure, but it can help. Nitrogen is more nucleophilic than oxygen so we might expect it to add first. But will it add directly to the carbonyl group or in the conjugate fashion we shall describe in Chapter 22? Either way, an intermediate will be formed that can cyclize.

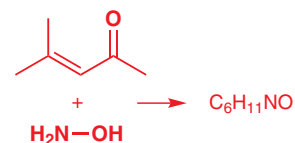

conjugate addition by the nitrogen atom of hydroxylamine

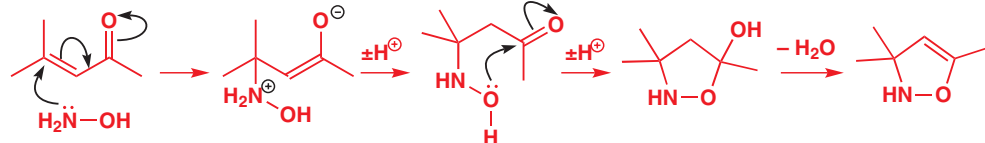

direct addition by the nitrogen atom of hydroxylamine

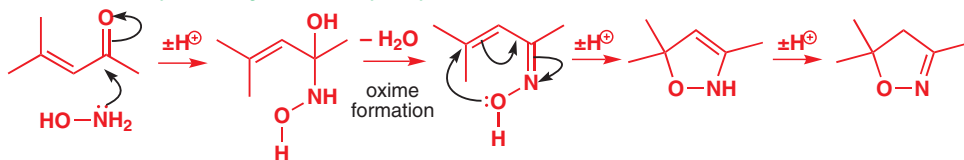

The two possible isomeric products were once the subject of a long-running controversy, but with IR and proton NMR spectra of the product, doubt vanished. The IR showed no NH stretch. The NMR showed no alkene proton but did have a CH_2 group at 2.63 ppm. Only the second structure is possible.

We need to look now at a selection of problems of different kinds to show how the various spectroscopic methods can cooperate in structure determination.

Reactive intermediates can be detected by spectroscopy

Some intermediates proposed in reaction mechanisms look so unlikely that it is comforting if they can be isolated and their structure determined. We feel more confident in proposing an intermediate if we are sure that it can really be made. Of course, this is not necessarily evidence that the intermediate is actually formed during reactions and it certainly does *not* follow that the failure to isolate a given intermediate disproves its involvement in a reaction. We shall use ketene as an example.

Ketene looks pretty unlikely! It is $\text{CH}_2=\text{C}=\text{O}$ with two π bonds ($\text{C}=\text{C}$ and $\text{C}=\text{O}$) to the same carbon atom. The orbitals for these π bonds must be orthogonal because the central carbon atom is sp hybridized with two linear σ bonds and two p orbitals at right angles both to the σ bonds and to each other. Can such a molecule exist? When acetone vapour is heated to very high temperatures (700–750 °C) methane is given off and ketene is supposed to be the other product. What is isolated is a ketene dimer ($\text{C}_4\text{H}_4\text{O}_2$) and even the structure of this is in doubt as two reasonable structures can be written.

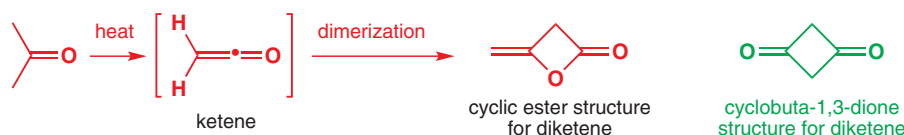

The spectra fit the ester structure well, but not the more symmetrical diketone structure at all. There are *three* types of proton (cyclobuta-1,3-dione would have just *one*), with allylic coupling between one of the protons on the double bond and the CH_2 group in the ring. The carbonyl group has the shift (185 ppm) of an acid derivative (not that of a ketone, which would be about 200 ppm) and all four carbons are different.

Do not be concerned about the details of the mechanisms: note that we have used the ‘ $\pm \text{H}^+$ ’ shorthand introduced in Chapter 11, and have abbreviated the mechanism where water is eliminated and the oxime formed—the full mechanism of imine (and oxime) formation can be found in Chapter 11, p. 229. In this chapter, we are much more concerned just with the structure of the products.

We used this logic in Chapter 15: carbocations were proposed as intermediates in $\text{S}_{\text{N}}1$ reactions long before they were observed spectroscopically, but it was reassuring to be able to see them by NMR once appropriate conditions were devised (see p. 335).

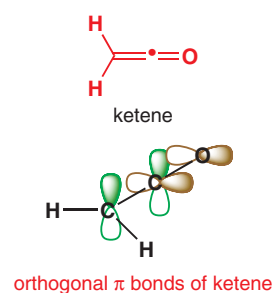

The structure of *ketene* is analogous to that of *allene*, discussed in Chapter 7, p. 146. Ketene is isoelectronic (p. 354) with CO_2 and azide, N_3^- .

Ozonolysis or ozonation

is the cleavage of an alkene by ozone (O_3). The reaction and its mechanism are discussed in Chapters 19 and 34: the only point to note now is that ozone is a powerful oxidant and cleaves the alkene to make two carbonyl compounds. Again, in this chapter we are concerned only with the structure of the products and how these can be determined.

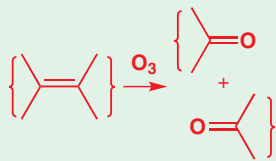

Malonic anhydride cannot be made directly from malonic acid because attempted dehydration of the acid leads to the exotic molecule carbon suboxide C_3O_2 .

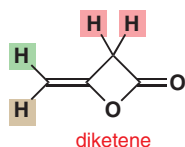
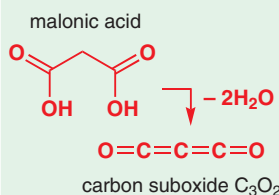

1H NMR spectrum:

4.85 (1H, narrow t, $J \sim 1$)
4.51 (1H, s)
3.90 (2H, d, $J \sim 1$)

^{13}C NMR spectrum:

185.1, 147.7, 67.0, 42.4

Ozonolysis of ketene dimer gives a very unstable compound that can be observed only at low temperatures ($-78^\circ C$ or below). It has two carbonyl bands in the IR and reacts with amines to give amides, so it looks like an anhydride (Chapter 10). Can it be the previously unknown cyclic anhydride of malonic acid?

The two carbonyl bands are of high frequency, as would be expected for a four-membered ring—using the table on p. 413 we estimate $1715 + 50\text{ cm}^{-1}$ (for the anhydride) + 65 cm^{-1} (for the four-membered ring) = 1830 cm^{-1} . Both the proton and the carbon NMR are very simple: just a 2H singlet at 4.12 ppm, shifted downfield by two carbonyls, a $C=O$ group at 160 ppm, right for an acid derivative, and a saturated carbon shifted downfield but not as much as a CH_2O group.

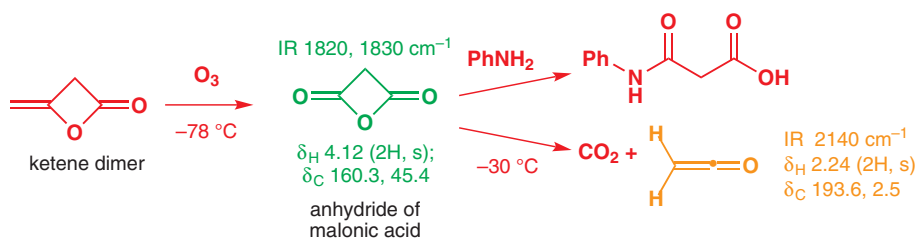

All this is reasonably convincing, and is confirmed by allowing the anhydride to warm to $-30^\circ C$, at which temperature it loses CO_2 (detected by the ^{13}C peak at 124.5 ppm) and gives another unstable compound with the strange IR frequency of 2140 cm^{-1} . Could this be monomeric ketene? It's certainly not either of the possible ketene dimers as we know what their spectra are like, and this is quite different: just a 2H singlet at 2.24 ppm and ^{13}C peaks at 194.0 and, remarkably, 2.5 ppm. It is indeed monomeric ketene.

Squares and cubes: molecules with unusual structures

Some structures are interesting because we believe they can tell us something fundamental about the nature of bonding while others are a challenge because many people argue that they cannot be made. What do you think are the prospects of making cyclobutadiene, a conjugated four-membered ring, or the hydrocarbons tetrahedrane and cubane, which have, respectively, the shapes of the perfectly symmetrical Euclidean solids, the tetrahedron and the cube?

With four electrons, cyclobutadiene is anti-aromatic—it has $4n$ instead of $4n + 2$ electrons. You saw in Chapter 7 that cyclic conjugated systems with $4n$ electrons (cyclooctatetraene, for example) avoid being conjugated by puckering into a tub shape. Cyclobutadiene cannot do this: it must be more or less planar, and so we expect it to be very unstable. Tetrahedrane has four fused three-membered rings. Although the molecule is tetrahedral in shape, each carbon atom is nowhere near a tetrahedron, with three bond angles of 60° . Cubane has six fused four-membered rings and is again highly strained.

In fact, cubane has been made, cyclobutadiene has a fleeting existence but can be isolated as an iron complex, and a few substituted versions of tetrahedrane have been made. The most convincing evidence that you have made any of these three compounds would be the extreme simplicity of the spectra. Each has only one kind of hydrogen and only one kind of carbon. They all belong to the family $(CH)_n$.

Cubane has a molecular ion in the mass spectrum at 104, correct for C_8H_8 , only CH stretches in the IR at 3000 cm^{-1} , a singlet in the proton NMR at 4.0 ppm, and a single line in the carbon



cyclobutadiene



tetrahedrane



cubane

NMR at 47.3 ppm. It is a very symmetrical molecule and a stable one in spite of all those four-membered rings.

Stable compounds with a cyclobutadiene and a tetrahedrane core can be made if each hydrogen atom is replaced by a *t*-butyl group. The very large groups round the edge of the molecule repel each other and hold the inner core tightly together. Now another difficulty arises—it is rather hard to tell the compounds apart. They both have four identical carbon atoms in the core and four identical *t*-butyl groups round the edge. The starting material for a successful synthesis of both was the tricyclic ketone below identified by its strained C=O stretch and partly symmetrical NMR spectra. When this ketone was irradiated with UV light (indicated by '*hν*' in the scheme), carbon monoxide was evolved and a highly symmetrical compound (*t*-BuC)₄ was formed. But which compound was it?

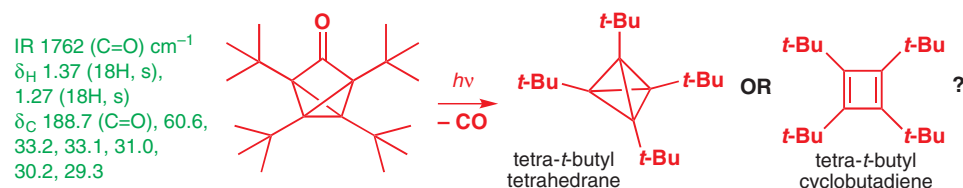

➔ You can read more about the synthesis of cubane in Chapter 36, when we discuss the rearrangement reactions that were used to make it.

The story is made more complicated (but in the end easier!) by the discovery that this compound on heating turned into another very similar compound. There are only two possible structures for (*t*-BuC)₄, so clearly one compound must be the tetrahedrane and one the cyclobutadiene. The problem simplifies with this discovery because it is easier to distinguish two possibilities when you can make comparisons between two sets of spectra. Here both compounds gave a molecular ion in the mass spectrum, neither had any interesting absorptions in the IR, and the proton NMRs could belong to either compound as they simply showed four identical *t*-Bu groups. So did the carbon NMR, of course, but it showed the core too. The first product had only saturated carbon atoms, while the second had a signal at 152.7 ppm for the unsaturated carbons. The tetrahedrane is formed from the tricyclic ketone on irradiation but it isomerizes to the cyclobutadiene on heating.

Identifying compounds from nature

The next molecules we need to know how to identify are those discovered from nature—natural products. These often have biological activity and many useful medicines have been discovered this way. We shall look at a few examples from different fields. The first is the sex pheromone of the Trinidad butterfly *Lycorea ceres ceres*. The male butterflies start courtship by emitting a tiny quantity of a volatile compound. Identification of this type of compound is very difficult because of the minute amounts available but this compound was crystallized and gave enough for a mass spectrum and an IR. The highest peak in the mass spectrum was at 135. This is an odd number so we might have one nitrogen atom and a possible composition of C₈H₉ON. The IR showed a carbonyl peak at 1680 cm⁻¹. With only this meagre information, the first proposals were for a pyridine aldehyde.

Eventually a little more compound (6 mg!) was available and a proton NMR spectrum was run. This showed at once that this structure was wrong. There was no aldehyde proton and only one methyl group. More positive information was the pair of triplets showing a -CH₂CH₂- unit between two electron-withdrawing groups (N and C=O?) and the pair of doublets for neighbouring protons on an aromatic ring, although the chemical shift and the coupling constant are both rather small for a benzene ring.

If we look at what we have got so far, we see that we have accounted for four carbon atoms in the methyl and carbonyl groups and the -CH₂CH₂- unit. This leaves only four carbon atoms for the aromatic ring. We must use nitrogen too as the only possibility is a pyrrole ring. Our fragments are now those shown below (the black dotted lines show joins to another fragment). These account for all the atoms in the molecule and suggest structures such as these.

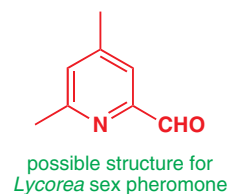

➔ Pyrrole was introduced in Chapter 7, p. 162.

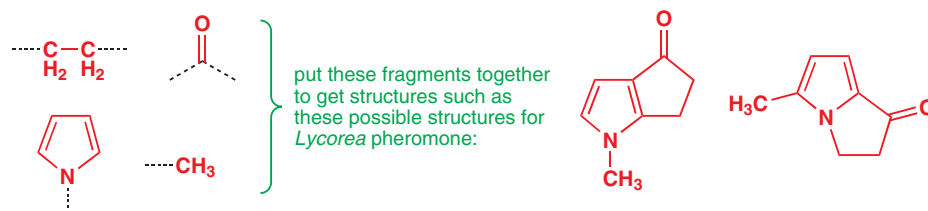

Now we need to use the known chemical shifts and coupling constants for these sorts of molecules. An N–Me group would normally have a larger chemical shift than 2.2 ppm so we prefer the methyl group on a carbon atom of the pyrrole ring. Typical shifts and coupling constants around pyrroles are shown below. Chemists do not, of course, remember these numbers; we look them up in tables. Our data, with chemical shifts of 6.09 and 6.69 ppm and a coupling constant of 2.5 Hz, clearly favour hydrogen atoms in the 2 and 3 positions, and suggest this structure for the sex pheromone, which was confirmed by synthesis and is now accepted as correct.

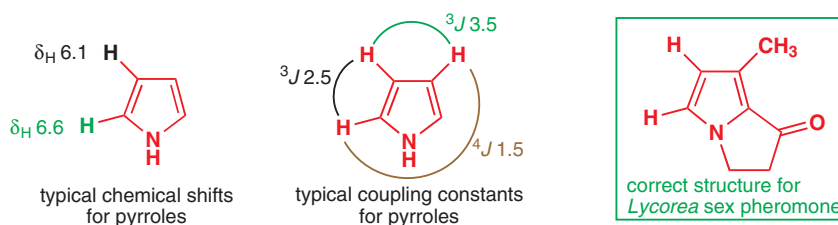

Tables

The final section of this chapter contains some tables of NMR data, which we hope you will find useful in solving problems. In Chapter 13 there were a few guides to chemical shift—summaries of patterns that you might reasonably be expected to remember. But we have left the main selections of hard numbers—tables that *you are not expected to remember*—until now. There are a few comments to explain the tables, but you will probably want to use this section as reference rather than bedtime reading. The first four tables give detailed values for various kinds of compounds and the final table gives a simple summary. We hope that you will find this last table particularly useful.

Effects of electronegativity

This table shows how the electronegativity of the atom attached directly to a methyl group affects the shifts of the CH₃ protons (δ_{H}) and the CH₃ carbon atom (δ_{C}) in their NMR spectra.

Chemical shifts of methyl groups attached to different atoms

Element	Electronegativity	Compound	δ_{H} , ppm	δ_{C} , ppm
Li	1.0	CH ₃ –Li	–1.94	–14.0
Si	1.9	CH ₃ –SiMe ₃	0.0	0.0
I	2.7	CH ₃ –I	2.15	–23.2
S	2.6	CH ₃ –SMe	2.13	18.1
N	3.1	CH ₃ –NH ₂	2.41	26.9
Cl	3.2	CH ₃ –Cl	3.06	24.9
O	3.4	CH ₃ –OH	3.50	50.3
F	4.0	CH ₃ –F	4.27	75.2

Effects of functional groups

Many substituents are more complicated than just a single atom and electronegativity is only part of the story. We need to look at all the common substituents and see what shifts they cause relative to the CH skeleton of the molecule. Our zero really ought to be at about 0.9 ppm for protons and at 8.4 ppm for carbon, that is, where ethane ($\text{CH}_3\text{-CH}_3$) resonates, and not at the arbitrary zero allocated to Me_4Si . In the table below we give such a list. The reason for this is that the shifts (from Me_4Si) themselves are not additive but the shift differences (from 0.9 or 8.4 ppm) are.

Chemical shifts of methyl groups bonded to functional groups

	Functional group	Compound	δ_{H} , ppm	$\delta_{\text{H}} - 0.9$, ppm	δ_{C} , ppm	$\delta_{\text{C}} - 8.4$, ppm
1	silane	Me₄Si	0.0	-0.9	0.0	-8.4
2	alkane	Me-Me	0.86	0.0	8.4	0.0
3	alkene	Me₂C=CMe₂	1.74	0.84	20.4	12.0
4	benzene	Me-Ph	2.32	1.32	21.4	13.0
5	alkyne	Me-C≡C-R^a	1.86	0.96		
6	nitrile	Me-CN	2.04	1.14	1.8	-6.6
7	acid	Me-CO₂H	2.10	1.20	20.9	11.5
8	ester	Me-CO₂Me	2.08	1.18	20.6	11.2
9	amide	Me-CONHMe	2.00	1.10	22.3	13.9
10	ketone	Me₂C=O	2.20	1.30	30.8	21.4
11	aldehyde	Me-CHO	2.22	1.32	30.9	21.5
12	sulfide	Me₂S	2.13	1.23	18.1	9.7
13	sulfoxide	Me₂S=O	2.71	1.81	41.0	32.6
14	sulfone	Me₂SO₂	3.14	2.24	44.4	36.0
15	amine	Me-NH₂	2.41	1.51	26.9	18.5
16	amide	MeCONH-Me	2.79	1.89	26.3	17.9
17	nitro	Me-NO₂	4.33	3.43	62.5	53.1
18	ammonium salt	Me₄N⁺Cl⁻	3.20	2.10	58.0	49.6
19	alcohol	Me-OH	3.50	2.60	50.3	44.3
20	ether	Me-OBu	3.32	2.42	58.5	50.1
21	enol ether	Me-OPh	3.78	2.88	55.1	46.7
22	ester	Me-CO₂Me	3.78	2.88	51.5	47.1
23	phosphonium salt	Ph₃P⁺-Me	3.22	2.32	11.0	2.2

^aR=CH₂OH; compound is but-2-yn-1-ol.

The effects of groups based on carbon (the methyl group is joined directly to another carbon atom) appear in entries 2 to 11. All the electron-withdrawing groups based on carbonyl and cyanide have about the same effect (1.1–1.3 ppm downfield shift from 0.9 ppm). Groups based on nitrogen (Me–N bond) show a similar progression through amine, ammonium salt, amide, and nitro compound (entries 15–18). Finally, all the oxygen-based groups (Me–O bond) show large shifts (entries 19–22).

Effects of substituents on CH₂ groups

It is more difficult to give a definitive list for CH₂ groups as they have two substituents. In the table below we set one substituent as phenyl (Ph) just because so many compounds of this kind are available, and give the actual shifts relative to PhCH₂CH₃ for protons (2.64 ppm) and PhCH₂CH₃ for carbon (28.9 ppm), again comparing the substituent with the CH skeleton.

If you compare the shifts caused on a CH₂ group by each functional group in the table below with the shifts caused on a CH₃ group by the same functional group in the table on p. 423 you will see that they are broadly the same.

Chemical shifts of CH₂ groups bonded to phenyl and functional groups

	Functional group	Compound	δ _H , ppm	δ _H - 2.64, ppm	δ _C , ppm	δ _C - 28.9, ppm
1	silane	PhCH ₂ -SiMe ₃	?	?	27.5	-1.4
2	hydrogen	PhCH ₂ -H	2.32	-0.32	21.4	-7.5
3	alkane	PhCH ₂ -CH ₃	2.64	0.00	28.9	0.0
4	benzene	PhCH ₂ -Ph	3.95	1.31	41.9	13.0
5	alkene	PhCH ₂ -CH=CH ₂	3.38	0.74	41.2	12.3
6	nitrile	PhCH ₂ -CN	3.70	1.06	23.5	-5.4
7	acid	PhCH ₂ -CO ₂ H	3.71	1.07	41.1	12.2
8	ester	PhCH ₂ -CO ₂ Me	3.73	1.09	41.1	12.2
9	amide	PhCH ₂ -CONEt ₂	3.70	1.06	?	?
10	ketone	(PhCH ₂) ₂ C=O	3.70	1.06	49.1	20.2
11	thiol	PhCH ₂ -SH	3.69	1.05	28.9	0.0
12	sulfide	(PhCH ₂) ₂ S	3.58	0.94	35.5	6.6
13	sulfoxide	(PhCH ₂) ₂ S=O	3.88	1.24	57.2	28.3
14	sulfone	(PhCH ₂) ₂ SO ₂	4.11	1.47	57.9	29.0
15	amine	PhCH ₂ -NH ₂	3.82	1.18	46.5	17.6
16	amide	HCONH-CH ₂ Ph	4.40	1.76	42.0	13.1
17	nitro ^a	PhCH ₂ -NO ₂	5.20	2.56	81.0	52.1
18	ammonium salt	PhCH ₂ -NMe ₃ ⁺	4.5/4.9		55.1	26.2
19	alcohol	PhCH ₂ -OH	4.54	1.80	65.3	36.4
20	ether	(PhCH ₂) ₂ O	4.52	1.78	72.1	43.2
21	enol ether	PhCH ₂ -OAr ^a	5.02	2.38	69.9	41.0
22	ester	MeCO ₂ -CH ₂ Ph	5.10	2.46	68.2	39.3
23	phosphonium salt	Ph ₃ P ⁺ -CH ₂ Ph	5.39	2.75	30.6	1.7
24	chloride	PhCH ₂ -Cl	4.53	1.79	46.2	17.3
25	bromide	PhCH ₂ -Br	4.45	1.81	33.5	4.6

^a Compound is (4-chloromethylphenoxymethyl)benzene.

Shifts of a CH group

We can do the same with a CH group, and in the left-hand side of the table below we take a series of isopropyl compounds, comparing the measured shifts with those for the central proton (CHMe_2) or carbon (CHMe_2) of 2-methylpropane. We set two of the substituents as methyl groups and just vary the third. Yet again the shifts for the same substituent are broadly the same.

Effects of α and β substitution on ^1H and ^{13}C NMR shifts in Me_2CHX^a

X	Effects on C_α ($\text{Me}_2\text{CH-X}$), ppm				Effects on C_β ($\text{Me}_2\text{CH-X}$), ppm			
	δ_{H}	$\delta_{\text{H}} - 1.68$	δ_{C}	$\delta_{\text{C}} - 25.0$	δ_{H}	$\delta_{\text{H}} - 0.9$	δ_{C}	$\delta_{\text{C}} - 8.4$
Li			10.2	-14.8			23.7	17.3
H	1.33	-0.35	15.9	-9.1	0.91	0.0	16.3	7.9
Me	1.68	0.00	25.0	0.0	0.89	0.0	24.6	16.2
$\text{CH}=\text{CH}_2$	2.28	0.60	32.0	7.0	0.99	0.09	22.0	13.6
Ph	2.90	1.22	34.1	9.1	1.24	0.34	24.0	15.6
CHO	2.42	0.74	41.0	16.0	1.12	0.22	15.5	7.1
COMe	2.58	0.90	41.7	16.7	1.11	0.21	27.4	19.0
CO_2H	2.58	0.90	34.0	4.0	1.20	0.30	18.8	10.4
CO_2Me	2.55	0.87	33.9	8.9	1.18	0.28	19.1	10.7
CONH_2	2.40	0.72	34.0	9.0	1.08	0.18	19.5	11.1
CN	2.71	1.03	20.0	-5.0	1.33	0.43	19.8	11.4
NH_2	3.11	1.43	42.8	17.8	1.08	0.18	26.2	17.8
NO_2	4.68	3.00	78.7	53.7	1.56	0.66	20.8	12.4
SH	3.13	1.45	30.6	5.6	1.33	0.43	27.6	19.2
<i>S</i> -Pr	3.00	1.32	33.5	8.5	1.27	0.37	23.7	15.3
OH	4.01	2.33	64.2	39.2	1.20	0.30	25.3	16.9
<i>O</i> -Pr	3.65	1.97	68.4	43.4	0.22	0.22	22.9	14.5
O_2CMe	5.00	3.32	67.6	42.6	1.22	0.32	21.4(8)	17.(0/4)
Cl	4.19	2.51	53.9	28.9	1.52	0.62	27.3	18.9
Br	4.29	2.61	45.4	20.4	1.71	0.81	28.5	20.1
I	4.32	2.36	31.2	6.2	1.90	1.00	21.4	13.0

^a There is coupling between the CH and the Me_2 groups in the proton NMR.

Shifts in proton NMR are easier to calculate and more informative than those in carbon NMR

This final table, on p. 426, helps to explain something we have avoided so far. Correlations of shifts caused by substituents in proton NMR really work very well. Those in ^{13}C NMR work much less well and more complicated equations are needed. More strikingly, the proton shifts often seem to fit better with our understanding of the chemistry of the compounds. There are two main reasons for this.

First, the carbon atom is much closer to the substituent than the proton. In the compounds in the table on p. 423 the methyl carbon atom is directly bonded to the substituent, while the protons are separated from it by the carbon atom of the methyl group. If the functional group is based on a large electron-withdrawing atom like sulfur, the protons will experience a simple inductive electron withdrawal and have a proportional downfield shift. The carbon atom is close enough to the sulfur atom to be shielded as well by the lone-pair electrons in the large 3sp^3 orbitals. The proton shift caused by S in Me_2S is about the same (1.23 ppm) as that caused by a set of more or less equally strong electron-withdrawing groups like CN (1.14 ppm) or ester (1.18 ppm). The carbon shift (9.7 ppm) is less than that caused by an ester (11.2 ppm) but much *more* than that caused by CN, which actually shifts the carbon upfield (-6.6 ppm) relative to the effect of a methyl group.

Approximate additive functional group (X) shifts in ^1H NMR spectra

Entry	Functional group X	^1H NMR shift difference ^a , ppm
1	alkene ($-\text{C}=\text{C}$)	1.0
2	alkyne ($-\text{C}\equiv\text{C}$)	1.0
3	phenyl ($-\text{Ph}$)	1.3
4	nitrile ($-\text{C}\equiv\text{N}$)	1.0
5	aldehyde ($-\text{CHO}$)	1.0
6	ketone ($-\text{COR}$)	1.0
7	acid ($-\text{CO}_2\text{H}$)	1.0
8	ester ($-\text{CO}_2\text{R}$)	1.0
9	amide ($-\text{CONH}_2$)	1.0
10	amine ($-\text{NH}_2$)	1.5
11	amide ($-\text{NHCOR}$)	2.0
12	nitro ($-\text{NO}_2$)	3.0
13	thiol ($-\text{SH}$)	1.0
14	sulfide ($-\text{SR}$)	1.0
15	sulfoxide ($-\text{SOR}$)	1.5
16	sulfone ($-\text{SO}_2\text{R}$)	2.0
17	alcohol ($-\text{OH}$)	2.0
18	ether ($-\text{OR}$)	2.0
19	aryl ether ($-\text{OAr}$)	2.5
20	ester ($-\text{O}_2\text{CR}$)	3.0
21	fluoride ($-\text{F}$)	3.0
22	chloride ($-\text{Cl}$)	2.0
23	bromide ($-\text{Br}$)	2.0
24	iodide ($-\text{I}$)	2.0

^a To be added to 0.9 ppm for MeX , 1.3 ppm for CH_2X , or 1.7 ppm for CHX .

Second, the carbon shift is strongly affected not only by what is directly joined to that atom (α position), but also by what comes next (β position). The right-hand half of the table on p. 424 shows what happens to methyl shifts when substituents are placed on the next carbon atom. There is very little effect on the proton spectrum: all the values are much less than the shifts caused by the same substituent on a methyl group in the table on p. 423. Carbonyls give a downfield shift of about 1.2 ppm when directly joined to a methyl group, but only of about 0.2 ppm when one atom further away. By contrast, the shifts in the carbon spectrum are of the same order of magnitude in the two tables, and the β shift may even be greater than the α shift! The CN group shifts a directly bonded methyl group upfield (-6.6 ppm) when directly bonded, but downfield (14.4 ppm) when one atom further away. This is an exaggerated example, but the point is that these carbon shifts must *not* be used to suggest that the CN group is electron-donating in the α position and electron-withdrawing in the β position. The carbon shifts are erratic but the proton shifts give us useful information and are worth understanding as a guide to both structure determination and the chemistry of the compound.

When you use this table and are trying to interpret, say, a methyl group at 4.0 ppm then you have no problem. Only one group is attached to a methyl group so you need a single shift value—it might be a methyl ester, for example. But when you have a CH_2 group at 4.5 ppm and you are interpreting a downfield shift of 3.2 ppm you must beware. There are *two* groups attached to each CH_2 group and you might need a single shift of about 3 ppm (say, an ester again) or two shifts of 1.5 ppm, and so on. The shifts are additive.

Further reading

A reminder: you will find it an advantage to have one of the short books on spectroscopic analysis to hand as they give explanations, comprehensive tables of data, and problems. We recommend *Spectroscopic Methods in Organic Chemistry* by D. H. Williams and Ian Fleming, McGraw-Hill, London, 6th edn, 2007.

Other books include R. M. Silverstein, F. X. Webster, and D. J. Kiemle, *Spectrometric Identification of Organic Compounds*,

Wiley, 2005 and a book of problems: L. D. Field, S. Sternhell, and J. R. Kalman, *Organic Structures from Spectra*, 3rd edn, Wiley, 2003.

The ^{13}C NMR of ketene was reported by J. Firl and W. Runger, *Angew. Chem. Int. Ed.*, 1973, **12**, 668, the tetrahedrane/cyclobutadiene story is expounded by G. Maier in *Angew. Chem. Int. Ed.*, 1988, **27**, 309, and the *Lycorea* sex pheromone story by G. Meinwald and team, *Science*, 1968, **164**, 1174.

Check your understanding



To check that you have mastered the concepts presented in this chapter, attempt the problems that are available in the book's Online Resource Centre at <http://www.oxfordtextbooks.co.uk/orc/clayden2e/>

Electrophilic addition to alkenes

19

Connections

➔ Building on

- Elimination reactions that form alkenes [ch17](#)
- Stability of carbocations, and their reactions during the S_N1 reaction [ch15](#)

Arriving at

- Reactions of simple, unconjugated alkenes with *electrophiles*
- Converting C=C double bonds to other functional groups by electrophilic addition
- How to predict which end of an unsymmetrical alkene reacts with the electrophile
- Stereoselective, stereospecific, and regioselective reactions of alkenes
- How to make alkyl halides, epoxides, alcohols, and ethers through electrophilic addition
- How to cleave an alkene into two carbonyl compounds

➔ Looking forward to

- Electrophilic addition to alkenes carrying oxygen substituents (enols and enolates) [ch20](#)
- Electrophilic addition to aromatic rings [ch21](#)
- Nucleophilic additions to electron-deficient alkenes [ch22](#)
- Reactions of alkenes by pericyclic reactions [ch34](#)
- Rearrangement reactions [ch36](#)

Alkenes react with bromine

Bromine (Br_2) is brown, and one of the classic tests for alkenes is that they turn a brown aqueous solution of bromine colourless. Alkenes decolourize bromine water: alkenes react with bromine. The product of the reaction is a dibromoalkane, and the reaction on the right shows what happens with the simplest alkene, ethylene (ethene).

In order to understand this reaction, and the other similar ones you will meet in this chapter, you need to think back to Chapter 5, where we started talking about reactivity in terms of nucleophiles and electrophiles. As soon as you see a new reaction, you should immediately think to yourself, 'Which reagent is the nucleophile; which reagent is the electrophile?' Evidently, neither the alkene nor bromine is charged, but Br_2 has a low-energy empty orbital (the $\text{Br}-\text{Br} \sigma^*$), and is therefore an electrophile. The $\text{Br}-\text{Br}$ bond is exceptionally weak, and bromine reacts with many nucleophiles like this.



In the reaction with ethylene, the alkene must be the nucleophile, and its HOMO is the $\text{C}=\text{C} \pi$ bond. Other simple alkenes are similarly electron-rich and they typically act as *nucleophiles* and attack *electrophiles*.

- Simple, unconjugated alkenes are nucleophilic and react with electrophiles.

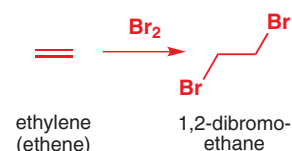

Online support. The icon  in the margin indicates that accompanying interactive resources are provided online to help your understanding: just type www.chemtube3d.com/clayden/123 into your browser, replacing **123** with the number of the page where you see the icon. For pages linking to more than one resource, type **123-1**, **123-2** etc. (replacing **123** with the page number) for access to successive links.

When it reacts with Br_2 , the alkene's filled π orbital (the HOMO) will interact with the bromine's empty σ^* orbital to give a product. But what will that product be? Look at the orbitals involved.



How do we know bromonium ions exist?

Very hindered alkenes form bromonium ions that are resistant to nucleophilic attack. In this very hindered case, the bromonium ion is sufficiently stable to be characterized by X-ray crystallography.

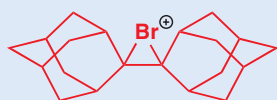

The highest electron density in the π orbital is right in the middle, between the two carbon atoms, so this is where we expect the bromine to attack. The only way the π HOMO can interact in a bonding manner with the σ^* LUMO is if the Br_2 approaches end-on—and this is how the product forms. The symmetrical three-membered ring product is called a bromonium ion.

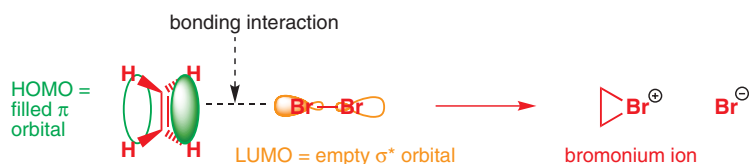

How shall we draw curly arrows for the formation of the bromonium ion? We have a choice. The simplest way is just to show the middle of the π bond attacking $\text{Br}-\text{Br}$, mirroring what we know happens with the orbitals.



But there is a problem with this representation: because only *one* pair of electrons is moving, we can't form *two* new $\text{C}-\text{Br}$ bonds. We should really then represent the $\text{C}-\text{Br}$ bonds as partial bonds. Yet the bromonium ion is a real intermediate with two proper $\text{C}-\text{Br}$ bonds (the box in the margin presents evidence of this). So an alternative way of drawing the arrows is to involve a lone pair on bromine.



We think the first way represents more accurately the key orbital interaction involved, and we shall use that one, but the second is acceptable too.

Of course, the *final* product of the reaction isn't the bromonium ion. The second step of the reaction follows on at once: the bromonium ion is itself an electrophile, and it reacts with the bromide ion lost from the bromine in the addition step. We can now draw the correct mechanism for the whole reaction, which is termed electrophilic addition to the double bond, because bromine (Br_2) is an electrophile. Overall, the molecule of bromine *adds across* the double bond of the alkene.

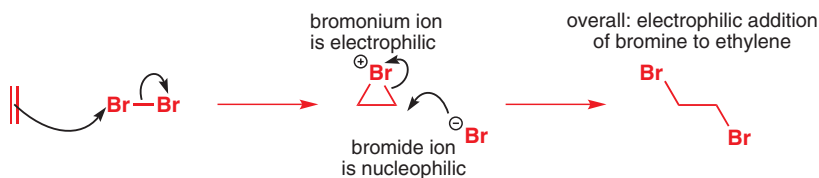

Chloramines

Have you ever wondered why conventional wisdom (and manufacturers' labels) warns against mixing different types of cleaning agent? The danger arises from nucleophilic attack on another electrophilic halogen, chlorine. Some cleaning solutions contain chlorine (bleach, to kill moulds and bacteria, usually for the bathroom) while others contain ammonia (to dissolve fatty deposits, usually for the kitchen). Ammonia is nucleophilic, chlorine electrophilic, and the products of their reaction are the highly toxic and explosive chloramines NH_2Cl , NHCl_2 , and NCl_3 .

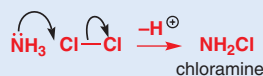

Interactive mechanism for reaction of ethylene with bromine

Compare the second step with the way nucleophiles attack epoxides, Chapter 15, p. 354.

Attack of Br on a bromonium ion is a normal S_N2 substitution—the key orbitals involved are the HOMO of the bromide and the σ^* of one of the two carbon–bromine bonds in the strained three-membered ring. As with all S_N2 reactions, the nucleophile maintains maximal overlap with the σ^* by approaching in line with the leaving group but from the opposite side, resulting in inversion at the carbon that is attacked. The stereochemical outcome of more complicated reactions (discussed below) is important evidence for this overall reaction mechanism.

You may wonder why the bromine attacks a carbon atom in the bromonium ion rather than the positively charged bromine atom. Well, in fact, it can do this as well, but the result is just regeneration of bromine and the alkene: the first step of the reaction is reversible.

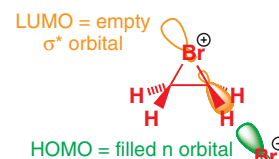

Another way of thinking about bromonium ions

You can think of the bromonium ion as a carbocation that has been stabilized by interaction with a nearby bromine atom. You have seen a similar effect with oxygen—this 'oxonium ion' was an intermediate, for example, in the S_N1 substitution of MOM chloride on p. 338 of Chapter 15.

The bromine is one atom further away but, with bromine being lower in the periodic table and having more diffuse lone pairs, it can have a similar stabilizing effect, despite the angle strain in a three-membered ring.

The two types of stabilization are not equivalent: the cation and the bromonium ion are different molecules with different shapes, while the two representations of the oxonium ion are just that—they aren't different molecules. This stabilization of an adjacent cationic centre by a heteroatom with at least one lone pair to form a three-membered ring intermediate is not restricted to bromine or the other halogens, but is also an important aspect of the chemistry of compounds containing oxygen, sulfur, or selenium, as you will see in Chapter 27.

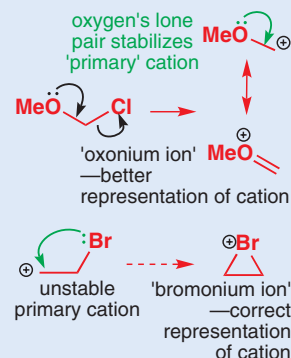

Oxidation of alkenes to form epoxides

The electrophilic addition of bromine to alkenes is an oxidation. The starting alkene is equivalent in oxidation level to an alcohol, but the product has *two* carbons at the alcohol oxidation level—the elimination reactions of dibromides to give alkynes that you met in Chapter 17 (p. 398) should convince you of this. There are a number of other oxidants containing electrophilic oxygen atoms that react with nucleophilic alkenes to produce epoxides (oxiranes). You can view epoxides as the oxygen analogues of bromonium ions, but unlike most bromonium ions they are quite stable.

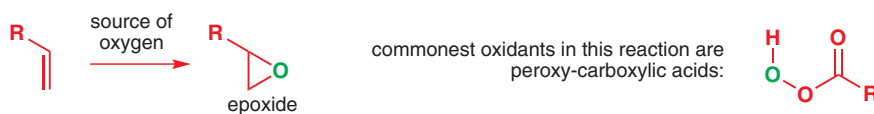

The simplest epoxide, ethylene oxide (or oxirane itself), can be produced on the tonne scale by the direct oxidation of ethene with oxygen at high temperature over a silver catalyst. These conditions are hardly suitable for general laboratory use, and the most commonly used epoxidizing agents are peroxy-carboxylic acids. These peroxy-acids (or peracids) have an extra oxygen atom between the carbonyl group and their acidic hydrogen—they are esters of hydrogen peroxide (H_2O_2). They are rather less acidic than carboxylic acids because their conjugate base is no longer stabilized by delocalization into the carbonyl group. But they are electrophilic at the oxygen shown here in green because attack there by a nucleophile displaces carboxylate, a good leaving group. The LUMO of a peroxy-carboxylic acid is the σ^* orbital of the weak O–O bond.

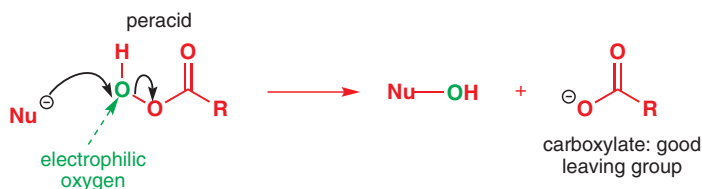

You have met epoxides being formed by intramolecular substitution reactions, but the oxidation of alkenes is a much more important way of making them. Their alternative name derives from a systematic way of naming rings: 'ox' for the O atom, 'ir' for the three-membered ring, and 'ane' for full saturation. You may meet oxetane (remember the oxaphosphetane in the Wittig reaction, Chapter 11, p. 238) and, while THF is never called oxolane, dioxolane is another name for five-membered cyclic acetals.



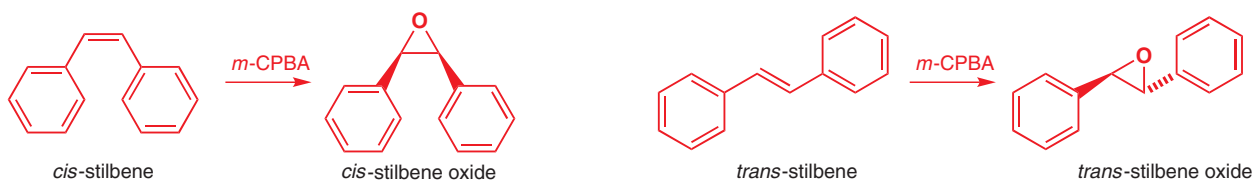

More substituted alkenes epoxidize faster

Peracids give epoxides from alkenes with any substitution pattern (except ones conjugated with electron-withdrawing groups, for which a different reagent is required: see Chapter 22), but the chart below shows how the rate varies according to the number of substituents on the double bond.

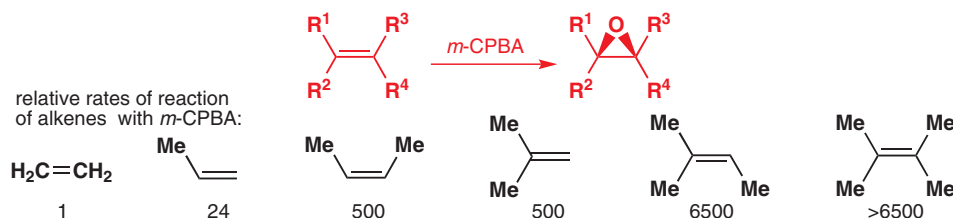

Not only are more substituted double bonds more stable (as you saw in Chapter 17), but they are more nucleophilic. We showed you in Chapter 15 that alkyl groups are electron-donating because they stabilize carbocations. This same electron-donating effect raises the energy of the HOMO of a double bond and makes it more nucleophilic. You can think of it this way: every C–C or C–H bond that can allow its σ orbital to interact with the π orbital of the alkene will raise the HOMO of the alkene slightly, as shown by the energy level diagram. The more substituents the alkene has, the more the energy is raised.

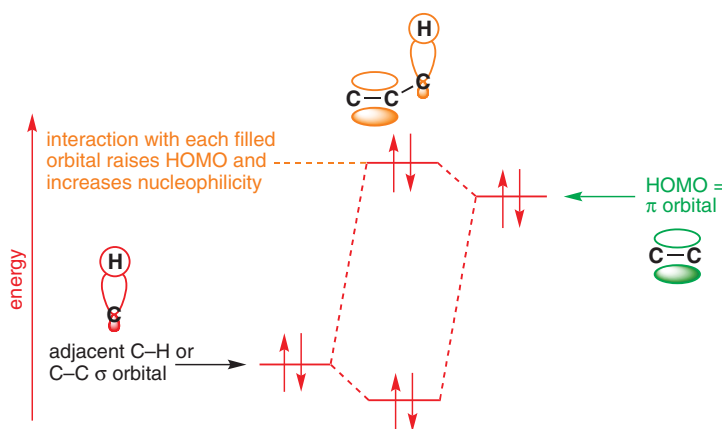

The differences in reactivity between alkenes of different substitution patterns can be exploited to produce the epoxide only of the more reactive alkene of a pair, provided the supply of oxidant is limited. In the first example below, a tetrasubstituted alkene reacts in preference to a *cis* disubstituted one. Even when two alkenes are equally substituted, the effect of epoxidizing one of them is to reduce the nucleophilicity of the second (the new oxygen atom is electron-withdrawing, and dienes are in general more nucleophilic than alkenes: see below). The monoepoxide of cyclopentadiene is a useful intermediate and can be prepared by direct epoxidation of the diene under buffered conditions.

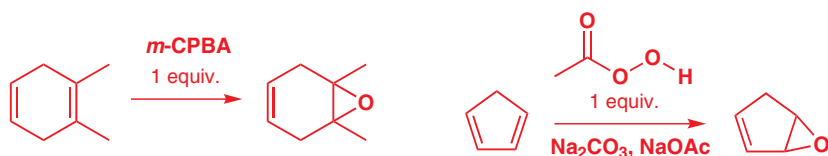

■ The sodium carbonate/sodium acetate added here is a *buffer*, used to prevent the reaction mixture becoming too acidic—remember, the carboxylic acid is a by-product of the epoxidation. Some epoxides are unstable in acid, as we shall see shortly.

■ *Spiro* compounds have two rings joined at a single atom. Compare **fused** rings (joined at two adjacent atoms) and **bridged** rings (joined at two non-adjacent atoms) (see p. 653).

p-Nitroperoxybenzoic acid is dangerously explosive, and it is sufficiently reactive to produce this remarkable and highly strained *spiro* epoxide (oxaspiropentane), which was made in order to study its reactions with nucleophiles.

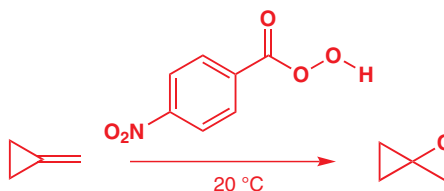

Dimethyldioxirane and carcinogenic epoxides

Certain fungi, especially the mould *Aspergillus* sp. (which grows on damp grain), produce a group of the most carcinogenic substances known to man, the aflatoxins. One of the toxins (which are, of course, entirely natural) is metabolized in the human body to the epoxide shown below. Some chemists in the USA decided to synthesize this epoxide to investigate its reaction with DNA, hoping to discover exactly how it causes cancer. The epoxide is far too reactive to be made using a peroxy-acid (because of the acidic by-product), and instead these chemists used a reagent called dimethyldioxirane.

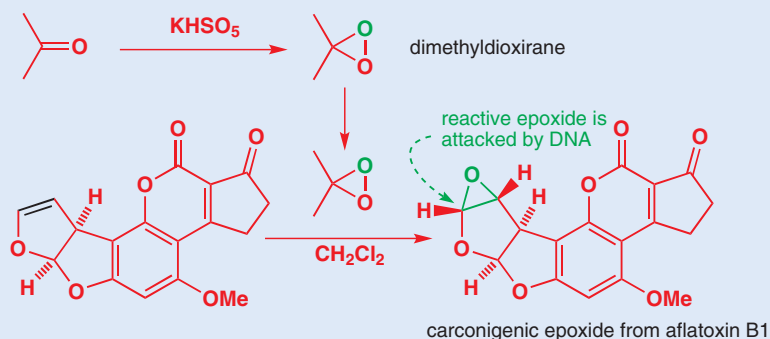

Dimethyldioxirane is made by oxidizing acetone with KHSO_5 , but is too reactive to be stored for more than a short period in solution. After it has transferred an oxygen atom in the epoxidation step, only innocuous acetone is left, as shown by the mechanism below.

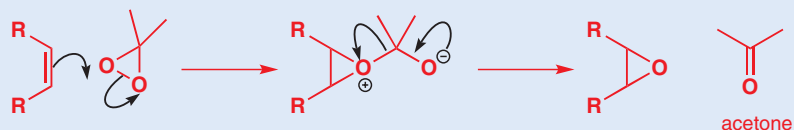

The liver is home to a wide variety of enzymes that carry out oxidation—the aim is to make unwanted water-insoluble molecules more polar and therefore soluble by peppering them with hydroxyl groups. Unfortunately, some of the intermediates in the oxidation processes are highly reactive epoxides that damage DNA. This is the means by which aromatic hydrocarbons may cause cancer, for example. Note that it is very hard to oxidize benzene by chemical (rather than biological) methods.

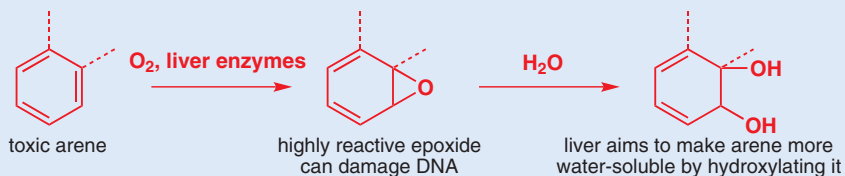

Electrophilic addition to unsymmetrical alkenes is regioselective

In epoxidation reactions, and in electrophilic additions of bromine, each end of the alkene is joined to the same sort of atom (Br or O). But in the addition reactions of other electrophiles, H–Br for example, there is a choice: which carbon gets the H and which gets the Br? You will need to be able to predict, and to explain, reactions of unsymmetrical alkenes with HBr, but we should start by looking at the reaction with a symmetrical alkene—cyclohexene. This is what happens. When H–Br reacts as an electrophile, it is attacked at H, losing Br[−]. Unlike a bromine atom, a hydrogen atom can't form a three-membered ring cation—it has no lone pairs to use. So electrophilic addition of a proton (which is what this is) to an alkene gives a product best represented as a carbocation. This carbocation rapidly reacts with the bromide ion just formed. Overall, H–Br adds across the alkene. This is a useful way of making simple alkyl bromides.

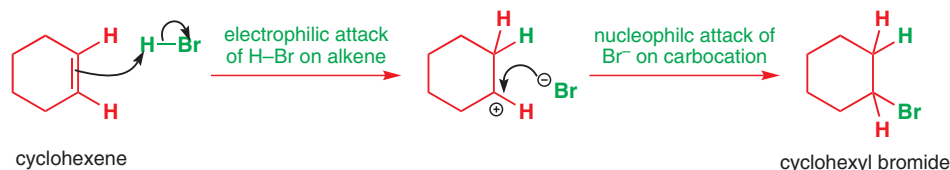

Here are two more syntheses of alkyl bromides, but this time we need to ask our question about which end of the alkene is attacked because the alkenes are unsymmetrical (they have different substituents at each end). First, the results.



In each case, the bromine atom ends up on the more substituted carbon, and the mechanism explains why. There are two possible outcomes for protonation of styrene by HBr, but you should immediately be able to spot which is preferred, even if you don't know the outcome of the reaction. Protonation at one end gives a stabilized benzylic cation, with its positive charge delocalized into the benzene ring.

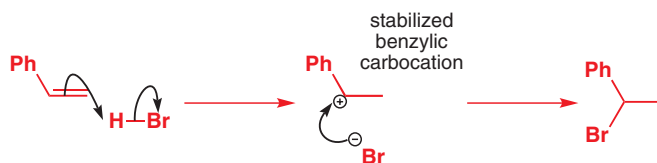

Protonation at the other end would give a highly unstable primary cation, and therefore does not take place.

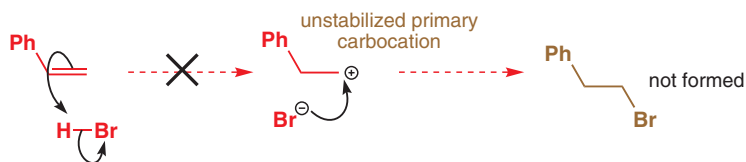

You get the same result with isobutene (2-methylpropene): the more stable tertiary cation leads to the product; the alternative primary cation is not formed.

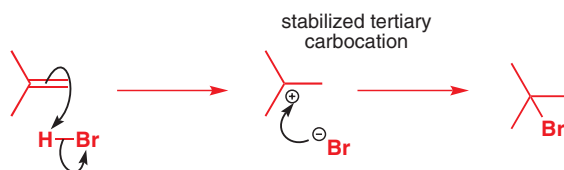

Markovnikov's rule

There is a traditional guideline called Markovnikov's rule for electrophilic additions of H-X to alkenes, which can be stated as: 'The hydrogen ends up attached to the carbon of the double bond that had more hydrogens to start with.' We don't suggest you learn this rule, although you may hear it referred to. As with all 'rules' it is much more important to understand the reason behind it. For example, *you* can now predict the product of the reaction below. With all due respect, Markovnikov couldn't.



The protonation of alkenes to give carbocations is quite general. The carbocations may trap a nucleophile, as you have just seen, or they may simply lose a proton to give back an alkene. This is just the same as saying the protonation is reversible, but it needn't be the same proton that is lost. A more stable alkene may be formed by losing a different proton, which means that acid can catalyze the isomerization of alkenes—both between *Z* and *E* geometrical isomers and between regioisomers.

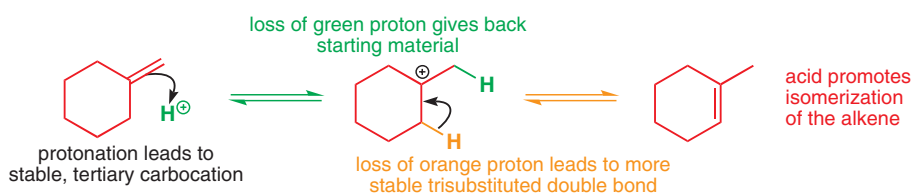

E1 and isomerization

The isomerization of alkenes in acid is probably a good part of the reason why E1 eliminations in acid generally give *E* alkenes. In Chapter 17 we explained how *kinetic* control could lead to *E* alkenes: interconversion of *E* and *Z* alkenes under the conditions of the reaction allows the *thermodynamic* product to prevail. This was also discussed in Chapter 12.

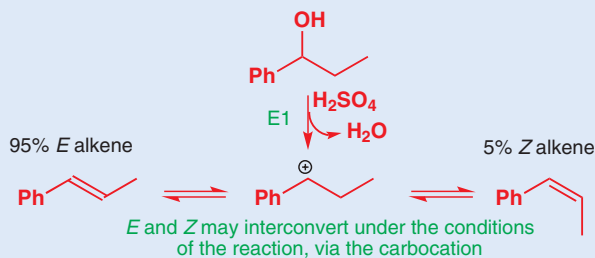

Other nucleophiles may also intercept the cation, for example alkenes can be treated with HCl to form alkyl chlorides, with HI to form alkyl iodides, and with H₂S to form thiols.

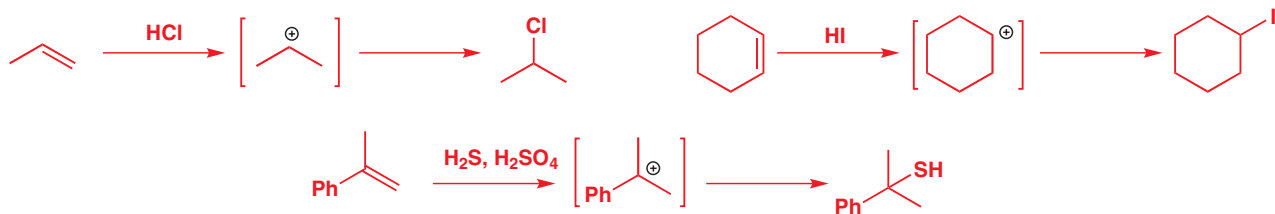

Electrophilic addition to dienes

Earlier in the chapter you saw the epoxidation of a diene to give a monoepoxide: only one of the double bonds reacted. This is quite a usual observation: dienes are more nucleophilic than isolated alkenes. This is easy to explain by looking at the relative energy of the HOMO of an alkene and a diene—this discussion is on p. 138 of Chapter 7. Dienes are therefore very susceptible to protonation by acid to give a cation. This is what happens when 2-methylbuta-1,3-diene (isoprene) is treated with acid. Protonation gives a stable delocalized allylic cation.

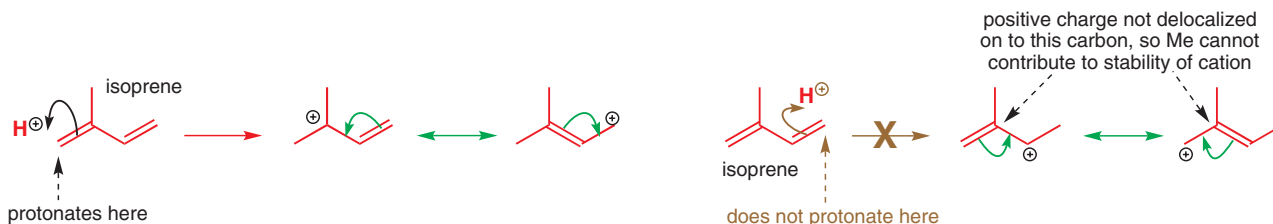

Why protonate this double bond and not the other one? The cation you get by protonating the other double bond is also allylic, but it cannot benefit from the additional stabilization from the methyl group because the positive charge is not delocalized on to the carbon carrying the methyl.

If the acid is HBr, then nucleophilic attack by Br on the cation follows. The cation is attacked at the less hindered end to give the important compound prenyl bromide. This is very much the sort of reaction you met in Chapter 15—it is the second half of an S_N1 substitution reaction on an allylic compound.

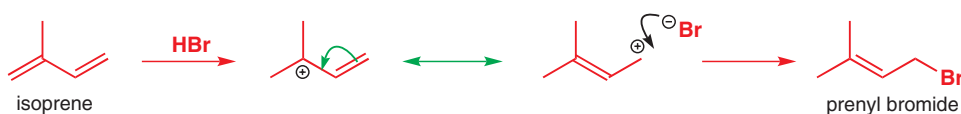

Overall, the atoms H and Br are added to the ends of the diene system. The same appears to be the case when dienes are brominated with Br_2 .

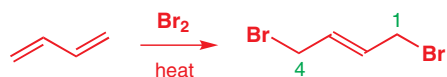

Changing the conditions slightly gives a different outcome. If the reaction is done at lower temperatures, the bromine just adds across one of the double bonds to give a 1,2-dibromide.

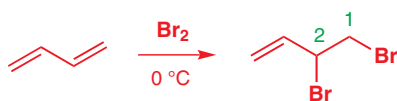

This compound turns out to be the kinetic product of the bromination reaction. The 1,4-dibromide is formed only when the reaction is heated, and is the thermodynamic product. The mechanism is electrophilic attack on the diene to give a bromonium ion, which bromide opens to give the dibromide. We have shown the bromide attacking the more substituted end of the bromonium ion—although we can't know this for sure (attack at either end gives the same product), you are about to see (in the next section) evidence that this is the usual course of reactions of unsymmetrical bromonium ions.

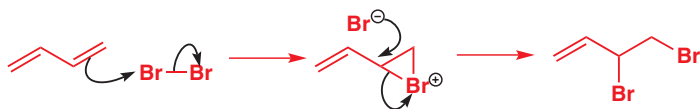

► If you need reminding about kinetic and thermodynamic control, look back at p. 264, Chapter 12.

This 1,2-dibromide can still react further because it can undergo nucleophilic substitution. Bromide is a good nucleophile and a good leaving group and, with an allylic system like this, an S_N1 reaction can take place in which both the nucleophile and the leaving group are bromide. The intermediate is a cation, but here the carbocation is disguised as the bromonium ion because bromine's lone pair can help stabilize the positive charge. Bromide can attack where it left, returning to starting material, but it can also attack the far end of the allylic system, giving the 1,4-dibromide. The steps are all reversible at higher temperatures, so the fact that the 1,4-dibromide is formed under these conditions must mean it is more stable than the 1,2-dibromide. It is not hard to see why: it has a more substituted double bond and the two large bromine atoms are further apart.



Interactive mechanism for bromination of butadiene

Unsymmetrical bromonium ions open regioselectively

We ignored the issue of symmetry in the alkene when we discussed the bromination of alkenes because even unsymmetrical alkenes give the same 1,2-dibromides, whichever way the bromide attacks the bromonium ion.

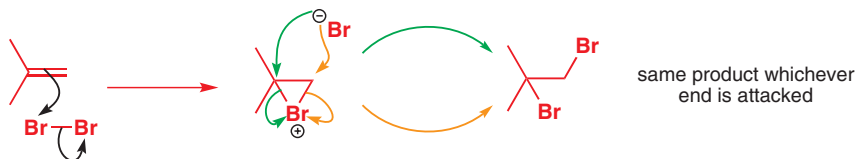

But when a bromination is done in a nucleophilic solvent—water or methanol, for example—solvent molecules compete with the bromide to open the bromonium ion. As you know, alcohols are much worse nucleophiles than bromide but, because the concentration of solvent is so high (remember—the concentration of water in water is 55 M), the solvent gets there first most of the time. This is what happens when isobutene is treated with bromine in methanol. An ether is formed by attack of methanol only at the *more substituted* end of the bromonium ion. When a functional group can react in more than one position, the choice is known as the *regioselectivity* of the reaction. We will return to the concept of regioselectivity in Chapter 24.

► We deduced this number in Chapter 8.

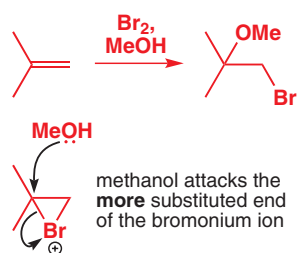

Methanol is attacking the bromonium ion where it is most hindered, so there must be some effect at work more powerful than steric hindrance. One way of looking at this is to reconsider our assumption that bromonium ion opening is an S_N2 process. Here, it hardly looks S_N2 . We have a tertiary centre, so naturally you expect S_N1 , via the cation below. But we have already said that cations like this can be stabilized by formation of the three-membered bromonium ion and, if we let this happen, we have to attack the bromonium ion, which gets us back to where we started: an S_N2 mechanism!

two limiting mechanisms for substitution on bromonium ion

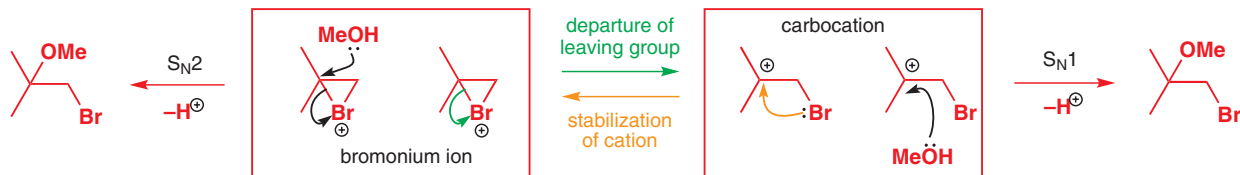

The answer to the conundrum is that substitution reactions don't always go by pure S_N1 or pure S_N2 mechanisms: sometimes the mechanism is somewhere in between. Perhaps the leaving group starts to leave, creating a partial positive charge at carbon, which is intercepted by the nucleophile. This provides a good explanation of what is going on here. The bromine begins to leave and a partial positive charge builds up at carbon. The departure of bromine can get to a more advanced state at the tertiary end than at the primary end because the substituents stabilize the build-up of positive charge. A more accurate representation of this bromonium ion is shown in the margin, with one C–Br bond longer than the other and more polarized than the other.

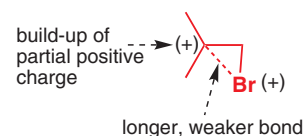

The nucleophile now has a choice: does it attack the more accessible, primary end of the bromonium ion, or does it attack the more charged end with the weaker C–Br bond? Here, the latter is clearly the faster reaction. The transition state has considerable positive charge on carbon and is known as a loose S_N2 transition state.

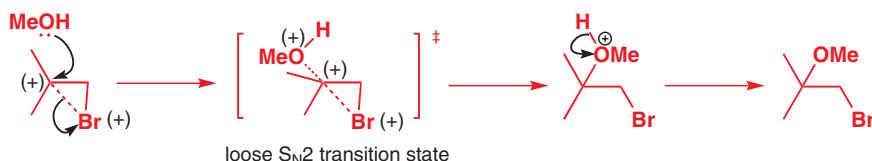

Interactive mechanism for regioselective addition to unsymmetrical alkenes

The products of bromination in water are called bromohydrins. They can be treated with base, which deprotonates the alcohol. A rapid intramolecular S_N2 reaction follows: bromide is expelled as a leaving group and an epoxide is formed. This can be a useful alternative synthesis of epoxides avoiding peroxy-acids.

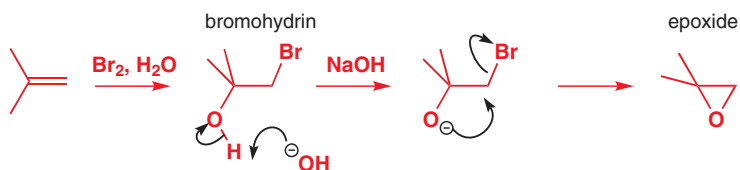

Rates of bromination of alkenes

The pattern you saw for epoxidation with peracids (more substituted alkenes react faster) is followed by bromination reactions too. The bromonium ion is a reactive intermediate, so the rate-determining step of the brominations is attack of bromine. The scale below shows the effect on the rate of reaction with bromine in methanol of increasing the number of alkyl substituents from none

(ethylene) to four. Each additional alkene substituent produces an enormous increase in rate. The degree of branching (Me versus *n*-Bu versus *t*-Bu) within the substituents has a much smaller, negative effect (probably of steric origin) as does the geometry (*E* versus *Z*) and substitution pattern (1,1-disubstituted versus 1,2-disubstituted) of the alkene.

relative rates of reaction of alkenes with bromine in methanol

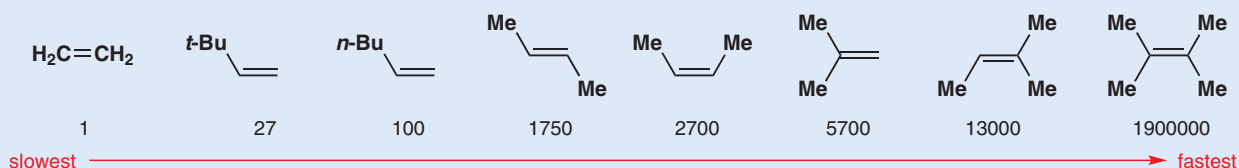
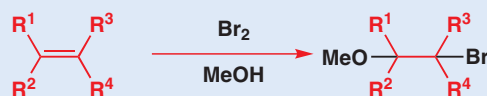

The regioselectivity of epoxide opening can depend on the conditions

Alkoxides are never leaving groups in S_N2 reactions: it's the strain alone which makes epoxides reactive.

Although epoxides, like bromonium ions, contain strained three-membered rings, they require either acid catalysis or a powerful nucleophile to react well. Compare these two reactions of a 1,1,2-trisubstituted epoxide. They are nucleophilic substitutions related to those we introduced in Chapter 15 (p. 352) but in that chapter we carefully avoided discussing epoxides of the unsymmetrical variety. In this example, the regiochemistry reverses with the reaction conditions. Why?

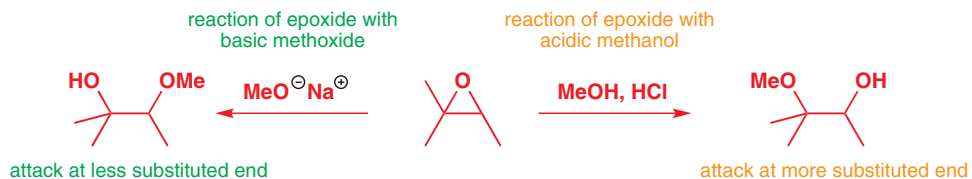

We'll start with the acid-catalysed reaction because it is more similar to the examples we have just been discussing—opening happens at the more substituted end. Protonation by acid produces a positively charged intermediate that bears a passing resemblance to the corresponding bromonium ion. The two alkyl groups make possible a build-up of charge on the carbon at the tertiary end of the protonated epoxide, and methanol attacks here, just as it does in the bromonium ion. You could think of the protonated leaving group 'pulling' the otherwise unreactive methanol in towards the reactive centre.

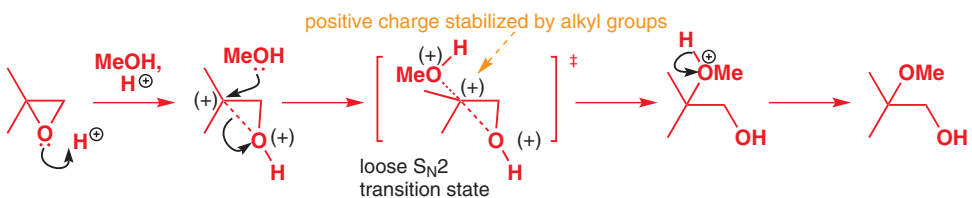

Remember, S_N1 can be fast only with good leaving groups (Chapter 15).

In base there can be no protonation of the epoxide and no build-up of positive charge. Without protonation, the epoxide oxygen is a poor leaving group, and leaves only if 'pushed' by a strong nucleophile: the reaction becomes pure S_N2 . Steric hindrance becomes the controlling factor and methoxide attacks only the primary end of the epoxide.

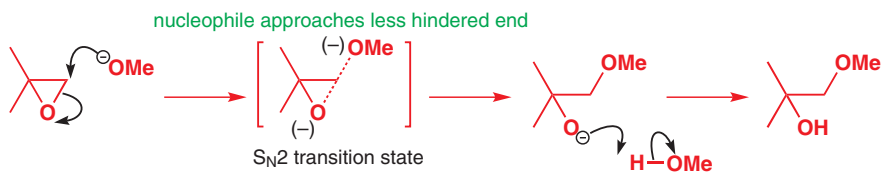

This example makes the matter look deceptively clear cut. But with epoxides, regioselectivity is not as simple as this because, even with acid catalysts, S_N2 substitution at a primary centre is fast. For example, Br^- in acid attacks the epoxide below mainly at the less substituted end, and only 24% of the product is produced by the 'cation-stabilized' pathway. It is very difficult to override the preference of epoxides unsubstituted at one end to react at that end.

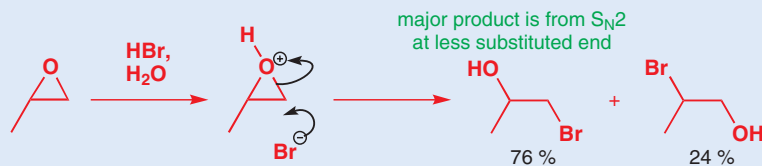

For most substitution reactions of epoxides, then, regioselectivity is much higher if you give in to the epoxide's desire to open at the less substituted end and enhance it with a strong nucleophile under basic conditions.

Electrophilic additions to alkenes can be stereospecific

Although they really belong in Chapter 15 with other nucleophilic substitution reactions, we included the last few examples of epoxide-opening reactions here because they have many things in common with the reactions of bromonium ions. Now we are going to make the analogy work the other way by looking at the stereochemistry of the reactions of bromonium ions, and hence at the stereoselectivity of electrophilic additions to alkenes. We shall first remind you of an epoxide reaction from Chapter 15, where you saw this.

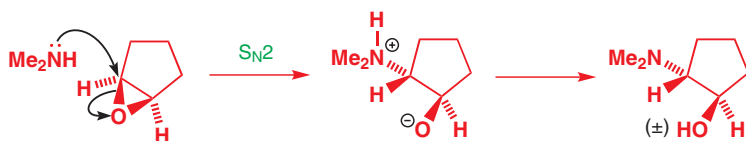

The epoxide ring opening is stereospecific: it is an S_N2 reaction and it goes with inversion. The epoxide starts on the top face of the ring and the amino group therefore ends up on the bottom face. In other words, the two groups end up *anti* or *trans* across the ring. You now know how to make this epoxide—you would use cyclopentene and *m*-CPBA, and in two steps you could ‘add’ an OH group and a Me_2N group *anti* across the double bond.



■ The reaction is stereospecific because it's the stereochemistry of the epoxide that determines the outcome of the reaction. The S_N2 reaction has no choice but to go with inversion. We discussed the terms ‘stereospecific’ and ‘stereoselective’ on p. 396.

■ Notice the (\pm) symbol below the products. They are single diastereoisomers, but they are *necessarily* formed as racemic mixtures, as we discussed in Chapter 14. You can look at it this way: the Me_2NH will attack the two identical ends of the epoxide with precisely equal probability. Both give the same *anti* diastereoisomer, but each gives an opposite enantiomer. The two enantiomers will be formed in precisely equal amounts.

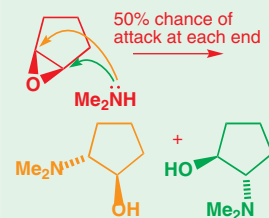

■ We don't need to write (\pm) next to the isomer that isn't formed because it is an achiral structure—it has a plane of symmetry and would be a *meso* compound (see p. 317).

 Interactive mechanism for reaction of cyclohexene with bromine

Now we can move on to look at the stereochemistry of electrophilic addition to alkenes.

Electrophilic addition to alkenes can produce stereoisomers

When cyclohexene is treated with bromine in carbon tetrachloride, the racemic *anti*-1,2-dibromocyclohexane is obtained exclusively.



The result is no surprise if we think first of the formation of the bromonium ion that is opened with inversion in an S_N2 reaction.

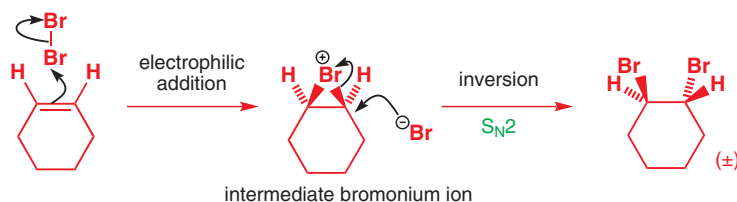

Bromination of alkenes is stereospecific because the geometry of the starting alkene determines which product diastereoisomer is obtained. We couldn't demonstrate this with cyclohexene because only a *Z* double bond is possible in a six-membered ring. But bromination or chlorination of *Z* and *E*-2-butene in acetic acid produces a single diastereoisomer in each case, and they are different from each other. *Anti* addition occurs in both cases—more evidence that a bromonium ion is the intermediate.

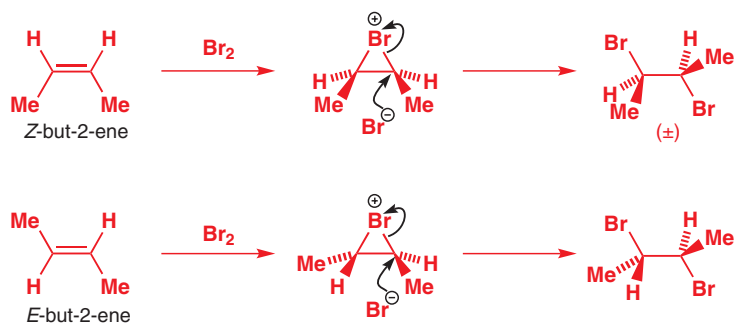

The stereochemistry of the products is a bit clearer if we redraw them, and in the scheme below the product of each reaction is shown in two different ways. Firstly, the products have been rotated to place the carbon chain in the plane of the paper: in this conformation you can clearly see that there has been an *anti* addition across the *E* double bond. Secondly, the middle bond has been twisted 180° to give an (unrealistically) eclipsed conformation. We show this conformation for two reasons: now you can clearly see that there has been an *anti* addition across the *Z* double bond too. It also makes it quite clear that the product of the *E*-butene bromination is achiral: you can see the plane of symmetry in this conformation, and this is why we haven't placed (±) signs next to the products from the *E* alkene.

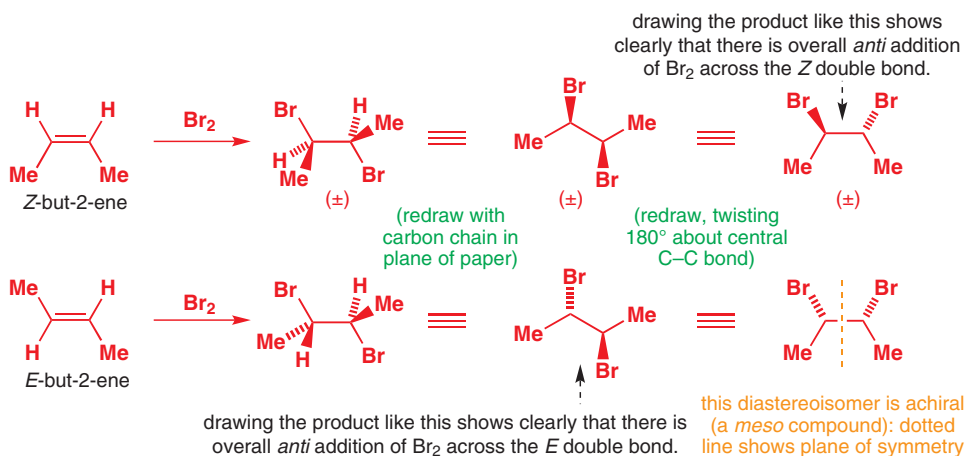

Interactive mechanism for stereospecific *anti* addition to alkenes

Note that in all three different views of each product the same stereoisomer is represented. There is no change of configuration, only changes of conformation to help you understand what is going on. If you cannot follow any of the 'redrawing' steps, make a model. With practice, you will soon learn to manipulate mental models in your head, and to see what happens to substituents when bonds are rotated. Most importantly, don't let all of this more subtle stereochemical discussion cloud the simple message:

- Bromine undergoes *anti* addition to alkenes.

Bromonium ions as intermediates in stereoselective synthesis

You will not be surprised to learn that the other nucleophiles (water and alcohols) you saw intercepting bromonium ions earlier in the chapter also do so stereospecifically. The following reaction can be done on a large scale and produces a single diastereoisomer of the product (racemic, of course) because water opens the bromonium ion with inversion.

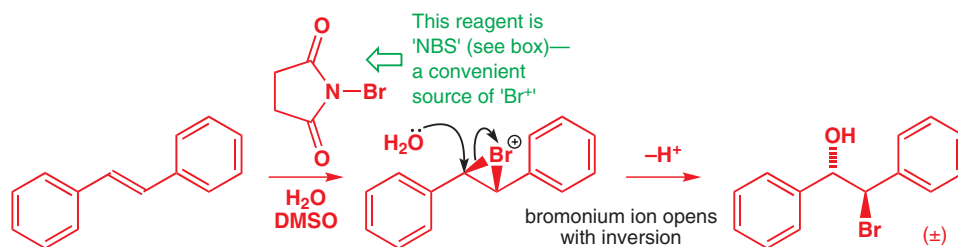

N-Bromosuccinimide, NBS

The reagent used to form the bromonium ion here is called *N*-bromosuccinimide, or NBS for short. Unlike the noxious brown liquid bromine, NBS is an easily handled crystalline solid and is perfect for electrophilic addition of bromine to alkenes when the bromonium ion is not intended to be opened by Br⁻. It works by providing a very small concentration of Br₂ in solution: a small amount of HBr is enough to get the reaction going and thereafter every addition reaction produces another molecule of HBr, which liberates more Br₂ from NBS. In a sense, NBS is a source of 'Br⁺'. NBS is known to act as a source of Br₂ because the results of reactions of NBS and of Br₂ in low concentration are identical.

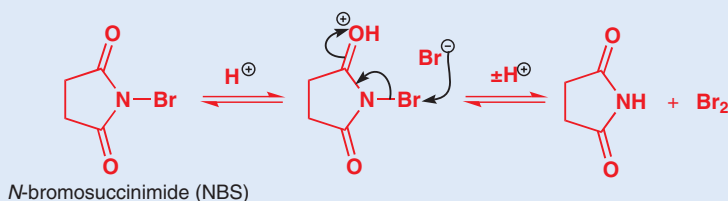

The reagent NBS generates only a low concentration of Br₂, so the concentration of Br⁻ is always low and alcohols compete with Br⁻ to open the epoxide even if they are not the solvent. In the next example, the alcohol is 'propargyl alcohol', prop-2-yn-1-ol. It gives the expected *anti*-disubstituted product with cyclohexene and NBS.

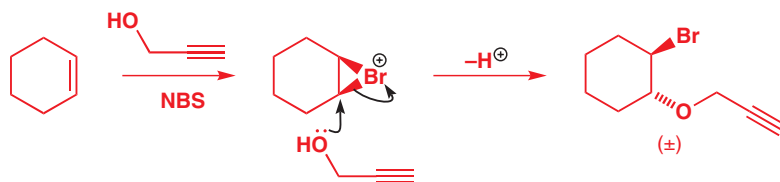

When 1-methylcyclohexene is used as the starting material, there is additionally a question of regioselectivity. The alcohol attacks the more hindered end of the bromonium ion—the end where there can be greatest stabilization of the partial positive charge in the 'loose S_N2' transition state (see p. 437). This reaction really does illustrate the way in which a mechanism can lie in between S_N1 and S_N2. Configurational inversion, indicative of an S_N2 reaction, happens at a tertiary centre, where you would usually expect S_N1.

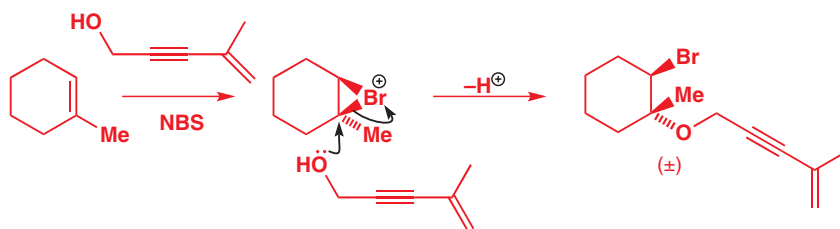

■ Notice that the bromine reacts only with the most electron-rich trisubstituted alkene and not with the disubstituted alkene or the alkyne.

Adding two hydroxyl groups: dihydroxylation

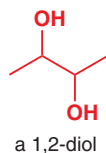

Many important compounds—the carbohydrates, for example—have two hydroxyl groups on adjacent carbon atoms. They are called 1,2-diols. A good way of making a 1,2-diol is to add two hydroxyl groups across a double bond. This can be done in two ways, each of which can give a different diastereoisomer of the product.

The first way uses chemistry you have already met. When a nucleophile opens an epoxide, it generates an alcohol. If the nucleophile is water, the product is the diol. The epoxide opening in an S_N2 reaction goes with stereochemical inversion, so in this example the two hydroxyl groups end up on opposite sides of the six-membered ring: the product is an *anti* diol. The epoxide opening reaction can be done in acid or in base.

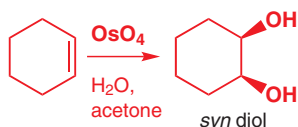
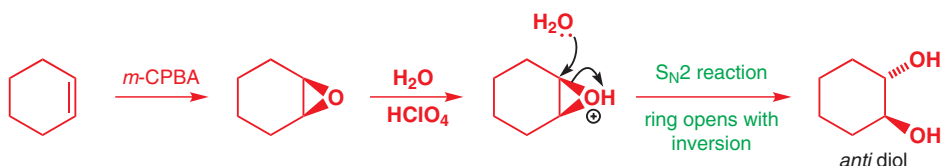

To get the *syn* diol, a completely different method is used, involving the reagent osmium tetroxide, OsO_4 . OsO_4 reacts with alkenes to deliver two hydroxyl groups—one to each end of the double bond—in a single step. Because both groups are delivered at the same time, they are always *syn* to one another: OsO_4 carries out a *syn* dihydroxylation of the double bond.

The mechanism of the reaction is different from ones you have met before and goes like this: the Os starts as tetrahedral osmium(VIII) and ends up as osmium(VI). The immediate product of the reaction is an osmate ester, but these reactions are carried out in the presence of water, and hydrolysis always follows on fast, giving the diol.

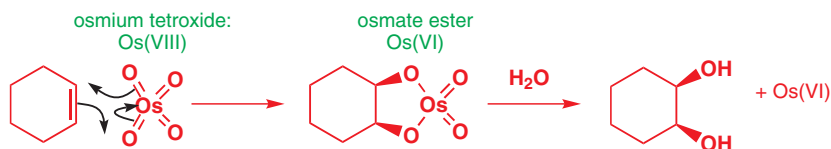

Because $Os(VI)$ is produced in the reaction, and a simple oxidation will restore it to $Os(VIII)$, the most effective version of this reaction makes use of just a catalytic amount of $Os(VIII)$ and a stoichiometric amount of a reoxidant, often the compound NMO, or *N*-methylmorpholine-*N*-oxide. In the example below there is only one new chiral centre, so no possibility of diastereoisomers.

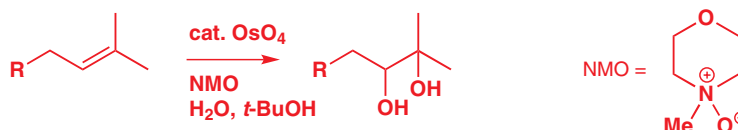

Because OsO_4 adds two hydroxyl groups to an alkene in a *syn* fashion, the overall product depends on the geometry of the alkene starting material: it is stereospecific. It is similar to bromination (p. 439) in that respect, although of course bromination is an *anti* addition. You can see how two different diastereoisomers are produced from different alkenes in these two examples: both dihydroxylations are mechanistically *syn*, but redrawing the product from the *Z* alkene in its more extended form reveals *anti* stereochemistry.

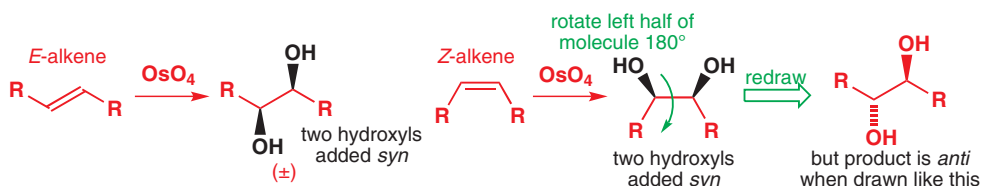

Interactive mechanism for dihydroxylation of alkenes

■ The mechanism of this reaction, in which the arrows go round in a ring and end where they started, is termed *pericyclic*: we shall discuss this in detail in Chapter 34.

■ There is more discussion of this idea in the context of bromination on p. 440. It is worthwhile thinking about the chirality of these two products too: the first is chiral, with no plane of symmetry (we have included the symbol (\pm) to remind you that although we have necessarily drawn just one enantiomer here, it must be racemic); the second is achiral, with a plane of symmetry in the first conformation shown and a centre of symmetry in the second. If this is not clear to you, look back at Chapter 15.

Breaking a double bond completely: periodate cleavage and ozonolysis

Sometimes it can be necessary to cleave a double bond completely, in other words to oxidize not just its π bond (as you have seen with Br_2 and OsO_4) but its σ bond too, as shown in the margin. This can be done in two steps using OsO_4 in conjunction with the reagent sodium periodate, NaIO_4 . The diol product forms a periodate ester, which decomposes to give two molecules of aldehyde by a cyclic mechanism similar to that for the OsO_4 step. The NaIO_4 also reoxidizes the Os(VI) to Os(VIII) so only a catalytic amount of Os is required.

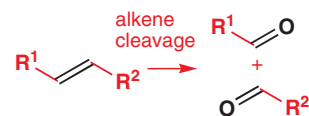
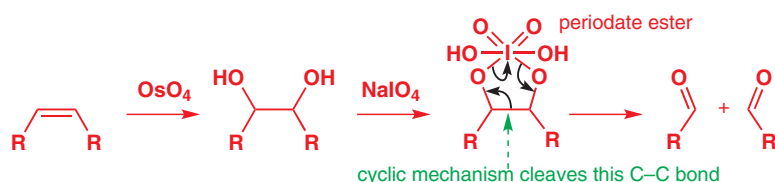

Interactive mechanism for periodate cleavage of alkenes

The process proceeds by two successive oxidations—first of the π , and then the σ bond—with different reagents (which can be added in one step or in two—you can use NaIO_4 to cleave any diol, whether or not you made it using OsO_4). But there is another reagent that will achieve double oxidation in one step: ozone.

Ozone is a symmetrical bent molecule with a central positively charged oxygen atom and two terminal oxygen atoms that share a negative charge. Ozone is unstable, and is generated immediately before use from oxygen (using a device called an ‘ozonizer’) and bubbled into the reaction mixture. Like OsO_4 , it adds to alkenes by a cyclic mechanism: the product is a five-membered ring with three oxygen atoms. It is extremely unstable and collapses by breaking a weak O–O bond and a C–C σ bond, but gains two strong C=O bonds in the process.

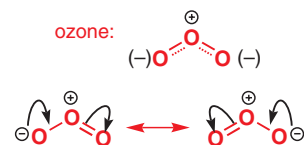
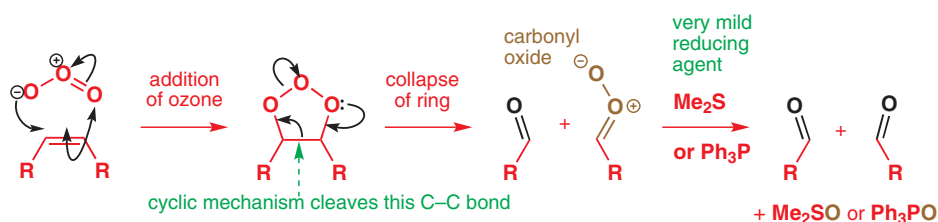

Interactive mechanism of ozonolysis

The immediate products are a simple aldehyde on the left and a new, rather unstable looking molecule known as a *carbonyl oxide* on the right. But treatment of this mixture with a very mild reducing agent such as dimethyl sulfide, Me_2S , or triphenylphosphine, Ph_3P , removes the ‘spare’ oxygen and reveals the two aldehydes.

This cleavage of an alkene by ozone is an important reaction and is known as *ozonolysis*. Ozonolysis can be used to generate not only aldehydes, but also other functional groups. Completing the reaction with oxidizing agents such as H_2O_2 will give carboxylic acids, and more powerful reducing agents such as NaBH_4 will give alcohols. Here are the overall transformations:

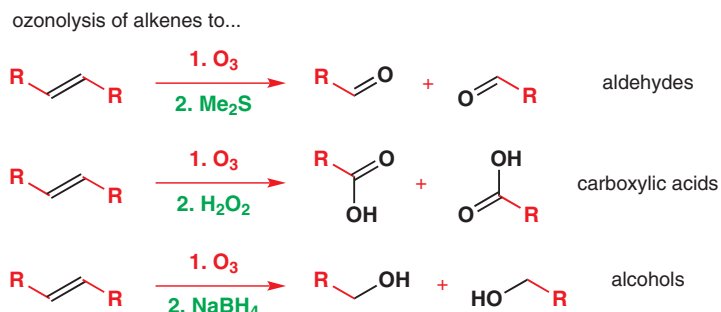

■ The mechanism by which the carbonyl oxide comes to be reduced is more complicated than we show here, and is addressed in Chapter 34.

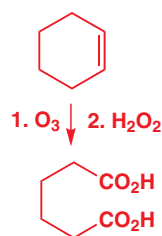

Ozonolysis of cyclohexenes is particularly useful as it gives 1,6-dicarbonyl compounds that are otherwise difficult to make. In the simplest case we get hexane-1,6-dioic acid (adipic acid), a monomer for nylon manufacture.

Adding one hydroxyl group: how to add water across a double bond

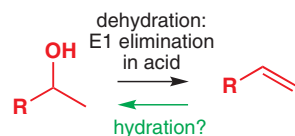

In Chapter 17 you saw alkenes being made from alcohols by E1 elimination—dehydration—under acid catalysis. The question we are going to answer in this section is: how can you make this elimination run backwards—in other words, how can you hydrate a double bond?

It is possible on occasion simply to use aqueous acid to do this. The reaction works only if protonation of the alkene can give a stable, tertiary carbocation. The cation is then trapped by the aqueous solvent.

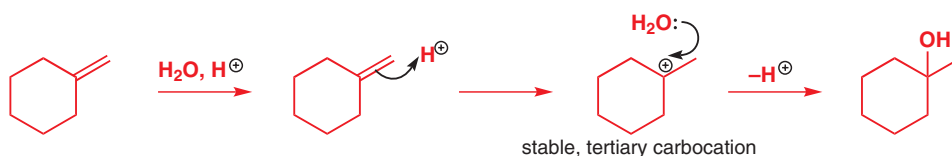

In general, though, it is difficult to predict whether aqueous acid will hydrate the alkene or dehydrate the alcohol. The method we are about to show you is much more reliable. The key is to use a transition metal to help you out. Alkenes are soft nucleophiles (p. 357) and interact well with soft electrophiles such as transition metal cations. In the margin, for example, is the complex formed between an alkene and mercury(II) cation. The complex should remind you of a bromonium ion, and rightly so because its reactions are similar. Even relatively feeble nucleophiles such as water and alcohols, when used as the solvent, open the ‘mercurinium’ ion and give alcohols and ethers. In the next scheme, the mercury(II) is supplied as mercury(II) acetate, $\text{Hg}(\text{OAc})_2$, which we shall represent with two covalent Hg–O bonds. Unsurprisingly, water attacks at the more substituted end of the positively charged mercurinium ion.

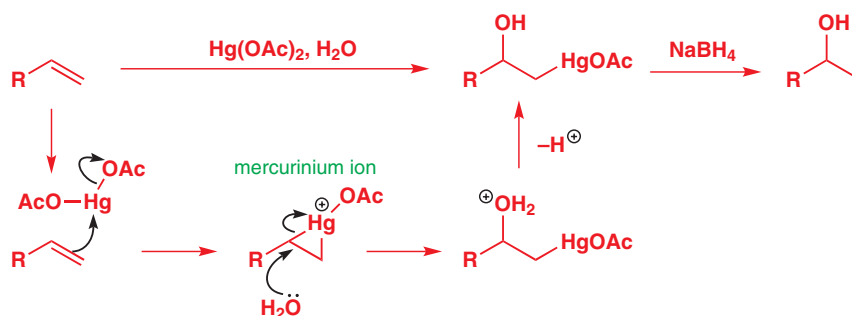
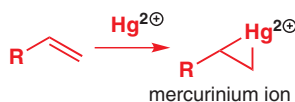

■ The demercuration step involves radical chemistry, which is discussed in Chapter 37. You will find much more on organometallic compounds and their reactions in Chapter 40.

We’ve added OH and Hg(II) across the alkene, and the reaction is termed an ‘oxymercuration’. But a problem remains: how to get rid of the metal. The C–Hg bond is very weak and the simplest way to replace Hg with H is by using a reducing agent: NaBH_4 works fine.

Below is an example of oxymercuration–demercuration at work. The intermediate mercury compound is not isolated.

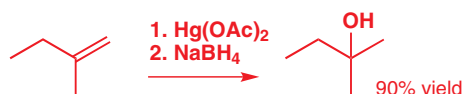

Hydration of alkynes

Oxymercuration works particularly well with alkynes. Here are the conditions, and the product, following the analogy of alkene hydration, should be the compound shown at the right-hand end of the scheme below.



But the product isolated from an alkyne oxymercuration is in fact a ketone. You can see why if you just allow a proton on this initial product to shift from oxygen to carbon—first protonate at C then deprotonate at O. C=O bonds are stronger than C=C bonds, and this simple reaction is very fast.

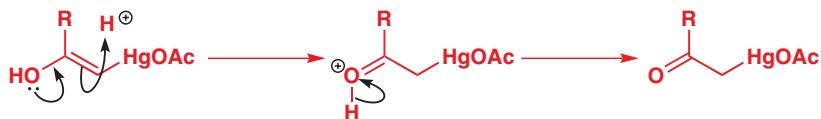

We now have a ketone, but we also still have the mercury. That is no problem when there is a carbonyl group adjacent because any weak nucleophile can remove mercury in the presence of acid, as shown below. Finally, another proton transfer (from O to C again) gives the real product of the reaction: a ketone.

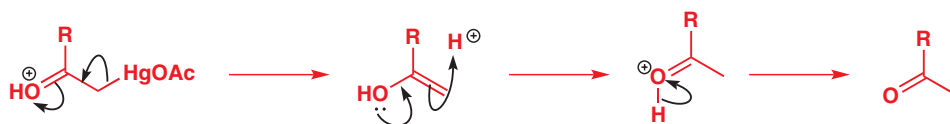

This is a very useful way of making methyl ketones because terminal alkynes can be made using the methods of Chapter 9 (addition of metallated alkynes to electrophiles).



Enols

These alkenes carrying hydroxyl groups are called enols (ene + ol), and they are among the most important intermediates in chemistry. They happen to be involved in this reaction, and this was a good way to introduce you to them but, as you will see in the next chapter and beyond, enols (and their deprotonated sisters, enolates) have far-reaching significance in chemistry.

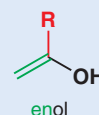

Anticancer compounds

The anthracycline class of anticancer compounds (which includes daunomycin and adriamycin) can be made using a mercury(II)-promoted alkyne hydration. You saw the synthesis of alkynes in this class on Chapter 9, where we discussed additions of metallated alkynes to ketones. Here is the final step in a synthesis of the anticancer compound deoxydaunomycinone: the alkyne is hydrated using Hg^{2+} in dilute sulfuric acid to give the final product.

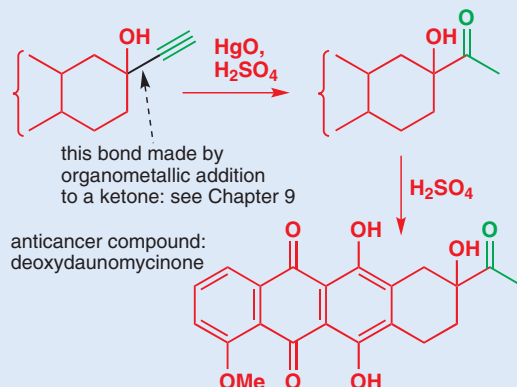

Hydroboration

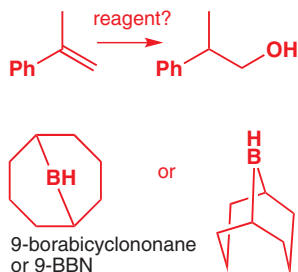

These methods for adding water across a double or triple bond involve cationic intermediates, and always end up putting the new hydroxyl group at the position best able to stabilize a positive charge (see p. 433). By what about addition of water the other way round? How would you do the reaction in the margin for example?

The answer is to make use of yet another element: boron. Boranes, including both BH_3 itself and analogues with one or two alkyl groups, HBR_2 (an important example is shown in the margin), add to alkenes to make a new C–H bond and a new C–B bond by a mechanism we can write like this. The alkene pushes electrons into the boron's empty p orbital, while the hydrogen transfers onto the alkene.

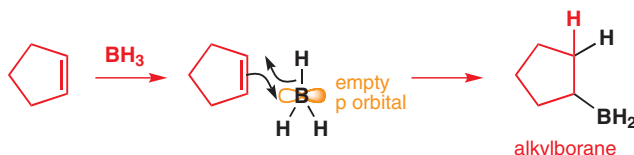

■ Why does B end up on the less substituted carbon? This is partly due to electronics—the reaction is driven by donation of the alkene's π electrons into the empty p orbital of the boron atom, so positive charge builds up at the other (more substituted) end of the alkene—and partly due to steric factors— BR_2 is bigger than H, so it ends up where there is less steric hindrance. One of the reasons for using the borane 9-BBN above is that the B atom is made very bulky by the bicyclic ring system.

Importantly, if the alkene is unsymmetrical, the boron tends to end up on the less substituted carbon atom. This reaction can happen several times so, for example, if you start with an alkene and BH_3 , you will typically end up with a trialkylborane:

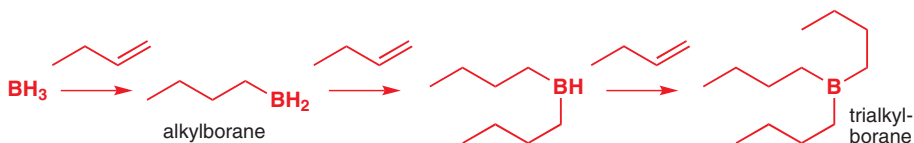

So far so good, if you want to make boranes, but we started out this section posing ourselves the problem of adding *water* across a double bond. This is where a quirk of boron chemistry helps us out. The C–B bond(s) we have just created can be oxidized to C–O bonds by using a mixture of NaOH and H_2O_2 . The mixture generates the hydroperoxide anion $\text{HO}-\text{O}^-$, which adds to that important empty p orbital on boron. The product is a negatively charged structure, shown below.

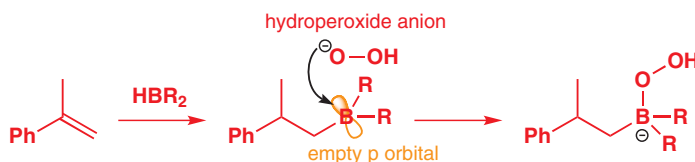

This is not stable, and it can decompose by a mechanism you should look at closely. It is not one which is familiar to you, but it makes sense if you think about it. The O–O bond is weak and can break, losing HO^- . As it does so, one of the alkyl groups on boron can migrate from B to O, relieving the boron atom of its negative charge, to give the structure shown below.

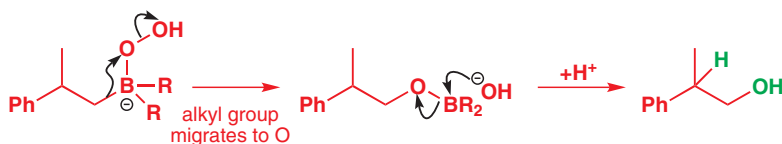

Interactive mechanism of hydroboration

➔ This mechanism, in which a C–B bond is exchanged for another C–X bond, is typical reactivity for boron. It has some similarity also with the Baeyer–Villiger oxidation, Chapter 36.

We now have the C–O bond where we want it, and all that has to happen is for the hydroxide anion to come back in and displace B from the alcohol product. The product, on protonation, is our alcohol. How can we be sure the correct R group will migrate? Well, if we use BH_3 we will get a trialkylborane, where all three groups on boron are the same, and all three C–B bonds can be oxidized one after another. If we use the HBR_2 reagent 9-BBN, then only the non-cyclic substituent formed in the hydroboration reaction will migrate, selectively giving us the product we want.

To conclude...a synopsis of electrophilic addition reactions

Electrophilic addition to double bonds gives three-membered ring intermediates with Br_2 , with Hg^{2+} , and with peroxy-acids (in which case the three-membered rings are stable and are called epoxides). All three classes of three-membered rings react with nucleophiles to give 1,2-difunctionalized products with control over (1) regioselectivity and (2) stereoselectivity. Protonation of a double bond gives a cation, which also traps nucleophiles, and this reaction can be used to make alkyl halides. Some of the sorts of compounds you can make by the methods of this chapter are shown below.

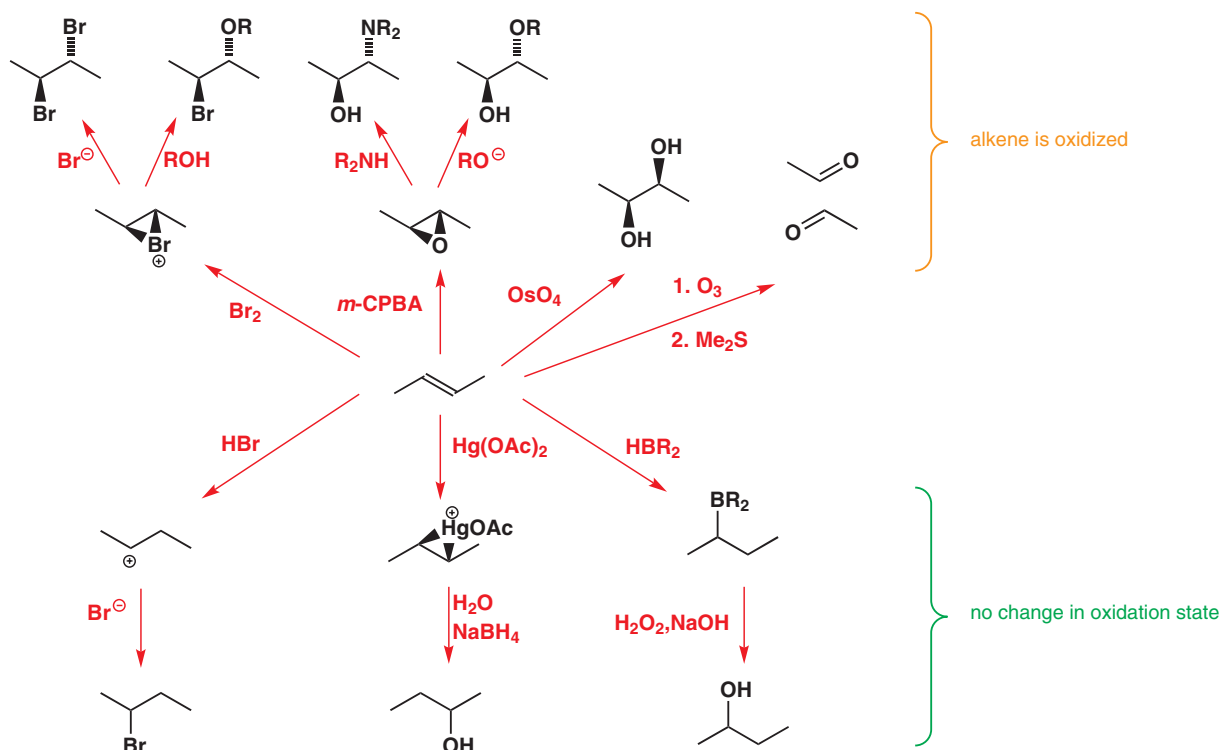

Further reading

The orbital arguments in this chapter are also treated in *Molecular Orbitals and Organic Chemical Reactions: Student Edition* by Ian Fleming, Wiley, Chichester, 2009. F. A. Carey and R. J. Sundberg, *Advanced Organic Chemistry A, Structure and Mechanisms*, 5th edn,

Springer, 2007, chapter 5, treats both elimination and addition reactions.

The stable bromonium ion on p. 428 was characterized by R. S. Brown et al., *J. Am. Chem. Soc.*, 1994, **116**, 2448.

Check your understanding



To check that you have mastered the concepts presented in this chapter, attempt the problems that are available in the book's Online Resource Centre at <http://www.oxfordtextbooks.co.uk/orc/clayden2e/>

Formation and reactions of enols and enolates

20

Connections

➔ Building on

- Carbonyl chemistry [ch6](#), [ch9](#), [ch10](#), & [ch11](#)
- Electrophilic additions to alkenes [ch19](#)

Arriving at

- How carbonyl compounds exist in equilibrium with isomers called enols
- How acid or base promotes the formation of enols and their conjugate bases, enolates
- How enols and enolates have inherent nucleophilic reactivity
- How this reactivity can be exploited to allow the introduction of functional groups next to carbonyl groups
- How silyl enol ethers and lithium enolates can be used as stable enolate equivalents

➔ Looking forward to

- Aromatic compounds as nucleophiles [ch21](#)
- The use of enolates in the construction of C–C bonds [ch25](#) & [ch26](#)
- The central position of enolate chemistry in the chemist's methods of making molecules [ch28](#)

We make no apologies for the number of pages we have devoted to carbonyl chemistry. The first reactions you met, in Chapter 6, involved carbonyl compounds. Then in Chapters 9, 10, and 11 we considered different aspects of nucleophilic attack on electrophilic carbonyl compounds. But carbonyl compounds have two opposed sides to their characters. They can be nucleophilic as well: *electrophilic* attack on aldehydes, ketones, and acid derivatives is a useful reaction too. How can the same class of compound be subject to both nucleophilic and electrophilic attack? The resolution of this paradox is the subject of this chapter, where we shall see that most carbonyl compounds exist in two forms—one electrophilic and one nucleophilic. The electrophilic form is the carbonyl compound itself and the nucleophilic form is called the **enol**.

Would you accept a mixture of compounds as a pure substance?

You can buy dimedone (5,5-dimethylcyclohexane-1,3-dione) from chemical suppliers. If, as is wise when you buy any compound, you run an NMR spectrum of the compound to check on its purity, you might be inclined to send the compound back. In CDCl_3 solution it is clearly a mixture of two compounds. Overleaf you can see ^1H and ^{13}C NMR spectra of the mixture, with the peaks of the dione in red.

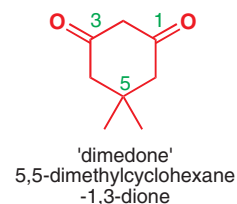

Online support. The icon  in the margin indicates that accompanying interactive resources are provided online to help your understanding: just type www.chemtube3d.com/clayden/123 into your browser, replacing **123** with the number of the page where you see the icon. For pages linking to more than one resource, type **123-1**, **123-2** etc. (replacing **123** with the page number) for access to successive links.

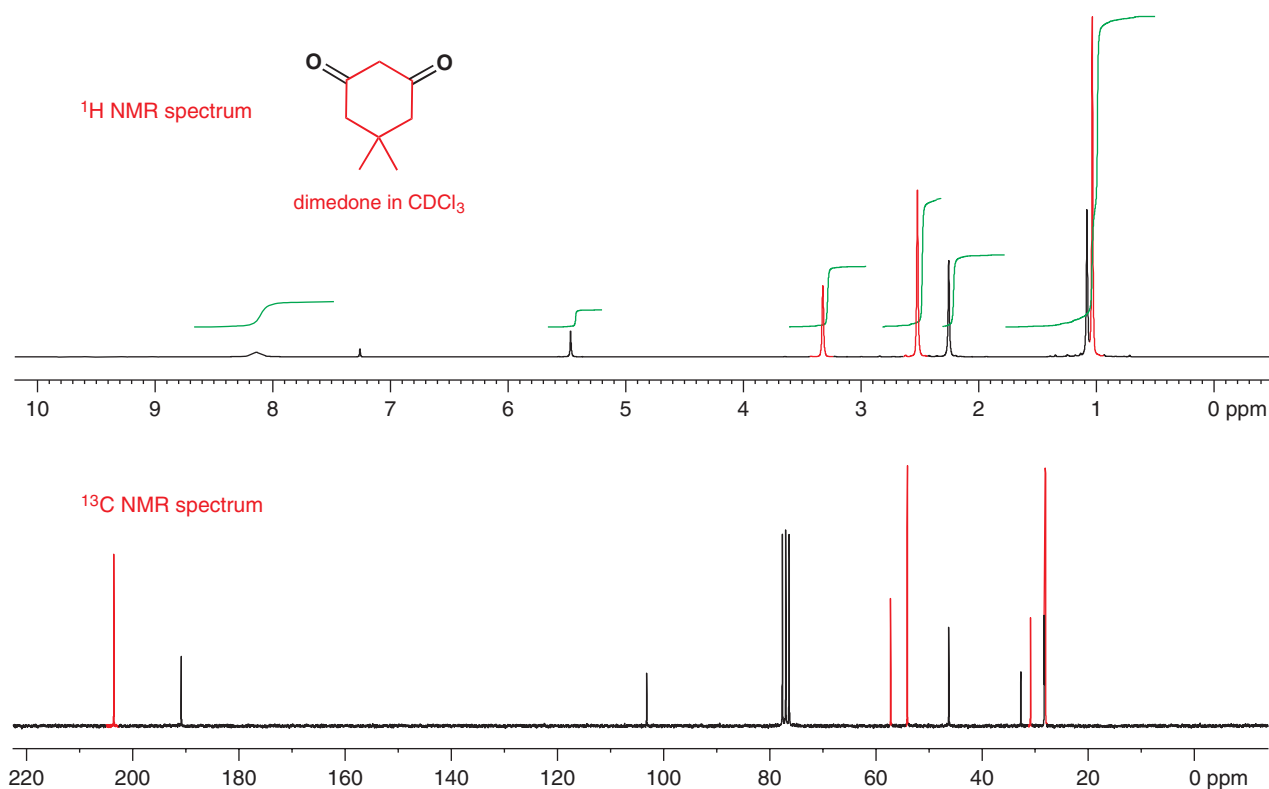

Remember to ignore the CDCl₃ solvent peaks at δ_{H} 7.25 and δ_{C} 77.

The majority of the sample is indeed 5,5-dimethylcyclohexane-1,3-dione. What is the rest? The other component has a similar spectrum and is clearly a similar compound: it has the 6H singlet for the CMe₂ group and the two CH₂ groups at the side of the ring; it also has five signals in its ¹³C NMR spectrum. But it has a broad signal at δ_{H} 8.15, which looks like an OH group, and importantly a sharp signal at δ_{H} 5.5 in the double-bond region. It also has *two different* sp² carbon atoms. All this fits the *enol* structure below.

➔ If you need reminding about the chemical shifts of different types of protons in ¹H NMR, look back to Chapter 13, p. 272.

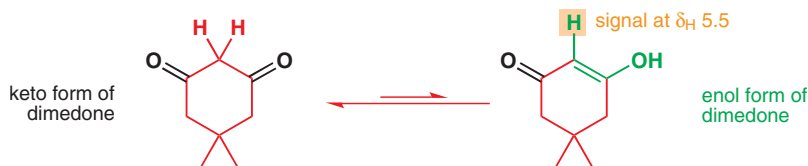

Tautomerism: formation of enols by proton transfer

An enol is exactly what the name implies: an ene-ol. It has a C=C double bond and an OH group joined directly to it. In the case of dimedone, the enol must be formed by a transfer of a proton from the central CH₂ group of the keto form to one of the OH groups, a reaction known as *enolization*.

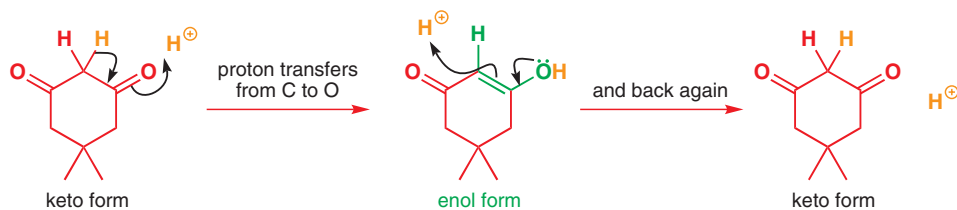

Notice that there is no change in pH—a proton is lost from carbon and gained on oxygen. It is a strange reaction in which little happens: the only change is the transfer of one

proton and the shift of the double bond. Interconversions like this are given the name *tautomerism*.

Tautomerism

Any reaction that simply involves the intramolecular transfer of a proton, and nothing else, is called a tautomerism. Here are two other examples.

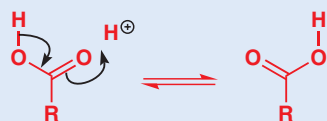

tautomerism in a carboxylic acid

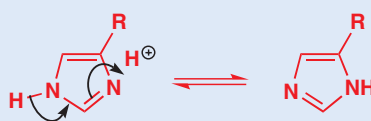

tautomerism in an imidazole

This sort of chemistry was discussed in Chapter 8, where the acidity and basicity of atoms were the prime considerations. In the first case the two tautomers are the same and so the equilibrium constant must be exactly 1 (the mixture must be exactly 50:50). In the second case (imidazole-containing compounds appear on p. 178) the equilibrium will lie on one side or the other depending on the nature of R.

Why don't simple aldehydes and ketones exist as enols?

When we were looking at the spectra of carbonyl compounds in Chapters 13 and 18 we saw no signs of enols in IR or NMR spectra. Dimedone is exceptional (we will discuss why later) and while any carbonyl compound with protons adjacent to the carbonyl group can enolize, simpler carbonyl compounds like cyclohexanone or acetone have only a trace of enol present under ordinary conditions. The equilibrium lies well over towards the keto form (the equilibrium constant K for acetone enolization is about 10^{-6}).

This is because the combination of a C=C double bond and an O–H single bond is (slightly) less stable than the combination of a C=O double bond and a C–H single bond. The balance between the bond energies is quite fine. On the one hand, the O–H bond in the enol is a stronger bond than the C–H bond in the ketone but, on the other hand, the C=O bond of the ketone is much stronger than the C=C bond of the enol. Some average values for these bonds are shown on the right.

Typical amounts of enols in solution are about one part in 10^5 for normal ketones. So why do we think they are important? *Because enolization is just a proton transfer, it is occurring all the time even though we cannot detect the minute proportion of the enol.* Let's look at the evidence for this statement.

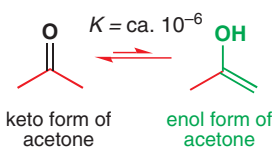

Typical bond strengths (kJ mol^{-1}) in keto and enol forms

	Bond to H	π bond	Sum
keto form	440 (C–H)	720 (C=O)	1160
enol form	500 (O–H)	620 (C=C)	1120

Evidence for the equilibration of carbonyl compounds with enols

If you dissolve a simple carbonyl compound (for example, 1-phenylpropan-1-one, 'propiophenone') in D_2O and run a series of ^1H NMR spectra over a period of time, the signal for protons next to the carbonyl group very slowly disappears. If the compound is isolated from the solution afterwards, the mass spectrum shows that those hydrogen atoms have been replaced by deuterium atoms: there is a peak at $(M+1)^+$ or $(M+2)^+$ instead of at M^+

Enolization usually means losing a proton from C and gaining one at O. But in D_2O all of the 'protons' are in fact 'deuterons' (D^+ , or $^2\text{H}^+$), so initially an enol with an 'OD' group forms. This doesn't matter, though, because when the enol form reverts to the keto form, it loses the D from O. But what does matter is that it also picks up a deuteron instead of a proton at C.

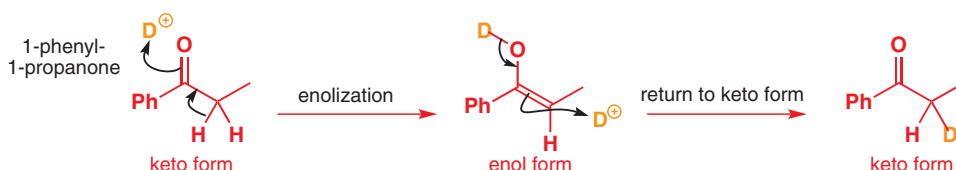

■ Notice that the double bond in this enol could be either *E* or *Z*. It is drawn as *Z* here, but in reality is probably a mixture of both, although this is irrelevant to the reaction. We shall not be concerned with the geometry of enols in this chapter, but there are some reactions that you will meet in later chapters where it is important, and you need to appreciate that the possibility exists.

The process can now be repeated: either the D or the H could be lost this time, but eventually it is certain that the huge excess of D over H in the solvent will mean that both H atoms adjacent to the carbonyl group are replaced by D.

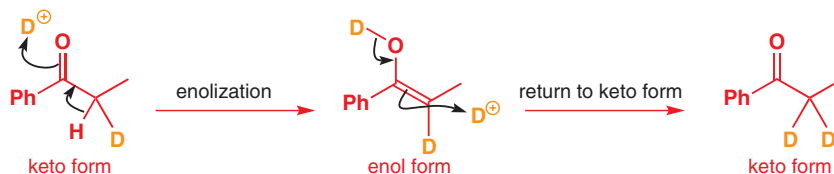

■ Something else will happen to the proton NMR spectrum. The signal for the CH_3 group was a triplet in the original ketone, but when those two Hs are replaced by Ds, it becomes a singlet. In the carbon spectrum, coupling to deuterium appears: remember the shape of the CDCl_3 peak (Chapter 18).

We can detect this exchange by the slow disappearance of the 2H signal for the protons on the carbon next to the carbonyl group. There are, of course, eight other hydrogen atoms in the molecule but they are not affected by enolization.

Enolization is catalysed by acids and bases

Enolization is, in fact, quite a slow process in neutral solution, even in D_2O (the exchange described above might take place over a period of hours to days at room temperature), and we would catalyse it with acid or base if we really wanted it to happen fast. In the acid-catalysed reaction, the molecule is first protonated on oxygen and then loses a proton from C in a second step. We shall use a different example here to show that aldehydes form enols too, but acid or base will catalyse enolization of any carbonyl compound in the same way.

Acid-catalysed enolization of an aldehyde

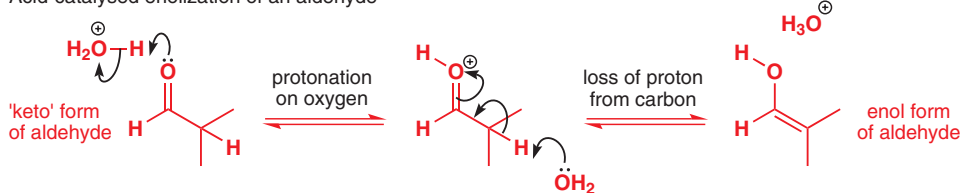

This is a more detailed mechanism for enolization than those we have been drawing because it shows that something (here a water molecule) must actually be removing the proton from carbon. Although this reaction will occur faster than the uncatalysed enolization, the equilibrium is not changed and we still cannot detect the enol spectroscopically.

In the base-catalysed reaction the C–H proton is removed first by the base, say a hydroxide ion, and the proton added to the oxygen atom in a second step.

Base-catalysed enolization of an aldehyde

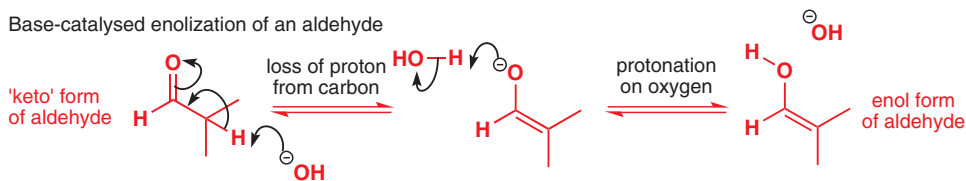

This is a good mechanism too because it shows that something must remove the proton from carbon and something (here a water molecule—we don't, of course, have protons available in basic solution) must put the proton on the oxygen atom.

Notice that both of these reactions are genuinely catalytic. You get the proton back again (in the form of H_3O^+) at the end of the acid-catalysed mechanism, and you get the hydroxide ion back again at the end of the base-catalysed mechanism.

The intermediate in the base-catalysed reaction is an enolate ion

There are some more insights to be gained from the base-catalysed reaction. The intermediate anion is called the **enolate ion**. It is the conjugate base of the enol and can be formed either

■ In Chapter 17 (p. 388) we discussed the equivalence of mechanisms showing protons just 'falling off' with those in which basic solvent molecules are involved to remove a proton. In this chapter, and in the rest of the book, you will see both variants in use according to the context. They mean exactly the same thing.

 Interactive mechanism for base-catalysed enolization

directly from the carbonyl compound by the loss of a C–H proton or from the enol by loss of the O–H proton.

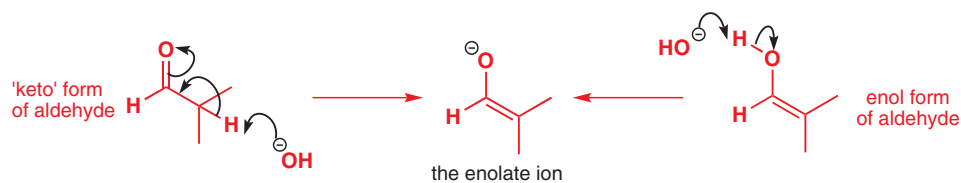

The enolate ion is one of those three-atom four-electron systems related to the allyl anion that you met in Chapter 7. The negative charge is mainly on oxygen, the most electronegative atom. We can show this with curly arrows using the simplest enolate possible (from MeCHO).

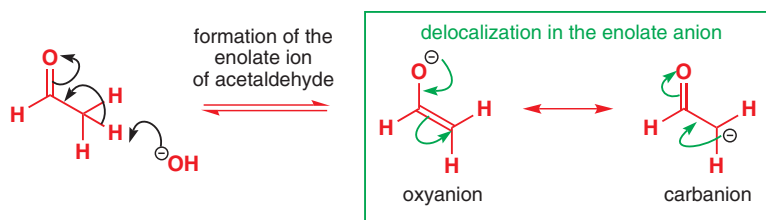

The enolate is a delocalized system, with negative charge carried on both C and O—we use a double-headed conjugation arrow to connect these two representations because the oxyanion and carbanion structures are just two different ways to represent the same thing. We shall usually prefer the oxyanion structure as it is more realistic.

You can say the same thing in orbitals.

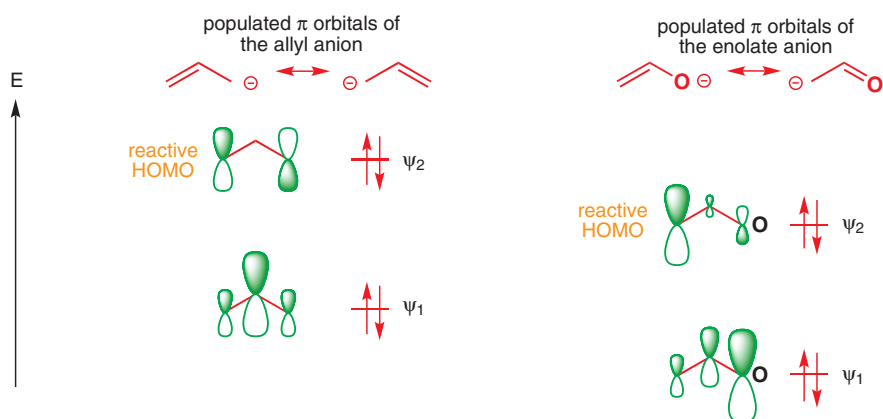

On the left you see the populated orbitals of the allyl anion and on the right the corresponding orbitals of the enolate ion. The allyl anion is, of course, symmetrical. Two changes happen when we replace one carbon by an oxygen atom. Because oxygen is more electronegative, both orbitals go down in energy. The orbitals are also distorted. The lower-energy atomic orbital of the more electronegative oxygen contributes more to the lower-energy orbital (ψ_1) and correspondingly less to ψ_2 . The charge distribution comes from both populated orbitals so the negative charge is spread over all three atoms, but is mostly on the ends. The important reactive orbital is the HOMO (ψ_2), which has the larger orbital on the terminal carbon atom.

In the enolate, the oxygen atom has more of the negative charge, but the carbon atom has more of the HOMO. One important consequence is that we can expect reactions dominated by charges and electrostatic interactions to occur on oxygen and reactions dominated by orbital interactions to occur on carbon. Thus acyl chlorides tend to react at oxygen to give enol esters.

■ It's important to recognize the difference between this conjugation and the tautomerism that interconverts the keto and enol forms of a carbonyl compound, which is a real equilibrium between two different structures and must be represented by equilibrium arrows.

➔ Refer to Chapter 7 if you fail to see where these orbitals come from.

■ In other words, the oxygen is a *hard* nucleophilic centre and the carbon is a *soft* nucleophilic centre. See Chapter 15, p. 357.

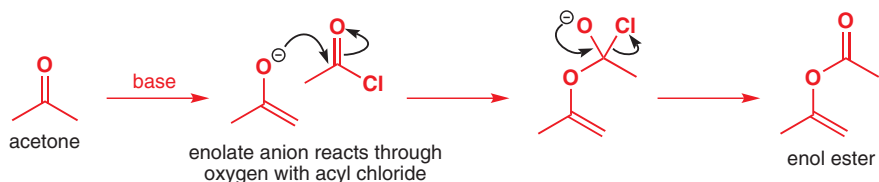

while alkyl halides tend to react at carbon.

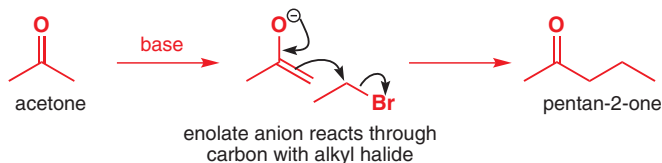

■ Notice that in drawing this mechanism it is *not* necessary to locate the negative charge on the carbon atom. We suggest you draw enolate mechanisms using the more representative oxyanion structure.

We shall be looking at these reactions in detail in Chapter 25. For the rest of this chapter we will turn to some simpler consequences of enolization and some reactions of enolates with simple heteroatom-based electrophiles.

Summary of types of enol and enolate

Time to recap and summarize the various kinds of enol and enolate that can form from carbonyl compounds. You have already seen that **ketones** and **aldehydes** enolize. With an unsymmetrical ketone, more than one enol or enolate ion is possible.

Enolizable ketones

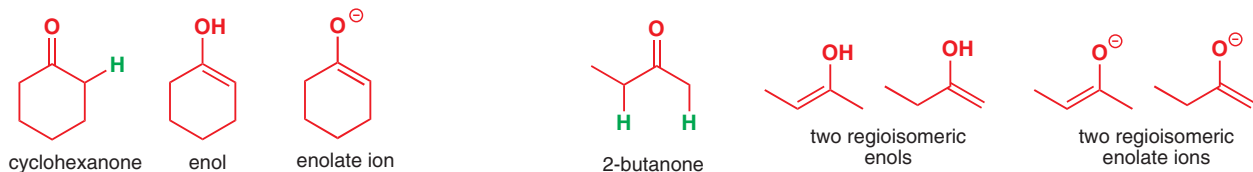

Aldehydes may enolize, but of course enolization is impossible in any carbonyl compound without hydrogen atoms adjacent to the carbonyl group.

Enolizable aldehyde

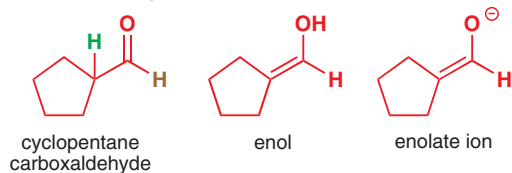

Non-enolizable carbonyl compounds

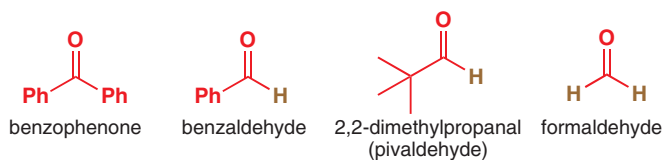

■ Note that the aldehyde proton itself (shown here in brown) is never enolized. Try to draw the curly arrows and you will see that they don't work.

All carboxylic acid derivatives can form enols of some kind. Those of **esters** are particularly important and either enols or enolates are easily made. It is obviously necessary to avoid water in the presence of acid or base, as esters hydrolyse under these conditions. One solution is to use the alkoxide belonging to the ester (MeO^- with a methyl ester, EtO^- with an ethyl ester, and so on) to make enolate ions.



Then, if the alkoxide does act as a nucleophile, there's no harm done as the same ester is simply regenerated.

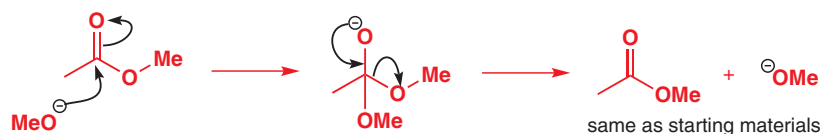

The carbonyl group is accepting electrons in both the enolization step and the nucleophilic attack. The same compounds that are the most electrophilic are also the most easily enolizable. This makes **acyl chlorides** very enolizable. To avoid nucleophilic attack, we cannot use chloride ion as base since chloride is not basic, so we must use a non-nucleophilic base such as a tertiary amine. The resulting enolate is not stable as it can eliminate chloride ion, a good leaving group, to form a ketene. This works particularly well in making dichloroketene from dichloroacetyl chloride as the proton to be removed is very acidic.

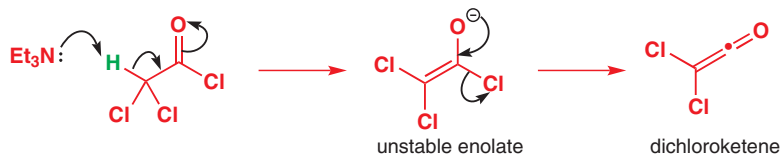

➔ A *ketene* (p. 403) has a carbon atom with a double bond to O and another double bond to C. This is an E1cB elimination, and you saw this sort of chemistry in Chapter 17.

Carboxylic acids do not form enolate anions easily as the base first removes the acidic OH proton. This also protects acids from attack by most nucleophiles.

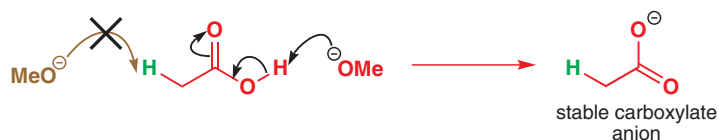

In acid solution, there are no such problems and 'ene-diols' are formed.

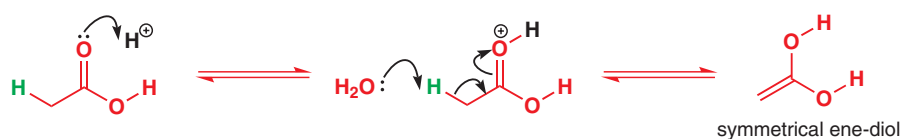

Amides (unless they are tertiary) also have rather acidic protons, though not, of course, as acidic as those of carboxylic acids. Attempted enolate ion formation in base removes an N–H proton rather than a C–H proton. Amides are also the least reactive and the least enolizable of all acid derivatives, and their enols and enolates are rarely used in reactions.

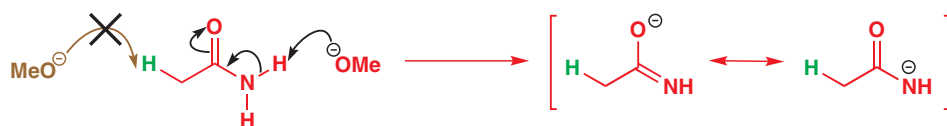

It is not even necessary to have a carbonyl group to observe very similar reactions. Imines and enamines are related by the same kind of tautomeric equilibria.

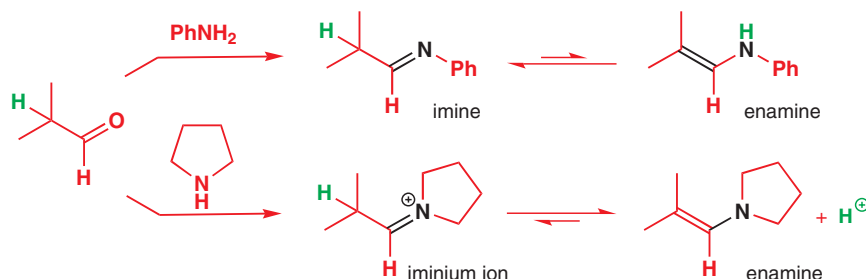

■ You should make sure you can write mechanisms for these reactions: we discussed them in Chapter 12.

With a primary amine (here PhNH_2) a reasonably stable imine is formed, but with a secondary amine (here a simple cyclic amine) the imine itself cannot be formed and the iminium salt is less stable than the enamine.

Just as enamines are the nitrogen analogues of enols, **aza-enolates** are the nitrogen analogues of enolates. They are made by deprotonating enamines with strong base. Nitroalkanes are much more acidic and form enolate-like anions in quite weak base.

➔ You will see both enamines and aza-enolates in action in Chapters 25 and 26. Deprotonation of nitroalkanes is discussed in Chapter 8 (p. 177).

Formation of aza-enolate

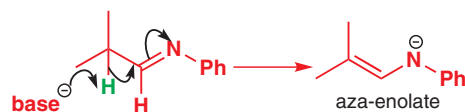

Formation of nitromethane anion

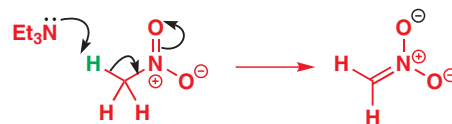

Nitriles (cyanides) also form anions and require strong base as the negative charge is delocalized onto only a single nitrogen atom. The anion is a linear system like ketene, allene, or carbon dioxide.

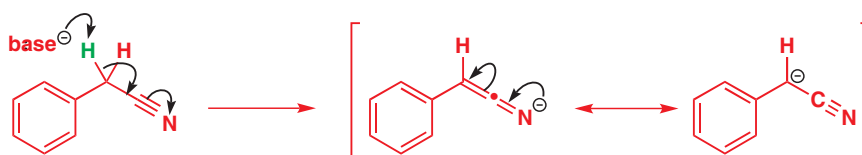

● Requirement for enolization

Any organic compound with an electron-withdrawing functional group, with at least one π bond joined to a saturated carbon atom having at least one hydrogen atom, may form an enol in neutral or acid solution. Many also form enolates in basic solution (exceptions being carboxylic acids, and primary and secondary amides).

The enols will probably not be detectable in solution (only about one part in 10^4 – 10^6 is enol for most compounds). Some compounds by contrast form stable enols, and we'll look at these next, before coming back to how enols and enolates react.

Stable enols

We have established that the enol is, in general, less stable than the keto form of the molecule. We might hope to see stable enols if we changed that situation by adding some feature to the molecule that stabilized the enol thermodynamically. Or we might try to create an enol that would revert only slowly to the keto form—in other words, it would be *kinetically* stable. We shall look at this type first.

Kinetically stable enols

The formation of enols is catalysed by acids and bases. The reverse of this reaction—the formation of ketone from enol—must therefore also be catalysed by the same acids and bases. If you prepare simple enols in the strict absence of acid or base they have a reasonably long lifetime. A famous example is the preparation of the simplest enol, vinyl alcohol, by heating ethane-1,2-diol (glycol—antifreeze) to very high temperatures (900°C) at low pressure. Water is lost and the enol of acetaldehyde is formed. It survives long enough for its proton NMR spectrum to be run, but gives acetaldehyde slowly.

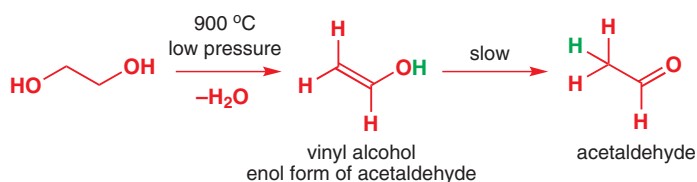

NMR spectrum of vinyl alcohol

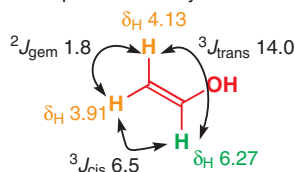

How delocalization affects chemical shift

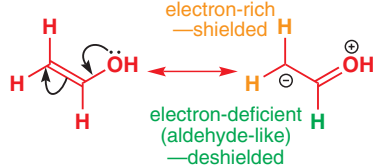

The spectrum illustrates the electronic effect of the oxygen atom on the double bond. The alkene proton next to OH (in green) is deshielded and the two alkene protons on the other carbon atom (in orange) are shielded as you would expect from the feeding of electrons into the double bond by the OH group. The coupling constants across the double bond are as expected too: a large *trans* coupling (14.0 Hz) and a smaller *cis* coupling (6.5 Hz). The very small geminal coupling is typical of a terminal double bond CH_2 group.

Other enols can be made that are stable because it is very difficult for the carbon atom to be protonated. In the example on the right, the two substituted benzene rings crowd the enol and prevent approach of a protonating agent. The rings twist out of the plane of the double bond and shield both faces of the enol from attack by a proton.

➔ Coupling constants in alkenes are explained on p. 293.

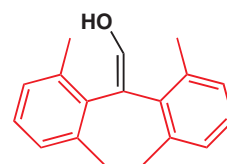

Thermodynamically stable enols: 1,3-dicarbonyl compounds

We started this chapter by looking at a molecule that contained about 33% enol in solution—dimedone (shown on the right). In fact, this is just one example of the class of 1,3-dicarbonyl compounds (also called β -dicarbonyls), many of which contain substantial amounts of enol and may even be completely enolized in polar solvents.

We need now to examine why these enols are so stable. The main reason is that this unique (1,3) arrangement of the two carbonyl groups leads to enols that are conjugated—rather like a carboxylic acid.

Delocalization in the enol form of dimedone

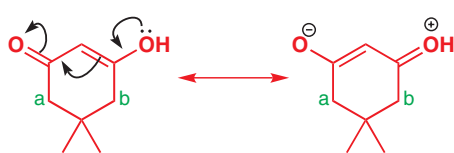

Delocalization in a carboxylic acid

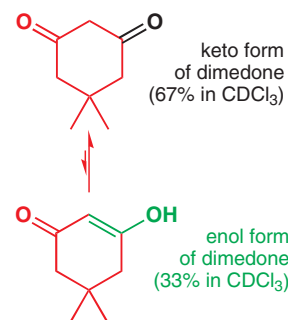
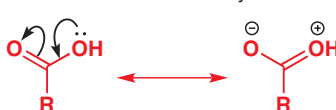

Look back at the NMR spectrum of dimedone (p. 450) and you'll see that the two CH_2 groups within the ring seem to be the same, although they are different (a and b)—even the delocalization we have just proposed does not make them equivalent. This must mean that the enol is in rapid equilibrium with another identical enol. This is *not* delocalization—a proton is moving—so it is **tautomerism**.

Tautomerism of the enol form of dimedone

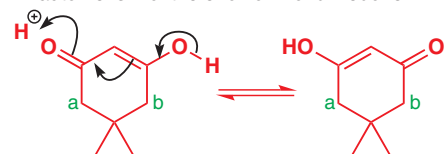

Tautomerism of a carboxylic acid

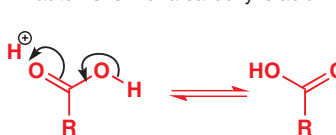

➔ We discussed ‘averaging’ in NMR spectra in Chapter 16, p. 374.

■ Again, note carefully the difference between this **tautomerism**, in which a proton is moved around the molecule and the structures are linked by equilibrium arrows, and **delocalization** (conjugation), where only electrons are ‘moved’ (no actual movement occurs, of course) and the two structures are linked by one *double-headed* arrow as they are just two ways of drawing the same thing.

■ This hydrogen bond was not possible in dimedone.

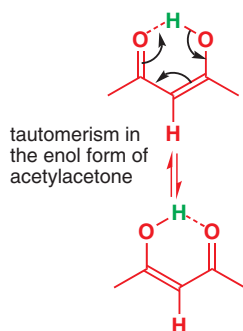

Once again, this is very like the situation in a carboxylic acid. The two enols equilibrate (tautomerize) so fast in CDCl_3 solution that the NMR spectrometer records an ‘averaged’ spectrum. By contrast, equilibration between the enol and keto forms is sufficiently slow that the NMR spectrometer records separate signals for the keto and enol forms.

Other 1,3-dicarbonyl compounds also exist largely in the enol form. In some examples there is an additional stabilizing factor, intramolecular hydrogen bonding. Acetylacetone (propane-2,4-dione) has a symmetrical enol stabilized by conjugation. The enol form is also stabilized by a very favourable intramolecular hydrogen bond in a six-membered ring.

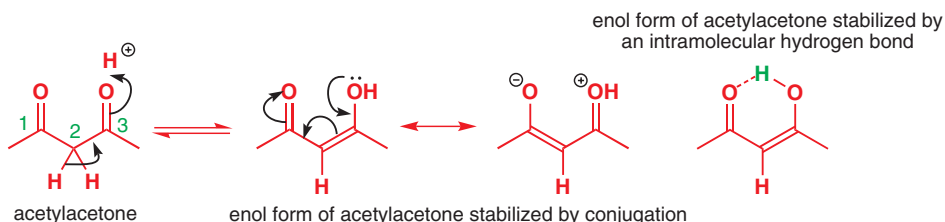

The hydrogen-bonded enol structure looks unsymmetrical, but in fact, as with dimedone, the two identical enol structures interconvert rapidly by proton transfer, that is, by tautomerism.

The 1,3-dicarbonyl compound need not be symmetrical, and if it is not then two different enol forms will interconvert by proton transfer. Below is a cyclic keto-aldehyde that exists entirely as a pair of rapidly equilibrating enols. The proportions of the three species can be measured by NMR: there is <1% keto-aldehyde, 76% of the first enol, and 24% of the second.

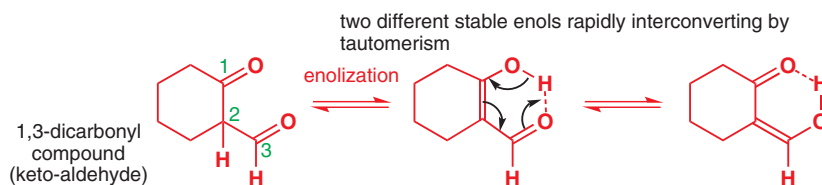

More examples of stable enols

Pfizer’s anti-inflammatory drug ‘Feldene’ (used to treat arthritis) is a stable enol based on a 1,3-dicarbonyl compound. It also contains amide and sulfonamide groups but you should be able to pick out the enol part.

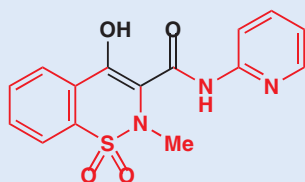

Piroxicam (Feldene[®])
once-a-day treatment for arthritis

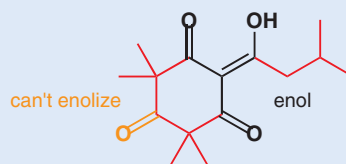

Leptospermeone (Callisto[®])
herbicide produced by the bottle-brush plant

Stable enols occur in nature too. Leptospermeone is a herbicide produced by *Callistemon citrinus*, the bottle-brush plant, to keep down competitors, and it has been used commercially as ‘Callisto’ to protect maize. It is a tetraketone, but exists entirely as a mixture of tautomeric enols. Note that the carbonyl group in orange is unable to form an enol: it has no α hydrogens.

Vitamin C has a five-membered ring containing two carbonyl groups but normally exists as a very conjugated ene-diol.

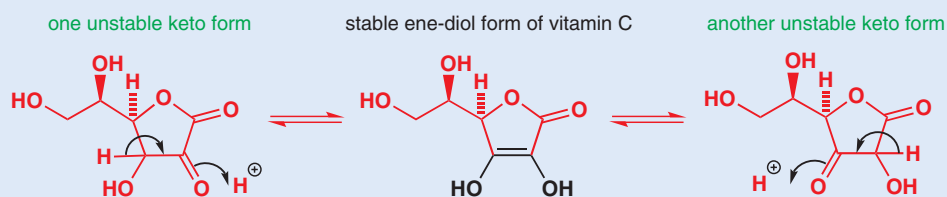

We can show the delocalization and explain why vitamin C is called *ascorbic acid* at the same time. The green enol proton is acidic because the anion is delocalized over the 1,3-dicarbonyl system.

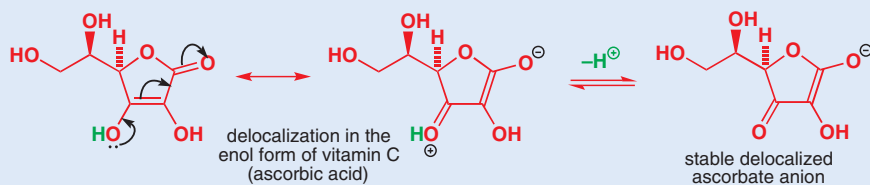

The ultimate in stable enols has to be the Ph-enol. Aromatic alcohols, or phenols, which prefer the substantial advantage of aromaticity to the slight advantage of a C=O over a C=C double bond. They exist entirely in the phenol form. Like ascorbic acid, phenol is also quite acidic (pK_a 10)—it used to be called carboic acid.

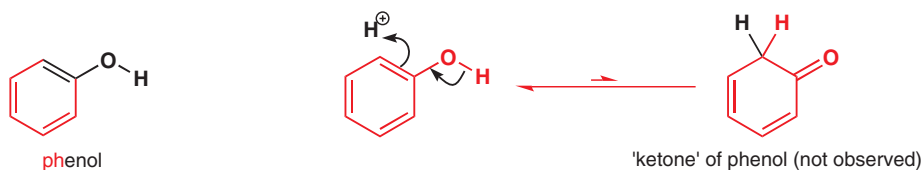

Consequences of enolization

Unsaturated carbonyl compounds prefer to be conjugated

It is difficult to keep a β,γ -unsaturated carbonyl compound because the double bond tends to move into conjugation with the carbonyl group in the presence of traces of acid or base. The intermediate is, of course, an enol in acid solution but an enolate ion in base.

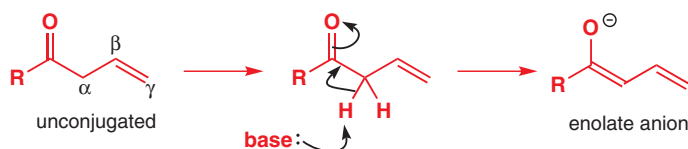

Protonation at the α position takes the molecule back to the unconjugated ketone, but protonation in the γ position gives the more stable conjugated isomer. All the reactions are equilibria so the conjugated isomer ends up predominating.

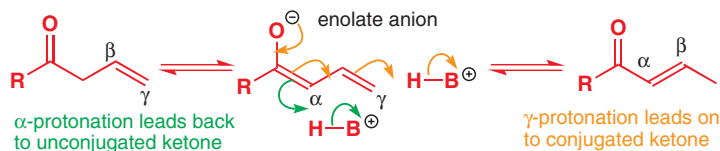

Racemization

Any stereogenic centre next to a carbonyl group is precarious because enolization will destroy it. It would be foolish to try and make optically active β -keto esters whose only stereogenic centre was between the two carbonyl groups. Although the keto-ester is chiral, the enol is flat and cannot be chiral. The two forms are in rapid equilibrium so all optical activity would quickly be lost.

You will see in Chapter 21, however, that intermediates with this 'keto' structure are formed in reactions on the benzene ring of phenols.

The Greek letters α , β , γ , and so on are used to designate the positions along the chain starting from the atom next to carbonyl (or any other functional) group.

labelling carbon atoms in carbonyl compounds

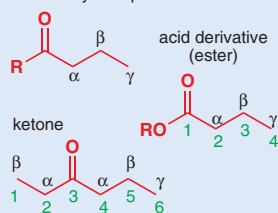

An enolizable position is always α , even if there are two of them, as in an unsymmetrical alkyl ketone. The α , β , γ system is independent of the IUPAC rules for nomenclature, which would, for example, assign the green numbers shown above to the carbon atoms in the chain.

The same terminology can be used for amino acids or keto esters, for example.

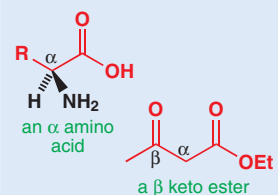

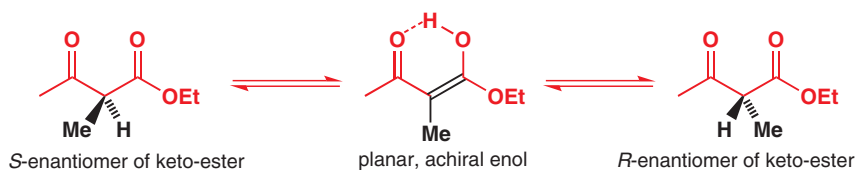

Compounds with one carbonyl group next to the stereogenic centre can be made but care still needs to be taken. The α amino acids, the component parts of proteins, are like this. They are perfectly stable and do not racemize in aqueous acid or base. In base they exist as carboxylate anions that do not enolize, as explained above. Enolization in acid is prevented by the $-\text{NH}_3^+$ group, which inhibits the protonation of the carbonyl group necessary for enol formation.

Amino acids can be converted into their *N*-acetyl derivatives with acetic anhydride. These *N*-acetyl amides can be racemized on recrystallization from hot acetic acid, no doubt by enolization. The amino group is no longer basic, and is not protonated in acid, so protonation on the carbonyl group and hence enolization is now possible.

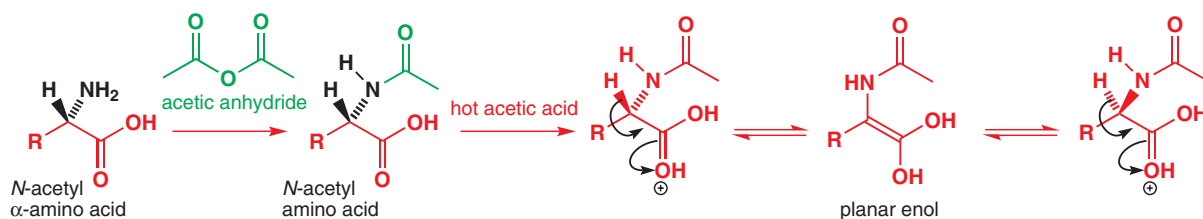

■ We discussed **resolution**, the separation of enantiomers by the formation of diastereoisomers with an optically active resolving agent, in Chapter 14.

You may think it a crazy idea to *want* to racemize an amino acid. Supposing, however, that you are preparing a pure (*S*)-amino acid from a racemate by resolution. Half your material ends up as the wrong (*R*)-enantiomer and you don't want just to throw it away. If you racemize it you can put it back into the next resolution and convert half of it into the (*S*)-acid. Then you can racemize what remains and so on.

Racemization *in vivo*

Some compounds may be racemized inside the human body. Bacterial cell walls are built partly from 'unnatural' (*R*)-amino-acids, which humans can't digest. But we can use enzymes to racemize them.

There is an important group of analgesic (pain-killing) drugs, such as ibuprofen, based on the aryl-propionic acid structure. Ibuprofen can be bought over the counter in chemists' shops as Nurofen. Only the (*S*)-enantiomer of ibuprofen is an effective painkiller but the compound is administered as the racemate. The body does the rest, racemizing the compound by enolizing it.

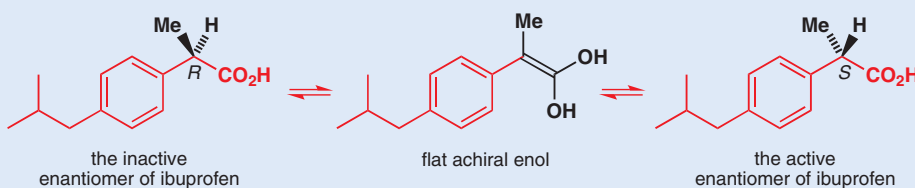

Reaction with enols or enolates as intermediates

We have already seen that exchange of hydrogen for deuterium, movement of double bonds into conjugation, and racemization can occur with enols or enolates as intermediates. These are chemical reactions of a sort, but it is time to look at some reactions that make significant changes to the carbonyl compound.

Halogenation

Carbonyl compounds can be halogenated in the α position by halogens (such as bromine, Br_2) in acidic or basic solutions. We shall look at the acid-catalysed reaction first because it is simpler. Ketones can usually be cleanly brominated using acetic acid as solvent.

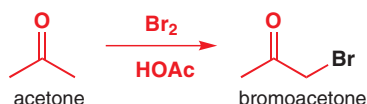

The first step is acid-catalysed enolization and the electrophilic bromine molecule then attacks the nucleophilic carbon of the enol. The arrows show why this particular carbon is the one attacked.

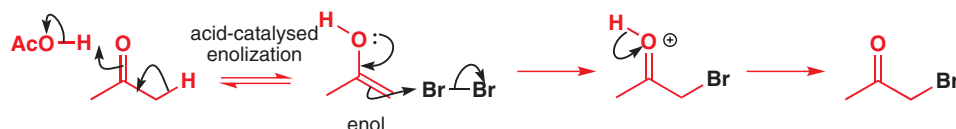

Interactive mechanism for acid-catalysed ketone bromination

Notice that the acid catalyst is regenerated at the end of the reaction. The reaction need not be carried out in an acidic solvent, or even with a protic acid at all. Lewis acids make excellent catalysts for the bromination of ketones. This example with an unsymmetrical ketone gives 100% yield of the bromoketone with catalytic AlCl_3 in ether as solvent.

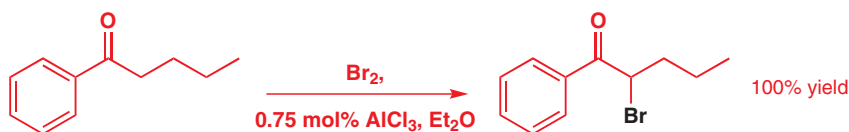

Bromination occurs nowhere else in the molecule—not on the benzene ring (which, as you will see in the next chapter, it easily might under these conditions), nor on any other atom of the aliphatic side chain. This is because only one position can form an enol and the enol is more reactive towards bromine than the aromatic ring.

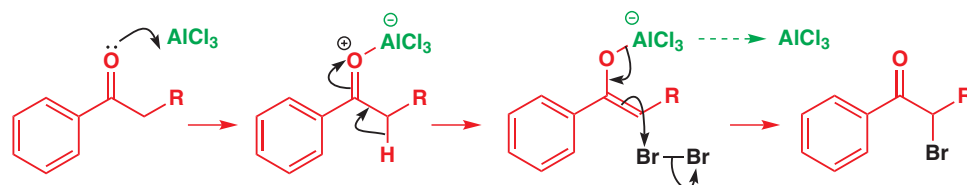

■ We have introduced a slight but unimportant variation to this mechanism. In the previous mechanism, we used the lone pairs on oxygen to assist attack on Br_2 and then lost the acid catalyst in a separate step. Here, we have written AlCl_3 leaving as the Br_2 is attacked. The difference is not significant, and you will see mechanisms written in both ways. The second way saves a step, of course.

These mechanisms should remind you of alkene bromination (p. 427)—except that here the attack on the bromine is assisted by an electron pair on oxygen. Enols are more nucleophilic than simple alkenes—the HOMO is raised by the interaction with the oxygen's lone pairs and looks not unlike the HOMO of the enolate anion we discussed on p. 453. The product, instead of being a bromonium ion (which would undergo further reactions), loses a proton (or the Lewis acid) to give a ketone.

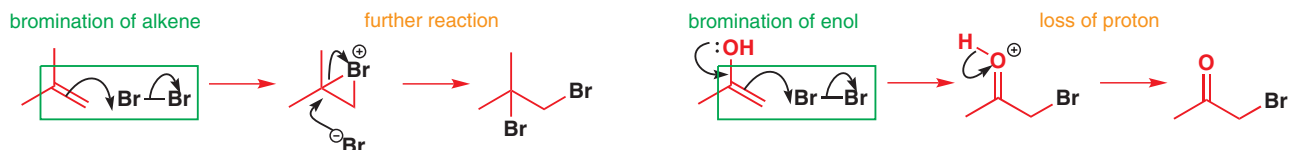

Bromination of acid derivatives is usually carried out not on the acid itself but by converting it to an acyl bromide or chloride, which is not isolated but gives the α -bromoacyl halide via the enol. This used to be done in one step with red phosphorus and bromine, but a two-step

■ In the reaction of the bromoacyl chloride with methanol, attack occurs at the carbonyl group with an alcohol because oxygen nucleophiles are 'hard' nucleophiles (controlled by charge interactions). If we want to displace the α -bromo group we can use any 'soft' (orbital-dominated) nucleophile. Triphenylphosphine (Ph_3P) is particularly important—the product is a phosphonium salt, employed in Wittig reactions and discussed in Chapters 11 and 27. Hard and soft nucleophiles in substitution reactions are discussed in Chapter 15.

process is usually preferred now, and the bromoester is usually made directly without isolating any of the intermediates. We can summarize the overall process like this.

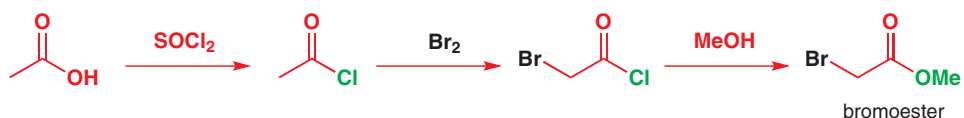

The formation of the acyl chloride with SOCl_2 and the conversion of the α -bromoacyl chloride into the bromoester with MeOH are simple nucleophilic substitutions at the carbonyl group, as described in Chapter 10. The intermediate stage, the bromination of the very easily enolized acyl chloride, is a typical enol bromination.

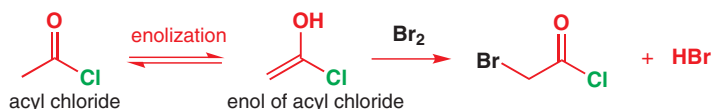

Base-promoted halogenation

In base, bromination is different and more complicated because it usually won't stop with the introduction of one halogen atom. We'll use the bromination of acetone as our example: the first step will now be a base-catalysed enolization to give the enolate ion instead of the enol. The enolate ion can attack a bromine molecule in a very similar way to the attack of the enol on bromine. The enolate will, of course, be even more reactive than the enol (the enolate carries a negative charge).

■ Notice that the hydroxide ion is not regenerated in this reaction—bromide ion is not basic and does not react with water to regenerate hydroxide ion (Chapter 8). We therefore need to add a whole equivalent of hydroxide.

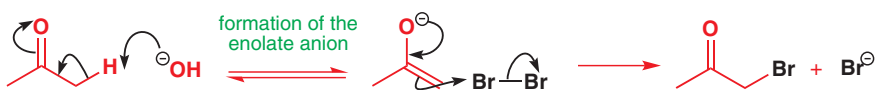

The problem is that the reaction does not stop at this point. The first step was the removal of a proton and the protons between the carbonyl group and the bromine atom in the product are *more* acidic than those in the original acetone because of the electron-withdrawing bromine atom. Bromoacetone forms an enolate faster than acetone does.

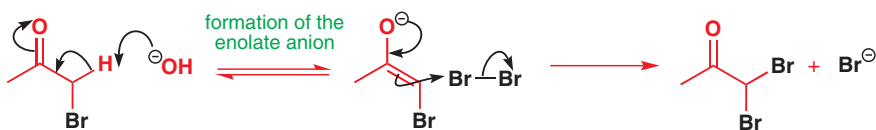

Dibromoacetone is formed. Now we have one remaining proton in between the carbonyl group and two bromine atoms. It is even more acidic and so forms a new enolate ion even more quickly. The first product observable in any amount is tribromoacetone.

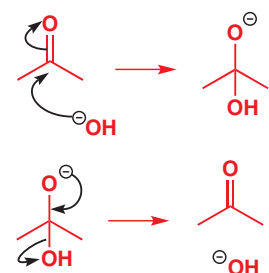
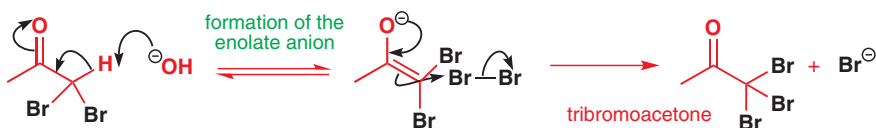

But even this is not the end of the story. To see why, we need to backtrack a bit. You may already have asked yourself, 'Why doesn't the hydroxide ion, being a nucleophile, attack the carbonyl group?' This is a general question you might ask about all enolizations in base. The answer is that it does. The reaction is shown in the margin. A tetrahedral intermediate forms.

What can happen now? This tetrahedral intermediate will revert to a carbonyl compound by expelling the best leaving group. Me^- can never act as a leaving group: the only possible leaving group is the hydroxide ion (pK_a of water = 15.7), so it just drops out again.

This state of affairs continues until we reach the tribromoketone. The CBr_3 group now has a chance to be a leaving group since the carbanion is stabilized by three bromine atoms. A real reaction occurs:

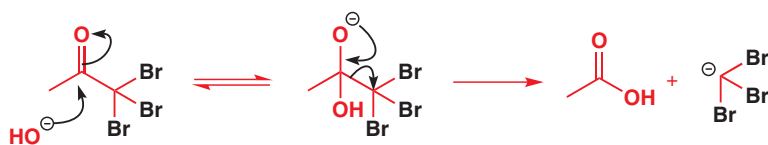

These initial products exchange a proton to reveal the true products of the reaction—the anion of a carboxylic acid and tribromomethane (CHBr_3).



The same thing happens with iodine, and we can summarize the whole process with iodine using a general structure for a carbonyl compound bearing a methyl group. It must be a methyl group because three halogens are necessary to make the carbanion into a leaving group.

This reaction is often called the 'iodoform' reaction. Iodoform was an old name for triiodomethane, just as chloroform is still used for trichloromethane. It is one of the rare cases where nucleophilic substitution at a carbonyl group results in the cleavage of a C–C single bond.

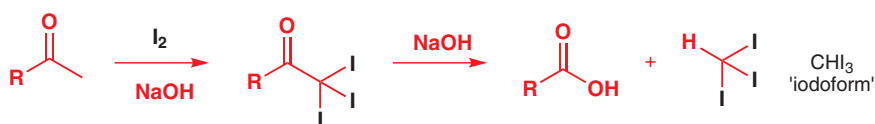

● Acid conditions are best for halogenation

Halogenation of carbonyl compounds should be carried out in acid solution. Attempts in basic solution lead to multiple substitutions and C–C bond cleavage.

Why does acid-catalysed halogenation work better?

The reason why halogenation in base continues until all the hydrogens have been replaced is clear: each successive halide makes the remaining proton(s) more acidic and the next enolization easier. But why does acid-catalysed halogenation stop after the introduction of one halogen? It would be more accurate to say that it *can be made to stop* after one halogen is introduced if only one equivalent of halogen is used. Acid-catalysed halogenation *will* continue if there is more halogen available.

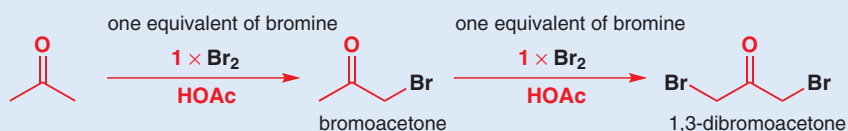

However, the second halogen goes on the other side of the carbonyl group, if it can. It is evidently the case that the second halogenation is slower than the first. Most of the intermediates are positively charged and hence destabilized by the presence of a halogen. The bromoketone is less basic than acetone so less of the reactive protonated form is present. This slows down any further electrophilic attack.

addition of a second bromine to the same position in acid solution (this does not usually happen)

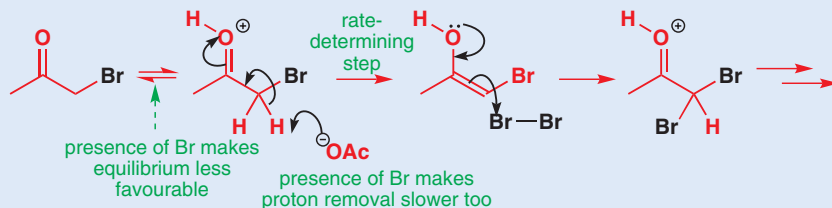

The second step is the rate-determining step, and the presence of a bromine atom at the α position slows this step down still further: if a proton can be lost from a different α position—one without a Br atom—it will be. The transition state for proton removal illustrates why bromine slows this step down. The part of the structure close to the bromine atom is positively charged.

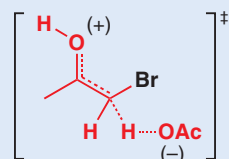

transition state for
proton removal

We can add a useful piece of evidence to this weak-sounding explanation. The halogenation of an unsymmetrical dialkyl ketone gives different results in acid and in base. In base halogenation occurs preferentially on a methyl group, that is, on the less highly substituted side. In acid solution by contrast, the first (and only) halogenation occurs on the more substituted side of the carbonyl group. Alkyl groups have the opposite effect to bromine atoms—they stabilize positive charges. So the reactions of an enol, with a positively charged transition state, are faster at more highly substituted positions. Enolates react through negatively charged transition states and are faster at less highly substituted carbon atoms.

halogenation in base

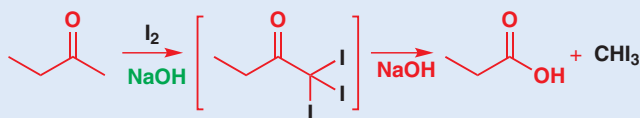

halogenation in acid

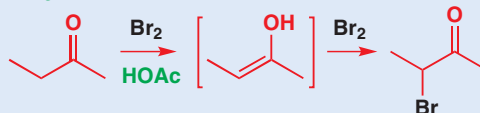

Nitrosation of enols

Now for a reaction with nitrogen as an electrophile that illustrates enol reactivity and reminds us that tautomerism happens with functional groups other than the carbonyl. Let us suppose you have a carbonyl compound and wish to introduce another carbonyl group next to the first. One way you might go about it is like this:

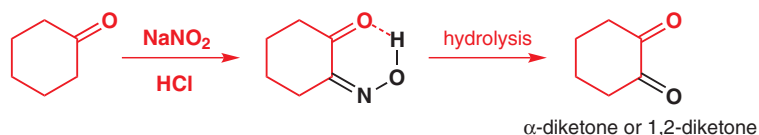

The first step involves the formation of the weak acid nitrous acid (HNO_2 or, more helpfully, HONO) from the sodium salt and the strong acid HCl . Nitrous acid is itself protonated and then loss of water creates the reactive electrophile NO^+ .

Interactive mechanism for
formation of nitrosonium ion

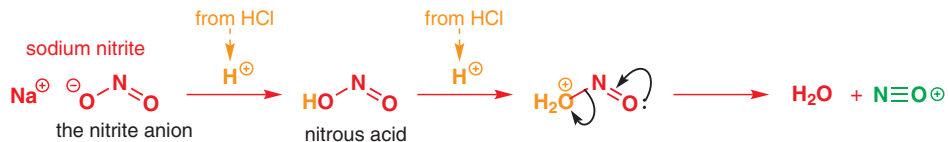

This diatomic cation, isoelectronic with carbon monoxide, is electrophilic at nitrogen and attacks the enol of the ketone to form an unstable nitroso compound.

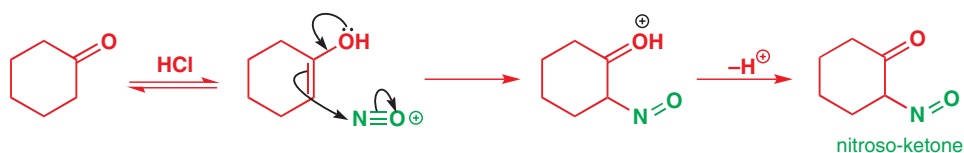

The nitroso compound is unstable because it can tautomerize with the transfer of a proton from carbon to the oxygen of the nitroso group. This process is exactly like enolization but with $\text{N}=\text{O}$ in the place of the $\text{C}=\text{O}$ group. It gives an oxime as the stable 'enol'. The oxime's $\text{O}-\text{H}$ can form an intramolecular hydrogen bond with the ketone carbonyl group. Hydrolysis of the oxime reveals the second ketone.

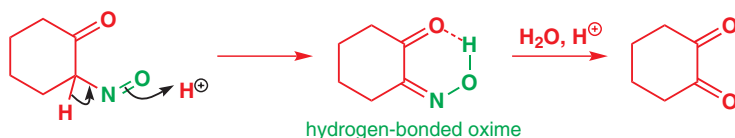

If the ketone is unsymmetrical, this reaction will occur on the more substituted side, for the same reason that acid-catalysed enol bromination gives the more substituted α -bromocarbonyl compound (see the box on p. 463).

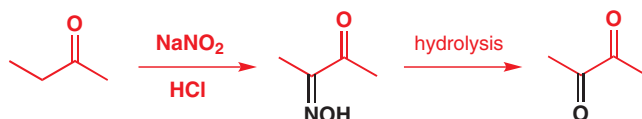

Before we move on to any more reactions, we want you to take away this message from the reactions of enols and enolates with Br_2 and with NO^+ :

- Enols and enolates generally react with electrophiles at carbon.

The nitroso group

The difference between the nitro and nitroso groups is one of oxidation state and conjugation. The much more stable nitro group has a trigonal nitrogen atom with no lone pair; the $\text{N}=\text{O}$ bond is delocalized. The nitroso group has a trigonal nitrogen atom with a lone pair in the plane; the $\text{N}=\text{O}$ bond is not delocalized. Both can form 'enols' but the equilibria are biased in different directions.

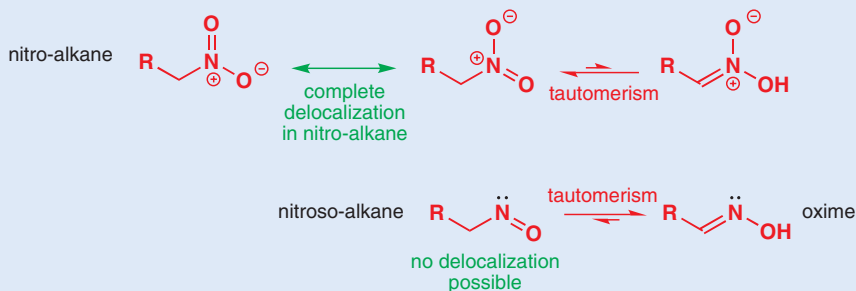

Stable equivalents of enolate ions

Lithium enolates

Even with fairly strong bases such as hydroxides or alkoxides, most carbonyl compounds are converted to their enolates only to a very small extent. A typical value for the $\text{p}K_a$ of protons adjacent (α) to a carbonyl group is 20–25, while the $\text{p}K_a$ of methanol is around 16, so we can only hope for about 1 part enolate in 10^4 parts carbonyl compound. With a much stronger base this all changes, and the enolate is formed quantitatively from the carbonyl compound. This is a very important result that we shall capitalize on in Chapters 25 and 26. The base usually used is LDA (lithium diisopropylamide), and it works like this.

➔ The nitroso functional group, $-\text{N}=\text{O}$, may be new to you, but you met oximes in Chapter 11. Imine (and therefore oxime) hydrolysis was also discussed in Chapter 11.

■ You have already met LDA in Chapter 17, promoting elimination reactions (p. 398), but no other use of this base compares in importance with what we are telling you now. By far the most important use of LDA is for making lithium enolates.

 Interactive mechanism for lithium enolate formation with LDA

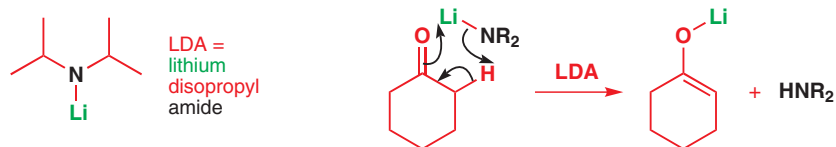

■ Never try to use BuLi to deprotonate a carbonyl compound! BuLi almost invariably adds to carbonyl groups as a nucleophile.

LDA is bulky, so it does not take part in nucleophilic attack at the carbonyl group, and it is basic—the pK_a of diisopropylamine is about 35, which is plenty basic enough to deprotonate next to any carbonyl group. The lithium enolate is stable at low temperature (-78°C) but reactive enough to be useful. Lithium enolates are the most commonly used stable enolate equivalents in chemistry.

Silyl enol ethers

Second only to lithium enolates in usefulness are silyl enol ethers. Silicon is less electropositive than lithium, and silyl enol ethers are more stable, and less reactive, than lithium enolates. They are made by treating an enolate with a silicon electrophile. Silicon electrophiles invariably react with enolates at the oxygen atom firstly because they are hard (see pp. 357 and 467) and secondly because of the very strong Si–O single bond. The most common silicon electrophile is trimethylsilyl chloride (Me_3SiCl), an intermediate made industrially in bulk and used to make the NMR standard tetramethylsilane (Me_4Si).

Silicon–oxygen bonds are so strong that silicon reacts with carbonyl compounds on oxygen even without a strong base to form the enolate: the reaction probably goes through the small amount of enol present in neutral solution and just needs a weak base (Et_3N) to remove the proton from the product. An alternative view is that the silicon reacts with oxygen first, and the base just converts the oxonium ion to the silyl enol ether. Both mechanisms are given below—either might be correct. This is one of the two best ways to make a stable enol derivative from virtually any enolizable carbonyl compound.

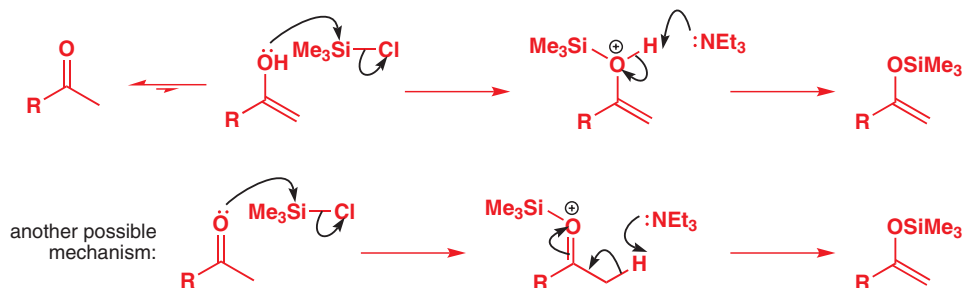

Silyl enol ethers can also be made from lithium enolates just by treating them with trimethylsilyl chloride.

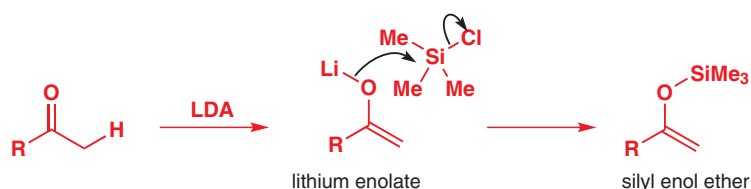

➡ The reason why you might want to carry out this seemingly rather pointless transformation will become clear in Chapter 25.

Occasionally, it can be useful to run this reaction in reverse, generating the lithium enolate from the silyl enol ether. This can be done with methyllithium, which takes part in nucleophilic substitution at silicon to generate the lithium enolate plus tetramethylsilane.

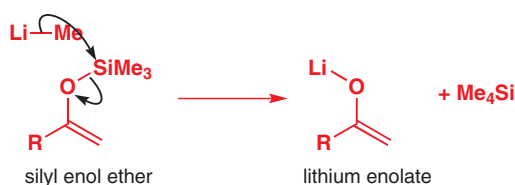

We shall be returning to silyl enol ethers and lithium enolates later in the book, but for the moment you should view them simply as enol derivatives that are stable enough to be formed quantitatively from carbonyl compounds before being used in further reactions.

Enol and enolate reactions at oxygen: preparation of enol ethers

You have just seen that silyl enol ethers are easy to make. But, if enolate ions have most of their negative charge on the oxygen atom, it ought to be possible to make ordinary, carbon-based ethers from them too. It is—but only under strange conditions. Normally, enols and enolate ions prefer to react with alkylating agents (such as alkyl halides) at carbon, as we shall see in Chapter 25. If enolate ions are prepared with potassium bases in dipolar aprotic solvents (such as dimethyl sulfoxide, DMSO) that cannot solvate the oxygen anion, and are treated with dimethylsulfate or trimethyloxonium ion—powerful methylating agents that react best with charged atoms—some at least of the enol ether is formed. The Me₃O⁺ ion is found in the stable (though reactive) compound trimethyloxonium tetrafluoroborate, or Meerwein's salt, Me₃O⁺BF₄⁻. This compound and dimethylsulfate, Me₂SO₄, are hard electrophiles with highly polarized C–O bonds which therefore react with the enolate at hard O rather than soft C.

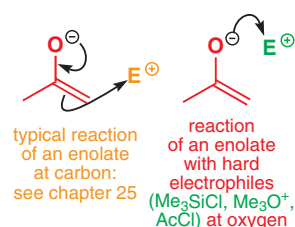

➔ Hard and soft reagents were discussed in Chapter 15 on p. 357.

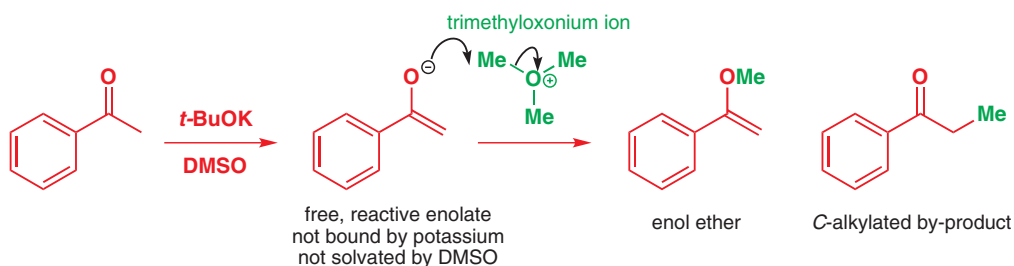

The yield in this reaction is about 60–70% of enol ether, the rest being mainly C-alkylated product. A more reliable method for making an enol ether is the acid-catalysed decomposition of an acetal in the strict absence of water:

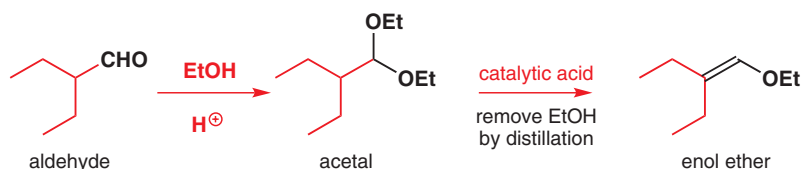

■ Acetal formation was discussed in Chapter 11. Any water in the second step of this sequence would give back the starting aldehyde by hydrolysis.

The reaction starts as though the acetal were being hydrolysed, but there is no water to continue the hydrolysis, so a proton is lost instead. In other words, with no suitable nucleophile for S_N1 substitution, E1 elimination takes place.



These enol ethers are rather unstable, particularly towards acid-catalysed hydrolysis (as described in the next section) and are not as useful as the silyl enol ethers. We shall next look at the enol-like reactions of both groups of enol ethers.

Reactions of enol ethers

Hydrolysis of enol ethers

➔ See p. 351 for a discussion of the unreactivity of 'normal' ethers.

Enols have an OH group and are alcohols of a sort. Normal alcohols form stable ethers that are difficult to convert back to the alcohol. Powerful reagents such as HI or BBr_3 are required and these reactions were discussed in Chapter 15. The reaction with HI is an $\text{S}_{\text{N}}2$ attack on the methyl group of the protonated ether and that is why a good nucleophile for saturated carbon, such as iodide or bromide, is needed for the reaction. Enol ethers, by contrast, are relatively unstable compounds that are hydrolysed back to the carbonyl compound simply with aqueous acid—dilute HCl or H_2SO_4 , for example.

conversion of normal ether to alcohol with HI

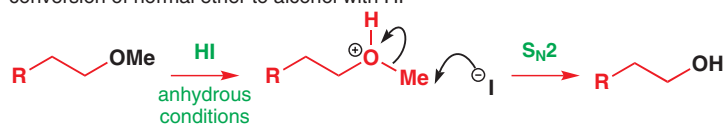

hydrolysis of enol ether with aqueous acid

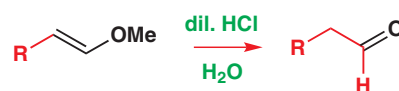

Why the big difference? The reason is that the enol ether can be protonated at carbon using the delocalization of the oxygen lone pair in the enol derivative to produce a reactive oxonium ion.



This oxonium ion could be attacked on the methyl group in the same way that the ordinary ether was attacked.

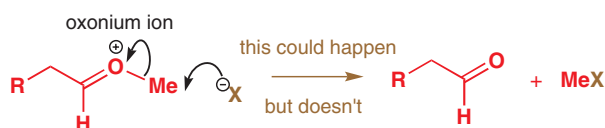

We wouldn't really expect this reaction to happen much faster than the same reaction on an ordinary ether, so there must be another better and faster mechanism. That mechanism is attack on the π bond instead of attack on the σ bond.

■ Attacks on π bonds are inherently faster than attacks on σ bonds as the more weakly held π electrons are more polarized by the difference in electronegativity between C and O.

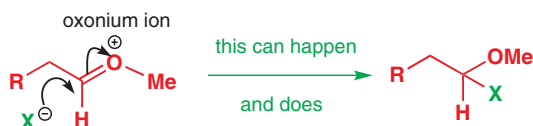

In aqueous acid the nucleophile X^- is just water and we find ourselves in the middle of the mechanism of hydrolysis of acetals (Chapter 11, p. 226). The oxonium ion is an intermediate common to both mechanisms.

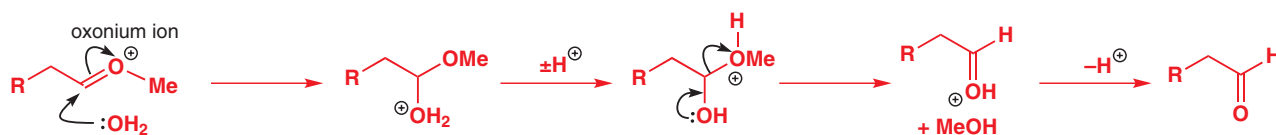

A similar reaction occurs when enol ethers react with alcohols in acid solution and in the absence of water, but now we are starting in the middle of the acetal hydrolysis mechanism and going the other way, in the direction of the acetal. A useful example is the formation of THP (tetrahydropyranyl) derivatives of alcohols from the enol ether dihydropyran. You will see THP derivatives of alcohols being used as protecting groups in Chapter 23.

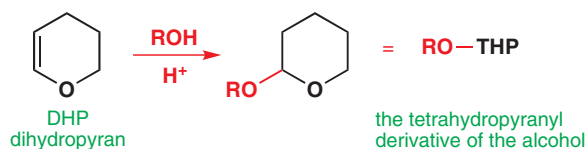

Silyl enol ethers hydrolyse by a slightly different mechanism, although the first step is the same—protonation at carbon using the lone pair on oxygen. We have already seen how easy it is to attack silicon with nucleophiles, especially those with oxygen or a halogen as the nucleophilic atom. This tips the balance towards attack by water at silicon for the next step.

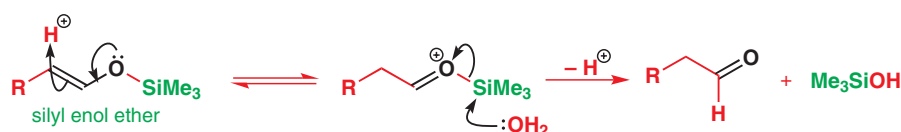

The aldehyde is formed immediately. What happens to the other product illustrates again just how easy nucleophilic substitution at silicon can be. Two of these compounds combine together to give a disilyl ether, called a disiloxane.

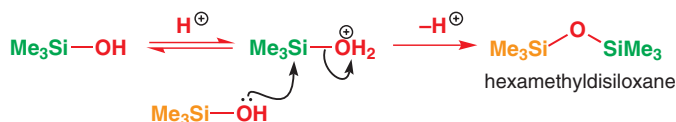

Reactions of silyl enol ethers with halogen and sulfur electrophiles

In comparison with other ethers, enol ethers of all kinds are rather unstable. As alkenes they are also more reactive than normal alkenes because of the lone pair of electrons on the oxygen atom. They react with electrophiles like bromine or chlorine on the α carbon atom, behaving like enol derivatives and not like alkenes.

Electrophilic attack occurs at the α carbon atom and the halide ion released in this step then attacks the silicon atom to release the product and a molecule of Me_3SiX , which will be hydrolysed during the work-up.



This procedure avoids the difficulties we outlined earlier in the direct halogenation of aldehydes and ketones. It allows the preparation of haloketones on the less substituted side of the carbonyl group, for instance.

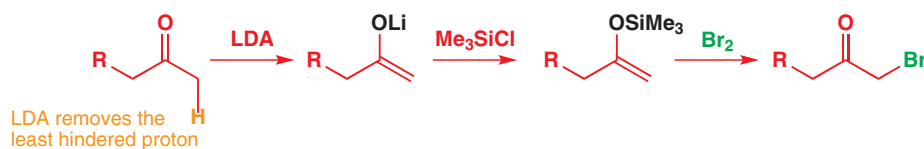

➔ See the discussion of THP protecting groups on p. 550 for the mechanism of this reaction, although you should be able to work it out without looking there!

Pyrans

Pyran is a six-membered oxygen-containing heterocyclic ring system with two double bonds. It is not aromatic although compounds like pyrones are. The compound with only one double bond is therefore dihydropyran, and the saturated ring system is tetrahydropyran.

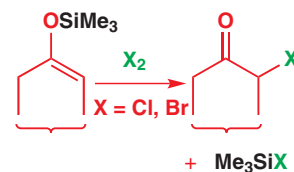
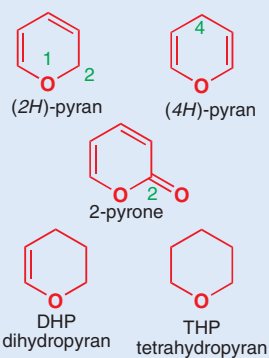

➔ There is more on the way LDA removes less hindered protons selectively on p. 600.

A similar method with the good soft electrophile PhSCl allows sulfenylation next to the carbonyl group.

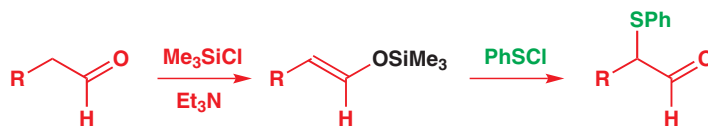

The mechanism is very similar: the electrophilic sulfur atom attacks the α carbon atom of the silyl enol ether, releasing a chloride ion that removes the Me_3Si group from the intermediate.

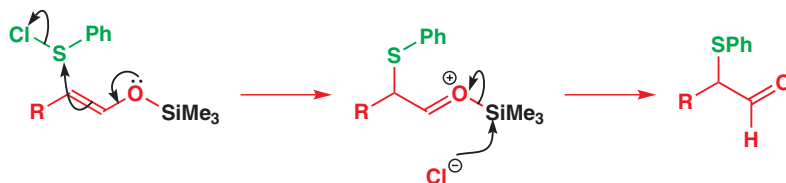

To conclude

You have now seen how enols and enolates react with electrophiles based on hydrogen (deuterium), carbon, halogens, silicon, sulfur, and nitrogen. What remains to be seen is how new carbon-carbon bonds can be formed with alkyl halides and carbonyl compounds in their normal electrophilic mode. These reactions are the subject of Chapters 25–26, but next we look at the ways aromatic compounds react with electrophiles. You will see similarities with the behaviour of enols.

Further reading

S. Warren, *Chemistry of the Carbonyl Group*, Wiley, Chichester, 1974: section 4 is 'Carbanions and Enolisation'. B. S. Furniss, A. J. Hannaford, P. W. G. Smith, and A. T. Tatchell, *Vogel's Textbook*

of Practical Organic Chemistry, Longman, 5th edn, 1989, has halogenation of carboxylic acids pp. 722–725, imine and enamine formation, pp. 782–783, and nitrosation of enols, pp. 627–631.

Check your understanding



To check that you have mastered the concepts presented in this chapter, attempt the problems that are available in the book's Online Resource Centre at <http://www.oxfordtextbooks.co.uk/orc/clayden2e/>

Connections

➔ Building on

- Structure of molecules [ch4](#)
- Conjugation [ch7](#)
- Mechanisms and catalysis [ch12](#)
- Electrophilic addition to alkenes [ch19](#)
- Enols and enolates [ch20](#)

Arriving at

- Phenols as aromatic enols
- Benzene and alkenes compared: what is special about aromatic compounds?
- Electrophilic attack on benzene
- Activation and deactivation of the benzene ring
- Position of substitution
- Elaborating aromatic structures: competition and cooperation
- Problems with some aromatic substitution reactions and how to solve them

➔ Looking forward to

- Nucleophilic aromatic substitution [ch22](#)
- Oxidation and reduction [ch23](#)
- Regioselectivity and ortholithiation [ch24](#)
- Retrosynthetic analysis [ch28](#)
- Aromatic heterocycles [ch29 & ch30](#)
- Rearrangements [ch36](#)
- Transition-metal catalysed couplings to aromatic compounds [ch40](#)

Introduction: enols and phenols

In the last chapter you saw that many ketones have a nucleophilic 'alter ego' known as an enol tautomer. Formation of the enol tautomer is catalysed by acid or by base, and because the ketone and enol are in equilibrium, enolization in the presence of D_2O can lead to replacement of the protons in the α positions of ketones by deuterium atoms. This is what happens to pentan-3-one in acidic D_2O :

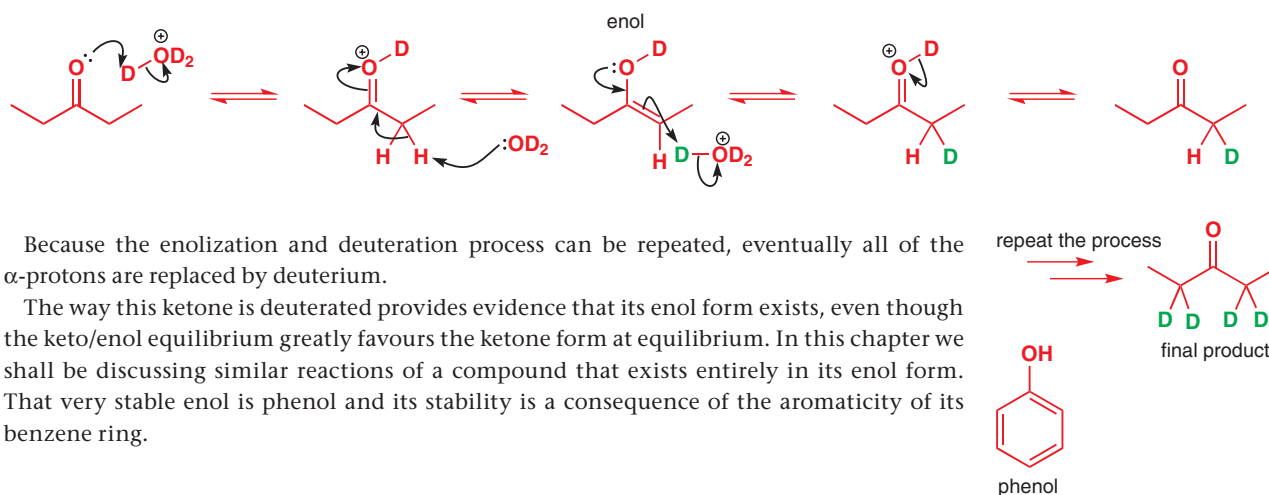

■ If you haven't just read Chapter 20, look back at p. 451 to remind yourself of how this works.

The proton NMR spectrum for phenol is shown below. Before reading any further cover up the rest of this page and make sure you can assign the spectrum.

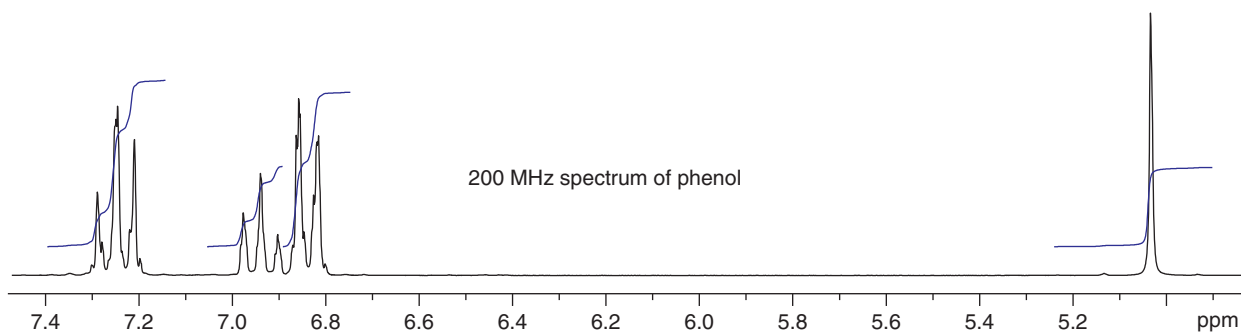

The next spectrum is the proton NMR after shaking phenol with acidic D_2O . Most of the peaks have almost disappeared because the H atoms have been replaced with D. Only one signal remains the same size, and even that is simplified because it has lost any coupling to adjacent protons it may have had previously.

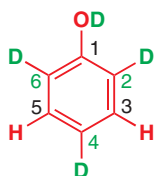
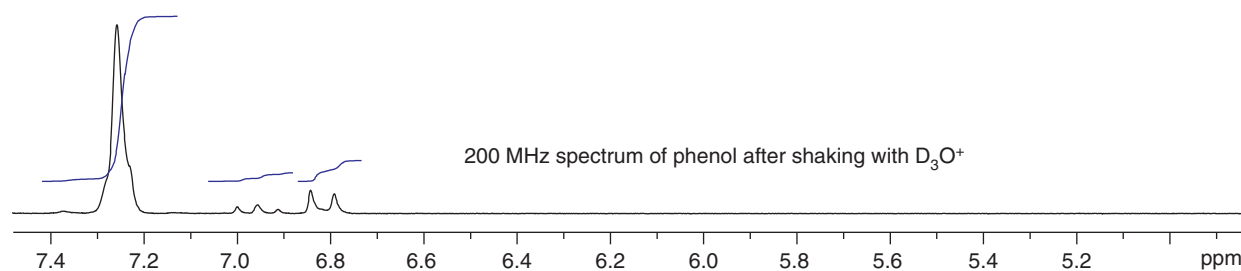

The signal that remains is the 2H signal for the protons in the 3 and 5 positions of the aromatic ring, so the product must be the one shown in the margin. We can explain why by using the same mechanism we used with the ketone on the previous page. Phenol is deuterated in the same way as other enols, except that the final product remains in the very stable, aromatic, enol form rather than reverting to the keto form. The first step (after initial replacement of the OH with OD) is addition of D_3O^+ to the enol.

➡ This equilibrium was discussed on p. 456.

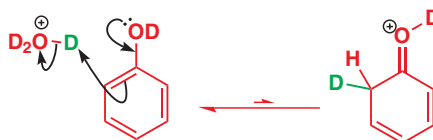

Now this cation could lose the D from oxygen to leave a ketone (brown arrow below), or it could lose the proton from carbon to leave the phenol (orange arrows below). Alternatively, it could just lose the D and go back to the starting material, which is why there is an equilibrium arrow in the scheme above.

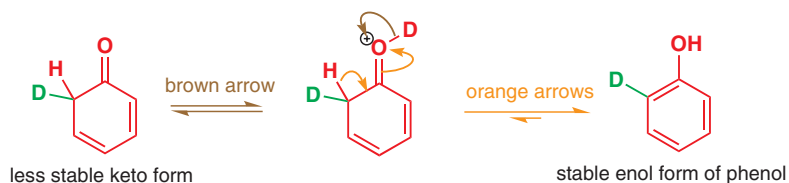

Our spectrum tells us that *three* ring protons are replaced by D—the ones at the 2, 4, and 6 positions. It's not hard to see how the same process on the other side of the OH group replaces the proton at C-6. But how does the D at position 4 get there? The enol of phenol is conjugated, and we can push the curly arrows one stage further, like this:

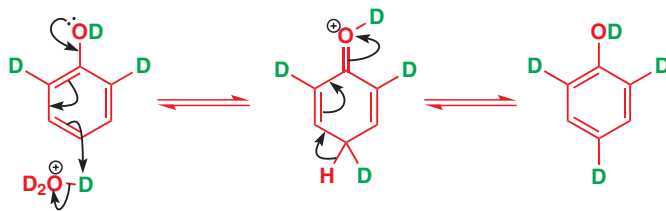

The end product on treating phenol with D_3O^+ has the protons in the 2, 4, and 6 positions (that is, the *ortho* and *para* positions) substituted by deuterium. D_3O^+ is an electrophile, and the overall process is called *electrophilic substitution*. It is a reaction characteristic of not only phenol but of other aromatic compounds, and it forms the subject of this chapter.

- When aromatic compounds react with electrophiles they generally do so by **electrophilic aromatic substitution**.

Benzene and its reactions with electrophiles

We'll start with the most straightforward aromatic compound: benzene. Benzene is a planar symmetrical hexagon with six trigonal (sp^2) carbon atoms, each having one hydrogen atom in the plane of the ring. All the bond lengths are 1.39 Å (compare C–C 1.47 Å and C=C 1.33 Å). All the ^{13}C shifts are the same (δ_{C} 128.5).

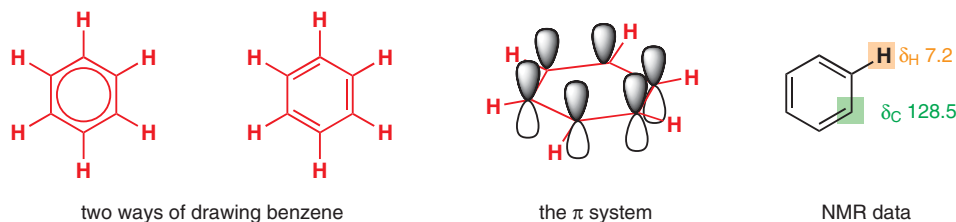

two ways of drawing benzene

the π system

NMR data

The special stability of benzene (aromaticity) comes from the six π electrons in three molecular orbitals formed by the overlap of the six atomic p orbitals on the carbon atoms. The energy levels of these orbitals are arranged so that there is exceptional stability in the molecule (a notional 140 kJ mol^{-1} over a molecule with three conjugated double bonds), and the shift of the six identical hydrogen atoms in the NMR spectrum (δ_{H} 7.2) is evidence of a ring current in the delocalized π system.

Drawing benzene rings

Benzene is symmetrical and the structure with a circle in the middle best represents this. However, it is impossible to draw curly arrow mechanisms using this representation so we shall usually make use of the Kekulé form with three double bonds. This does not mean that we think the double bonds are localized! It makes no difference which Kekulé structure you draw—any mechanism can be equally well drawn using either.

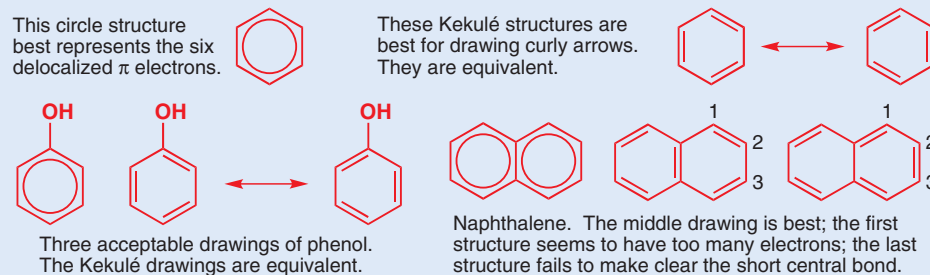

Aromatic substituents

A reminder (see pp. 36 and 416) of the names we give to the positions around a benzene ring relative to any substituent:

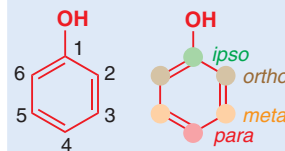

Ortho, *meta*, and *para* are sometimes abbreviated to *o*, *m*, and *p*.

■ The concept of *aromaticity* is central to this chapter: we will elaborate considerably on the introduction to aromatic compounds we presented in Chapter 7.

➔ The orbitals of benzene were discussed in Chapter 7.

In substituted aromatic molecules such as phenol, the C–C bond lengths in the ring are no longer exactly the same. However, it is still all right to use either representation, depending on the purpose of the drawing. With some aromatic compounds, such as naphthalene, it *does* matter which Kekulé structure you use as there is some alternation of bond lengths. Only the first Kekulé representation shows that the central bond is the strongest and shortest in the molecule and that the C1–C2 bond is shorter than the C2–C3 bond. And if a circle in a ring indicates six π electrons, then two circles suggests 12, even though naphthalene has only 10, making this representation less satisfactory too.

Electrophilic attack on benzene and on cyclohexene

Simple alkenes, including cyclohexene, react rapidly with electrophiles such as bromine or peroxy-acids (Chapter 19). Bromine gives the product of *trans* addition, peracids give epoxides by *cis* addition. Under the same conditions benzene reacts with neither reagent.



➔ Lewis acids were described on p. 180.

Benzene can, however, be persuaded to react with bromine if a Lewis acid catalyst such as AlCl_3 is added. The product contains bromine but is not from either *cis* or *trans* addition.



The bromine atom has replaced an atom of hydrogen, so this is a substitution reaction. The reagent (Br_2) is electrophilic and benzene is aromatic so the reaction is **electrophilic aromatic substitution**, the subject of this chapter.

We can compare the bromination of cyclohexene and of benzene directly.

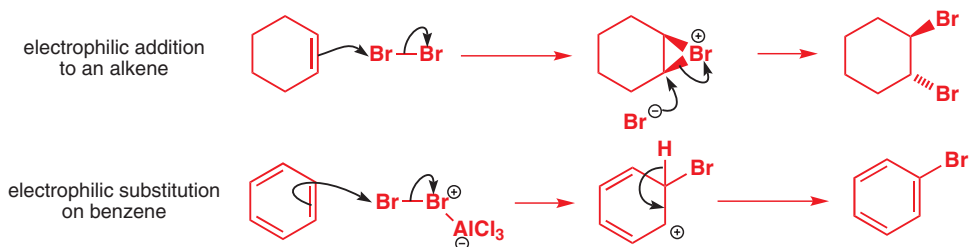

The intermediate in both reactions is a cation but the first (from cyclohexene) adds an anion while the second (from benzene) loses a proton so that the aromatic system can be restored. Notice also that neutral bromine reacts with the alkene but the cationic AlCl_3 complex is needed to get reaction with benzene. Bromine itself is a very reactive electrophile. It is indeed a dangerous compound and should be handled only with special precautions. Even so it does not react with benzene. It is difficult to get benzene to react with anything.

● Benzene is very unreactive

- It combines only with very reactive (usually cationic) electrophiles.
- It gives substitution and not addition products.

The intermediate in electrophilic aromatic substitution is a delocalized cation

We will return again and again to this mechanism of electrophilic aromatic substitution during this chapter. In its most general form the mechanism has two stages: attack by an electrophile to give an intermediate cation and loss of a proton from the cation to restore the aromaticity.

General mechanism for electrophilic aromatic substitution

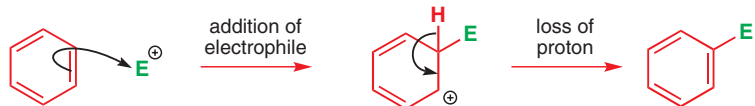

The cationic intermediate is, of course, unstable compared with the starting materials or the product. But it is nonetheless stabilized by delocalization. The arrows below show how the positive charge can be delocalized to the two *ortho* positions and to the *para* position, or can be drawn as a single delocalized structure with partial (dotted) bonds and about one-third of a positive charge (+) at three atoms.



the brown H is drawn in to emphasize the non-aromaticity of this delocalized cation

It's very important to note that although it is delocalized, this cation is not aromatic: there is no cyclic array of p orbitals because the ring contains a single tetrahedral (sp^3 hybridized) carbon atom. We have emphasized this tetrahedral atom by drawing in the hydrogen atom at the point of substitution—the one that will be lost when aromaticity is regained. We suggest that when you write mechanisms for electrophilic aromatic substitution you do the same. Given this loss of aromaticity, it is not surprising that formation of the cationic intermediate is the rate-determining step of an electrophilic aromatic substitution.

How do we know the cationic intermediate exists?

In strong acid, the electrophile is a proton and it is actually possible to observe this cationic intermediate. The trick is to pick a non-nucleophilic and non-basic counterion X^- , such as SbF_6^- . In this octahedral anion, the central antimony atom is surrounded by the fluorine atoms with the negative charge spread over all seven atoms. The protonation is carried out using FSO_3H and SbF_5 at $-120^\circ C$. A similar trick was described in Chapter 15 as a means to show the existence of simple carbocations as intermediates in the S_N1 mechanism.

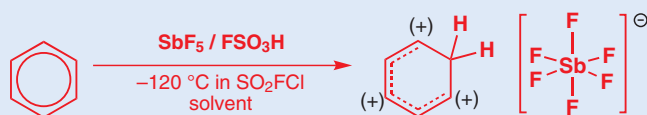

Under these conditions it is possible to record the 1H and ^{13}C NMR spectra of the cation. The shifts show that the positive charge is spread over the ring but is greatest (i.e. the electron density is least) at the *ortho* and *para* positions. Using the data for the 1H and ^{13}C NMR shifts (δ_H and benzene δ_C , respectively), a charge distribution can be calculated that closely matches the predictions of the curly arrows.

	position	δ_H	δ_C
0.26+	1	5.6	52.2
0.26+	2,6	9.7	186.6
0.09+	3,5	8.6	136.9
0.30+	4	9.3	178.1
	benzene (for comparison)	7.33	129.7

Nitration of benzene

Now we've introduced to you the general principles of electrophilic aromatic substitution we need to delve into the details a little more and show you some real reactions of benzene. In each case, a powerful cationic electrophile is needed to persuade the unreactive benzene to act as a nucleophile.

■ The delocalized structure of the nitro group was discussed in Chapter 2.

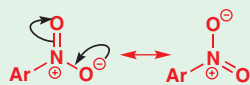

We'll start with nitration, the introduction of a nitro (NO_2) group. Nitration requires very powerful reagents, the most typical being a mixture of concentrated nitric and sulfuric acids.

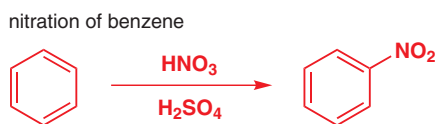

Sulfuric acid is the stronger acid and it produces the powerful electrophile NO_2^+ by protonating the nitric acid so that a molecule of water can leave.

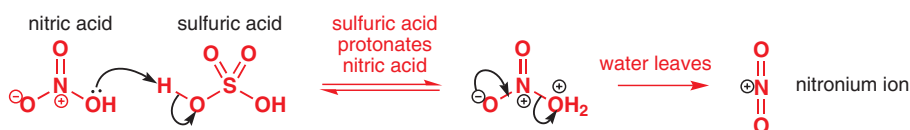

The nitronium ion (NO_2^+) is linear—it's isoelectronic with CO_2 , with an sp -hybridized nitrogen atom at the centre. It's this nitrogen that is attacked by benzene, breaking one of the $\text{N}=\text{O}$ bonds to avoid a five-valent nitrogen.

Interactive mechanism for nitration of benzene

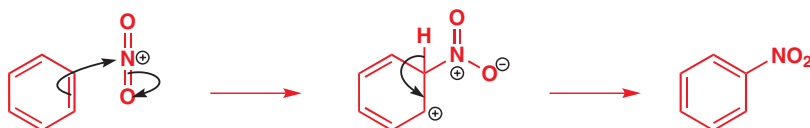

■ A reminder: electrophilic aromatic substitution mechanisms are easier to follow if you draw in the H at the point of substitution.

● Nitration converts aromatic compounds (ArH) into nitrobenzenes (ArNO_2) using NO_2^+ from $\text{HNO}_3 + \text{H}_2\text{SO}_4$.

The cationic intermediate can also be formed by the protonation of sulfur trioxide, SO_3 , and another way to do sulfonations is to use concentrated sulfuric acid with SO_3 added. These solutions have the industrial name **oleum**. It is possible that the sulfonating agent in all these reactions is not protonated SO_3 but SO_3 itself.

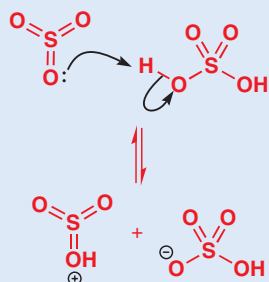

Sulfonation of benzene

Benzene reacts slowly with sulfuric acid alone to give benzenesulfonic acid. One molecule of sulfuric acid protonates another and loses a molecule of water. Notice the similarity with the first step of the nitration above.



The cation produced is very reactive and attacks benzene by the same mechanism we have seen for bromination and nitration—slow addition to the π system followed by rapid loss of a proton to regenerate aromaticity.

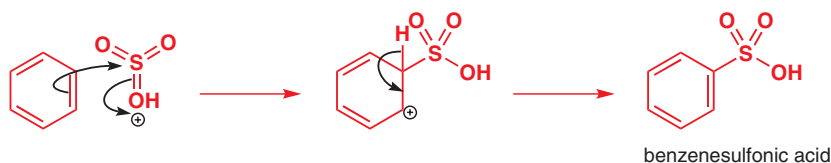

Interactive mechanism for sulfonation of benzene

The product contains the sulfonic acid group $-\text{SO}_2\text{OH}$. Sulfonic acids are strong acids, about as strong as sulfuric acid itself. They are stronger than HCl , for example, and can be isolated

from the reaction mixture as their crystalline sodium salts if an excess of NaCl is added. Not many compounds react with NaCl!

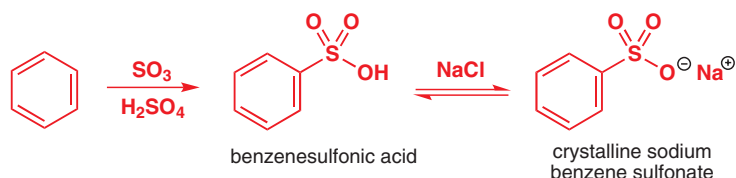

➔ You met a related sulfonate anion in the guise of the excellent tosylate leaving group in Chapter 15.

● Sulfonation with H_2SO_4 or SO_3 in H_2SO_4 converts aromatic compounds (ArH) into aromatic sulfonic acids (ArSO_2OH). The electrophile is SO_3 or SO_3H^+ .

Alkyl and acyl substituents can be added to a benzene ring by the Friedel–Crafts reaction

So far we have added heteroatoms only—bromine, nitrogen, or sulfur. Adding a carbon substituent to a reluctant aromatic nucleophile requires reactive carbon electrophiles and that means carbocations. In Chapter 15 you learned that any nucleophile, however weak, will react with a carbocation in the $\text{S}_{\text{N}}1$ reaction: benzene rings are no exception. The classic $\text{S}_{\text{N}}1$ electrophile is the *t*-butyl cation, which is generated from *tert*-butanol with acid.

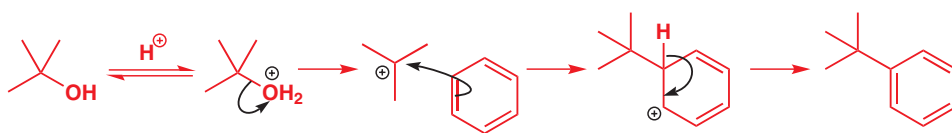

This is, in fact, an unusual way to carry out such reactions. The **Friedel–Crafts alkylation**, as this is known, usually involves treating benzene with a tertiary alkyl chloride and the Lewis acid AlCl_3 . Rather in the manner of the reaction with bromine, AlCl_3 removes the chlorine atom from *t*-BuCl and releases the *t*-Bu cation for the alkylation reaction.

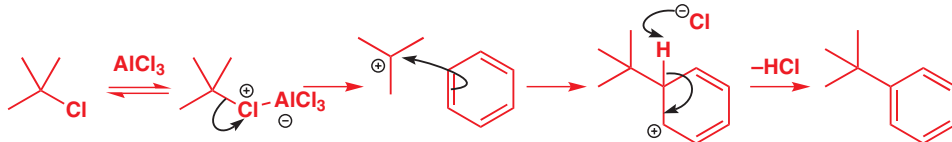

We have not usually bothered with the base that removes the proton from the intermediate. Here it is chloride ion as the by-product is HCl, so you can see that even a very weak base will do. Anything, such as water, chloride, or other counterions of strong acids, will do this job well enough and you need not in general be concerned with the exact agent.

A more important variation of this reaction is the **Friedel–Crafts acylation** with acid chlorides and AlCl_3 . Aluminium chloride behaves with acyl chlorides much as it does with alkyl chlorides—it removes chloride to leave behind a cation. In this case the cation is a linear acylium ion, with the carbocation stabilized by the adjacent oxygen lone pair. When the acylium ion attacks the benzene ring it gives an aromatic ketone: the benzene ring has been acylated.

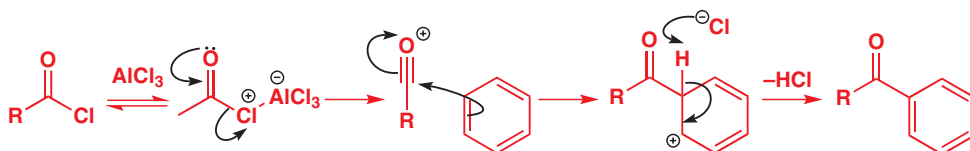

Charles Friedel (1832–1899), a French chemist, and James Crafts (1839–1917), an American mining engineer, both studied with Wurtz and then worked together in Paris, where in 1877 they discovered the reaction which now carries their names.

Interactive mechanism for Friedel–Crafts alkylation

Interactive mechanism for Friedel–Crafts acylation

➔ We'll come back (on p. 492) to why this is and what can be done about it.

The acylation is better than the alkylation because it does not require any particular structural feature in the acyl chloride—R can be almost anything. In the alkylation step it is essential that the alkyl group can form a cation, otherwise the reaction does not work very well. In addition, for reasons we are about to explore, the acylation stops cleanly after one reaction whereas the alkylation often gives mixtures of products.

● Friedel–Crafts reactions

Friedel–Crafts alkylation with *t*-alkyl chlorides and Lewis acids (usually AlCl_3) gives *t*-alkyl benzenes. The more reliable Friedel–Crafts acylation with acid chlorides and Lewis acids (usually AlCl_3) gives aryl ketones.

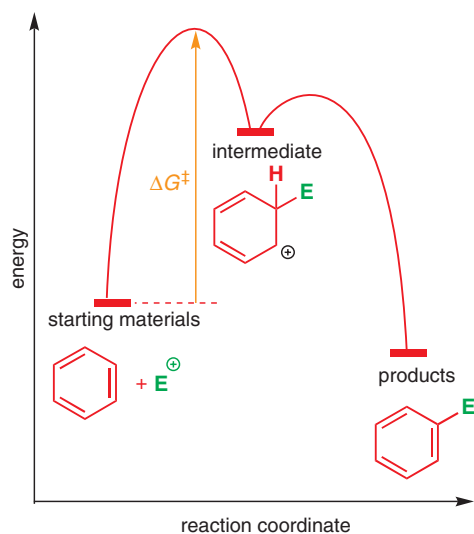

Summary of electrophilic substitution on benzene

This completes our preliminary survey of the most important reactions in aromatic electrophilic substitution. We shall switch our attention to the benzene ring itself now and see what effects various types of substituent have on these reactions. During this discussion we will return to each of the main reactions and discuss them in more detail. Meanwhile, we conclude this introduction with an energy profile diagram for a typical substitution.

Since the first step involves the temporary disruption of the aromatic π system, and is therefore rate determining, it must have the higher-energy transition state. The intermediate is unstable and has a much higher energy than either the starting material or the products, close to that of the transition states for its formation and breakdown. The two transition states will be similar in structure to the intermediate and we shall use the intermediate as a model for the important first transition state.

■ This argument is based on the **Hammond postulate**, which suggests that structures close in energy that transform directly into each other are also similar in structure. For more on this, see Chapter 39.

● Summary of the main electrophilic substitutions on benzene

Reaction	Reagents	Electrophile	Product
bromination	Br_2 and Lewis acid, e.g. AlCl_3 , FeBr_3 , Fe powder		
nitration	$\text{HNO}_3 + \text{H}_2\text{SO}_4$		
sulfonation	concentrated H_2SO_4 or $\text{H}_2\text{SO}_4 + \text{SO}_3$ (oleum)		
Friedel–Crafts alkylation	$\text{RX} + \text{Lewis acid usually } \text{AlCl}_3$		
Friedel–Crafts acylation	$\text{RCOCl} + \text{Lewis acid usually } \text{AlCl}_3$		

Electrophilic substitution on phenols

We started this chapter by comparing phenols with enols and now we return to phenols and look at electrophilic substitution in full detail. You will find that the reaction is much easier than it was with benzene itself because phenols are like enols and the same reactions (bromination, nitration, sulfonation, and Friedel–Crafts reactions) occur more easily. There is a new question too: the positions round the phenol ring are no longer equivalent—so where does substitution take place?

Phenols react rapidly with bromine

Benzene does not react with bromine except with Lewis acid catalysis. Phenols react in a very different manner: no Lewis acid is needed, the reaction occurs very rapidly, and the product contains three atoms of bromine in specific positions. All that needs to be done is to add bromine dropwise to a solution of phenol in ethanol. Initially, the yellow colour of the bromine disappears but if, when the colour just remains, water is added, a white precipitate of 2,4,6-tribromophenol is formed.

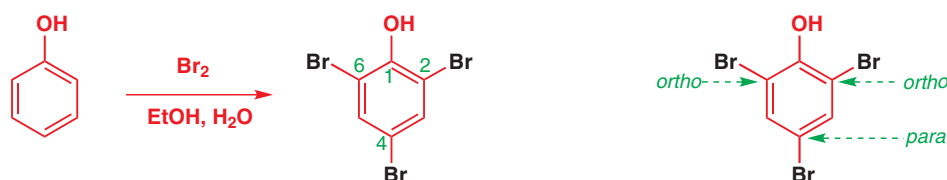

The product shows that bromination has occurred at the *para* position and at both *ortho* positions. What a contrast to benzene! Phenol reacts three times, without catalysis, at room temperature. Benzene reacts once, and needs a Lewis acid to make the reaction go at all. The difference is, of course, the enol nature of phenol. The non-bonding lone pair of electrons at oxygen contribute to a much higher-energy HOMO than the low-energy bonding electrons in a benzene ring. We should let our mechanism show this. Starting in the *para* position:

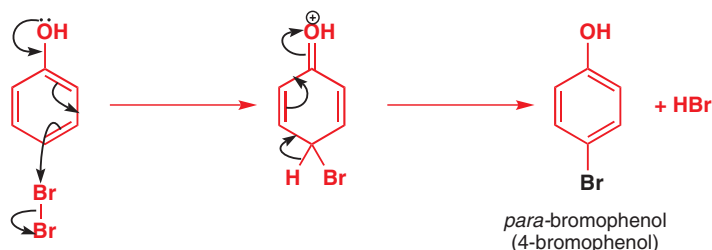

Notice that we start the chain of arrows with the lone pair electrons on the OH group and push them through the ring so that they emerge at the *para* position to attack the bromine molecule. The benzene ring is acting as a conductor, allowing electrons to flow from the OH group to the bromine molecule.

Now the reaction is repeated, but this time at one of the two equivalent *ortho* positions:

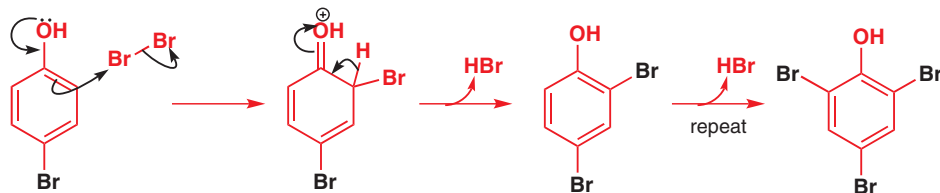

Again the lone pair electrons on the OH group are fed through the benzene ring to emerge at the *ortho* position. A third bromination in the remaining *ortho* position—you could draw the mechanisms for this as practice—gives the final product 2,4,6-tribromophenol.

Why do we use numbers for some descriptions, such as 2,4-dibromophenol, but also use *ortho* and *para* in others? The numbers are best in naming compounds but we need *ortho* and *para* to describe the relationship between substituents. Phenol brominates in both *ortho* positions. In this molecule they happen to be positions 2 and 6. In other molecules, where the OH group is not at C1, they will still be *ortho* to the OH group. Use whichever description suits the point you are making.

■ This mechanism should remind you of the bromination of enols in Chapter 20.

A similar reaction with chlorine is used to make the well-known antiseptic TCP (2,4,6-trichlorophenol). The characteristic smell of TCP is typical of the smell of many other phenols.

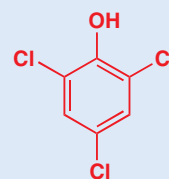

2,4,6-trichlorophenol (TCP)

If you want to put just one bromine atom into a phenol, you must work at low temperature ($<5\text{ }^{\circ}\text{C}$) and use just one equivalent of bromine. The best solvent is the rather dangerously inflammable carbon disulfide (CS_2), the sulfur analogue of CO_2 . Under these conditions, *para*-bromophenol is formed in good yield as the main product (which is why we started the mechanism for bromination of phenol in the *para* position). The minor product is *ortho*-bromophenol.

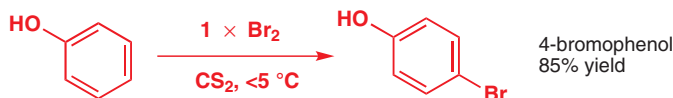

The OH group is said to be *ortho, para-directing* towards electrophiles. No substitution occurs in either *meta* position. We can understand this by looking at the curly arrow mechanisms or by looking at the molecular orbitals. In Chapter 20 (p. 453) we looked at the π system of an enolate and saw how the electron density is located mainly on the end atoms (the oxygen and the carbon). In phenol it is the *ortho* and *para* positions that are electron-rich (and, of course, the oxygen itself). We can show this using curly arrows.

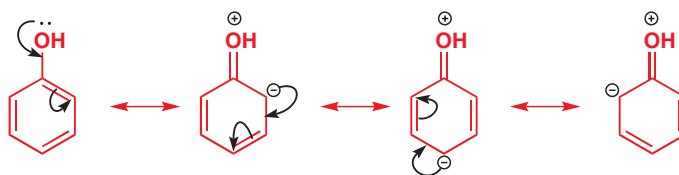

The curly arrows actually give an indication of the electron distribution in the HOMO of the molecule. The reason is that the HOMO has large coefficients at *alternate atoms*, just as the allyl anion had large coefficients at its ends but not in the middle (Chapter 7).

NMR can give us some confirmation of the electron distribution

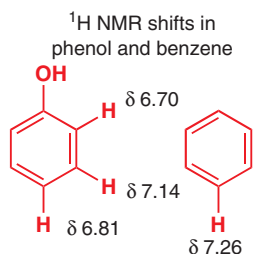

The ^1H NMR shifts of phenol give us an indication of the electron distribution in the π system. The more electron density that surrounds a nucleus, the more shielded it is and so the smaller the shift (see Chapter 13). All the chemical shifts for the ring protons in phenol are smaller than those for benzene (7.26 ppm), which means that overall there is greater electron density in the ring. There is little difference between the *ortho* and the *para* positions: these are where the electron density is greatest and hence these are the sites for electrophilic attack. The chemical shift at the *meta* positions is not significantly different from those in benzene—this is where the electron density is lowest.

● Electrophilic attack on phenols

OH groups on benzene rings are *ortho, para-directing* and activating.

You will get the right product if you start your arrows at a lone pair on the OH group.

Oxygen substituents activate a benzene ring

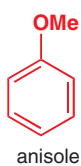

To brominate phenol, all we had to do was to mix bromine and phenol—if we do this with benzene itself, nothing happens. We therefore say that, relative to benzene, the OH group in phenol *activates* the ring towards electrophilic attack. The OH group is both activating and *ortho, para-directing*. Other groups that can donate electrons also activate and direct *ortho, para*. Anisole (methoxybenzene) is the ‘enol ether’ equivalent of phenol. It reacts faster than benzene with electrophiles.

2,4-D

The multiple chlorination of another oxygen-substituted compound, phenoxyacetic acid, leads to a useful product. Chlorination with two equivalents of chlorine provides 2,4-dichlorophenoxy acetic acid, which is the herbicide 2,4-D. The oxygen substituent again activates the ring and directs the chlorination to the *ortho* and *para* positions.

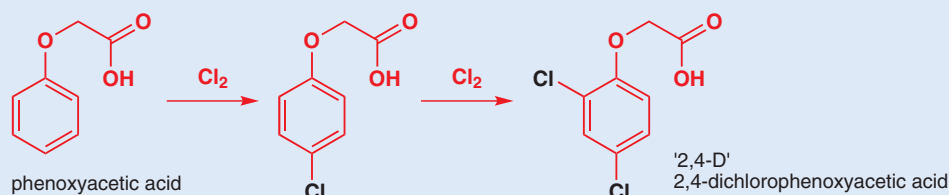

Nitration of phenol is also very fast and can be problematic under the usual nitration conditions (conc. HNO_3 , conc. H_2SO_4) because concentrated nitric acid oxidizes phenols. The solution is to use dilute nitric acid. The concentration of NO_2^+ will be small but that does not matter with such a reactive benzene ring.

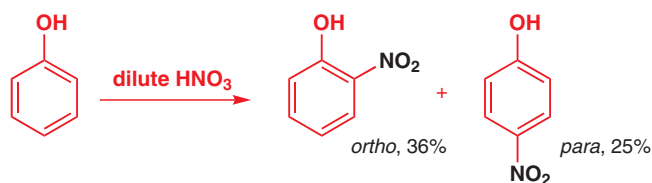

The product is a mixture of *ortho*- and *para*-nitrophenol from which the *ortho* compound can be separated by steam distillation. A strong intramolecular hydrogen bond reduces the availability of the OH group for intermolecular hydrogen bonding so the *ortho* compound has a lower boiling point.

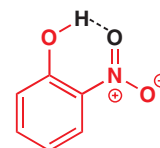

strong intramolecular H bond

Paracetamol from a phenol

The remaining *para*-nitrophenol is used in the manufacture of the painkiller paracetamol (also known as acetaminophen).

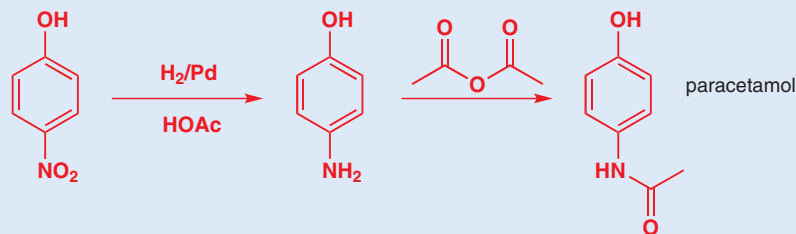

The phenoxide ion is even more reactive towards electrophilic attack than phenol. It manages to react with such weak electrophiles as carbon dioxide. This reaction, known as the **Kolbe–Schmitt process**, is used industrially to prepare salicylic acid (2-hydroxybenzoic acid), a precursor in making aspirin.

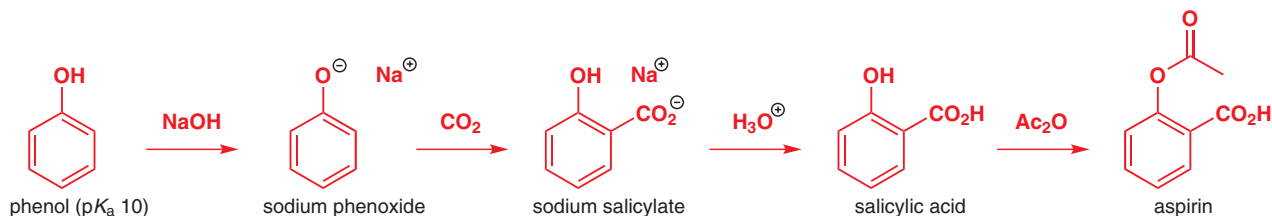

■ Salicylic acid is 2-hydroxybenzoic acid and is named after the willow trees (genus *Salix*) from which it was first isolated.

The O^- substituent is *ortho*, *para*-directing but the electrophilic substitution step with CO_2 gives mostly the *ortho* product. There must be some coordination between the sodium ion and the oxygen atoms of both the phenoxide and CO_2 that delivers the electrophile to the *ortho* position.

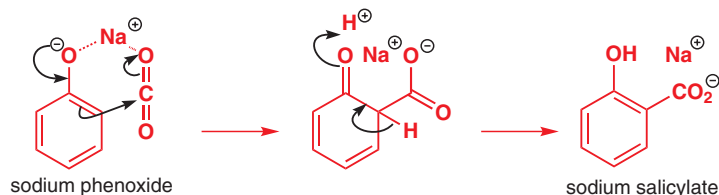

A nitrogen lone pair activates even more strongly

Aniline (phenylamine) is even more reactive towards electrophiles than phenols, phenyl ethers, or phenoxide ions. Because nitrogen is less electronegative than oxygen, the lone pair is higher in energy and so even more available to interact with the π system than is the lone pair on oxygen. Reaction of aniline with bromine is very vigorous and rapidly gives 2,4,6-tribromoaniline. The mechanism is very similar to the bromination of phenol so we show only one *ortho* substitution to remind you of how it goes.

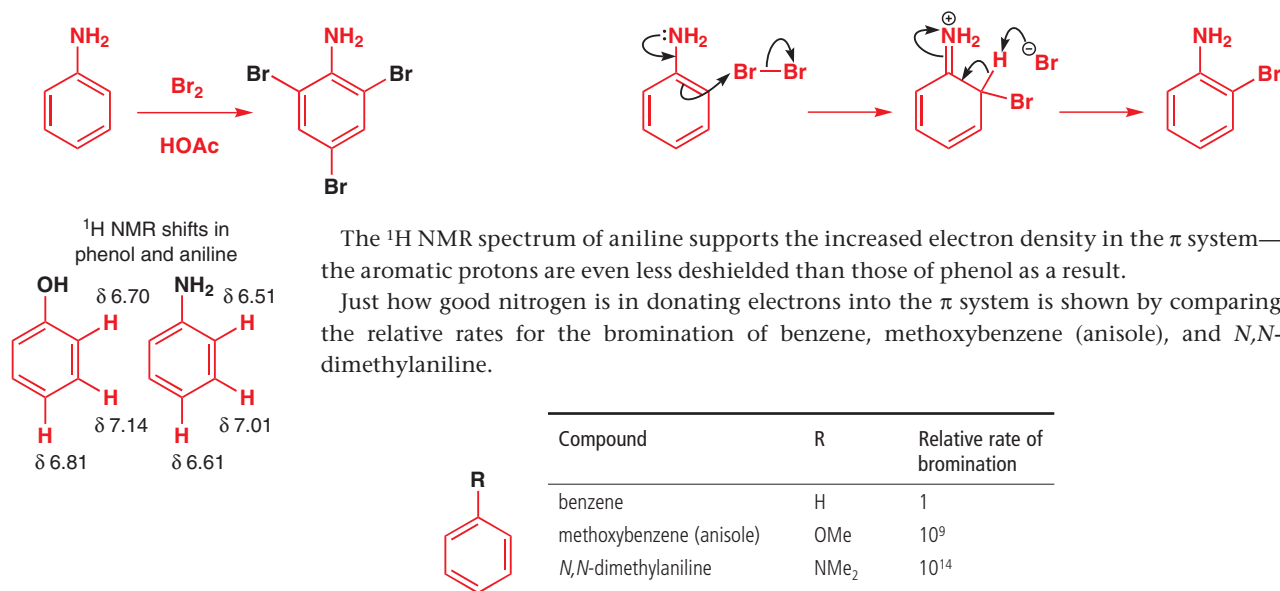

Making aromatic amines less reactive

The high reactivity of aniline can actually be a problem. Suppose we wanted to put just one bromine atom onto the ring. With phenol, this is possible (p. 480)—if bromine is added slowly to a solution of phenol in carbon disulfide solution and the temperature is kept below 5°C , the main product is *para*-bromophenol. Not so if aniline is used—the main product is the triply substituted product.



How then could we prevent oversubstitution from occurring? What we need is a way to make aniline less reactive by preventing the nitrogen lone pair from interacting so strongly with the π system of the ring. Fortunately, it is very simple to do this. In Chapter 8 (p. 175) we saw how the nitrogen atom in an amide is much less basic than a normal amine because it is conjugated with the carbonyl group. This is the strategy that we will use here—simply acylate the amine to form an amide. The lone pair electrons on the nitrogen atom of the amide are conjugated with the carbonyl group as usual but their delocalization into the benzene ring is weaker than in the amine. The amide nitrogen donates less electron density into the ring, so the electrophilic aromatic substitution is more controlled. The lone pair is still there, but its power is tamed. Reaction still occurs in the *ortho* and *para* positions (mainly *para*) but it occurs once only.

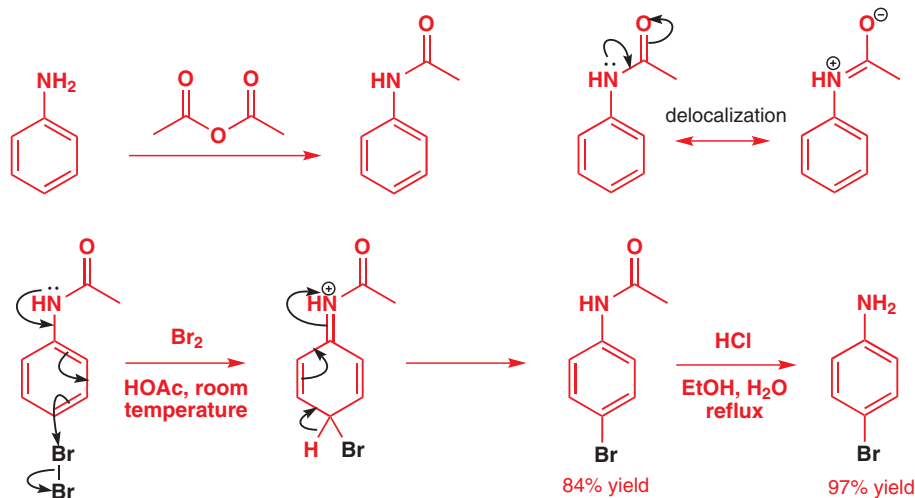

Amides formed by the acylation of anilines are sometimes called *anilides*. If they are acetyl derivatives they are called *acetanilides*. We shall not use these names but you may meet them elsewhere.

After the reaction, the amide can be hydrolysed (here, with aqueous acid) back to the amine.

- Anilines react rapidly with electrophiles to give polysubstituted products. Their amide derivatives react in a more controlled manner to give *para*-substituted products.

Selectivity between *ortho* and *para* positions

Phenols and anilines react in the *ortho* and/or *para* positions for electronic reasons. These are the most important effects in deciding where an electrophilic substitution will occur on a benzene ring. When it comes to choosing between *ortho* and *para* positions we need to consider steric effects as well. You will have noticed that we have seen one *ortho* selective reaction—the formation of salicylic acid from phenol—and several *para* selective reactions such as the bromination of an amide just discussed.

If the reactions occurred merely statistically, we should expect twice as much *ortho* as *para* product because there are two *ortho* positions. However, we should also expect more steric hindrance in *ortho* substitution since the new substituent must sit closely beside the one already there. With large substituents, such as the amide, steric hindrance will be significant and it is not surprising that we get more *para* product.

There is another effect that decreases the amount of *ortho* substitution, and that is the *inductive* electron-withdrawing effect of an electronegative substituent. As you've seen, oxygen and nitrogen, although they are electronegative, activate the ring towards attack by donating π electron density from their lone pairs. At the same time, the C–O or C–N σ bond is polarized back towards the O or N atom—in other words, they *donate* electron density to the π system but *withdraw* electron density from the σ framework. This is *inductive* electron withdrawal—it affects the atoms nearest the O or N atom the most, and has the effect of decreasing the likelihood that attack will happen in the *ortho* positions.

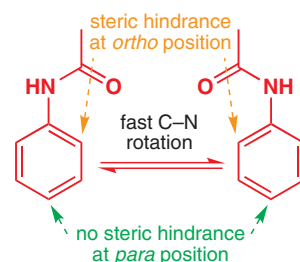

Inductive effects were introduced on p. 135.

Alkyl benzenes also react at the *ortho* and *para* positions

This is what happens when toluene (methylbenzene) meets bromine:

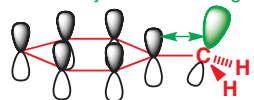
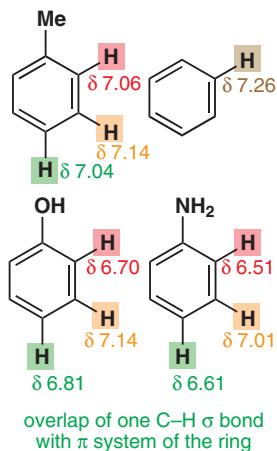
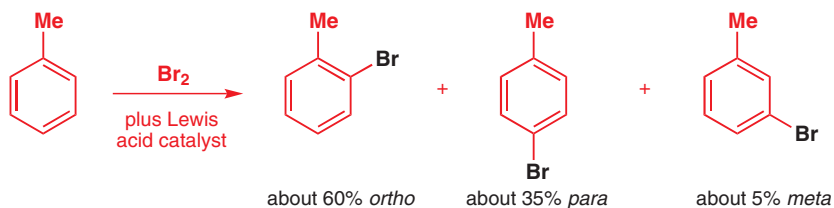

favourable intermediate for *ortho* substitution

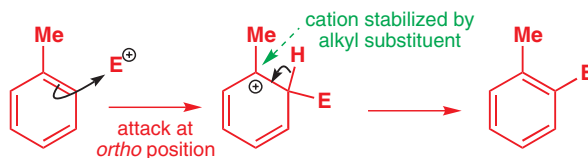
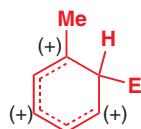

■ You are familiar with the idea that more substituted cations are more stable (Chapter 15, p. 335) and that more substituted alkenes are more stable (Chapter 17, p. 394). The effect we are discussing here is the same.

favourable intermediate for *para* substitution

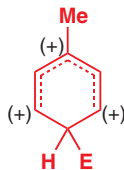

Electrophilic attack occurs on alkyl benzenes so that the positive charge ends up on the carbon bearing the alkyl group. This carbon is tertiary, making the cation there more stable. This condition is fulfilled if toluene is attacked at the *ortho* position, as shown above, but also at the *para* position, because in both cases the positive charge is delocalized onto the same three carbon atoms.

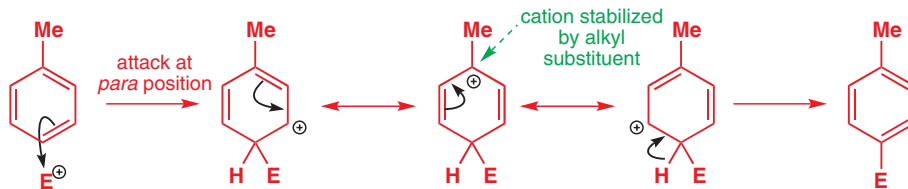

If, on the other hand, the electrophile were to attack at the *meta* position, the charge would end up delocalized over three carbon atoms, none of which are tertiary, so no stabilization by the alkyl group is possible. The situation is no worse than that of benzene, but given that toluene reacts some 10^3 times faster than benzene at the *ortho* and *para* positions these reactions win out. Nonetheless, unlike phenol, toluene does give trace amounts of *meta*-substituted products.

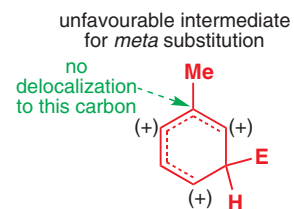
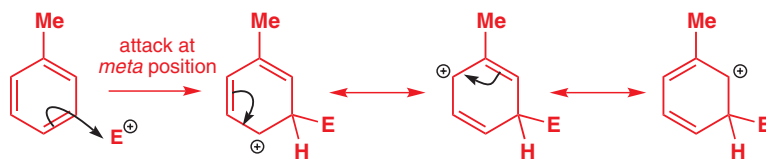

Protonating toluene with a superacid

On p. 475 we described how to observe the cationic intermediate in electrophilic substitution reactions of benzene by protonation in an NMR tube using a superacid. In benzene the cation which forms is symmetrical. Doing the same experiment with toluene leads to protonation in the *para* position.

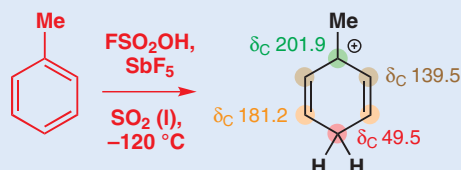

The *ortho* (to the Me group) carbon has a shift (δ 139.5) only 10 ppm greater than that of benzene (δ 129.7) but the *ipso* and *meta* carbons have the very large shifts that we associate with cations. The charge is mainly delocalized to these carbons but the greatest charge is at the *ipso* carbon.

The sulfonation of toluene

Direct sulfonation of toluene with concentrated sulfuric acid gives a mixture of *ortho* and *para* sulfonic acids from which about 40% of toluene *para* sulfonic acid can be isolated as the sodium salt.

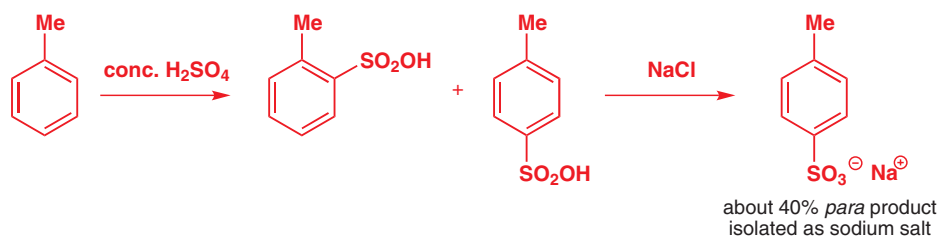

We shall use SO_3 as the electrophile in this case and draw the intermediate with the charge at the *ipso* carbon to show the stabilization from the methyl group.

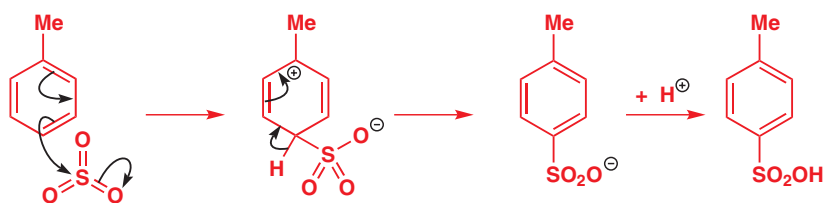

You met the *para*-toluenesulfonate group (tosylate, OTs) as an important leaving group if you want to carry out an $\text{S}_{\text{N}}2$ reaction on an alcohol (Chapter 15, p. 349) and the acid chloride (tosyl chloride, TsCl) needed to make tosylates can be made from the acid in the usual way (p. 215) with PCl_5 . It can also be made directly from toluene by sulfonation with chlorosulfonic acid ClSO_2OH . This reaction favours the *ortho* sulfonyl chloride, which is isolated by distillation.

Toluenesulfonic acid

The product *para*-toluenesulfonic acid is important as a convenient solid acid, useful when a strong acid is needed to catalyse a reaction. Being much more easily handled than oily and corrosive sulfuric acid or syrupy phosphoric acid, it is useful for acetal formation (Chapter 11) and eliminations by the $\text{E}1$ mechanism on alcohols (Chapter 17). It also gets called tosic acid, TsOH, or PTSA, and its sulfonyl chloride derivative is tosyl chloride, TsCl (Chapter 15).

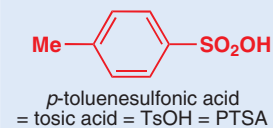

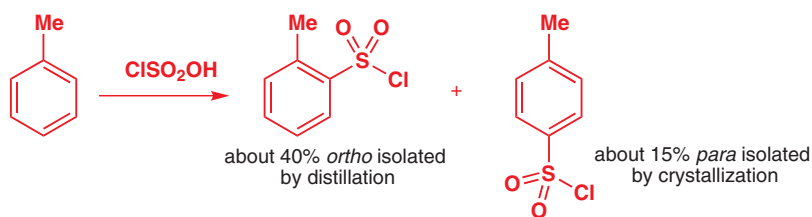

No other acid is needed because chlorosulfonic acid is a very strong acid indeed and protonates itself to give the electrophile. This explains why OH is the leaving group rather than Cl and why chlorosulfonation rather than sulfonation is the result.



In drawing the mechanism we can again get the positive charge onto the tertiary *ipso* atom. No treatment with NaCl is needed in this reaction as the major product (the *ortho* acid chloride) is isolated by distillation.

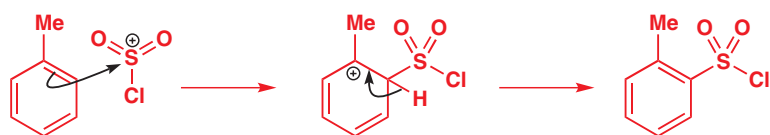

It is fortunate that the *ortho* acid chloride is the major product in the chlorosulfonation because it is needed in the synthesis of saccharin, the first of the non-fattening sweeteners. The formation of the sulfonamide is like that of an ordinary amide, but the oxidation of the methyl group with potassium permanganate is probably new to you. It's a rather vigorous reaction, but one which very usefully turns toluene derivatives into benzoic acid derivatives.

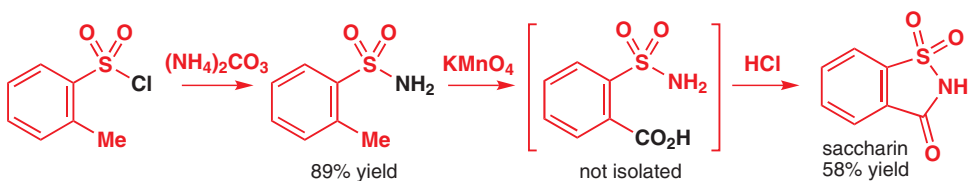

■ The preference for *para* product in the sulfonation and *ortho* product in the chlorosulfonation is the first hint that sulfonation is reversible. This point is discussed, and exploited, in Chapter 24 (p. 566).

■ As you will see in the next section, the substitution reactions of benzoic acid derivatives show different selectivity from the substitution reactions of toluene itself.

- Alkylbenzenes react with electrophiles faster than benzene and give mixtures of *ortho*- and *para*-substituted products.

Electron-withdrawing substituents give *meta* products

So far, all of the substituted benzene rings we have considered have carried substituents capable of donating electron density to the ring: despite being electronegative atoms, oxygen and nitrogen have lone pairs which conjugate with the ring's π system; a similar but weaker effect results from σ conjugation from a methyl group. Two consequences arise from these substituents: the ring becomes more reactive than benzene, and substitution takes place in the *ortho* and *para* positions.

So what happens with groups which pull electron density away from the ring? Such a group is the trimethylammonium substituent: the nitrogen is electronegative but unlike in aniline this electronegativity is not offset by donation of a lone pair—the nitrogen is tetrahedral and no longer has one to donate. Nitration of the phenyltrimethyl ammonium ion yields mainly

the *meta* product. And it does so slowly too—this nitration proceeds about 10^7 times more slowly than that of benzene.

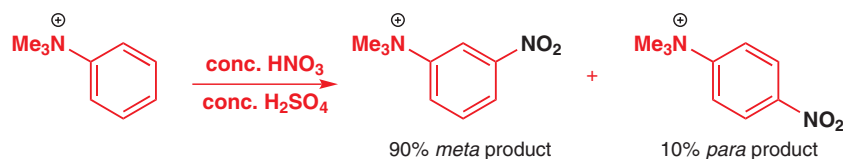

The same thing happens with the CF_3 group. The three very electronegative fluorine atoms polarize the C–F bonds so much that the Ar–C bond is polarized too. Nitration of trifluoromethylbenzene gives a nearly quantitative yield of *meta* nitro compound.

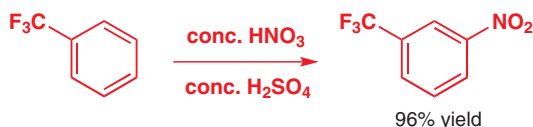

Draw the mechanism for this reaction and you see the reason for the switch to *meta* selectivity.

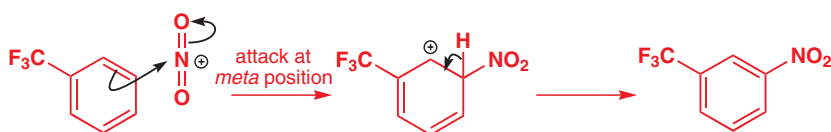

The intermediate cation is again delocalized over three carbons, but importantly none of these carbons is the one next to the CF_3 group.

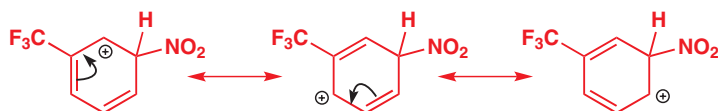

charge can avoid being delocalized to this carbon



favourable intermediate for *meta* substitution

If, on the other hand, the electrophile were to attack the *ortho* or *para* position (the hypothetical reaction *para* to CF_3 is shown below) then the carbon next to CF_3 would *have* to carry a positive charge, which would be destabilized by the electron withdrawal, making this a high-energy intermediate.

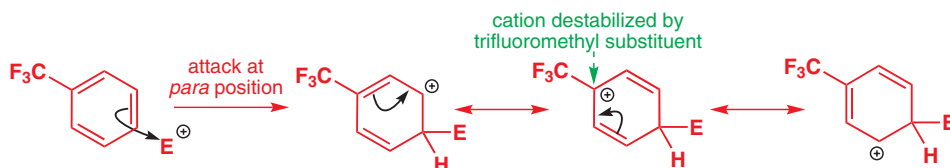

cation destabilized by trifluoromethyl substituent

unfavourable intermediate for *para* substitution

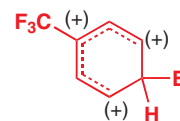

Think of it this way: the electron-deficient ring would really rather not react with an electrophile (hence the slower rate) but if it has to (because the electrophile is so reactive) then it takes the least bad course of keeping the positive charge away from the electron-withdrawing groups—and that means *meta* substitution.

Some substituents withdraw electrons by conjugation

Aromatic nitration is important because it is a convenient way of adding a nitrogen substituent to the ring and because it stops cleanly after one nitro group has been added. Double nitration of benzene is possible but stronger conditions must be used—fuming nitric acid instead of normal concentrated nitric acid—and the mixture must be refluxed at around 100°C .

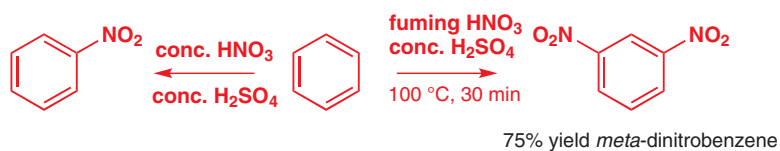

The second nitro group is introduced *meta* to the first: evidently the nitro group is deactivating and *meta*-directing.

The nitro group is conjugated with the π system of the benzene ring and is strongly electron withdrawing—and it withdraws electrons specifically from the *ortho* and *para* positions. We can use curly arrows to show this:

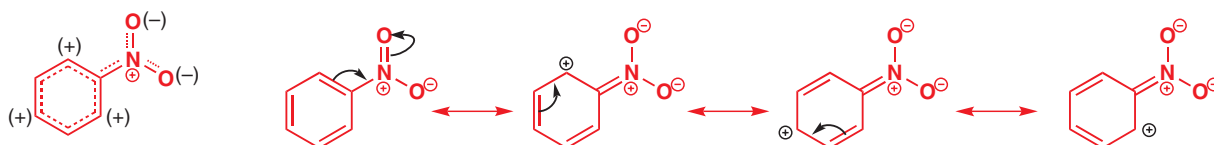

The nitro group withdraws electron density from the π system of the ring thereby making the ring less reactive towards an electrophile. Since more electron density is removed from the *ortho* and *para* positions, the least electron-deficient position is the *meta* position. Hence the nitro group is *meta* directing. In the nitration of benzene, it is much harder to nitrate a second time and, if we insist, the second nitro group goes in *meta* to the first.

Other reactions go the same way: bromination of nitrobenzene gives *meta*-bromonitrobenzene in good yield. The combination of bromine and iron powder provides the necessary Lewis acid catalyst (FeBr_3) while the high temperature needed for this unfavourable reaction is easily achieved as the boiling point of nitrobenzene is over 200 °C.

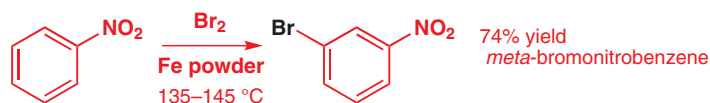

In drawing the mechanism it is best to draw the intermediate and to emphasize that the positive charge must not be delocalized to the carbon atom bearing the nitro group.

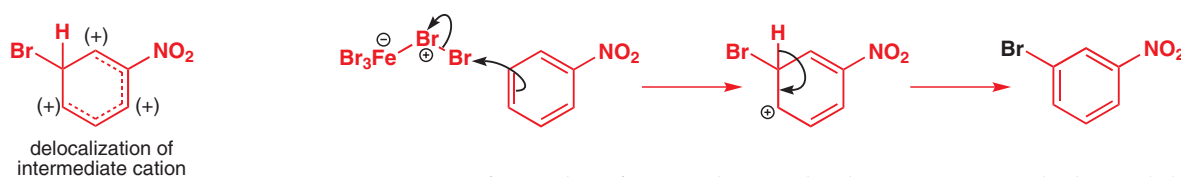

Nitro is just one of a number of groups that are also deactivating towards electrophiles and *meta* directing because of electron withdrawal by conjugation. Others include carbonyl groups (aldehydes, ketones, esters, etc.), nitriles, and sulfonates. The ^1H NMR shifts of rings carrying these substituents confirm that they remove electrons principally from the *ortho* and *para* positions.

^1H NMR chemical shifts

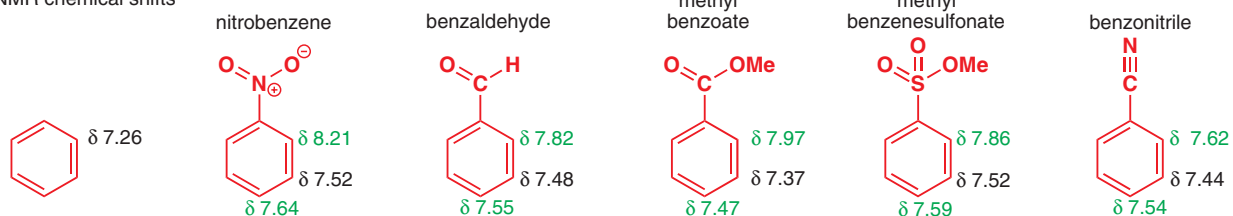

Points to note:

- Each of the compounds contains the unit Ph–X=Y, where Y is an electronegative element, usually oxygen.
- In each compound, *all* the protons have larger chemical shifts than benzene because the electron density at carbon is less.
- The protons in the *meta* position have the smallest shift and so the greatest electron density.

Nitro is the most electron-withdrawing of these groups and some of the other compounds are nearly as reactive (in the *meta* position, of course) as benzene itself. It is easy, for example, to nitrate methyl benzoate and the *m*-nitro ester can then be hydrolysed to *meta*-nitrobenzoic acid very easily.

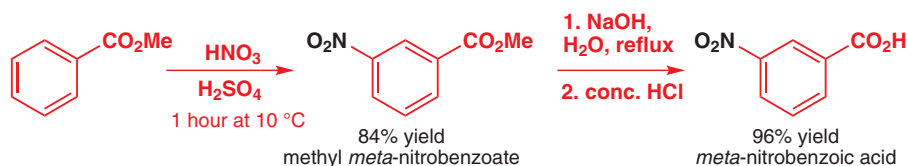

• Electron-withdrawing groups make aromatic rings more reluctant to undergo electrophilic substitution, but when they do react, they react in the *meta* position.

One group of substituents remains and they are slightly odd. They are *ortho*, *para*-directing but they are also *deactivating*. They are the halogens.

Halogens show evidence of both electron withdrawal and donation

So far we have steered clear of the reactions of halogenated derivatives of benzene. Before we explain their reactions, have a look at the table, which shows the rates of nitration of fluoro, chloro, bromo, and iodobenzene relative to benzene itself, and also gives an indication of the products formed in each case.

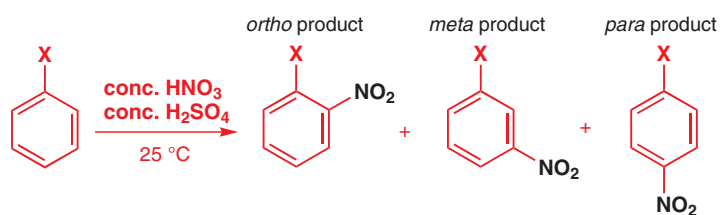

Compound	Products formed (%)			Nitration rate (relative to benzene)
	<i>ortho</i>	<i>meta</i>	<i>para</i>	
PhF	13	0.6	86	0.18
PhCl	35	0.9	64	0.064
PhBr	43	0.9	56	0.060
PhI	45	1.3	54	0.12

We'll come back to this table a few times in the next page or so, but the first thing to note is that **all the halobenzenes react more slowly than benzene itself**. Evidently, electron withdrawal by the electronegative halogen deactivates the ring towards attack. But the second thing that should strike you is that, unlike the deactivating groups we have just been discussing, **halogens are *ortho*, *para* directing**—very few *meta*-nitrated products are formed.

The only way this makes sense is if there are two opposing effects: electron donation by conjugation and electron withdrawal by induction. The halogen has three lone pairs, one of which may conjugate with the ring just like in phenol or aniline. Yet the conjugation is much less good than in phenol or aniline, for one of two reasons. When Cl, Br, or I is the substituent, the problem is size: the 2p orbitals from the carbon atoms overlap poorly with the bigger p orbitals from the halogen (3p for chlorine, 4p for bromine, and 5p for iodine). This size mismatch is clearly illustrated by comparing the reactivities of aniline and chlorobenzene:

chlorine and nitrogen have approximately the same electronegativity, but aniline is much more reactive than chlorobenzene because of the better overlap between the carbon and nitrogen 2p orbitals. Fluorine 2p orbitals are the right size to overlap well with the carbon 2p orbitals, but now there is another problem: the orbitals of fluorine are much lower in energy than the orbitals of carbon since fluorine is so electronegative.

So, all four halogens are less good at donating electrons to the ring than an OH or NH₂ group, but not only are the halobenzenes less reactive than phenol or aniline, they are even less reactive than benzene itself. Now, when we looked at aniline and phenol, we didn't worry about any electron withdrawal by induction, even though both oxygen and nitrogen are of course rather electronegative. Electron donation from their N and O lone pairs is evidently much more important. But with the conjugation in the halobenzenes already weak, inductive electron withdrawal takes over as the dominant factor in determining reactivity.

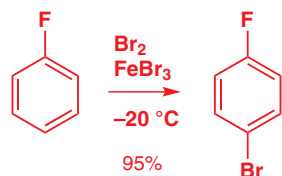

With all this in mind, how would you expect fluorobenzene to react? Most electron density is removed first from the *ortho* positions by induction, then from the *meta* positions, and then from the *para* position. Any conjugation of the lone pairs on fluorine with the π system would increase the electron density in the *ortho* and *para* positions. Both effects favour the *para* position and this is where most substitution occurs. But is the ring more or less reactive than benzene? This is hard to say and the honest answer is that sometimes fluorobenzene is more reactive in the *para* position than benzene (for example, in proton exchange and in acetylation—see later) and sometimes it is less reactive than benzene (for example, in nitration, as shown by the table above). In all cases, fluorobenzene is significantly more reactive than the other halobenzenes. We appreciate that this is a rather surprising conclusion, but the evidence supports it. For example, fluorobenzene reacts with bromine and an iron catalyst (it does need a catalyst: it is not as reactive as phenol) at only $-20\text{ }^\circ\text{C}$ to give the *para*-bromo derivative.

Let's now look back in bit more detail at the table above. We can now also explain two other features of the results:

► We mentioned inductive effects as a factor controlling *ortho* vs *para* reactivity on p. 483.

- The percentage of the *ortho* product increases from fluorobenzene to iodobenzene. We might have expected the amount to decrease as the size of the halide increases because of increased steric hindrance at the *ortho* position but this is clearly not the case. Instead the greater inductive effect of the more electronegative atoms (F, Cl) withdraws electron density mostly from the *ortho* positions, lessening their reactivity.
- The rates of the reactions fall into two pairs and follow a 'U-shaped' sequence: fluorobenzene nitrates most quickly, followed closely by iodobenzene; chloro-, and bromobenzene nitrate at around half these rates. Chlorine and bromine suffer because both are quite electronegative and neither has good lone pair overlap: in fluorine, overlap is good; in iodine, electronegativity is much less.

In practical terms, it is usually possible to get high yields of *para* products from electrophilic substitution reactions of halobenzenes. Both nitration and sulfonation of bromobenzene give enough material to make the synthesis worthwhile. Although mixtures of products are always bad in a synthesis, electrophilic aromatic substitution is usually simple to carry out on a large enough scale to make separation of the major product, ideally by crystallization, a workable method. A 68% yield of sodium *p*-bromobenzenesulfonate can be achieved by recrystallization of the sodium salt from water and a 70% yield of *p*-bromonitrobenzene by separation from the *ortho* isomer by recrystallization from EtOH.

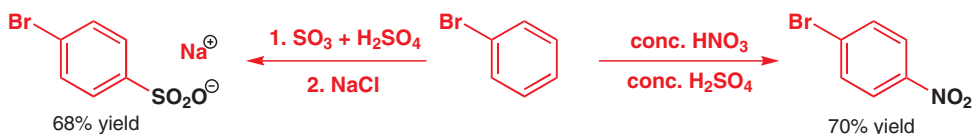

Summary of directing and activating effects

Now we can summarize the stage we have reached in terms of *activation* and *direction*.

Electronic effect	Example	Activation	Direction
donation by conjugation	$-\text{NR}_2, -\text{OR}$	very activating	<i>ortho, para</i> only
donation by inductive effect	alkyl	activating	mostly <i>ortho, para</i> but some <i>meta</i>
donation by conjugation and withdrawal by inductive effect	F, Cl, Br, I	deactivating	<i>ortho</i> and (mostly) <i>para</i>
withdrawal by inductive effect	$-\text{CF}_3, -\text{NR}_2^+$	deactivating	<i>meta</i> only
withdrawal by conjugation	$-\text{NO}_2, -\text{CN}, -\text{COR}, -\text{SO}_2\text{R}$	very deactivating	<i>meta</i> only

Two or more substituents may cooperate or compete

The directing effects of two or more substituents can work with or against one another. Bromoxynil and ioxynil are contact herbicides especially used in spring cereals to control weeds resistant to other weedkillers, and both are synthesized from *p*-hydroxybenzaldehyde by double halogenation. The aldehyde directs *meta* and the OH group directs *ortho*: both effects work together to promote bromination or iodination at the same two positions.

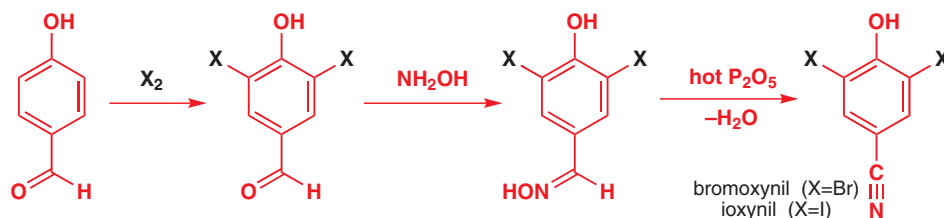

The reaction with NH_2OH is the formation of an oxime from the aldehyde and hydroxylamine and was dealt with in Chapter 11. The reaction with P_2O_5 is a dehydration—phosphorus is used to form the nitrile by removing water from the oxime.

In other cases substituents compete by directing to different positions. The antioxidant BHT (p. 58) is made from 4-methylphenol (known as *p*-cresol) by a Friedel–Crafts alkylation. Usually, both the methyl and OH groups are *ortho, para* directors. The *para* positions are obviously both blocked, but the positions *ortho* to each of the groups are different. Since the $-\text{OH}$ group is much more powerfully directing than the methyl group it ‘wins’ and directs the electrophile (a *t*-butyl cation) *ortho* to itself.

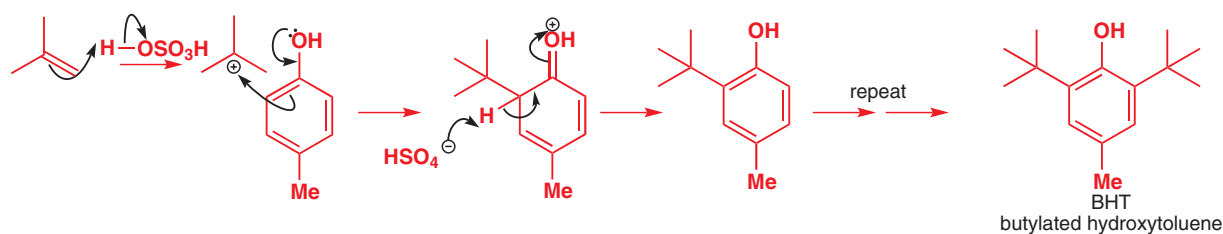

In this case the *t*-butyl cation is made from the alkene and protic acid; alternative reagents would be *t*-butanol with protic acid or *t*-butyl chloride with AlCl_3 .

Even a ‘watered-down’ activating group like the amide $-\text{NHCOMe}$, which provides an extra pair of electrons, will ‘win’ over a deactivating group or an activating alkyl group. Bromination of this amide goes *ortho* to the $-\text{NHCOMe}$ group but *meta* to the methyl group.

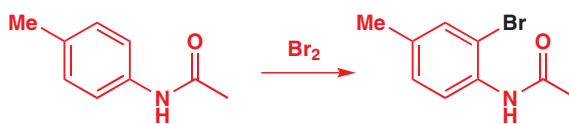

When looking at any compound where competition is an issue it is sensible to consider electronic effects first and then steric effects. For electronic effects, in general, any activating effects are more important than deactivating ones. For example, the aldehyde below has three groups—two methoxy groups that direct *ortho* and *para* and an aldehyde that directs *meta*.

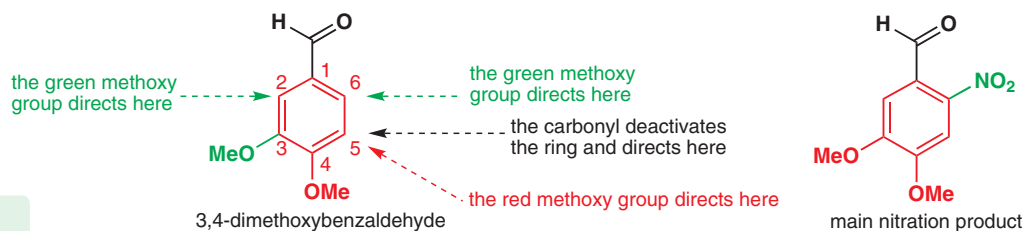

■ If you are in a bar and someone picks a fight with you, it is no help that an inoffensive little man in the corner would prefer not to pick a fight. Aggressive $-\text{NR}_2$ and $-\text{OR}$ groups are not much affected by inoffensive $-\text{Br}$ or carbonyl groups in another corner of the molecule.

Despite the fact that the aldehyde group withdraws electron density from positions 2 and 6, C6 is still the position for nitration. The activating methoxy groups dominate electronically and the choice is really between C2, C5, and C6. Now consider steric factors: reaction at C2 or C5 would lead to three adjacent substituents. Substitution occurs at position 6.

Some problems and some opportunities

You've seen plenty of electrophilic aromatic substitution reactions in this chapter that are reliable and widely used—bromination and nitration, for example. But others pose problems:

- Friedel–Crafts alkylation works only when the intermediate cation is stable, so how do we add an *n*-alkyl chain to an aromatic ring?
- There is no good way of introducing an oxygen electrophile to an aromatic ring, so how do we make $\text{Ar}-\text{O}$ bonds?
- Electron-donating groups always direct *ortho*, *para*, so how do we put in a group *meta* to, for example, an amino group?

We will consider some answers to these questions in this last section of this chapter.

A closer look at Friedel–Crafts chemistry

Reactions such as nitration and sulfonation add a very deactivating substituent. They usually stop cleanly after a single substitution unless there is also a strongly activating substituent. Even then it may be possible to stop after a single substitution. Weakly electron-withdrawing substituents like the halogens can be added once, but multiple substitution is common when the starting arene carries strongly activating substituents like OH and NH_2 .

Two reasons to avoid a Friedel–Crafts alkylation

When electron-donating substituents are added, multiple substitution is always a threat. The principal reaction where multiple substitution is a genuine problem is the Friedel–Crafts alkylation reaction. Here's an example: preparation of diphenylmethane from benzene and benzyl chloride is a useful reaction but the product has two benzene rings, each more reactive than benzene itself. A 50% yield is the best we can do and that requires a large excess of benzene to ensure that it competes successfully for the reagent with the reactive, electron-rich product.

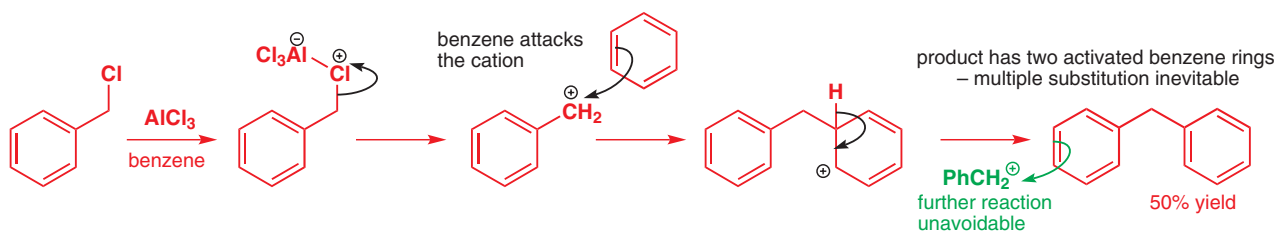

Multiple substitution is just one of the potential pitfalls of Friedel–Crafts alkylations. The other is important to be aware of too: **Friedel–Crafts alkylations work well only with stable cations**. This is what happens when we try a Friedel–Crafts reaction with *n*-propyl chloride.

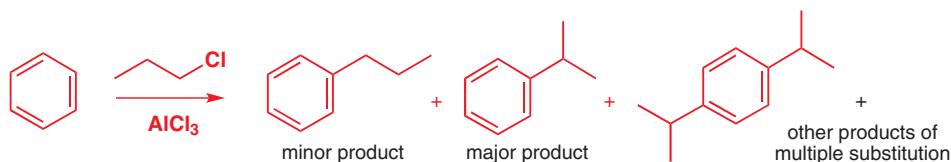

Recall from Chapter 15 that primary halides don't form cations easily, so the Friedel–Crafts reaction with *n*-propyl chloride has to go via an S_N2 mechanism.

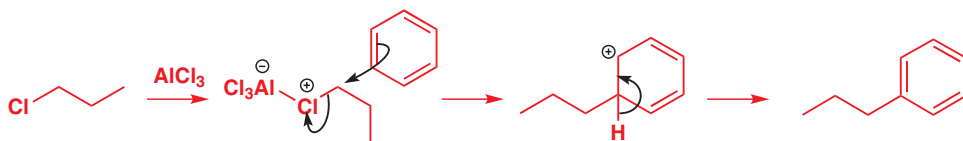

So where does the major product of the reaction come from? The three carbons are arranged not as an *n*-propyl group but as an *iso*-propyl group: a *rearrangement* has occurred. This is the mechanism:

rearrangement (migration of green H) leads to isopropyl benzene

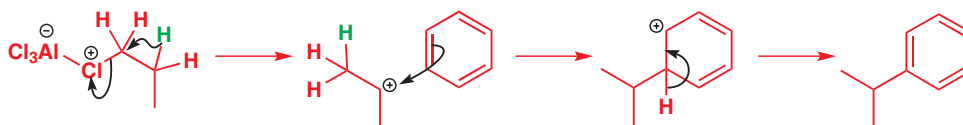

The green hydrogen migrates to allow a secondary rather than a primary alkyl cation to be formed, and *iso*-propylbenzene results. This leaves us with a problem: how can you add primary alkyl groups to benzene rings?

The solution: use Friedel–Crafts acylation instead

We can kill two birds with one stone here: both problems common to the Friedel–Crafts alkylation are solved when the acylation is used instead. Firstly, the product of the acylation is a ketone: the reaction introduces a deactivating, electron-withdrawing, conjugating carbonyl group to the ring, so the product is *less* reactive than the starting material. Reaction will stop cleanly after one acylation. Here's benzene reacting with propionyl chloride.

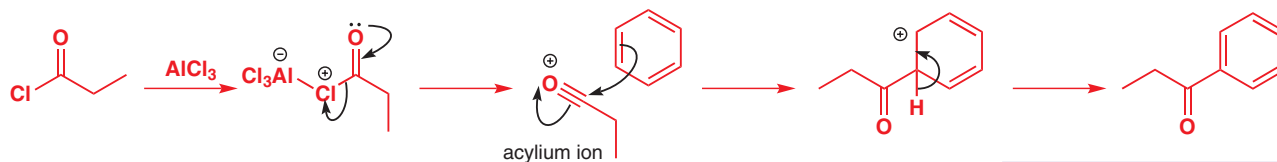

If we want the ketone then all well and good. But a simple reduction also allows us to get the alkylated product—this compound (trivially called propiophenone) is reduced to

➔ We'll deal with rearrangements in much greater detail in Chapter 36.

➔ We introduced the Friedel–Crafts acylation on p. 477.

🖱 Interactive mechanism for Friedel–Crafts acylation

You may also meet the trivial names acetophenone and benzophenone.

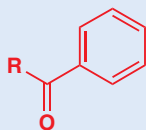

R = Me: acetophenone
R = Ph: benzophenone

➔ More reductions like this—which get rid of the carbonyl group completely—are discussed in Chapter 23.

propylbenzene using any of a number of reduction methods, for example zinc amalgam in hydrochloric acid.

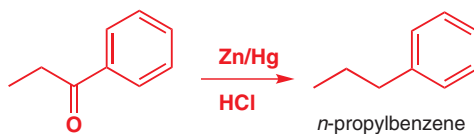

The reduction of a Friedel–Crafts acylation product like this always gives an *n*-alkylbenzene, exactly the sort of compound that causes the problems in Friedel–Crafts alkylation. Friedel–Crafts acylations also work well when anhydrides are used in the place of acid chlorides. The acylium ion is formed in the same way:

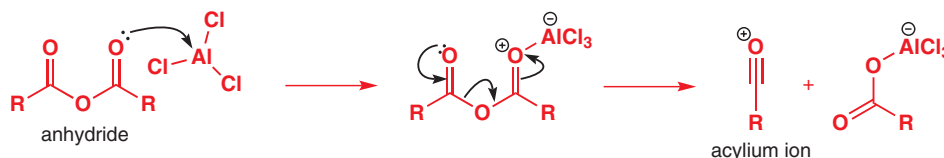

If a cyclic anhydride is used, the product is a keto-acid.



Reduction of the ketone can give a simpler carboxylic acid, but we can go one step further and do another acylation—because the reaction is intramolecular, it goes even with just a strong acid (phosphoric acid): the strong acid makes the OH into a good leaving group (water) and the acylium ion is again an intermediate.

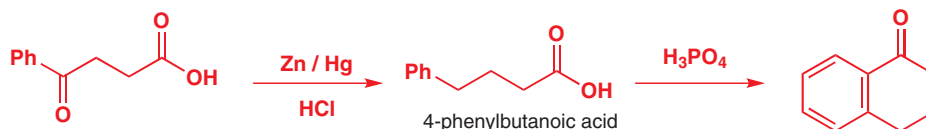

■ Notice how much AlCl_3 is needed: in Friedel–Crafts alkylations using an alkyl chloride, the Lewis acid is used in catalytic quantities. In an acylation, however, the Lewis acid can also complex to any oxygen atoms present, to the carbonyl in the product, for example. As a result, in acylation reactions more Lewis acid is required—just over one equivalent per carbonyl group.

■ Make sure you can see how this reaction works.

● The advantages of acylation over alkylation

Two problems in Friedel–Crafts alkylation do not arise with acylation.

- The acyl group in the product withdraws electrons from the π system, making multiple substitutions harder. Indeed, if the ring is too deactivated to start off with, Friedel–Crafts acylation may not be possible at all—nitrobenzene is inert to Friedel–Crafts acylation and is often used as a solvent for these reactions.
- Rearrangements are also no longer a problem because the electrophile, the acylium cation, is already relatively stable.
- The acyl groups of the products can be reduced to primary alkyl groups, which are impossible to introduce cleanly by Friedel–Crafts alkylation.

Exploiting the chemistry of the nitro group

The nitro group is remarkably useful in a number of ways:

- It is easy to introduce by nitration chemistry (p. 476).
- Unlike most N- or O-based functional groups, it is a *meta* director (p. 488).
- It can be reduced to an amino group.
- It can be replaced with other substituents using diazonium chemistry.

You have met the first two of these features, but the last two may be new to you. An aromatic nitro group is easy to turn into an amino group—a number of reagents will do this, but the most common are tin in dilute HCl or hydrogenation with a palladium catalyst supported on charcoal (written as Pd/C).

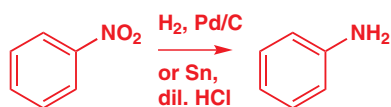

➔ There is more on these selective reducing agents in Chapter 23.

This simple transformation is extremely important because it turns the *meta*-directing nitro group into an *ortho*, *para*-directing amino group (although as you saw on p. 483, the amino group may need ‘taming’ to make its reactivity useful). The sequence of nitration–reduction allows us to introduce a useful NH₂⁺ equivalent into an aromatic molecule, and can let us make otherwise difficult-to-form *meta*-substituted amino compounds.

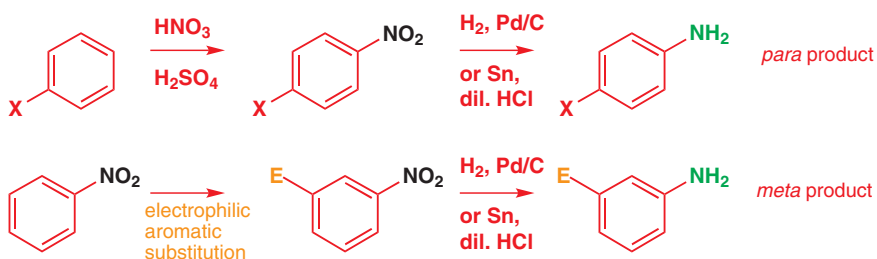

The reduction to an amino group also opens up the possibility of replacing the nitrogen substituent completely, by converting it first to a diazonium group. Treatment of an amine with nitrous acid converts it to an unstable diazonium salt, whose mechanism of formation and chemistry we will discuss in the next chapter. Not surprisingly, diazonium salts very readily lose nitrogen gas, and this substitution of N₂ by a nucleophile opens yet more opportunities to compounds derived from nitrobenzene derivatives. It also involves *nucleophilic* substitution at the aromatic ring, which forms the subject of the next chapter.

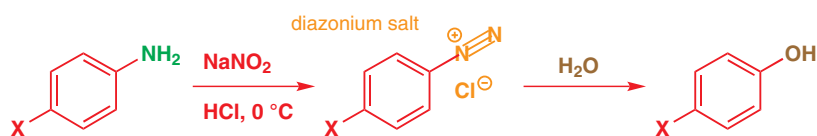





➔ Diazonium salts are discussed on p. 520. Chapter 40 introduces the idea of using transition metals in the formation of bonds to aromatic rings, while Chapter 24 revisits the methods available when control of regiochemistry (i.e. *ortho*, *meta*, or *para* selectivity) is needed.

Summary

● Products from electrophilic substitution reactions

Product	Reaction	Reagents	Page
	bromination	Br ₂ and Lewis acid, e.g. AlCl ₃ , FeBr ₃ , Fe powder	474
	nitration	HNO ₃ + H ₂ SO ₄	476
	reduction of nitro compounds	From ArNO ₂ : Sn, HCl or H ₂ , Pd/C	495

(continued) Products from electrophilic substitution reactions

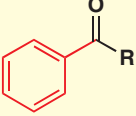
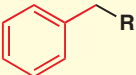
Product	Reaction	Reagents	Page
 X = OH, CN, Br, I...	substitution of diazonium salts	From ArNH ₂ : 1. NaNO ₂ , HCl; 2. X ⁻	See Chapter 22, p. 520
	sulfonation	concentrated H ₂ SO ₄ or H ₂ SO ₄ + SO ₃ (oleum)	476
	chlorosulfonation	ClSO ₃ H	486
	Friedel–Crafts alkylation	RX + Lewis acid, usually AlCl ₃	477
	Friedel–Crafts acylation	RCOCl + Lewis acid, usually AlCl ₃	477
	Friedel–Crafts acylation and reduction	From ArCOR: Zn/Hg, HCl	493

● Reactions of aromatic compounds in this chapter

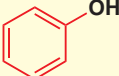
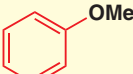
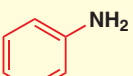
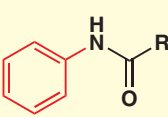
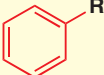
Starting material	Example	Activating/deactivating	Directing effect	Page
benzene, PhH		–	–	474
phenol, PhOH		activating	<i>ortho, para</i>	479
anisole, PhOMe		activating	<i>ortho, para</i>	480
aniline, PhNH ₂		activating	<i>ortho, para</i>	482
ArNHCOR (anilides)		activating	<i>ortho, para</i>	483
toluene and alkylbenzenes, PhR		activating	<i>ortho, para</i>	484

(continued) Reactions of aromatic compounds in this chapter

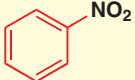
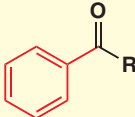
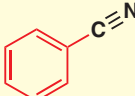
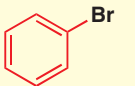
Starting material	Example	Activating/deactivating	Directing effect	Page
nitrobenzene, PhNO ₂		deactivating	<i>meta</i>	488*
acylbenzenes, PhCOR (acetophenone, benzophenone)		deactivating	<i>meta</i>	489
benzonitrile, PhCN		deactivating	<i>meta</i>	488
halobenzenes, PhX		deactivating	<i>ortho, para</i>	489

*For methods of converting nitro substituents to other groups by reduction, diazotization and substitution, see pp. 520 and 567, and Chapters 22 and 24.

Further reading

Every big organic chemistry text has a chapter on this topic. One of the best is: F. A. Carey and R. J. Sundberg, *Advanced Organic Chemistry A, Structure and Mechanisms*, 5th edn, Springer, 2007, chapter 9 and B, *Reactions and Synthesis*, chapter 11. B. S. Furniss,

A. J. Hannaford, P. W. G. Smith, and A. T. Tatchell, *Vogel's Textbook of Practical Organic Chemistry*, Longman, 5th edn, 1989, sections 6.1–6.4 and 6.10–6.13 gives many practical examples of the reactions in this chapter.

Check your understanding



To check that you have mastered the concepts presented in this chapter, attempt the problems that are available in the book's Online Resource Centre at <http://www.oxfordtextbooks.co.uk/orc/clayden2e/>

22

Conjugate addition and nucleophilic aromatic substitution

Connections

➔ Building on

- Nucleophilic substitution at C=O **ch10** and at saturated C **ch15**
- Electrophilic additions to alkenes **ch19**
- Electrophilic substitution on aromatic rings **ch21**

Arriving at

- Conjugate addition: conjugation of alkenes with electron-withdrawing groups makes them electrophilic and allows nucleophilic attack
- Conjugate substitution: electrophilic alkenes bearing leaving groups can promote substitution reactions at C=C related to those at C=O
- Nucleophilic aromatic substitution: electron-poor aromatic rings that allow substitution reactions with nucleophiles rather than the usual electrophiles
- Special leaving groups and nucleophiles that allow nucleophilic aromatic substitution on electron-rich rings

➔ Looking forward to

- Regioselectivity **ch24**
- Conjugate addition of enolates **ch26**
- Reactions of heterocyclic aromatic compounds **ch29 & ch30**

This chapter is also the last chapter in the second cycle of chapters within this book, with which we complete our survey of the important elementary types of organic reactions. We follow it with two review chapters, where we bring together aspects of *selectivity*, before looking in more detail at enolate chemistry and how to make molecules.

Alkenes conjugated with carbonyl groups

To start this chapter, let us take you back to one of the first reactions we introduced: nucleophilic addition to carbonyl groups. Here are two examples, both of which give products which you should fully expect. We've included details of the IR spectra of the products to confirm firstly that the product has no carbonyl group and secondly that the alkene is still there.

■ If you need to review IR spectroscopy, turn back to Chapter 3. Any C=O peak would appear near 1700 cm⁻¹, but there isn't one. Instead there's an O-H peak at 3600 cm⁻¹. The 2250 cm⁻¹ peak is C≡N; C=C is at 1650 cm⁻¹.

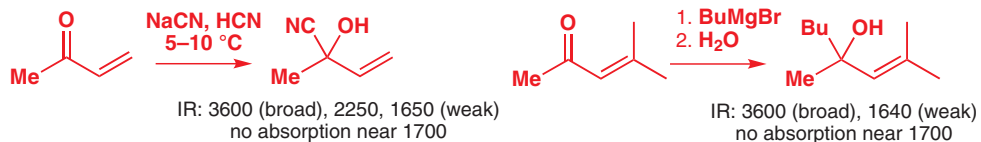

Now let's tweak the conditions: we repeat the first reaction at a higher temperature, and we add to the second a small amount of a copper salt. Now the products are different:

Online support. The icon  in the margin indicates that accompanying interactive resources are provided online to help your understanding: just type www.chemtube3d.com/clayden/123 into your browser, replacing **123** with the number of the page where you see the icon. For pages linking to more than one resource, type **123-1, 123-2** etc. (replacing **123** with the page number) for access to successive links.



Both products A and B have kept their carbonyl group (IR peak at 1710–1715 cm^{-1}) but have lost the C=C. Yet A, at least, is unquestionably an addition product because it contains a C≡N peak at 2250 cm^{-1} .

Well, the identities of A and B are revealed here: they are the products of addition, not to the carbonyl group, but to the C=C bond. Here's a mechanism, for both reactions of cyanide: firstly the direct addition to C=O and secondly addition to the C=C bond.

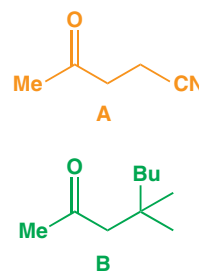
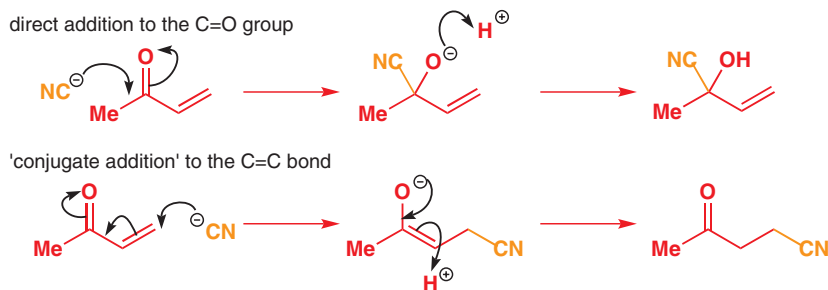

Interactive mechanism for conjugate addition of cyanide

This type of reaction, where a nucleophile adds to a C=C double bond, is called **conjugate addition**, and this chapter is about the sorts of alkenes (and arenes) that do this kind of thing. We will also explain how such small differences in reaction conditions (temperature, or the presence of CuCl) manage to change the outcome so dramatically.

But first we need to place these conjugate additions into context. As you found out in Chapter 19, **alkenes are nucleophilic**. Almost regardless of their substituents, they react with electrophiles such as bromine to form adducts in which the π bond of the alkene has been replaced by two σ bonds.

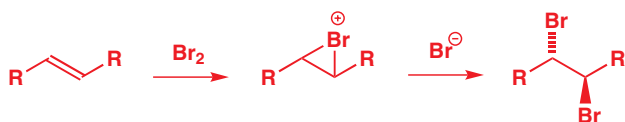

Reactions like this were discussed in Chapter 19.

Even when the alkene is conjugated with an electron-withdrawing group, as the alkenes on the last page were, bromine addition still occurs, although less readily. Never lose sight of this: alkenes are nucleophilic.

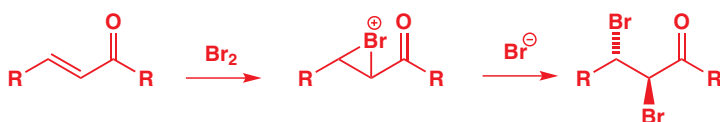

But as we have just seen, this last type of alkene also reacts with nucleophiles (such as cyanide, Grignard reagents, and, as you see below, more besides), and we now need to consider why.

Conjugated alkenes can be electrophilic

Conjugate additions occur only when the C=C double bond is immediately adjacent to the C=O group. They don't occur to C=C bonds that aren't conjugated (see the box on p. 501 for an illustration of this).

Compounds with double bonds adjacent to a C=O group are known as α,β -unsaturated carbonyl compounds. Many α,β -unsaturated carbonyl compounds have trivial names, and some are shown here. Some *classes* of α,β -unsaturated carbonyl compounds also have names such as 'enone', made up of 'ene' (for the double bond) + 'one' (for ketone).

The α and β refer to the distance of the double bond from the $C=O$ group: the α carbon is the one next to $C=O$ (not the carbonyl carbon itself), the β carbon is one further down the chain, and so on.

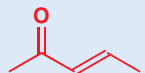
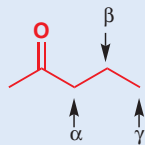
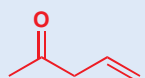
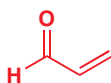
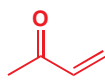
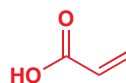
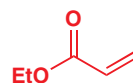
 α,β -unsaturated ketone β,γ -unsaturated ketone α,β -unsaturated aldehyde (an enal)propenal
(trivial name = acrolein) α,β -unsaturated ketone (an enone)but-3-en-2-one
(trivial name = methyl vinyl ketone) α,β -unsaturated acidpropenoic acid
(trivial name = acrylic acid) α,β -unsaturated esterethyl propenoate
(trivial name = ethyl acrylate)

Most types of nucleophiles can be made to undergo conjugate additions with α,β -unsaturated carbonyl compounds, and seven examples are shown below. Note that many of these nucleophiles would not add to a simple carbonyl group: we will explain why shortly. Conjugate addition is also known as Michael addition, and the reactive α,β -unsaturated carbonyl compounds shown here are often known as Michael acceptors.

Nucleophile:

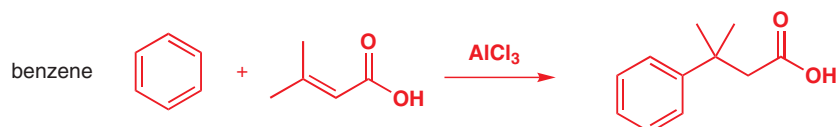
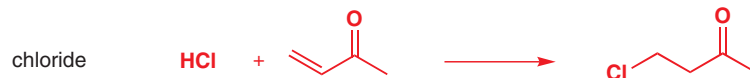
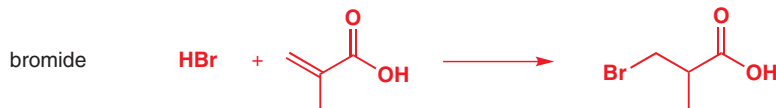
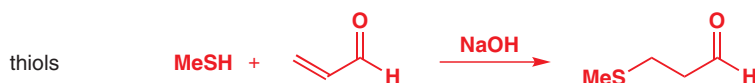
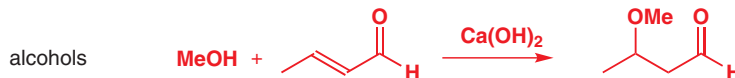
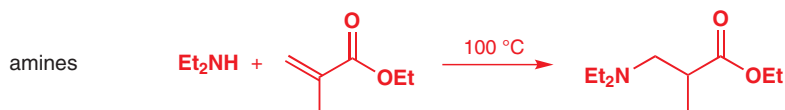
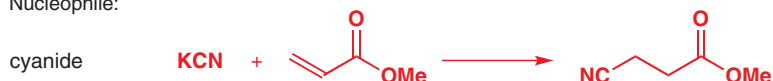

The reason that α,β -unsaturated carbonyl compounds react differently is conjugation, the phenomenon we discussed in Chapter 7. There we introduced you to the idea that bringing two π systems (two $C=C$ bonds, for example, or a $C=C$ bond and a $C=O$ bond) close together leads to a stabilizing interaction. It also leads to modified reactivity, because the π bonds no longer react as independent functional groups but as a single, conjugated system.

• Conjugation makes alkenes electrophilic

- $C=C$ double bonds are nucleophilic
- $C=C$ double bonds conjugated with carbonyl groups can be electrophilic

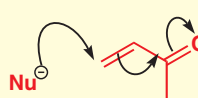
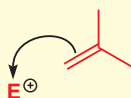

Termite self-defence and the reactivity of alkenes

Soldier termites of the species *Schedorhinotermes lamanianus* defend their nests with secretions of the enone shown below (compound 1), which is very effective at taking part in conjugate addition reactions with thiols (RSH). This makes it highly toxic, since many important biochemicals carry SH groups (one is described on p. 508). The worker termites of the same species—who build the nests—need to be able to avoid being caught in the crossfire, so they are equipped with an enzyme that allows them to reduce compound 1 to compound 2. This still has a double bond, but the double bond is completely unreactive towards nucleophiles because it is not conjugated with a carbonyl group. The workers escape unharmed.

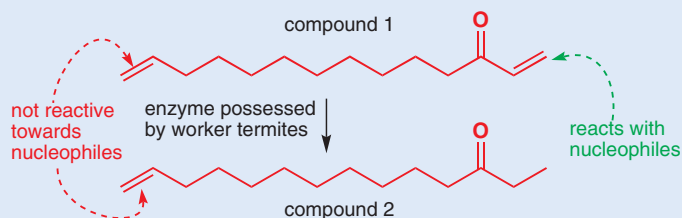

Alkenes conjugated with carbonyl groups become polarized

To show why alkenes conjugated with carbonyl groups behave differently from unconjugated alkenes, we use curly arrows to indicate delocalization of the π electrons over the four atoms in the conjugated system. Both representations are extremes, and the true structure lies somewhere in between, but the polarized structure indicates why the conjugated C=C bond is electrophilic and why the β carbon is attacked by nucleophiles.

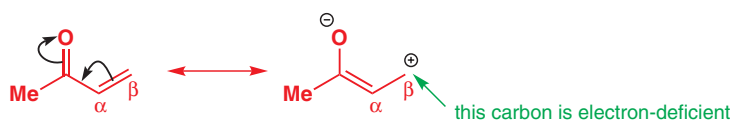

Polarization is detectable spectroscopically

IR spectroscopy provides us with evidence for polarization in C=C bonds conjugated to C=O bonds. An unconjugated ketone C=O absorbs at 1715 cm^{-1} while an unconjugated alkene C=C absorbs (usually rather weakly) at about 1650 cm^{-1} . Bringing these two groups into conjugation in an α,β -unsaturated carbonyl compound leads to two peaks at 1675 and 1615 cm^{-1} , respectively, both quite intense. The lowering of the frequency of both peaks is consistent with a weakening of both π bonds (notice that the polarized structure has only single bonds where the C=O and C=C double bonds were). The increase in the intensity of the C=C absorption is consistent with polarization brought about by conjugation with C=O: a conjugated C=C bond has a significantly larger dipole moment than its unconjugated cousins.

The polarization of the C=C bond is also evident in the ^{13}C NMR spectrum, with the signal for the sp^2 carbon atom furthest from the carbonyl group moving downfield relative to an unconjugated alkene to about 140 ppm, and the signal for the other double bond carbon atom staying at about 120 ppm.

Molecular orbitals control conjugate additions

We have spectroscopic evidence that a conjugated C=C bond is polarized, and we can explain this with curly arrows, but the actual bond-forming step must involve movement of electrons from the HOMO of the nucleophile to the LUMO of the unsaturated carbonyl compound. This example is an efficient (the reaction happens even at 0°C) addition to acrolein (propenal) with methoxide as the nucleophile.

You may be asking yourself why we can't show the delocalization by moving the electrons the other way, like this.

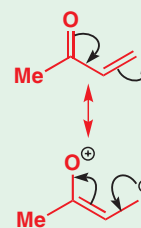

Think about electronegativities: O is much more electronegative than C, so it is quite happy to accept electrons, but here we have taken electrons away, leaving it with only six electrons. This structure therefore cannot represent the distribution of electrons in the conjugated system.

^{13}C NMR chemical shifts:

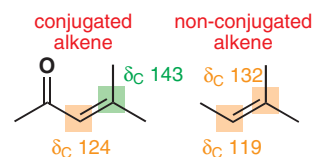

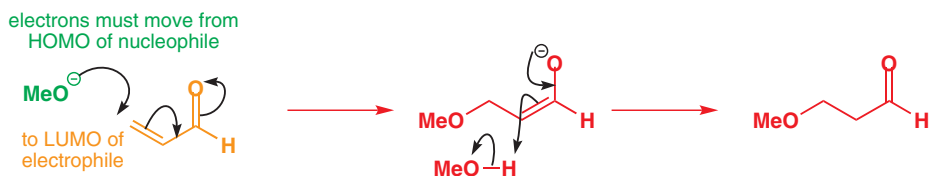

But what does this LUMO look like? It will certainly be more complicated than the π^* LUMO of a simple carbonyl group. The nearest thing you have met so far (in Chapter 7) are the orbitals of butadiene (C=C conjugated with C=C), which we can compare with the α,β -unsaturated aldehyde acrolein (C=C conjugated with C=O). The orbitals in the π systems of butadiene and acrolein are shown here. They are different because acrolein's orbitals are perturbed (distorted) by the oxygen atom (Chapter 4). You need not be concerned with exactly how the sizes of the orbitals are worked out, but for the moment just concentrate on the shape of the LUMO, the orbital that will accept electrons when a nucleophile attacks.

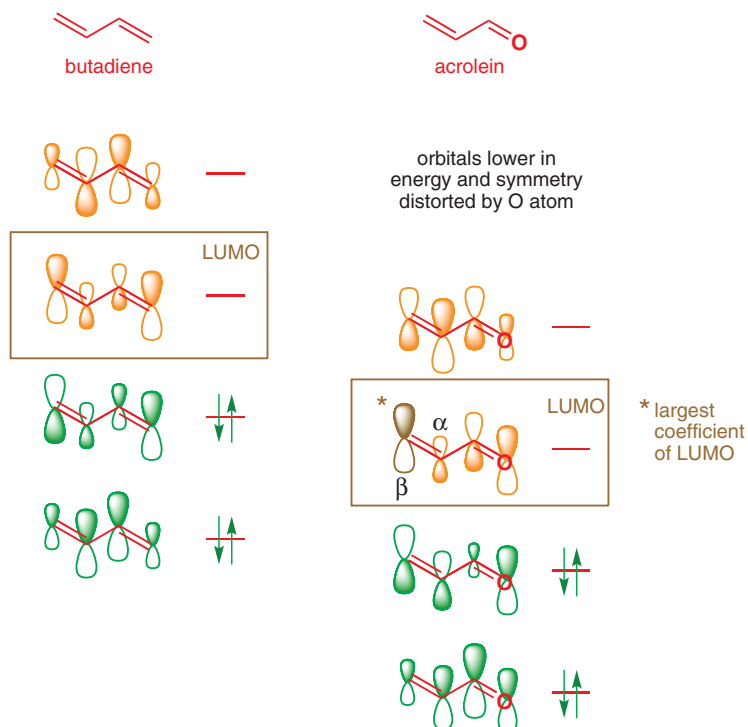

Interactive molecular orbitals in acrolein

In acrolein, the HOMO is in fact not the highest filled π orbital you see here, but the lone pairs on oxygen. This is not important, however, because here we are considering acrolein as an electrophile, so we are interested only in its LUMO.

In the LUMO, the largest coefficient is on the β carbon of the α,β -unsaturated system, shown with an asterisk. And it is here, therefore, that nucleophiles attack. In the reaction you have just seen, the HOMO is the methoxide oxygen's lone pair, so this will be the key orbital interaction that gives rise to the new bond.



The second largest coefficient is on the C=O carbon atom, so it's not surprising that some nucleophiles attack here as well—remember the example right at the beginning of the chapter where you saw cyanide attacking either the double bond or the carbonyl group depending on the conditions of the reaction. We shall next look at some conjugate additions with alcohols and amines as nucleophiles, before reconsidering the question of where the nucleophile attacks.

Conjugate additions have enolates or enols as intermediates

So much for the addition step of the reaction. But the product of this step is of course not the final product of the reaction—it is in fact an enolate. We hope you recognize these species from Chapter 20, where you saw them being made by treating carbonyl compounds with base. Conjugate addition is another way of generating an enolate, and as with all enolates, protonation gives back a carbonyl compound. The proton has to come from somewhere, so conjugate additions are usually done in protic solvents (such as alcohols or water). Here is another example with an alcohol as the nucleophile:

➔ Enols and enolates were introduced in Chapter 20.

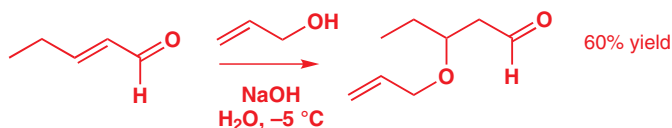

In alkaline solution, a small amount of alkoxide is produced (the pK_a of an alcohol is slightly higher than that of water), which attacks the C=C double bond in a conjugate addition. The product is an enolate, which is protonated by water to give the final aldehyde, and regenerates hydroxide as it does so: only a catalytic amount of base is required for this type of reaction.

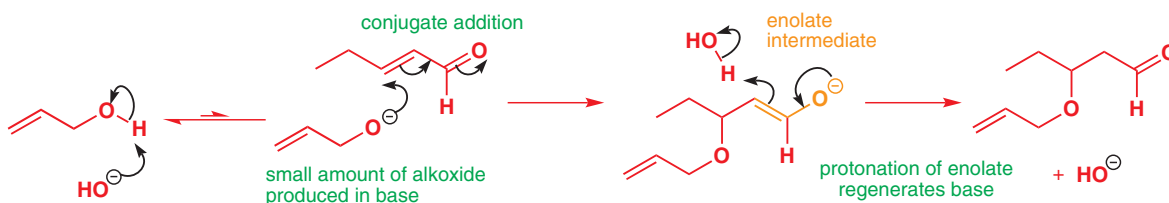

Amines are good nucleophiles for conjugate addition. In the reaction below, aqueous dimethylamine is used in a sealed system to stop the amine evaporating (dimethylamine is a gas even at room temperature).

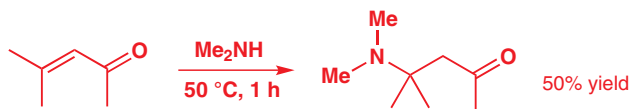

Amines are neutral nucleophiles, and the amine itself provides a proton for the enolate.

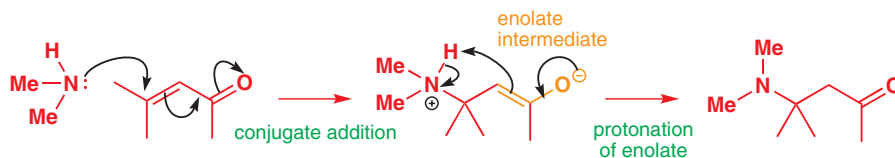

If you survey the initial overview of conjugate additions on p. 500 you will see that several take place under acidic conditions. Treatment of this α,β -unsaturated ketone with HCl, for example, gives a chloroketone. The first step must be protonation of the carbonyl group, which makes the enone even more electrophilic by giving it a positive charge. Chloride attacks the β carbon to give an *enol*.

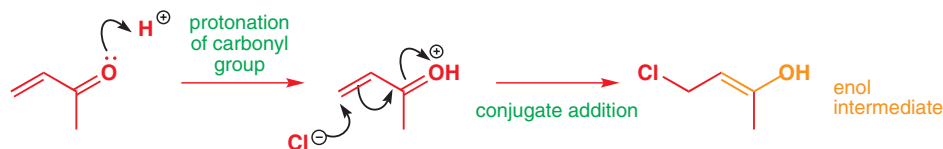

➔ Tautomerism is defined on p. 451.

All that remains to happen now is tautomerism of the enol to its keto form by proton transfer from O to C.



Conjugate addition or direct addition to the carbonyl group?

We have shown you several examples of conjugate additions using various nucleophiles and α,β -unsaturated carbonyl compounds, but we haven't yet addressed one important question. When do nucleophiles do conjugate addition (also called 1,4-addition) and when do they add directly to the carbonyl group (1,2-addition)? Several factors are involved—they are summarized here, and we will spend the next section of this chapter discussing them in turn.

- **Conjugate addition to C=C (also called 1,4-addition)**

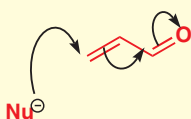

- **Direct addition to C=O (also called 1,2-addition)**

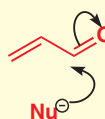

The way that nucleophiles react depends on:

- the conditions of the reaction
- the nature of the α,β -unsaturated carbonyl compound
- the type of nucleophile.

Reaction conditions

The very first conjugate addition reaction in this chapter depended on the conditions of the reaction. Treating an enone with cyanide and an acid catalyst at low temperature gives a cyanohydrin by direct attack at C=O, while heating the reaction mixture leads to conjugate addition. What is going on?

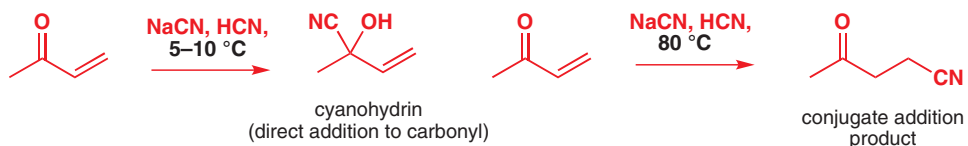

We'll consider the low-temperature reaction first. As you know from Chapter 6, it is quite normal for cyanide to react with a ketone under these conditions to form a cyanohydrin. You also know from Chapter 6 that cyanohydrin formation is reversible. Even if the equilibrium for cyanohydrin formation lies well over to the side of the products, there will always be a small amount of starting enone remaining. Most of the time, this enone will react to form more cyanohydrin and, as it does, some cyanohydrin will decompose back to enone plus cyanide—such is the nature of a dynamic equilibrium. But every now and then—at a much slower rate—the starting enone will undergo a *conjugate addition* with the cyanide.

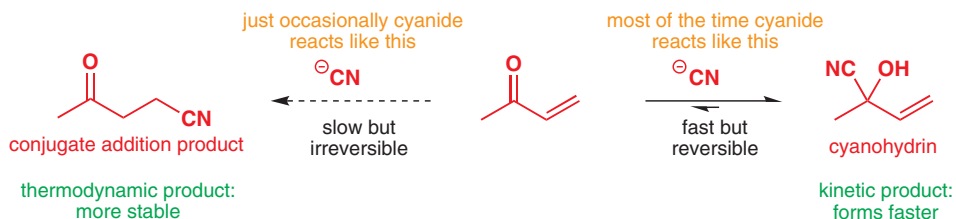

Now we have a different situation: conjugate addition is essentially an *irreversible* reaction, so once a molecule of enone has been converted to conjugate addition product, its fate is sealed: it cannot go back to enone again. Very slowly, therefore, the amount of conjugate addition product in the mixture will build up. In order for the enone–cyanohydrin equilibrium to be maintained, any enone that is converted to conjugate addition product will have to be replaced by reversion of cyanohydrin to enone plus cyanide. Even at room temperature, we can therefore expect the cyanohydrin to be converted bit by bit to conjugate addition product. This may take a very long time, but reaction rates are faster at higher temperatures, so at 80 °C this process does not take long at all and, after a few hours, the cyanohydrin has all been converted to conjugate addition product.

The contrast between the two products is this: the cyanohydrin is **formed faster** than the conjugate addition product, and is known as the product of kinetic control (or the kinetic product), but the conjugate addition product is the **more stable compound** and is the product of thermodynamic control (or the thermodynamic product). Typically, kinetic control involves lower temperatures and shorter reaction times, which ensures that only the fastest reaction has the chance to occur. And, typically, thermodynamic control involves higher temperatures and long reaction times to ensure that even the slower reactions have a chance to occur, and all the material is converted to the more stable compound.

● Kinetic and thermodynamic control

- The product that forms faster is called the **kinetic product**.
- The product that is the more stable is called the **thermodynamic product**.

Similarly,

- Conditions that give rise to the kinetic product are called **kinetic control**.
- Conditions that give rise to the thermodynamic product are called **thermodynamic control**.

Why is direct addition faster than conjugate addition? Well, although the carbon atom β to the C=O group carries some positive charge, the carbon atom of the carbonyl group carries more, and so electrostatic attraction for the charged nucleophiles will encourage it to attack the carbonyl group directly rather than undergo conjugate addition.

And why is the conjugate addition product the more stable? In the conjugate addition product, we gain a C–C σ bond, losing a C=C π bond, but keeping the C=O π bond. With direct addition, we still gain a C–C bond, but we lose the C=O π bond and keep the C=C π bond. C=O π bonds are stronger than C=C π bonds, so the conjugate addition product is more stable.

Practically, then, to get conjugate addition to occur you just have to give the reaction plenty of energy and maybe plenty of time to find its way to the most stable product. Here's an example: note the temperature!

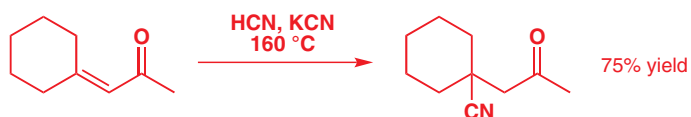

Structural factors

So far we have shown you conjugate additions mainly of α,β -unsaturated aldehydes and unsaturated α,β -ketones. You won't be at all surprised to learn, however, that unsaturated acids, esters, amides, and nitriles—in fact all carboxylic acid derivatives—can also take part in conjugate addition reactions. Two examples, an amide and an ester, are shown on the right below. But notice how the selectivity of these reactions depends on the structure of the unsaturated compound: compare the way butyllithium adds to this α,β -unsaturated aldehyde and α,β -unsaturated amide. Both additions are irreversible, and BuLi attacks the reactive carbonyl group of the aldehyde, but prefers conjugate addition to the less reactive amide. Similarly, ammonia reacts with this acyl chloride to give an amide product that derives from direct

➔ Kinetic and thermodynamic control were introduced in Chapter 12.

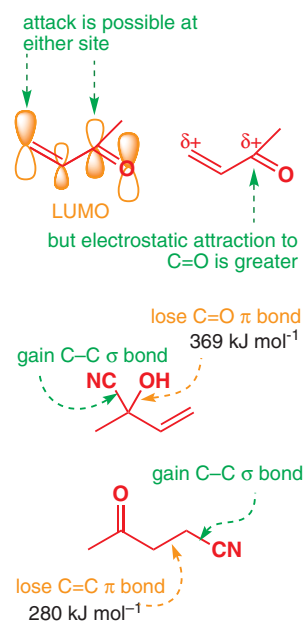

addition to the carbonyl group, while with the ester it undergoes conjugate addition to give an amine.

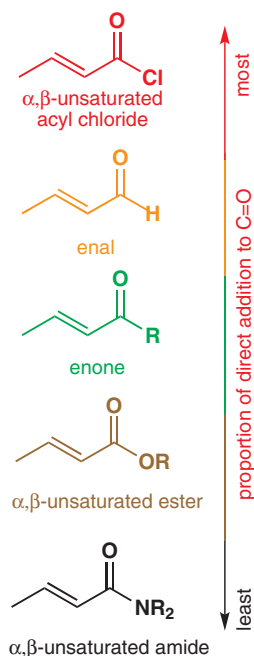
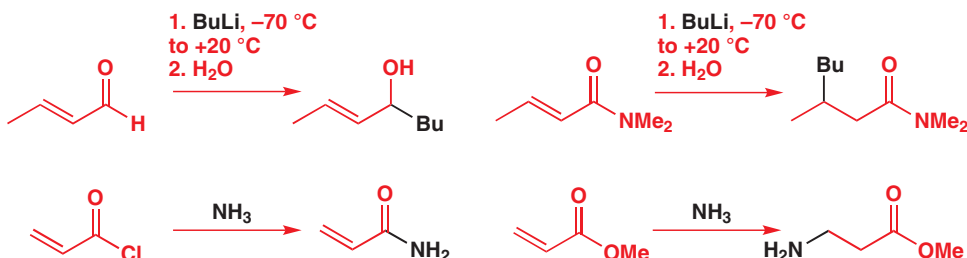

In both of these cases, the site of nucleophilic attack is determined simply by reactivity: the more reactive the carbonyl group, the more direct addition to C=O will result. The most reactive carbonyl groups, as you saw in Chapter 10, are those that are not conjugated with O or N (as they are in esters and amides), and particularly reactive are acyl chlorides and aldehydes. In general, the proportion of direct addition to the carbonyl group follows the reactivity sequence in the margin.

Sodium borohydride is a nucleophile that you have seen reducing simple aldehydes and ketones to alcohols, but it will also do conjugate addition reactions. Which of the alternatives actually takes place depends on the reactivity of the C=O group. NaBH₄ usually reacts with α,β -unsaturated aldehydes to give alcohols by direct addition to the carbonyl group.



Quite common with ketones, however, is the outcome below.

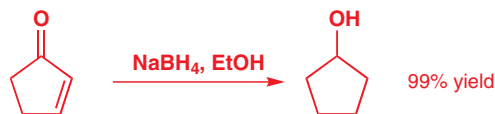

The borohydride has reduced not only the carbonyl group but the double bond as well. In fact, it's the double bond that's reduced first in a conjugate addition, followed by addition to the carbonyl group.

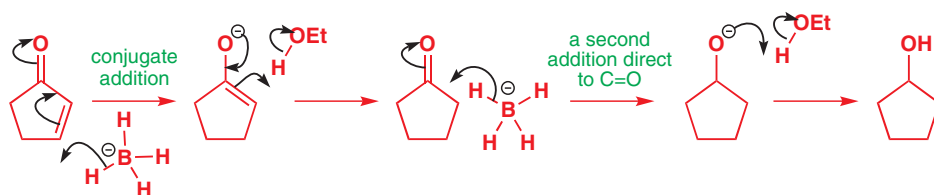

Luche reduction

It is possible to force NaBH₄ to attack only the C=O group by adding CeCl₃ to the reaction mixture. This modification is known as the Luche reduction, after its discoverer.

For esters and other less reactive carbonyl compounds conjugate addition is the only reaction that occurs because NaBH₄ doesn't reduce esters or amides.

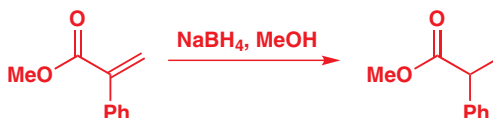

The nature of the nucleophile: hard or soft

Among the best nucleophiles of all at doing conjugate addition are thiols, the sulfur analogues of alcohols. In this example, the nucleophile is thiophenol (phenol with the O replaced by S).

Remarkably, no acid or base catalyst is needed (as it was with the alcohol additions), and the product is obtained in 94% yield under quite mild reaction conditions.

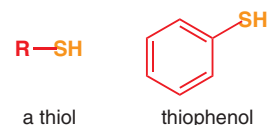
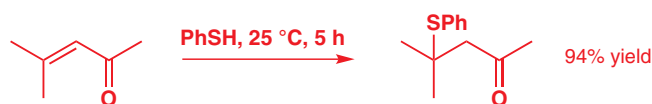

So what's so special about a thiol? As you've seen already, attraction between nucleophiles and electrophiles is governed by two related interactions—electrostatic attraction between positive and negative charges and orbital overlap between the HOMO of the nucleophile and the LUMO of the electrophile. Successful reactions usually result from a combination of both, but sometimes reactivity can be dominated by one or the other. The dominant factor, be it electrostatic or orbital control, depends on the nucleophile and electrophile involved. Nucleophiles containing small, electronegative atoms (such as O or Cl), which we call 'hard', tend to react under predominantly electrostatic control, while 'soft' nucleophiles containing larger atoms (including the sulfur of thiols, but also P, I, and Se) are predominantly subject to control by orbital overlap.

The table below divides some nucleophiles into the two categories (plus some that lie in between)—but don't try to learn it! Rather, convince yourself that the properties of each one justify its location in the table. Most of these nucleophiles you have not yet seen in action, and the most important ones at this stage are indicated in **bold type**.

Hard and soft nucleophiles

Hard nucleophiles	Borderline	Soft nucleophiles
F^- , OH^- , RO^- , SO_4^{2-} , Cl^-	N_3^- , CN^-	I^- , RS^- , RSe^- , S^{2-}
H_2O , ROH , ROR' , $RCOR'$	RNH_2 , $R'R''NH$	RSH , RSR' , R_3P
NH_3 , $RMgBr$, RLi	Br^-	alkenes, aromatic rings

Not only can nucleophiles be classified as hard or soft, but electrophiles can too. For example, H^+ is a very hard electrophile because it is small and charged, while Br_2 is a soft electrophile: its orbitals are diffuse and it is uncharged. You saw Br_2 reacting with an alkene earlier in the chapter, and we explained in Chapter 5 that this reaction happens solely because of orbital interactions: no charges are involved.

● Hard/soft reactivity

- Reactions of hard species are dominated by charges and electrostatic effects.
- Reactions of soft species are dominated by orbital effects.
- Hard nucleophiles tend to react well with hard electrophiles.
- Soft nucleophiles tend to react well with soft electrophiles.

What has all this to do with the conjugate addition of thiols? Well, an α,β -unsaturated carbonyl compound is unusual in that it has two electrophilic sites, one of which is hard and one of which is soft. The carbonyl group has a high partial charge on the carbonyl carbon and will tend to react with hard nucleophiles, such as organolithium and Grignard reagents, that have a high partial charge on the nucleophilic carbon atom. Conversely, the β carbon of the α,β -unsaturated carbonyl system does not have a high partial positive charge but is the site of the largest coefficient in the LUMO. This makes the β carbon a soft electrophile and likely to react well with soft nucleophiles such as thiols.

● Hard/soft—direct/conjugate addition

- Hard nucleophiles tend to react at the carbonyl carbon (hard) of an enone.
- Soft nucleophiles tend to react at the β carbon (soft) of an enone and lead to conjugate addition.

■ We introduced the terms **hard** and **soft** in relation to nucleophiles in Chapter 15, p. 357.

Anticancer drugs that work by conjugate addition of thiols

Drugs to combat cancer act on a range of biochemical pathways, but most commonly on processes that cancerous cells need to use to proliferate rapidly. One class attacks DNA polymerase, an enzyme needed to make the copy of DNA that has to be provided for each new cell. Helenalin and vernolepin are two such compounds, and if you look closely at their structure you should be able to spot

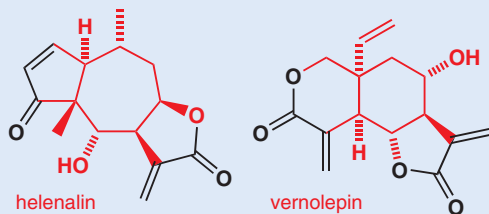

two α,β -unsaturated carbonyl groups in each. Biochemistry is just chemistry in very small flasks called cells, and the reaction between DNA polymerase and these drugs is simply a conjugate addition reaction between a thiol (the SH group of one of the enzyme's cysteine residues) and the unsaturated carbonyl groups. The reaction is irreversible and shuts down completely the function of the enzyme.

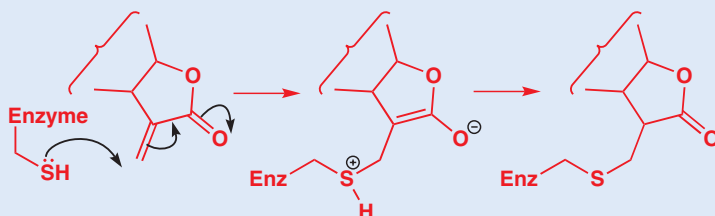

For this reason any compound capable of conjugate addition is potentially dangerous to living things. Even simple compounds like ethyl acrylate are labelled 'cancer suspect agents'. They attack enzymes, particularly the DNA polymerase involved in cell division by conjugate addition to thiol and amino groups in the enzyme. Fortunately, we are offered some degree of protection by an

important compound present in most tissues. The compound is glutathione, a tripeptide—a compound made from three amino acids. We shall discuss such compounds in more detail later in the book (Chapter 42) but notice for the moment that this compound can be divided into three at the two amide bonds.

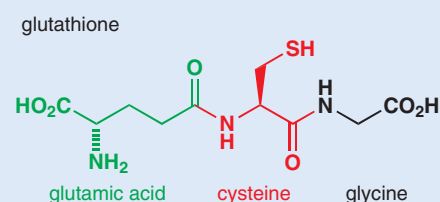

The business end of glutathione is the thiol (SH) group, which scavenges carcinogenic compounds by conjugate addition. If we use an 'exomethylene lactone'—a highly reactive Michael acceptor—as an example and represent glutathione as RCH_2SH , you can see the sort of thing that happens. If the normally abundant glutathione is removed by such processes as oxidation

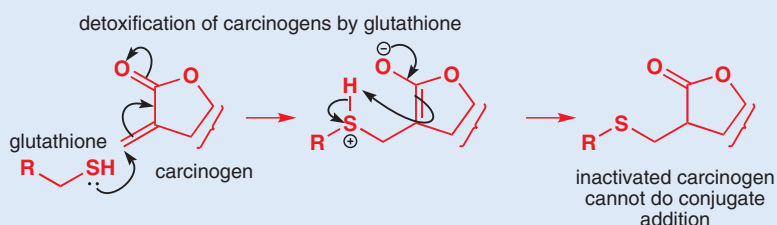

(Chapter 42) and cannot any longer scavenge toxins, then the organism is in danger. This is one reason why 'antioxidants' like vitamin C are so beneficial—they remove stray oxidizing agents and protect the supply of glutathione. Keep eating the fruit and vegetables!

Promoting conjugate addition with copper(I) salts

Grignard reagents add directly to the carbonyl group of α,β -unsaturated aldehydes and ketones to give allylic alcohols: you have seen several examples of this, and you can now explain it by saying that the hard Grignard reagent prefers to attack the harder $C=O$ rather than the softer $C=C$ electrophilic centre. Here is a further example—the addition of $MeMgBr$ to a cyclic ketone to give an allylic alcohol, plus, as it happens, some of a diene that arises from this alcohol by loss of water (dehydration). Below this example is the same reaction to which a very small amount (just 0.01 equivalents, that is, 1%) of copper(I) chloride has been added. The effect of the copper is dramatic: it makes the Grignard reagent undergo conjugate addition, with only a trace of the diene.

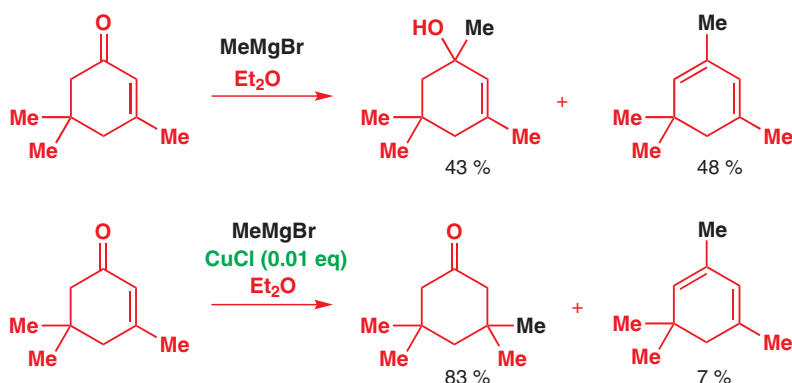

Organocopper reagents undergo conjugate addition

The copper works by *transmetallating* the Grignard reagent to give an organocopper reagent—simply put, the magnesium is exchanged for copper. Organocoppers are softer than Grignard reagents, and add in a conjugate fashion to the softer C=C double bond. Once the organocopper has added, the copper salt is available to transmetallate some more Grignard, and only a catalytic amount is required.

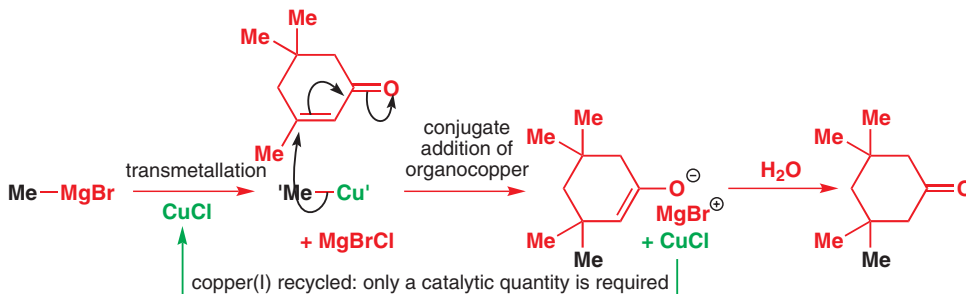

The organocopper is shown here as 'Me-Cu' because its precise structure is not known. But there are other organocopper reagents that also undergo conjugate addition and are much better understood. The simplest result from the reaction of two equivalents of organolithium with one equivalent of a copper (I) salt such as CuBr in ether or THF solvent at low temperature. The lithium cuprates (R₂CuLi) that are formed are not stable and must be used immediately.



The addition of lithium cuprates to α,β -unsaturated ketones turns out to be much better if trimethylsilyl chloride is added to the reaction—we shall explain what this does shortly, but for the moment here are two examples of lithium cuprate additions.

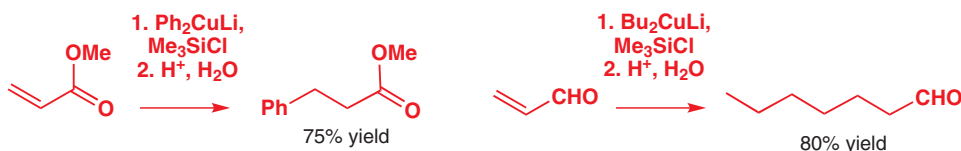

The silicon works by reacting with the negatively charged intermediate in the conjugate addition reaction to give a silyl enol ether—a type of molecule we met in Chapter 20. Here is a possible mechanism for a reaction between Bu₂CuLi and an α,β -unsaturated aldehyde in the presence of Me₃SiCl. The silyl enol ether simply hydrolyses to the ketone at the end of the reaction.

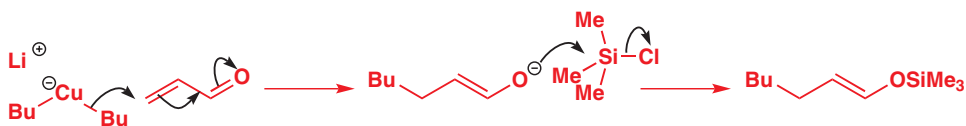

Summary: factors controlling conjugate addition

At this point in the chapter it is worthwhile talking stock of the factors controlling the two modes of addition to α,β -unsaturated carbonyl compounds.

■ Organocoppers are softer than Grignard reagents because copper is less electropositive than magnesium, so the C-Cu bond is less polarized than the C-Mg bond, giving the carbon atom less of a partial negative charge. Electronegativities: Mg, 1.3; Cu, 1.9.

■ As with many other organometallic compounds, the exact structure of these reagents is more complex than we imply here: they are probably tetramers (four molecules of R₂CuLi bound together), but for simplicity we will draw them as monomers. Organometallics (compounds with metal-carbon bonds) get a chapter to themselves (Chapter 40).

● Conjugate (1,4 or Michael) vs direct (1,2) addition

	Conjugate addition favoured by	Direct addition to C=O favoured by
Reaction conditions (for reversible additions):	thermodynamic control: high temperatures, long reaction times	kinetic control: low temperatures, short reaction times
Structure of α,β -unsaturated compound:	unreactive C=O group (amide, ester) unhindered β carbon	reactive C=O group (aldehyde, acyl chloride) hindered β carbon
Type of nucleophile:	soft nucleophiles	hard nucleophiles
Organometallic:	organocoppers or catalytic Cu(I)	organolithiums, Grignard reagents

Extending the reaction to other electron-deficient alkenes

It's not only carbonyl-based groups that make alkenes react with nucleophiles rather than the more usual electrophiles. Other electron-withdrawing groups do just the same thing. Here are two examples: a nitrile and a nitro group. These compound classes appeared in Chapter 21 in the context of aromatic substitution reactions where we saw them pulling electron density away from the ring. The same thing happens here.

Unsaturated nitriles and nitro compounds

The simplest conjugated nitrile is acrylonitrile. This compound adds amines readily. No special conditions are needed to encourage attack at C=C rather than C≡N because the nitrile carbon is rather unreactive as an electrophilic centre.

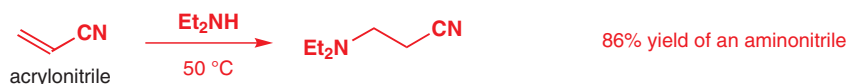

The amine first attacks the alkene in a typical conjugate addition to make an anion stabilized by being next to the nitrile. The anion can have its charge drawn on C or N: it is delocalized like an enolate. Do not be put off by the odd appearance of the 'enolate'. The dot between the two double bonds is a reminder that there is a linear sp carbon atom at this point.

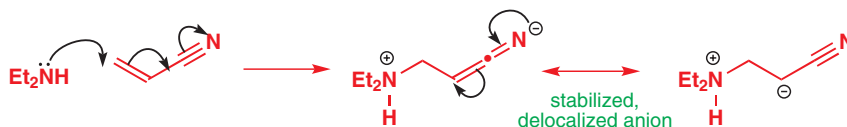

Protonation at carbon restores the nitrile and gives the product—an amino-nitrile. The whole process adds a 2-cyano-ethyl group to the amine and is known industrially as cyanoethylation.

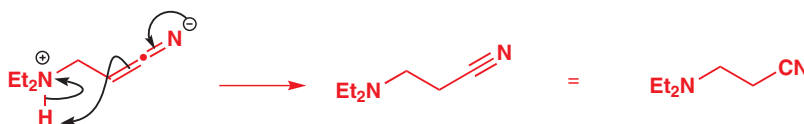

With a primary amine, the reaction need not stop at that stage as the product is still nucleophilic and a second addition can occur to replace the second hydrogen atom on nitrogen.

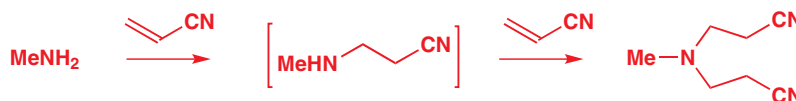

➔ For reactions where strong nucleophiles do attack C≡N—partly because they have nothing else to attack—see pp. 220 and 231.

🖱 Conjugate addition of amines to acrylonitrile

■ You will see a few mechanisms in this chapter where we have written an intramolecular deprotonation. This saves writing two steps—protonation of the enolate and deprotonation of N (in this case)—but quite possibly this is not the actual mechanism by which the proton transfer takes place. Any proton will do, as will any base—the protons are hopping around all the time, so as with any proton transfer it doesn't pay to take the arrows too literally. We discussed alternative but equivalent mechanisms for proton transfers in Chapter 12, p. 267.

Other elements such as O, S, or P can add too. Phenyl phosphine can undergo a double addition just as in the last example, but alcohols can add only once. If there is competition between a first-row (for example N or O) and a second-row (for example S or P) element, the second-row element normally wins, for the reasons discussed above (p. 507).



The nitro group (NO_2) is extremely electron-withdrawing—about twice as electron-withdrawing as a carbonyl group. It is also unreactive as an electrophilic centre, which makes conjugate addition to nitro-alkenes a very reliable reaction. In this example, sodium borohydride attacks the $\text{C}=\text{C}$ bond in a conjugate manner to give an intermediate looking rather like an enolate anion, with a negatively charged oxygen atom conjugated to an ($\text{N}=\text{C}$) double bond. It reacts like an enolate too, picking up a proton on carbon to re-form the nitro group and give a stable product.

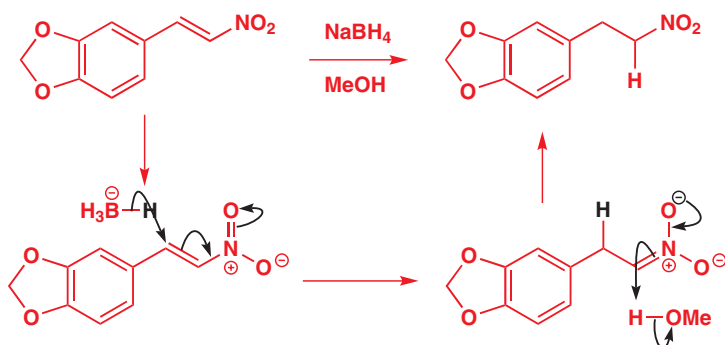

Conjugate substitution reactions

Just as direct addition to $\text{C}=\text{O}$ (Chapter 6) becomes substitution at $\text{C}=\text{O}$ (Chapter 10) when there is a leaving group at the carbonyl carbon, so conjugate *addition* becomes conjugate *substitution* if there is a leaving group, such as Cl, at the β carbon atom. Here is an example: substitution replaces Cl with OMe, just as it would have done in a reaction with an acyl chloride.

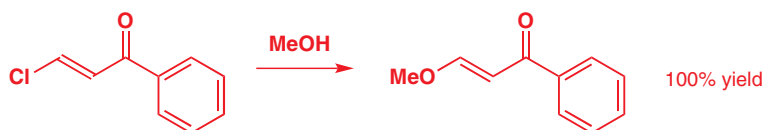

As with substitution at $\text{C}=\text{O}$, this apparently simple reaction does *not* involve a direct displacement of the leaving group in a single step. The mechanism starts in exactly the same way as for conjugate addition, giving an enol intermediate.

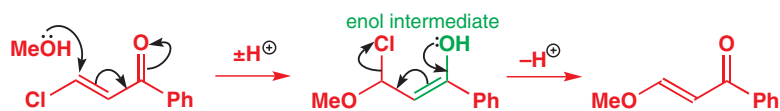

Now the leaving group can be expelled by the enol: the double bond moves back into its original position in an elimination reaction—the sequence is often called an addition–elimination

Vinylogous behaviour

Compounds like this are known as vinylogous amides—the conjugated double bond serves as an electronic linker between the carbonyl group and the heteroatom, which makes the chemical and spectroscopic behaviour of the composite functional group similar to that of its simpler relative. You could think of the β -chloro enone at the beginning of this section as a vinylogous acyl chloride that reacts with methanol to give a vinylogous ester.

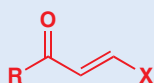

is the vinylogous version of, and reacts similarly to,



reaction. The 'new' double bond has the more stable *E* configuration. In the next example, two consecutive conjugate substitution reactions give a 1,1-diamine.

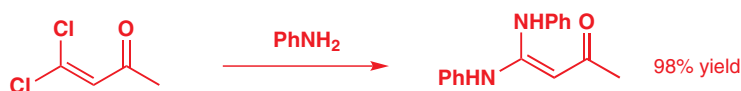

At first sight, the product looks rather unstable—sensitive to water, or traces of acid perhaps. But, in fact, it is remarkably resistant to reaction with both. The reason is conjugation: this isn't really an amine (or a diamine) at all because the lone pairs of the nitrogen atoms are delocalized through into the carbonyl group, very much as they are in an amide. This makes them less basic, and makes the carbonyl group less electrophilic.

delocalization of the nitrogen's lone pair



delocalization in an amide



Conjugate substitution and the synthesis of anti-ulcer drugs

Just as the cyanide (CN) and nitro (NO₂) groups can be used to bring about conjugate addition, so also can they initiate conjugate substitution. Examples of these reactions play important roles in the synthesis of two of the most significant drugs in the development of modern medicinal chemistry: the anti-ulcer compounds cimetidine (marketed as Tagamet) and ranitidine (Zantac). We looked at some aspects of the structure of these drugs in Chapter 8 (p. 178) and we are now going to see how conjugate addition is used in their synthesis.

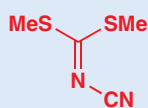
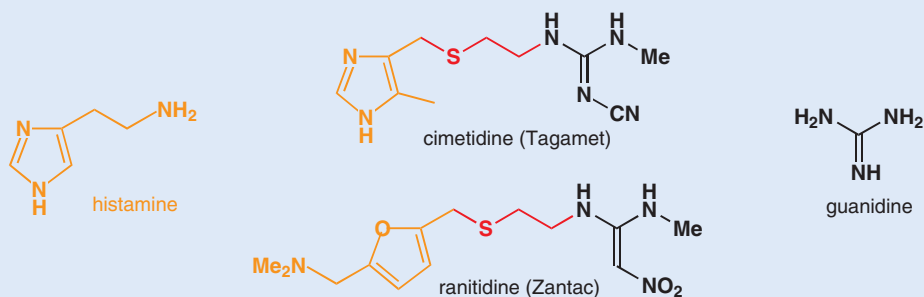

The simple cyanoimino on the left, with two SMe groups as built-in leaving groups, is readily available and reacts with amines to give guanidines in two stages. Each of the reactions is a conjugate substitution. It will be clearer if we draw the reaction with a generalized primary amine RNH₂ first: conjugate addition, exactly as we saw with acrylonitrile, is followed by expulsion of the best leaving group. Thiols are acidic compounds, and MeS⁻ is a better leaving group than RNH⁻.

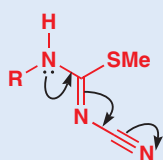
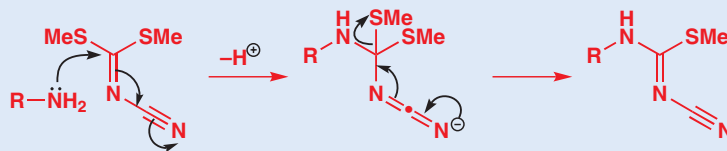

The reaction stops cleanly at this point and more vigorous conditions are required to displace the second MeS⁻ group. This is because the first product is less reactive than the starting material: the new amino group is electron-donating and conjugation is established between it and the cyano group, deactivating the molecule towards a second conjugate substitution (as shown in the margin). But under more forcing conditions a second and different amine can be introduced and the second MeS⁻ group displaced. In the synthesis of cimetidine the second amine is MeNH₂ and the molecule is complete.

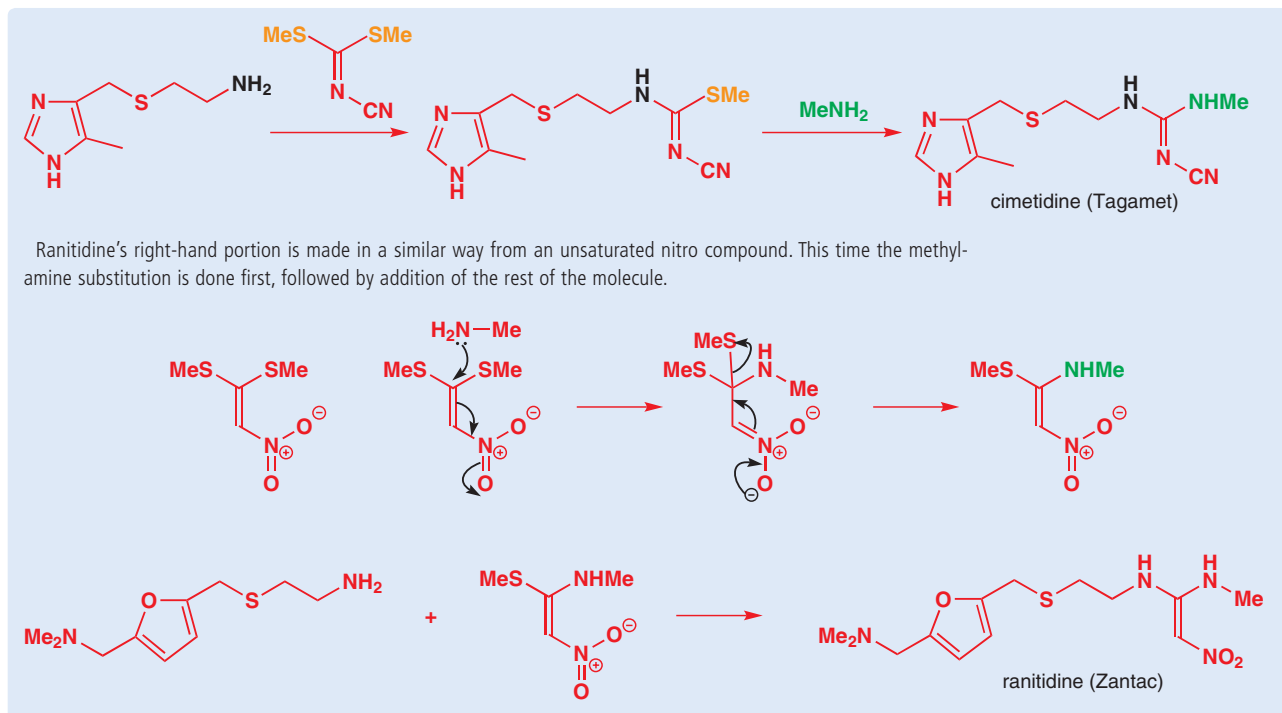

Nucleophilic epoxidation

The conjugate substitutions we have just been discussing rely on a starting material containing a leaving group. In this section we are going to look at what happens if the leaving group is not attached to the unsaturated carbonyl compound, but instead is attached to the nucleophile. We shall look at this class of compounds—nucleophiles with leaving groups attached—in more detail in Chapter 38), but for the moment the most important will be hydroperoxide, the anion of hydrogen peroxide.

Hydroperoxide is a good nucleophile because of the **alpha effect**: interaction of the two lone pairs on adjacent oxygen atoms raises the HOMO of the anion and makes it a better and softer nucleophile than hydroxide. Hydroperoxide is also less basic than hydroxide because of the inductive electron-withdrawing effect of the second oxygen atom. Basicity and nucleophilicity usually go hand in hand—not here though. This means that the hydroperoxide anion can be formed by treating hydrogen peroxide with aqueous sodium hydroxide.

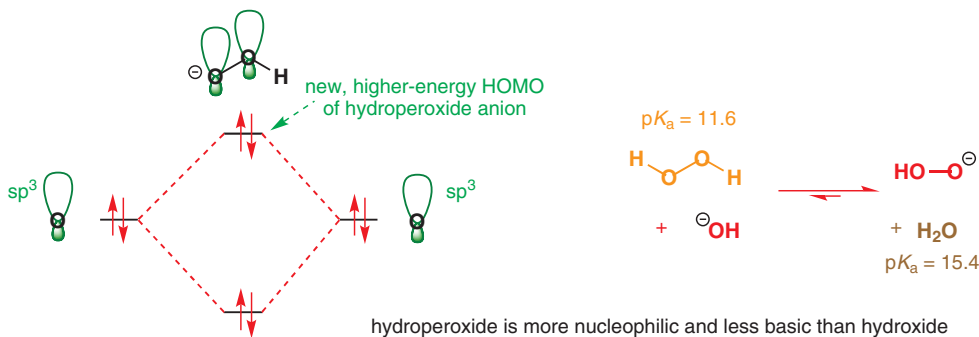

This is what happens when this mixture is added to an enone. First, there is the conjugate addition.

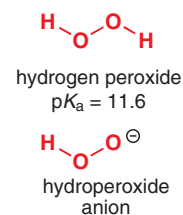

■ The same effect explains why hydroxylamine and hydrazine are more nucleophilic than ammonia (see p. 232).

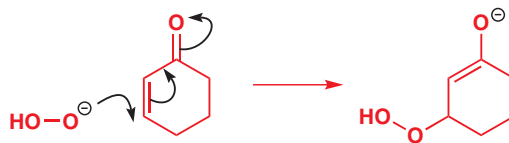

But the product is not stable because hydroxide can be lost from the oxygen atom that was the nucleophile. Hydroxide is fine as a leaving group here—after all, hydroxide is lost from enolates in E1cB eliminations, and here the bond breaking is a weak O–O bond. The product is an epoxide.

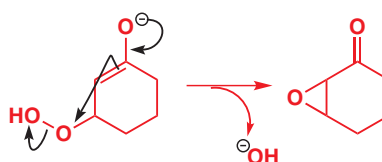

Interactive mechanism for nucleophilic epoxidation

The electrophilic epoxidizing agents such as *m*-CPBA, which you met in Chapter 19, work reliably only with nucleophilic alkenes, and for α,β -unsaturated carbonyl compounds and other electron-deficient alkenes, hydroperoxide—a nucleophilic epoxidizing agent—is often used instead.

There is another significant difference between hydrogen peroxide and *m*-CPBA, highlighted by the pair of reactions below.

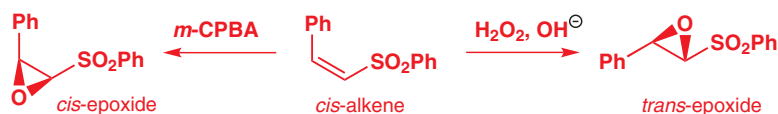

➔ For a reminder of the meaning of the term *stereospecific*, see p. 396.

m-CPBA epoxidation is stereospecific because the reaction happens in one step. But nucleophilic epoxidation with hydroperoxide is a two-step reaction: there is free rotation about the bond marked in the anionic intermediate, and the more stable, *trans*-epoxide results, whatever the geometry of the starting alkene.

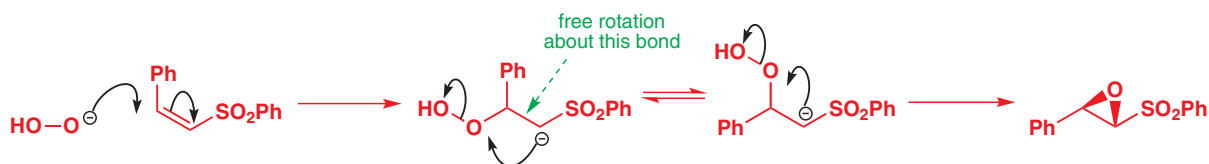

Nucleophilic aromatic substitution

In this next section we are going to consider reactions related to conjugate substitutions but in which the double bond is part of an aromatic ring. We spent some considerable time in Chapter 21 explaining that aromatic rings are *nucleophilic*: electrophiles attack them, and typical aromatic reactivity is to undergo electrophilic substitution.

In general, nucleophilic substitutions of aromatic halides—such as the one proposed here in which hydroxide is attempting to displace bromide—**do not happen**. You might well ask, ‘Why not?’ The reaction looks all right and, if the ring were saturated, it *would be* all right.

This is an S_N2 reaction, and we know (Chapter 15) that attack must occur in line with the C–Br bond from the back, where the largest lobe of the σ^* orbitals lies. That is perfectly all right for the aliphatic ring because the carbon atom is tetrahedral and the C–Br bond is not in the plane of the ring. Substitution of an equatorial bromine goes like this:

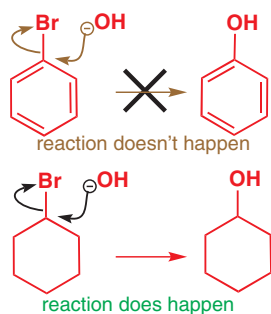

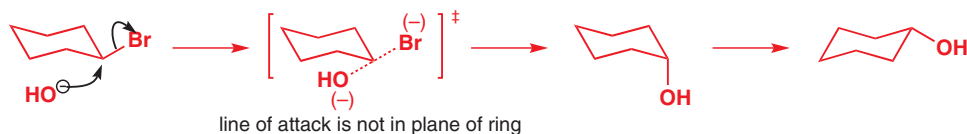

But in the aromatic compound, the C–Br bond *is* in the plane of the ring as the carbon atom is trigonal. To attack from the back, the nucleophile would have to appear inside the benzene ring and invert the carbon atom in an absurd way. This reaction is of course not possible.

This is another example of the general rule:



● S_N2 at sp^2 C does not occur.

If S_N2 is impossible, what about S_N1 ? This is possible but very unfavourable unless the leaving group is an exceptionally good one (see below for an example). It would involve the unaided loss of the leaving group and the formation of an aryl cation. All the cations we saw as intermediates in the S_N1 reaction (Chapter 15) were planar with an empty p orbital. This cation is planar but the p orbital is full—it is part of the aromatic ring—and the empty orbital is an sp^2 orbital outside the ring.

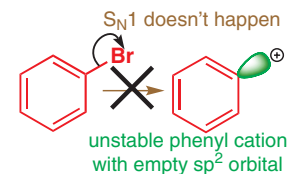

Yet some aromatic compounds *do* undergo nucleophilic substitution. Just as normally nucleophilic alkenes can be made to undergo conjugate substitution if they carry electron-withdrawing substituents, so normally nucleophilic aromatic rings also become electrophilic if they have the right substituents. The mechanism by which they undergo nucleophilic substitution also closely parallels that of conjugate substitution which you have just seen.

The addition–elimination mechanism

Imagine a cyclic β -fluoro-enone reacting with a secondary amine in a conjugate substitution reaction. The normal addition to form the enolate followed by return of the negative charge to expel the fluoride ion gives the product.

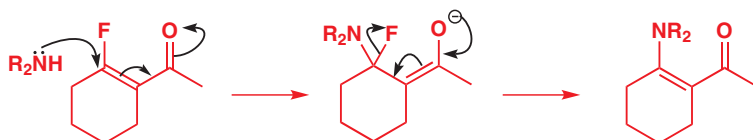

Now imagine just the same reaction with two extra double bonds in the ring. These play no part in our mechanism; they just make what was an aliphatic ring into an aromatic one. Conjugate substitution has become **nucleophilic aromatic substitution**.

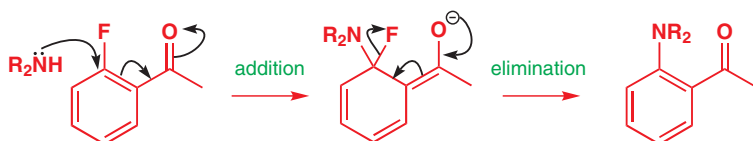

The mechanism involves *addition* of the nucleophile followed by *elimination* of the leaving group—the **addition–elimination mechanism**. It is not necessary to have a carbonyl group—any electron-withdrawing group will do—the only requirement is that the electrons must be able to get out of the ring into this anion-stabilizing group. Here is an example with a *para*-nitro group.

■ This mechanism is also abbreviated to S_NAr (for Substitution, Nucleophilic, Aromatic).

 Interactive mechanism for aromatic addition–elimination

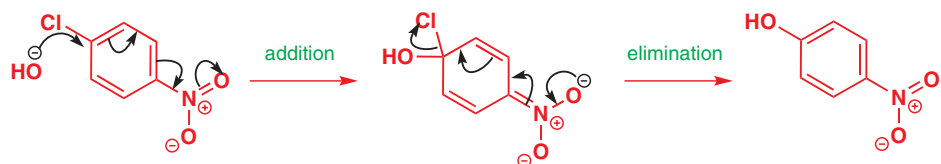

Everything is different about this example—the nucleophile (HO^-), the leaving group (Cl^-), the anion-stabilizing group (NO_2), and its position (*para*)—but the reaction still works. The nucleophile is a good one, the negative charge can be pushed through on to the oxygen atom(s) of the nitro group, and chloride is a better leaving group than OH^- .

• **A typical nucleophilic aromatic substitution has:**

- an oxygen, nitrogen, or cyanide nucleophile
- a halide for a leaving group
- a carbonyl, nitro, or cyanide group *ortho* and/or *para* to the leaving group.

Since the *nitro* group is usually introduced by electrophilic aromatic substitution (Chapter 21) and halides direct *ortho/para* in nitration reactions, a common sequence is nitration followed by nucleophilic substitution.

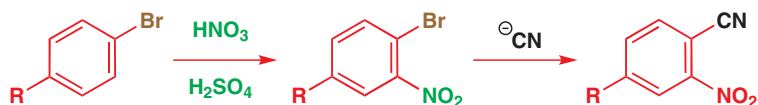

This sequence is useful because the nitro group could not be added directly to give the final product as nitration would go in the wrong position. The nitrile is *meta*-directing, while the alkyl group (R) is *ortho, para*-directing.

Two activating electron-withdrawing groups are better than one and dinitration of chlorobenzene makes a very electrophilic aryl halide. Reaction with hydrazine gives a useful reagent.

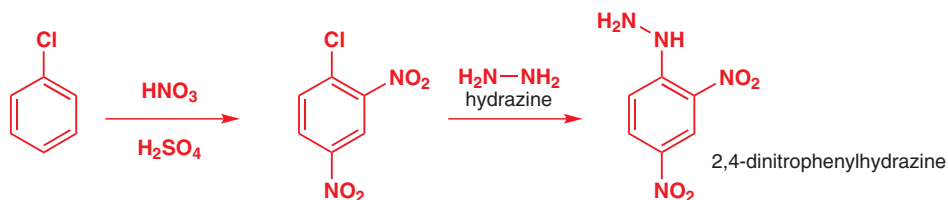

It also makes a very toxic one! This compound—2,4-dinitrophenylhydrazine—is carcinogenic. Nonetheless it forms coloured crystalline imines (hydrazones) with carbonyl compounds—before the days of spectroscopy these were used to characterize aldehydes and ketones (see p. 232).

The intermediate in the addition–elimination mechanism

What evidence is there for intermediates like the ones we have been using in this section? When reactions like this last example are carried out, a purple colour often appears in the reaction mixture and then fades away. In some cases the colour is persistent and thought to be due to the intermediate. Here is an example with RO^- attacking a nitrated aniline. This intermediate is persistent because neither potential leaving group (NR_2 or OR) is very good.

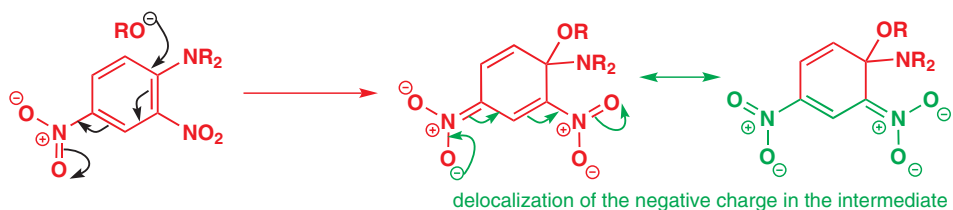

What is the nature of this intermediate? Well, in essence it is an anion delocalized over five sp^2 hybridized carbons of a six-membered ring (the sixth, the point at which the nucleophile attacked, is sp^3 hybridized). It's possible to make a simple homologue of such a species by deprotonating cyclohexadiene. Delocalizing the anion generates the three structures below.

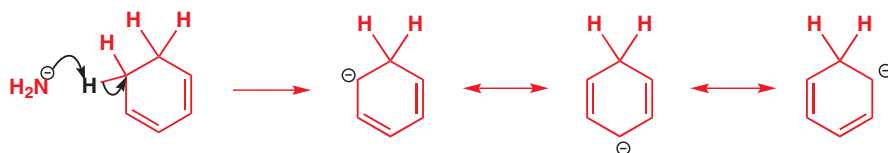

You've seen before that ^{13}C NMR spectra are revealing when it comes to distribution of charge, and the details of the ^{13}C NMR spectrum of this anion are shown below, along with those of benzene itself and also of the cation generated by protonating benzene (which, as you will remember from Chapter 21, corresponds to the intermediate generated in electrophilic aromatic substitution).

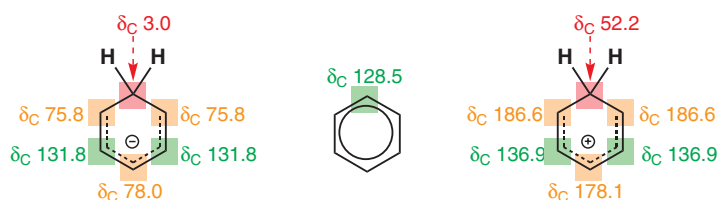

■ A reminder: A larger shift means less electronic shielding and a smaller shift more electronic shielding.

These results are very striking. The shifts of the *meta* carbons in both ions are very slightly different from those of benzene itself (about 130 ppm). But the *ortho* and *para* carbons in the anion have gone upfield to much smaller shifts, indicating greater electron density. By contrast, *ortho* and *para* carbons in the cation have gone downfield to much larger shifts.

The differences are very great—about 100 ppm between the cation and the anion! It is very clear from these spectra that the ionic charge is delocalized almost exclusively to the *ortho* and *para* carbons in both cases. The alternative structures in the margin show this delocalization.

This means that stabilizing groups, such as nitro or carbonyl in the case of the anion, can only have an effect if they are on carbons *ortho* or *para* to the position being attacked by the nucleophile. A good illustration of this is the selective displacement of one chlorine atom out of these two. The chlorine *ortho* to the nitro group is lost; the one *meta* is retained.

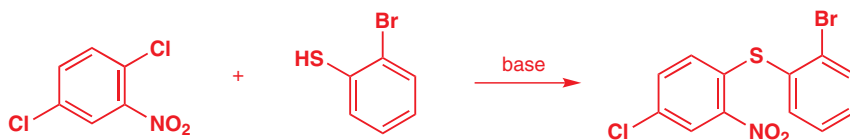

The mechanism works well if the nucleophile (the anion derived from the thiol) attacks the carbon bearing the chlorine *ortho* to the nitro group as the negative charge can then be pushed into the nitro group. Satisfy yourself that you cannot do this if you attack the other chlorine position. This is a very practical reaction and is used in the manufacture of a tranquilizing drug.

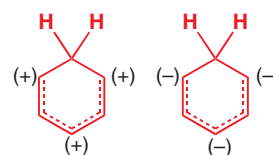
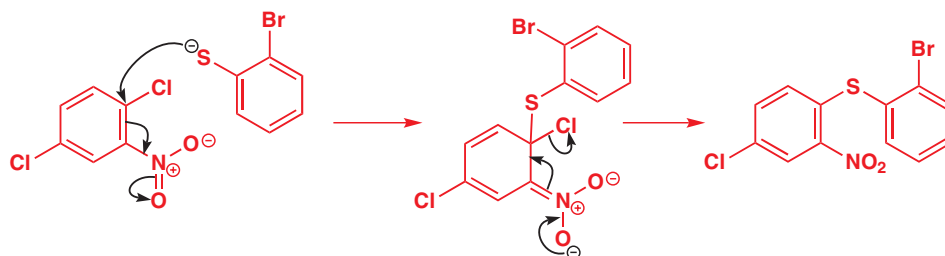

■ Remember, charges in brackets show significant (here ca. 1/3) portions of a charge, in contrast with δ , which means a much smaller polarization.

The leaving group and the mechanism

In the first nucleophilic aromatic substitution that we showed you, we used fluoride ion as a leaving group. Fluoride works very well in these reactions and even such a simple compound as 2-halo-1-nitrobenzenes reacts efficiently with a variety of nucleophiles, as in these examples.

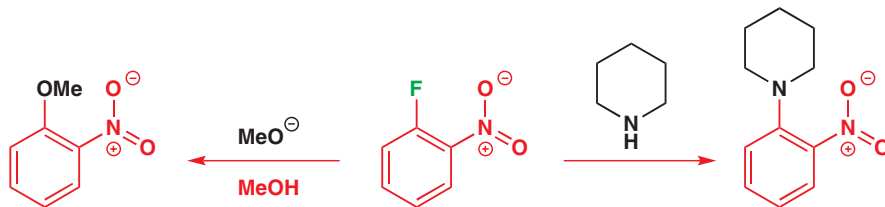

reactivity of 2-halo-1-nitrobenzenes in nucleophilic aromatic substitution

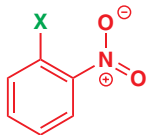

$F \gg Cl \sim Br \gg I$

The same reactions happen with the other 2-halo-1-nitrobenzenes but less efficiently. The fluoro-compound reacts about 10^2 – 10^3 times faster than the chloro or bromo compounds and the iodo compound is even slower.

This ought to surprise you. When we were looking at other nucleophilic substitutions such as those at the carbonyl group or saturated carbon, we never used fluoride as a leaving group! The C–F bond is very strong—the strongest of all the single bonds to carbon—and it is difficult to break. As a consequence, these reactions are not a good prospect:

This reaction is never used:

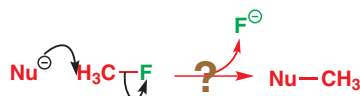

use instead Cl, Br, or I (I is best)

This reaction is rarely used:

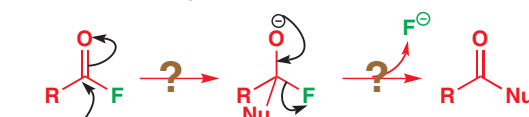

use instead Cl

So why is fluoride so good in nucleophilic aromatic substitution when the reverse is true with other reactions? You will notice that we have *not* said that fluoride is a better leaving group in nucleophilic aromatic substitution. It isn't! The explanation depends on a better understanding of the mechanism of the reaction. We shall use azide ion as our nucleophile because this has been well studied and because it is one of the best.

The mechanism is exactly the same as that we have been discussing all along—a two-stage addition–elimination sequence. In a two-step mechanism, one step is slower and rate determining; the other is unimportant to the rate. You may guess that, in the mechanism for nucleophilic aromatic substitution, it is the first step that is slower because it disturbs the aromaticity. The second step restores the aromaticity and is faster. The effect of fluoride, or any other leaving group, can only come from its effect on the first step. How good a leaving group it might be does not matter: the rate of the second step—the step where fluoride leaves—has no effect on the overall rate of the reaction.

➔ You met the azide anion in Chapter 15, p. 354.

■ Note carefully that this is an *inductive* effect: there are no arrows to be drawn to show how fluorine withdraws electrons—it does it just by polarizing C–F bonds towards itself. Contrast the electron-withdrawing effect of the nitro group, which works (mainly) by conjugation.

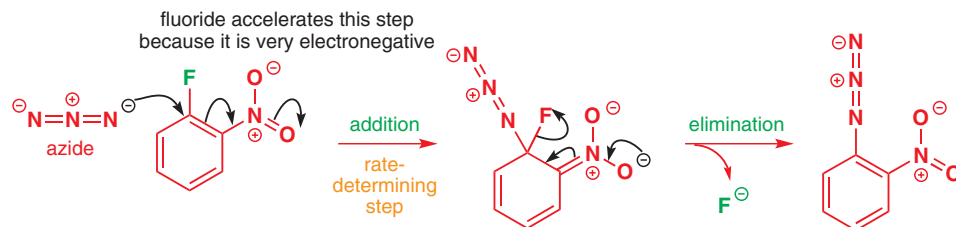

Fluoride accelerates the first step through its inductive effect. It is the most electronegative element of all and it stabilizes the anionic intermediate, assisting the acceptance of electrons by the benzene ring.

The activating anion-stabilizing substituent

We have used nitro groups very extensively so far because they are the best at stabilizing the anionic intermediate. Others that work include carbonyl, cyanide, and sulfur-based groups such as sulfoxides and sulfones. A direct comparison of the different groups Z that can assist the displacement of bromide (by the secondary amine piperidine in this example) is shown in the margin.

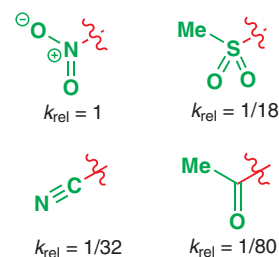
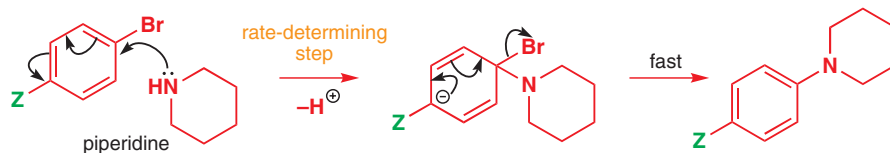

All the compounds react more slowly than the nitro compound. We have already mentioned (Chapters 8 and 21) the great electron-withdrawing power of the nitro group—here is a new measure of that power. The sulfone reacts 18 times slower, the nitrile 32 times slower, and the ketone 80 times slower.

Nitro is the best activating group, but the others will all perform well, especially when combined with a fluoride rather than a bromide as the leaving group. Here are two reactions that work well in a preparative sense with other anion-stabilizing groups. Note that the trifluoromethyl group works by using only its powerful inductive effect.

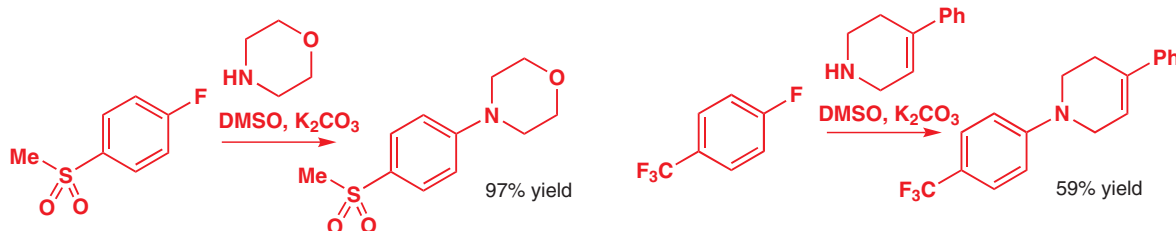

● To summarize

An anion-stabilizing (electron-withdrawing) group *ortho* or *para* to a potential leaving group can be used to facilitate nucleophilic aromatic substitution.

Conjugate and nucleophilic aromatic substitution reactions in action: the synthesis of an antibiotic

We want to convince you that this chemistry is useful and also that it works in more complicated molecules so we are going to describe in part the preparation of the antibiotic ofloxacin. The sequence starts with an aromatic compound having four fluorine atoms. Three are replaced sequentially by nucleophiles and the last is present in the antibiotic itself.

The first reaction is a conjugate substitution of the ethoxy group marked in orange. An amino alcohol is used as the nucleophile and it is the more nucleophilic amino group (rather than the hydroxyl group) that adds to the alkene.

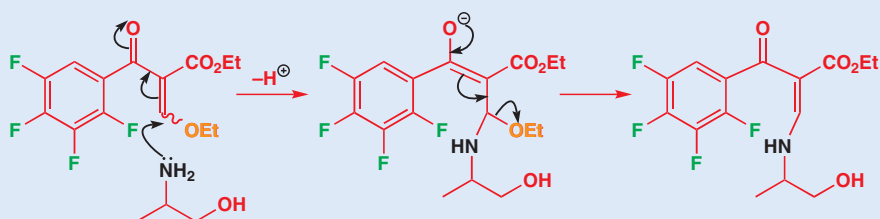

Now for the first nucleophilic aromatic substitution. The amino group attacks in the position *ortho* to the carbonyl group so that an enolate intermediate can be formed. The first fluoride is expelled in the elimination step.

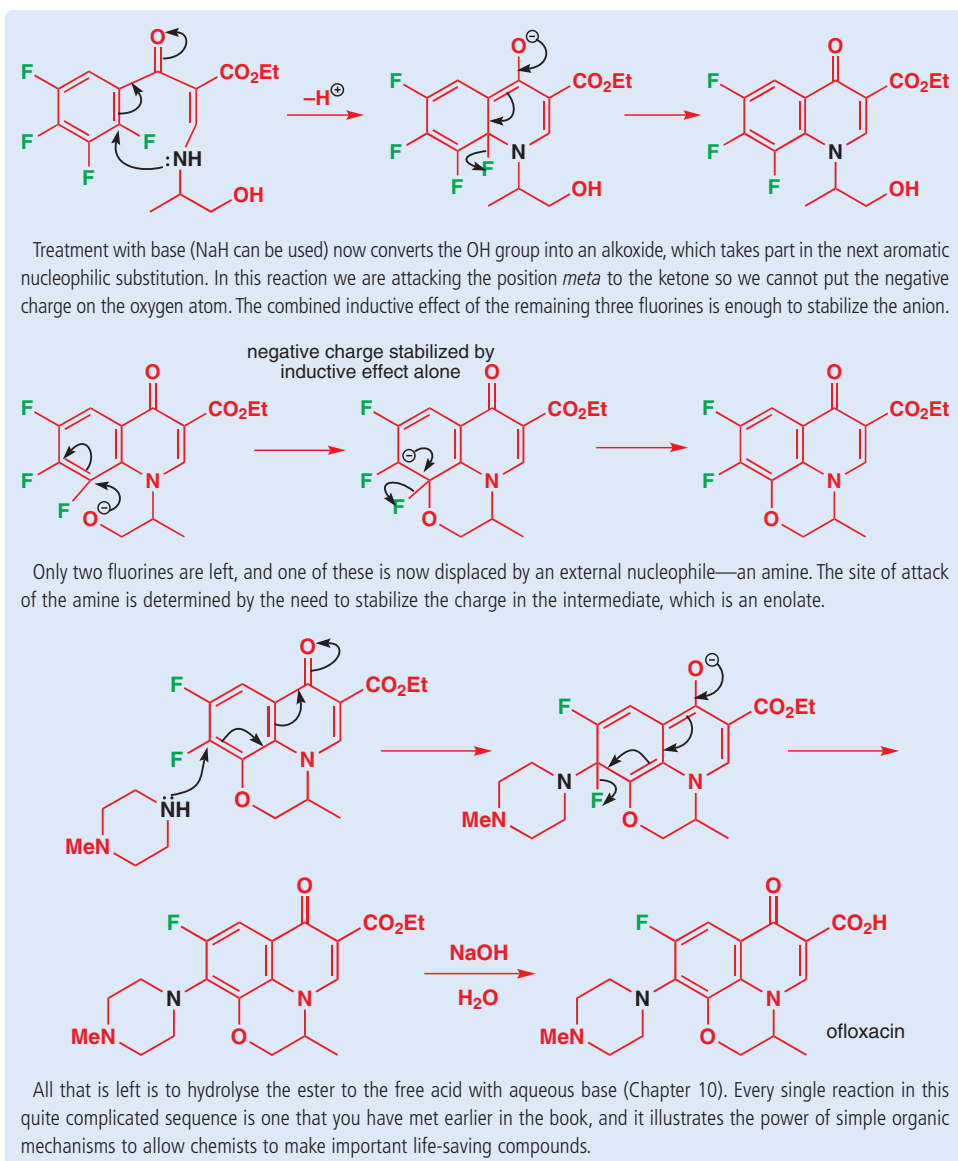

Nucleophilic substitution on aromatic rings is possible by alternative mechanisms as well. We will now turn to these.

The S_N1 mechanism for nucleophilic aromatic substitution: diazonium compounds

If we really want to make aromatic compounds undergo nucleophilic substitution in a general way, the way to do it is to use absolutely the best leaving group of all—nitrogen gas. In fact, the diazonium compound below is so good at nucleophilic aromatic substitution that it does so even without activating groups. On warming, the nitrogen molecule just departs, leaving behind a cation, which is captured by a nucleophile, in this case water. Do you find this reminiscent of the S_N1 reaction? We hope so.

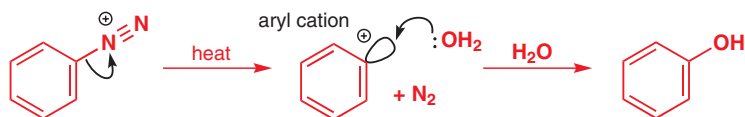

Before we talk about this group of aromatic S_N1 reactions in more detail, let's consider how to make the diazonium salt. The reagent we need is the reactive nitrogen electrophile NO⁺. You met NO⁺ in Chapter 20, but to remind you, it forms when the nitrite anion (usually sodium nitrite) is treated with acid at around 0 °C. Protonation of nitrite gives nitrous acid, HONO; protonation again gives a cation, which can lose water to form NO⁺. Butyl nitrite (or other alkyl nitrites) can also be used as a source of NO⁺.

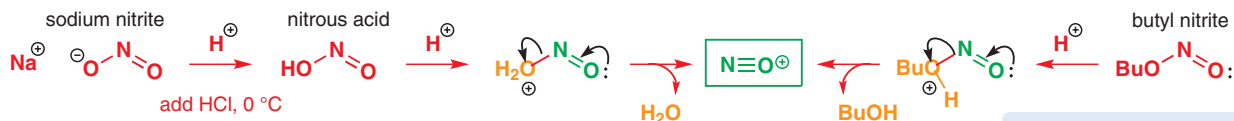

A diazonium salt is formed when NO⁺ reacts with an amine. The lone pair of the amine attacks the NO⁺ cation, and then water is lost. The mechanism is actually quite simple, but it does involve a lot of proton transfers. There is, of course, an anion associated with the nitrogen cation, and this will be the conjugate base (Cl⁻ usually) of the acid used to form NO⁺. This reaction is known as *diazotization*.

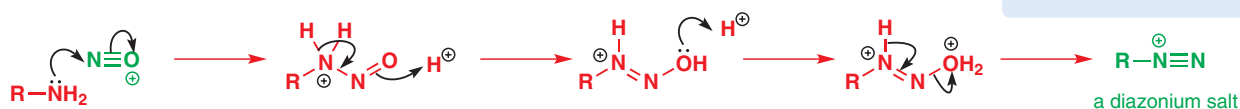

If the amine is secondary, water can't be eliminated and a *nitrosamine* forms.

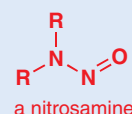

If the amine is an *alkyl* amine, this diazonium salt is very unstable and immediately loses nitrogen gas to give a planar carbocation, which normally reacts with a nucleophile in an S_N1 process (Chapter 15), loses a proton in an E1 process (Chapter 17), or rearranges (Chapter 36). It may, for example, react with water to give an alcohol:

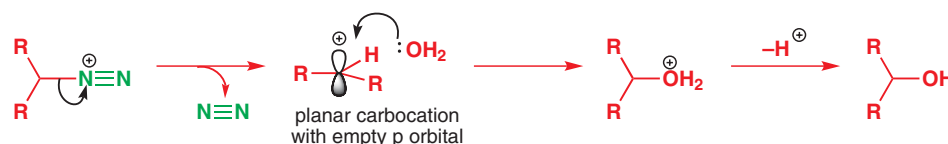

Interactive mechanism for formation of diazonium salt

If the amine is an aryl amine, then the reaction you saw at the beginning of this section will take place and a phenol will form. This is in fact rather a useful reaction as it is difficult to add an oxygen atom to a benzene ring by normal electrophilic substitution: there is no good reagent for OH⁺. A nitrogen atom can be added easily by nitration, and reduction and diazotization provide a way of replacing the nitro group by a hydroxyl group.

➔ We alluded to this sequence at the end of Chapter 21.

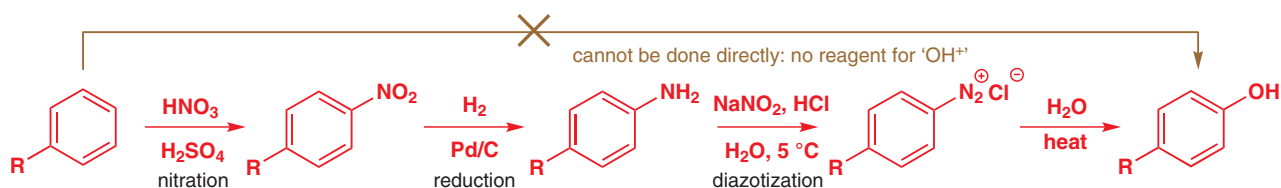

Substitution reactions in the synthesis of a drug

The synthesis of the drug thymoxamine (Moxslylyte) provides a practical example of how this reaction can be used.

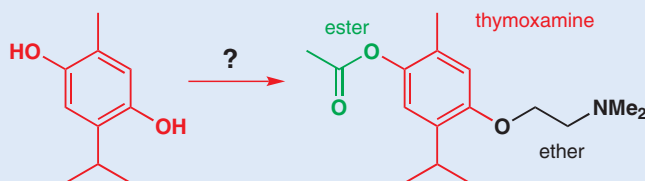

It seems obvious to make this compound by alkylation and acylation of a dihydroxybenzene, but how are we to make sure that the acylation and alkylation go on the right OH groups? French pharmaceutical chemists had an ingenious answer: start with a compound having only one OH group, alkylate that, and only then introduce the second using the diazonium salt method. They used a simple phenol and introduced nitrogen as a nitroso (NO) rather than a nitro (NO₂) group. This means using the same reagent as we have been using for diazotization. These were the first two steps.

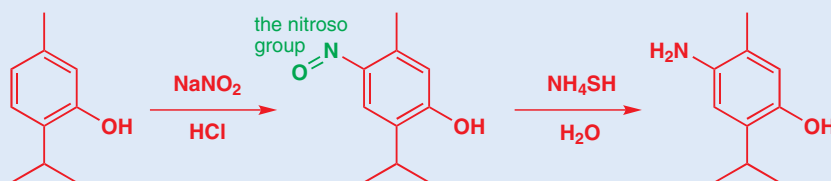

The reduction of NO is easier than that of NO₂, and H₂S is enough to do the job. The amine can now be converted to an amide to lessen its nucleophilicity so that alkylation of the phenol occurs cleanly—a form of protection (see Chapter 23).

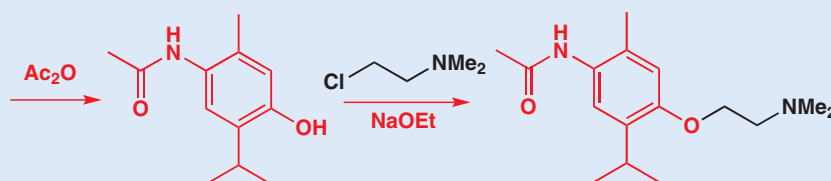

Finally, the amide must be hydrolysed, the amino converted into an OH group by diazotization and hydrolysis, and the new phenol acetylated.

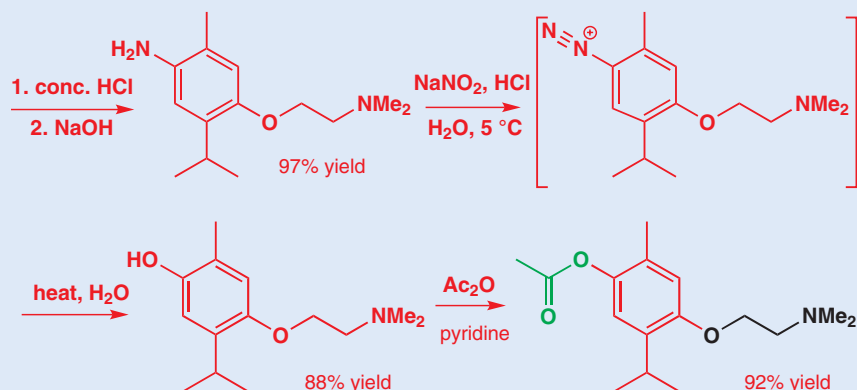

However, an aryl carbocation is much less stable than an alkyl carbocation because its empty orbital is an sp² rather than a p orbital. This makes the loss of nitrogen slower. If the diazotization is done at temperatures around 0 °C (classically at 5 °C), the diazonium salt is stable and can be reacted with various nucleophiles other than water.

Other nucleophiles

Aryl iodides are not as easy to make by electrophilic substitution as aryl chlorides or bromides because iodine is not reactive enough to attack benzene rings. But adding potassium iodide to the diazonium salt gives an aryl iodide by nucleophilic aromatic substitution.

■ Aryl iodides have wide utility in the coupling chemistry, catalysed by Pd and other transition metals, that you will meet in Chapter 40.

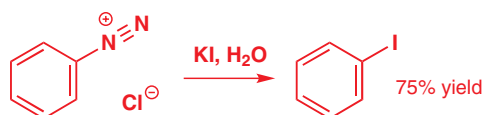

Other nucleophiles, such as chloride, bromide, and cyanide, are best added as copper(I) salts. Since aromatic amines are usually made by reduction of nitro compounds, a common sequence of reactions goes like this:

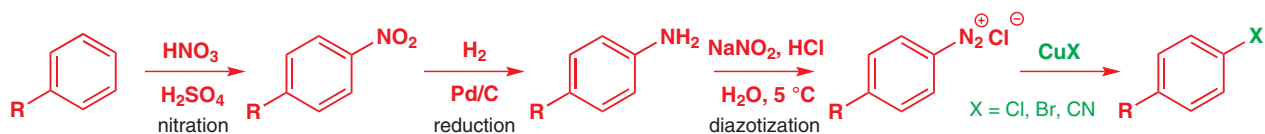

As often in aromatic chemistry, it's the versatility of the nitro group that makes this sequence work—easy introduction by electrophilic substitution, easy reduction, and easy nucleophilic substitution of its diazonium derivative.

The benzyne mechanism

We now need to introduce you to one last mechanism for aromatic nucleophilic substitution and you may well feel that this is the weirdest mechanism you have yet seen with the most unlikely intermediate ever! For our part, we hope to convince you that this mechanism is not only possible but also useful.

Earlier in this chapter we said that the displacement by nucleophiles of bromide from bromobenzene does not occur. In fact substitution reactions of bromobenzene *can* occur but only under the most vigorous conditions, such as when bromobenzene and NaOH are melted together (fused) at very high temperature. A similar reaction with the very powerful reagent NaNH₂ (which supplies NH₂⁻ ion) also happens, at a rather lower temperature.

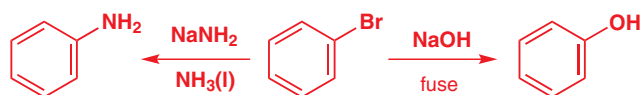

These reactions were known for a long time before anyone saw what was happening. They do not happen by an S_N2 mechanism, as we explained earlier, and they can't happen by the addition–elimination mechanism because there is nothing to stabilize the negative charge in the intermediate. The first clue to the true mechanism is that all the nucleophiles that react in this way are very basic. They start the reaction off by removing a proton *ortho* to the leaving group.

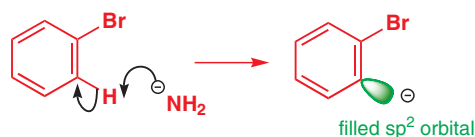

The carbanion is in an sp² orbital in the plane of the ring. Indeed, this intermediate is very similar to the aryl cation intermediate in the S_N1 mechanism from diazonium salts. That had no electrons in the sp² orbital; the carbanion has two. Why should this proton be removed rather than any other? The bromine atom is electronegative and the C–Br bond is in the plane of the sp² orbital and removes electrons from it. The stabilization is nonetheless weak and only exceptionally strong bases will do this reaction.

The next step is the loss of bromide ion in an elimination reaction. This is the step that is difficult to believe as the intermediate we are proposing looks impossible. The orbitals are bad for the elimination too—it is a *syn*- rather than an *anti*-periplanar elimination. But it happens.

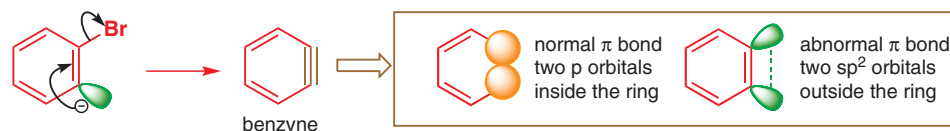

The intermediate is called benzyne as it is an alkyne with a triple bond in a benzene ring. But what does this triple bond mean? It certainly isn't a normal alkyne as these are linear. In fact one π bond is normal—it is just part of the aromatic system. One π bond—the new one—is abnormal and is formed by overlap of two sp² orbitals outside the ring. This external π bond

is very weak and benzyne is a very unstable intermediate. Indeed, when the structure was proposed few chemists believed it and some pretty solid evidence was needed before they did. We shall come to that shortly, but let us first finish the mechanism. Unlike normal alkynes, benzyne is electrophilic as the weak third bond can be attacked by nucleophiles.

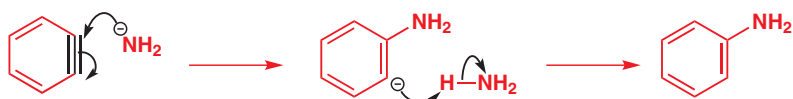

The whole mechanism from bromobenzene to aniline involves an elimination to give benzyne followed by an addition of the nucleophile to the triple bond of benzyne. In many ways, this mechanism is the reverse of the normal addition–elimination mechanism for nucleophilic aromatic substitution and it is sometimes called the **elimination–addition mechanism**.

Any nucleophile basic enough to remove the *ortho* proton can carry out this reaction. Known examples include oxyanions, amide anions (R_2N^-), and carbanions. The rather basic alkoxide *t*-butoxide will do the reaction on bromobenzene if the potassium salt is used in the dipolar aprotic solvent DMSO to maximize reactivity.

■ DMSO (see p. 255) solvates K^+ but not RO^- .

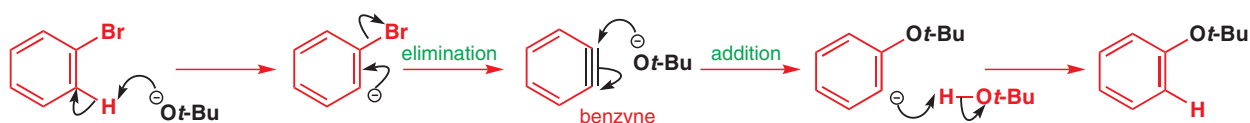

Interactive mechanism for benzyne formation and reaction

One rather special feature of the benzyne mechanism allows us to be certain that this proposed mechanism is correct, and this is the fact that the triple bond could in principle be attacked by nucleophiles at either end. This is of no consequence with bromobenzene as the products would be the same, but we can make the ends of the triple bond different and then we see something interesting. *ortho*-Chloro aryl ethers are easy to prepare by chlorination of the ether (Chapter 21). When these compounds are treated with $NaNH_2$ in liquid ammonia, a single amine is formed in good yield.

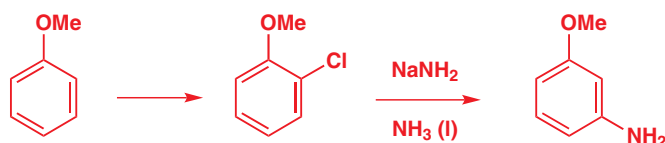

The new amino group finds itself in the *meta* position even though the chlorine was at the *ortho* position. It would be very difficult to explain this other than by the benzyne mechanism. Using the same elimination–addition sequence, this must be the mechanism:

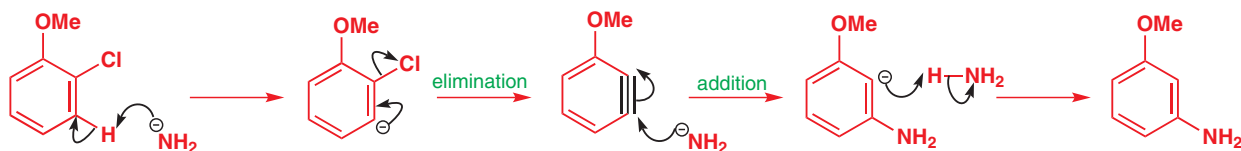

■ Steric hindrance is not nearly as important in electrophilic substitution or in nucleophilic substitution by the addition–elimination mechanism. In both of these reactions, the reagent is attacking the p orbital at *right angles* to the ring and is some distance from an *ortho* substituent.

That shows *how* the *meta* product might be formed, but *why* should it be formed? Attack could also occur at the *ortho* position, so why is there no *ortho* product? There are two reasons: electronic and steric. Electronically, the anion next to the electronegative oxygen atom is preferred because oxygen is inductively electron-withdrawing. The same factor facilitates deprotonation next to Cl in the formation of the benzyne. Sterically, it is better for the amide anion to attack away from the OMe group rather than come in alongside it. Nucleophilic attack on a benzyne has to occur in the plane of the benzene ring because that is where the orbitals are. This reaction is therefore very sensitive to steric hindrance as the nucleophile must attack in the plane of the substituent as well.

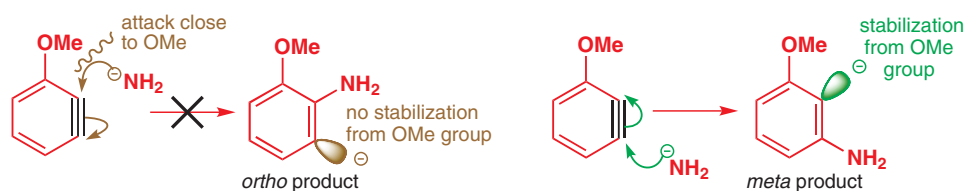

■ Oxygen is an electron-withdrawing group here because the anion is formed in the plane of the ring and has nothing to do with the benzene's π orbitals.

This is a useful way to make amino ethers with a *meta* relationship as both groups are *ortho*, *para*-directing and so the *meta* compounds cannot be made by electrophilic substitution.

para-Disubstituted halides can again give only one benzyne and most of them give mixtures of products. A simple alkyl substituent is too far from the triple bond to have much steric effect.

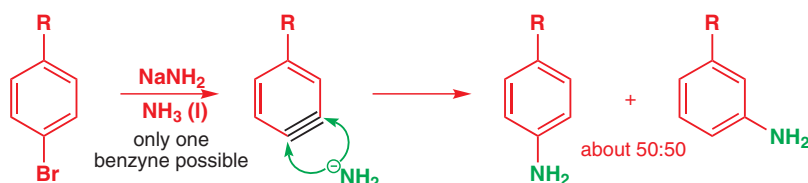

If the substituent is an electron-repelling anion, then the *meta* product is formed exclusively because this puts the product anion as far as possible from the anion already there. This again is useful as it creates a *meta* relationship between two *ortho*, *para*-directing groups.

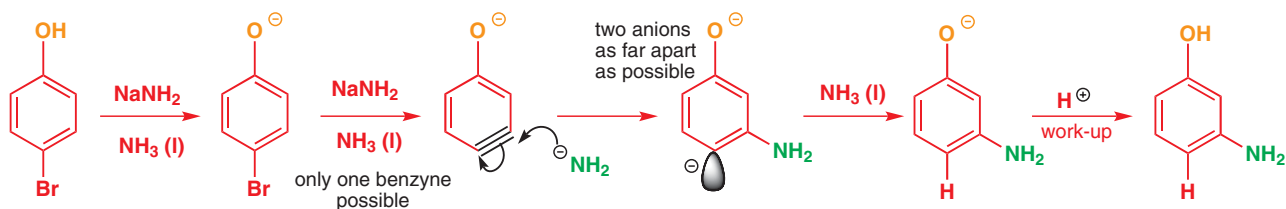

Other evidence for benzyne as an intermediate

As you would expect, the formation of benzyne is the slow step in the reaction so there is no hope of isolating benzyne from the reaction mixture or even of detect-

ing it spectroscopically. However, it can be made by other reactions where there are no nucleophiles to capture it, for example from this diazotization reaction.

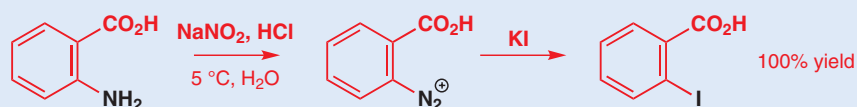

This diazotization is particularly efficient as you can see by the quantitative yield of 2-iodobenzoic acid on capture of the diazonium salt with iodide ion. However, if the same diazonium salt is neutralized with NaOH, it gives a zwitterion with the negative charge on the carboxylate balancing the positive charge

on the diazonium group. This diazotization is done with an alkyl nitrite in an organic solvent to avoid the chance that nucleophiles such as chloride or water might capture the product. When the zwitterion is heated it decomposes in an entropically favourable reaction to give carbon dioxide, nitrogen, and benzyne.

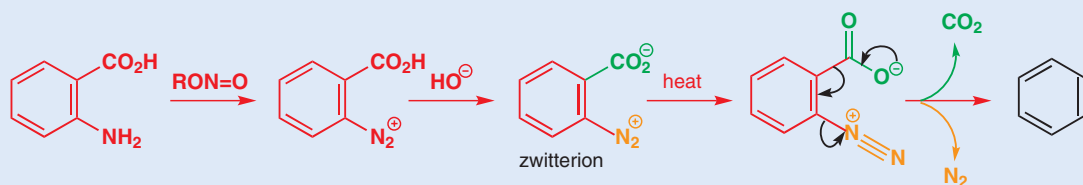

You can't isolate the benzyne because it reacts with itself to give a benzyne dimer having a four-membered ring between two benzene rings. If the zwitterion is injected into a mass spectrometer, there is a peak at 152 for the dimer

but also a strong peak at 76, which is benzyne itself. The lifetime of a particle in the mass spectrometer is about 2×10^{-8} s so benzyne can exist for at least that long in the gas phase.

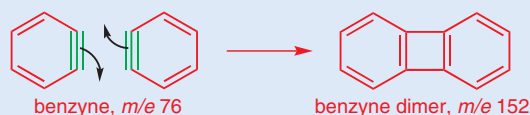

To conclude...

Alkenes and arenes are usually nucleophiles. This chapter is about the occasions on which they are not, and instead react as electrophiles. Remember that, important though the reactions in this chapter are, the principal reactivity you can expect from these compound classes is nucleophilicity.

The table below summarizes these reactions and also other similar ones you will find elsewhere in the book.

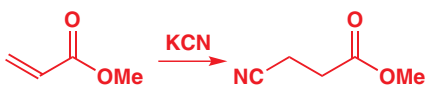
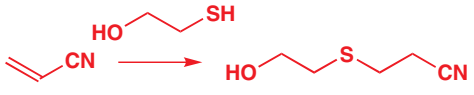
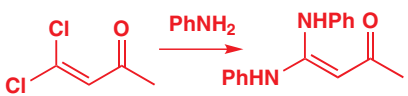
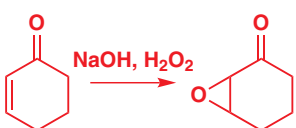
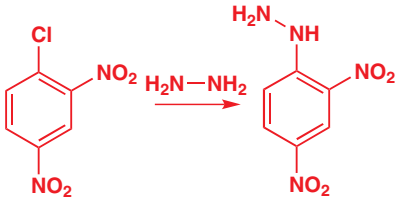
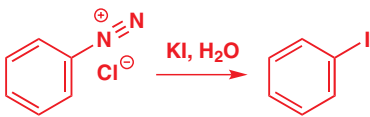
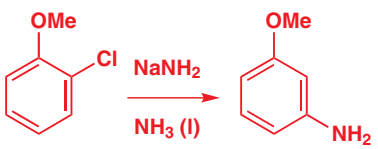
Page	Type of alkene	Example	Reaction
500	unsaturated carbonyl compounds		conjugate addition
510	unsaturated nitriles and nitroalkenes		conjugate addition
511	enones, etc. with β leaving group		conjugate substitution
513	unsaturated carbonyl		nucleophilic epoxidation
515	aryl chlorides/fluorides/ethers with <i>ortho</i> or <i>para</i> electron-withdrawing groups		nucleophilic aromatic substitution: addition-elimination mechanism
520	aryl cations (from diazonium salts)		nucleophilic aromatic substitution: S_N1 mechanism
525	benzyne		nucleophilic aromatic substitution: elimination-addition mechanism
ch. 26	enolates and enolate equivalents as nucleophiles		conjugate addition

Further reading

F. A. Carey and R. J. Sundberg, *Advanced Organic Chemistry A, Structure and Mechanisms*, 5th edn, Springer, 2007, chapter 9 and *B, Reactions and Synthesis*, chapter 11 also has a discussion of nucleophilic aromatic substitution. B. S. Furniss, A. J. Hannaford, P. W. G. Smith, and A. T. Tatchell, *Vogel's Textbook of Practical Organic Chemistry*, Longman, 5th edn, 1989, 6.6–6.7 gives many practical examples of the nucleophilic aromatic substitution. P. Wyatt and S. Warren, *Organic Synthesis: Strategy and Control*, Wiley, Chichester, 2007, chapter 9.

Check your understanding



To check that you have mastered the concepts presented in this chapter, attempt the problems that are available in the book's Online Resource Centre at <http://www.oxfordtextbooks.co.uk/orc/clayden2e/>

23

Chemoselectivity and protecting groups

Connections

➔ Building on

- Carbonyl addition and substitution [ch6](#), [ch10](#), & [ch12](#)
- Oxidation of alcohols [ch9](#)
- Mechanisms and catalysis [ch12](#)
- Electrophilic addition to alkenes [ch19](#)

Arriving at

- Regio-, stereo-, and chemoselectivity
- Reagents for reduction of alkenes and carbonyl compounds
- Removal of functional groups
- Reduction of benzene rings
- Reagents for oxidation of alcohols
- Reagents for oxidation of alkenes
- Protection of aldehydes, ketones, alcohols, and amines
- Synthesis of peptides

➔ Looking forward to

- Regioselectivity [ch24](#)
- Reactions of enolates [ch25](#) & [ch26](#)
- Sulfur chemistry [ch27](#)
- Retrosynthetic analysis [ch28](#)
- Cycloadditions [ch34](#)

Selectivity

Most organic molecules contain more than one functional group, and most functional groups can react in more than one way, so organic chemists often have to predict *which* functional group will react, *where* it will react, and *how* it will react. These questions are what we call *selectivity*.

Selectivity comes in three sorts: chemoselectivity, regioselectivity, and stereoselectivity. Chemoselectivity is *which* group reacts; regioselectivity is *where* it reacts. Stereoselectivity is *how* the group reacts with regard to the stereochemistry of the product.

● Selectivity

There are three main types of selectivity:

- chemoselectivity: *which* functional group will react (this chapter)
- regioselectivity: *where* it will react (Chapter 24)
- stereoselectivity: *how* it will react (stereochemistry of the products) (Chapters 32, 33, and 41)

We have talked a lot about regioselectivity, without calling it that, in the last two chapters. In Chapter 21 you learned how to predict and explain which product(s) you get from electrophilic aromatic substitution reactions. The functional group is the aromatic ring: *where* it reacts is the reaction's regioselectivity. In Chapter 22 you saw that nucleophilic addition to an unsaturated ketone can take place in a 1,2- or 1,4-fashion—the question of which happens (*where* the unsaturated ketone reacts) is a question of regioselectivity. We will address regioselectivity in much more detail in the next chapter.

Online support. The icon  in the margin indicates that accompanying interactive resources are provided online to help your understanding: just type www.chemtube3d.com/clayden/123 into your browser, replacing **123** with the number of the page where you see the icon. For pages linking to more than one resource, type **123-1**, **123-2** etc. (replacing **123** with the page number) for access to successive links.

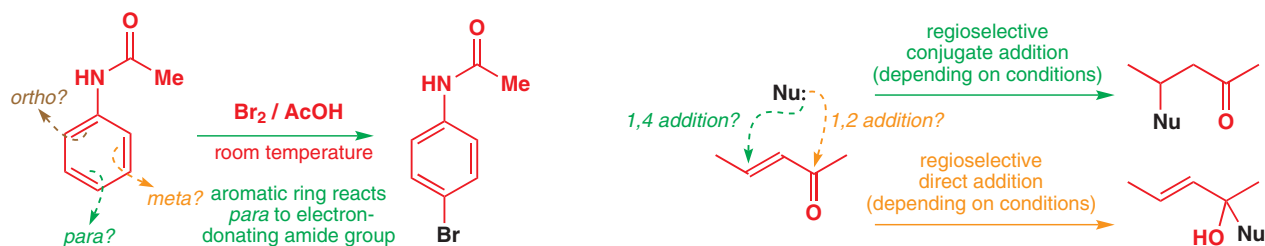

But this chapter is about *chemoselectivity*—in a compound with more than one functional group, which group reacts? Let's start with a straightforward example—the synthesis of the painkiller paracetamol. 4-Aminophenol could react with acetic anhydride at both nitrogen and oxygen to give a compound containing an amide and an ester functional group. This is what happens on heating with excess acetic anhydride (Ac_2O) in toluene.

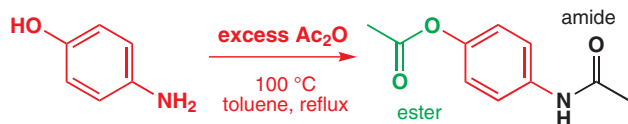

But with just one equivalent of acetic anhydride in the presence of a base (pyridine) only the NH_2 group is acylated, and paracetamol is the product. This is chemoselectivity, and it is to be expected that the NH_2 group is more nucleophilic than the OH group. It is even possible to hydrolyse the doubly acetylated product to paracetamol with aqueous sodium hydroxide. The ester is more reactive than the amide and hydrolyses much more easily. This is another chemoselective reaction.

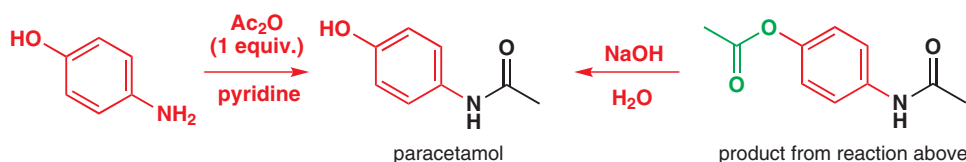

We know that ketones are more reactive towards Grignard reagents and organolithiums than esters because you can't isolate a ketone from the reaction of an ester with a Grignard reagent or an organolithium. Chemists at the pharmaceutical company Pfizer made use of this fact while they were developing anticonvulsants related to the tranquillizer oblivin. By adding lithium acetylide to ketones, they were able to make a tertiary alcohol by chemoselective reaction of a ketone in the presence of an ester.

ketone is more electrophilic than ester

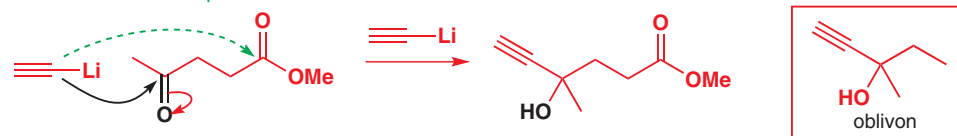

These last two reactions work because, although each starting material contains two carbonyl groups, one is more electrophilic and therefore more reactive towards nucleophiles (OH^- in the first case; lithium acetylide in the second) than the other. We can order carbonyl compounds into a sequence in which it will *usually* be possible to react those on the left with nucleophiles in the presence of those on the right.

• Reactivity towards nucleophiles

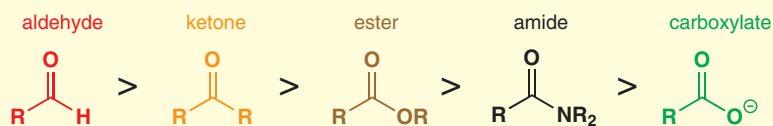

➔ Why amines are more nucleophilic than alcohols and why esters are more reactive than amides was all explained in Chapter 10.

➔ In Chapter 10 we devoted some time to what you *can* react with an organometallic compound to get a ketone (p. 218).

We've already discussed this sequence of reactivity in relation to acid derivatives in Chapter 10—make sure you understand the reason for the ordering of ester > amide > carboxylate. Here we're adding to the list aldehyde (the most reactive, for steric reasons—it is the least hindered) and ketone (more reactive than esters because the carbonyl group is not stabilized by conjugation with a lone pair).

Reducing agents

Chemists at Glaxo exploited this reactivity sequence in their synthesis of the anti-asthma drug salmefamol (sister compound to the bestseller salbutamol). Three reducing agents are used in the sequence: sodium borohydride (NaBH_4), hydrogen gas over a palladium catalyst, and lithium aluminium hydride (LiAlH_4).

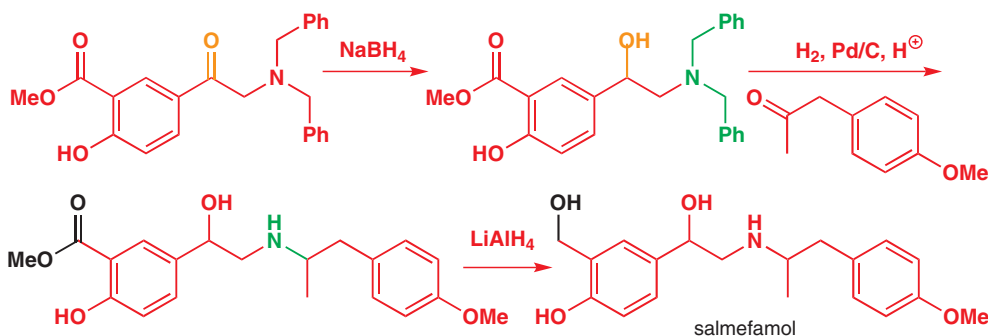

Why not use LiAlH_4 all the time?

In general, it's best to use the mildest conditions possible for any particular reaction—the potential for unwanted side-reactions is lessened. What is more, NaBH_4 is a lot easier to handle than LiAlH_4 —for example, it simply dissolves in water while LiAlH_4 catches fire if it gets wet. NaBH_4 is usually used to reduce aldehydes and ketones, even though LiAlH_4 also works.

We shall use this synthesis as a basis for discussion on chemoselectivity in reductions. In the first step, sodium borohydride leaves the carbonyl group of the ester untouched while it reduces the ketone (in orange); in the last step, lithium aluminium hydride reduces the ester (in black). These chemoselectivities are typical of these two most commonly used reducing agents: borohydride can usually be relied upon to reduce an aldehyde or a ketone in the presence of an ester, while lithium aluminium hydride will reduce almost any carbonyl group.

■ It is worth noticing that *all* of the reducing agents for carbonyl groups described in this section are hydrides of boron or aluminium.

Reduction of carbonyl groups

We should now look in detail at reductions of carbonyl compounds, and in doing so we shall introduce a few more specialized reducing agents. Then we will come back to the other type of reduction in the salmefamol synthesis—catalytic hydrogenation.

How to reduce aldehydes and ketones to alcohols

We don't need to spend much time on this—sodium borohydride, which you met in Chapter 6, does it very well. Sodium borohydride will reduce only in protic solvents (usually ethanol or methanol) or in the presence of electrophilic metal cations such as Li^+ or Mg^{2+} (LiBH_4 can be used in THF, for example). The mechanism follows a course which can be represented like this.

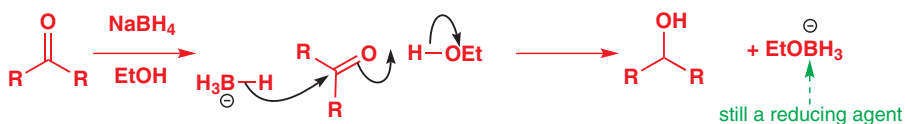
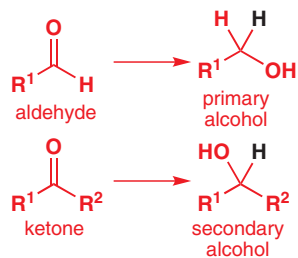

The essence of the reaction is the transfer of a hydrogen atom with two electrons (called **hydride transfer**, although no hydride ion is involved) from boron to carbon. The developing

negative charge on oxygen is protonated by the alcohol, and resulting alkoxide adds to the boron during or immediately after the reduction. The by-product, an alkoxyborohydride anion, is itself a reducing agent, and can go on to reduce three more molecules of carbonyl compound, transferring step-by-step all of its hydrogen atoms.

How to reduce esters to alcohols

LiAlH_4 is often the best reagent, and gives alcohols by the mechanism we discussed in Chapter 10 (p. 217). As a milder alternative (needed because LiAlH_4 has caused countless fires through careless handling), lithium borohydride in alcoholic solution will reduce esters—in fact, it has useful selectivity for esters over acids or amides that LiAlH_4 does not have. *Sodium* borohydride reduces most esters only very slowly.

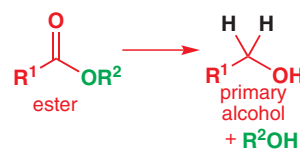
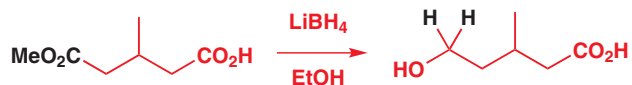

Why not try writing the mechanism out now for this reaction to make sure you understand it, before checking back to p. 217. In a moment, we will show you a slightly more sophisticated version, in which we account for the fate of the Li and Al species.

How to reduce amides to amines

Again, LiAlH_4 is a good reagent for this transformation. The mechanism follows a similar course to the reduction of esters: both are written out in detail below, and there is a key difference at the steps boxed in orange and in green. In the orange box, loss of alkoxide from the tetrahedral intermediate forms an aldehyde, which is reduced further. This doesn't happen with amides; instead the anionic oxygen is lost—assisted by coordination to aluminium—to form an iminium ion. A good alternative for the reduction of amides to amines is borane (BH_3), described in the next section.

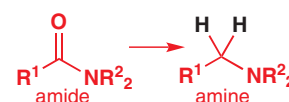

The mechanism for ester reduction here has rather more detail than the simplified one we presented to you in Chapter 10.

LiAlH_4 reduction of esters

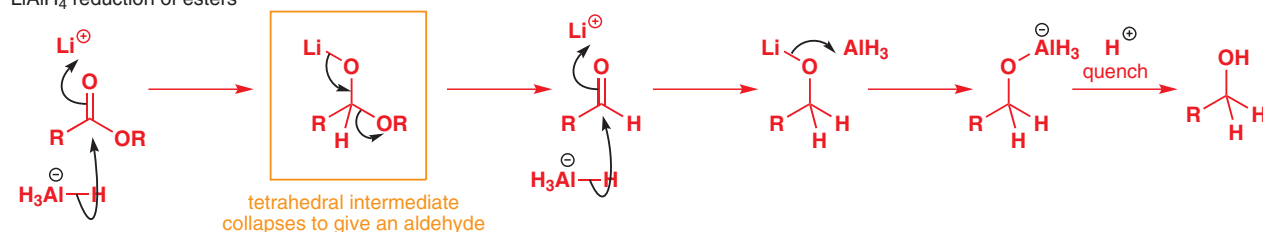

LiAlH_4 reduction of amides

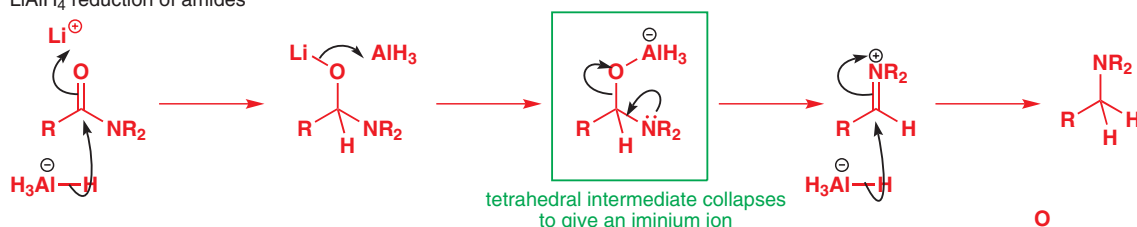

How to reduce carboxylic acids to alcohols

The best reagent for this is borane, BH_3 . Borane is, in fact, a gas with the structure B_2H_6 , but it can be 'tamed' as a liquid by complexing it with ether (Et_2O), THF, or dimethyl sulfide (DMS , Me_2S).

Although borane appears superficially similar to borohydride, it is not charged, and that makes all the difference to its reactivity. Whereas borohydride reacts best with the most electrophilic carbonyl groups, borane's reactivity is dominated by its desire to accept an electron pair into the boron's empty p orbital. In the context of carbonyl group reductions, this means that **borane reduces electron-rich carbonyl groups fastest**. The carbonyl groups of

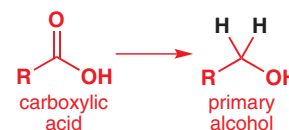

These complexes are formed when BH_3 , a Lewis acid, accepts a lone pair of electrons from the ether or sulfide—a Lewis base. Lewis acids and bases were described on p. 180.

acyl chlorides and esters are relatively electron-poor (Cl and OR are very electronegative); borane will not touch acyl chlorides and reduces esters only slowly. But it will reduce very effectively both carboxylic acids and amides.

■ This 'sharing' of lone pair between two conjugating groups is also the reason why anhydrides are more reactive than esters (see p. 206).

Borane reacts with carboxylic acids first of all to form triacylborates, with evolution of hydrogen gas. Esters are usually less electrophilic than ketones because of conjugation between the carbonyl group and the lone pair of the sp^3 hybridized oxygen atom—but, in these boron esters, the oxygen next to the boron has to share its lone pair between the carbonyl group and the boron's empty p orbital, so they are considerably more reactive than normal esters.

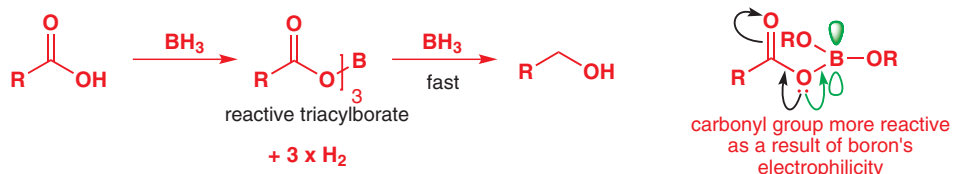

Borane is a highly chemoselective reagent for the reduction of carboxylic acids in the presence of other reducible functional groups such as esters, and even ketones.

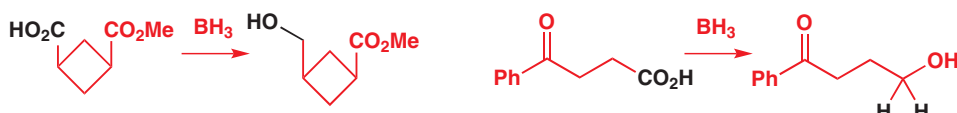

Borane and lithium borohydride are a most useful pair of reducing agents, with opposite selectivities. Japanese chemists used an enzyme to make a single enantiomer of the acid below, and were able to reduce either the ester or the carboxylic acid by choosing lithium borohydride or borane as their reagent. Check for yourself that the lactones (cyclic esters) in black frames are enantiomers.

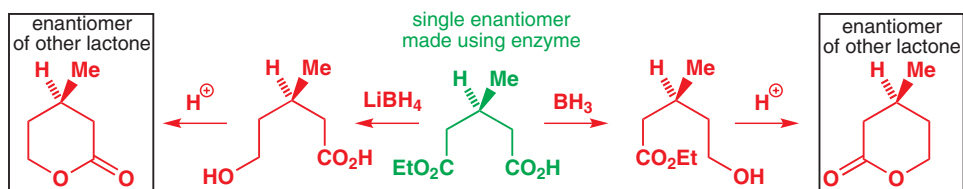

Because borane reacts well with electron-rich carbonyl groups, it is also a good alternative to $LiAlH_4$ for reducing amides to amines, and is chemoselective even in the presence of an ester:

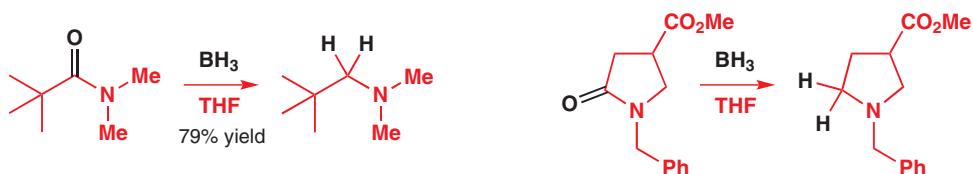

The carbonyl group of an amide is electron-rich because it receives electron density from the delocalized N lone pair. It therefore complexes well with the empty p orbital of the Lewis acidic borane. Hydride transfer is then possible from anionic boron to electrophilic carbon. The resulting tetrahedral intermediate collapses to an iminium ion that is reduced again by the borane.

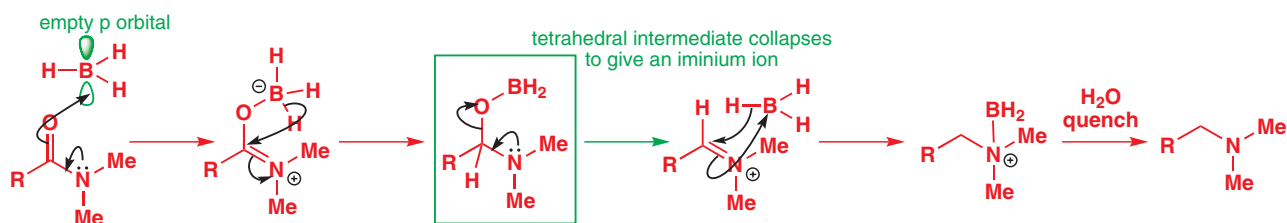

How to reduce esters or amides to aldehydes

The step boxed in orange in the ester reduction scheme on p. 531 gave an aldehyde. The aldehyde is more readily reduced than the ester, so the reduction doesn't stop there, but carries on to the alcohol oxidation level. How, then, can you reduce an ester to an aldehyde? This is a real problem in synthetic chemistry—the ester below, for example, is easy to make by methods you will meet in Chapter 25, but an important synthesis of the antibiotic monensin requires the aldehyde.

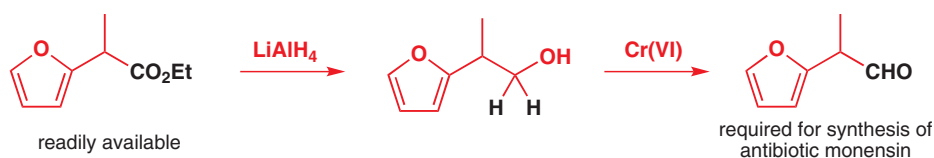
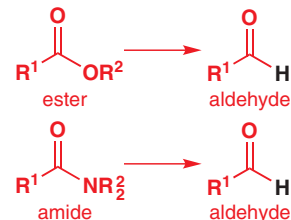

In this case, the chemists decided simply to put up with the fact that LiAlH_4 gives the alcohol, and oxidize the alcohol back to the aldehyde using chromium(VI), the oxidant you met in Chapter 9 (p. 194). There is, however, a reagent that will sometimes do the job in a single step, although you must bear in mind that this is not at all a general reaction. The reagent is known as DIBAL or DIBALH—diisobutyl aluminium hydride, $i\text{-Bu}_2\text{AlH}$.

DIBAL is an alane: its structure is shown in the margin. Its chemistry is in many ways like borane—it exists as a bridged dimer, and it becomes a reducing agent only after it has formed a Lewis acid–base complex, so like borane it too reduces electron-rich carbonyl groups most rapidly. DIBAL will reduce esters even at -70°C , and at this temperature the tetrahedral intermediate, formed by the transfer of hydride from aluminium to carbon (and shown below), may be stable. Only in the aqueous work-up does it collapse to the aldehyde. This step also destroys any excess DIBAL so no further reduction is possible.

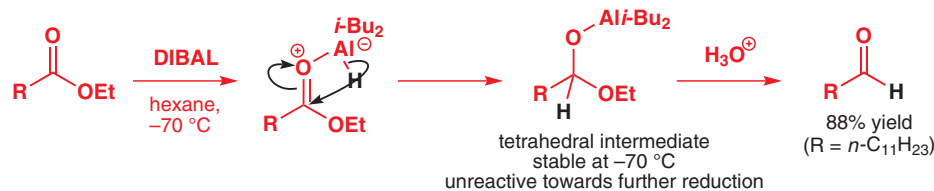
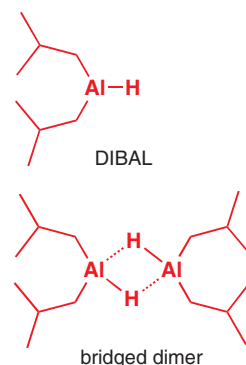

Lactols from lactones

A stable tetrahedral intermediate is more likely in the reduction of lactones, for the same reasons that cyclic hemiacetals are more stable than acyclic ones. DIBAL is most reliable in the reduction of lactones to cyclic hemiacetals (also known as lactols), as in this reaction from E. J. Corey's synthesis of the prostaglandins.

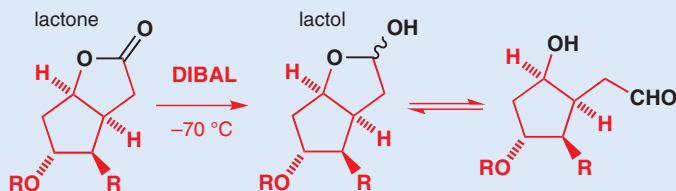

Higher temperatures are needed to promote collapse to the iminium.

In the amide reduction scheme on p. 533, the step framed in green gives an iminium ion. Stopping the reaction before the iminium ion forms would therefore provide a way of making aldehydes from amides because in the absence of the aluminium, this tetrahedral intermediate collapses to an aldehyde. Because tetrahedral intermediates like these formed during amide reduction are rather more stable than those from ester reduction, this can often be achieved simply by carrying out the amide reduction and quenching with water, all at 0 °C.

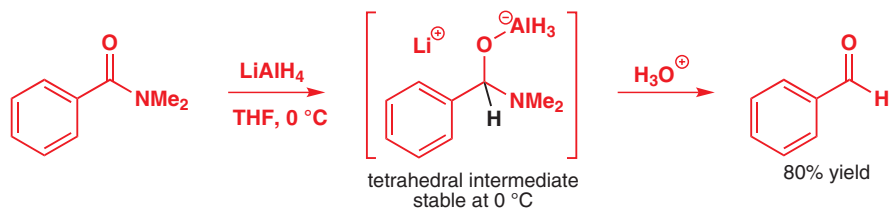

DIBAL is also good for reducing nitriles to aldehydes. Indeed, this reaction and the reduction of lactones to lactols (see box above) are the best things that DIBAL does.

Carboxylic acids can be reduced to aldehydes via their acyl chlorides using the Rosenmund reaction—see below.

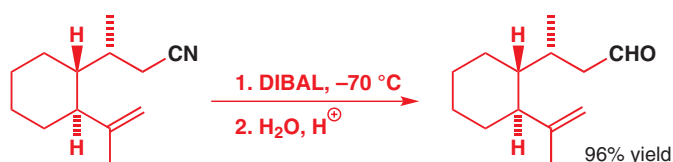

The box below summarizes the chemoselectivity of all of these reagents.

Also included is sodium cyanoborohydride, which as you saw in Chapter 11 reduces imines but not carbonyl compounds.

Summary of reducing agents for carbonyl groups

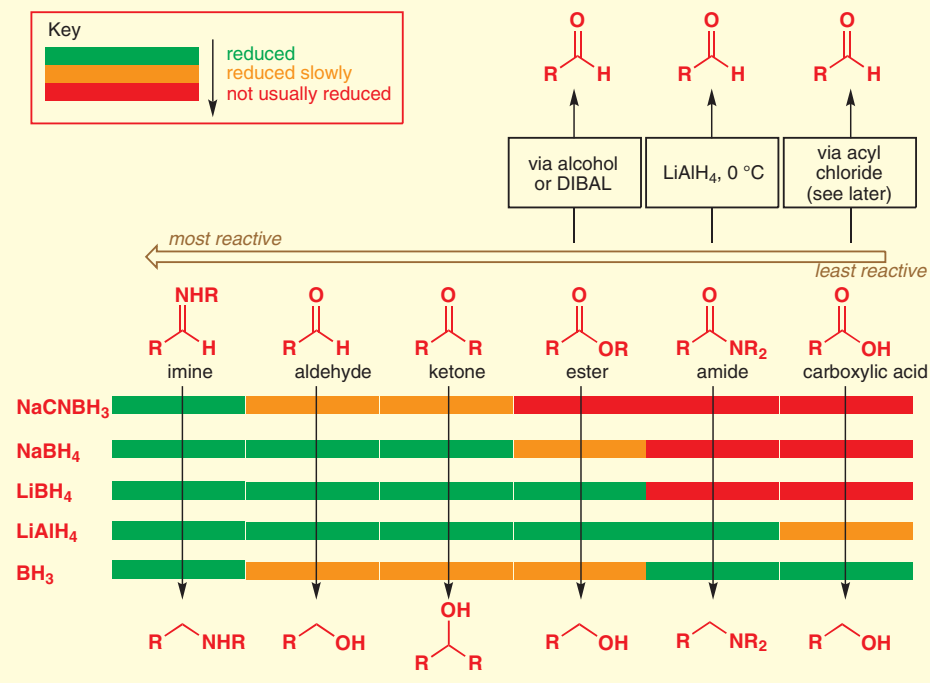

Hydrogen as a reducing agent: catalytic hydrogenation

➔ You will meet some exceptions in Chapter 41.

The simplest reducing agent is hydrogen itself, H₂. Hydrogen can't generally be used as a reducing agent for carbonyl compounds—it isn't nucleophilic enough. However, it can act as

a reducing agent for other, weaker, double and triple bonds, such as $C=C$, $C=N$, $C\equiv C$ and $C\equiv N$. To do these reactions, a metal catalyst is required and the process is known as catalytic hydrogenation. The hydrogen is provided by a cylinder, perhaps via a balloon, or can be made by electrolysis and pumped with the substrate over the catalyst. In the example below, the alkene is reduced while the aldehyde remains untouched.

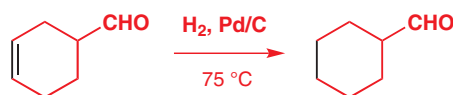

The catalysts used to make hydrogen react with double bonds are transition metals: usually palladium (as in this example) or platinum, but sometimes nickel, rhodium, or ruthenium. We will talk about several different reductions in this section, but the mechanisms of all of them are similar, and very different from those involved in carbonyl reductions.

Catalytic hydrogenation takes place on the surface of the metal. The metal must therefore be finely divided, and is usually dispersed on the surface of an inert support. This is what 'Pd/C' means—finely divided palladium carried on a charcoal support. The first step is chemical absorption of hydrogen onto the metal surface, a process that results in breakage of the H–H bonds and distributes hydrogen atoms where they can react with the organic substrate. Now the alkene can also bond to the metal, and hydrogen can be transferred from the metal to the alkene.

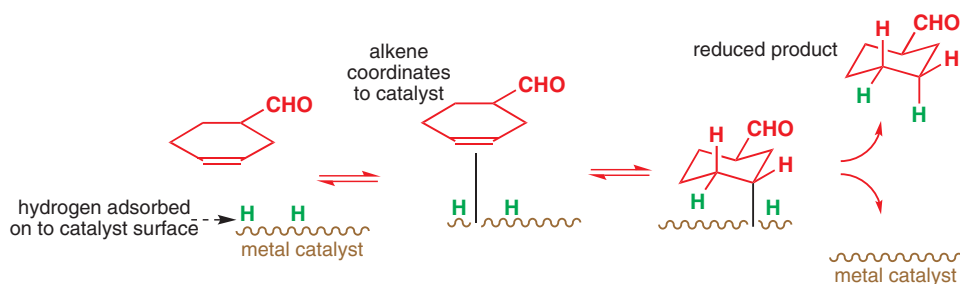

Palladium on charcoal

Palladium on charcoal (Pd/C) is usually 5–10% by mass Pd and 90–95% C. It is made by suspending charcoal powder in a $PdCl_2$ solution, and then reducing the $PdCl_2$ to Pd metal, usually with H_2 gas, but sometimes with formaldehyde, $HCHO$ (which is oxidized to formic acid, HCO_2H). The palladium metal precipitates on to the charcoal, which can be filtered off and dried. The fine Pd particles present maximum surface area to the reaction they catalyse and, while Pd is an expensive metal, it is recyclable since the Pd/C is insoluble and can be recovered by filtration.

➔ We will look in more detail at the ways alkenes bond with metals in Chapter 40.

How to reduce alkenes to alkanes

Hydrogenation with a palladium or a platinum catalyst is the most common way of reducing alkenes. You may find our mechanism rather unsatisfactory, but it is hard to draw curly arrows for the reactions involved here. There is, however, plenty of evidence that the hydrogenation occurs like this, for example the alkene below reacts in such a way that the major product receives both hydrogen atoms on the same face of the molecule—just what we would expect from a reaction at a surface.

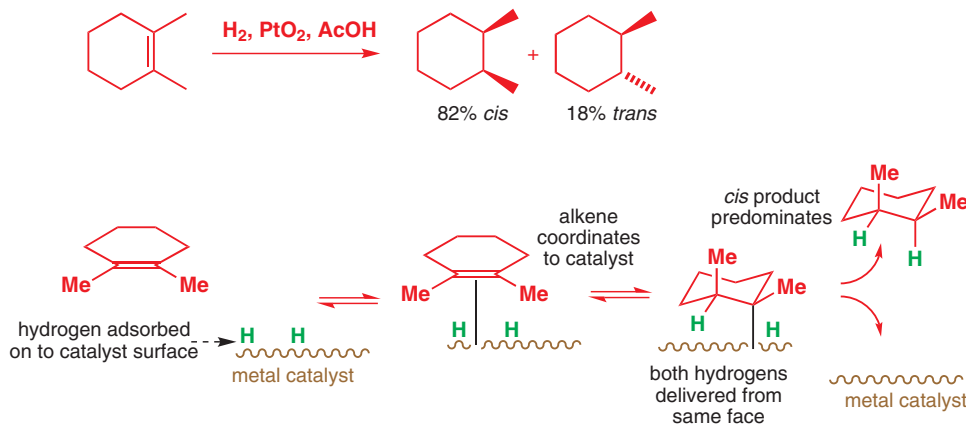

■ PtO_2 , platinum oxide, is known as Adams' catalyst. The actual catalyst is not the oxide but Pt metal formed by reduction of PtO_2 to Pt during the hydrogenation.

Hydrogenated vegetable oil

Plants such as soya, rapeseed, cottonseed, and sunflower are useful sources of edible vegetable oils, but these oils are unsuitable as butter substitutes because of their low melting points. Their low melting points relative to animal fats are largely due to *cis* double bonds that disrupt the packing of the alkyl chains in

the solid state. Treating the crude vegetable oil with hydrogen over a metal catalyst removes some of these double bonds, increases the proportion of saturated fat in the oil, and raises its melting point, making it suitable for making margarine.

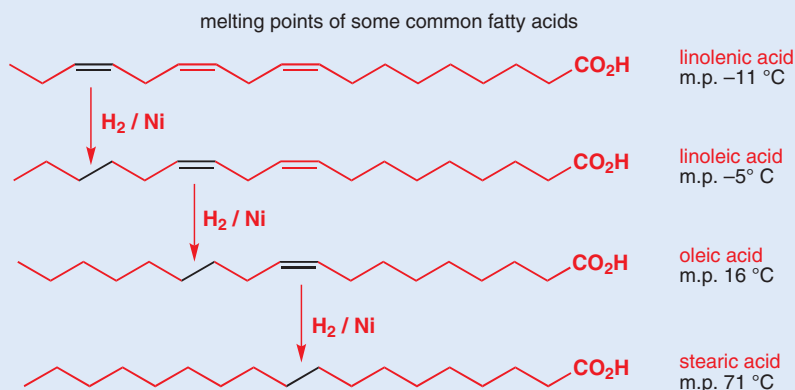

The reaction is usually stopped before all the double bonds are hydrogenated, of course: margarine manufacturers are desperate to tell us that their products are still 'high in unsaturated fatty acids'. Many also advertise that they are 'low

in *trans* unsaturated fatty acids' because of a suggested link between incidence of coronary heart disease and *trans* unsaturated fatty acid intake.

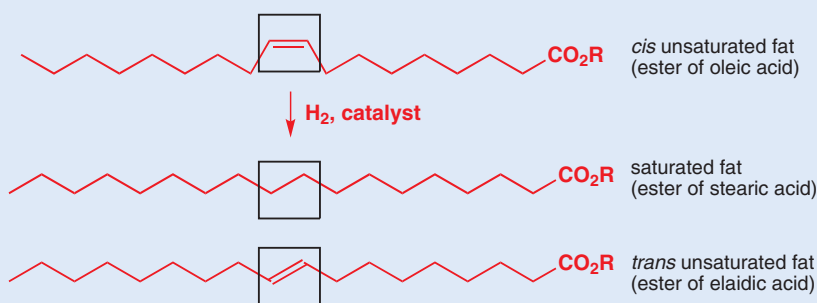

Where have these *trans* double bonds come from? Well, partial hydrogenation can lead to significant double-bond isomerization, not just to regioisomers but

to geometrical isomers too.

How to reduce α,β -unsaturated carbonyl compounds

It should not now surprise you that regioselective reduction of the C=C double bond of an α,β -unsaturated carbonyl compound is best done using catalytic hydrogenation as the C=C bond is more susceptible to hydrogenation than the C=O bond. The flavouring compound known as raspberry ketone is made by this method.

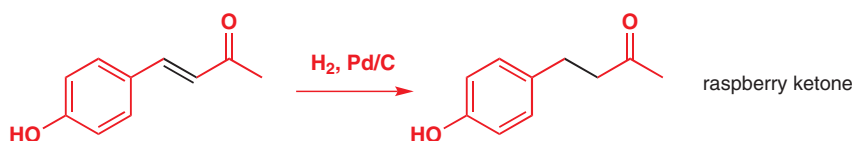

➔ See Chapter 22 for a discussion of the reactivity of α,β -unsaturated carbonyl compounds.

But what if you want instead to reduce the C=O group selectively? You should immediately think of using NaBH_4 . But in Chapter 22 we pointed out that hydride reducing agents in general are not good choices for the selective reduction of the C=O bond of unsaturated carbonyl compounds because they tend to add to the double bond as well, giving first the saturated carbonyl compound, which is then reduced to the alcohol. The way to get regioselective addition directly to the carbonyl group is to use NaBH_4 in the presence of a hard, Lewis-acidic metal salt, such as CeCl_3 . This combination of reagents is known as the **Luche reduction**.

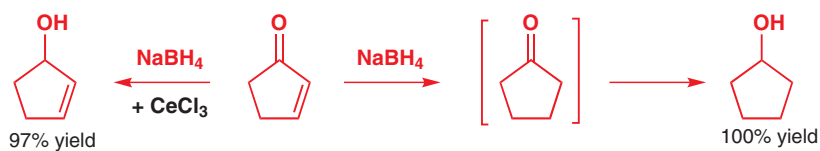

How to reduce benzene rings to cyclohexanes

Even aromatic rings can be hydrogenated in preference to C=O groups: in these examples the ester and acid survive while phenyl is reduced to a cyclohexyl group.

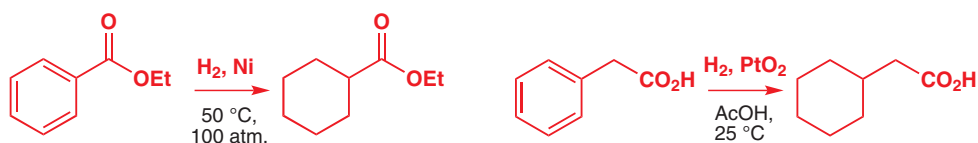

The catalyst used in each reduction can be a matter of trial and error, and it is difficult to predict which metal will be most successful—generally Pt, Rh, or Ni is used for arenes.

How to reduce alkynes to alkenes

A catalyst known as **Lindlar's catalyst** (which you will meet again in Chapter 27) is used to reduce alkynes to alkenes, but does not easily reduce alkenes to alkanes. This requires rather subtle chemoselectivity: alkenes are usually hydrogenated at least as fast as alkynes, so we need to be sure the reaction stops once the alkene has been formed. The Lindlar catalyst is a palladium catalyst (Pd/CaCO₃) deliberately poisoned with lead. The lead lessens the activity of the catalyst and makes further reduction of the alkene product slow: most palladium catalysts would reduce alkynes all the way to alkanes. Best selectivities are obtained if quinoline is also added to the reaction, and alkyne to alkene reductions work with Pd/BaSO₄ + quinoline too. Even so, Lindlar reactions often have to be monitored carefully to make sure that over-reduction is not taking place.

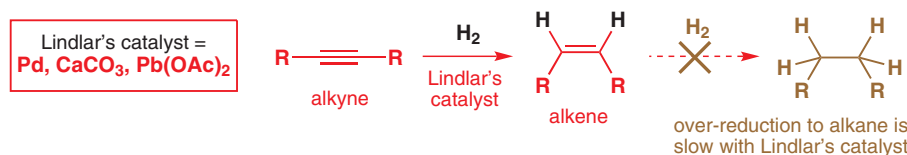

How to reduce acid chlorides to aldehydes

Catalytic hydrogenation is often chosen as a method for reduction because of its chemoselectivity for C=C over C=O groups, and an important hydrogenation involving a carbonyl compound is not actually a reduction of the C=O double bond. Hydrogenation of acyl chlorides gives aldehydes in a reaction known as the **Rosenmund reaction**—really a hydrogenolysis of a C–Cl bond.

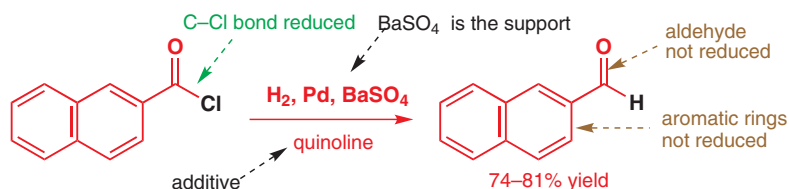

This is a good way of reducing compounds at the carboxylic acid oxidation level to aldehydes, which is why we included it in the table of carbonyl reductions on p. 534.

Hydrogenation sometimes requires high pressures of hydrogen—100 atmospheres in the reaction on the left. These reactions are carried out in a sealed apparatus known as a Parr hydrogenator, or using hydrogen generated electrolytically and pumped at high pressure within a flow system.

Raney nickel

Nickel is often used for hydrogenation in a finely divided form known as Raney nickel. Raney nickel is made from a nickel–aluminium alloy. The aluminium is dissolved away using concentrated aqueous sodium hydroxide, leaving the nickel as a fine powder. The process liberates H₂, and some of this hydrogen remains adsorbed on the nickel catalyst. This means that some hydrogenations, particularly those of C–S bonds, which you will come across later in this chapter, can be carried out just by using freshly prepared Raney nickel, with no added H₂. Raney nickel is abbreviated to RaNi—nothing to do with radium, note!

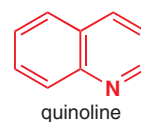

■ You will notice too that the catalyst support is different: Pd/BaSO₄ rather than Pd/C. BaSO₄ (and CaCO₃) are commonly used as supports with more easily reduced substrates because they allow the products to escape from the catalyst more rapidly and cut down over-reduction.

The quinoline is needed both to neutralize the HCl produced in the reaction and to moderate the activity of the catalyst, preventing over-reduction.

Reductive amination by catalytic hydrogenation

The unreactivity of carbonyl groups towards catalytic hydrogenation allows us to use hydrogenation in a similar way to sodium cyanoborohydride to carry out reductive aminations of amines and carbonyl compounds. For example, in the synthesis of salmefamol we presented on p. 530, one step involves the formation of the imine from an amine and a ketone in the presence of acid, hydrogen, and a palladium catalyst. The imine (in its protonated iminium form) is hydrogenated to yield an amine, while the ketone (and the aromatic systems) remains untouched.

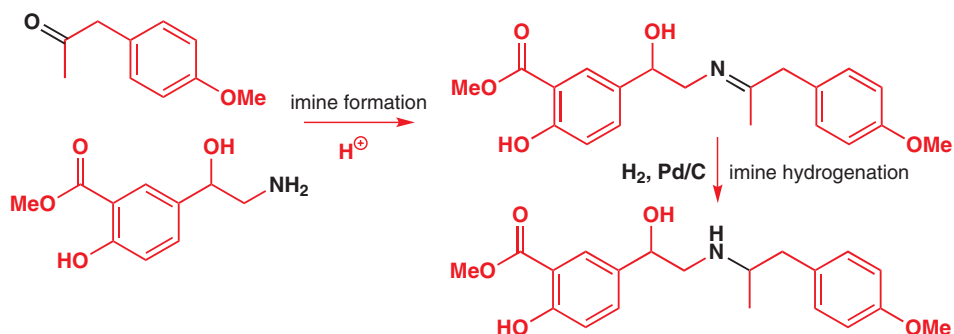

How to reduce nitro groups to amines

In Chapters 21 and 22 we saw how the sequence of nitration of aromatic rings followed by reduction was a useful route to aromatic amines. The reduction of the nitro group can be carried out by Sn/HCl but catalytic hydrogenation is much simpler. The reaction is usually done in ethanol with a Pd or Pt catalyst, and it may be necessary to add a weak acid to prevent the amine produced from poisoning the catalyst. The real gain over the Sn/HCl method is in the work-up. Instead of separating and disposing of voluminous toxic tin residues, a simple filtration to remove the catalyst, evaporation, and crystallization or distillation gives the amine.

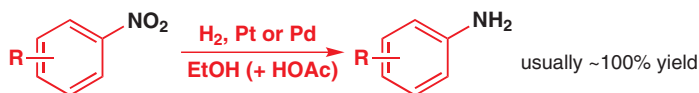

Hydrogenolysis: breaking C–O and C–N bonds

In the reductive amination above we skirted over the fact that the starting amine in the synthesis of salmefamol (look back at p. 530) in fact carries two benzyl groups, which disappear during the hydrogenation.

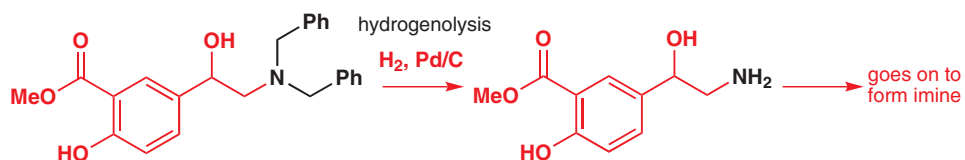

What happens to them is a **hydrogenolysis**—a reaction that is liable to occur under catalytic hydrogenation conditions whenever a heteroatom (in particular O or N) finds itself bonded to a carbon atom *adjacent* to a benzene ring, in other words with benzylic amines, alcohols or ethers.

➔ You met reductive amination with sodium cyanoborohydride in Chapter 11, p. 234.

➔ For the use of nitroarenes in the synthesis of aromatic compounds, see pp. 521 and 576.

Benzyl and allyl

Here is a good place to remind you of the difference between a benzyl or allyl group on one hand, which are attached via an sp^3 C atom, and a phenyl or vinyl group on the other, where the bond is directly to an sp^2 C atom. You first met these groups in Chapter 2, p. 42.

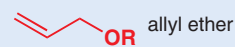
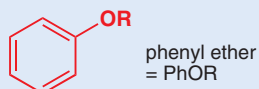
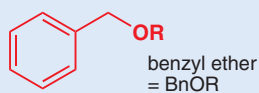

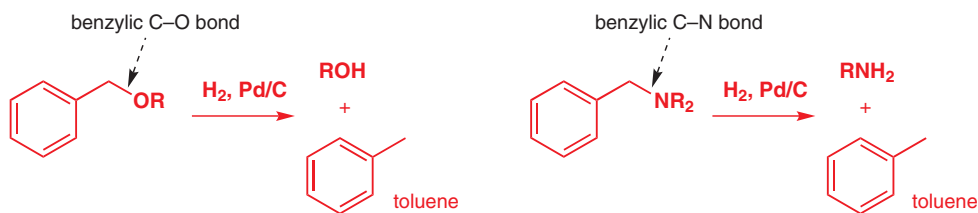

Hydrogenolysis happens under similar conditions to alkene hydrogenation, but involves breakage of a C–O or C–N σ bond rather than a C=C π bond. It is particularly important for removing benzyl protecting groups, to which we will return later in the chapter.

- We can draw up a sequence of reactivity towards hydrogenation. The precise ordering varies with the catalyst, and some catalysts are particularly selective towards certain classes of compound—for example, Pt, Rh, and Ru will selectively hydrogenate aromatic rings in the presence of benzylic C–O bonds, while with Pd catalysts the benzylic C–O bonds are reduced faster.

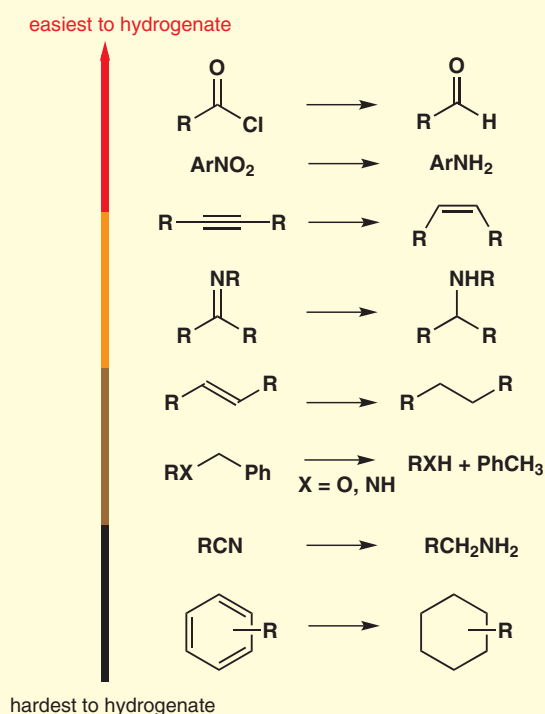

Getting rid of functional groups

Functional groups can be useful for putting a molecule together, but they aren't always needed in the final product. We need ways of getting rid of them. Hydrogenation of alkenes is one way that you have seen. Hydrogenation of alkynes to alkanes is very useful because we can build long chains of carbon atoms by alkylating alkynes, then hide the evidence by hydrogenation:

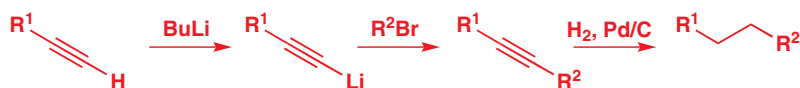

■ The hydrogenation uses Pd/C, not the Lindlar catalyst of course, because we want to go all the way to the alkane.

Alcohols can be got rid of either by elimination to alkenes and then hydrogenation or by tosylation and substitution using borohydride to provide a nucleophilic hydrogen atom.

■ Lithium triethylborohydride is used here—it is particularly good at these S_N2 substitutions—but other powerful hydride reducing agents work too.



Removal of carbonyl groups is harder, although there are several possible methods. C–O bonds are strong, but C–S bonds are much weaker and are often easily reduced with Raney nickel. We can get rid of aldehyde and ketone carbonyl groups by making them into **thioacetals**, sulfur analogues of acetals, formed in a reaction analogous to acetal formation (see Chapter 11) but using a dithiol with a Lewis acid catalyst. Freshly prepared Raney nickel carries enough H_2 (p. 537) to reduce the thioacetal without added hydrogen.

■ This is sometimes known as the **Mozingo reaction**.

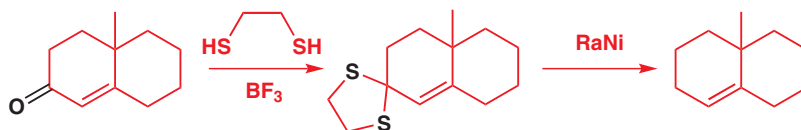

A slightly more vigorous method, known as the **Wolff–Kishner reduction**, is driven by the elimination of nitrogen gas from a hydrazone. Hot concentrated sodium hydroxide solution deprotonates the hydrazone, which can then lose nitrogen to form an alkyl anion, which is immediately protonated by water.

Interactive mechanism for Wolff–Kishner reduction

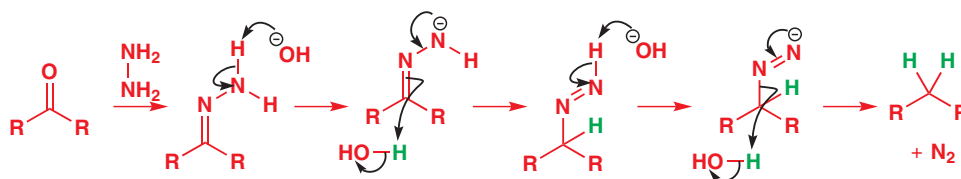

The third method is the simplest to do, but has the most complicated mechanism. The **Clemmensen reduction** is also rather violent, and really reasonable only for compounds with just the one functional group. It uses zinc metal dissolving in concentrated hydrochloric acid. As the metal dissolves, it gives up two electrons—in the absence of something else to do, these electrons would reduce the H^+ in the acid to H_2 , and give ZnCl_2 and H_2 . But in the presence of a carbonyl compound, the electrons go to reduce the C=O bond.

■ You saw this reaction in Chapter 21 as a useful way of turning acylated arenes of the type that are easy to make by Friedel–Crafts acylation into alkylated arenes of the type that are hard to make by Friedel–Crafts alkylation.

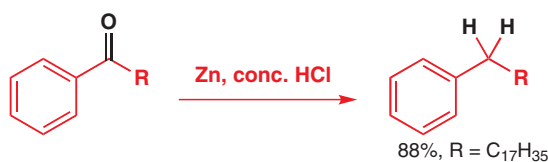

The mechanism has a good deal in common with a whole class of reductions, of which the Clemmensen is a member, known as **dissolving metal reductions**. We shall now look at these as our third (after metal hydrides and catalytic hydrogenation) important class of reducing agents.

Two synthetic routes to muscalure—the house fly pheromone

Many insects attract a mate by releasing a volatile organic compound known as a pheromone. Pheromones are highly specific to species and provide a cunning means of controlling pests: place a pad of cotton wool soaked in male pheromone inside a trap and in drop all the female pests—no next generation. If insect control is to rely on a supply of the pheromone, that supply has to be synthetic—it takes enormous numbers of squashed insects to provide even a few milligrams of most pheromones.

Two syntheses of the very simple pheromone of a very common insect—the house fly—provide an illustration of how to use two of the reduction methods we have just described. The pheromone, known as muscalure, is a Z-alkene.

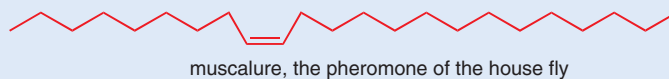

One approach, used by some American chemists in the early 1970s, was very simple. These chemists noted the similarity between the structures of muscalure and the fatty acid known as erucic acid, which is abundant in rapeseed oil, and decided to make muscalure from erucic acid. They first reacted the acid with

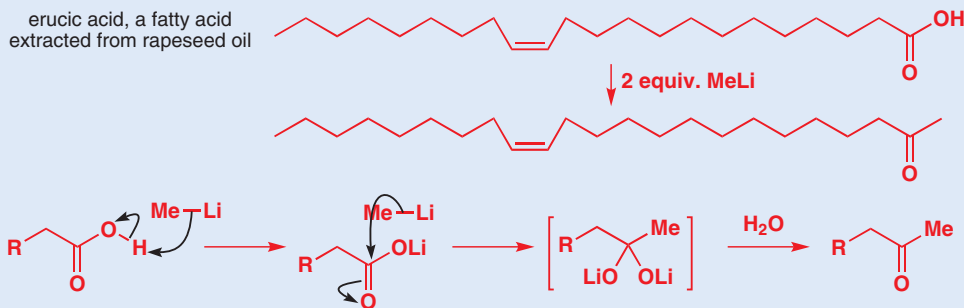

two equivalents of methyl lithium—the first equivalent deprotonates the acid to make a lithium carboxylate salt, while the second reacts with the lithium carboxylate to make a ketone (see p. 219).

The next step is to remove the ketone functional group. The method chosen was the Wolff–Kishner reaction described on p. 540: make a hydrazone and



heat in the presence of base. Muscalure is the product.

Later some Russian chemists made the same compound by a different route. They chose to introduce the *Z* double bond by hydrogenation of an alkyne over Lindlar's catalyst (p. 537). To make the alkyne they needed, they took 1-decyne,

treated it with LiNH_2 to remove the acidic terminal proton, and reacted the anion with an *n*-alkyl bromide. By stirring the alkyne with Lindlar's catalyst under an atmosphere of hydrogen they were able to make muscalure.

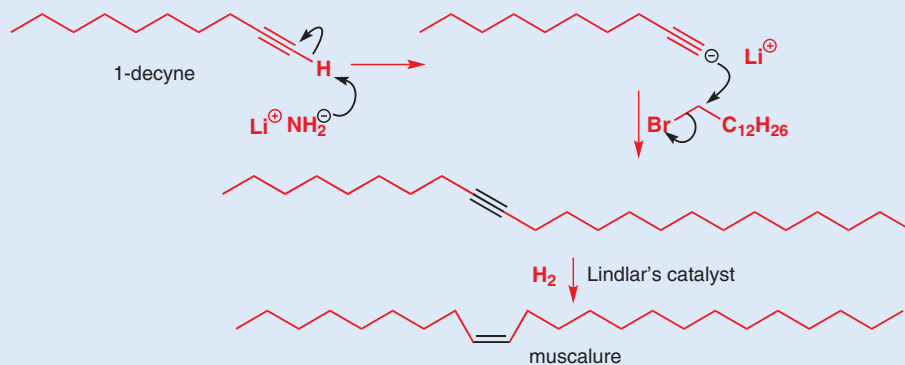

Dissolving metal reductions

You will be familiar with the idea that many metals react with acid to liberate hydrogen, forming a salt at the same time. There is an example in the margin. The metal cation (Mg^{2+} in this example) results from the loss of electrons, and these electrons reduce $2 \times \text{H}^+$ to give H_2 .

The same thing happens even in very weak acids (water, alcohols...even liquid ammonia) if the metal is very reactive (sodium or potassium, say). You can think of the process here in two steps: first sodium releases an electron, then the electron is captured by a proton from NH_3 to give H , which forms H_2 . Sodium ethoxide (NaOEt) and sodium amide (NaNH_2 , p. 171) are made by dissolving sodium in ethanol or liquid ammonia, respectively.

But what if, instead of just reducing the solvent to liberate hydrogen, we harness the electrons by giving them a more easily reduced substrate instead? A dissolving metal reduction results: note *dissolving*. The electrons have to be captured as the metal releases them, otherwise they will just reduce the solvent to give H_2 .



■ You have in fact already met several dissolving metal reductions, for example Sn, HCl for reducing nitro groups (p. 495) and the Clemmensen reduction mentioned above.

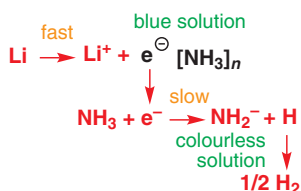
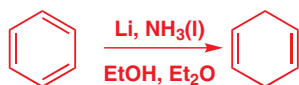

■ Sodium amide, NaNH_2 , the base you met early in this book, is made by dissolving Na in liquid NH_3 and then waiting till the solution is no longer blue.

Dissolving metal reductions work because the electrons released as reactive metals form soluble cations that can be harnessed to do other, more useful, reductions. Electrons are the simplest possible reducing agents, and they will reduce carbonyl compounds, alkynes, or aromatic rings—in fact any functional group with a low-energy π orbital into which the electron can go.

Birch reduction of arenes

We shall start by looking at the dissolving metal reduction of aromatic rings, known as the **Birch reduction**. The margin shows the reaction of benzene with lithium in liquid ammonia. At first sight this reaction looks improbable, with an aromatic ring ending up as an unconjugated diene. The mechanism will explain why we get this regiochemistry, and also why the reaction stops there—in other words, why the dissolving lithium reduces an aromatic ring more readily than an alkene.

The first thing to note is that when lithium or sodium dissolve in ammonia they give an intense blue solution. Blue is the colour of solvated electrons: these group 1 metals ionize to give Li^+ or Na^+ and $\text{e}^- (\text{NH}_3)_n$. With time, the blue colour fades, as the electrons reduce the ammonia to NH_2^- and H_2 .

Birch reductions use those blue solutions, with their solvated electrons, as reducing agents. The reduction of NH_3 to NH_2^- and H_2 is quite slow, and a better electron acceptor will get reduced in preference. With benzene, the electrons go into the lowest lying antibonding orbital (benzene's LUMO). The species we get can be represented in several ways, all of them radical anions (molecules with one excess unpaired electron). The radical anion is very basic, and it picks up a proton from the ethanol that is in the reaction mixture.

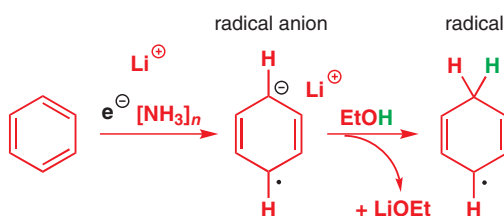

The molecule is now no longer anionic, but it is still a radical. It can pick up another electron, which pairs with the radical to give an anion, which is quenched again by the proton source (ethanol). Overall we have arrived at two additional H atoms by sequentially adding two electrons plus two protons.

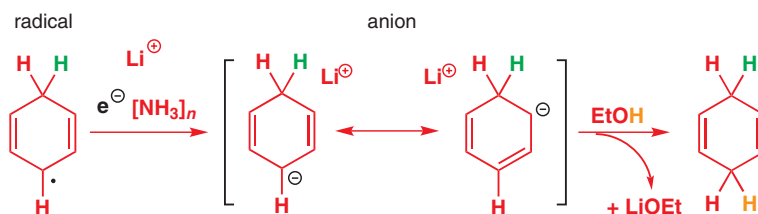

More questions of regioselectivity arise when there are substituents around the aromatic ring. Here are two examples.

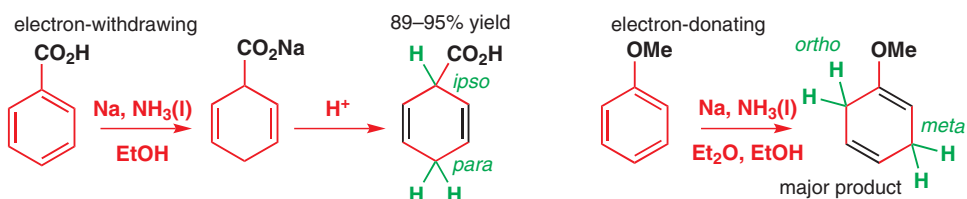

The regiochemistry of the final product is determined at the last protonation step—the anion itself is of course delocalized and could react at either end to give a conjugated diene, which would be more stable. Why then does it choose to pick up a proton in the middle and give a less stable isomer? Kinetically controlled reactions of pentadienyl anions with electrophiles typically take place at this central carbon as a result of orbital interactions. For more information see the further reading section at the end of the chapter.

➔ The terms *ipso*, *ortho*, *meta*, and *para* were defined in Chapter 18, p. 416.

These examples serve to illustrate a general principle:

- Electron-withdrawing groups promote *ipso*, *para* Birch reduction.
- Electron-donating groups promote *ortho*, *meta* Birch reduction.

The explanation must lie in the distribution of electron density in the intermediate radical anions. Electron-withdrawing groups stabilize electron density at the *ipso* and *para* positions, and protonation occurs *para*,

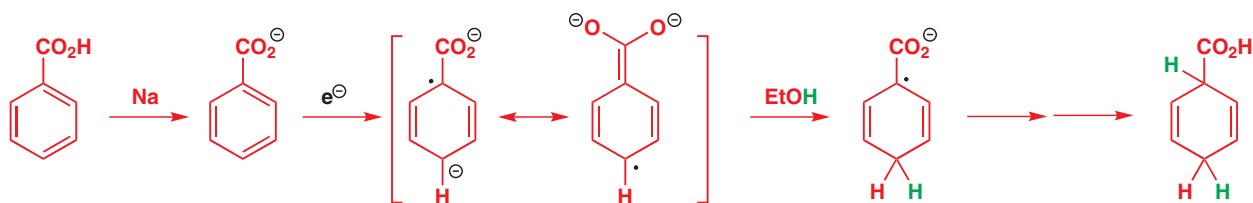

while electron-donating groups stabilize *ortho* and *meta* electron density:

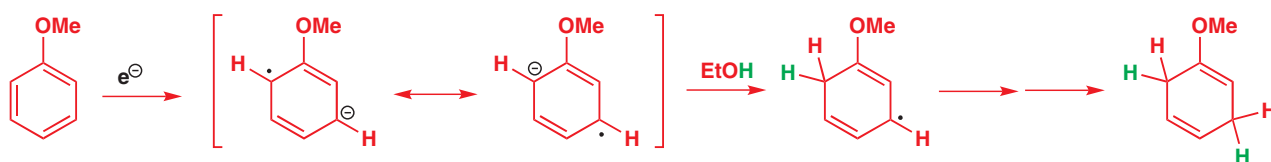

If you want the conjugated dienes as products, it is quite a simple matter to isomerize them using an acid catalyst. In fact, a small amount (about 20%) of the conjugated product is produced anyway in the reaction of anisole above. With anilines, it is impossible to stop the isomerization taking place during the reaction, and Birch reduction always gives conjugated dienamines.

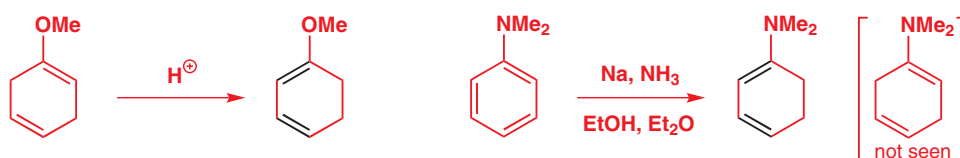

■ Make sure you can write a mechanism for the isomerization into conjugation. *Hint.* Start as though you were protonating an enol ether on carbon. You saw this sort of thing in Chapter 20.

Birch reduction of alkynes

Birch reduction works for alkynes too and reduces them to *trans* alkenes.

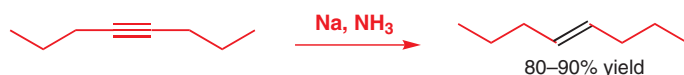

The mechanism follows the same course as the reduction of aromatic rings, but the vinyl anion is basic enough to deprotonate ammonia, so no added proton source is required. Vinyl anions are geometrically unstable, and choose to be *E*. Again, the two green H atoms come from two electrons and two protons.

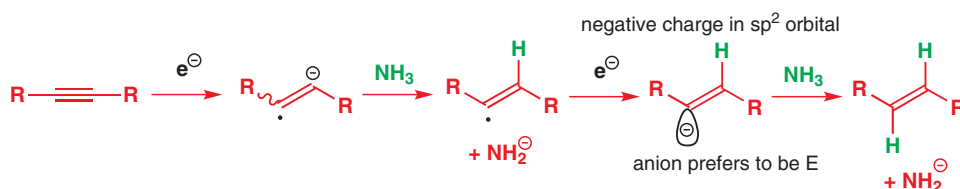

■ Note that the stereoselectivity is complementary to that of hydrogenation over the Lindlar catalyst, p. 537.

Selectivity in oxidation reactions

➔ Turn back to p. 194 (at the end of Chapter 9) if you need reminding of this.

■ [O] means an unspecified oxidizing agent.

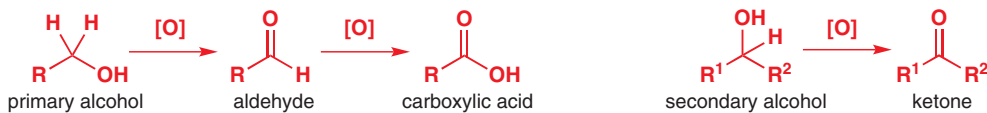

Since then you have met some other oxidizing agents too, particularly in Chapter 19:

- On p. 429 you saw peracids as oxidizing agents for C=C double bonds—they give epoxides.
- On p. 442 you saw osmium tetroxide (OsO₄) giving diols from alkenes.
- On p. 443 we introduced ozone (O₃) as a means of cleaving alkenes to carbonyl compounds by ozonolysis.

Unlike Cr(VI), none of these reagents will oxidize a hydroxyl group: they are *chemoselective* for C=C double bonds, but do not react with hydroxyl groups. By contrast, Cr(VI) oxidizes alcohols but not alkenes.

Oxidizing agents

Chemoselective for C=C double bonds	Chemoselective for alcohols or carbonyl compounds
peracids, RCO ₃ H (Chapter 19)	Cr(VI) compounds
osmium tetroxide, OsO ₄ (Chapters 19 and 34)	Mn(VII) compounds
ozone, O ₃ (Chapters 19 and 34)	some high oxidation state Hal, N, or S compounds

In this section we will be concerned only with oxidizing agents that oxidize alcohols and carbonyl compounds, and in particular we shall be concerned with ways of choosing whether to arrest the oxidation of primary alcohols at the aldehyde stage or let it continue to the carboxylic acid.

The most commonly used methods for oxidizing alcohols are based around metals in high oxidation states, often chromium(VI) (which you met in Chapter 9) or manganese(VII), and you will see that mechanistically they are quite similar—they both rely on the formation of a bond between the hydroxyl group and the metal. Another class of oxidations, those that use halogens, sulfur, or nitrogen in high oxidation states, we will deal with relatively briefly.

How to oxidize secondary alcohols to ketones

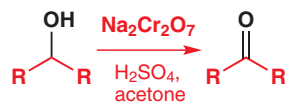

🖱 Interactive mechanism for chromium(VI) oxidation of alcohols

You met methods for this reaction in Chapter 9, where you met the use of Cr(VI) in the form of CrO₃. One common version of this reaction is the *Jones oxidation*, shown in the margin. The mechanism starts with the formation of HCrO₄⁻ ions, that is, Cr(VI), from dichromate ion in solution. In acid, these Cr(VI) species form chromate esters with alcohols. Chromate esters decompose by elimination of a Cr(IV) species, which subsequently reacts with Cr(VI) to yield 2 × Cr(V). These Cr(V) species can oxidize alcohols in the same way and are thereby reduced to Cr(III) (the final metal-containing by-product). Cr(VI) is orange and Cr(III) is green, so the progress of the reaction is easy to follow by colour change.

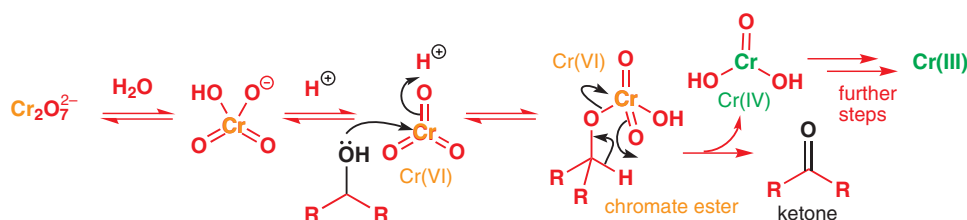

➔ We discussed this mechanism on p. 195.

Chromic acid is best avoided if acid-sensitive alcohols are to be oxidized, and an alternative reagent for these is PCC (pyridinium chlorochromate), which can be used in dichloromethane.

How to oxidize primary alcohols to aldehydes

Aqueous methods like the Jones oxidation are no good for this, since the aldehyde that forms is further oxidized to acid via its hydrate. The oxidizing agent treats the hydrate as an alcohol, and oxidizes it to the acid.

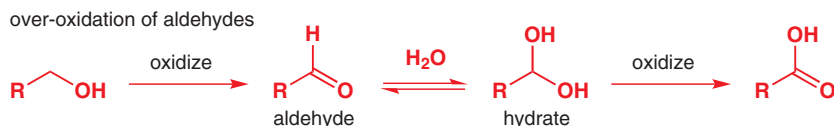

The key thing is to avoid water, so PCC in dichloromethane works quite well. The related reagent PDC (pyridinium dichromate) is particularly suitable for oxidation to aldehydes.

Some very mild oxidizing agents are being more and more widely used for the synthesis of very sensitive aldehydes. One of these is known as TPAP (tetra-*n*-propylammonium perruthenate, pronounced 'tee-pap'). TPAP can be used catalytically, avoiding the large amounts of toxic heavy metal by-products generated by most chromium oxidations. The stoichiometric oxidant in this reaction is NMO (*N*-methylmorpholine-*N*-oxide), which is reduced to the amine, reoxidizing the ruthenium to Ru(VII).

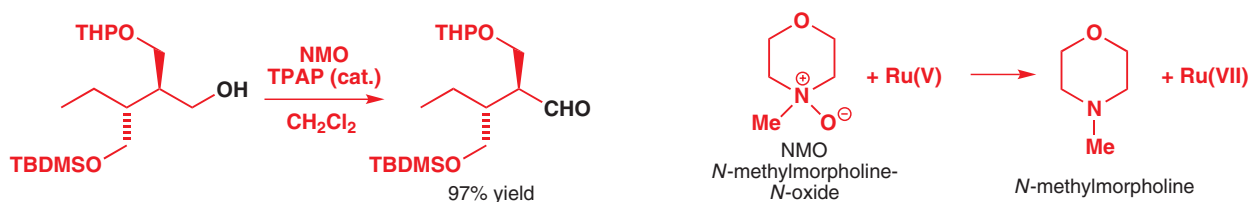

Another important mild oxidant is a high-valent iodine compound known as the **Dess–Martin periodinane**. It can be made from 2-iodobenzoic acid.



It will oxidize even very sensitive alcohols to carbonyl compounds—few others, for example, would give the *cis*- α,β -unsaturated aldehyde in the margin from a *cis*-allylic alcohol without isomerizing it to *trans*, or producing other by-products.

We shall leave detailed discussion of one more method till much later, in Chapter 27, since the mechanism involves some sulfur chemistry you will meet there, but we introduce it here because of its synthetic importance. Known as the **Swern oxidation**, it uses a sulfoxide [sulfur(IV)] as the oxidizing agent. The sulfoxide is reduced to a sulfide, while the alcohol is oxidized to an aldehyde.

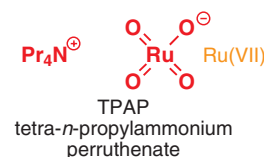
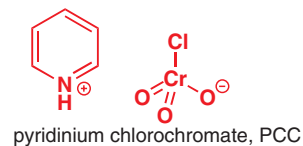
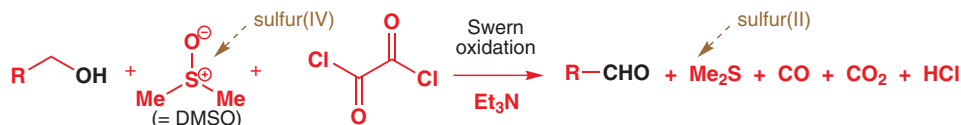

➔ The abbreviations THP and TBDMS will be explained later in this chapter (p. 550).



➔ For more details, and the mechanism of the Swern oxidation, see p. 667.

How to oxidize primary alcohols or aldehydes to carboxylic acids

Sometimes the 'over-oxidation' we were trying to avoid in oxidizing alcohols to aldehydes is actually the reaction you want. It's best done with an aqueous solution of Cr(VI) or Mn(VII). Acidic or basic aqueous potassium permanganate is often a good choice. From alcohols in acidic solution the mechanism follows very much the lines of the chromic acid mechanism; from aldehydes, the mechanism is very similar.

Potassium permanganate is a very powerful oxidant and will also oxidize a benzylic methyl group (i.e. a toluene derivative) to a carboxylic acid. You saw this in one of the steps in the synthesis of saccharin on p. 486.

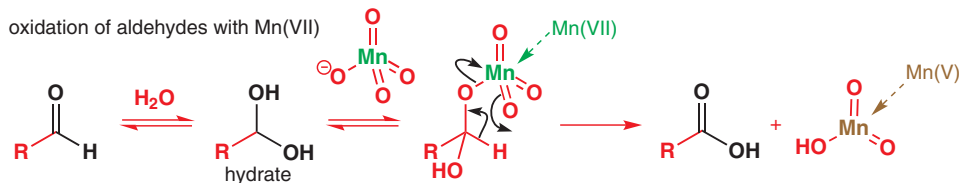
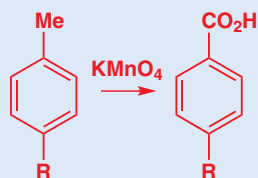

Competing reactivity: choosing which group reacts

We hope that our survey of the important methods for reduction and oxidation has shown you that, by choosing the right reagent, you can often get reaction only at the functional group you want. The chemoselectivity you obtain is *kinetic chemoselectivity*—reaction at one functional group is simply faster than at another.

Now look at the acylation of an amino alcohol (which is, in fact, a synthesis of the painkiller isobucaine) using benzoyl chloride under *acid* conditions. The hydroxyl group is acylated to form an ester. Yet under *basic* conditions, the selectivity is quite different, and an amide is formed.

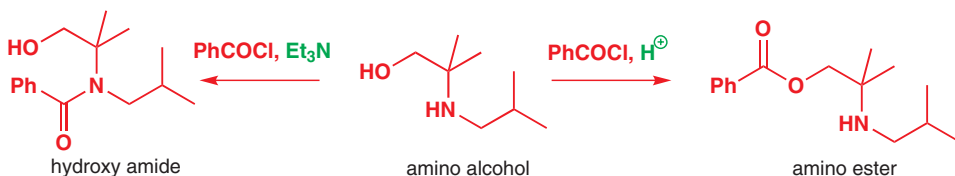

A clue to why the selectivity reverses is shown below—it is, in fact, possible to interconvert the ester and the amide simply by treating either with acid or with base.

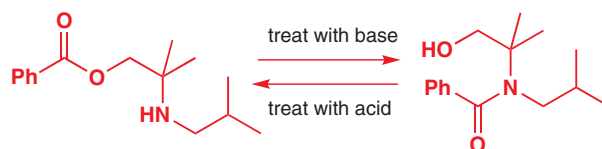

We discussed kinetic and thermodynamic control in Chapter 12 (p. 264) and again on pp. 435 and 505.

The selectivity in these reactions is *thermodynamic* chemoselectivity. Under conditions in which the ester and amide can equilibrate, the product obtained is the more stable of the two, not necessarily the one that is formed faster. In base the more stable amide predominates, while in acid the amine is protonated, which prevents it from acting as a nucleophile and removes it from the equilibrium, giving the ester.

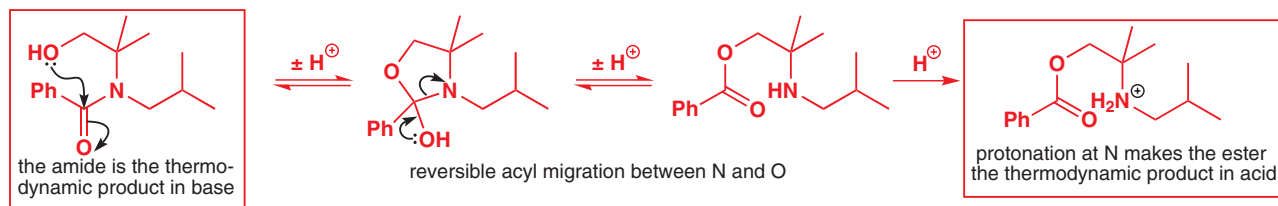

How to react the less reactive group (I): react both then 'unreact' one

The relative reactivity of the alcohol and amine in the example just given could be overturned by conducting a reaction under thermodynamic control. In kinetically controlled reactions, the idea that you can conduct chemoselective reactions on the more reactive of a pair of functional groups—carbonyl-based ones, for example—is straightforward. But what if you want to react the less reactive of the pair? There are two commonly used solutions. The first is illustrated by a compound needed by chemists in Cambridge to study an epoxidation reaction. They were able to make the following diol, but wanted to acetylate only the more hindered secondary hydroxyl group.

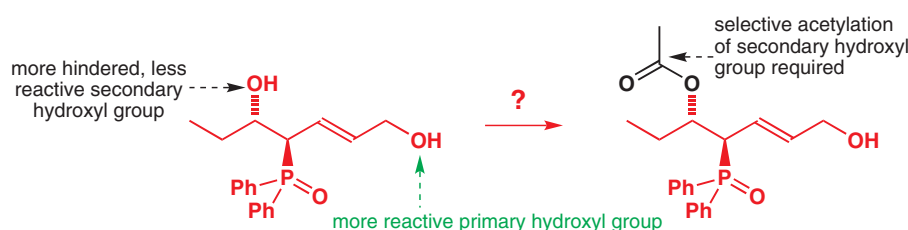

Treatment with one equivalent of an acetylating agent is no good because the primary hydroxyl group is more reactive; instead, the chemists acetylated both hydroxyl groups, and then treated the bis-acetate with mildly basic methanol (K_2CO_3 , MeOH, 20°C), which reacted only at the less hindered acetoxy group and gave the desired compound in 65% yield.

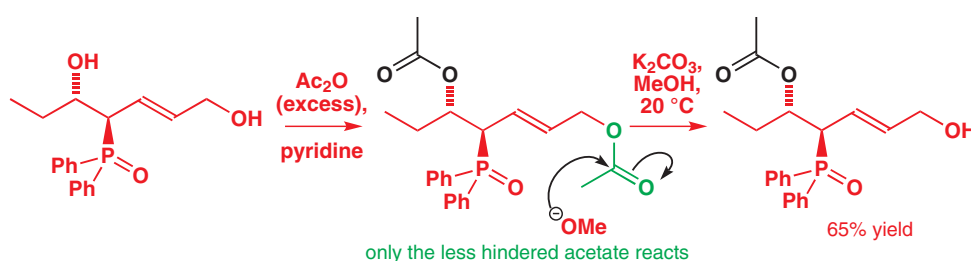

In other words, start by letting both groups react and then go backwards so the reaction is reversed, but at only one of the two groups. Steric hindrance means that the less favourable reaction (in other words, reaction at the less reactive group) was also less readily reversed.

Chemoselectivity in the reactions of dianions

A similar idea is central to a useful bit of chemoselectivity that can be obtained in the reactions of dianions. 1-Propynol can be deprotonated twice by strong bases—first, at the hydroxyl group to make an alkoxide anion (the pK_a of the OH group is about 16) and, secondly, at the alkyne (pK_a of the order of 25) to make a dianion. When this dianion reacts with electrophiles it always reacts at the alkynyl anion and not at the alkoxide.

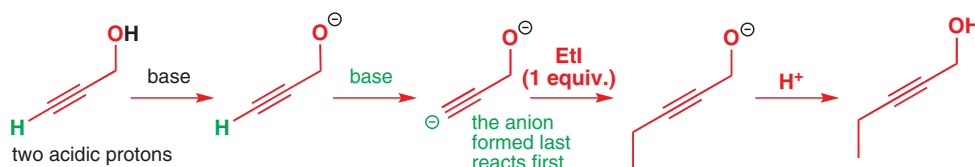

● Reactivity of dianions

The anion that is formed *last* reacts *first*.

This reaction is important in a synthesis of the perfumery compound *cis*-jasmane. The alkyne is the precursor to *cis*-jasmane's alkene side chain.

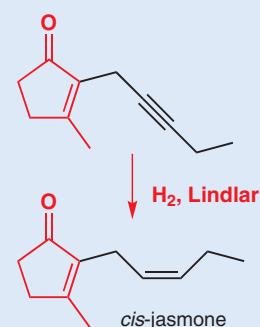

Vollhardt used this sort of chemoselectivity in his 1977 synthesis of the female sex hormone oestrone. He needed an alkyl iodide, which could be made by reacting an anion of a bis-alkyne with ethylene oxide.

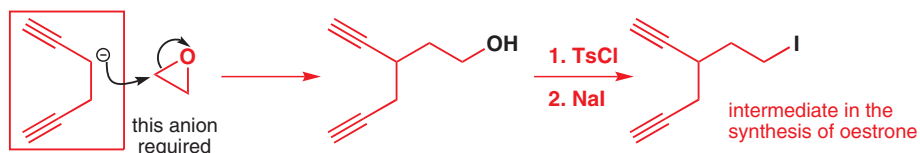

Although anions can often be formed straightforwardly next to alkynes, there are two other more acidic protons (black) in the molecule that would be removed by base before the green proton. However, treatment with *three* equivalents of butyl lithium removes all three, and the trianion reacts with ethylene oxide at the last-formed anionic centre to give the required compound.

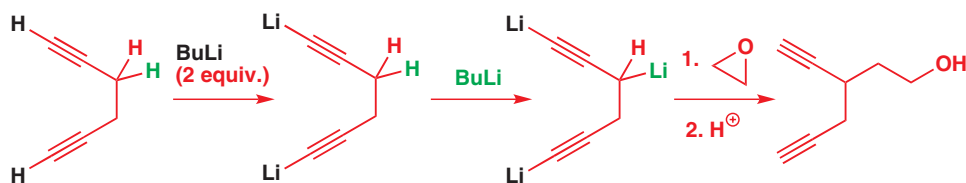

How to react the less reactive group (II): protecting groups

The more usual way of reacting a less reactive group in the presence of a more reactive one is to use a **protecting group**. This tertiary alcohol, for example, could be made from a keto-ester if we could get phenylmagnesium bromide to react with the ester rather than with the ketone.

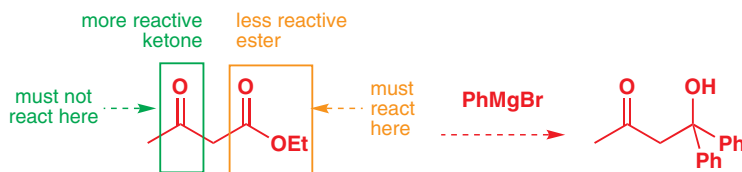

As you would expect, simply adding phenylmagnesium bromide to ethyl acetoacetate leads mainly to addition to the more electrophilic ketone.

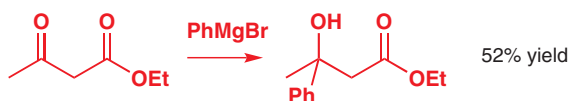

One way of making the alcohol we want is to *protect* the ketone from attack by disguising it from the nucleophile. An acetal protecting group (shown in black) is used.

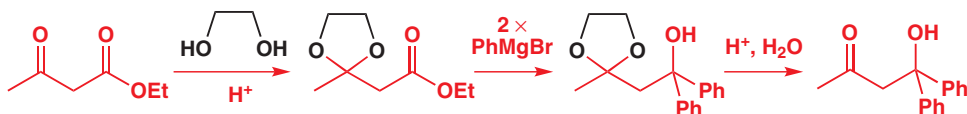

■ Five-membered cyclic acetals like these are known as dioxolanes. You met them first in Chapter 11 when we were discussing acetal formation and hydrolysis.

The first step puts the protecting group on to the (more electrophilic) ketone carbonyl, making it no longer reactive towards nucleophilic addition. The Grignard then adds to the ester, and finally a 'deprotection' step, acid-catalysed hydrolysis of the acetal, gives us back the ketone. An acetal is an ideal choice here—acetals are stable to base (the conditions of the reaction we want to do), but are readily cleaved in acid.

A survey of protecting groups

A dioxolane can be used in this way to protect aldehydes and ketones from powerful, basic nucleophiles, and makes the first entry in the tour of important protecting groups we shall conduct you through in the next few pages.

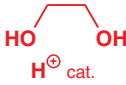
Protecting group	Structure	Protects	From	To protect	To deprotect
acetal (dioxolane)		ketones, aldehydes	nucleophiles, bases		H ⁺ , H ₂ O

By protecting sensitive functional groups like ketones it becomes possible to make reagents that would otherwise be unstable. In a synthesis of the natural product porantherine, a compound based on the structure in the margin was needed. As it's a symmetrical secondary alcohol (see p. 216), a good way to make it is to add a Grignard reagent twice to ethyl formate.

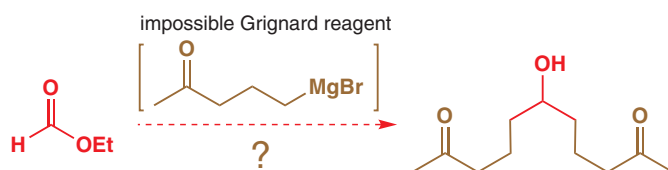
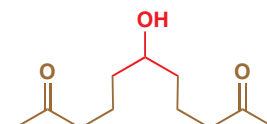

But, of course, a ketone-containing Grignard is an impossibility as it would self-destruct, so an acetal-protected compound was used. Acid-catalysed hydrolysis of the two dioxolanes, coloured green, reveals the diketone.

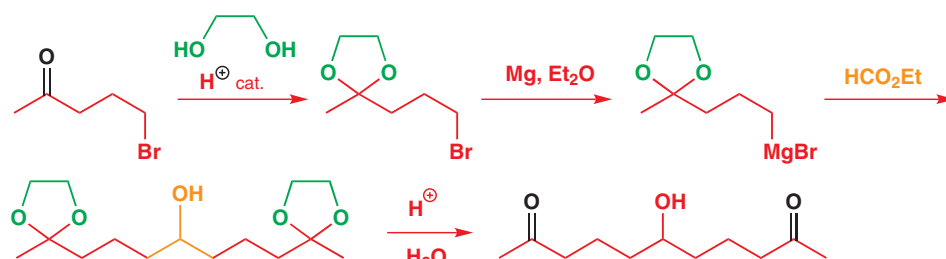

Strongly nucleophilic reagents like Grignard reagents and organolithiums are also strong bases and may need protecting from acidic protons as well as from electrophilic carbonyl groups. Among the most troublesome are the protons of hydroxyl groups. When some American chemists wanted to make the antiviral agent Brefeldin A, they needed the simple alkynol in the margin.

A synthesis could start with the same bromoketone as the one above: reduction gives an alcohol, but alkylation of an alkynyl anion with this compound is not possible because the anion will just deprotonate the hydroxyl group.

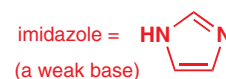
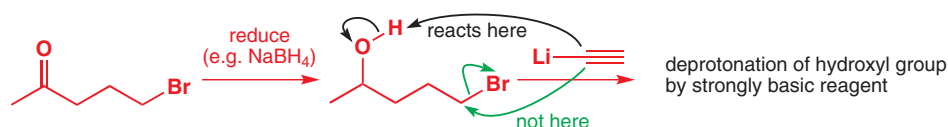
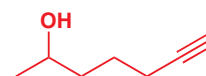

The answer is to protect the hydroxyl group with a group resistant to base, and the group chosen here was a **silyl ether**. Such ethers are made by reacting the alcohol with a trialkylsilyl chloride (here *tert*-butyldimethylsilyl chloride, or TBDMSCl) in the presence of a weak base, usually imidazole, which also acts as a nucleophilic catalyst (Chapter 12).

➔ You met imidazole on p. 178.

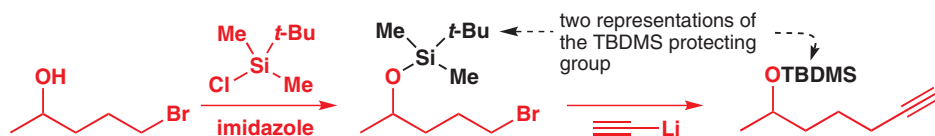

Silicon has a strong affinity for electronegative elements, particularly O, F, and Cl, so trialkylsilyl ethers are attacked by hydroxide ion, water, or fluoride ion but are more stable to carbon or nitrogen bases or nucleophiles. They are usually removed with aqueous acid or fluoride salts, particularly $\text{Bu}_4\text{N}^+\text{F}^-$ (tetra-*n*-butylammonium fluoride, known as TBAF and pronounced ‘tea-baff’), which is soluble in organic solvents. In fact, TBDMS is one member of a whole family of trialkylsilyl protecting groups and their relative stability to nucleophiles of various kinds is determined by the three alkyl groups carried by silicon. The most labile, trimethylsilyl (TMS), is removed simply on treatment with methanol, while the most stable require hydrofluoric acid.

■ Although not important to our discussion here, these substitution reactions are not the simple $\text{S}_{\text{N}}2$ reactions (Chapter 15) they might appear to be. The nucleophile adds to silicon first to form a five-valent anion, which decomposes with the loss of the alcohol.



Protecting group	Structure	Protects	From	Protection	Deprotection
trialkylsilyl $\text{R}_3\text{Si}-$, e.g. TBDMS	$\text{RO}-\text{SiMe}_3$ $\text{RO}-\text{SiMe}_2\text{t-Bu}$	alcohols (OH in general)	nucleophiles, C or N bases	R_3SiCl , base	H^+ , H_2O , or F^-

Why can't we just use a simple alkyl ether (methyl, say) to protect a hydroxyl group? There is no problem making the ether, and it will survive most reactions—but there is a problem getting an ether off again. This is always a consideration in protecting group chemistry—you want a group that is stable to the conditions of whatever reaction you are going to do (in these examples, strong bases and nucleophiles), but can then be removed under mild conditions that do not result in decomposition of a sensitive molecule. What we need then is an ether that has an Achilles' heel—a feature that makes it susceptible to attack by some specific reagent or under specific conditions. One such group is the tetrahydropyranyl (THP) group. Although it is stable under basic conditions, as an ether would be, it is an acetal—the presence of the second oxygen atom is its Achilles' heel and makes the THP protecting group susceptible to hydrolysis under acidic conditions. You could see the lone pair on the second oxygen atom as a safety catch that is released only in the presence of acid.

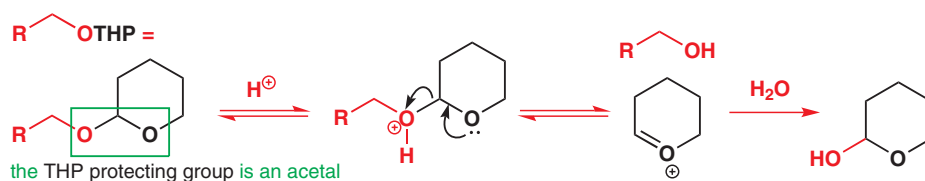

➡ There is more chemistry of enol ethers in Chapter 20.

Making the THP acetal has to be done in an unfamiliar way because the usual ‘carbonyl plus two alcohols’ method is inappropriate (work out why!). Alcohols are protected by treating them with an enol ether, dihydropyran, under acid catalysis. Notice the oxonium intermediate (formed by a familiar mechanism from Chapter 12)—just as in a normal acetal-forming reaction. In this example the THP group is at work preventing a hydroxyl group from interfering in the reduction of an ester.

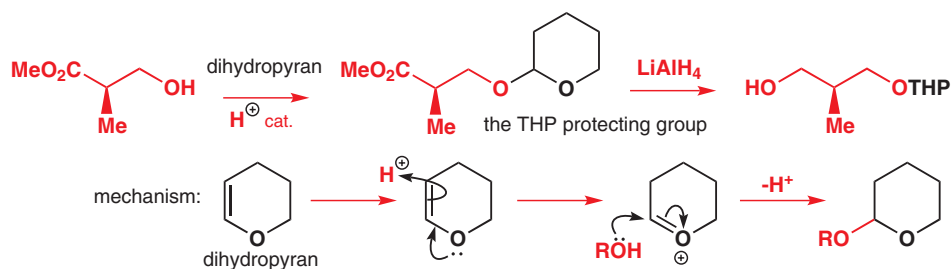

Protecting group	Structure	Protects	From	To protect	To deprotect
tetrahydropyranyl (THP)		alcohols (OH in general)	strong bases	dihydropyran and acid	H^+ , H_2O

The THP-protected compound above was used as an intermediate in a synthesis of the insecticide milbemycin. It needed to be converted to the alkyne in the margin—to do this the *other* hydroxyl group also needed protecting.

This time, however, TBDMS will not do because the protecting group needs to withstand the acidic conditions needed to remove the THP protecting group! What is more, the protecting group needs to be able to survive acid conditions in later steps of the synthesis of the insecticide. The answer is to use a third type of hydroxyl-protecting group, a benzyl ether. Benzyl (Bn) protecting groups are put on using strong base (usually sodium hydride) plus benzyl bromide, and are stable to both acid and base.

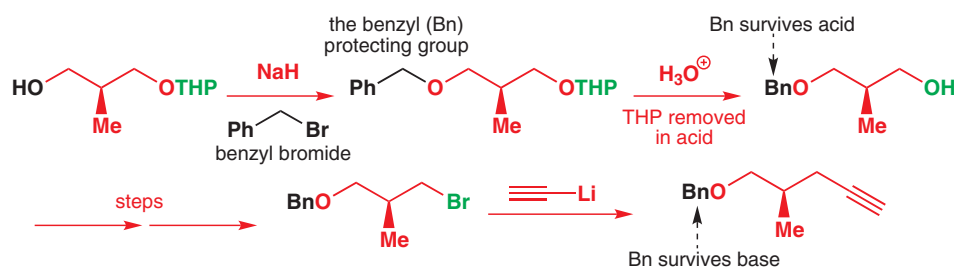

The benzyl ether's Achilles' heel is the aromatic ring and, after reading the first half of this chapter, you should be able to suggest conditions that will take it off again: hydrogenation (hydrogenolysis) over a palladium catalyst, which cleaves benzylic C–O bonds.

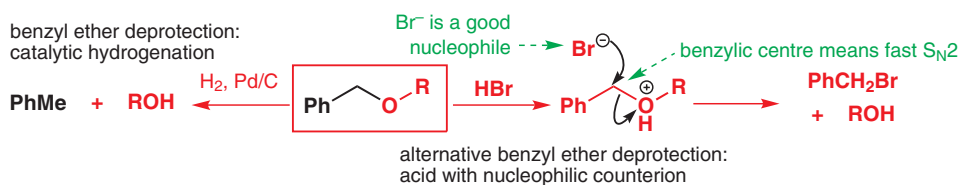

Benzyl ethers can alternatively sometimes be removed by acid, if the acid has a *nucleophilic* conjugate base. HBr , for example, will remove a benzyl ether because Br^- is a good enough nucleophile to displace ROH , although only at the reactive, benzylic centre.

A little further inspection will show you that the THP group here is not just stopping the OH interfering with the $LiAlH_4$ reduction, but is also crucial to the preservation of the chirality of this compound. The wedged bond shows you that the starting material is a single enantiomer: without a protecting group on one of the hydroxyls, they would be identical and the compound would no longer be chiral. The THP group also complicates the situation by introducing an extra chiral centre, and hence the potential for two diastereoisomers, which we will ignore.

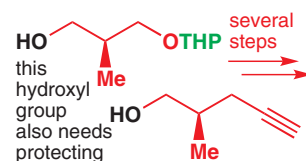

➔ You saw this method for making ethers by an S_N2 reaction back in Chapter 15.

Benzyl and benzoyl

Note the abbreviation for a benzyl ether, $ROCH_2Ph$, is **ROBn**. Contrast this with benzoyl esters, $ROCOPh$, which may be abbreviated **ROBz**.

■ It must be a *palladium* catalyst—platinum would catalyse hydrogenation of the aromatic ring.

Protecting group	Structure	Protects	From	To protect	To deprotect
benzyl ether (OBn)		alcohols (OH in general)	almost everything	NaH, BnBr	H ₂ , Pd/C, or HBr
methyl ether (ArOMe)		phenols (ArOH)	bases	NaH, MeI, or (MeO) ₂ SO ₂	BBr ₃ , HBr, HI, Me ₃ SiI

We said earlier that simple methyl ethers are inappropriate as protecting groups for OH because they are too hard to take off again. That is usually true, but not if the OH is phenolic—ArOH is a better leaving group than ROH, so HBr will take off methyl groups from aryl methyl ethers too.

■ Alternatives to HBr include BBr₃, usually the favoured reagent, HI, and Me₃SiI.

deprotection of aryl methyl ethers

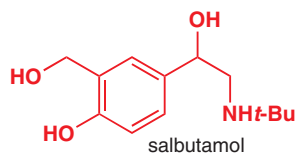
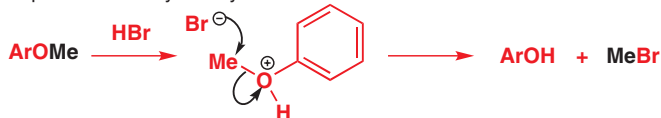

Protecting groups may be useful, but they are also wasteful—both of time, because there are two extra steps to do (putting the group on and taking it off), and of material, because these steps may not go in 100% yield. Here's one way to avoid using them. During the development of the anti-asthma drug salbutamol, the triol below was needed. With large quantities of salbutamol already available, it seemed most straightforward to make the triol by adding phenylmagnesium bromide to an ester available from salbutamol. Unfortunately, the ester also contains three acidic protons, making it look as though the hydroxyl and amine groups all need protecting. But, in fact, it was possible to do the reaction just by adding a large excess of Grignard reagent: enough to remove the acidic protons *and* to add to the ester.

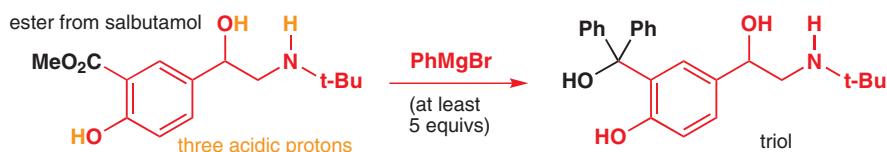

This strategy is easy to try, and, providing the Grignard reagent isn't valuable (you can buy PhMgBr in bottles), is much more economical than putting on protecting groups and taking them off again. But it doesn't always work—there is no way of telling whether it will until you try the reaction in the laboratory. In this closely related reaction, for example, the same chemists found that they needed to protect both the phenolic hydroxyl group (but not the other alcohol OH) as a benzyl ether and the amine NH as a benzyl amine. Both protecting groups come off in one hydrogenation step.

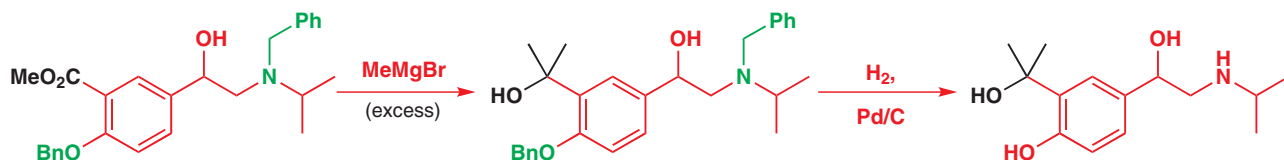

Benzyl groups are one way of protecting secondary amines against strong bases that might deprotonate them. But it is the nucleophilicity of amines that usually poses problems of chemoselectivity, rather than the acidity of their NH groups. The potential for pitfalls is

nowhere more acute than in the synthesis of one of the most important classes of biological molecules: peptides.

Peptide synthesis

Peptide synthesis has become one of the most reliable and predictable fields of practical organic chemistry, principally because of the effectiveness of the protecting groups it employs. For this reason, peptides are one of the few classes of complex organic molecules that can routinely be made by machines, such as the one on the right, in which much of the chemistry we are about to talk about takes place without any human intervention.

Biology makes peptides and proteins by selectively coupling together members of a pool of 20 or so amino acids. To do the same in the laboratory, we need to overcome a number of challenges. For example, we'll start by thinking about how to react two amino acids together, to make a dipeptide—leucine and glycine, for example. If we want the NH_2 group of glycine to react with the CO_2H group of leucine we will first have to activate the carboxylic acid towards nucleophilic substitution—by making the acyl chloride, say, or a particularly reactive ester, which we will represent as RCOX .

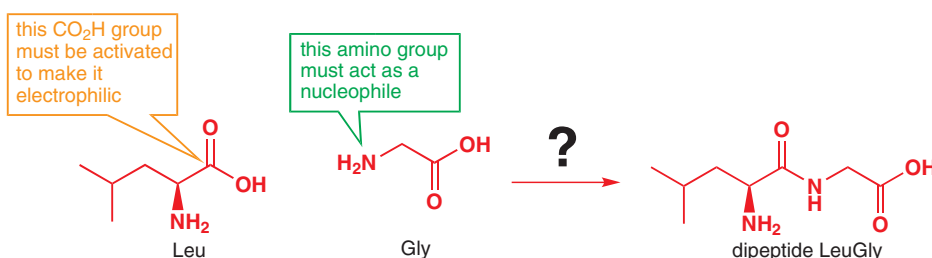

The main problem, though, is that there is another free CO_2H , which could react with the COX group to form an anhydride, and two different free amines, either of which might react, giving both LeuLeu (which we don't want) and LeuGly (which we do).

For this reason, we need to protect both the NH_2 group of leucine and the CO_2H group of glycine. What sort of protecting groups do they need to be? We will need to be able to take them off again once they have done their job, so there is no point using, say, an amide to protect the amine since we would have great difficulty hydrolysing the amide in the presence of the amide bond we are trying to form. Not only do we want the protecting groups to be removable under mild conditions, but we want two groups (one for each of NH_2 and CO_2H) which we can take off under *different* conditions. We then have the opportunity to modify either end of the dipeptide at will.

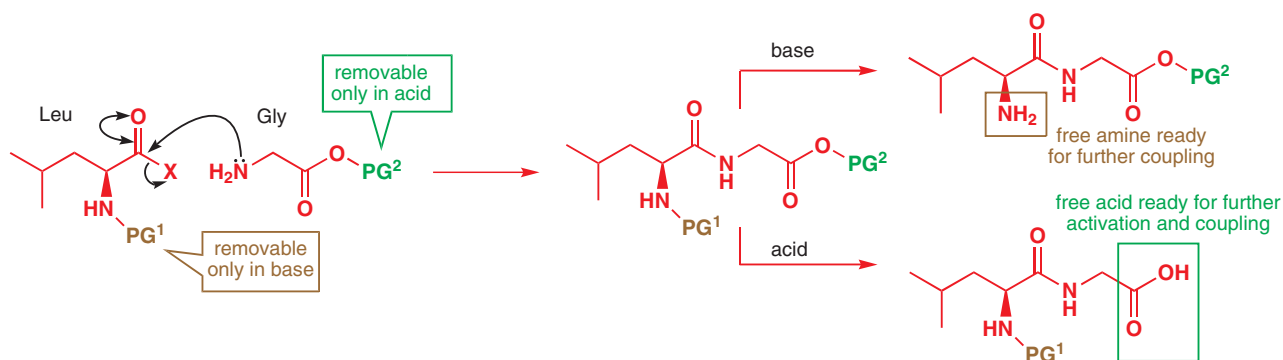

A good choice for a pair of conditions might be acid and base—we might protect the NH_2 group with a protecting group we can remove only in base, and the CO_2H group with protection we can remove only in acid.



■ There is a full list of the names, structures, and abbreviation of the amino acids which constitute most peptides and proteins on p. 554.

■ In fact, acyl chlorides are not used in peptide synthesis because of the potential for unwanted side reactions, including racemization and dimerization to form by-products known as diketopiperazines.

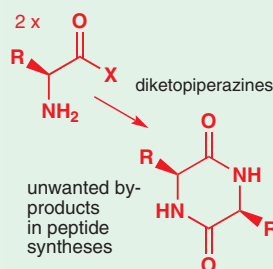

unprotected coupling—three competing nucleophiles

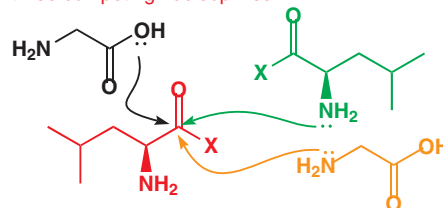

The amino acids

For reference, a full list of the amino acids appearing in the structure of peptides is given here, along with the codes used to describe them in abbreviated structures. The side chains are shown in black, with side chain functional groups in green. More chemistry of amino acids will follow in Chapter 42.

Name	Three-letter code	One-letter code	Structure
glycine	Gly	G	
alanine	Ala	A	
valine	Val	V	
leucine	Leu	L	
isoleucine	Ile	I	
phenylalanine	Phe	F	
tryptophan	Trp	W	
proline	Pro	P	
serine	Ser	S	
threonine	Thr	T	
tyrosine	Tyr	Y	

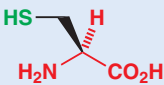
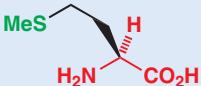
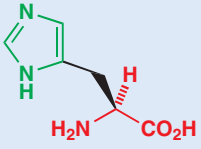
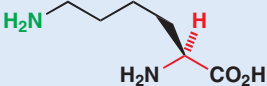
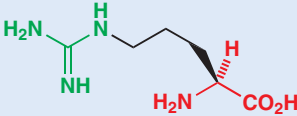
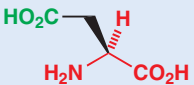
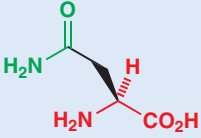
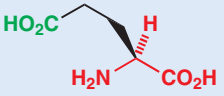
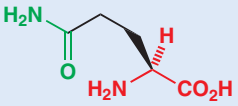
Name	Three-letter code	One-letter code	Structure
cysteine	Cys	C	
methionine	Met	M	
histidine	His	H	
lysine	Lys	K	
arginine	Arg	R	
aspartic acid	Asp	D	
asparagine	Asn	N	
glutamic acid	Glu	E	
glutamine	Gln	Q	

The Cbz protecting group—oxytocin



We introduced the dipeptide LeuGly as an example because it appears at one end of the peptide hormone oxytocin. The first step in the synthesis of oxytocin is indeed the coupling of glycine (through its amino group) with leucine. This is how it was done by du Vigneaud and Bodanszky. First, the carboxylic acid of the glycine was protected as an ethyl ester. Making an ester is the obvious way to stop CO_2H groups interfering as acids or as nucleophiles. However, simple methyl and ethyl esters may pose problems—they can still react with such nucleophiles as amines. Ethyl esters of amino acids are therefore stable only if the NH_2 group is protected. The glycine ethyl ester had to be stored as its hydrochloride salt: in effect, the $-\text{NH}_2$ group is ‘protected’ as $-\text{NH}_3^+$.

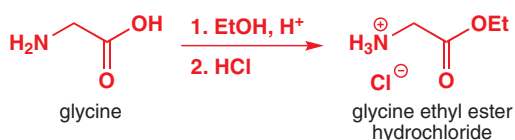

Oxytocin is a hormone involved in controlling the onset of labour in women and the subsequent release of milk. It was the first peptide hormone to be synthesized, in 1953, by du Vigneaud, who won the Nobel prize in 1955 for his work on peptide synthesis. The ‘synthetic’ version of the hormone, syntocinon (identical, of course, with the natural version isolated from human placentas, although without the dangers of biological contamination), is regularly used in modern obstetrics to induce labour in women whose babies are overdue.

A more commonly used carboxylic-acid-protecting group that is rather more stable towards attack by nucleophiles is **the *t*-butyl ester**. *t*-Butyl esters can be made by reacting the carboxylic acid with the cation generated from isobutene in sulfuric acid.

■ This method is preferable in this case to the usual way of making esters, from acyl chloride plus alcohol (see Chapter 10), because steric hindrance makes that a very slow reaction with *t*-butanol.

making a *t*-butyl ester

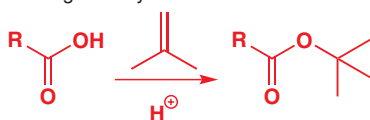

key steps:

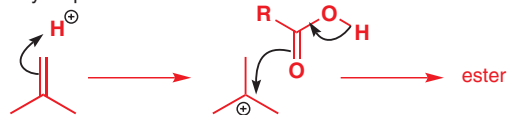

Steric bulk means that *t*-butyl esters are resistant to nucleophilic attack at the carbonyl group, and that includes hydrolysis under basic conditions (nucleophilic attack by HO⁻). But they do hydrolyse relatively easily in acid because the mechanism of hydrolysis of *t*-butyl esters in acid is quite different. Instead of undergoing nucleophilic attack at the carbonyl group, the *t*-butyl ester loses a stable carbocation, which is either captured by solvent in an S_N1 reaction or loses a proton in an E1 reaction.

hydrolysis of *t*-butyl esters in acid:

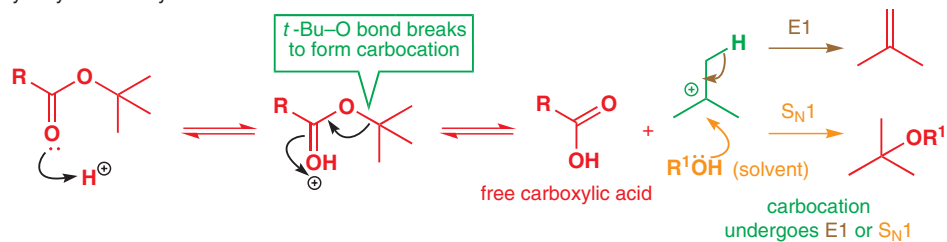

Protecting group	Structure	Protects	From	To protect	To deprotect
<i>t</i> -butyl ester (CO ₂ <i>t</i> -Bu)		carboxylic acids	nucleophiles	isobutene, H ⁺	strong acid

In the event, the chemists needed a group that they could later react with ammonia to make the primary amide that is present in oxytocin. They also wanted a group that was stable to mild acid—so they chose the ethyl ester.

■ You will occasionally see Cbz abbreviated to just Z.

As for the leucine residue, it had to have its NH₂ group protected using a base-stable protecting group because base would be needed to release the NH₂ group of the glycine hydrochloride salt. The group that was used is one of the most important nitrogen-protecting groups and is known as the Cbz group (Cbz stands for carboxybenzyl). Cbz groups are put on by treating with benzyl chloroformate (BnOCOCl) and weak base.

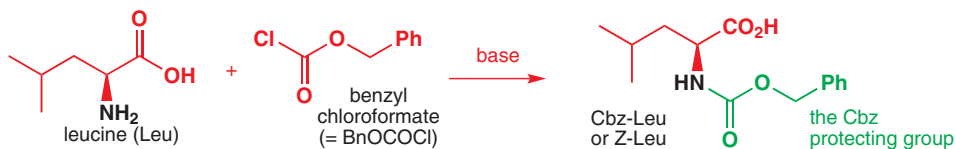

■ Carbamates are a sort of hybrid of an ester and an amide, but their chemistry resembles most closely that of an amide.

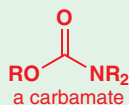

Cbz-protected amines are actually carbamates: just like amides they are no longer nucleophilic because the nitrogen's lone pair is tied up in conjugation with the carbonyl group. They are resistant to both aqueous acid and aqueous base, but they have, to use the analogy we developed earlier, an Achilles' heel—the benzyl group. Removal of the benzyl group under the same two sets of conditions that remove benzyl ethers (p. 551) releases the safety catch and removes Cbz:

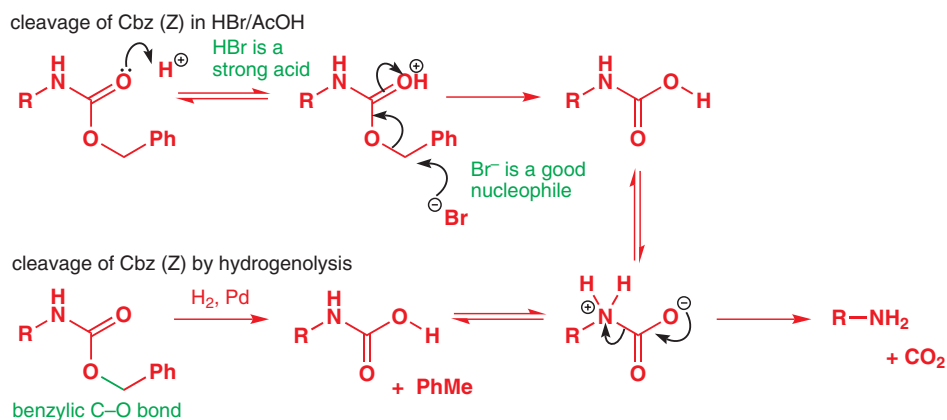

Protecting group	Structure	Protects	From	Protection	Deprotection
Cbz (Z) (OCOBn)		amines	electrophiles	BnOCOCl, base	HBr, AcOH; or H ₂ , Pd

The carboxylic acid of the Cbz-protected leucine next has to be activated to allow it to react with the glycine. The acyl chloride won't do as it is unstable, and an alternative in peptide chemistry is to make a *p*-nitrophenyl or 2,4,6-trichlorophenyl ester. Phenoxide, especially when substituted with electron-withdrawing substituents, is a good leaving group, and Cbz-leucine *p*-nitrophenyl ester reacts with the glycine hydrochloride ethyl ester in the presence of a weak base (triethylamine, to release the glycine's NH₂ group).

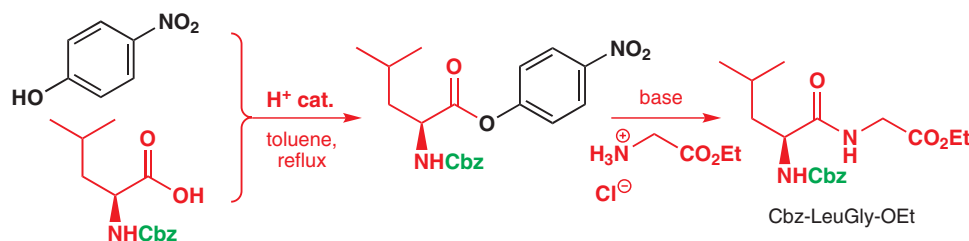

The dipeptide is now coupled—but is still protected. Deprotection (HBr/AcOH) gave the HCl salt of LeuGly ethyl ester for further reaction. The rest of the peptide was built up in much the same way—each amino acid being introduced as the Cbz-protected *p*-nitrophenyl ester before being deprotected ready for the next coupling, until all nine of oxytocin's amino acids had been introduced.

The Boc protecting group—gastrin and aspartame

Gastrin is a hormone released from the stomach that controls the progress of digestion. Early work on the hormone showed that only the four C-terminal amino acids of the peptide (the C-terminal tetrapeptide) were necessary for its physiological activity.

The synthesis starts with the coupling of two more amino acids: aspartic acid and phenylalanine. As you would expect, the carboxylic acid group of phenylalanine is protected, this time as a methyl ester, and the NH₂ group of aspartic acid is protected as a Cbz derivative. Since aspartic acid has two carboxylic acid groups, one of these also has to be protected. Here is the method—first the Cbz group is put on; then both acids are protected as *benzyl* esters. Then just one of the benzyl esters is hydrolysed. It may seem surprising to you that this chemoselective hydrolysis is possible, and you could not have predicted that it would work without trying it out in the laboratory.

■ The lower pK_a of a phenol makes a phenoxide a better leaving group than an alkoxide, and an electron-deficient phenoxide is even better still (see p. 173).

■ Notice the chemoselectivity in this step—the glycine's NH₂ group has three carbonyl groups to choose from, but reacts only with the most electrophilic—the one bearing the best leaving group.

H₂N–Tyr–Met–Asp–Phe–CONH₂
gastrin C-terminal tetrapeptide

C-terminus means the end of the peptide that carries the terminal CO₂H group. The other end, carrying the NH₂ group, is the N-terminus. By convention, the N-terminus is always written to the left and the C-terminus to the right.

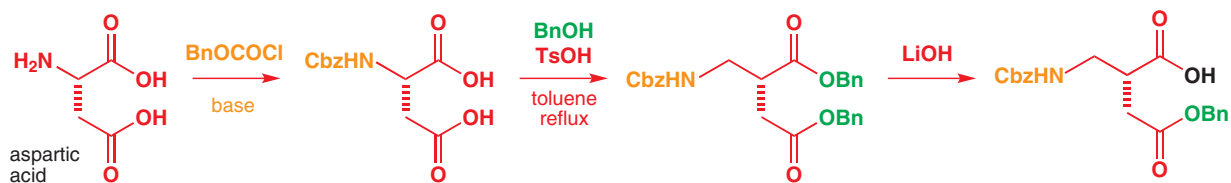

Accidental aspartame

At this point in one synthesis of the tetrapeptide in the laboratories of Searle, the now defunct American pharmaceutical company, a remarkable discovery occurred. The AspPhe methyl ester was accidentally found to taste sweet: extremely sweet—about 200 times as sweet as sucrose. AspPhe is now known as aspartame, marketed under the brand name NutraSweet. It goes without saying that despite this extraordinary discovery, tasting anything in the laboratory, accidentally or otherwise, is extremely unwise, ill-judged, and outright dangerous. Donald Rumsfeld was once chief executive of Searle.

The protected acid is next activated as its 2,4,6-trichlorophenyl ester, ready for coupling with the phenylalanine methyl ester in base. Now you see why the benzyl ester was chosen to protect Asp's side-chain carboxylic acid group—hydrogenolysis can be used to cleave both the Cbz group and the benzyl ester at the same time.

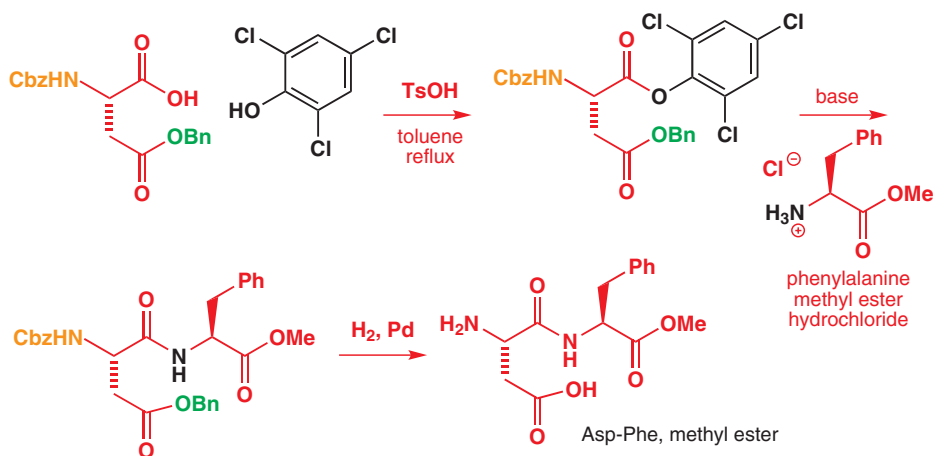

The next amino acid in the peptide is methionine, and it will of course need N-protecting and C-activating. The N-protecting group used this time was different—still a carbamate, although not Cbz—it was Boc, which stands for *t*-butyloxycarbonyl and is pronounced 'bock'. The Boc group, *t*-BuOCO, is introduced with (*t*-BuOCO)₂O, known as Boc anhydride.

■ To introduce the Cbz group, a chloroformate (BnOCCl) is used. But the equivalent chloroformate here, *t*-BuOCCl, is unstable, so Boc_2O is used instead. It would be good practice for you to write a mechanism for this reaction.

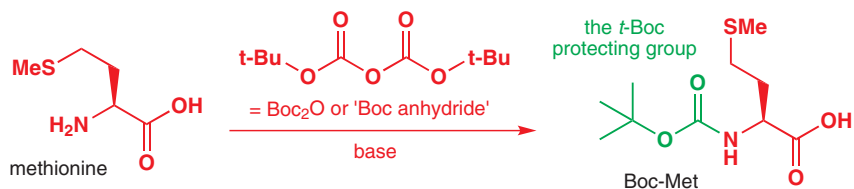

Like Cbz, the Boc group is a carbamate protecting group. But, unlike Cbz, it can be removed simply with dilute aqueous acid. Just 3M HCl will hydrolyse it, again by protonation, loss of *t*-butyl cation, and decarboxylation. Base, on the other hand, cannot touch the Boc group—the carbonyl group is too hindered to be attacked even by OH^- , and Boc is strongly resistant to basic hydrolysis.

■ The mechanism for this hydrolysis is comparable to the acid-catalysed cleavage of Cbz groups, but remember that here the *t*-Bu group leaves in an $\text{S}_{\text{N}}1$ step. Cbz groups are cleaved by using a good nucleophile, Br^- , because an $\text{S}_{\text{N}}2$ step is involved; any old acid will cleave Boc.

removal of the Boc group in acid

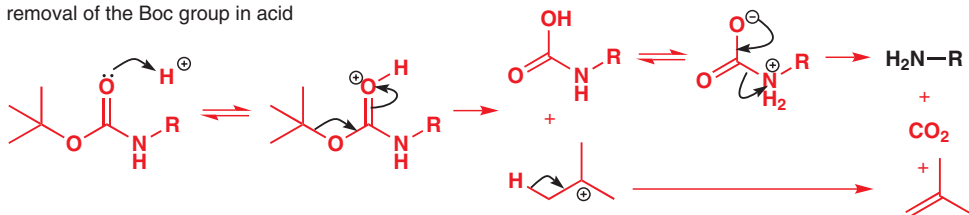

Protecting group	Structure	Protects	From	To protect	To deprotect
Boc (<i>t</i> -BuOCO)		amines	electrophiles	(<i>t</i> -BuOCO) ₂ O, base	H ⁺ , H ₂ O

Meanwhile, back at the tetrapeptide synthesis, methionine (Met) has been Boc-protected, and is ready for activation—as a 2,4,6-trichlorophenyl ester (abbreviated to Ar below) this time—and coupling with the deprotected AspPhe–OMe. Aqueous acid takes off the Boc group without hydrolysing peptide or ester bonds, and a repeat of this cycle with Boc-tryptophan trichlorophenyl ester (BocHN–Trp–OAr) followed by formation of the amide with ammonia finally gives the tetrapeptide.

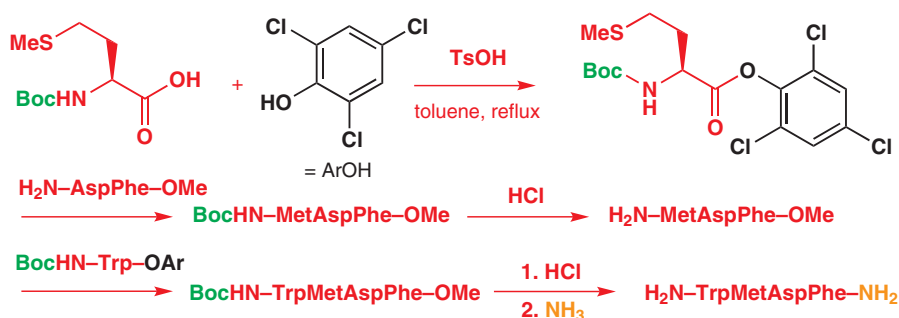

The Fmoc protecting group

Our final protecting group has a susceptibility inverse to that of Boc. The Fmoc (pronounced ‘eff-mock’), or fluorenylmethyloxycarbonyl, protecting group cannot be lost by substitution in the manner of Cbz or *t*-Boc because neither S_N1 nor S_N2 mechanisms can operate at the ringed carbon atom: it is both primary *and* hindered.

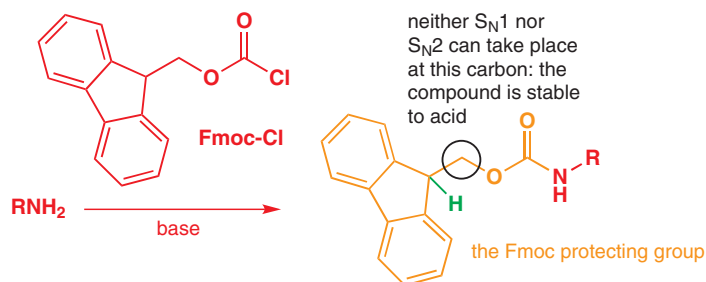

So, where is the safety catch? Fmoc’s Achilles’ heel is its rather acidic proton (pK_a about 25), shown in green. It’s acidic because the anionic product of deprotonation is aromatic. Only a very small concentration of this aromatic anion ever forms, but as it does it immediately undergoes elimination. Fmoc-protected amines are readily deprotected in base.

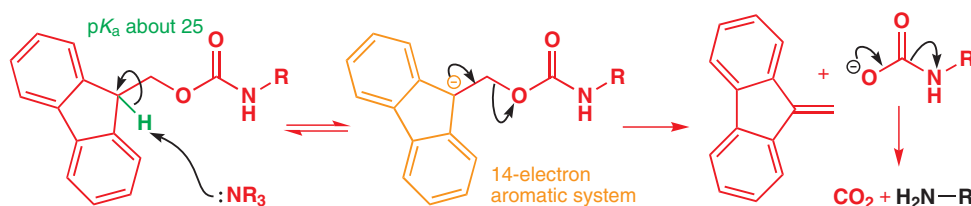

➔ In Chapter 15 we analysed in detail the structural features which favour and disfavour substitution reactions of this type.

➔ The aromaticity of cyclopentadienyl anions of this type was discussed in Chapter 17, p. 401.

The table of protecting groups, built up slowly over this chapter, is now complete. You should from this point on be able to write a structure for each of the ones listed below, and you should also be familiar with the types of conditions necessary for protection and deprotection with each member of the list.

Protecting group	Structure	Protects	From	To protect	To deprotect
acetal (dioxolane)		ketones, aldehydes	nucleophiles, bases		H ⁺ , H ₂ O
trialkylsilyl R ₃ Si (e.g. TBDMS)	RO-SiMe ₃ RO-SiMe ₂ t-Bu	alcohols (OH in general)	nucleophiles, C or N bases	R ₃ SiCl, base	H ⁺ , H ₂ O, or F ⁻
tetrahydropyranyl (THP)		alcohols (OH in general)	strong bases		H ⁺ , H ₂ O
benzyl ether (OBn)		alcohols (OH in general)	almost everything	NaH, BnBr	H ₂ , Pd/C, or HBr
methyl ether (ArOMe)		phenols (ArOH)	bases	NaH, MeI, or (MeO) ₂ SO ₂	BBr ₃ , HBr, HI, Me ₃ SiI
<i>t</i> -butyl ester (CO ₂ <i>t</i> -Bu)		carboxylic acids	nucleophiles	isobutene, H ⁺	strong acid
Cbz (Z) (OCOBn)		amines	electrophiles	BnOCOCl, base	HBr, AcOH; or H ₂ , Pd
<i>t</i> -Boc (OCO <i>t</i> -Bu)		amines	electrophiles	(<i>t</i> -BuOCO) ₂ O, base	H ⁺ , H ₂ O
Fmoc	see text	amines	electrophiles	Fmoc-Cl	base, e.g. amine

Chemoselective methods for oxidation and reduction, and protecting groups to help control chemoselectivity, will appear throughout this book, and we shall return in detail to peptides and their biological functions in Chapter 42. Before then we will address in detail stereoselectivity (in Chapters 32, 33, and 41) but the very next chapter will deal with the other aspect of selectivity—*regioselectivity*.

Further reading

There is a basic introduction in S. Warren and P. Wyatt, *Organic Synthesis: the Disconnection Approach*, Wiley, Chichester, 2008, chapter 5.

Molecular Orbitals and Organic Chemical Reactions: Student Edition by Ian Fleming, Wiley, Chichester, 2009 on pentadienyl anions, pp. 126–128.

Birch reduction: P. W. Rabideau, and Z. Marcinow, *Org. React.* 1992, **42**, 1. Lindlar reduction: H. Lindlar and R. Dubuis, *Org. Synth. Coll.* 1973, vol 5, 880.

Peptide synthesis: N. L. Benoiton, *Chemistry of Peptide Synthesis*, Taylor and Francis, 2005. J. Jones, *Amino Acid and Peptide Synthesis*, Oxford Primer, 2nd edn, OUP, Oxford, 2002.

Protecting Groups: basic introduction, Jeremy Robertson, *Protecting Group Chemistry*, Oxford Primer, Oxford, OUP, 2000. More advanced books: P. J. Kocienski, *Protecting Groups*, 3rd edn, Thieme, 2003. P. G. M. Wuts and T. Greene, *Greene's Protecting Groups in Organic Synthesis*, Wiley, 2007. A different view: T. Newhouse, P. S. Baran, and R. W. Hoffmann, The Economies of Synthesis, *Chem. Soc. Rev.* 2009, **38**, 3010.

Check your understanding



To check that you have mastered the concepts presented in this chapter, attempt the problems that are available in the book's Online Resource Centre at <http://www.oxfordtextbooks.co.uk/orc/clayden2e/>

24

Regioselectivity

Connections

➔ Building on

- Chemoselectivity **ch23**
- Electrophilic aromatic substitution **ch21**
- Addition to alkenes **ch19**
- Substitution at saturated C **ch15**
- Electrophilic alkenes and nucleophilic aromatic substitution **ch22**

Arriving at

- Selectivity of a new kind decided by mechanism
- Reagent and substrate are both important
- Controlling the arrangement of aromatic substituents
- How to get *ortho* selectivity: ortholithiation and sulfonation
- Radical as well as ionic reactions
- Reactions of allylic compounds
- Revisiting conjugate addition

➔ Looking forward to

- Stereoselectivity **ch32–ch33**
- Enol and enolate reactions **ch25 & ch26**
- Reactions and synthesis of heterocycles **ch29 & ch30**
- Radical reactions **ch37**

Introduction

We met *chemoselectivity*—*which* group reacts—in the last chapter. Chemoselectivity means that there are two separate functional groups and that a reagent must choose between them. By contrast, *regioselectivity* implies that there is one functional group that can react in two different places and a reagent must choose where to react. Simple examples include addition of HX to an alkene (Chapter 19) and nucleophilic attack on the epoxide derived from that alkene (Chapter 15).

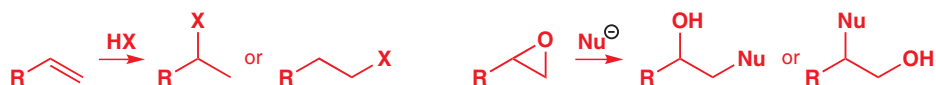

It might also mean that two functional groups are combined in a single conjugated system that can again react in two (or more) places. Examples include the addition of bromine to dienes (two conjugated alkenes) and addition of a nucleophile to a conjugated carbonyl compound (carbonyl group conjugated to an alkene).

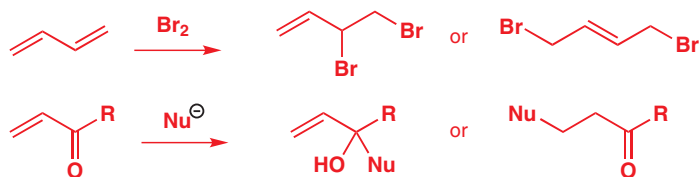

Online support. The icon  in the margin indicates that accompanying interactive resources are provided online to help your understanding: just type www.chemtube3d.com/clayden/123 into your browser, replacing **123** with the number of the page where you see the icon. For pages linking to more than one resource, type **123-1, 123-2** etc. (replacing **123** with the page number) for access to successive links.

The choice between *ortho/para* and *meta* substitution when an electrophile attacks a benzene ring (Chapter 21) is also a matter of regioselectivity. We shall discuss all these examples in further detail in this chapter, and extend these ideas to new reactions as well.

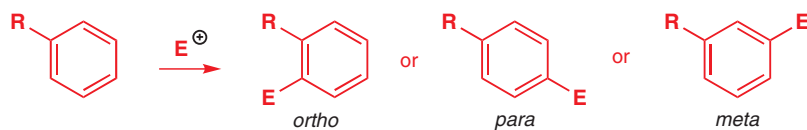

Regioselectivity in electrophilic aromatic substitution

We start with electrophilic aromatic substitution. It was established in Chapter 21 that an electron-donating substituent favours *ortho/para* and an electron-withdrawing substituent favours *meta* substitution. Although *meta* substitution is usually slower than *ortho/para* substitution (because electron-withdrawing groups deactivate the ring), it usually gives the *meta* product alone.

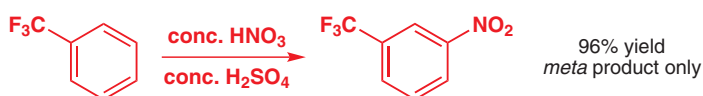

Most reactions of benzene rings with electron-donating substituents give *ortho/para* mixtures and, if the substituent is very electron-donating, may lead to both *ortho* and *para* substitution in the same molecule. Control in favour of the *para* product can usually be achieved by reducing the reactivity of the substituent and increasing its size.

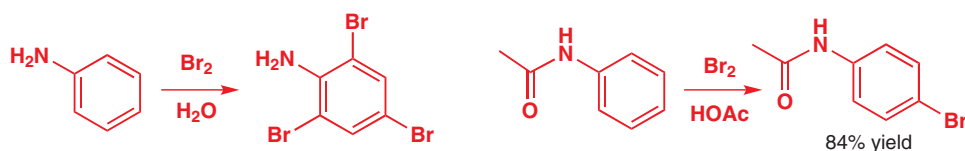

Of course, if the *para* position is blocked, *ortho* substitution is the only option, and we will come back to the idea of blocking substituents shortly. But there is a general way of directing electrophiles to the *ortho* position using activation by metallation.



➔ All these examples are drawn from Chapter 21.

Making organometallics by deprotonating aromatic rings: ortholithiation

Look at the reaction below: butyllithium deprotonates an sp^2 hybridized carbon atom to give an aryllithium. It works because the protons attached to sp^2 carbons are more acidic than protons attached to sp^3 carbons (although they are a lot less acidic than alkyne protons).



But there must be another factor involved to account for exclusive *ortho* substitution, which is after all the most hindered site. The functional group containing oxygen (sometimes nitrogen) is next to the proton to be removed. This functional group 'guides' the butyllithium, so that it attacks the adjacent protons. It does this by forming a complex with the Lewis acidic lithium atom, much as ether solvents dissolve Grignard reagents by complexing

their Lewis-acidic metal ions. This mechanism means that it is only the protons *ortho* to the functional group that can be removed, and the reaction is known as an **ortholithiation**.

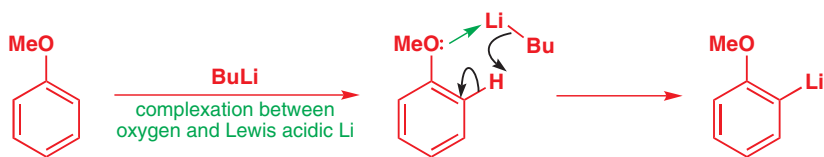

The example below shows ortholithiation, activated by the nitrogen atom of a tertiary amine, being used to make a new C–C bond. Here it is the nitrogen atom that directs attack of the butyllithium, again by complexation with the Li atom.

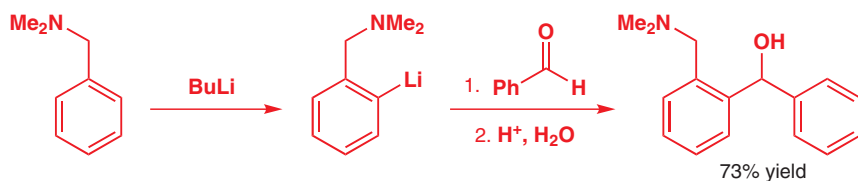

■ Compare the methods for making organolithiums or Grignard reagents that you met in Chapter 9—most of them rely on formation of an organometallic by reduction of an alkyl or aryl halide.

Ortholithiation is a useful way of making reactive organometallics because the starting material does not need to contain a halogen atom. But it is much less general than the other ways we have told you about for making organolithiums, as there are rather tight restrictions on what sorts of groups the aromatic ring must carry. The best ortholithiation-directing substituents have lone pairs to donate electrons to Li and are also electronegative so they withdraw electrons from the benzene ring and help stabilize the anion forming at the *ortho* position.

Fredericamycin

Fredericamycin is a curious aromatic compound extracted in 1981 from the soil bacterium *Streptomyces griseus*. It is a powerful antibiotic and antitumour agent, and its structure is shown below. The first time it was made in the laboratory, in 1988, the chemists in Boston started their synthesis with three consecutive lithiation reactions: two are ortholithiations, and the third is slightly different. You needn't be concerned about the reagents that react with the organolithiums; just look at the lithiation reactions themselves. In each one, one or more oxygen atoms (colour-coded green) directs a strongly basic reagent to remove a nearby proton (colour-coded black). As it happens, none of the steps uses *n*-BuLi itself, but instead its more reactive cousins, *sec*-BuLi and *tert*-BuLi (see the table on p. 186). The third lithiation step uses a different kind of base related to LDA, made by deprotonating an amine (pK_a about 35). The black proton removed in this third lithiation is more acidic because it is next to an aromatic ring.

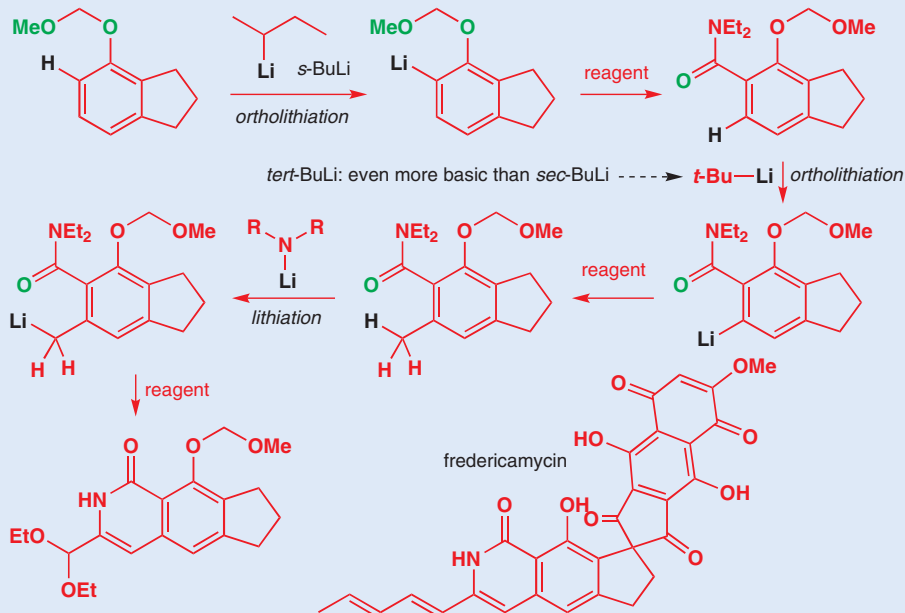

Sulfonation may lead to *ortho* selectivity without lithiation

We introduced sulfonation in Chapter 21 but have left detailed discussion until now because sulfonation has some features that make it more interesting than first meets the eye. One important difference between sulfonation and other examples of electrophilic substitution is that sulfonation is *reversible*. Heating an arenesulfonic acid causes it to decompose with loss of gaseous SO_3 .

Here's an example of how we can exploit this to gain control of regioselectivity without resorting to lithiation. In stage 1 the phenol is sulfonated twice—the first sulfonic acid group (which adds *para* to the OH group) is electron-withdrawing and deactivates the ring, making the introduction of the second group (which goes *ortho* to the OH and *meta* to the first sulfonic acid) harder and that of the third group harder still, which is why we can isolate the disulfonated phenol.

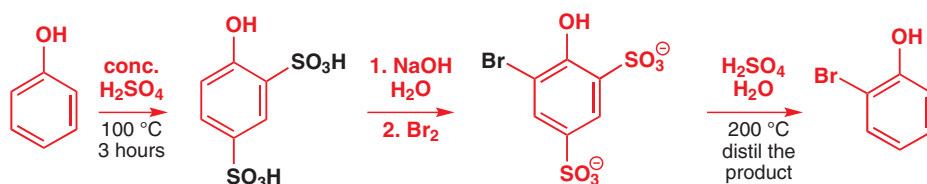

In the second stage, the bromination, the OH directs to the *ortho* and *para* positions, but only one *ortho* position is vacant, so the bromine attacks there. Sodium hydroxide is needed to deprotonate the sulfonic acid groups to make them less deactivating. The sulfonation reaction is reversible, and in the third stage it is possible to drive the reaction over to the products by distilling out the relatively volatile 2-bromophenol at high temperature. The loss of SO_3 involves attack of H^+ on the aromatic ring.

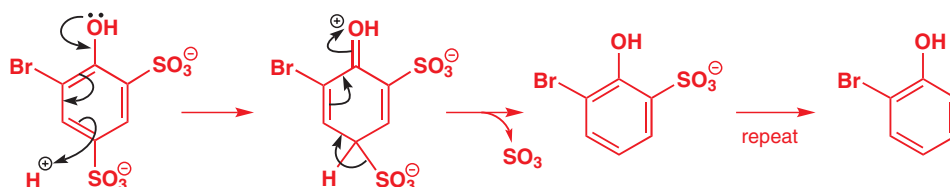

Overall, we have succeeded in making 2-bromophenol where direct bromination of phenol itself would have given (at low temperatures) mainly *p*-bromophenol and at higher temperatures, 2,4,6-tribromophenol. The sulfonic acid groups are useful reversible blocking groups.

The same method can be used with anilines because *para*-sulfonation of aromatic amines is possible. This seems surprising because in sulfuric acid essentially all the amine will be protonated. You might expect the resulting ammonium ion to react in the *meta* position (because NH_3^+ is no longer electron-rich) but instead the *para*-sulfonic acid (sulfanilic acid) is formed. At the high temperature of the reaction, it is probable that any *meta*-substituted product reverts to the starting material, while the *para*-sulfonic acid accumulates because it is stabilized by delocalization and is less hindered.

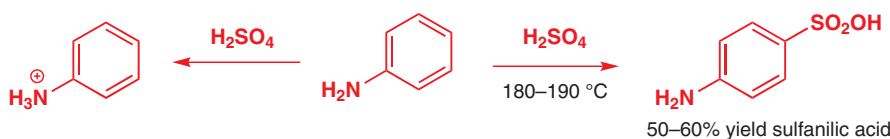

Regioselective reactions of naphthalene

We introduced you to the 10-electron aromatic system of naphthalene in Chapter 7. As you would expect, it undergoes electrophilic aromatic substitution with the same reagents you met in Chapter 21, but the regioselectivity of its reactions is of a different type to the *ortho*, *meta*,

The sulfonating agent

The exact nature of the electrophile in sulfonation reactions seems to vary with the amount of water present. Certainly for oleum (fuming sulfuric acid, that is concentrated sulfuric acid with added sulfur trioxide) and solutions of sulfur trioxide in organic solvents, the electrophile is sulfur trioxide itself, SO_3 . With more water around, H_3SO_4^+ and even $\text{H}_2\text{S}_2\text{O}_7$ have been suggested.

■ You might want to consider *why* sulfonation is reversible at high temperature in the light of our discussion of entropy and temperature on p. 248.

■ The reversibility of sulfonation with sulfuric acid may also account for the higher yield of *para* product in the sulfonation of toluene with H_2SO_4 as compared with ClSO_3H (p. 485).

Sulfa drugs

The product is important because the amides derived from it (sulfanilamides) were the first antibiotics, the sulfa drugs.

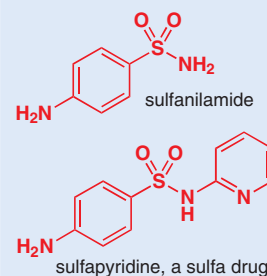

■ In Chapter 7 we pointed out that the middle bond is shorter than the rest, and for this reason we suggest you draw naphthalene with a double bond in this position—it makes mechanistic explanations more realistic.

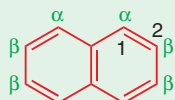

naphthalene has two sorts of ring positions

➔ Unactivated rings such as benzene need a Lewis acid to react with bromine: see p. 474.

■ Another way of looking at the difference between these two delocalized cations is that the first can be shown delocalized into the double bond without disrupting the remaining aromatic ring; in the second, all other representations of delocalized structures must lose the aromatic ring.

para selectivity we have been talking about. Naphthalene has 10 carbons: two form the ring junction, and aren't available for substitution reactions, and the other eight are of just two types α (the 1-position, next to the ring junction) and β (the 2-position).

Electrophilic substitution on naphthalene normally occurs at a site next to the ring junction (α). This is because the HOMO has its largest coefficient at this atom, but you can rationalize the result by looking at the long, linear delocalization in the resulting cation, which can be represented by a single train of arrows. This extended conjugation makes naphthalene more nucleophilic than benzene. So, bromination occurs at the α -position in good yield even without a Lewis acid.

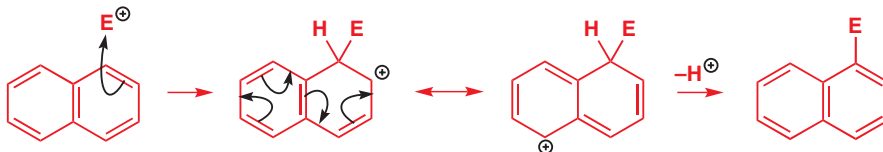

Reaction at the other position (β) is less favourable as the intermediate cation is cross-conjugated. The cation delocalizes into both rings, but no long linear chain of arrows is possible.

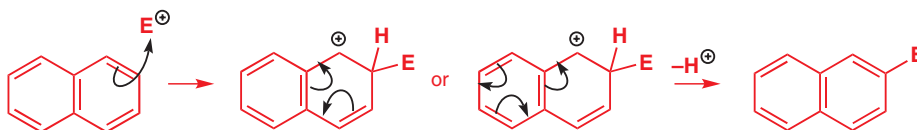

If the reaction is irreversible, the α -product is usually formed. But if the reaction is reversible, as is the case with sulfonation, the position of substitution may be determined by temperature. Sulfonation at low temperatures gives the α -product by kinetic control, while sulfonation at high temperatures gives the β -product by thermodynamic control. The β -product is formed more slowly but it is more stable as there is less steric hindrance between the large sulfonic acid group and the orange hydrogen on the other ring. Under conditions allowing reversible sulfonation, eventually all the product ends up β .

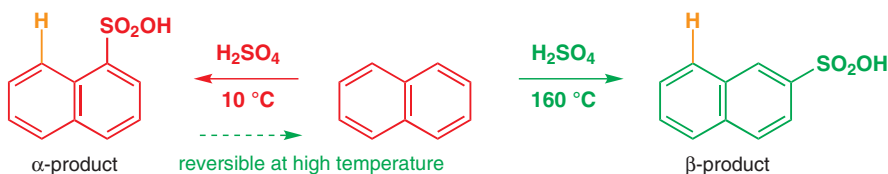

Regiocontrol by choice of route

Choosing the right route to an aromatic product is essential if you want to get one particular isomer. We can illustrate this with the synthesis of the isomers of bromonitrobenzene. Because the bromo substituent is *ortho*, *para*-directing and the nitro group *meta*-directing, it's possible to make all three isomers, providing we exploit the regioselectivity of electrophilic substitution. Nitration of bromobenzene would give the *ortho* and *para* isomers while bromination of nitrobenzene would give the *meta* isomer. The selectivity of the first reaction is not good: bromine is small and not very electronegative, so steric hindrance is weak and the *ortho* positions are not deactivated. Furthermore there are two *ortho* positions but only one *para*: a typical result is about 37% *ortho*, 1% *meta*, and 62% *para*. Both compounds are industrial products, made by nitration and separated.

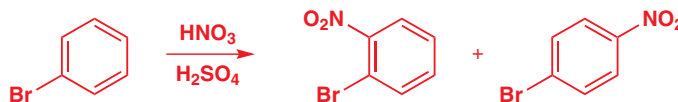

Bromination of nitrobenzene is remarkably good, considering the unreactivity of nitrobenzene in electrophilic aromatic substitution. One recipe uses iron powder and bromine at 140 °C and gives 74% of the *meta* product. We shall need these reactions in the next section.

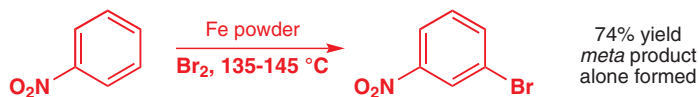

Before we move on, consider why this selectivity works: we can get all three isomers because we have one *ortho/para* director and one *meta* director. But what if we had two *ortho/para* directors—say, amino and bromo—and wanted the *meta* isomer?

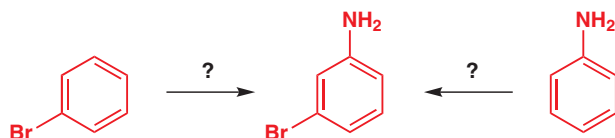

The solution in these cases is often to make use of the transformation of the nitro group (a *meta* director) into an amino group (a *para* director) by reduction.

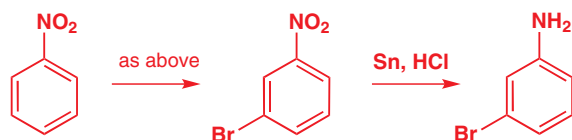

Since the amino group can be substituted by diazotization (p. 520), many problems of regioselectivity can be solved by using nitro compounds as intermediates. You could, for example, use the product above to make the otherwise challenging 3-bromoiodobenzene:

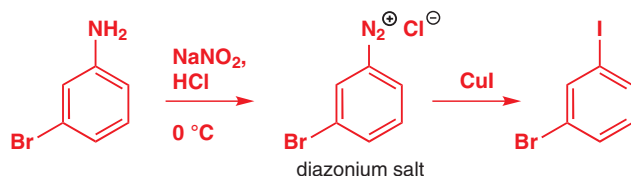

➔ Diazonium salts, and their use in the synthesis of aromatic compounds, were discussed on pp. 495 and 520.

Regioselectivity in nucleophilic aromatic substitution

As you saw in Chapters 21 and 22, diazonium salts need no activation to undergo nucleophilic aromatic substitution, but for other leaving groups a nitro group is commonly used as an activator. The three fluoronitrobenzenes are all commercial products but only the *ortho* and *para* isomers can do the nucleophilic substitution. This is because the nitro group must be able to stabilize the addition intermediate by accepting the negative charge.

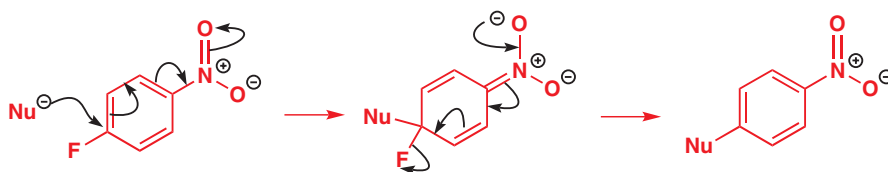

By carefully combining electrophilic and nucleophilic substitution it is possible to make aromatic compounds with substituents arranged in a precise and predictable fashion. So, if we nitrate *o*-dichlorobenzene, all positions are favourable but the nitro group goes in *para* to one Cl atom because of steric hindrance at the *ortho* positions. Although chlorine is small, two chlorines next to each other have a butressing effect as each pushes the other away. It is difficult to get three adjacent substituents on a benzene ring. If we now do a nucleophilic

➔ The various ways to carry out nucleophilic aromatic substitution are described on pp. 514–526.

aromatic substitution, only the Cl *para* to the nitro group is displaced. We can even reduce the nitro group to the corresponding amine.

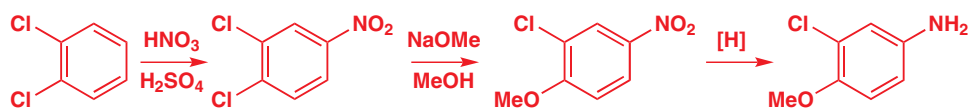

The last successful method for nucleophilic aromatic substitution uses a benzyne intermediate—on p. 524 you saw benzyne chemistry being used to make *meta*-aminoanisole, like this:

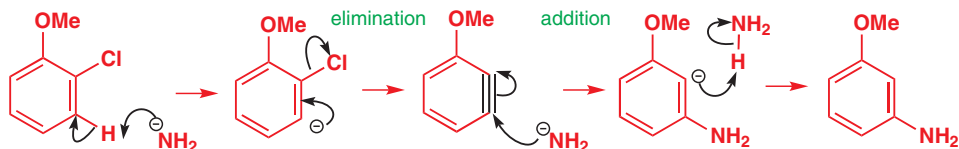

➔ The regiochemistry of this reaction is explained in Chapter 22.

Now that the amino group is fixed; we can displace it via a diazonium salt using any chosen nucleophile—copper cyanide for example:

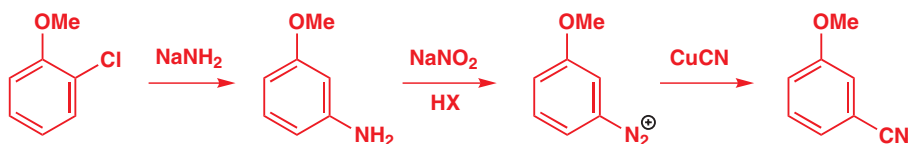

Regioselectivity of intramolecular reactions

A cunning way to get unusual regioselectivity is to make the reaction intramolecular. The synthesis from benzene of the cyclic ketone known as tetralone may look difficult as we must get an *ortho* relationship on the benzene ring. But if we make the final bond in the ring by a Friedel–Crafts acylation there is no problem. The alkyl group is *ortho,para*-directing and the acid cannot reach the *para* position.

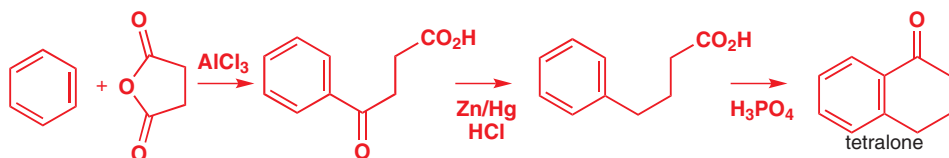

■ Usually a more powerful catalyst (AlCl_3) is needed, but intramolecular acylations are fast enough without this.

Notice the use of a cyclic anhydride in the first Friedel–Crafts acylation. It doesn't matter where the acylation occurs and the reaction stops there as the ring is deactivated by the ketone and the carboxylic acid released in the reaction is much less electrophilic than the anhydride. The ketone is then reduced to a CH_2 group by the Clemmensen method (see Chapter 23) and polyphosphoric acid is used to carry out the intramolecular acylation step.

A more subtle approach is to use a 'tether'—something that holds two reagents together and is afterwards cleaved. An example is halolactonization. The idea is simple. A halogen, say bromine, attacks an alkene and the bromonium ion intermediate is captured intramolecularly by the anion of a carboxylic acid. The reaction therefore uses bromine and NaHCO_3 —a weak base, but one strong enough to deprotonate a carboxylic acid. The anion attacks the more highly substituted end of the bromonium ion, as explained in Chapter 19, and forms a five-membered ring.

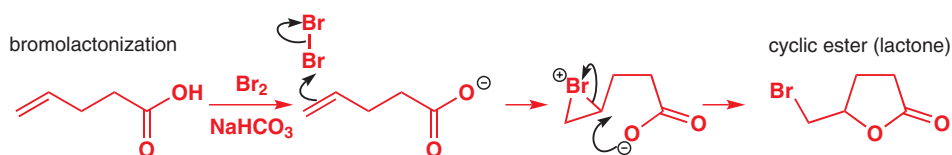

Although any halogen might be used in this reaction, iodine is the most versatile and the reaction is commonly called iodolactonization. The tether is the C–O bond of the lactone and this can be cleaved with an alkoxide.

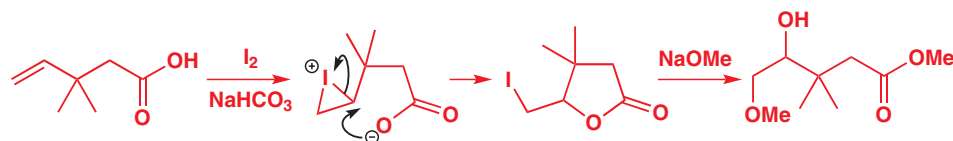

The reaction with methoxide needs some explanation. Attack on the carbonyl group cleaves the lactone, releasing an alkoxide that cyclizes to form an epoxide. A second molecule of methoxide now attacks the epoxide, opening it from the less hindered end as we should expect in an anionic reaction (Chapter 19).

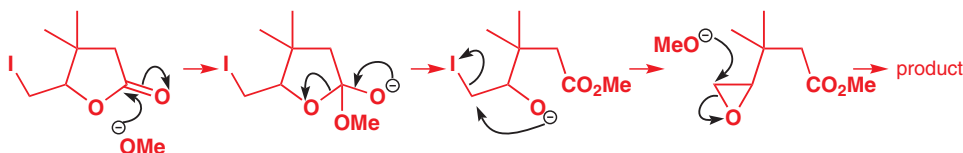

Another example shows that reaction may occur at the other end of the iodonium ion. Attack at the tertiary carbon would be difficult sterically and, in any case, would give an unstable four-membered ring. The lactone formed has the iodine β to the carbonyl group and so eliminates easily in base (pyridine works well) by the E1cB mechanism (Chapter 17) to give the unsaturated lactone. Although the relative stereochemistry of the iodolactone is controlled by the inversion in the opening of the iodonium ion, it is irrelevant as it disappears in the elimination step.

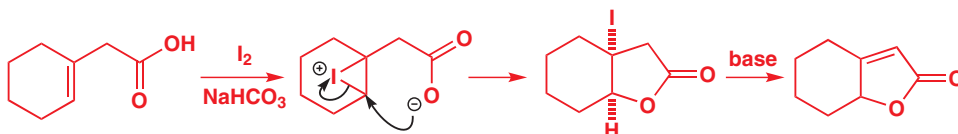

➔ We'll come back to the use of iodolactonization to control stereochemistry in Chapter 32.

Regioselectivity in elimination reactions

This question was discussed in Chapter 17 but we can return to it here with more sophisticated examples. The regioselectivity in the last reaction of the sequence above dictates the position of the alkene in the product. Of all of the protons adjacent to the iodo group, only a black one is lost:

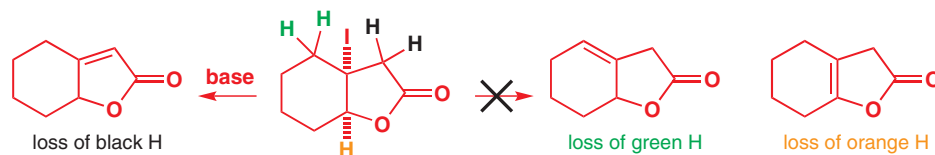

The orange hydrogen cannot be lost by E2 as it is *cis* to the iodine and E2 reactions prefer a *trans* (anti-periplanar) arrangement. The green hydrogens are not lost because they are less acidic than the black hydrogens. In fact, this is not an E2 elimination at all. Because one of the black hydrogens can be lost in enolate formation, this is an E1cB elimination.

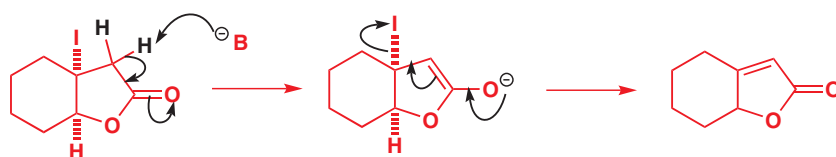

But now another regioselectivity question arises: if elimination occurs preferably towards the carbonyl group, how can we make the starting material for the iodolactonization sequence, which has the alkene not in conjugation with the carboxylic acid? It turns out that it is better to make the ester with the ‘wrong’ regioselectivity. This is easily done by a Horner–Wadsworth–Emmons reaction using a phosphonate ester. This Wittig-style reaction is explained in Chapter 27.



Now comes the remarkable regioselectivity. The ester is hydrolysed, as usual, in aqueous NaOH. On acidification to pH 3, the free acid is released and the double bond has moved into the ring.

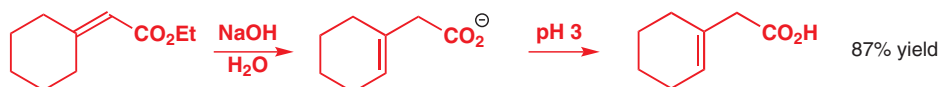

Alkenes like to be conjugated with carbonyl groups but they also prefer to be *inside* six-membered rings rather than *outside*—in this case presumably because the ester group otherwise has to eclipse a ring carbon. Conjugation with an ester group pulls the alkene out of the six-membered ring in the lactone we made above, but when the carbonyl group is a carboxylate anion, conjugation is very weak and the double bond moves into the ring.

Electrophilic attack on alkenes

You met electrophilic attack on alkenes in Chapter 19 and we shall just briefly revisit its regioselectivity. Unsymmetrical alkenes add HBr to give the more stable of the two possible cations. If R is alkyl or aryl, this means the more substituted cation.

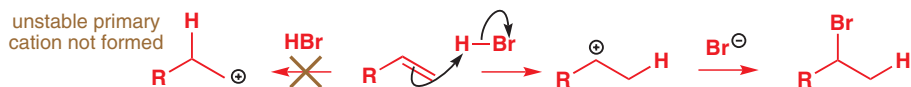

If you want to get the other regioisomer, with the heteroatom at the end, you can use hydroboration (Chapter 19) or the radical reactions described in the next section. Here is a brief reminder of hydroboration. Reaction between a borane having at least one B–H bond with an alkene gives an alkyl borane in which all the hydrogens are replaced by alkyl groups. Oxidation gives the terminal alcohol.

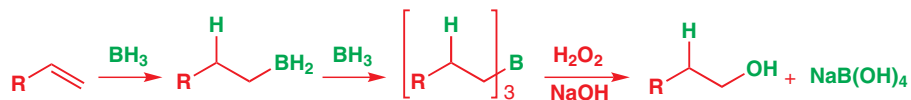

The regioselectivity comes from the first step. The boron's empty p orbital bonds to the more nucleophilic end of the alkene and hydride is transferred to give a borane. Reaction with alkaline H₂O₂ leads to migration of an alkyl group from boron to oxygen and eventually to the alcohol.

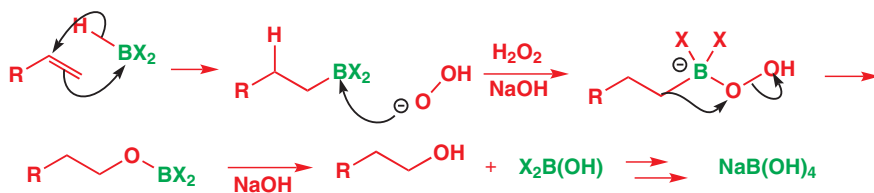

■ In these structures X can be R or H.

Interactive mechanism for hydroboration

Borane is unstable but can easily be made from NaBH_4 and BF_3 . In this synthesis of hexan-1-ol from hex-1-ene, a water molecule has been added to the alkene, but with the opposite regioselectivity to reactions with H_2O in acid or HBr .

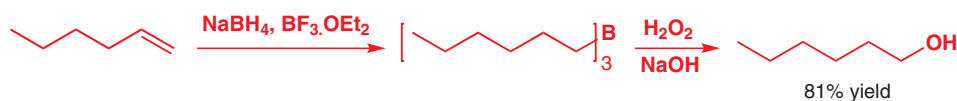

Regioselectivity in radical reactions

Almost every reaction we have discussed so far has been ionic, but in this short section we need to give you a preview of another group of reactions we return to in Chapter 37—those of *radicals*. When HBr adds to an unsymmetrical alkene we use arrows that represent the movement of two electrons to give charged intermediates that combine in a second step to give a neutral product. The strong $\text{H}-\text{Br}$ bond breaks to give a bromide ion and a stable alkyl cation. This bond breaks *heterolytically*—that is, unsymmetrically—as does the alkene bond. We can predict the regiochemistry of these reactions by making the most stable anions and cations as intermediates, in this case a tertiary alkyl cation and a bromide anion.

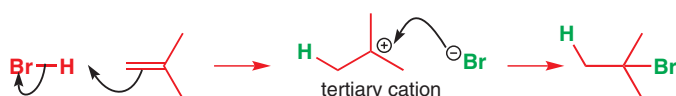

➔ You'll meet radicals in much greater detail in Chapter 37.

Radical addition

The regioselectivity in the reaction below is opposite: a primary alkyl bromide is formed, by a different mechanism involving radicals.



In radical reactions, bonds break *homolytically* with one electron going one way and one the other. The radicals that are formed have an odd number of electrons, one of which must be unpaired. This makes them very reactive and they are not usually isolated. Even strong bonds can break into ions provided they are polarized, but to make radicals we need weak symmetrical bonds such as $\text{O}-\text{O}$, $\text{Br}-\text{Br}$ or $\text{I}-\text{I}$. Dibenzoyl peroxide, the $\text{Ph}(\text{CO}_2)_2$ catalyst in this reaction, readily undergoes homolysis like this—the one-electron movements are represented by 'fish-hook' arrows having one barb and odd electrons on atoms are represented by dots.

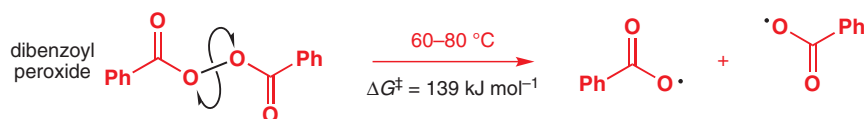

Now we can use the new radicals we have just made to cleave the strong HBr bond homolytically because a new and very strong OH bond will be formed. As we start with one radical intermediate that must have an unpaired electron, we must finish with another radical with an unpaired electron. In this case, it is a bromine radical.



If we do this reaction in the presence of the alkene we have just reacted with HBr , the bromine radical adds to the alkene in one of the two possible ways. Although radicals are neutral,

they are electron-deficient (the C atom is one electron short) and, rather like cations, are more stable the more substituents they have. So the tertiary radical is formed rather than the primary radical, and the bromine ends up at the primary position.

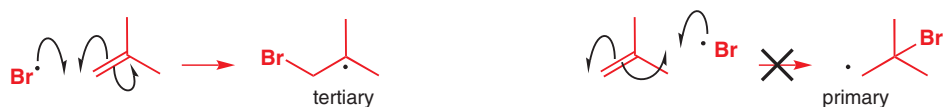

We have still not reached the end of the reaction as our product is still a radical. How can it become a molecule with only paired electrons? The answer is simple. It reacts with another HBr molecule to produce more bromine radicals. Now you see something important to all radical reactions: only a small amount of the radical is needed as more radicals are produced every time the reaction gives product. The overall process is a *radical chain reaction*.

Interactive mechanism for radical addition of HBr to alkenes

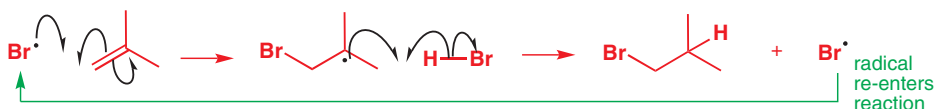

Because of this we also need only very small amounts of dibenzoyl peroxide, the radical initiator, which is just as well as it is potentially explosive, like many radical generators. Here is the reaction being used to make a bromoacid:

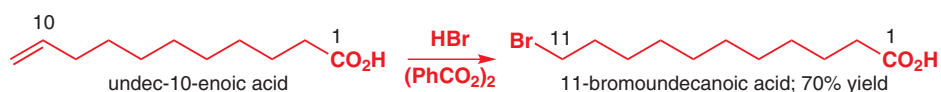

Radical abstraction

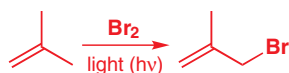

We sneaked a new reaction into that sequence. The removal of a hydrogen atom (note: not a proton) from HBr by the peroxide radical is an *abstraction* reaction. The bromine radical will also abstract hydrogen atoms and will do so from the same alkene we have just used but with yet another different outcome, as you see in the margin.

When light shines on bromine, the weak Br–Br bond breaks to give two bromine radicals. Heat will do the job too but light is cleaner and, as bromine is brown, it absorbs most wavelengths of visible light.

■ Note that the Br–Br bond is more stable than the O–O bond in the peroxide.

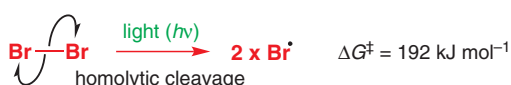

Radicals are very unstable and reactive, and these bromine radicals may simply recombine or they may react with other compounds. You already know that bromide anions are good nucleophiles in $\text{S}_{\text{N}}2$ reactions, but bromine radicals do two quite different reactions: abstraction and addition. The Br radical may abstract a hydrogen atom from the alkene or it may add to the π bond. Notice that each reaction produces a new carbon-centred radical and, in the first case, a molecule of HBr. Whereas the Br–Br bond is weak, the H–Br bond is much stronger (366 kJ mol^{-1}) and, unlike ionic reactions, radical reactions are dominated by bond strength.

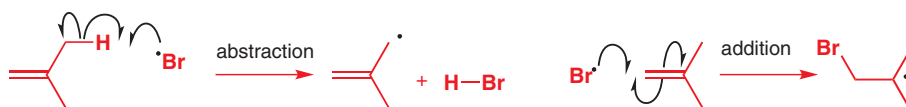

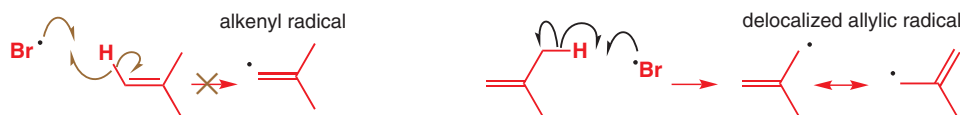

The first reaction introduces another important aspect of regioselectivity: why does the radical abstract that H atom, and not one from the alkene?

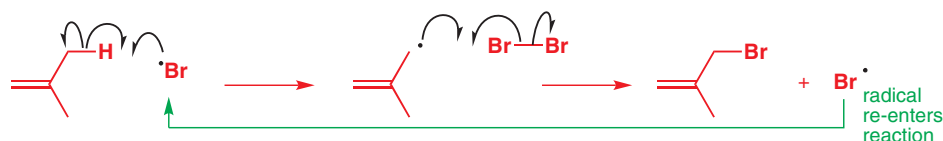

Removal of an alkene H gives a carbon-centred radical localized on the sp^2 atom but the removal of an H from a methyl group gives a much more stable delocalized allylic radical. In addition there are six such H atoms but only two alkene H atoms.

The reaction obviously cannot end there with the formation of another radical, however stable, and this allylic radical collects a bromine atom from a bromine molecule. Note that the allylic radical doesn't react with a bromine radical in this step: radicals are very unstable and the concentration of radicals at any one time is so low that it is rare for two of them to meet.



 Interactive mechanism for allylic bromination

This step also produces a new bromine radical that can start a new series of reactions. Like the addition of HBr above, the reaction is a radical chain reaction, and only a small amount of Br_2 needs to break down to $Br^•$ to get the reaction going. This is important as you already know what happens when bromine molecules react with alkenes: addition occurs by an ionic mechanism. Add too much Br_2 and the bromine molecules attack the alkene directly and do not abstract H atoms.



If we want to make the dibromide, we use plenty of bromine, but if we want to use a radical process to make the allylic bromide we must take advantage of the greater reactivity of the radical and keep the bromine concentration low. A good way to do this is to use the compound NBS (*N*-bromosuccinimide), which you met in Chapter 19. NBS acts as a sort of turnstile which only lets a molecule of Br_2 out when a molecule of HBr is formed (and of course HBr is the by-product in the radical bromination).

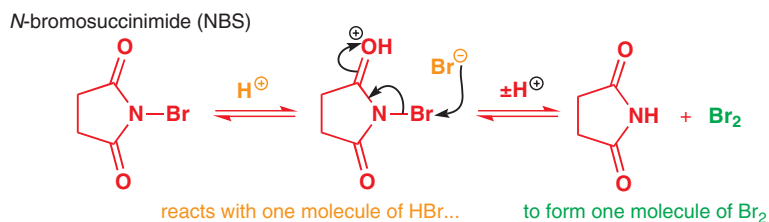

Br_2 is slowly released into the reaction as it proceeds, and the concentration never builds up enough to generate the dibromide. In this example, dibenzoyl peroxide is the initiator and allylic bromination gives the useful cyclohexenyl bromide.

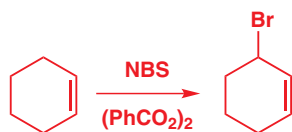

These radical reactions will be described in much greater detail in Chapter 37. For the moment you need only notice that they can have quite different regioselectivity from ionic reactions with the same reagents.

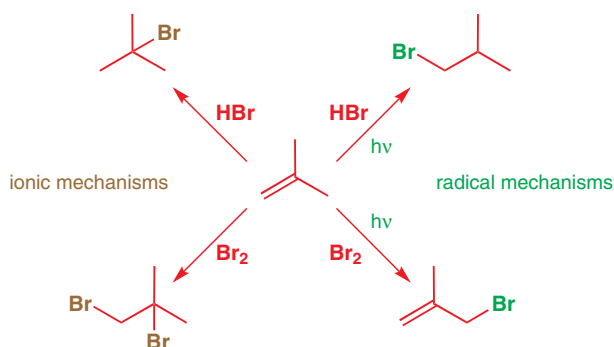

Nucleophilic attack on allylic compounds

The allylic bromides that can be made by these radical reactions display interesting regioselectivity. We shall start with some substitution reactions with which you are familiar from Chapter 15. There we said that allyl bromide is about 100 times more reactive towards simple S_N2 reactions than is propyl bromide or other saturated alkyl halides.

The double bond stabilizes the S_N2 transition state by conjugation with the p orbital at the carbon atom under attack. This full p orbital (shown in orange in the diagram below) forms a partial bond with the nucleophile and with the leaving group in the transition state. Any stabilization of the transition state will, of course, accelerate the reaction by lowering the energy barrier.

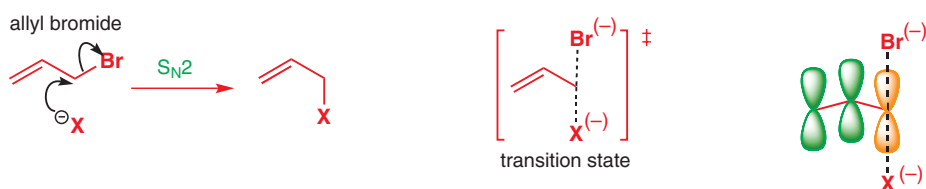

There is an alternative mechanism for this reaction that involves nucleophilic attack on the alkene instead of on the saturated carbon atom. This mechanism leads to the same product and is often called the S_N2' (pronounced 'S-N-two-prime') mechanism.

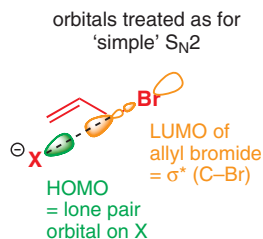

We can explain both mechanisms in a unified way if we look at the frontier orbitals involved. The nucleophile must attack an empty orbital (the LUMO), which we might expect to be simply σ^* (C-Br) for the S_N2 reaction. But this ignores the alkene. The interaction between π^* (C=C) and the adjacent σ^* (C-Br) will as usual produce two new orbitals, one higher and one lower in energy. The lower-energy orbital, $\pi^* + \sigma^*$, will now be the LUMO. To construct this orbital we must put all the atomic orbitals parallel and make the contact between $\pi^* + \sigma^*$ a bonding interaction.

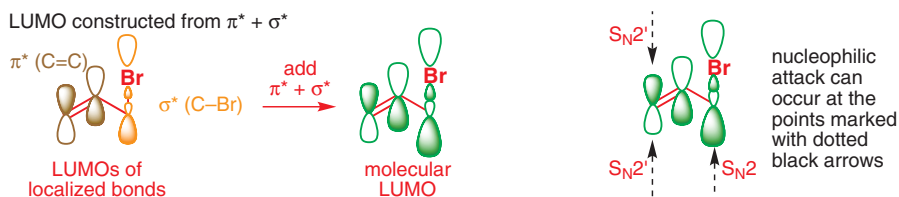

If the allylic halide is unsymmetrically substituted, a question of regioselectivity arises. The products from S_N2 and S_N2' are different and the normal result is that nucleophilic attack occurs at the less hindered end of the allylic system, whether that means S_N2 or S_N2' . This important allylic bromide, known as prenyl bromide, normally reacts entirely via the S_N2 reaction.

prenyl bromide reacts like this

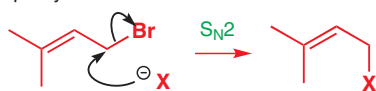

and not like this

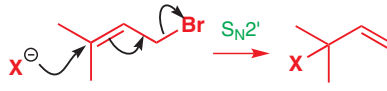

The two ends of the allylic system are contrasted sterically: direct (S_N2) attack is at a primary carbon while allylic (S_N2') attack is at a tertiary carbon atom so that steric hindrance favours the S_N2 reaction. In addition, the number of substituents on the alkene product means that the S_N2 product is nearly always preferred— S_N2 gives a trisubstituted alkene while the S_N2' product has a less stable monosubstituted alkene.

An important example is the reaction of prenyl bromide with phenols. This is simply carried out with K_2CO_3 in acetone as phenols are acidic enough ($pK_a \sim 10$) to be substantially deprotonated by carbonate. The product is almost entirely from the S_N2 route, and is used in the Claisen rearrangement (Chapter 35).

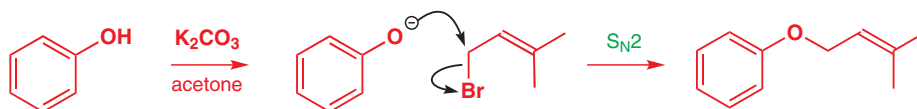

If we make the two ends of the allyl system more similar, say one end primary and one end secondary, things are more equal. We could consider the two isomeric butenyl chlorides.

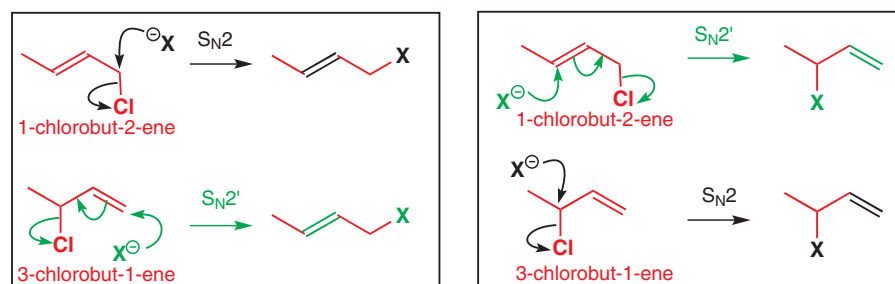

All routes look reasonable, although we might again expect faster attack at the primary carbon. The reactions in the left-hand box are preferred to those in the right-hand box. But there is no special preference for the S_N2 over the S_N2' mechanism or vice versa—the individual case decides. If we react the secondary butenyl chloride with an amine we get the S_N2' mechanism entirely.

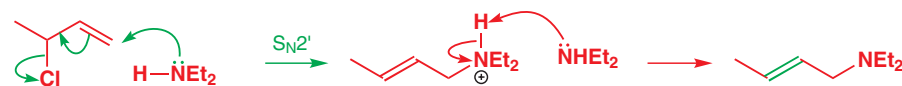

If the primary chloride is used, once again we get nucleophilic attack at the primary centre. The more stable product with the more highly substituted alkene is formed this time by the S_N2 reaction. Here is a slightly more advanced example:

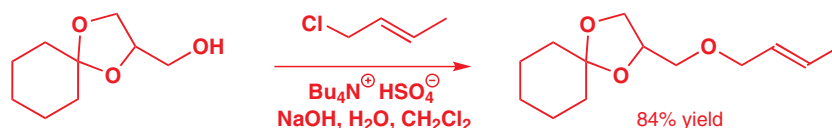

So far we have used the word 'allyl' to describe these compounds. Strictly, that word applies only to specific compounds $CH_2=CH-CH_2X$ with no substituents other than hydrogen. Allyl is often used loosely to describe any compound with a functional group on the carbon atom *next* to the alkene. We shall use 'allylic' for that and 'allyl' only for the unsubstituted version.

Interactive mechanisms for various nucleophilic substitutions

Interactive mechanism for S_N2' nucleophilic substitutions

► We explained why adjacent double bonds assist S_N2 reactions on p. 341.

Notice that these reactions take place with allylic chlorides. We should not expect an alkyl chloride to be particularly good at S_N2 reactions as chloride ion is only a moderate leaving group and we should normally prefer to use alkyl bromides or iodides. Allylic chlorides are more reactive because of the alkene. Even if the reaction occurs by a simple S_N2 mechanism without rearrangement, the alkene is still making the molecule more electrophilic.

You might ask a very good question at this point. How do we know that these reactions really take place by S_N2 and S_N2' mechanisms and not by an S_N1 mechanism via the stable allylic cation? Well in the case of prenyl bromide, we don't! In fact, we suspect that the cation probably is an intermediate because prenyl bromide and its allylic isomer are in rapid equilibrium in solution at room temperature.

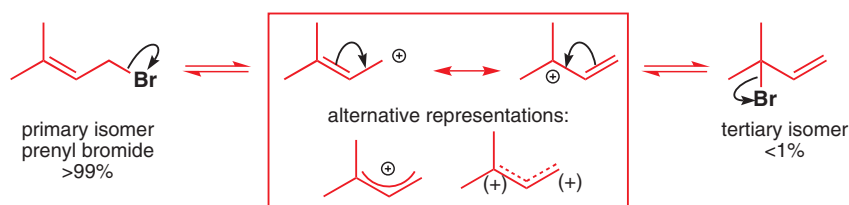

The equilibrium is entirely in favour of prenyl bromide because of its more highly substituted double bond. Reactions on the tertiary allylic isomer are very likely to take place by the S_N1 mechanism: the cation is stable because it is tertiary and allylic and the equilibration tells us it is already there. Even if the reactions were bimolecular, no S_N2' mechanism would be necessary for the tertiary bromide because it can equilibrate to the primary isomer more rapidly than the S_N2 or S_N2' reaction takes place.

Even the secondary system we also considered is in rapid equilibrium when the leaving group is bromide. This time both allylic isomers are present, and the primary allylic isomer (known as crotyl bromide) is an *E/Z* mixture. The bromides can be made from either alcohol with HBr and the same ratio of products results, indicating a common intermediate in the two mechanisms. You saw at the beginning of Chapter 15 that this reaction is restricted to alcohols that can react by S_N1 .

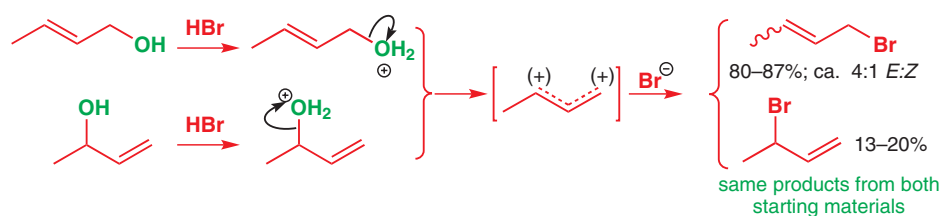

Displacement of the bromide by cyanide ion, using the copper(I) salt as the reagent, gives a mixture of nitriles in which the more stable primary nitrile predominates even more. These can be separated by a clever device. Hydrolysis in concentrated HCl is successful with the predominant primary nitrile but the more hindered secondary nitrile does not hydrolyse. Separation of compounds having two different functional groups is easy: in this case the acid can be extracted into aqueous base, leaving the neutral nitrile in the organic layer.

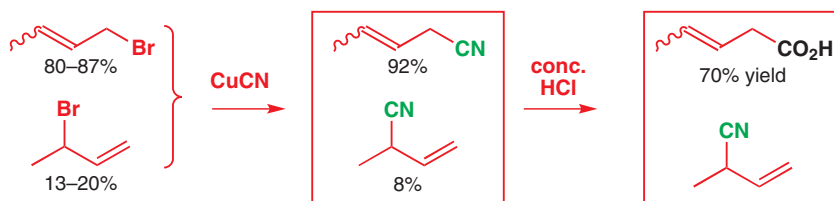

Once again, we do not know for sure whether this displacement by cyanide goes by the S_N1 or S_N2' mechanism, as the reagents equilibrate under the reaction conditions. However, the

chlorides do *not* equilibrate and so, if we want a clear-cut result on a single well-defined starting material, the chlorides are the compounds to use. But you already see that regioselectivity with allylic compounds may depend on steric hindrance, rates of reaction, and stability of the product.

Regiospecific preparation of allylic chlorides

Allylic alcohols are good starting materials for making allylic compounds with control over where the double bond and the leaving group will be. Allylic alcohols are easily made by addition of Grignard reagents or organolithium compounds to enals or enones (Chapter 9) or by reduction of enals or enones (Chapter 23). More to the point, they do not equilibrate except in strongly acidic solution, so we know which allylic isomer we have.

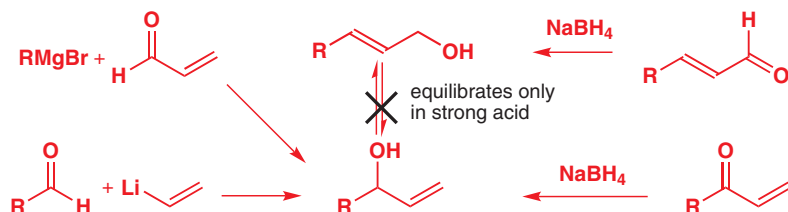

Conversion of the alcohols into the chlorides is easier with the primary than with the secondary alcohols. We need to convert OH into a leaving group and provide a source of chloride ion to act as a nucleophile. One way to do this is with methanesulfonyl chloride (MeSO_2Cl) and LiCl .

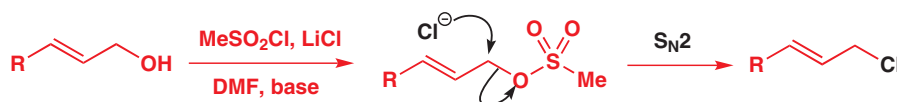

This result hardly looks worth reporting and, anyway, how do we know that equilibration or $\text{S}_{\text{N}}1$ reactions aren't happening? Well, here the mechanism must be $\text{S}_{\text{N}}2$ because the corresponding *Z*-allylic alcohol preserves its alkene configuration. If there were equilibration of any sort, the *Z*-alkene would give the *E*-alkene because *E*- and *Z*-allylic cations are not geometrically stable.

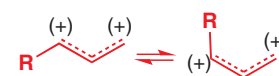
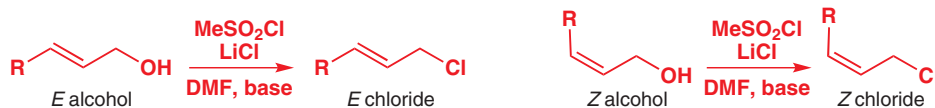

no cation can be involved because *E* and *Z* carbocations are in rapid equilibrium

Sadly, this method fails to preserve the integrity of the secondary allylic alcohol, which gives a mixture of allylic chlorides.

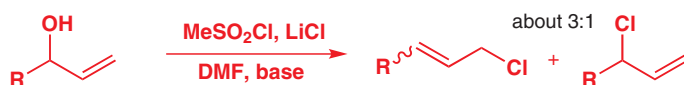

Reliable clean $\text{S}_{\text{N}}2$ reactions with secondary allylic alcohols can be achieved only with Mitsunobu chemistry. Here is a well-behaved example with a *Z*-alkene. The reagents have changed since your last encounter with a Mitsunobu-type reaction: instead of DEAD and a carboxylic acid we have hexachloroacetone, with, of course, triphenylphosphine.

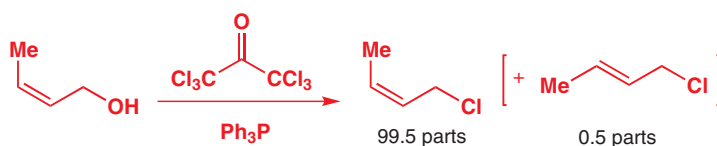

➔ The Mitsunobu reaction was discussed in Chapter 15, p. 349. Mitsunobu chemistry involves using a phosphorus atom to remove the OH group, after the style of PBr_3 as a reagent to make alkyl bromides from alcohols.

allylic chlorides do not equilibrate

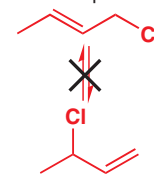

■ By analogy with *stereospecific*, we can define *regiospecific* to mean a reaction where the regiochemistry (that is, the location of the functional groups) of the product is determined by the regiochemistry of the starting material.

The first thing that happens is that the lone pair on phosphorus attacks one of the chlorine atoms in the chloroketone. The leaving group in this S_N2 reaction at chlorine is an enolate, which is a basic species and can remove the proton from the OH group in the allylic alcohol.

■ Phosphorus doing a substitution at a C–Cl bond the wrong way round? But P is soft, so it cares little about the polarization of the bond, only about the energy of the C–Cl σ^* . The energy is the same whichever end of the bond is attacked. You may see similar reactions of PPh_3 with CBr_4 or CCl_4 : all produce stabilized carbanions.

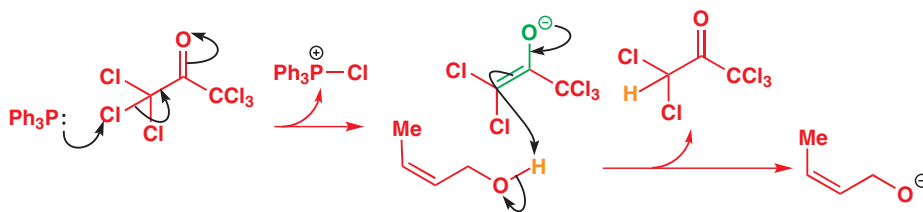

Now the alkoxide anion can attack the positively charged phosphorus atom. This is a good reaction in two ways. First, there is the obvious neutralization of charge and, second, the P–O bond is very strong.



■ We looked at the converse—'loose' S_N2 transition states with considerable S_N1 character—in the reactions of bromonium ions and protonated epoxides in Chapter 17.

The next step is a true S_N2 reaction at carbon as the very good leaving group is displaced. The already strong P–O single bond becomes an even stronger P=O double bond to compensate for the loss of the strong C–O single bond. There is obviously no S_N1 component in this displacement (otherwise the *Z*-alkene would have partly isomerized to the *E*-alkene) and very little S_N2' presumably as only 0.5% of the rearrangement product is formed. These displacements of $Ph_3P=O$ are often the 'tightest' of S_N2 reactions.

Now for the really impressive result. Even if the alcohol is secondary, and the rearranged product would be thermodynamically more stable, very little of it is formed and almost all the reaction is clean S_N2 .

S_N2 preferred to S_N2'

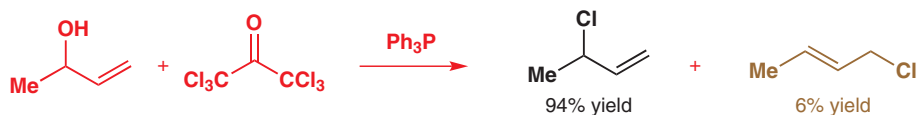
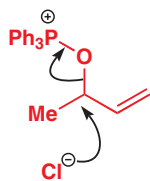

There is a bit more rearrangement than there was with the other isomer but that is only to be expected. The very high proportion of direct S_N2 product shows that there is a real preference for the S_N2 over the S_N2' reaction in this displacement.

Now that we know how to make allylic chlorides of known structure—whether primary or secondary—we need to discover how to replace the chlorine with a nucleophile with predictable regioselectivity. We have said little so far about carbon nucleophiles (except cyanide ion) so we shall concentrate on simple carbon nucleophiles in the S_N2' reaction of allylic chlorides.

The S_N2' reaction of carbon nucleophiles on allylic chlorides

Ordinary carbon nucleophiles such as cyanide or Grignard reagents or organolithium compounds fit the patterns we have described already. They usually give the more stable product by S_N2 or S_N2' reactions depending on the starting material. If we use copper compounds, there is a tendency—no more than that—to favour the S_N2' reaction. You will recall that copper(I) was the metal we used to ensure conjugate addition to enones (Chapter 22) and its use in S_N2' reactions is obviously related. Simple alkyl copper reagents (RCu , known as Gilman reagents) generally favour the S_N2' reaction but we can do much better by using RCu complexed with BF_3 .

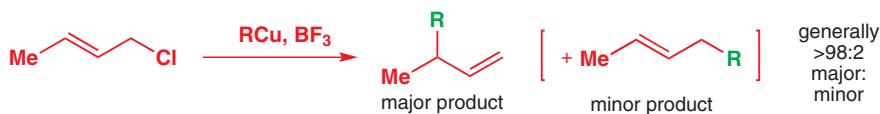

➔ The nature of metal–alkene complexes is discussed in Chapter 40.

The copper must complex to the alkene and then transfer the alkyl group to the S_N2' position as it gathers in the chloride. This might well be the mechanism, although it is often difficult to draw precise mechanisms for organometallic reactions.

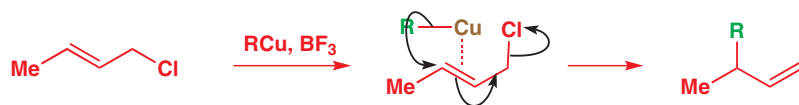

The secondary allylic isomer also gives almost entirely the rearranged product. This is perhaps less surprising, as the major product is the more stable isomer, but it means that either product can be formed in high yield simply by choosing the right (or should we say *wrong*, since there is complete allylic rearrangement during the reaction) isomer. The reaction is *regiospecific*.

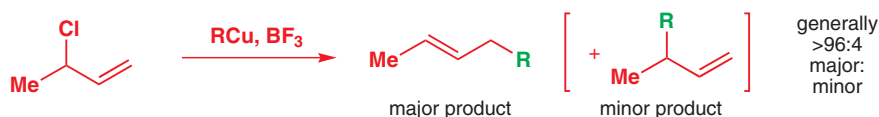

The most remarkable result of all is that prenyl chloride gives rearranged products in good yield. This is about the only way in which these compounds suffer attack at the tertiary centre by S_N2' reaction when there is the alternative of an S_N2 reaction at a primary centre.

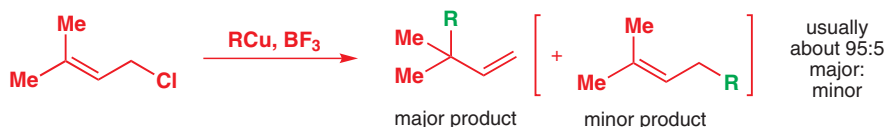

Electrophilic attack on conjugated dienes

Another way to make allylic chlorides is by treating dienes with HCl. Electrophiles attack conjugated dienes more readily than they do isolated alkenes. There was some discussion of this in Chapter 19, establishing the main point that the terminal carbon atoms are the most nucleophilic and that the initial attack produces an allylic cation. A simple example is the addition of HCl to cyclopentadiene.

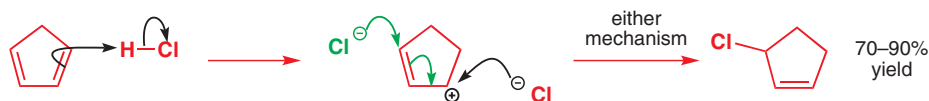

Although there is a question of regioselectivity in the initial protonation, the allylic cation is symmetrical and attack by chloride at either end produces the same product. However, if the electrophile is a halogen rather than HCl or HBr then the reaction becomes regioselective as the cationic intermediate is no longer symmetrical. What happens is this:



The alternative is direct attack on the bromonium ion intermediate, which we assume would occur at the allylic site (black arrows) and not at the other (green arrows). Although this 1,2-dibromide product is not observed, it is still possible that this reaction happens because the 1,2-product can rearrange by bromide shift to the observed 1,4-dibromide.

➔ By 'bromide shift' we mean the reversible isomerization of allylic bromides you saw on p. 576.

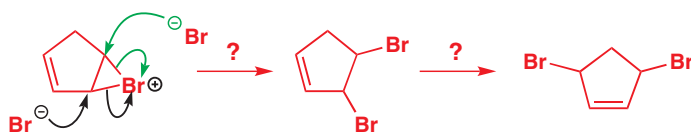

The final product of this reaction could in fact be either of two compounds as the two bromine atoms may be *cis* or *trans*. Bromination in chloroform at $-20\text{ }^{\circ}\text{C}$ gives mostly a liquid *cis* dibromide while reaction in hydrocarbon solvents gives the crystalline *trans* isomer. On standing the *cis* isomer slowly turns into the *trans*.

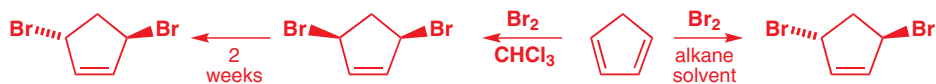

This suggests that the *cis* bromide is the kinetic product and the more stable *trans* compound is the thermodynamic product, formed by reversible loss of bromide and reformation of the bromonium ion.

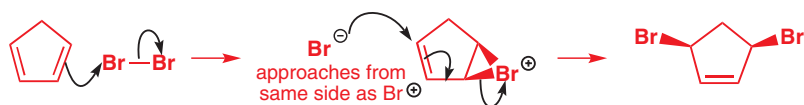

Similar questions arise when nucleophilic substitution occurs on the dibromides. Reaction of either the *cis* or the *trans* dibromide with dimethylamine gives the *trans* isomer of a diamine. But look at the regioselectivity—it's not the diamine you might expect. The only explanation is one $\text{S}_{\text{N}}2$ displacement and one $\text{S}_{\text{N}}2'$ displacement.

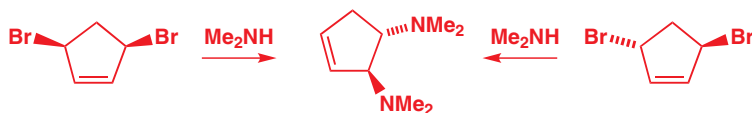

But what about the stereochemistry? Starting with the *cis* isomer, one $\text{S}_{\text{N}}2$ displacement with inversion might be followed by an intramolecular $\text{S}_{\text{N}}2'$ displacement and finally another $\text{S}_{\text{N}}2$ displacement with inversion at the allylic centre.

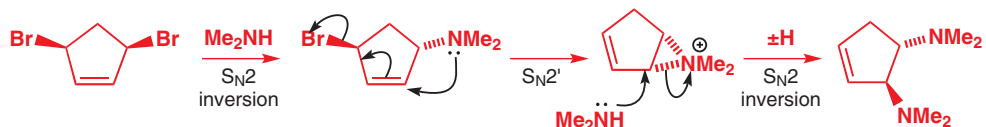

The reaction with the *trans* isomer is almost identical: the same three-membered ring is an intermediate in both sequences so the products are bound to be the same.

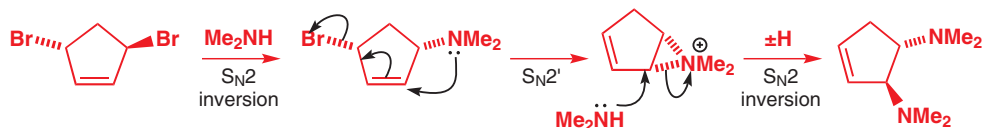

If the nucleophile is different from the electrophile we can get a bit more information about the course of the reaction. When butadiene is treated with bromine in methanol as solvent, two adducts are formed in a 15:1 ratio along with some dibromide. Methanol is a weak nucleophile and adds to the bromonium ion mainly at the allylic position (black arrow below); only a small amount of product is formed by attack at the far end of the allylic system. Note that no attack occurs at the other end of the bromonium ion (green dotted arrow).

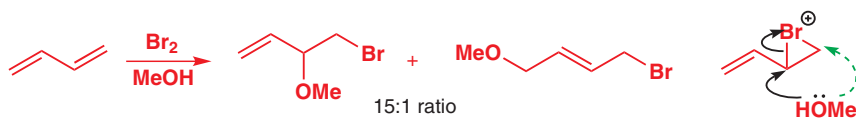

Conjugate addition

In Chapter 22 we devoted considerable space to discussing conjugate addition and the reasons why some reactions occur by direct attack on the carbonyl group of an α,β -unsaturated carbonyl compound and why others occur by conjugate addition. We shall briefly revise the regioselectivity aspects of these reactions.

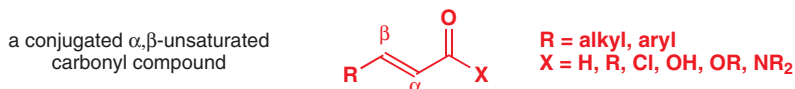

Direct (or 1,2) addition means that the nucleophile attacks the carbonyl group directly. An addition compound is formed which may lose X^- , if it is a leaving group, or become protonated to give an alcohol.

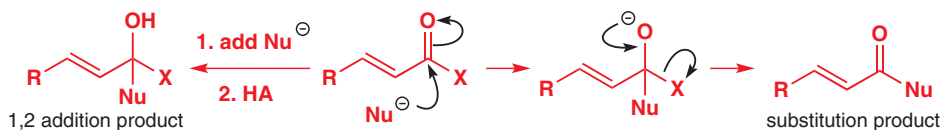

Conjugate (or 1,4) addition means that the nucleophile adds to the end of the alkene furthest from the carbonyl group. The electrons move through into the carbonyl group to produce an enolate anion that usually becomes protonated to give a ketone.

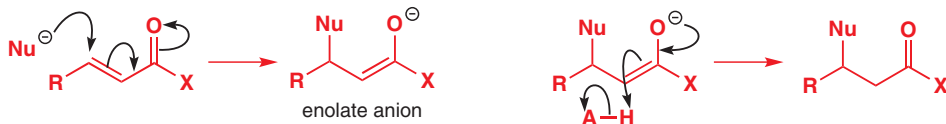

The first difference between the two routes is that the product from direct addition keeps the alkene but loses the carbonyl group while conjugate addition keeps the carbonyl group but loses the alkene. As a $C=O$ π bond is stronger than a $C=C$ π bond, **conjugate addition gives the thermodynamic product**. But as the carbonyl group is more electrophilic than the far end of the alkene, especially to charged, hard nucleophiles, **direct addition gives the kinetic product**. So direct addition is favoured by low temperatures and short reaction times while conjugate addition is favoured by higher temperatures and longer reaction times, provided the 1,2 addition is reversible.

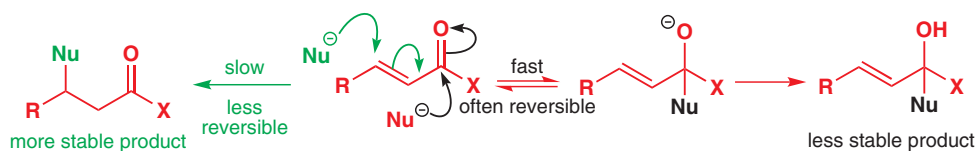

The second difference depends on how electrophilic is the α,β -unsaturated carbonyl compound. The more electrophilic such as aldehydes and acid chlorides tend to prefer direct addition while the less electrophilic such as ketones or esters tend to prefer conjugate addition.



It is similar with the choice of nucleophile: more nucleophilic species, such as MeLi or Grignard reagents, prefer direct addition, particularly as they react irreversibly, while less nucleophilic species like amines and thiols prefer conjugate addition. These nucleophiles add reversibly to the C=O group, giving an opportunity for any direct addition product to revert to starting materials and react again.



Regioselectivity in action

We finish with an example that illustrates several aspects of chemoselectivity as well as introducing the subjects of the next two chapters. The first synthetic sweetener was saccharin but newer ones such as the BASF compound thiophenesaccharin are much in demand. The sodium salt is the active sweetener but the neutral compound has to be made via the simpler intermediate thiophene.

■ Thiophene is the name for this sulfur-containing aromatic compound. There is more about it in Chapter 29.

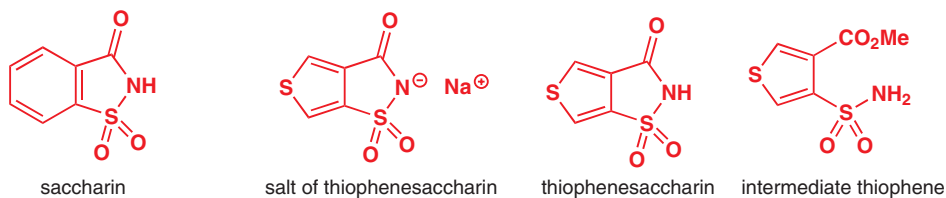
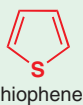

The synthesis started with a conjugate addition of a thiol to an unsaturated ester. The thiol is obviously the nucleophile and regioselectively chooses conjugate addition rather than attack on either ester group.

■ The thiol *could* attack its own ester group, leading to polymerization, but it doesn't.



In the next step the diester is treated with base and a carbonyl condensation reaction occurs of the type you will meet in Chapter 26. There is a real question of regioselectivity here: an enolate could form next to either ester (as shown by the orange circles) and would then attack the other ester as a nucleophile. There is little to choose between these alternatives but the first was wanted and was selected by careful experimentation, although only in 50% yield. This was acceptable on a large scale as the product could be separated by crystallization, the most practical of all methods.

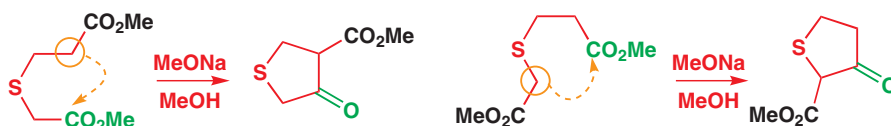

Reactions such as this—the attack of enolates on carbon electrophiles—form the subject of the next two chapters, where we will discuss in detail the mechanism of this type of reaction.

Further reading

There is a basic introduction in S. Warren and P. Wyatt, *Organic Synthesis: the Disconnection Approach*, Wiley, Chichester, 2008, chapter 3.

Ortholithiation: P. Wyatt and S. Warren, *Organic Synthesis: Strategy and Control*, Wiley, Chichester, 2007. J. Clayden, *Organolithiums: Selectivity for Synthesis*, Pergamon, 2002.

Reduction of nitro groups: L. McMaster and A. C. Magill, *J. Am. Chem. Soc.*, 1928, **50**, 3038. Bromination of nitrobenzene: B. S. Furniss, A. J. Hannaford, P. W. G. Smith, and A. T. Tatchell, *Vogel's Textbook of Practical Organic Chemistry*, Longman, 5th edn, 1989, p. 864.

Formation of diazonium salts and conversion into aryl halides: B. S. Furniss, A. J. Hannaford, P. W. G. Smith, and A. T. Tatchell, *Vogel's Textbook of Practical Organic Chemistry*, Longman, 5th edn, 1989, pp. 933, 935. Iodolactonisation: B. S. Furniss, A. J. Hannaford, P. W. G. Smith, and A. T. Tatchell, *Vogel's Textbook of Practical Organic Chemistry*, Longman, 5th edn, 1989, p. 734.

The Wittig-style Horner-Wadsworth-Emmons alkene synthesis: W. S. Wadsworth and W. D. Emmons, *Org. Synth. Coll.*, 1973, **5**,

547. P. Wyatt and S. Warren, *Organic Synthesis: Strategy and Control*, Wiley, Chichester, 2007. Synthesis of non-conjugated compounds: C. W. Whitehead, J. J. Traverso, F. J. Marshall, and D. E. Morrison, *J. Org. Chem.*, 1961, **26**, 2809.

Regioselective electrophilic attack on dienes: R. B. Moffett, *Org. Synth. Coll.*, 1963, **4**, 238. K. Nakayama, S. Yamada, H. Takayama, Y. Nawata, and Y. Itaka, *J. Org. Chem.*, 1984, **49**, 1537.

Buffered epoxidation to avoid rearrangement of product: M. Imuta and H. Ziffer, *J. Org. Chem.*, 1979, **44**, 1351. Mono- and di-epoxidation of dienes: M. A. Hashem, E. Manteuffel, and P. Weyerstahl, *Chem. Ber.*, 1985, **118**, 1267.

Regioselective bromination of dienes: A. T. Blomquist and W. G. Mayes, *J. Org. Chem.*, 1945, **10**, 134. Regioselective nucleophilic substitution on allylic bromides: A. C. Cope, L. L. Estes, J. R. Emery, and A. C. Haven, *J. Am. Chem. Soc.*, 1951, **73**, 1199. V. H. Heasley and P. H. Chamberlain, *J. Org. Chem.*, 1970, **35**, 539. But ignore the theoretical part especially the three 'different' intermediates.

Check your understanding



To check that you have mastered the concepts presented in this chapter, attempt the problems that are available in the book's Online Resource Centre at <http://www.oxfordtextbooks.co.uk/orc/clayden2e/>

25

Alkylation of enolates

Connections

➔ Building on

- Enols and enolates **ch20**
- Electrophilic addition to alkenes **ch19**
- Nucleophilic substitution reactions **ch15**
- Conjugate additions **ch22**

Arriving at

- How to make new C–C bonds using carbonyl compounds as nucleophiles
- How to prevent carbonyl compounds reacting with themselves

➔ Looking forward to

- Forming C–C bonds by reacting nucleophilic enolates with electrophilic carbonyl compounds **ch26**
- Retrosynthetic analysis **ch28**

Carbonyl groups show diverse reactivity

In earlier chapters we discussed the two types of reactivity displayed by the carbonyl group. We first described reactions that involve nucleophilic attack on the carbon of the carbonyl, and in Chapter 9 we showed you that these are among the best ways of making new C–C bonds. In this chapter we shall again be making new C–C bonds, but using *electrophilic* attack on carbonyl compounds: in other words, the carbonyl compound will be reacting as the nucleophile in the reaction. We introduced the nucleophilic forms of carbonyl compounds—enols and enolates—in Chapter 20. There you saw them reacting with electrophiles based on elements other than carbon, but they will also react well with carbon electrophiles provided the reaction is thoughtfully devised. Much of this chapter will concern that phrase, ‘thoughtfully devised’.

carbonyl compound acts as an electrophile

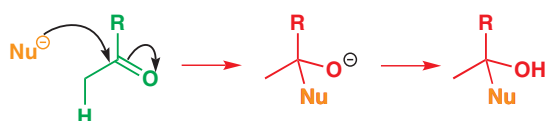

enolate acts as a nucleophile

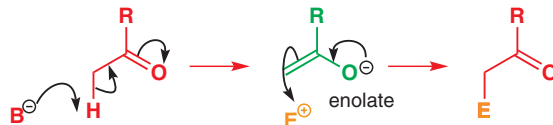

■ In the next chapter we shall talk about how to promote and control the reactions of carbonyl compounds with themselves, known as *aldol reactions*.

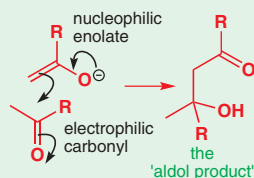

Thought is needed to ensure that the carbonyl compound exhibits the right sort of reactivity. In particular, the carbonyl compound must not act as an electrophile when it is intended to be a nucleophile. If it does, it may react with itself to give some sort of dimer—or even a polymer—rather than neatly attacking the desired electrophile. This chapter will consider ways of avoiding unwanted nucleophilic attack at the carbonyl C=O bond.

Fortunately, over the last four decades lots of thought has *already* gone into the problem of controlling the reactions of enolates with carbon electrophiles. This means that there are many excellent solutions to the problem: our task in this chapter is to help you understand which to use, and when to use them, in order to design useful reactions.

Some important considerations that affect all alkylations

The alkylations in this chapter will each consist of two steps. The first is the formation of a stabilized anion—usually (but not always) an enolate—by deprotonation with base.

Online support. The icon  in the margin indicates that accompanying interactive resources are provided online to help your understanding: just type www.chemtube3d.com/clayden/123 into your browser, replacing **123** with the number of the page where you see the icon. For pages linking to more than one resource, type **123-1, 123-2** etc. (replacing **123** with the page number) for access to successive links.

The second is a substitution reaction: attack of the nucleophilic anion on an electrophilic alkyl halide. All the factors controlling S_N1 and S_N2 reactions, which we discussed at length in Chapter 15, are applicable here.

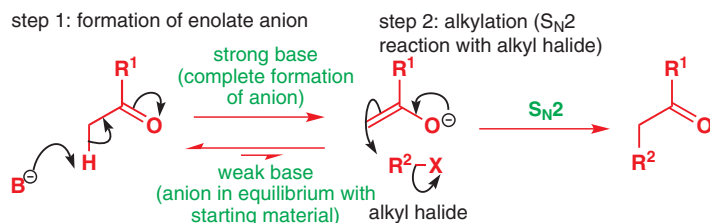

In each case, we shall take one of two approaches to the choice of base.

- A strong base (with a conjugate acid of pK_a greater than that of the carbonyl compound) can be chosen to *deprotonate the starting material completely*. There is complete conversion of the starting material to the anion before addition of the electrophile, which is added in a subsequent step.
- Alternatively, a weaker base may be used *in the presence of the electrophile*. The weaker base will not deprotonate the starting material completely because its conjugate acid has a lower pK_a than the carbonyl compound: only a small amount of anion will be formed, but that small amount will react with the electrophile. More anion is formed as alkylation uses it up.

The second approach is easier practically (just mix the starting material, base, and electrophile), but works only if the base and the electrophile are compatible and don't react together. With the first approach, which is practically more demanding, the electrophile and base never meet each other, so their compatibility is not a concern. We shall start with some compounds that avoid the problem of competing aldol reactions completely because they are not electrophilic enough to react with their own nucleophilic derivatives.

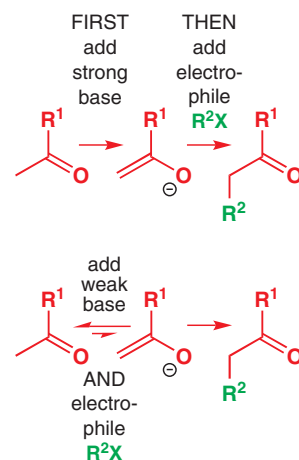

Nitriles and nitroalkanes can be alkylated

Problems that arise from the electrophilicity of the carbonyl group can be avoided by replacing $C=O$ by functional groups that are much less electrophilic but are still able to stabilize an adjacent anion. We shall consider two examples, both of which you met in Chapter 20.

Alkylation of nitriles

The nitrile group, which mirrors the carbonyl group in general reactivity, is much less easily attacked by nucleophiles (N is less electronegative than O). The anion formed by deprotonating a nitrile using strong base will not react with other molecules of nitrile but will react very efficiently with alkyl halides. The slim, linear structure of the anions makes them good nucleophiles for S_N2 reactions.

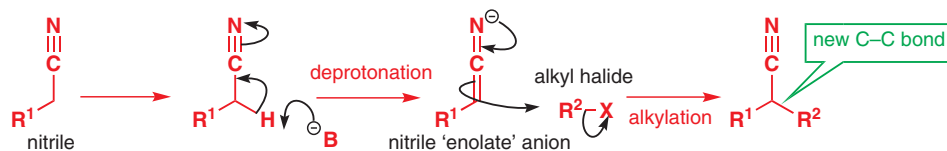

The nitrile does not have to be deprotonated completely for alkylation: with sodium hydroxide only a small amount of anion is formed. In the example below, such an anion reacts with propyl bromide to give 2-phenylpentanenitrile.



➔ You met nitrile hydrolysis and addition reactions, for example, in Chapter 10.

■ The pK_a of acetonitrile (MeCN) is 25.

Phase transfer catalysis

This reaction is carried out in a two-phase mixture (water + an immiscible organic solvent) to prevent the hydroxide and propyl bromide reacting together to give propanol. The hydroxide stays in the aqueous layer, and the other reagents stay in the organic layer. A tetraalkylammonium chloride (benzyltriethylammonium chloride $\text{BnEt}_3\text{N}^+\text{Cl}^-$) is needed as a *phase transfer catalyst* to allow sufficient hydroxide to enter the organic layer to deprotonate the nitrile.

Nitrile-stabilized anions are so nucleophilic that they will react with alkyl halides rather well even when a crowded quaternary centre (a carbon bearing no H atoms) is being formed. In this example the strong base, sodium hydride, was used to deprotonate the branched nitrile completely and benzyl chloride was the electrophile. The greater reactivity of benzylic electrophiles compensates for the poorer leaving group. In DMF, the anion is particularly reactive because it is not solvated (as you saw in Chapter 12, p. 255, DMF solvates only the Na^+ cation).

Remember our discussion about the lack of nucleophilicity of hydride (H^-) in Chapter 6? Here is hydride acting as a base even in the presence of the electrophile: there was no need to do this reaction in two steps because the base and electrophile don't react with one another.

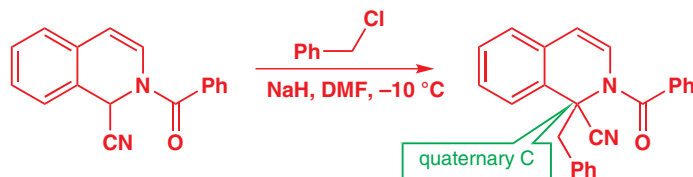

The compatibility of sodium hydride with electrophiles means that, by adding two equivalents of base, alkylation can be encouraged to occur more than once. This dimethylated acid was required in the synthesis of a potential drug, and it was made in two steps from a nitrile.

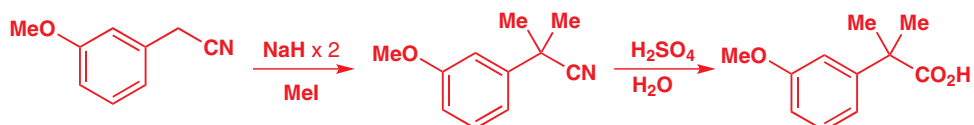

The '•' in the second and fourth structures indicates the linear carbon atom, which might get overlooked if it were not indicated in this way.

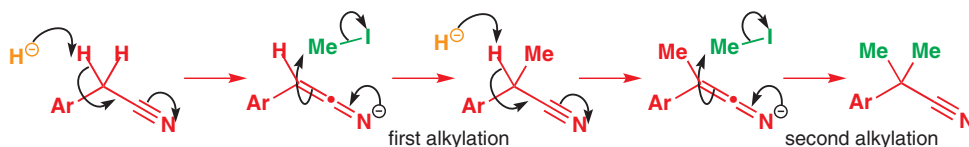

With two nitrile groups, the delocalized anion is so stable that even a weak, neutral amine (triethylamine) is sufficiently basic to deprotonate the starting material. Here double alkylation again takes place, in 100% yield: note that the electrophile is good at $\text{S}_{\text{N}}2$, and the dipolar aprotic solvent DMSO (like DMF) cannot solvate the 'enolate' anion, making it more reactive.



Multiple alkylation

Multiple alkylation is not always desirable, and one of the side reactions in alkylations that are intended to go only once is the formation of doubly alkylated products. These arise when the first alkylation product still has acidic protons and can be deprotonated to form another anion, which may in turn react further. Clearly, this is more likely to be a problem if the base is present in excess and can usually be restricted by using only one equivalent of the electrophile.

If the electrophile and the nitrile are in the same molecule and the spacing between them is appropriate, then intramolecular alkylation entails cyclization to form rings. The preparation of a cyclopropane is shown using sodium hydroxide as the base and chloride as a leaving group. With an intramolecular alkylation, the base and the electrophile necessarily have to be present together, but the cyclization is so fast that competing $\text{S}_{\text{N}}2$ substitution of Cl^- by HO^- is not a problem.



Alkylation of nitroalkanes

The powerful electron-withdrawing nature of the nitro group means that deprotonation is possible even with quite weak bases. The pK_{a} of MeNO_2 is 10, about the same as phenol.

Protons adjacent to a nitro group are in fact about as acidic as the same proton adjacent to two carbonyl groups; you can think of a nitro group as having double the electron-withdrawing power of a carbonyl group. Nitro-stabilized anions ('nitronate anions') react with carbon electrophiles and a wide variety of nitro-containing products can be produced. The anions are not, of course, enolates, but replacing the nitrogen with a carbon should help you to recognize the close similarity of these alkylations with the enolate alkylations described later.

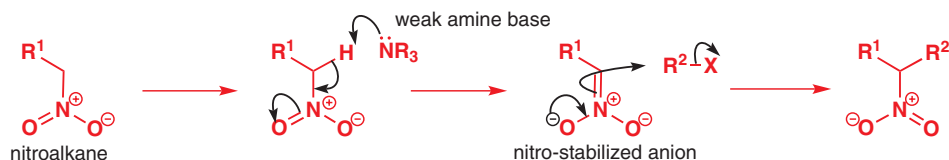
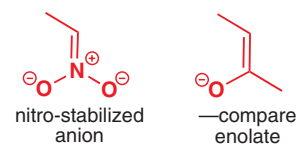

Surprisingly few simple nitroalkanes are commercially available but more complex examples can be prepared readily by alkylation of the anions derived from nitromethane, nitroethane, and 2-nitropropane. For example, deprotonation of nitropropane with butyllithium followed by the addition of butyl iodide gives 3-nitroheptane in good yield. This reaction really does have to be done in two steps: BuLi is not compatible with alkyl halides!



Nitroalkanes can be alkylated in a single step with hydroxide as a base: phase transfer conditions (see p. 585) keep the HO⁻ and the electrophile apart, preventing alcohol formation. The reaction below on the left works despite the quaternary carbon atom in the product. The reaction on the right gives a cyclic nitroalkane: now there really is no alternative: the base and electrophile must cohabit in the reaction mixture, so a weaker base such as potassium carbonate must be used—hydroxide or amines are no good here because they would undergo substitution reactions with the halide.

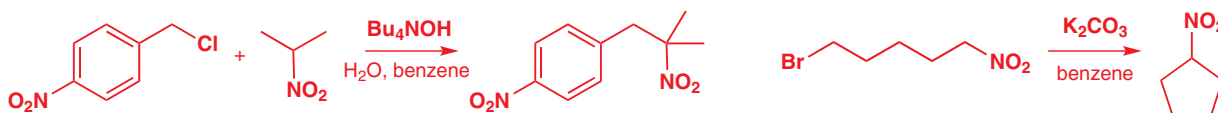

Choice of electrophile for alkylation

Enolate alkylations are S_N2 reactions (polar solvents, good charged nucleophile) so the electrophile needs to be S_N2-reactive if the alkylation is to succeed: primary and benzylic alkyl halides are among the best alkylating agents. More branched halides tend to prefer unwanted E2 elimination reactions because the anions themselves are basic. As a result, tertiary halides are useless for enolate alkylation. We shall see a way round this problem later in the chapter.

➔ Factors governing substitution reactions were covered in detail in Chapter 15, and elimination reactions were the subject of Chapter 17.

methyl	allyl	benzyl	primary alkyls	secondary alkyls	tertiary alkyls
$\text{H}_3\text{C}-\text{X}$	$\text{CH}_2=\text{CH}-\text{CH}_2-\text{X}$	$\text{C}_6\text{H}_5-\text{CH}_2-\text{X}$	$\text{R}-\text{CH}_2-\text{X}$	$\text{R}^2-\text{CH}-\text{X}$ R^1	R^2 $\text{R}^3-\text{C}-\text{X}$ R^1
alkylate very well			alkylate well	alkylate slowly	do <i>not</i> alkylate

Lithium enolates of carbonyl compounds

The problem of self-condensation of carbonyl compounds (that is, enolate reacting with unenolized carbonyl) under basic conditions does not exist if there is absolutely no unenolized carbonyl compound present. One way to achieve this is to use a base sufficiently strong

➔ LDA was described on p. 465.

a reminder: how to make LDA

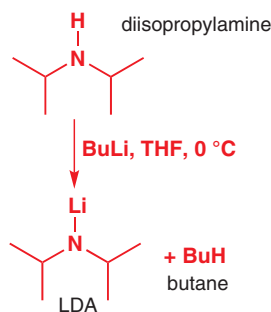

■ Enolates are a type of alkene, and may have two possible geometries. The importance of enolate geometry is discussed in Chapter 33 and will not concern us here. More important is the question of *regioselectivity* when unsymmetrical ketones are deprotonated. We shall discuss this aspect later in the chapter.

Interactive mechanism for lithium enolate formation

Variants of LDA

LDA came into general use in the 1970s, and you may meet variants such as those derived from butyllithium and 2,2,6,6-tetramethylpiperidine (lithium tetramethylpiperidide, LTMP) or hexamethyldisilazane (lithium hexamethyldisilazide, LHMS), which are even more hindered and even less nucleophilic.

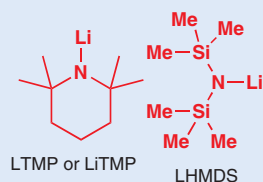

(pK_a at least 3 or 4 units higher than pK_a of the carbonyl compound) to ensure that all of the starting carbonyl is converted into the corresponding enolate. This will work only if the resulting enolate is sufficiently stable to survive until the alkylation is complete. As you saw in Chapter 20, lithium enolates are stable, and are among the best enolate equivalents for use in alkylation reactions.

The best base for making lithium enolates is usually LDA, made from diisopropylamine ($i\text{-Pr}_2\text{NH}$) and BuLi. LDA will deprotonate virtually all ketones and esters that have an acidic proton to form the corresponding lithium enolates rapidly, completely, and irreversibly even at the low temperatures (about -78°C) required for some of these reactive species to survive. Deprotonation occurs through a cyclic mechanism, which is illustrated below for ketones and esters. The basic nitrogen anion removes the proton as the lithium is delivered to the forming oxyanion.

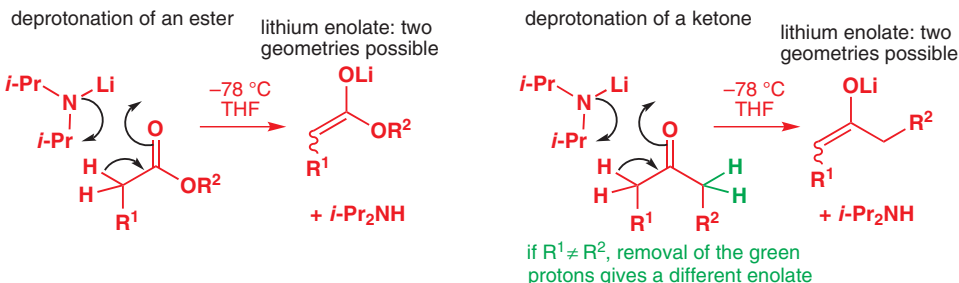

Alkylations of lithium enolates

The reaction of these lithium enolates with alkyl halides is one of the most important C–C bond-forming reactions in chemistry. Alkylation of lithium enolates works with both acyclic and cyclic ketones as well as with acyclic and cyclic esters (lactones). The general mechanism is shown below.

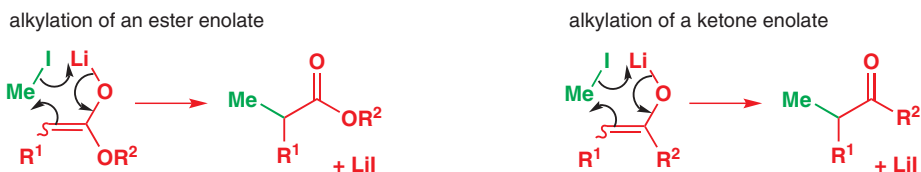

Typical experimental conditions for reactions of kinetic enolates involve formation of the enolate at very low temperature (-78°C) in THF. The strong base LDA is used to avoid self-condensation of the carbonyl compound but, while the enolate is forming, there is always a chance that self-condensation will occur. The lower the temperature, the slower the self-condensation reaction, and the fewer by-products there are. Once enolate formation is complete, the electrophile is added (still at -78°C : the lithium enolates may not be stable at higher temperatures). The reaction mixture is then usually allowed to warm up to room temperature to speed up the rate of the $\text{S}_{\text{N}}2$ alkylation.

Alkylation of ketones

Precisely this sequence was used to methylate the ketone below, with LDA acting as base followed by methyl iodide as electrophile.

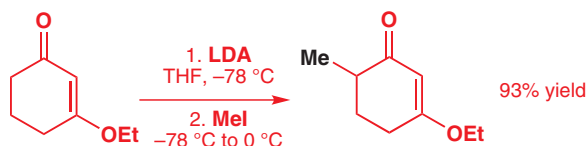

Their stability at low temperature means that lithium enolates are usually preferred, but sodium and potassium enolates can also be formed by abstraction of a proton by strong bases. The increased separation of the metal cation from the enolate anion with the larger alkali metals leads to more reactive but less stable enolates. Typical very strong Na and K bases include the hydrides (NaH, KH) or amide anions derived from ammonia (NaNH₂, KNH₂) or hexamethyldisilazane (NaHMDS, KHMDS). The instability of the enolates means that they are usually made and reacted in a single step, so the base and electrophile need to be compatible. Here are two examples of cyclohexanone alkylation: the high reactivity of the potassium enolate is demonstrated by the efficient tetramethylation with excess potassium hydride and methyl iodide.

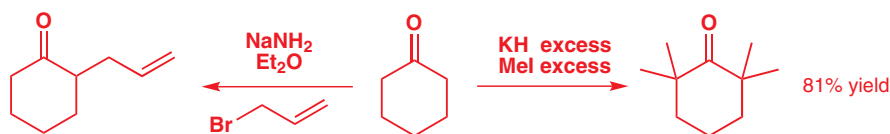

Alkylation of esters

In Chapter 26 you will meet the reaction of an ester with its own enolate: the Claisen condensation. This reaction can be an irritating side reaction in the chemistry of lithium ester enolates when alkylation is desired, and again it can be avoided only if the ester is converted entirely to its enolate under conditions where the Claisen condensation is slow. A good way of stopping this happening is to add the ester *to the solution of LDA* (and not the LDA to the ester) so that there is never excess ester for the enolate to react with. Another successful tactic is to make the group R as large as possible to discourage attack at the carbonyl group. Tertiary butyl esters are particularly useful in this regard because they are readily made, *t*-butyl is extremely bulky, and yet they can still be hydrolysed in aqueous acid under mild conditions by the method discussed on p. 556. In this example, deprotonation of *t*-butyl acetate gives a lithium enolate that reacts with butyl iodide as the reaction mixture is warmed to room temperature.

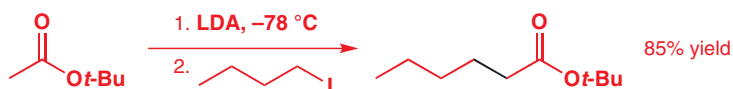

Alkylation of carboxylic acids

The lithium enolates of carboxylic acids can be formed if two equivalents of base are used: one to make the carboxylate anion and one to make the enolate. It is not necessary to use a strong base to remove the first proton but, since the second deprotonation requires a strong base such as LDA, it is often convenient to use two equivalents of LDA to form the dianion. With carboxylic acids, even BuLi can be used on occasion because the intermediate lithium carboxylate is much less electrophilic than an aldehyde or a ketone.

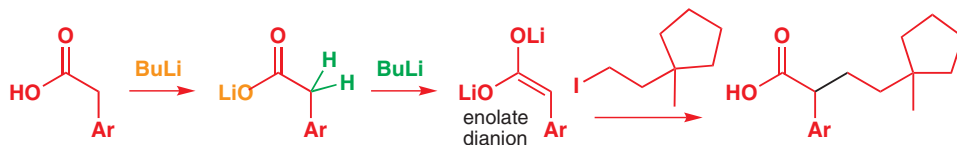

The next alkylation of an acid enolate is of a carbamate-protected amino acid, glycine. As you saw in Chapter 23, carbamate protecting groups are stable to basic reaction conditions. Three acidic protons are removed by LDA, but alkylation takes place only at carbon—the site of the last proton to be removed. Alkylation gets rid of one of the negative charges, so that, if the molecule gets a choice, it alkylates to get rid of the least stable anion, keeping the two more

aim to avoid the Claisen self-condensation of esters

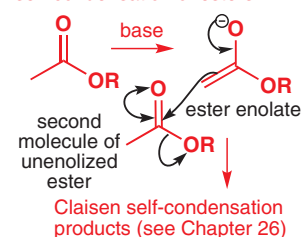

■ Why doesn't BuLi add to the carboxylate, as you saw in Chapter 10, to form the ketone? Presumably in this case the aromatic ring helps acidify the benzylic protons to tip the balance towards deprotonation. Even with carboxylic acids, LDA would normally be the first base you would try.

► You saw this sort of reactivity with dianions in Chapter 23: the last anion to form will be the most reactive.

stabilized charges. A good alternative to using the dianion is to alkylate the ester or nitrile and then hydrolyse to the acid.

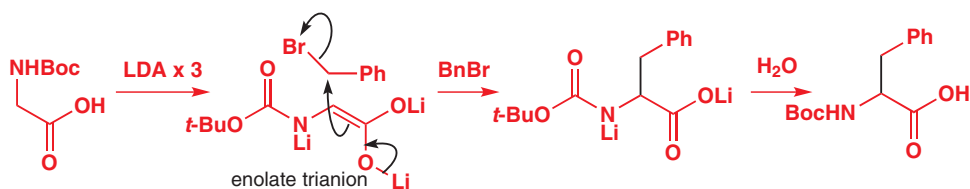

- Alkylation of ketones, esters, and carboxylic acids is best carried out using the lithium enolates.

Why do enolates alkylate on carbon?

Enolates have two nucleophilic sites: the carbon and the oxygen atoms. On p. 453 we showed that:

- carbon has the greater coefficient in the HOMO, and is the softer nucleophilic site
- oxygen carries the greater total charge and is the harder nucleophilic site. In Chapter 20 you saw that hard electrophiles prefer to react at oxygen—that is why it is possible to make silyl enol ethers, for example. Some carbon electrophiles with very good leaving groups also tend to react on oxygen, but soft electrophiles such as alkyl halides react at carbon, and you will see only this type of electrophile in this chapter.

In general:

- hard electrophiles, particularly alkyl sulfates and sulfonates (mesylates, tosylates), tend to react at oxygen
- soft electrophiles, particularly alkyl halides ($I > Br > Cl$), react at carbon
- polar aprotic solvents (DMSO, DMF) promote *O*-alkylation by separating the enolate anions from each other and the counterion (making the bond more polar and increasing the charge at O) while ethereal solvents (THF, DME) promote *C*-alkylation
- larger alkali metals ($Cs > K > Na > Li$) give more separated ion pairs (more polar bonds), which are harder and react more at oxygen.

hard electrophiles react at O

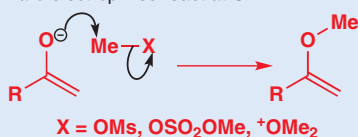

soft electrophiles react at C

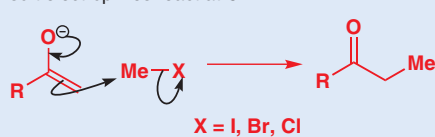

Alkylation of aldehydes: avoid LDA

Aldehydes are so electrophilic that, even with LDA at -78°C , the rate at which the deprotonation takes place is not fast enough to outpace reactions between the forming lithium enolate and still-to-be-deprotonated aldehyde remaining in the mixture. Direct addition of the base to the carbonyl group of electrophilic aldehydes can also pose a problem.

reactions which compete with aldehyde enolate formation

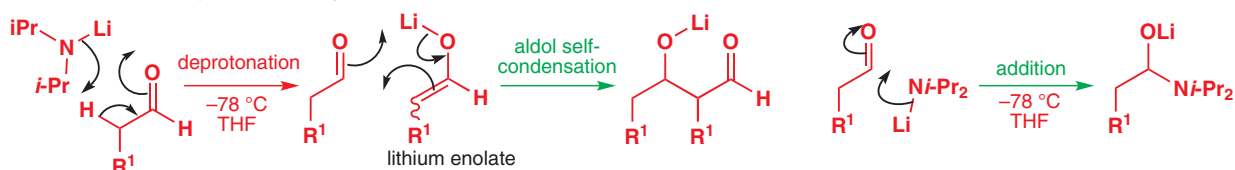

- Avoid using lithium enolates of aldehydes.

Using specific enol equivalents to alkylate aldehydes and ketones

These side reactions mean that aldehyde enolates are not generally useful reactive intermediates. Instead, there are a number of aldehyde enol and enolate equivalents in which the aldehyde is present only in masked form during the enolization and alkylation step. The three most important of these specific enol equivalents are:

- enamines
- silyl enol ethers
- aza-enolates derived from imines.

You met these enolate equivalents briefly in Chapter 20, and we shall discuss how to use them to alkylate aldehydes shortly. All three types of specific enol equivalent are useful not just with aldehydes, but with ketones as well, and we shall introduce each class with examples for both types of carbonyl compound.

Enamines are alkylated by reactive electrophiles

Enamines are formed when aldehydes or ketones react with secondary amines. The mechanism is given in Chapter 11. The mechanism below shows how they react with alkylating agents to form new carbon–carbon bonds: the enamine here is the one derived from cyclohexanone and pyrrolidine. The product is at first not a carbonyl compound: it's an iminium ion or an enamine (depending on whether an appropriate proton can be lost). But a mild acidic hydrolysis converts the iminium ion or enamine into the corresponding alkylated carbonyl compound.

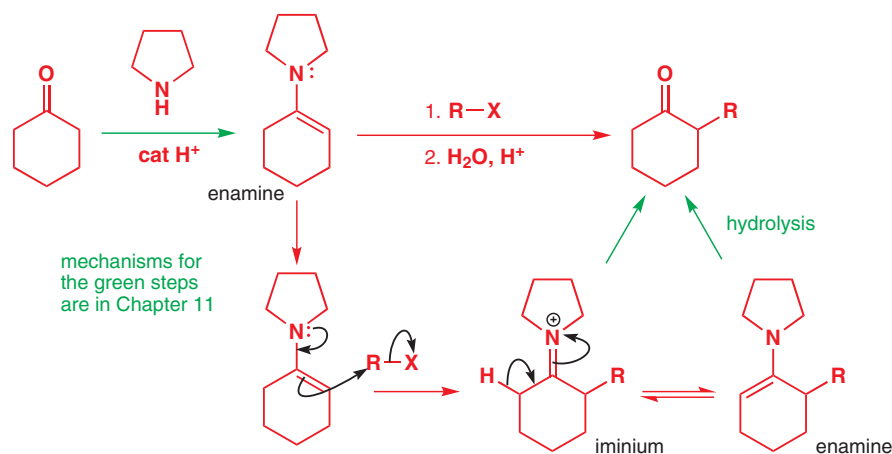

The overall process, from carbonyl compound to carbonyl compound, amounts to an enolate alkylation, but no strong base or enolates are involved so there is no danger of self-condensation. The example below shows two specific examples of cyclohexanone alkylation using an enamine. Note the relatively high temperatures and long reaction times: enamines are among the most reactive of neutral nucleophiles, but they are still a lot less nucleophilic than enolates.

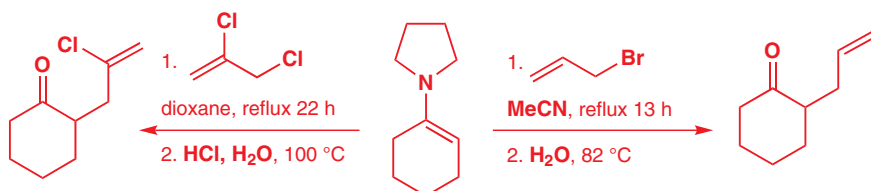

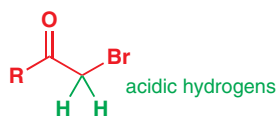
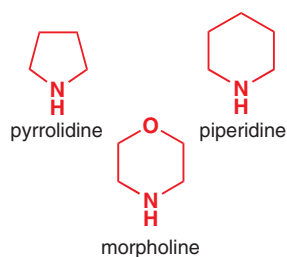

The choice of the secondary amine for formation of the enamine is not completely arbitrary even though it does not end up in the final alkylated product. Simple dialkyl amines can be used but cyclic amines such as pyrrolidine, piperidine, and morpholine are popular choices as the ring structure makes both the starting amine and the enamine more nucleophilic (the alkyl groups are 'tied back' and can't get in the way). The higher boiling points of these amines allow the enamine to be formed by heating.

α -Bromo carbonyl compounds are excellent electrophiles for S_N2 reactions because of the rate-enhancing effect of the carbonyl group (Chapter 15). The protons between the halogen and the carbonyl are significantly more acidic than those adjacent to just a carbonyl group and there can be a serious risk of an enolate nucleophile acting as a base. Enamines are only very weakly basic, but react well as nucleophiles with α -bromo carbonyl compounds, and so are a good choice.

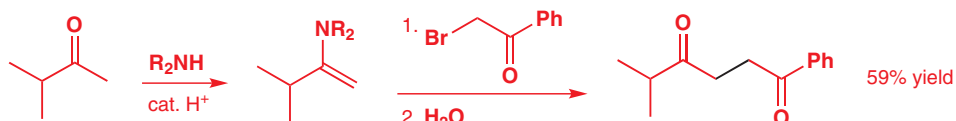

■ Note how the preference for the less substituted enamine is opposite to the preference for a more substituted enol: see p. 465.

The starting ketone here is unsymmetrical, so two enamines are possible. However, the formation of solely the *less* substituted enamine is typical. The outcome may be explained as the result of thermodynamic control: enamine formation is reversible so the less hindered enamine predominates. For the more substituted enamine, steric hindrance forces the enamine to lose planarity, and destabilizes it. The less substituted enamine, on the other hand, is rather more stable.

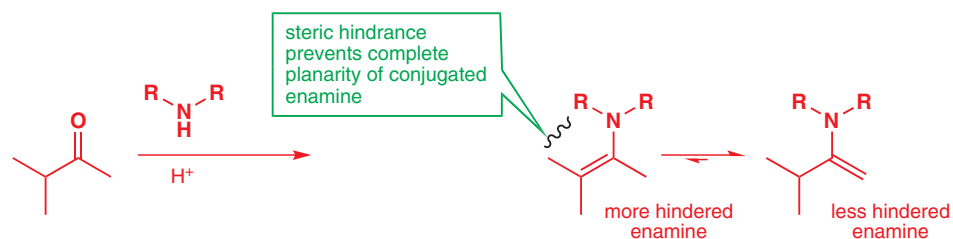

There is, however, a major problem with enamines: reaction at nitrogen. Less reactive alkylating agents—simple alkyl halides such as methyl iodide, for example—react to a significant degree at N rather than at C. The product is a quaternary ammonium salt, which hydrolyses back to the starting material and leads to low yields.

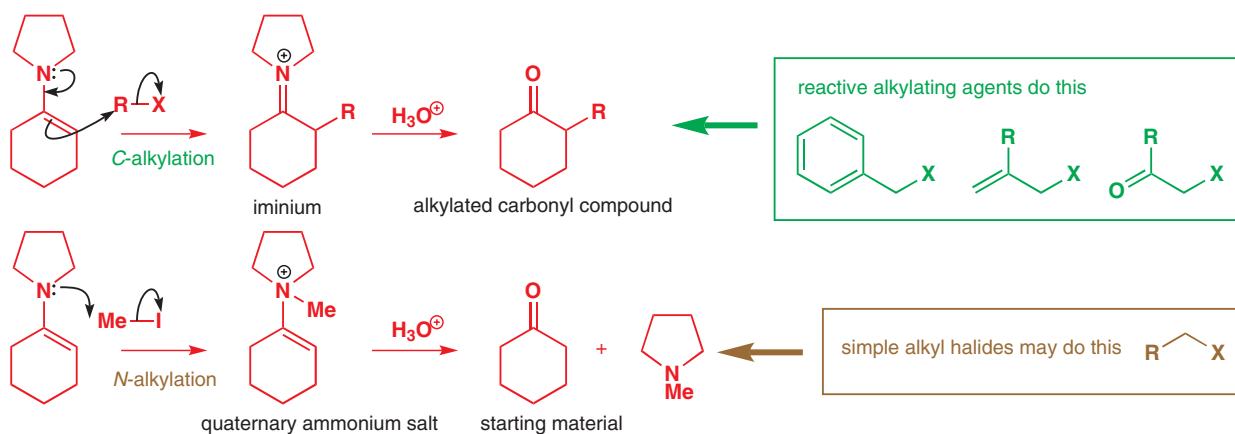

● **Enamines work best with reactive alkylating agents:**

- allylic halides
- benzyl halides
- α -halo carbonyl compounds.

That said, enamines are a good solution to the aldehyde enolate problem. Aldehydes form enamines very easily (one of the advantages of the electrophilic aldehyde) and these are immune to attack by nucleophiles—including, most importantly, the enamines themselves. Below are two examples of aldehyde alkylation using the enamine method. Both again use highly S_N2 -reactive electrophiles, and this is the main limitation of enamines.

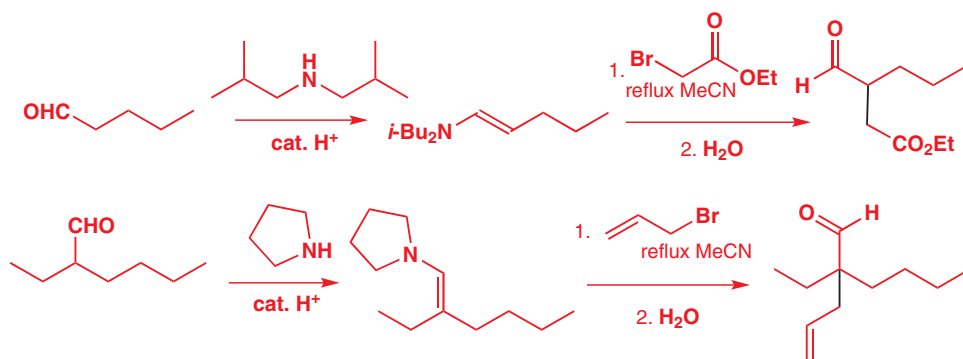

Aza-enolates react with a wider range of S_N2 -reactive electrophiles

Enamines are the nitrogen analogues of enols and provide one solution to the aldehyde enolate problem when the electrophile is reactive. Imines are the corresponding nitrogen analogues of aldehydes and ketones: a little lateral thinking should therefore lead you to expect some useful reactivity from the nitrogen equivalents of enolates, known as aza-enolates. Aza-enolates are formed when imines are treated with LDA or other strong bases.

In basic or neutral solution, imines are less electrophilic than aldehydes: they react with organolithiums, but not with many weaker nucleophiles (they are more electrophilic in acid when they are protonated). So, as the aza-enolate forms, there is no danger at all of self-condensation.

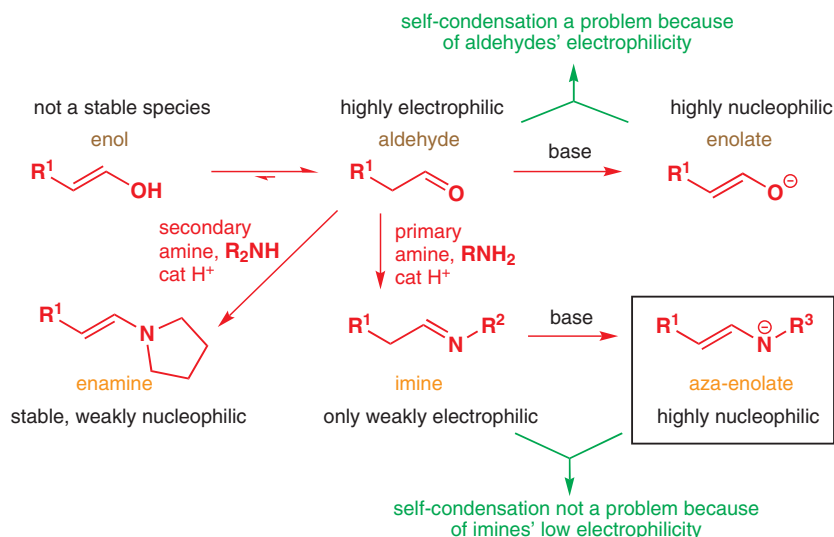

■ Note that aza-enolates are formed from imines, which can be made only from *primary* amines. Enamines are made from aldehydes or ketones with *secondary* amines.

The overall sequence involves formation of the imine from the aldehyde that is to be alkylated—usually with a bulky primary amine such as *t*-butyl- or cyclohexylamine to discourage even further nucleophilic attack at the imine carbon. The imine is not usually isolated, but is deprotonated directly with LDA or a Grignard reagent (these do not add to imines, but they will deprotonate them to give magnesium aza-enolates).

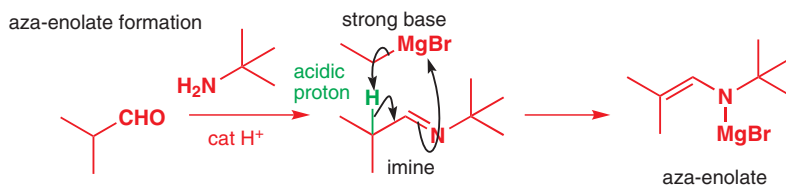

The resulting aza-enolate reacts like a ketone enolate with S_N2 -reactive alkylating agents—here, benzyl chloride—to form the new carbon–carbon bond and to re-form the imine. The alkylated imine is usually hydrolysed by the mild acidic work-up to give the alkylated aldehydes.

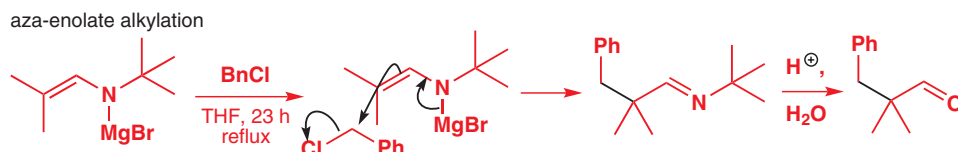

In the next example, a lithium base (lithium diethylamide) is used to form the aza-enolate. The ease of imine cleavage in acid is demonstrated by the selective hydrolysis to the aldehyde without any effect on the acetal introduced by the alkylation step. The product is a mono-protected dialdehyde, which is difficult to prepare by other methods.

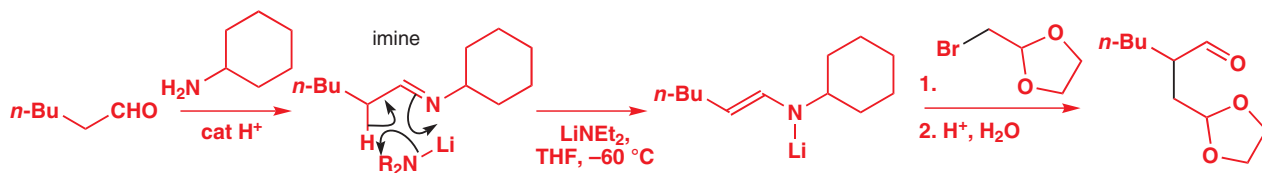

Aza-enolate alkylation is so successful that it has been extended from aldehydes, where it is essential, to ketones, where it can be a useful option. Cyclohexanones are among the most electrophilic simple ketones and can suffer from undesirable side reactions. The imine from cyclohexanone and cyclohexylamine can be deprotonated with LDA to give a lithium aza-enolate. In this example, iodomethylstannane was the alkylating agent, giving the tin-containing ketone after hydrolysis.

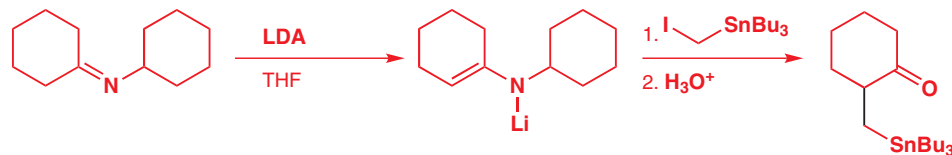

• Aldehyde alkylation

Aza-enolates are the best general solution for alkylating aldehydes with most electrophiles. With very S_N2 -reactive alkylating agents, enamines can be used, and with very S_N1 -reactive alkylating agents, silyl enol ethers must be used.

Silyl enol ethers are alkylated by S_N1 -reactive electrophiles in the presence of Lewis acid

While the greater nucleophilicity of azaenolates means that they will react with a wider range of electrophiles, their basicity, like that of lithium enolates, means that they will not react with S_N1 -reactive electrophiles like tertiary alkyl halides. The solution to this problem is to use silyl enol ethers, which are less reactive and so require a more potent electrophile to initiate reaction. Carbocations will do, and they can be generated *in situ* by abstraction of a halide or other leaving group from a saturated carbon atom.

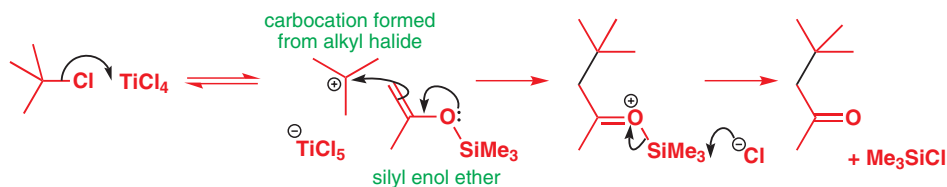

The best alkylating agents for silyl enol ethers are tertiary alkyl halides: they form stable carbocations in the presence of Lewis acids such as $TiCl_4$ or $SnCl_4$. Most fortunately, this is just the type of compound that is unsuitable for reaction with lithium enolates or enamines, as elimination results rather than alkylation: a nice piece of complementary selectivity. Below is an example: the alkylation of cyclopentanone with 2-chloro-2-methylbutane. The ketone was converted to the trimethylsilyl enol ether with triethylamine and trimethylsilylchloride: we discussed this step on p. 466 (Chapter 20). Titanium tetrachloride in dry dichloromethane promotes the alkylation step.

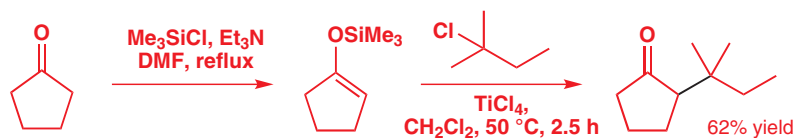

➔ You met silyl enol ethers in Chapter 20, p. 466.

■ $TiCl_4$ is acting as a Lewis acid here (see p. 180 for more on Lewis acids), accepting a pair of electrons from the Cl atom. You saw the quantitative formation of carbocations by a related method in Chapter 15.

● Summary: specific enol equivalents for aldehydes and ketones:

- Lithium enolates can be used with S_N2 -reactive electrophiles, but cannot be made from aldehydes.
- Aza-enolates of aldehydes or ketones can be used with the same S_N2 -reactive electrophiles, but can be made from aldehydes.
- Enamines of aldehydes or ketones can be used with allylic, benzylic, or α -halocarbonyl compounds.
- Silyl enol ethers of aldehydes or ketones can be used with S_N1 -reactive electrophiles such as allylic, benzylic, or tertiary alkyl halides.

Alkylation of β -dicarbonyl compounds

The presence of two, or even three, electron-withdrawing groups on a single carbon atom makes the remaining proton(s) sufficiently acidic (pK_a 10–15) that even mild bases can lead to complete enolate formation. Bases of the strength of alkoxides (pK_a of ROH = ca. 16) cannot deprotonate simple carbonyl compounds (pK_a 20–25) completely, but readily generate anions stabilized by more than one electron-withdrawing group. The most important enolates of this type are those of 1,3-dicarbonyl (or β -dicarbonyl) compounds.

The resulting anions are alkylated very efficiently. This diketone is enolized even by potassium carbonate, and reacts with methyl iodide in good yield. Carbonate is such a bad nucleophile that the base and the electrophile can be added in a single step.

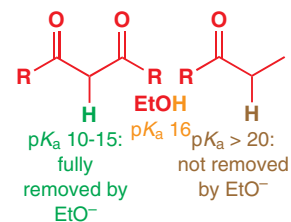

Enolates stabilized by two of the following electron-withdrawing groups may be formed with alkoxides: COR, CO_2R , CN, $CONR_2$, SO_2R , $(RO)_2P=O$.

alkylation of a 1,3-dicarbonyl compound (or β -dicarbonyl compound)

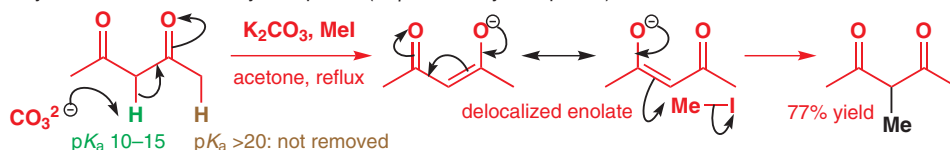

Among the β -dicarbonyls two compounds stand out in importance—diethyl (or dimethyl) malonate and ethyl acetoacetate. You should make sure you remember their structures and trivial names.



➔ You met the stable enols of related compounds in Chapter 20.

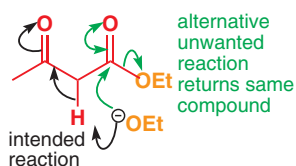

With these two esters, the choice of base is important: nucleophilic addition can occur at the ester carbonyl, which could lead to transesterification (with alkoxides), hydrolysis (with hydroxide), or amide formation (with amide anions). The best choice is usually an alkoxide identical with the alkoxide component of the ester (that is, *ethoxide* for diethyl malonate, *methoxide* for dimethyl malonate). Alkoxides are basic enough to deprotonate between two carbonyl groups but, should substitution occur at $\text{C}=\text{O}$, there is no overall reaction.

In the first example below the electrophile is the allylic cyclopentenyl chloride, and the base is ethoxide in ethanol—most conveniently made by adding one equivalent of sodium metal to dry ethanol. The same base is used in the second alkylation, of ethyl acetoacetate with butyl bromide.

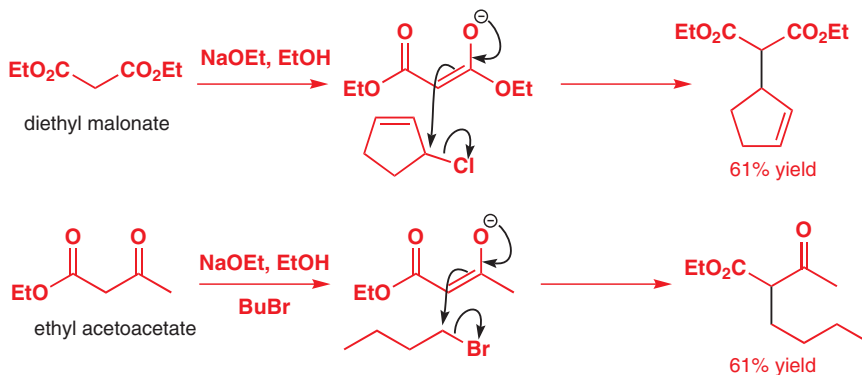

Various electron-withdrawing groups can be used in almost any combination with good results. In this example an ester and a nitrile cooperate to stabilize an anion. Nitriles are not quite as anion-stabilizing as carbonyl groups so this enolate requires a stronger base (sodium hydride) in an aprotic solvent (DMF) for success. The primary alkyl tosylate serves as the electrophile.

➔ If you need a reminder about the tosylate leaving group, turn back to p. 349.



These doubly stabilized anions are alkylated so well that it is common to carry out an alkylation between two carbonyl groups, only to remove one of them at a later stage. This is made possible by the fact that carboxylic acids with a β -carbonyl group decarboxylate (lose carbon dioxide) on heating. The mechanism below shows how. After alkylation of the dicarbonyl compound the unwanted ester is first hydrolysed in base. Acidification and heating lead to

decarboxylation via a six-membered cyclic transition state in which the acid proton is transferred to the carbonyl group as the key bond breaks, liberating a molecule of carbon dioxide. The initial product is the enol form of a carbonyl compound that rapidly tautomerizes to the more stable keto form—now with only one carbonyl group. Using this technique, β -keto esters give ketones while malonate esters give simple carboxylic acids (both ester groups hydrolyse but only one can be lost by decarboxylation). Decarboxylation can occur only with a second carbonyl group appropriately placed β to the acid, because the decarboxylated product must be formed as an enol.

decarboxylation of acetoacetate derivatives to give ketones

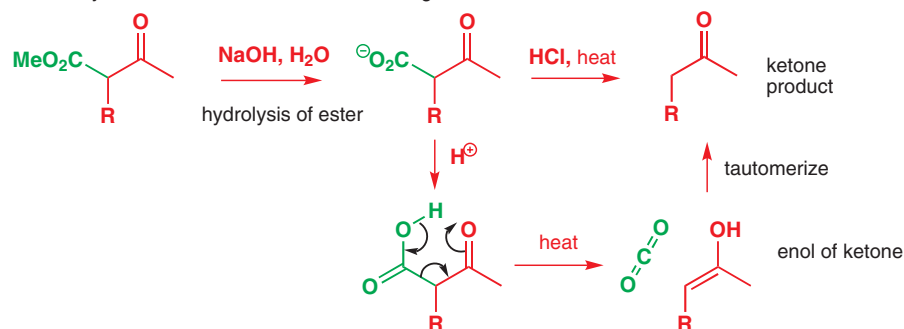

decarboxylation of malonate derivatives to give carboxylic acids

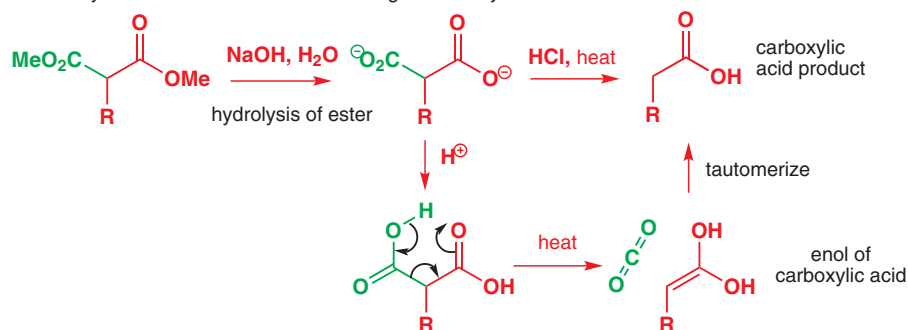

The alkylation of ethyl acetoacetate with butyl bromide on p. 596 was done with the expressed intention of decarboxylating the product to give heptan-2-one. These are the conditions for this decarboxylation: the heating step drives off the CO_2 by increasing the gearing on the entropy term (ΔS^\ddagger) of the activation energy (two molecules are made from one).

➔ We discussed the role of temperature in driving reactions in Chapter 12.

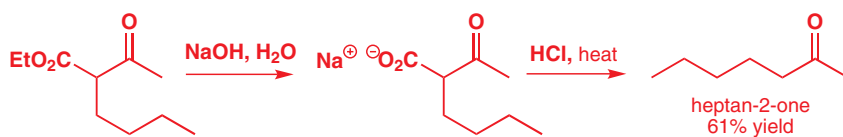

Esters are much easier to work with than carboxylic acids, and a useful alternative procedure removes one ester group without having to hydrolyse the other. The malonate ester is heated in a polar aprotic solvent—usually DMSO—in the presence of sodium chloride and a little water. No acid or base is required and, apart from the high temperature, the conditions are fairly mild. The scheme below shows a dimethyl malonate alkylation (note that NaOMe is used with the dimethyl ester) and removal of the methyl ester.

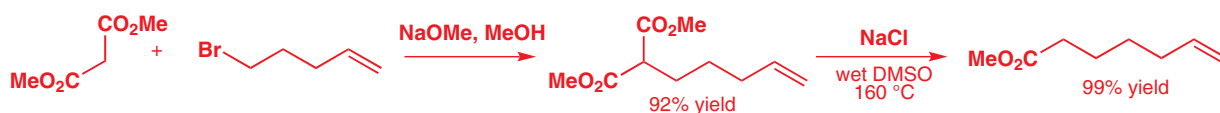

■ *tert*-Butyl esters also typically hydrolyse by cleavage of the O–alkyl bond, as we showed you on p. 556. With a *t*-butyl group the mechanism is of course S_N1 .

The mechanism of decarboxylation is a rather unusual type of ester cleavage reaction. The bond that breaks is not the MeO–CO bond but instead the O–alkyl bond: the reaction is an S_N2 substitution of carboxylate by Cl^- .

alternative mechanisms for ester cleavage

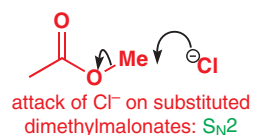
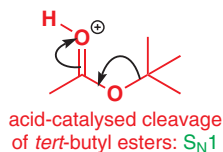
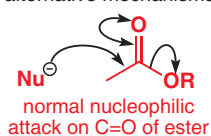

Chloride is a poor nucleophile, but it is more reactive in DMSO, by which it cannot be solvated. And, as soon as the carboxylate is displaced, the high temperature encourages (entropy again) irreversible decarboxylation. The other by-product, MeCl, is also lost as a gas. The ‘decarboxylation’ (in fact, removal of a CO_2Me group, not CO_2) is known as the **Krapcho decarboxylation**. Because of the S_N2 step, it works best with *methyl* malonate esters.

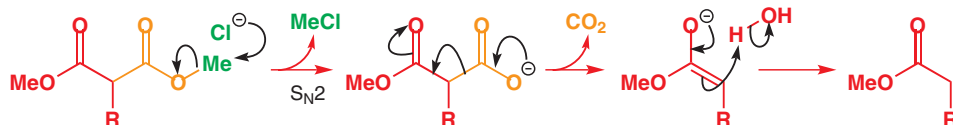

We have only looked at single alkylations of dicarbonyl compounds, but there are two acidic protons between the carbonyl groups and a second alkylation is usually possible. Excess of base and alkyl halide gives two alkylations in one step. More usefully, it is possible to introduce two different alkyl groups by using just one equivalent of base and alkyl halide in the first step.

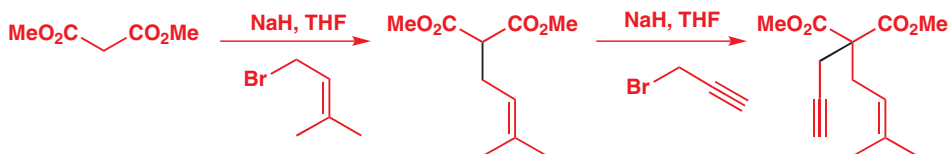

With a dihaloalkane, rings can be formed by two sequential alkylation reactions: this is an important way of making cycloalkanecarboxylic acids. Even the usually more difficult (see Chapter 31) four-membered rings can be made in this way.

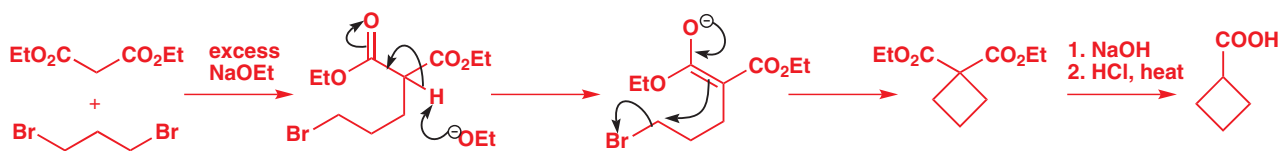

Ketone alkylation poses a problem in regioselectivity

Ketones are unique because they can have enolizable protons on both sides of the carbonyl group. Unless the ketone is symmetrical, or unless one side of the ketone happens to have no enolizable protons, two regioisomers of the enolate are possible and alkylation can occur on either side to give regioisomeric products. We need to be able to control which enolate is formed if ketone alkylations are to be useful.

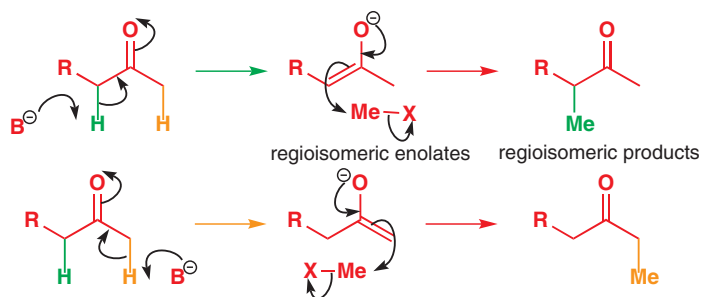

Thermodynamically controlled enolate formation

Selective enolate formation is straightforward if the protons on one side of the ketone are significantly more acidic than those on the other. This is what you have just seen with ethyl acetoacetate: it is a ketone, but with weak bases (pK_a of the conjugate acid < 18) it only ever enolizes on the side where the protons are acidified by the second electron-withdrawing group. If two new substituents are introduced, in the manner you have just seen, they will always both be joined to the same carbon atom. This is an example of thermodynamic control: only the more stable of the two possible enolates is formed.

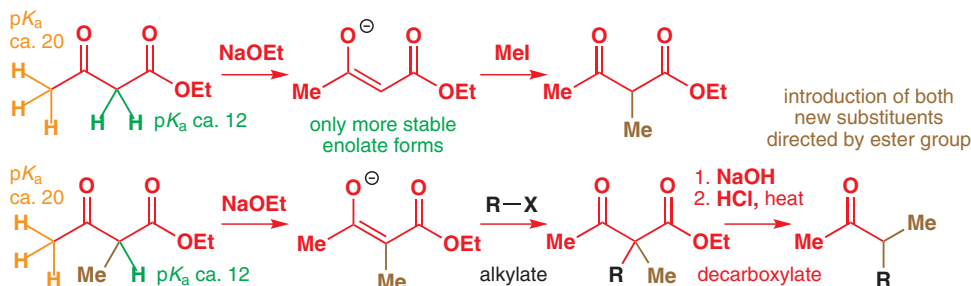

This principle can be extended to ketones whose enolates have less dramatic differences in stability. Since enols and enolates are alkenes, the more substituents they carry the more stable they are. So, in principle, even additional alkyl groups can control enolate formation under thermodynamic control. Formation of the more stable enolate requires a mechanism for equilibration between the two enolates, and this must be proton transfer. If a proton source is available—and this can even be just excess ketone—an equilibrium mixture of the two enolates will form. The composition of this equilibrium mixture depends very much on the ketone but, with 2-phenylcyclohexanone, conjugation ensures that only one enolate forms. The base is potassium hydride: it's strong, but small (and so has no difficulty removing the more hindered proton) and can be used under conditions that permit enolate equilibration.

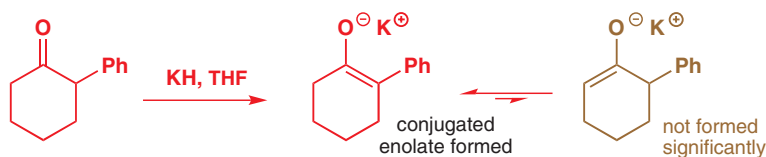

The more substituted lithium enolates can also be formed from the more substituted silyl enol ethers by substitution at silicon—a reaction you met in Chapter 20. The value of this reaction now becomes clear because the usual way of making silyl enol ethers (Me_3SiCl , Et_3N) typically produces, from unsymmetrical ketones, the more substituted of the two possible ethers. Because the silyl enol ether (unlike the enolate itself) can be purified, fully regiochemically pure enolates can be formed in this way.

➔ The influence of substituents on the stability of alkenes was discussed on p. 394. The fact that more substituted enols are more stable was discussed in Chapter 20, p. 465.

■ The mechanism for equilibration simply involves deprotonation of a molecule of ketone (the proton source) by a molecule of enolate:

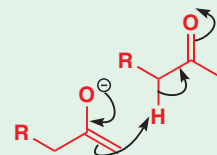

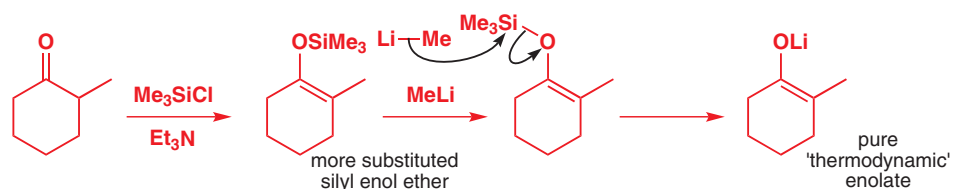

One possible explanation for the thermodynamic regioselectivity in the enol ether-forming step is related to our rationalization of the regioselectivity of bromination of ketones in acid on p. 464. Triethylamine is too weak a base (pK_a of Et_3NH^+ is about 10) to deprotonate the starting carbonyl compound (pK_a ca. 20), and the first stage of the reaction is probably an oxygen–silicon interaction. Loss of a proton now takes place through a cationic transition state, and this is stabilized rather more if the proton being lost is next to the methyl group: methyl groups stabilize partial cations just as they stabilize cations.

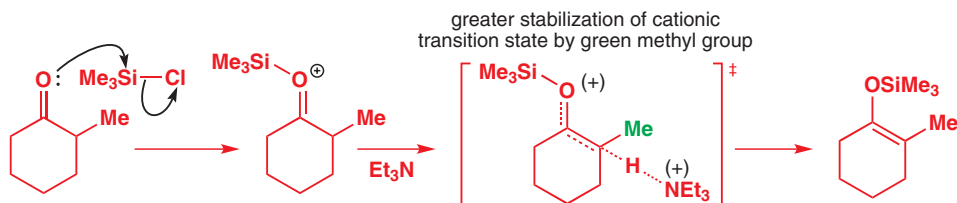

An alternative view is that reaction takes place through the enol: the Si–O bond is so strong that even neutral enols react with Me_3SiCl , on oxygen, of course. The predominant enol is the more substituted, leading to the more substituted silyl enol ether.

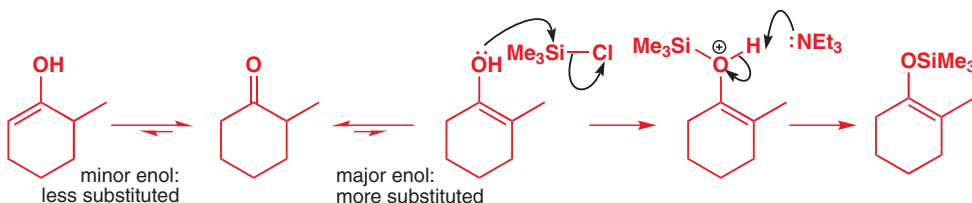

➔ Kinetic and thermodynamic control were discussed in Chapters 12, 23, and 24, pp. 264, 546, and 581.

■ To understand why less substituted C atoms have more acidic C–H bonds, think of base strengths: MeLi is a weaker base than $t\text{-BuLi}$, so the conjugate acid must be a stronger acid.

There must never be more ketone in the mixture than base, or exchange of protons between ketone and enolate will lead to equilibration. Kinetic enolate formations with LDA must be done by adding the ketone to the LDA so that there is excess LDA present throughout the reaction.

Kinetically controlled enolate formation

LDA is too hindered to attack most carbonyl C=O bonds, so it attacks C–H instead. And, if there is a choice of C–H bonds, it will attack the least hindered possible. It will also prefer to attack more acidic C–H bonds, and C–H bonds on less substituted carbons are indeed more acidic. Furthermore, statistics helps, since a less substituted C atom has more protons to be removed (three versus two in this example) so, even if the rates were the same, the less substituted enolate would predominate.

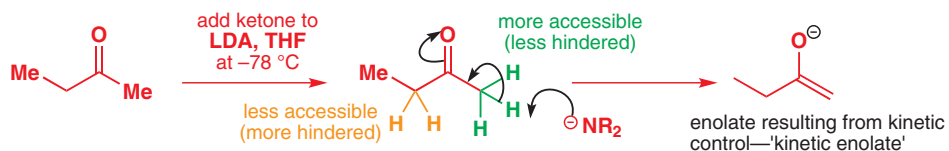

These factors multiply to ensure that the enolate that forms will be the one with the fewer substituents—provided we now prevent equilibration of the enolate to the more stable, more substituted one. This means keeping the temperature low, typically -78°C , keeping the reaction time short, and using an excess of strong base to deprotonate irreversibly and ensure that there is no remaining ketone to act as a proton source. The enolate that we then get is the one that formed faster, under kinetic control—known as the 'kinetic enolate'—and not necessarily the one that is more stable.

In general, this effect is sufficient to allow selective kinetic deprotonation of methyl ketones, that is, where the distinction is between Me and alkyl:

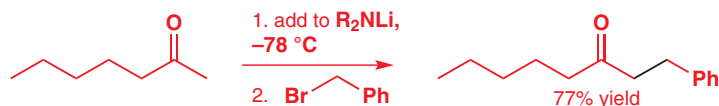

The same method works very well for 2-substituted cyclohexanones: the less substituted enolate forms. Even with 2-phenylcyclohexanone, which, as you have just seen, has a strong thermodynamic preference for the conjugated enolate, only the less substituted enolate forms.

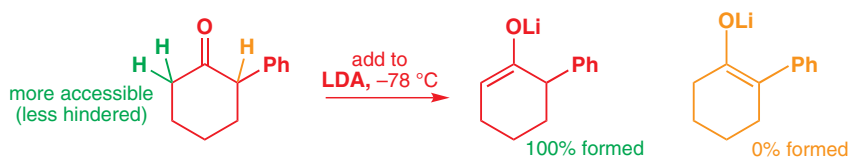

2-Methylcyclohexanone can be regioselectively alkylated using LDA and benzyl bromide by this method.

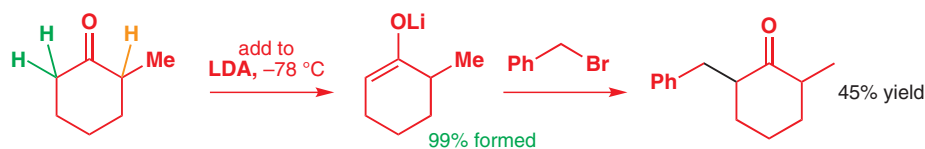

• Regioselective formation of enolates from ketones

Thermodynamic enolates are:

- more substituted
- more stable
- favoured by excess ketone, high temperature, long reaction time

Kinetic enolates are:

- less substituted
- less stable
- favoured by strong, hindered base (e.g. LDA), low temperature, short reaction time

Dianions allow unusual regioselectivity in alkylations of methyl acetoacetate

In Chapter 23, we introduced the idea that the last-formed anion in any dianion or trianion is the most reactive. Methyl acetoacetate is usually alkylated on the central carbon atom because that is the site of the most stable enolate. But methyl acetoacetate dianion—formed by removing a second proton from the usual enolate with a very strong base (usually butyllithium)—reacts first on the less stable anion: the terminal methyl group. Protonation of the more stable enolate then leads to the product. Butyllithium can be used as a base because the anionic enolate intermediate is not electrophilic.

➔ Dianions were discussed on p. 547.

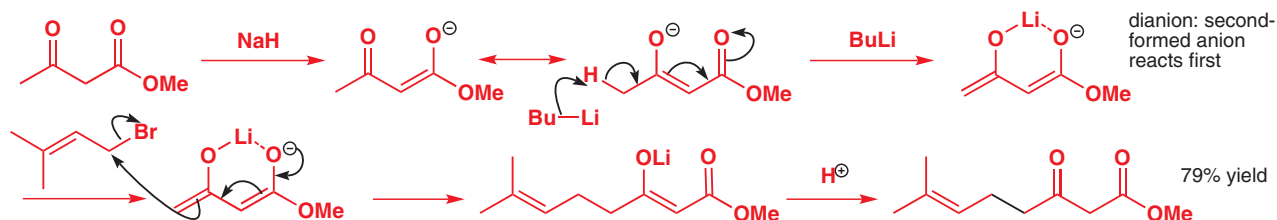

Enones provide a solution to regioselectivity problems

Enolates can be made regiospecifically from, for example, silyl enol ethers or enol acetates just by treating them with an alkyllithium. These are both substitution reactions in which RLi

displaces the enolate: one is $S_N2(\text{Si})$ and the other is attack at $\text{C}=\text{O}$. Provided there is no proton source, the enolate products have the same regiochemistry as their stable precursors, and single enolate regioisomers are formed.

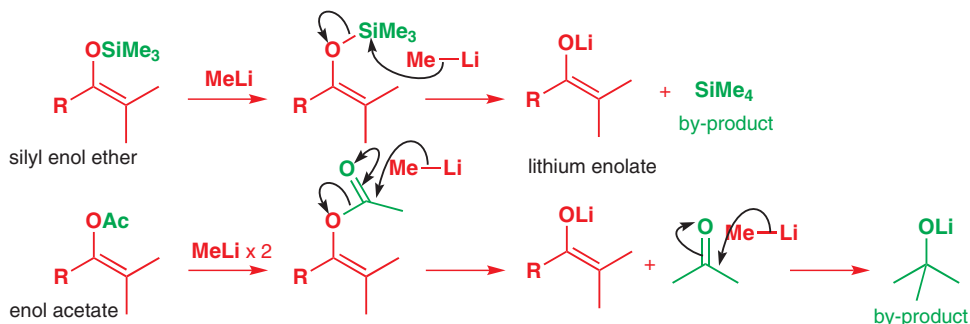

But there is a problem: forming enol ethers or enol esters will usually itself require a regioselective enolization! There are two situations in which this method is nonetheless useful: when the *more* substituted lithium enolate (which is hard to make selectively otherwise) is required, and when a silyl enol ether can be formed by a method not involving deprotonation. These methods are what we shall now consider.

Dissolving metal reduction of enones gives enolates regioselectively

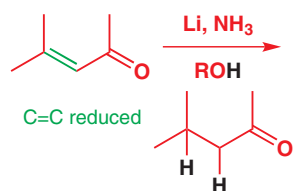

In Chapter 23 you met the Birch reduction: the use of dissolving metals (K, Na, or Li in liquid ammonia, for example) to reduce aromatic rings and alkynes. The dissolving metal reduction of enones by lithium metal in liquid ammonia is similar to these reactions—the $\text{C}=\text{C}$ bond of the enone is reduced, with the $\text{C}=\text{O}$ bond remaining untouched. An alcohol is required as a proton source and, in total, two electrons and two protons are added in a stepwise manner, giving net addition of a molecule of hydrogen to the double bond.

The mechanism follows that described on p. 543: transfer of an electron forms a radical anion that is protonated by the alcohol to form a radical. A second electron transfer forms an anion that can undergo tautomerization to an enolate.

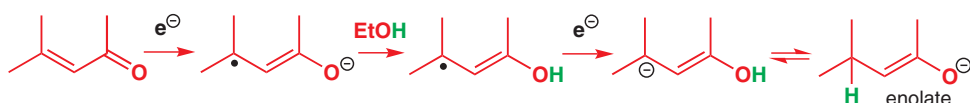

The enolate is stable to further reduction and protonation during the work-up will give a ketone. But reaction with an alkyl halide is more fruitful: because the enolate forms only where the double bond of the enone was, regioselective alkylation becomes possible.

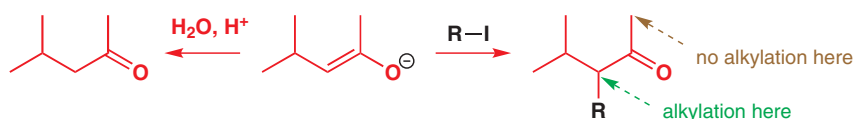

Thermodynamic control gives a 4:1 ratio of the two enols.

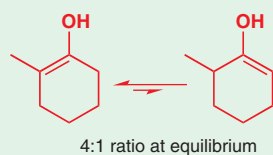

The example below leads to the regioselective methylation of methylcyclohexanone. Only 2% of the minor regioisomer is formed.

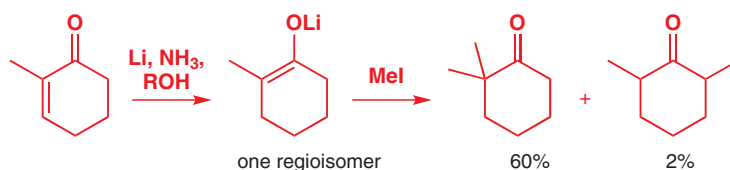

The transfer of electrons is not susceptible to steric hindrance so substituted alkenes pose no problem. In the next example, the enolate reacts with allyl bromide to give a single diastereoisomer of the product (the allyl bromide attacks from the face opposite the methyl group). Naturally, only one regioisomer is formed as well.

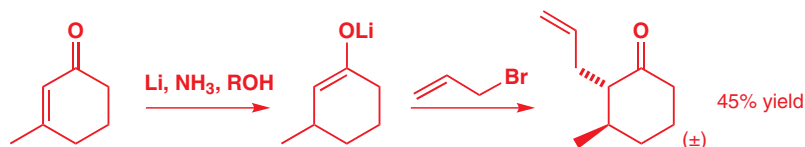

➔ We will discuss *stereo-selective* formation of single diastereoisomers in much more detail in Chapters 32 and 33.

Conjugate addition to enones gives enolates regioselectively

Although we did not talk in detail about them at that time, you will recall from Chapter 22 that conjugate addition to enones generates first an enolate, which is usually protonated in the work-up. But, again, more fruitful things can be done with the enolate under the right conditions.

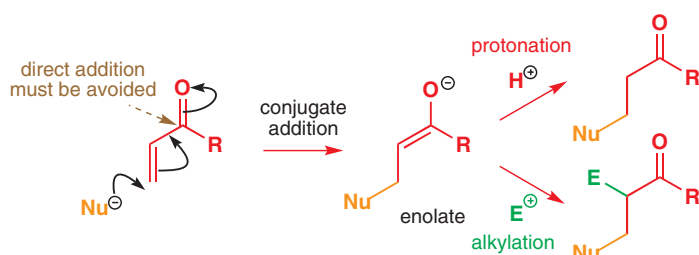

The simplest products are formed when Nu=H, but this poses a problem of regioselectivity in the nucleophilic attack step: a nucleophilic hydride equivalent that selectively undergoes conjugate addition to the enone is required. This is usually achieved with extremely bulky hydride reagents such as lithium or potassium tri(*sec*-butyl)borohydride (often known by the trade names of L- or K-Selectride, respectively). In this example, K-Selectride reduces the enone to an enolate that is alkylated by methyl iodide to give a single regioisomer.

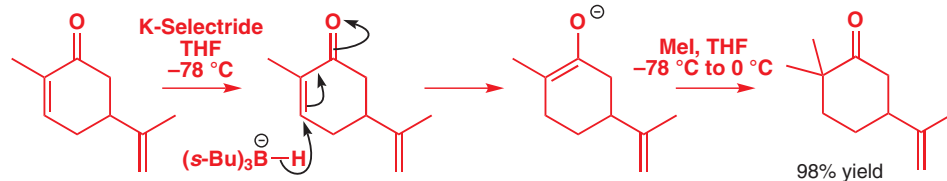

With organocopper reagents, conjugate addition introduces a new alkyl group and, if the resulting enolates are themselves alkylated, two new C–C bonds can be formed in a single step (a tandem reaction: one C–C bond formation rides behind another). In Chapter 22 we explained that the best organocuprate additions are those carried out in the presence of Me₃SiCl: the product of these reactions is a silyl enol ether, formed regioselectively (the 'enol' double bond is always on the side where the enone used to be).

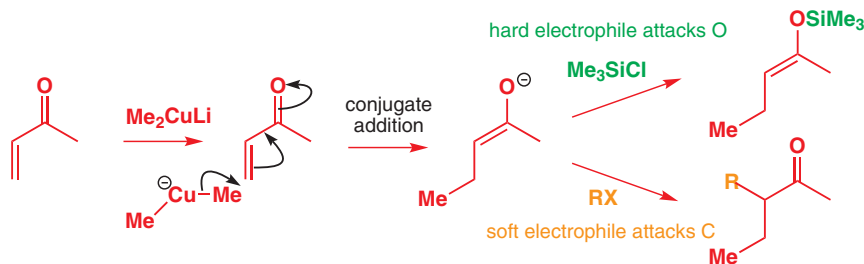

bulky reducing agents

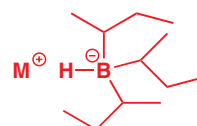

M = Li: lithium tri-*sec*-butylborohydride (L-Selectride)
M = K: potassium tri-*sec*-butylborohydride (K-Selectride)

■ The reaction also illustrates the difference in reactivity between conjugated and isolated double bonds.

The silyl enol ethers are too unreactive for direct alkylation by an alkyl halide, but by converting them to lithium enolates all the usual alkylation chemistry becomes possible. This type of reaction forms the key step in a synthesis of the natural product α -chamigrene. Conjugate addition of Me_2CuLi gives an enolate that is trapped with trimethylsilyl chloride. Methyl lithium converts the resulting silyl enol ether into a lithium enolate by substitution at Si. The natural product has a *spiro* six-membered ring attached at the site of the enolate, and this is made by alkylating with a dibromide (you saw this done on p. 598). The first substitution is at the more reactive allylic bromide. A second enolization is needed to make the ring, but this can be done under equilibrating conditions because the required six-membered ring forms much faster than the unwanted eight-membered ring that would arise by attack on the other side of the ketone.

► The ease with which different ring sizes form is discussed in Chapter 31.

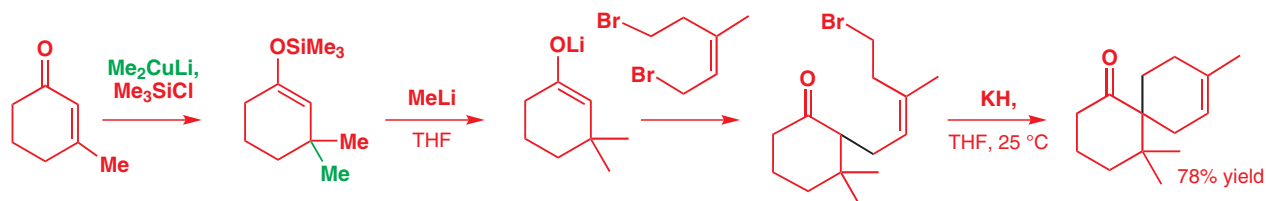

Among the most important of these tandem conjugate addition–alkylation reactions are those of cyclopentenones. With cyclopentenone itself, the *trans* diastereoisomer usually results because the alkylating agent approaches from the less hindered face of the enolate.

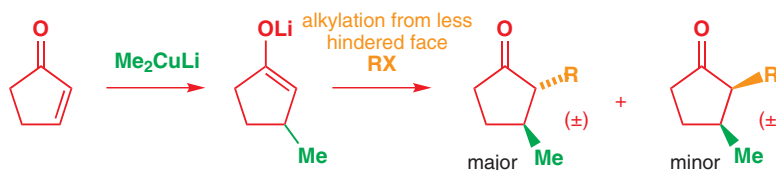

This is the sort of selectivity evident in the next example, which looks more complicated but is really just addition of an arylcopper reagent followed by alkylation (*trans* to the bulky Ar group) with an iodoester.

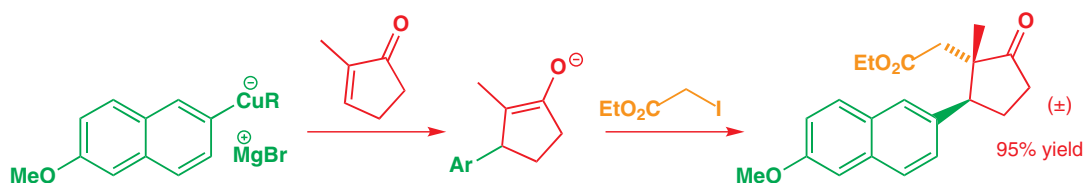

Synthesis of prostaglandin E_2

One of the most dramatic illustrations of the power of conjugate addition followed by alkylation is the short synthesis of the important biological molecule prostaglandin E_2 by Ryoji Noyori in Japan. The organocopper reagent and the alkylating agent contain all the functionality required for both side chains of the target in protected form. The required *trans* stereochemistry is assembled in the key step, which gives a 78% yield of a product requiring only removal of the silyl ether and ester protecting groups. The organometallic nucleophile was prepared from a vinyl iodide by halogen–metal exchange (Chapter 9). In the presence of copper iodide this vinyl lithium adds to the cyclopentenone in a conjugate sense to give an intermediate enolate. Because in this case the starting enone already has a stereogenic centre, this step is also stereoselective: attack on the less hindered face (opposite the silyl ether) gives the *trans* product. The resulting enolate was alkylated with the allylic iodide containing the terminal ester: once again the *trans* product was formed. It is particularly vital that enolate equilibration is avoided in this reaction to prevent the inevitable E1cB elimination of the silyloxy group that would occur from the other enolate. Deprotection of the silyl groups using TBAF (Chapter 23) gives the product.

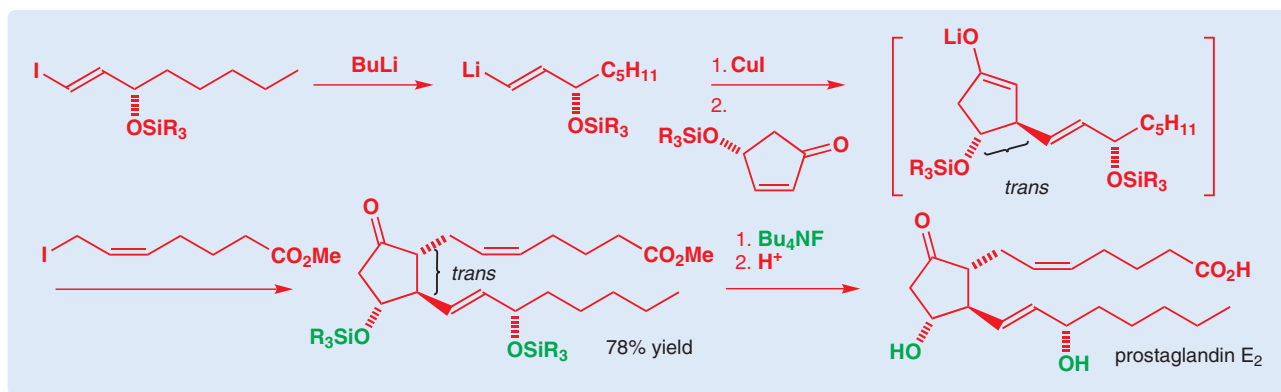

Using Michael acceptors as electrophiles

α,β -Unsaturated carbonyl compounds are, as you have just seen, an excellent source of regio-defined enolate equivalents. But they are also very effective electrophiles for reaction *with* enolates. In this last section we will consider conjugate addition reactions of enolates as an alternative way of making C–C bonds.

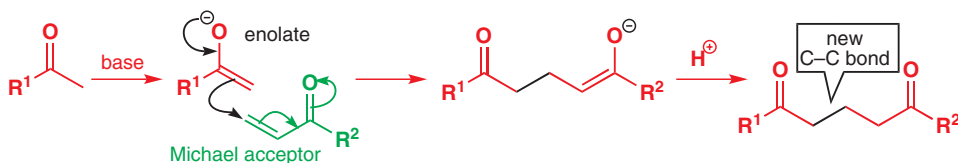

As with other conjugate additions, it is important in such reactions to choose conditions that prevent the nucleophile (here the enolate) attacking the C=O group directly. The same factors discussed in Chapter 22 govern the eventual outcome of the reaction. Thermodynamic control leads to conjugate addition but kinetic control leads to direct addition, so the key to successful conjugate addition is to ensure that direct addition to the carbonyl group is reversible. This enables the conjugate addition to compete and, as its product is more stable (it loses the weaker C=C π bond rather than the stronger C=O π), it eventually becomes the sole product.

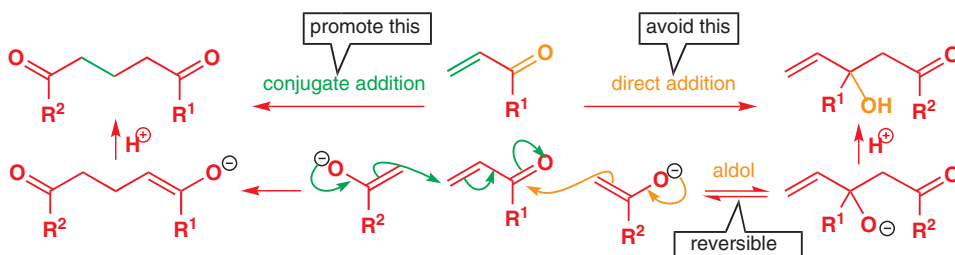

One of the most important ways of making the direct addition reversible is to use a more stabilized enolate, since expulsion of the stable anion from the direct addition product is more favourable. An additional consequence of adding a second electron-withdrawing group such as CO₂Et is that the direct addition product is more hindered (and therefore less stable) than the conjugate addition product.

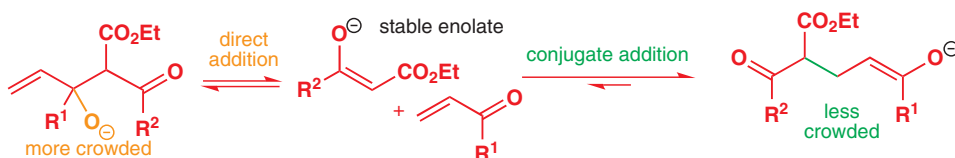

The nature of the carbonyl group in the α,β -unsaturated electrophile is also important as the more electrophilic carbonyl groups give more direct addition and the less electrophilic

A reminder from Chapter 22: a Michael acceptor is a compound capable of undergoing conjugate addition—an α,β unsaturated carbonyl compound or nitrile for example. Many Michael acceptors are toxic and carcinogenic compounds, and must be handled with care.

some Michael acceptors...

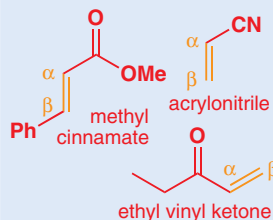

➔ Direct attack of an enolate on a C=O group—the aldol reaction—will be the subject of the next chapter.

🖱 Interactive mechanism for conjugate addition of enolates

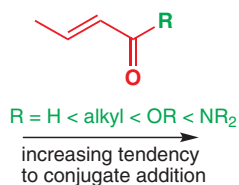

carbonyl groups (esters, amides) give more conjugate addition. Aldehydes and ketones can be pushed towards conjugate addition pathways by careful choice of enolate equivalent, while esters and amides are much less electrophilic at the carbonyl carbon and so are good substrates for conjugate addition.

• **Conjugate addition is thermodynamically controlled; direct addition is kinetically controlled.**

Stabilized enolates promote conjugate addition by:

- making direct addition (aldol reaction) more reversible
- making the direct addition (aldol) product more hindered.

Less reactive Michael acceptors promote conjugate addition by:

- making direct addition (aldol reaction) more reversible
- making the carbonyl group less electrophilic.

1,3-Dicarbonyl compounds undergo conjugate addition

β -Diesters (malonates and substituted derivatives, see p. 595) combine three useful features in conjugate addition reactions:

- they form stable enolate anions that undergo clean conjugate addition
- if required, one of the ester groups can be removed by hydrolysis and decarboxylation
- the remaining acid or ester is ideal for conversion into other functional groups.

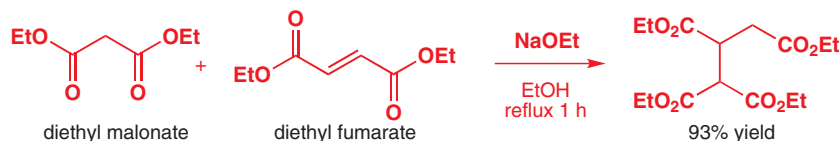

► Hydrolysis, decarboxylation, and the choice of base were discussed on p. 597.

Diethyl malonate adds to diethyl fumarate in a conjugate addition reaction promoted by sodium ethoxide in dry ethanol to give a tetraester. Diethyl fumarate is an excellent Michael acceptor because two ester groups withdraw electrons from the alkene. The mechanism involves deprotonation of the malonate, conjugate addition, and reprotonation of the product enolate by ethanol solvent. In this reaction two ester groups stabilize the enolate and two more promote conjugate addition.

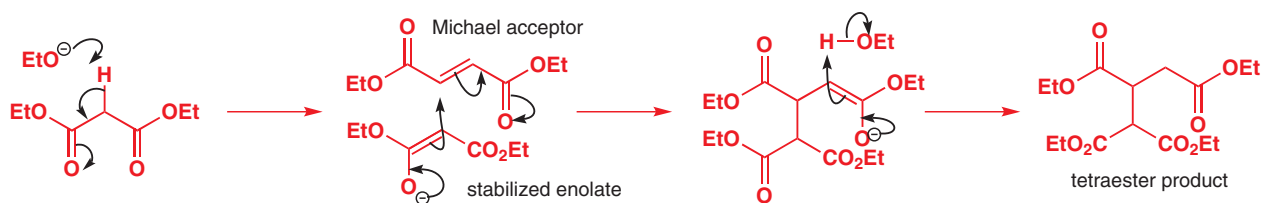

The value of malonate esters is illustrated in this synthesis of a substituted cyclic anhydride by conjugate addition to ethyl crotonate, hydrolysis, and decarboxylation, followed by dehydration with acetic anhydride. This route is very general and could be used to make a range of anhydrides with different substituents simply by choosing an appropriate unsaturated ester.

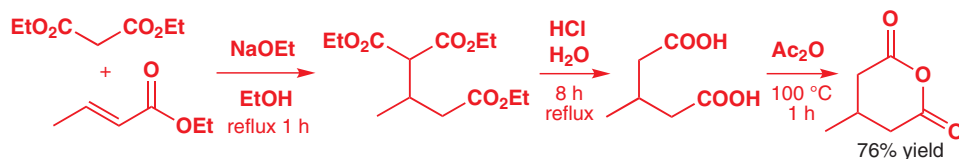

If the nucleophile is sufficiently enolized under the reaction conditions then the enol itself is able to attack the unsaturated carbonyl compound. Enols are neutral and thus soft nucleo-

philes favouring conjugate attack. 1,3-Diketones are enolized to a significant extent (Chapter 20), and under acidic conditions conjugate addition proceeds very efficiently even though there can be absolutely no base present. In this example methyl vinyl ketone (butenone) reacts with a cyclic β -diketone promoted by acetic acid to form a quaternary centre.

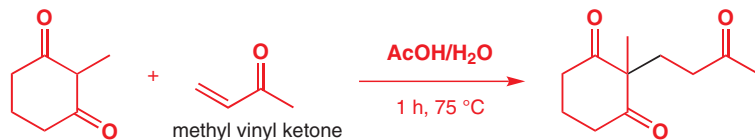

➔ The triketone product is an important intermediate in steroid synthesis as you will see in Chapter 26, p. 652.

The mechanism involves acid-catalysed conversion of the keto form of the cyclic β -diketone into the enol form, which is able to attack the protonated enone. The mechanistic detail is precisely analogous to the attack of an enolate; the only difference is that both reactants are protonated. The product is the enol form of the triketone, which rapidly tautomerizes to the more stable keto form.

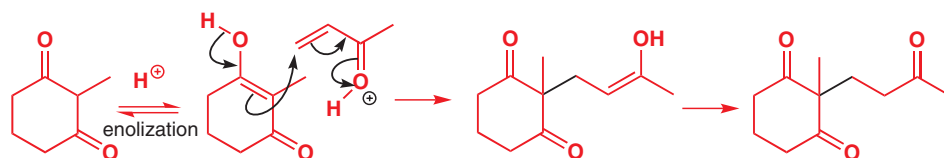

The thermodynamic control of conjugate addition allows even enals that are very electrophilic at the carbonyl carbon to participate successfully. As you will see in the next chapter, an aldol reaction (direct addition to C=O) must be possible here, but it is reversible and 1,4-addition eventually wins out. Acrolein combines with this five-membered diketone under very mild conditions to give a quantitative yield of product.

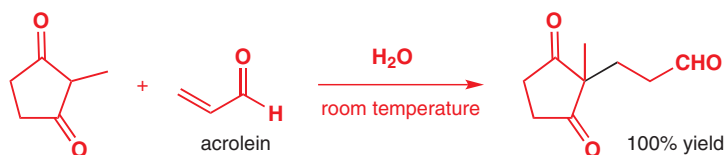

Alkali metal (especially Na, K) enolates can undergo conjugate addition

The use of two anion-stabilizing groups is a sure way of promoting conjugate addition, but it is not essential. Simple lithium enolates are not ideal nucleophiles for thermodynamically controlled conjugate addition because lithium binds strongly to oxygen and so tends to stabilize the aldol product. Better results are often observed with sodium or potassium enolates, which are more dissociated. Potassium *tert*-butoxide is the ideal base for this example as it is hindered and so will not attack the ester but is basic enough to deprotonate the ketone to a certain extent.

Two enolates are possible but, under the equilibrating conditions, the more stable enolate is the one leading to the product with a quaternary carbon atom.

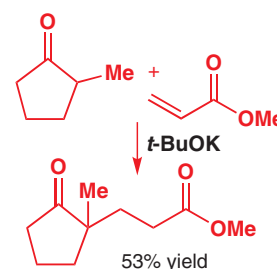
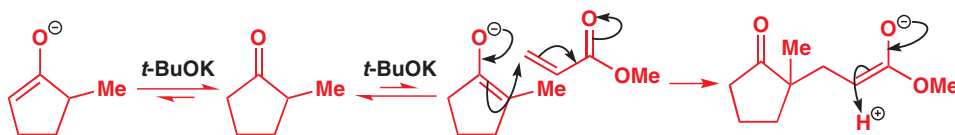

If the enolate carries a leaving group, we get a nice way of making a cyclopropane because the enolate formed by the conjugate addition can itself be alkylated.

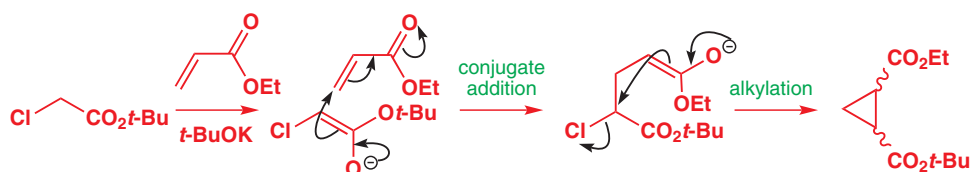

Enamines are convenient stable enol equivalents for conjugate addition

If you want a more reliable way of doing a conjugate addition of an aldehyde or ketone without having a second anion-stabilizing group, you need some stable and relatively unreactive enol equivalent. On p. 591 you saw how enamines, particularly those derived from cyclic secondary amines, are useful in alkylation reactions. These neutral species are also perfect for conjugate addition as they are soft nucleophiles but are more reactive than enols and can be prepared quantitatively in advance. The reactivity of enamines is such that heating the reactants together, sometimes neat, is all that is required. Acid catalysis can also be used to catalyze the reaction at lower temperature.

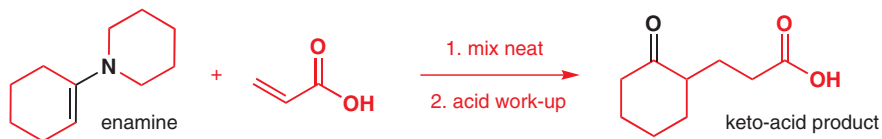

The mechanism is rather like enol addition. The differences are that the enamine is more nucleophilic because of the nitrogen atom and that the product is also an enamine, which can be converted into the corresponding carbonyl by mild acidic hydrolysis. This is usually performed during the work-up and so does not really constitute an extra step. The amine is washed out as the hydrochloride salt so isolation is straightforward. After conjugate addition the resulting enolate-iminium ion undergoes proton transfer rapidly to produce the more stable carbonyl-enamine tautomer. This is shown as an intramolecular process but it could just as easily be drawn with an external base and source of protons. The resulting enamine is then stable until aqueous acid is added at the end of the reaction. Hydrolysis occurs via the iminium ion to reveal the second carbonyl group and release the secondary amine.

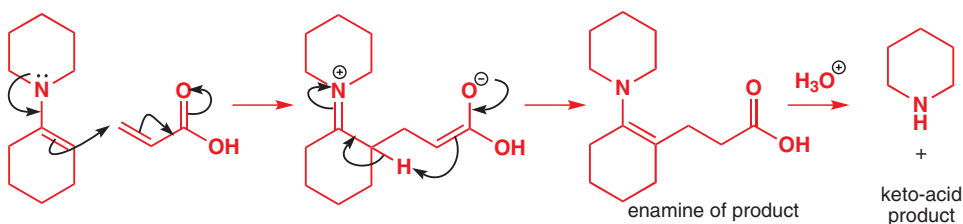

➔ In Chapter 41 we will discuss the catalytic use of chiral enamines to promote related reactions in asymmetric form.

In these two examples enamines from cyclohexanone formed with pyrrolidine and morpholine add in good yield to an α,β -unsaturated carbonyl compound with an extra electron-withdrawing methylthio or phenylsulfonyl group.

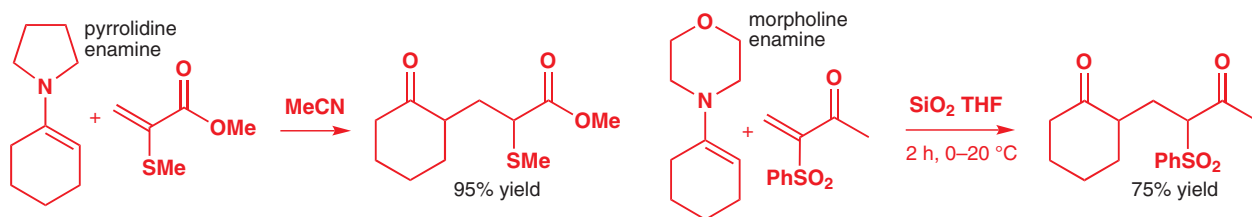

➔ See Chapter 20 for an introduction to silyl enol ethers and p. 466 for a description of Lewis acids. You saw a reaction similar to this with an alkyl halide as an electrophile on p. 604.

Conjugate addition of silyl enol ethers leads to the silyl enol ether of the product

The best alternatives to enamines for conjugate addition of enols of aldehyde, ketone, and carboxylic acid derivatives are silyl enol ethers. These stable neutral nucleophiles react very well with Michael acceptors either spontaneously or with Lewis acid catalysts such as TiCl_4 at low temperature. If the 1,5-dicarbonyl compound is required, then an aqueous work-up with either acid or base cleaves the silicon–oxygen bond in the product.

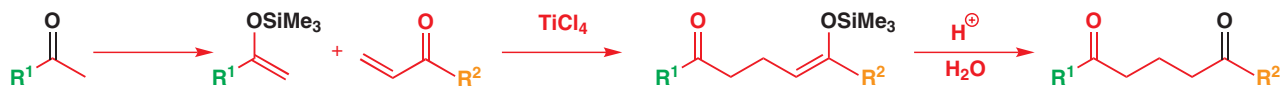

Addition of the silyl enol ether derived from acetophenone (PhCOMe) to a disubstituted enone promoted by titanium tetrachloride is very rapid and gives the diketone product in good yield even though a quaternary carbon atom is created in the conjugate addition. This is a typical example of this very powerful class of conjugate addition reactions.

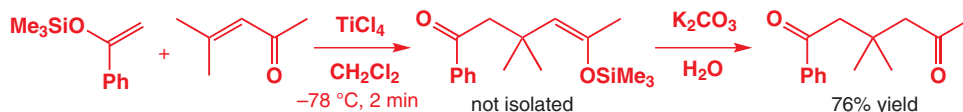

It is even possible to use a silyl enol ether to create a new C–C bond that joins two new quaternary centres. Silyl ketene acetals (the silyl enol ethers of esters) are more nucleophilic than ordinary silyl enol ethers, and in this example the silyl ketene acetal undergoes conjugate addition to an unsaturated ketone catalysed by the usual Lewis acid (TiCl_4) for such reactions.

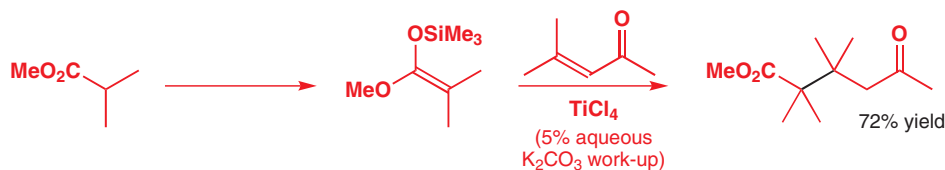

Ketene acetals

Because enol ethers of esters have two identical OR groups joined to the same end of the same double bond, you will see them called 'ketene acetals' or, here, 'silyl ketene acetals'. This is a reasonable description as you can imagine the carbonyl group of a ketene forming an acetal in the same way as an aldehyde. In fact, they cannot be made this way.

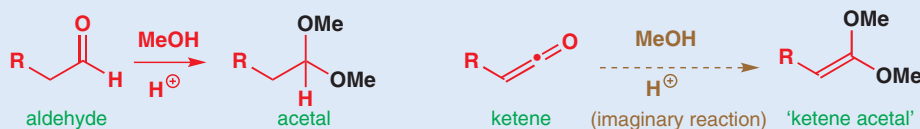

In these reactions, the electrophile coordinates to the TiCl_4 Lewis acid first, producing an activated enone that is attacked by the silylated nucleophile. It is difficult to determine at what stage the trimethylsilyl group moves from its original position and whether it is transferred intramolecularly to the product. In many cases the anion liberated from the Lewis acid (Cl^- , RO^- , Br^-) is a good nucleophile for silicon so it is reasonable to assume that there is a free trimethylsilyl species (Me_3SiX) that captures the titanium enolate:

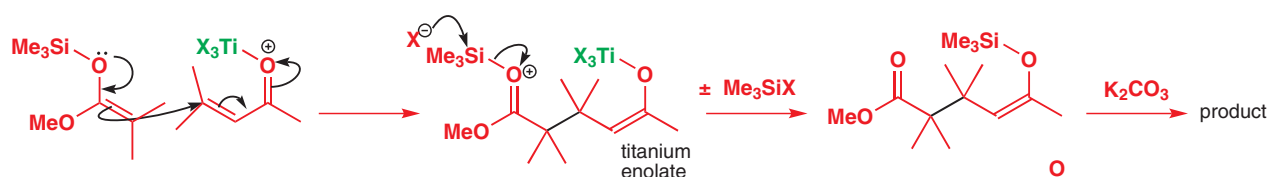

A variety of electrophilic alkenes will accept enol(ate) nucleophiles

The simplest and best Michael acceptors are those α,β -unsaturated carbonyl compounds with exposed unsaturated β carbon atoms, such as *exo*-methylene ketones, lactones, and vinyl ketones. However, their extreme reactivity can make them hard to handle (they polymerize readily), and in the next chapter (p. 621) you will meet a method that makes them *in situ* to circumvent these problems.

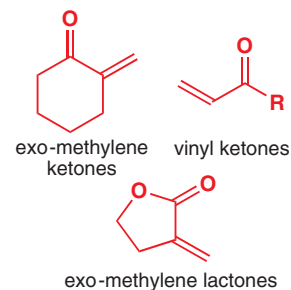

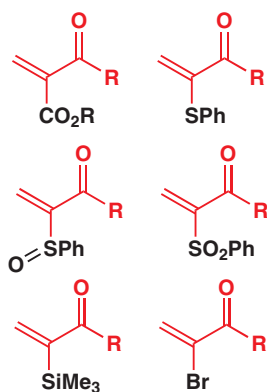

► The selective activation achieved by a nitrile group in enolate alkylation was explained at the start of this chapter.

One trick to persuade a stubborn enolate to do conjugate rather than direct substitution is to add an extra anion-stabilizing substituent in the α position. The margin shows a selection of reagents that do this. In each case the extra group (CO_2Et , SPh , SOPh , SO_2Ph , SiMe_3 , and Br) can be removed after the conjugate addition is complete.

Unsaturated esters are good Michael acceptors because they are not very electrophilic. Unsaturated amides are even less electrophilic and (provided they are tertiary and have no acidic NH protons) will even give conjugate addition products with lithium enolates.

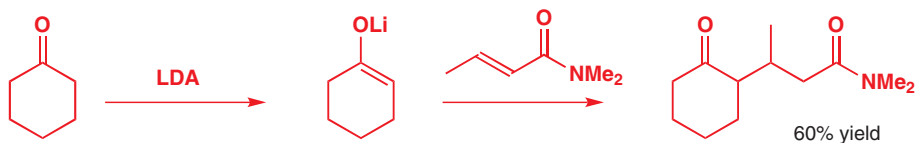

The nitrile group is not as reactive towards direct attack by nucleophiles as its carbonyl cousins but is equally able to stabilize an adjacent negative charge. Alkenes conjugated with nitriles are thus activated towards nucleophilic attack without the complications of competing direct addition to the activating group.

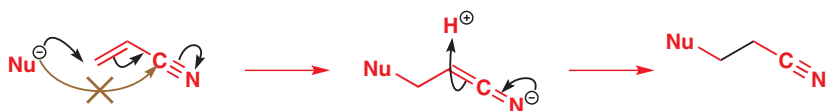

With base, methyl benzyl ketone forms its more stable enolate, which undergoes smooth and rapid conjugate addition to acrylonitrile. Acrylonitrile is one of the best Michael acceptors for enolates.

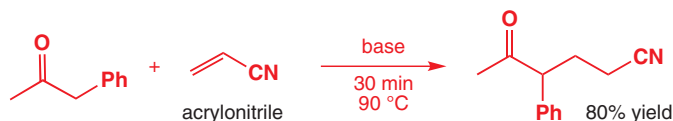

The cyanide group can also act as an anion-stabilizing group in the nucleophile. In combination with an ester group, the enolizable proton is acidified to such an extent that potassium hydroxide can be used as base.

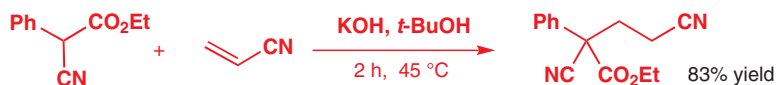

The simplest amino acid, glycine, would be an ideal starting material for the synthesis of more complicated amino acids but it does not easily form enols or enolates. By conversion to the methyl ester of its benzaldehyde imine, two electron-withdrawing groups are introduced to help stabilization of the enolate and conjugate addition of acrylonitrile is now possible. The base used was solid potassium carbonate. Simple hydrolysis of the alkylated product leads to the extended amino acid.

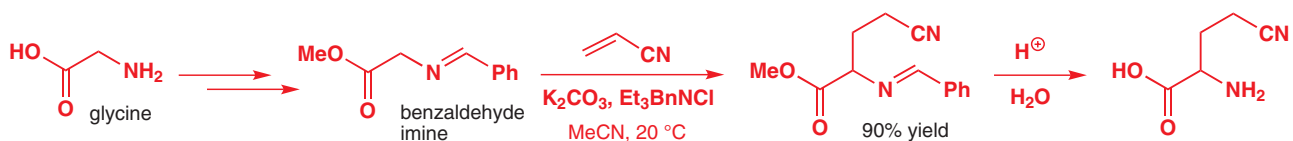

You saw on p. 606 how two ester groups in fumarate diesters encourage conjugate addition, but what if there are two *different* groups at the ends of the Michael acceptor? Then you must make a judgement as to which is more electron-withdrawing. One case is clear-cut. The **nitro** group is worth two carbonyl groups (p. 586) so that conjugate addition occurs β to the nitro group in this case.

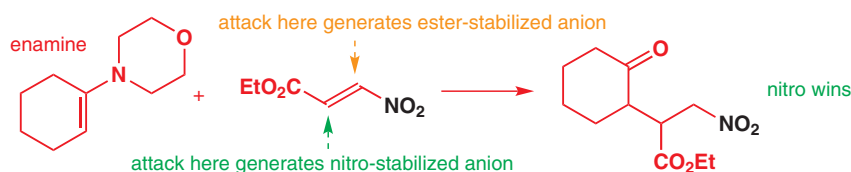

Nitroalkanes are superb nucleophiles for conjugate addition

In this chapter so far you have seen that highly stabilized anions, such as those derived from β -dicarbonyl compounds, are particularly good at nucleophilic addition because their stability helps to reverse the unwanted alternative direct $C=O$ addition (aldol) pathway, and facilitates proton transfer in the catalytic version of the reaction. The nitro group is so powerfully electron-withdrawing that just one is equivalent to two carbonyls in pK_a terms (p. 586). Thus if β -dicarbonyls are good for conjugate addition, you might expect nitroalkanes to undergo conjugate addition in just the same way. The good news is that they do, very well. The first stage is a base-catalysed conjugate addition.

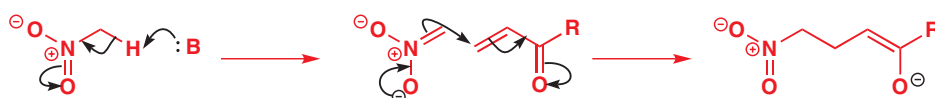

The product enolate that is formed is much more basic than the anion of the nitro compound so it removes a proton from the nitro compound and provides another molecule of anion for the second round of the reaction.

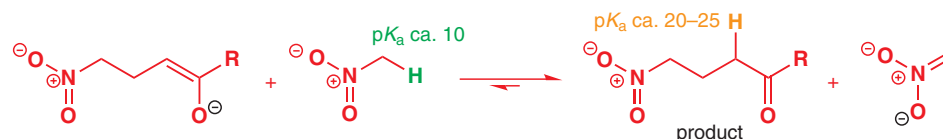

The acidifying effect of the nitro group is so profound that very mild bases can be used to catalyse the reaction. This enables selective removal of the proton next to the nitro group and helps to avoid side reactions of the carbonyl component. Common examples of mild bases include amines, quaternary ammonium hydroxides, and fluorides. Even basic alumina (a largely inert powder) is sufficient to catalyse virtually quantitative addition of this benzylic nitroalkane to cyclohexenone at room temperature!

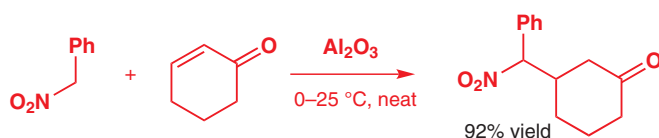

Anions of nitro compounds form quaternary centres with ease in additions to α,β -unsaturated mono- and diesters. The difference between the acidity of the protons next to a nitro group and those next to the esters in the products combined with the very mild basic conditions ensures that no unwanted side reactions occur.

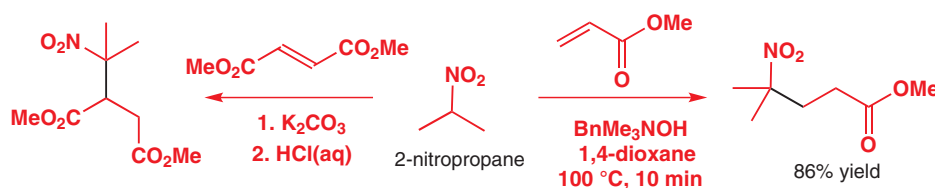

The effectiveness of nitro compound conjugate addition makes it ideal for use in combination with other reactions in making several bonds in one pot. The next example combines conjugate addition and intramolecular conjugate addition to make a six-membered ring.

Always draw out the nitro group in full when using it in mechanisms.

As you will see in Chapter 26, enolizable esters, ketones, and aldehydes are prone to undergo condensation reactions with themselves in the presence of strong bases.

■ Caesium is the most electropositive of readily available metals:
electronegativity = 0.79.

The base used for both steps is Cs_2CO_3 . The large caesium cation forms fully ionic compounds so the uncomplexed carbonate ion can exert its full basicity. Deprotonation of the conjugate addition product next to the nitro group produces a second anion, which does an intramolecular $\text{S}_{\text{N}}2$ displacement of iodide to form a six-membered ring.

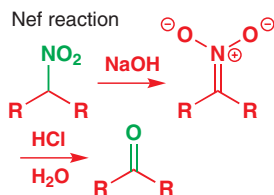
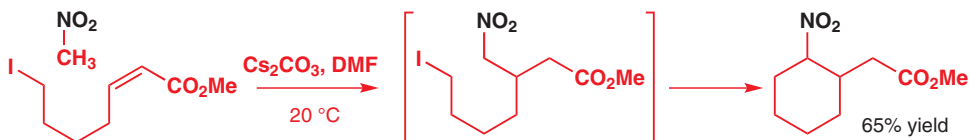

The nitro group can be converted into other useful functional groups following conjugate addition. Reduction gives primary amines while hydrolysis reveals ketones. The hydrolysis is known as the **Nef reaction** and used to be achieved by formation of the nitro-stabilized anion with a base such as sodium hydroxide followed by hydrolysis with sulfuric acid. These conditions are rather unforgiving for many substrates (and products) so milder methods have been developed. One of these involves reaction of the nitro 'enolate' with ozone (ozonolysis) at low temperature rather than treatment with acid. Base-catalysed conjugate addition of nitropropane to methyl vinyl ketone occurred smoothly to give the nitroketone. Formation of the salt with sodium methoxide was followed by oxidative cleavage of the $\text{C}=\text{N}$ linkage with ozone. The product was a 1,4-diketone, which was isolated without further aldol reaction by this route.

➔ Ozonolysis was described in Chapter 19.

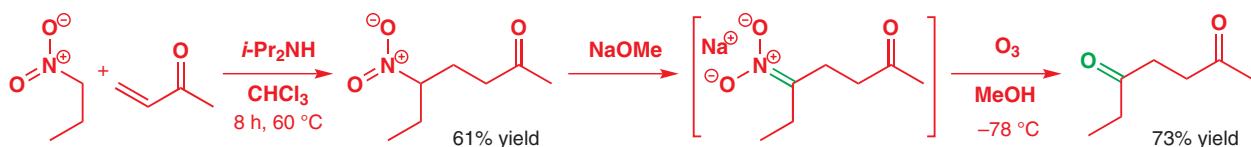

This is a good general method for the synthesis of 1,4-diketones, which can otherwise be difficult to make, and additional substituents are easily accommodated on the enone—a characteristic of conjugate addition.

The synthesis of a drug that acts on brain chemistry

We end this chapter with a simple commercial synthesis of a drug molecule—vivalan—described as a 'dopaminergic antagonist'. It uses four reactions that you have met: conjugate addition of an enolate to acrylonitrile, reduction of CN to a primary amine, alkylation, and reduction of the amide. There is another reaction involved—cyclization to an amide—but this occurs spontaneously.

■ The conjugate addition uses a base, benzyltrimethylammonium hydroxide, marketed as Triton B, which allows hydroxide to be soluble in organic solvents.

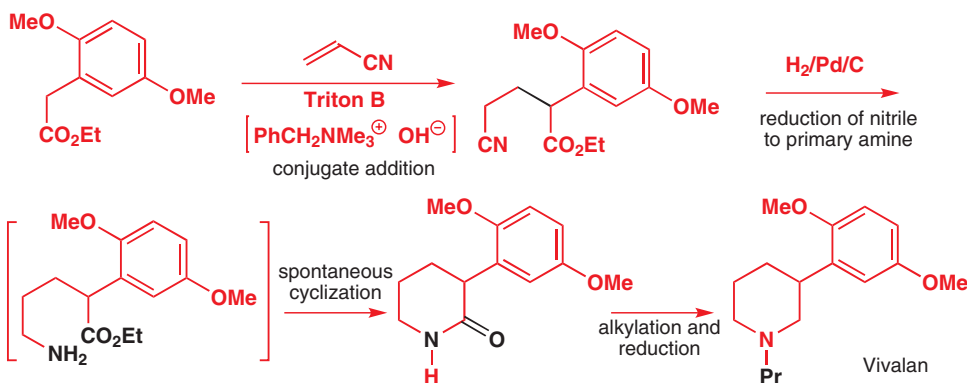

To conclude...

We have considered the reactions of enolates and their equivalents with alkyl halides and electrophilic alkenes. In the next chapter we move on to consider reactions we have deliber-

ately taken steps to avoid up to this point. We shall consider the same types of enolate equivalents reacting with carbonyl compounds themselves.

● Summary of methods for alkylating enolates

Specific enol equivalent	Notes
<i>To alkylate esters</i>	
<ul style="list-style-type: none"> LDA → lithium enolate use diethyl- or dimethylmalonate and decarboxylate 	gives acid (NaOH, HCl) or ester (NaCl, DMSO)
<i>To alkylate aldehydes</i>	
<ul style="list-style-type: none"> use enamine use silyl enol ether use aza-enolate 	<ul style="list-style-type: none"> with reactive alkylating agents with S_N1-reactive alkylating agents with S_N2-reactive alkylating agents
<i>To alkylate symmetrical ketones</i>	
<ul style="list-style-type: none"> LDA → lithium enolate use acetoacetate and decarboxylate use enamine use silyl enol ether use aza-enolate 	<ul style="list-style-type: none"> equivalent to alkylating acetone with reactive alkylating agents with S_N1-reactive alkylating agents with S_N2-reactive alkylating agents
<i>To alkylate unsymmetrical ketones on more substituted side</i>	
<ul style="list-style-type: none"> Me₃SiCl, Et₃N → silyl enol ether Me₃SiCl, Et₃N → silyl enol ether → lithium enolate with MeLi alkylate acetoacetate twice and decarboxylate addition or reduction of enone to give specific lithium enolate or silyl enol ether 	<ul style="list-style-type: none"> with S_N1-reactive alkylating agents with S_N2-reactive alkylating agents two successive alkylations of ethyl acetoacetate
<i>To alkylate unsymmetrical ketones on less substituted side</i>	
<ul style="list-style-type: none"> LDA → kinetic lithium enolate LDA then Me₃SiCl → silyl enol ether use dianion of alkylated acetoacetate and decarboxylate use enamine 	<ul style="list-style-type: none"> with S_N2-reactive electrophiles with S_N1-reactive electrophiles two successive alkylations of ethyl acetoacetate with reactive electrophiles

Further reading

P. Wyatt and S. Warren, *Organic Synthesis: Strategy and Control*, Wiley, Chichester, 2007, chapter 10. An early article by a pioneer in this field is H.O. House, M. Gall, and H. D. Olmstead, *J. Org. Chem.*, 1971, **36**, 2361. A good example of specific enolate forma-

tion and alkylation from an enone is D. Caine, S. T. Chao, and H. A. Smith, *Org. Synth.*, 1977, **56**, 52. F. A. Carey and R. J. Sundberg, *Advanced Organic Chemistry B, Reactions and Synthesis*, 5th edn, Springer 2007, chapter 1.

Check your understanding



To check that you have mastered the concepts presented in this chapter, attempt the problems that are available in the book's Online Resource Centre at <http://www.oxfordtextbooks.co.uk/orc/clayden2e/>

26

Reactions of enolates with carbonyl compounds: the aldol and Claisen reactions

Connections

➔ Building on

- Carbonyl compounds reacting with cyanide, borohydride, and bisulfite nucleophiles **ch6**
- Carbonyl compounds reacting with organometallic nucleophiles **ch9**
- Carbonyl compounds taking part in nucleophilic substitution reactions **ch10 & ch11**
- How enols and enolates react with heteroatomic electrophiles such as Br₂ and NO⁺ **ch20**
- How enolates and their equivalents react with alkylating agents **ch25**

Arriving at

- Reactions with carbonyl compounds as both nucleophile and electrophile
- How to make hydroxy-carbonyl compounds or enones by the aldol reaction
- How to be sure that you get the product you want from an aldol reaction
- The different methods available for doing aldol reactions with enolates of aldehydes, ketones, and esters
- How to use formaldehyde as an electrophile
- How to predict the outcome of intramolecular aldol reactions
- How esters react with enolates: the Claisen condensation
- How to acylate the enolates of esters and ketones
- How to get C-acylation and avoid O-acylation
- How to make cyclic ketones by intramolecular acylation
- Enamines in acylation reactions
- Modelling acylation on nature

➔ Looking forward to

- Retrosynthesis **ch28**
- Synthesis of aromatic heterocycles **ch29 & ch30**
- Asymmetric synthesis **ch41**
- Biological organic chemistry **ch42**

Introduction

The last chapter was about reactions of enols and enolates with alkylating agents such as alkyl halides and α,β -unsaturated carbonyl compounds. We emphasized how important it was to avoid nucleophilic attack at the carbonyl group.

alkylation of an enolate

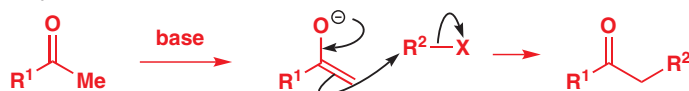

This chapter is about deliberately getting nucleophilic attack by enols and enolates on carbonyl groups of aldehydes or ketones (the aldol reaction in the first half of the chapter) or on acylating agents (the second half of the chapter).

Online support. The icon  in the margin indicates that accompanying interactive resources are provided online to help your understanding: just type www.chemtube3d.com/clayden/123 into your browser, replacing **123** with the number of the page where you see the icon. For pages linking to more than one resource, type **123-1, 123-2** etc. (replacing **123** with the page number) for access to successive links.

The aldol reaction

The simplest enolizable aldehyde is acetaldehyde (ethanal, CH_3CHO). What happens if we add a small amount of base, say NaOH , to this aldehyde? Some of it will form the enolate ion.

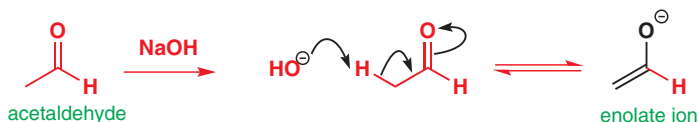

Only a small amount of the nucleophilic enolate ion is formed: as we pointed out in Chapter 25, hydroxide is not basic enough to enolize an aldehyde completely. Each molecule of enolate is surrounded by molecules of the aldehyde that are not enolized and so still have the electrophilic carbonyl group intact. The enolate ion will attack one of these aldehydes to form an alkoxide ion, which will be protonated by the water molecule formed in the first step.

■ $\text{p}K_{\text{a}} \text{H}_2\text{O} = 15.7$;
 $\text{p}K_{\text{a}} \text{MeCHO} \sim 20$

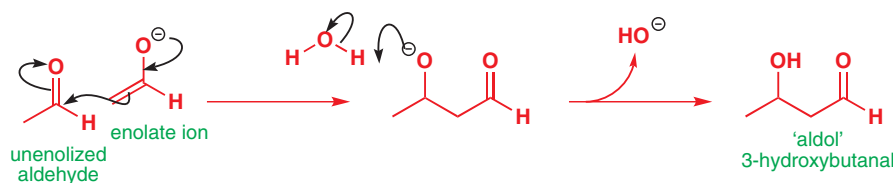

The product is an *aldehyde* with a hydroxy (*ol*) group and it has the trivial name **aldol**. The name *aldol* is given to the whole class of reactions between enolates (or enols) and carbonyl compounds even if in most cases the product is not a hydroxy-aldehyde at all. Notice that the base catalyst (hydroxide ion) is regenerated in the last step, so it is truly a catalyst.

This reaction is so important because of the carbon–carbon bond formed when the nucleophilic enolate attacks the electrophilic aldehyde. This bond is shown as a black bond in this version of the key step.

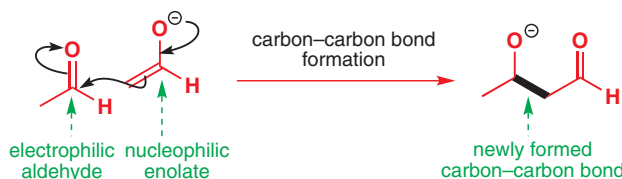

The reaction occurs with ketones as well. Acetone is a good example for us to use at the start of this chapter because it gives an important product, and as it is a symmetrical ketone, there can be no argument over which way it enolizes. Each step is the same as the aldol sequence with acetaldehyde, and the product is again a hydroxy-carbonyl compound, but this time a hydroxy-ketone.

the enolization step



the carbon–carbon bond-forming step

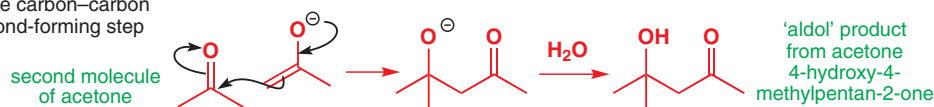

The acetaldehyde reaction works well when one drop of dilute sodium hydroxide is added to acetaldehyde. The acetone reaction is best done with insoluble barium hydroxide, $\text{Ba}(\text{OH})_2$. Both approaches keep the base concentration low. Without this precaution, the aldol products are not the compounds isolated from the reaction. With more base, further reactions occur because the aldol products dehydrate rather easily under the reaction conditions to give stable conjugated unsaturated carbonyl compounds.

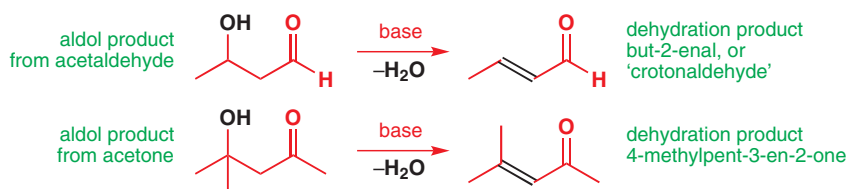

■ See p. 399 for a discussion of the E1cB mechanism.

These are elimination reactions, and you met them in Chapter 17, where the possible mechanisms are discussed. You cannot normally eliminate water from an alcohol in basic solution as hydroxide is a bad leaving group. It is the carbonyl group that allows elimination here: these are E1cB reactions, with a second enolization allowing the loss of OH⁻.

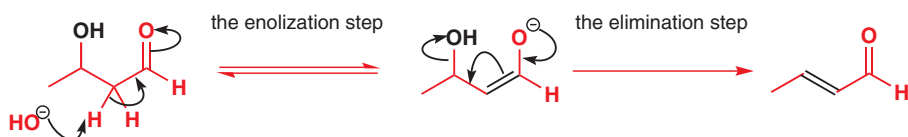

■ You do not, of course, need to learn each result individually: if you ever need to do a simple aldol reaction, you should consult the massive review in the 1968 volume of *Organic Reactions*.

In the examples that follow you will see that the base-catalysed aldol reaction sometimes gives the aldol and sometimes the elimination product. The choice is partly based on conditions—the more vigorous the conditions (stronger base, higher temperature, longer time) the more likely elimination is to occur—and partly on the structure of the reagents.

The elimination is even easier in acid solution and acid-catalysed aldol reactions commonly give unsaturated products instead of aldols. In this simple example with a symmetrical cyclic ketone, the enone is formed in good yield in acid or base. We shall use the acid-catalysed reaction to illustrate the mechanism. First the ketone is enolized under acid catalysis as you saw in Chapter 20.

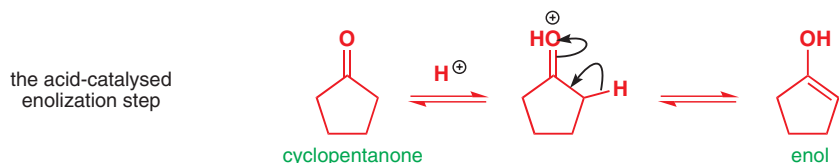

Then the aldol reaction takes place. Enols are less nucleophilic than enolates, and the reaction occurs because the electrophilic carbonyl component is protonated: the addition is acid-catalysed. An acid-catalysed aldol reaction takes place.

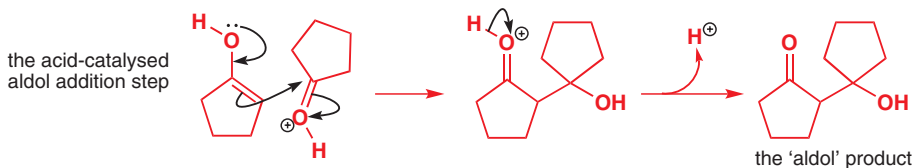

The aldol is a tertiary alcohol and would be likely to eliminate by an E1 mechanism in acid even without the carbonyl group. But the carbonyl ensures that only the stable conjugated enone is formed. Notice too that the dehydration is genuinely acid-catalysed as the acid reappears in the very last step.

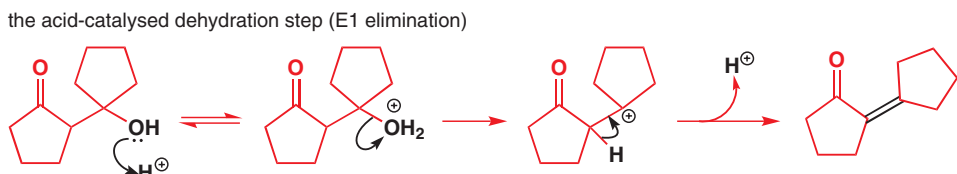

Interactive mechanism for acid-catalysed aldol reaction

None of these intermediates is detected or isolated in practice—simple treatment of the ketone with acid gives the enone in good yield. A base-catalysed reaction gives the same product via the aldol–E1cB elimination mechanism.

the base-catalysed dehydration step (E1cB elimination)

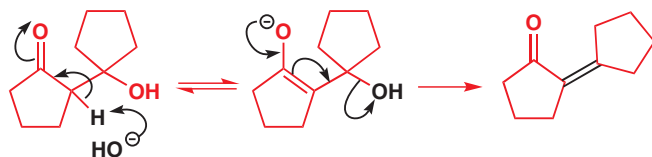

- Base-catalysed aldol reactions may give the aldol product, or may give the dehydrated enone or enal by an E1cB mechanism.
- Acid-catalysed aldol reactions may give the aldol product, but usually give the dehydrated enone or enal by an E1 mechanism.

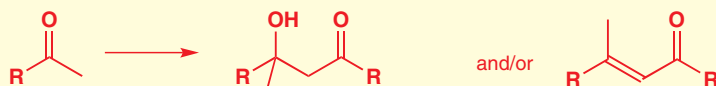

Aldol reactions of unsymmetrical ketones

If the ketone is blocked on one side so that it cannot enolize—in other words it has no protons on that side—only one aldol reaction is possible. Ketones of this type might bear a tertiary alkyl or an aryl substituent. *tert*-Butyl methyl ketone (3,3-dimethylbutan-2-one), for example, gives aldol reactions with various bases in 60–70% yield. Enolization cannot occur towards the *t*-butyl group and must occur towards the methyl group instead.

ketones which can enolize only one way:

a *tert*-alkyl group cannot enolize as it has no α protons

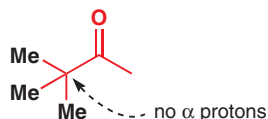

trigonal carbon atom in aryl ring with no substituents

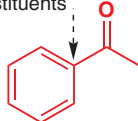

an aryl ketone has no substituents at the α position

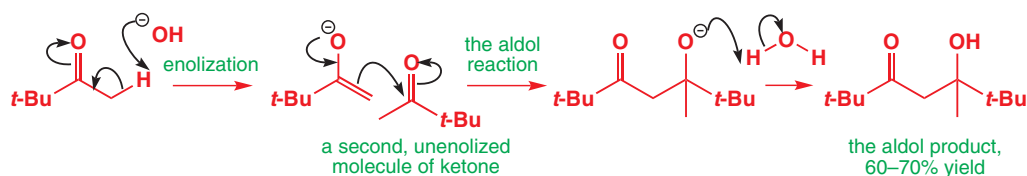

An especially interesting case of the blocked carbonyl compound is the lactone or cyclic ester. Open-chain esters do not give aldol reactions: they prefer a different reaction that is the subject of the second half of this chapter. But lactones are in some ways quite like ketones (the stretching frequencies of their C=O groups in the IR are similar, and unlike esters they react with NaBH_4) and give unsaturated carbonyl products under basic catalysis. Enolization is unambiguous because the ester oxygen atom blocks enolization on one side.

enolate formation from a lactone (cyclic ester)

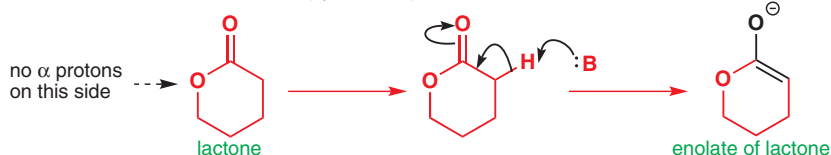

■ B in this scheme means 'base'.

Aldol condensations

The term 'condensation' is often used for reactions like this. Condensations are reactions where two molecules combine with the loss of another small molecule—usually water. In this case, two ketones combine with the loss of water. This reaction is called an aldol condensation and chemists may say 'two molecules of cyclopentanone condense together to give a conjugated enone'. You will also find the term 'condensation' used for all aldol reactions whether they occur with dehydration or not. The distinction is no longer important.

condensation of cyclopentanone

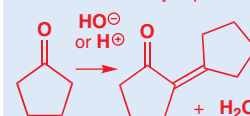

The enolate then attacks the carbonyl group of an unenolized lactone just as we have seen with aldehydes and ketones.

aldol reaction of a lactone (cyclic ester)

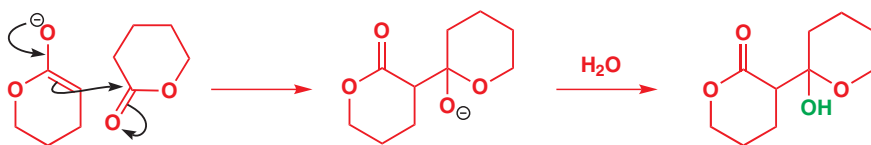

The last step is the familiar dehydration. As this reaction is being carried out in base we had better show the E1cB mechanism via the enolate of the aldol product.

the dehydration step

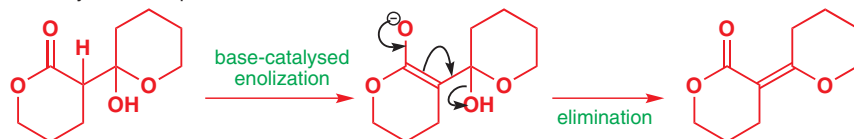

You might have been surprised that the intermediate in the aldol step of this reaction did not decompose. This intermediate could be described as a tetrahedral intermediate in a nucleophilic substitution at a carbonyl group (Chapter 10). Why then does it not break down in the usual way?

The equilibrium does not affect the eventual product; it simply withdraws some of the material out of the productive reaction. We call this sort of equilibrium a *parasitic equilibrium* as it has no real life of its own—it just sucks the blood of the reaction.

possible breakdown of a tetrahedral intermediate in a lactone aldol reaction

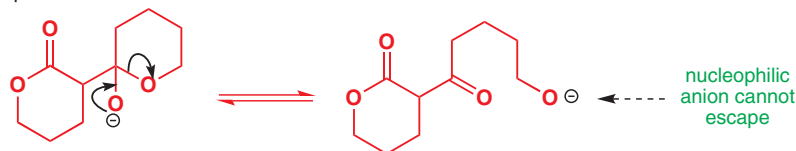

The best leaving group is the alkoxide and the product is quite reasonable. But what is it to do now? The only reasonable next step is for it to close back up again. Because the lactone is a *cyclic ester*, the leaving group cannot escape—it must stay attached to the molecule. This reaction is reversible, but dehydration is effectively irreversible because it gives a stable conjugated product. Normal, acyclic esters are different: their alkoxide leaving groups *can* leave, and the result is a different sort of reaction, which you will meet later in this chapter.

Cross-condensations

So far we have considered only 'self-condensations'—dimerization reactions of a single carbonyl compound. These form only a tiny fraction of known aldol reactions. Those that occur between two different carbonyl compounds, one acting as a nucleophile in its enol or enolate form, and the other as an electrophile, are called **cross-condensations**. They are more interesting than self-condensations, but working out what happens needs more thought. We shall start with an example that works well. The ketone PhCOMe reacts with 4-nitrobenzaldehyde in aqueous ethanol under NaOH catalysis to give a quantitative yield of an enone.

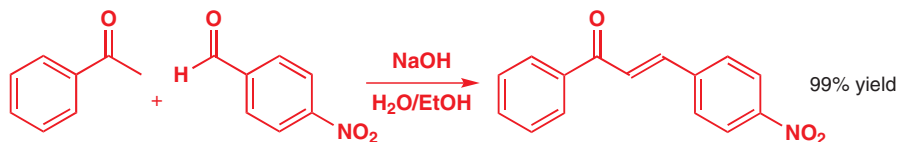

The first step must be the formation of an enolate anion using NaOH as a base. Although both carbonyl compounds are unsymmetrical, there is only one site for enolization as there is only one set of α protons, on the methyl group of the ketone. The aldehyde has no α protons at all.

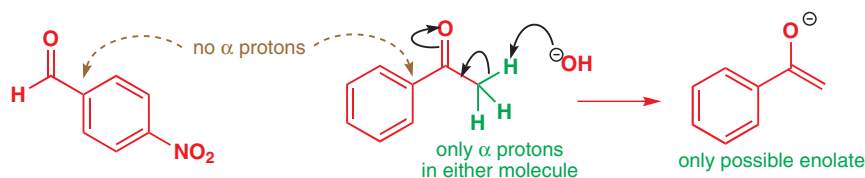

To get the observed product, the enolate obviously attacks the aldehyde to give an aldol, which then dehydrates by the E1cB mechanism.

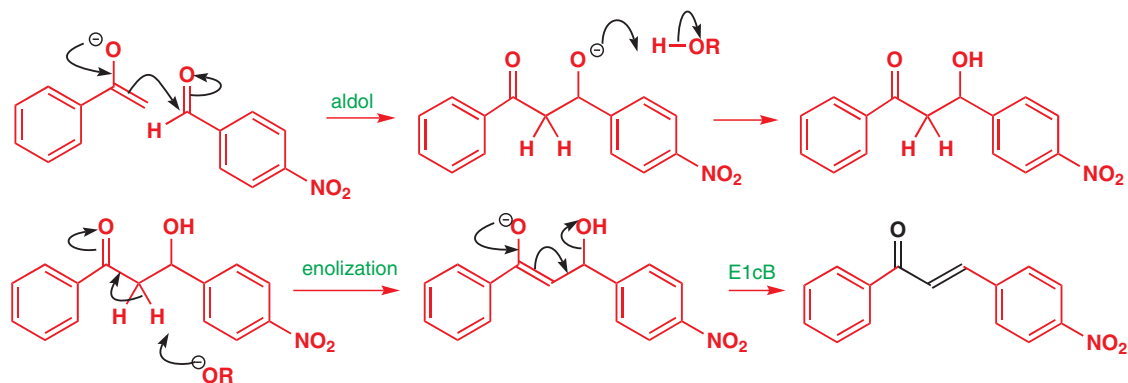

Now, in this step there was a choice. The enolate could have attacked another molecule of unenolized ketone. It didn't, because ketones are less reactive than aldehydes (Chapter 6). In this case the aldehyde has an electron-withdrawing nitro substituent too, making it even more reactive. The enolate selects the better electrophile—that is, the aldehyde.

In other cases the balance may shift towards self-condensation. You might think that a crossed aldol reaction between acetaldehyde and benzophenone (diphenylketone $\text{Ph}_2\text{C}=\text{O}$) should work well.



After all, only the aldehyde can enolize and the enolate could attack the ketone.

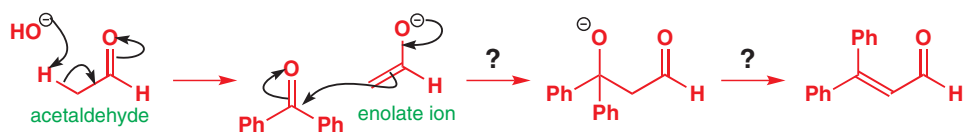

But it won't work. The ketone is very hindered and very conjugated. It is less electrophilic than a normal ketone and normal ketones are less electrophilic than aldehydes. Given a choice between attacking this ketone and attacking another (but unenolized) molecule of acetaldehyde, the enolate will choose the aldehyde every time. The reaction at the start of the chapter occurs, while the ketone is just a spectator.

● Successful crossed aldol reactions

For this kind of crossed aldol reaction to work well we must have two conditions:

- One partner only must be capable of enolization.
- The other partner must be incapable of enolization and be *more electrophilic than the enolizable partner*.

Everyone remembers the first of these conditions, but it is easy to forget the second.

The Mannich reaction

At first sight formaldehyde (methanal, $\text{CH}_2=\text{O}$) seems the ideal electrophilic partner in a mixed aldol reaction. It cannot enolize. (Usually we are concerned with α hydrogen atoms in an aldehyde. Formaldehyde does not even have α carbon atoms.) And it is a super aldehyde. Aldehydes are more electrophilic than ketones because a hydrogen atom replaces one of the alkyl groups. Formaldehyde has two hydrogen atoms.

The trouble is that it is *too* reactive. It tends to react more than once and to give extra unwanted reactions as well. You might think that condensation between acetaldehyde and formaldehyde in base would be quite simple. The acetaldehyde alone can form an enolate, and this enolate will attack the more electrophilic carbonyl group, which is formaldehyde. In each reaction the only possible enolate attacks another molecule of formaldehyde. By now you have got the idea so we simply draw the next enolate and the structure of the third aldol.

Formaldehyde

Formaldehyde is not available as a pure monomer because it forms trimers and tetramers in the pure state. The aqueous solution 'formalin' used to preserve biological specimens is available—it is 37% formaldehyde and mostly consists of the hydrate $\text{CH}_2(\text{OH})_2$; see Chapter 6. A pure dry polymer 'paraformaldehyde' is also available and was mentioned in Chapter 9. Neither of these is particularly useful in aldol reactions. The aqueous solution is used in the Mannich reaction that we describe shortly. It is possible to make the short-lived monomer and capture it with a lithium enolate, but this is not trivial experimentally.

crossed aldol reaction between acetaldehyde and formaldehyde

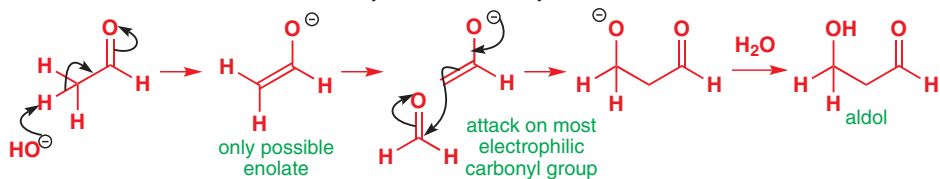

This aldol is formed all right but it is not the final product of the reaction because, with an electrophile as powerful as formaldehyde, a second and a third aldol follow swiftly on the heels of the first.

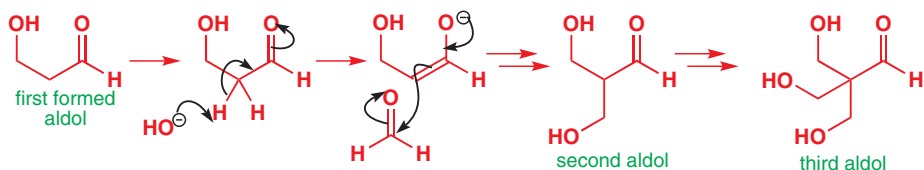

Even this is not all. A fourth molecule of formaldehyde reacts with hydroxide ion and then reduces the third aldol. This reduction is known as the Cannizzaro reaction, and is described in the box below. The final product is the highly symmetrical 'pentaerythritol', $\text{C}(\text{CH}_2\text{OH})_4$, with four CH_2OH groups joined in a tetrahedral array about the same carbon atom. The overall reaction uses four molecules of formaldehyde and can give a high yield (typically 80% with NaOH but as much as 90% with MgO) of the product.

reduction by the Cannizzaro reaction

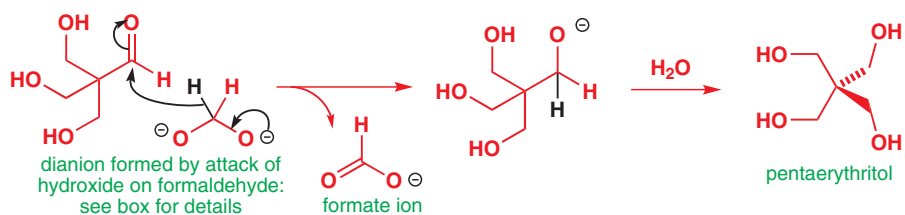

The Cannizzaro reaction

As you know, aldehydes are generally at least partly hydrated in water. Hydration is catalysed by base, and we can represent the hydration step in base like this. The hydration product is an anion but, if the base is sufficiently strong (or concentrated) and as long as the aldehyde cannot be enolized, at least some will be present as a dianion.

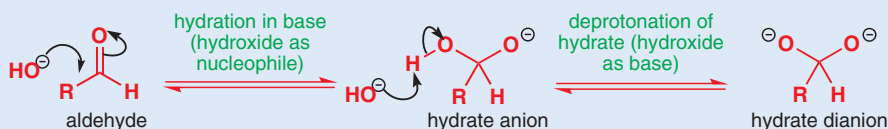

The dianion is very unstable, and one way in which it can become much more stable is by behaving like a tetrahedral intermediate. Which is the best leaving group? Out of a choice of O^{2-} , R^- , and H^- , it's H^- that (if reluctantly) has to go. Hydride is, of course, too unstable to be released into solution but, if there is a suitable electrophile at hand (another molecule of aldehyde, for example), it is transferred to the electrophilic centre in a mechanism that bears some resemblance to a borohydride reduction.

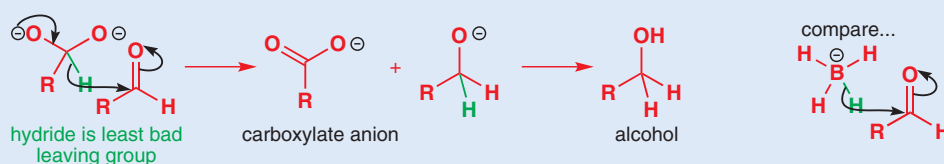

➔ There is more on the mechanism of the Cannizzaro reaction in Chapter 39.

A general solution to using formaldehyde in aldol reactions is to use the **Mannich reaction**. A typical example is shown in the margin: the reaction involves an enolizable aldehyde or ketone (here we use cyclohexanone), a secondary amine (here dimethylamine), the Mannich reaction formaldehyde as its aqueous solution, and catalytic HCl. The product is an amino-ketone from the addition of one molecule each of formaldehyde and the amine to the ketone.

The mechanism involves the preliminary formation of an imine salt from the amine and formaldehyde. The amine is nucleophilic and attacks the more electrophilic of the two carbonyl compounds available, which is, of course, formaldehyde. No acid is needed for this addition step, but acid-catalysed dehydration of the addition product gives the imine salt. In the normal Mannich reaction, this is just an intermediate but it is quite stable and the corresponding iodide is sold as Eschenmoser's salt for use in Mannich reactions.

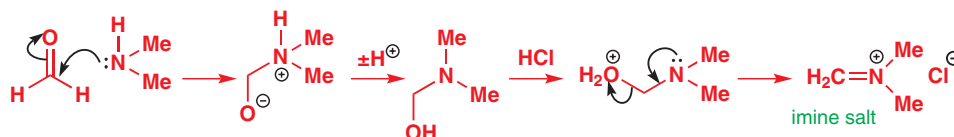

The electrophilic salt can now add to the enol (we are in acid solution) of the ketone to give the product of the reaction, an amine sometimes called a **Mannich base**.

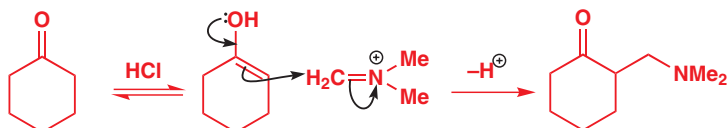

By using this reaction, you can add one molecule of formaldehyde—and one only—to carbonyl compounds. You might, of course, reasonably object that the product is not actually an aldol product at all—indeed, if you wanted the aldol product, the Mannich reaction would be of little use to you. It nevertheless remains a very important reaction. First of all, it is a simple way to make amino-ketones and many drug molecules belong to this class.

Secondly, the Mannich products can be converted to enones. The most reliable method for making the enone is to alkylate the amine product of the Mannich reaction with MeI and then treat the ammonium salt with base. Enolate ion formation leads to an E1cB reaction rather like the dehydration of aldols, but with a better leaving group.

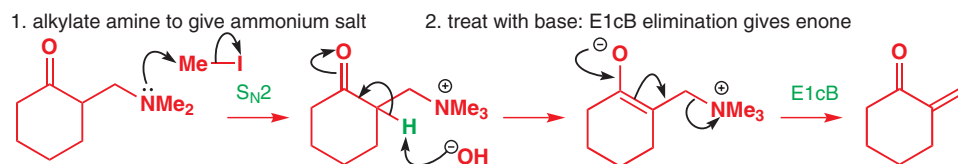

Enones like this, with two hydrogen atoms at the end of the double bond, are called **exomethylene compounds**; they are very reactive and cannot easily be made or stored. They certainly cannot be made by aldol reactions with formaldehyde alone as we have seen. The solution

the Mannich reaction

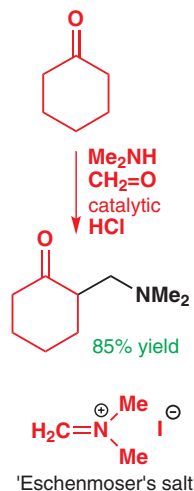

Interactive mechanism for the Mannich reaction

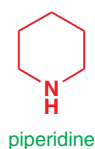
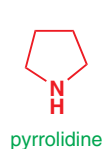

is to make the Mannich product, store that, and then to alkylate and eliminate only when the enone is needed. We have seen how useful this is in the Michael reaction in Chapter 25.

If the enone is wanted, any secondary amine will do as it does not end up in the molecule so the more convenient (less volatile and less smelly) cyclic amines, pyrrolidine, and piperidine, are often used. The very electrophilic enones with monosubstituted double bonds can be made in this way.

a Mannich reaction using pyrrolidine

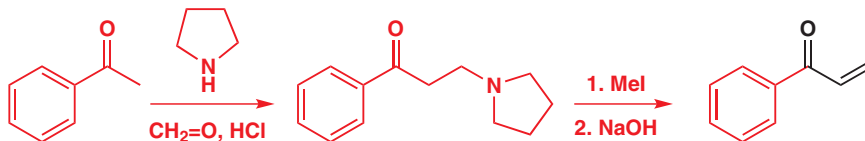

Carbonyl compounds that are electrophilic but cannot enolize

Good crossed aldol condensations require one component to enolize and act as a nucleophile and the other not to enolize and to act as the electrophile. Here follows a list of carbonyl substituents that prevent enolization and therefore force a carbonyl compound to take the role of the electrophilic partner. They are arranged roughly in order of reactivity with the most reactive towards nucleophilic attack by an enolate at the top. You do, of course, need two substituents to block enolization so typical compounds also appear in the list. Note that the last two entries—esters and amides—do not normally do aldol reactions with enolates, but they do react as acylating agents for enolates, as you will see later in this chapter.

Carbonyl substituents that block enolization

	Substituent	Typical compounds	Comments
most electrophilic	H		needs special methods: see Mannich reaction
	CF ₃ , CCl ₃		made by halogenation of enols (Chapter 20)
	<i>t</i> -alkyl		many other <i>t</i> -alkyl groups
	alkenyl		nucleophile may attack alkene: see Chapter 25
	aryl		many other aromatic rings, e.g. heterocycles
	OR		formate esters and carbonates
least electrophilic	NR ₂		this is DMF: other amides unreactive

Compounds that can enolize but that are not electrophilic

We can complement this type of selectivity with the opposite type. Are there any compounds that can enolize but that cannot function as electrophiles? No carbonyl compound can fill this role, but in Chapter 25 (p. 585) we met some 'enolizable' compounds that lacked carbonyl

groups altogether. Most notable among these were the nitroalkanes. Deprotonation of nitroalkanes is not enolization nor is the product an enolate ion, but the whole thing is so similar to enolization that it makes sense to consider them together. You saw these anions, sometimes called nitronates, reacting with Michael acceptors in Chapter 25, and they also react well with aldehydes and ketones.

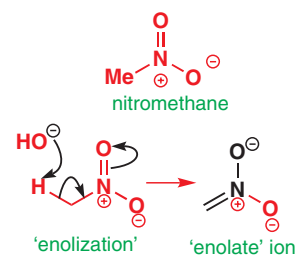
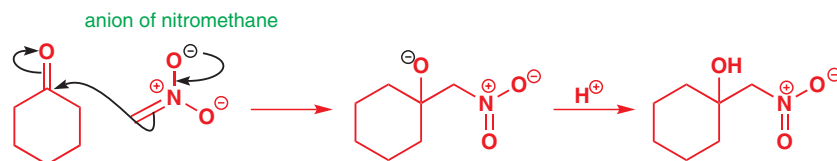

This particular example, using cyclohexanone as the electrophile and nitromethane itself as the source of the 'enolate', works quite well with NaOH as the base in methanol solution to give the 'aldol' in reasonable yield. Once again this reaction involves choice. Either compound could enolize and, indeed, cyclohexanone reacts well with itself under essentially the same conditions.

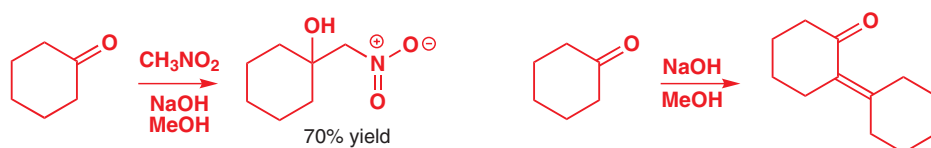

Although cyclohexanone forms an enolate in the absence of nitromethane, when both ketone and nitroalkane are present, the base prefers to remove a proton from nitromethane. This is simply a question of pK_a values. The pK_a of a typical ketone is about 20 but that of nitromethane is 10. It is not even necessary to use as strong a base as NaOH (pK_a of $H_2O = 15.7$) to deprotonate nitromethane: an amine will do (pK_a of $R_2NH_2^+$ about 10) and secondary amines are often used.

The elimination step also occurs easily with nitro compounds and is difficult to prevent in reactions with aromatic aldehydes. Now you can see how the useful nitroalkene Michael acceptors in Chapter 22 were made.

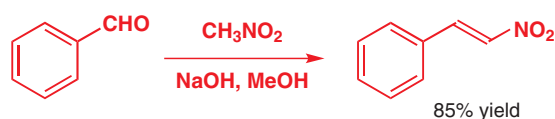

Nitroalkenes as termite defence compounds

Termites are social insects, and every species has its own 'soldier' termites that defend the nest. Soldier termites of the species *Protermiterme simplex* have huge heads from which they spray a toxic nitroalkene on their enemies.

defensive nitroalkene from termite soldiers



Although this compound kills other insects and even other species of termites, it has no effect on the workers of the same species. To find out why this was so, Prestwich made some radioactive compound using the aldol reaction. First, the right aldehyde was made using an S_N2 reaction with radioactive (^{14}C) cyanide ion on a tosylate followed by DIBAL reduction (Chapter 23) of the nitrile. The position of the ^{14}C atom in each compound is shown in black.

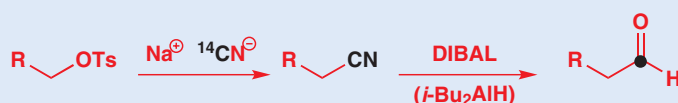

Then the aldol reaction was carried out with nitromethane and acetic anhydride in pyridine to give the nitro aldol. Elimination using sodium methoxide gave the defence compound (*E*-1-nitropentadec-1-ene) in 37% yield over the four steps.

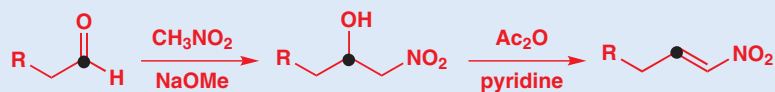

If the worker termites were sprayed with the labelled compound, they were able to make it harmless by using an enzyme to reduce the nitroalkene to a nitroalkane. The still radioactive labelled nitroalkane could be re-isolated only from workers of the same species: other insects do not have the enzyme.

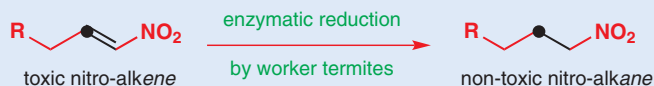

If an aldol reaction can be done with:

- only one enolizable component
- only one set of enolizable protons
- a carbonyl electrophile more reactive than the compound being enolized

then you are lucky and the crossed aldol method will work. But most aldol reactions aren't like this: they are cross-condensations of aldehydes and ketones of various reactivities with several different enolizable protons. Crossed aldols on most pairs of carbonyl compounds lead to hopeless mixtures of products. In all cases that fail to meet these three criteria, a specific enol equivalent will be required: one component must be turned quantitatively into an enol equivalent, which will be reacted in a separate step with an electrophile. That is what the next section is about—and you will find that some of the methods have a lot in common with those we used for alkylating enolates in Chapter 25.

■ You will see exceptions to this generalization when we discuss asymmetric synthesis in Chapter 41.

Specific enol equivalents can be used to control aldol reactions

In Chapter 25 we saw that the alkylation of enolates was most simply controlled by preparing a specific enol equivalent from the carbonyl compound. The same approach is the most powerful of all the ways to control the aldol reaction. The table is a reminder of some of the most useful of these specific enol equivalents.

Important specific enol equivalents

	enol	carbonyl compound	enolate ion
oxygen derivatives:			
	silyl enol ether		lithium enolate
nitrogen derivatives:			
	enamine		aza-enolate
1,3-dicarbonyls:			
	enol	1,3-dicarbonyl compound	enolate anion

Specific enol equivalents are intermediates that still have the reactivity of enols or enolates but are stable enough to be prepared in good yield from the carbonyl compound. That was all we needed to know in Chapter 25. Now we know that a further threat is the reaction of the partly formed enol derivative with its unenolized parent and we should add that ‘no aldol reaction should occur during the preparation of the specific enol equivalent’.

● Specific enol equivalents are intermediates that still have the reactivity of enols or enolates but are stable enough to be prepared in good yield from the carbonyl compound *without any aldol reaction*.

Sensible choice of an appropriate specific enol equivalent will allow almost any aldol reaction to be performed successfully. The first two compounds in our list, the silyl enol ethers and the lithium enolates, have a particularly wide application and we should look first at the way these work. As the table suggests, silyl enol ethers are more like enols: they are non-basic and not very reactive. Lithium enolates are more like enolate anions: they are basic and reactive. Each is appropriate in different circumstances.

Lithium enolates in aldol reactions

Lithium enolates are usually made at low temperature in THF with a hindered lithium amide base (often LDA) and are stable under those conditions because of the strong O–Li bond. The formation of the enolate begins with Li–O bond formation before the removal of the proton from the position by the basic nitrogen atom.

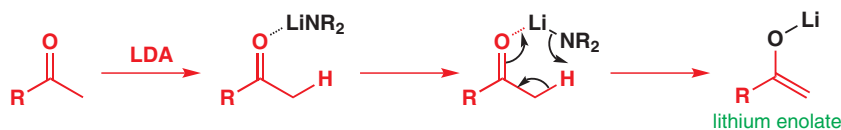

This reaction happens very quickly—so quickly that the partly formed enolate does not have a chance to react with unenolized carbonyl compound before proton removal is complete.



Now, if a second carbonyl compound is added, it too complexes with the same lithium atom. This allows the aldol reaction to take place by a cyclic mechanism in the coordination sphere of the lithium atom. The aldol step itself is now a very favourable intramolecular reaction with a six-membered cyclic transition state. The product is initially the lithium alkoxide of the aldol, which gives the aldol on work-up.

aldol reaction with a lithium enolate

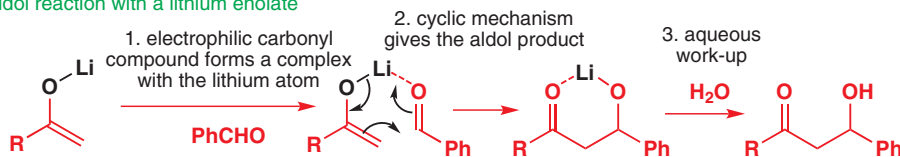

This reaction works well even if the electrophilic partner is an enolizable aldehyde. In this example, an unsymmetrical ketone (blocked on one side by an aromatic ring) reacts as the enol partner in excellent yield with a very enolizable aldehyde. This is the first complete aldol reaction we have shown you using a specific enol equivalent: notice the important point that it is done in two steps:

- first, form the specific enol equivalent (here, the lithium enolate at low temperature)
- then add the electrophile.

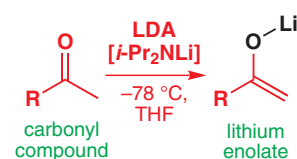

➔ The formation of lithium enolates was discussed in Chapter 25.

🖱 Interactive mechanism for lithium enolate formation

■ Aldehydes are an exception. You can make lithium enolates from some aldehydes such as *i*-PrCHO, but generally self-condensation is too fast, so unwanted aldol self-condensation products are produced during the formation of the lithium enolate. To make specific enolates of aldehydes we need to use another type of derivative: see later.

■ A lithium cation has four coordination sites—those we do not show are occupied by solvent molecules. Before the aldol reaction can take place, one of these molecules must be displaced by the electrophilic carbonyl partner.

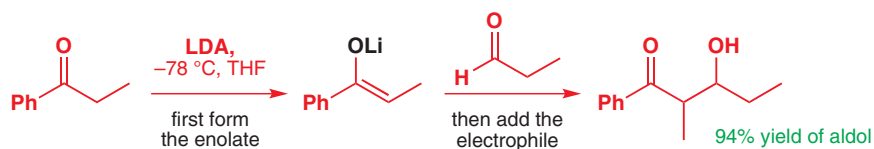

Contrast the crossed aldols earlier in the chapter, where enolizable component, base, and electrophile were all mixed together in one step.

The next example is particularly impressive. The enol partner is a symmetrical ketone that is very hindered—there is only one hydrogen on either side. The electrophilic partner is a conjugated enal that is not enolizable but that might accept the nucleophile in a conjugate manner. In spite of these potential problems, the reaction goes in excellent yield.

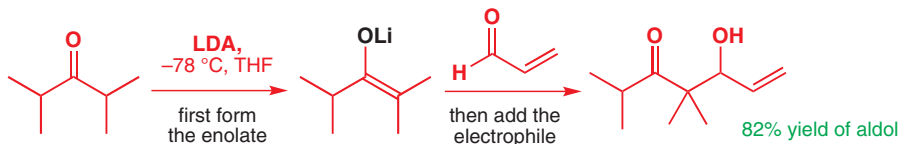

■ Because of the six-membered ring mechanism for the addition, lithium enolates don't usually do conjugate additions. For enol equivalents that do, see Chapter 25.

■ The symbol [O] denotes oxidation by one of the very general but ill-defined oxidizing agents from the laboratory of the famous Welsh chemist Owen Brackets. Here the Swern oxidation was the best (see Chapter 23).

You may wonder why we did not mention the stereochemistry of the first of these two products. Two new stereogenic centres are formed and the product is a mixture of diastereoisomers. In fact, both of these products were wanted for oxidation to the 1,3-diketone so the stereochemistry is irrelevant. This sequence shows that the aldol reaction can be used to make diketones too.

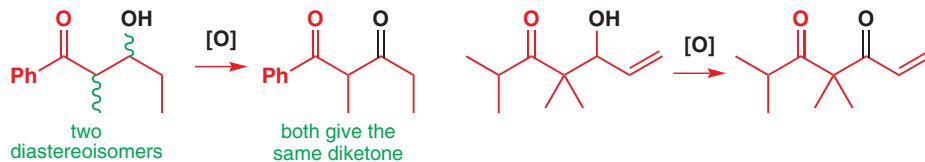

Silyl enol ethers in aldol reactions

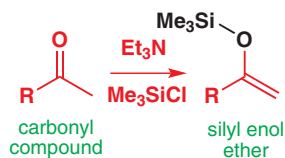

The silyl enol ether can be prepared from its parent carbonyl compound by forming a small equilibrium concentration of enolate ion with weak base such as a tertiary amine and trapping the enolate with the very efficient oxygen electrophile Me_3SiCl . The silyl enol ether is stable enough to be isolated but is usually used immediately without storing.

You should look upon silyl enol ethers as rather reactive alkenes that combine with things like protons or bromine (Chapter 20), but do not react with aldehydes and ketones without catalysis: they are much less reactive than lithium enolates. As with alkylation (pp. 595 and 609), a Lewis acid catalyst is needed to get the aldol reaction to work, and a Ti(IV) compound such as TiCl_4 is popular.

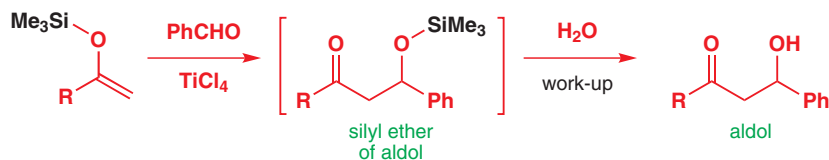

The immediate product is actually the silyl ether of the aldol product but this is hydrolysed during work-up and the aldol is formed in good yield. The Lewis acid presumably bonds to the carbonyl oxygen atom of the electrophile.

Now the aldol reaction can occur: the positive charge on the titanium-complexed carbonyl oxygen atom makes the aldehyde reactive enough to be attacked even by the not very nucleophilic silyl enol ether. Chloride ion removes the silyl group and the titanium alkoxide

captures it again. This last step should not surprise you as any alkoxide (MeOLi, for example) will react with Me₃SiCl to form a silyl ether.

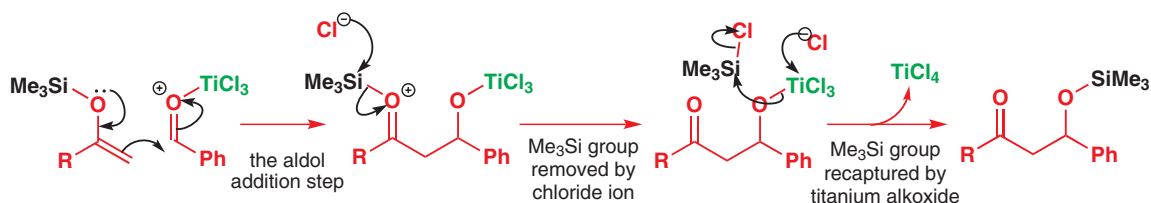

This mechanism looks complicated, and it is. It is, in fact, not clear that the details of what we have written here are right: the titanium may well coordinate to *both* oxygens throughout the reaction, and some of the steps that we have represented separately probably happen simultaneously. However, all reasonable mechanisms will agree on two important points, which you must understand:

- Lewis acid is needed to get silyl enol ethers to react.
- The key step is an aldol reaction of the silyl enol ether with the Lewis-acid complexed electrophile.

The use of silyl enol ethers can be illustrated in a synthesis of manicone, a conjugated enone that ants use to leave a trail to a food source. It can be made by an aldol reaction between pentan-3-one (as the enol component) and 2-methylbutanal (as the electrophile). Both partners are enolizable so we shall need to form a specific enol equivalent from the ketone. The silyl enol ether works well. The aldol product will be a mixture of diastereoisomers but it eliminates to give a single compound.

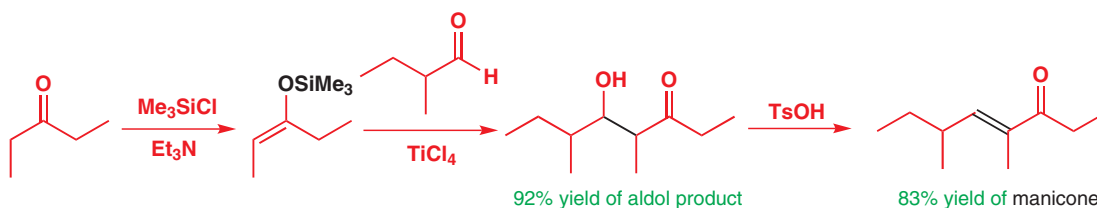

The silyl enol ether is not isolated but is treated immediately with the aldehyde to give an excellent yield of the aldol. Dehydration in acid solution with toluenesulfonic acid (TsOH) gives the enone. You can see by the high yield in the aldol reaction that there is no significant self-condensation of either partner in the aldol reaction.

Conjugated Wittig reagents as specific enol equivalents

When the Wittig reaction was introduced (Chapter 11) we saw it simply as an alkene synthesis. Now if we look at one group of Wittig reagents, those derived from α -halo-carbonyl compounds, we can see that they behave as specific enol equivalents in making unsaturated carbonyl compounds.

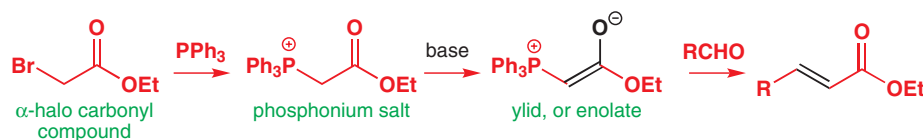

You notice that we have drawn the intermediate ylid as an enolate just to emphasize that it is an enolate derivative: it can also be represented either as the ylid or as an equivalent C=P 'phosphorane' structure. If we look at the details of this sort of Wittig reaction, we shall see that ylid formation is like enolate anion formation (indeed it *is* enolate anion formation). Only a weak base is needed as the enolate is stabilized by the Ph₃P⁺ group as well.

➔ We will return to ylids and the mechanism of the Wittig reaction in detail in Chapter 27.

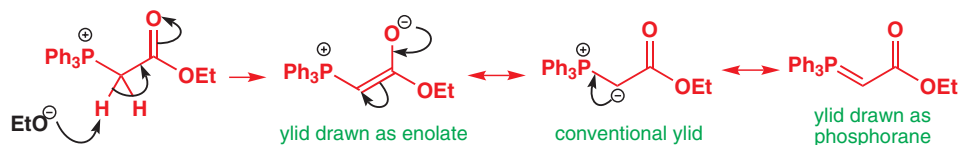

The first step of the Wittig reaction proper is just like an aldol reaction as it consists of an enolate attacking an electrophilic carbonyl compound. But, instead of forming an ‘aldol’ product, this adduct goes on to form an unsaturated carbonyl compound directly.

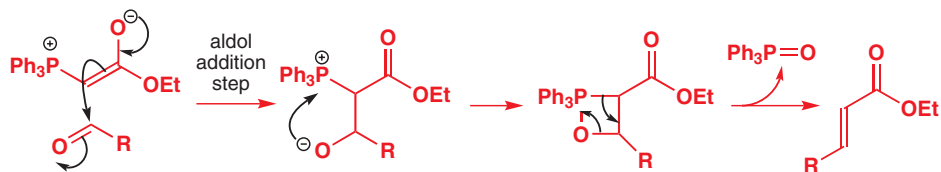

The final stages follow the mechanism of the Wittig reaction you met in Chapter 11: you can now see them as a special case of dehydration of an ‘aldol’ made favourable by the formation of a phosphine oxide and an unsaturated carbonyl compound.

The conjugated ylids derived from aldehydes, ketones, and esters are all sufficiently stable to be commercially available as the ylids—one of the few examples of specific enolate equivalents that you can actually buy. The ylid corresponding to the enolate of acetaldehyde is a solid, m.p. 185–188°C, that reacts well with other aldehydes, even if they are enolizable.

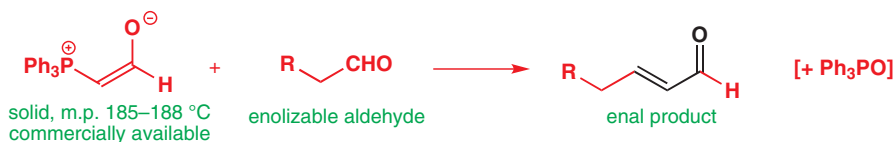

■ The alkene-forming reactions with $(RO)_2P=O$ in the place of R_3P^+ are known as Horner–Wadsworth–Emmons reactions. The Horner–Wadsworth–Emmons reaction can be used only to make conjugated alkenes.

■ The ‘brace’ device here is commonly used rather like ‘R’—it means that the rest of the molecule is unimportant to the reaction in question and could be anything.



The stability of the phosphonium-stabilized enolates also means that, although they react well with aldehydes, their reactions with ketones are often poor, and it is better in these cases to use phosphonate-stabilized enolates. Being anionic, rather than neutral, these enolates are more nucleophilic. If an ester enolate equivalent is being used, the best base is the alkoxide ion belonging to the ester; with a ketone enolate equivalent, use sodium hydride or an alkoxide.

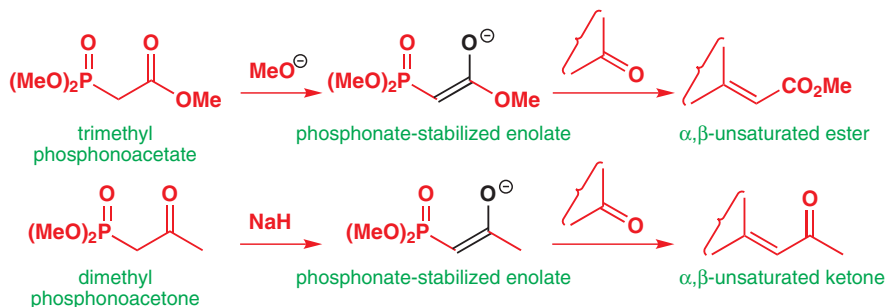

These last reagents, where the anion is stabilized both by the adjacent carbonyl group (as an enolate) and by the adjacent $P=O$ group, are just one of many examples of enolate anions stabilized by two electron-withdrawing groups. The most important members of this class, enolates of 1,3-dicarbonyl compounds, are the subject of the next section.

Specific enol equivalents from 1,3-dicarbonyl compounds

Although these are the oldest of the specific enol equivalents, they are still widely used because they need no special conditions—no low temperatures or strictly anhydrous solvents. The two most important are derived from malonic acid and ethyl acetoacetate.

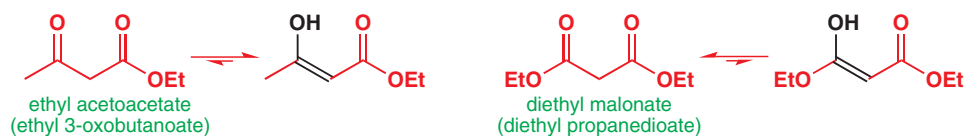

Ethyl acetoacetate is partly enolized under normal conditions. So, you might ask, why doesn't it immediately react with itself by the aldol reaction? There are two aspects to the answer. First, the enol is very stable (see Chapter 20 for a full discussion) and, second, the carbonyl groups in the unenolized fraction of the sample are poorly electrophilic ester and ketone groups. The second carbonyl group of the enol is not electrophilic because of conjugation. When a normal carbonyl compound is treated with catalytic acid or base, we have a small proportion of reactive enol or enolate in the presence of large amounts of unenolized electrophile. Aldol reaction (self-condensation) occurs. With 1,3-dicarbonyl compounds we have a small proportion of not particularly reactive unenolized compound in the presence of large amounts of stable (and hence unreactive) enol. No aldol occurs.

If we want a **crossed aldol reaction** with a 1,3-dicarbonyl compound, we simply add a second, electrophilic carbonyl compound such as an aldehyde, along with a weak acid or base. Often a mixture of a secondary amine and a carboxylic acid is used.

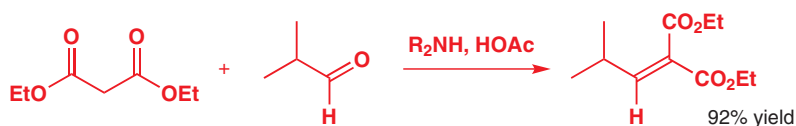

Reaction no doubt occurs via the enolate ion generated by the amine while the carboxylic acid buffers the solution, neutralizing the product and preventing enolization of the aldehyde. The amine (pK_a $R_2NH_2^+$ about 10) is a strong enough base to form a significant concentration of enolate from the 1,3-dicarbonyl compound (pK_a about 13) but not strong enough to form the enolate from the aldehyde (pK_a about 20). The formation of the enolate can be drawn from either tautomer of the malonate.

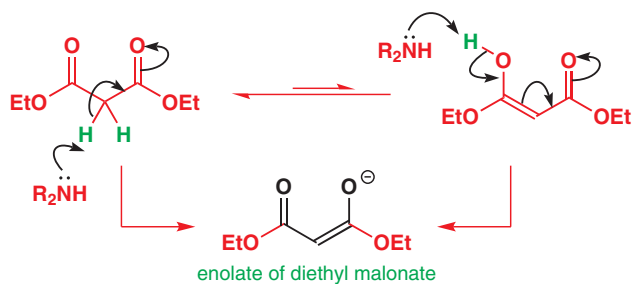

Now the enolate ion can attack the aldehyde in the usual way, and the buffer action of the acid produces the aldol product in the reaction mixture.

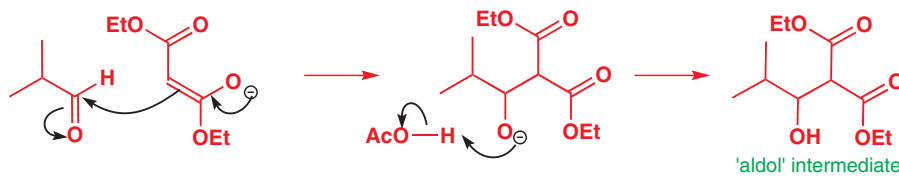

There is still one proton between the two carbonyl groups so enolate anion formation is again easy and dehydration follows to give the unsaturated product.

electrons are fed into this carbonyl group, making it less electrophilic

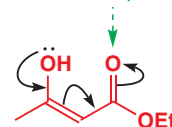

■ The aldol condensation of 1,3-dicarbonyl compounds under these conditions is sometimes called the **Knoevenagel reaction** after its nineteenth century inventor.

➔ Tautomers are isomers related to one another by *tautomerism*: see Chapter 20, p. 451.

🖱 Interactive mechanism for the Knoevenagel reaction

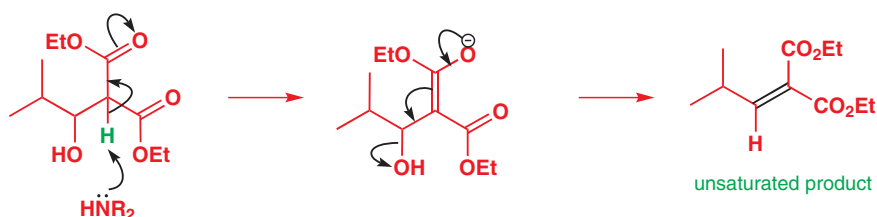

You may not want a product with both ester groups present, and we discussed in Chapter 25 how one of two 1,3-related ester groups may be removed by hydrolysis and decarboxylation. There is a simpler route with the aldol reaction. If, instead of the malonate diester, malonic acid is used, the decarboxylation occurs spontaneously during the reaction. The catalysts this time are usually a more basic mixture of piperidine and pyridine.

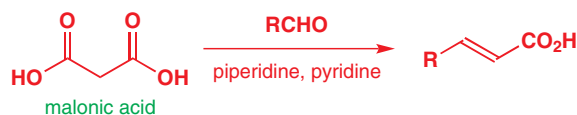
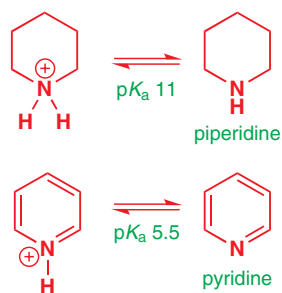

The reaction presumably uses the enolate anion of the monocarboxylate anion of malonic acid. Although this enolate is a dianion, its extensive delocalization and the intramolecular hydrogen bond make it really quite stable.

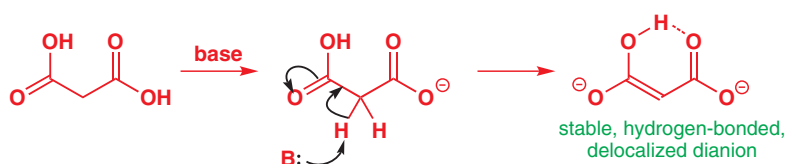

Next comes the aldol step. The dianion attacks the aldehyde, and after proton exchange the aldol is formed (still as the monocarboxylate in this basic solution).

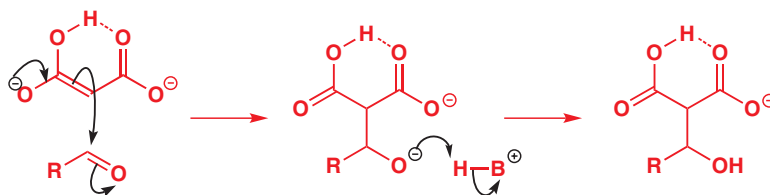

Finally comes the decarboxylation step, which can occur through a cyclic mechanism (compare the decarboxylation mechanisms in Chapter 25). The decarboxylation could give either an *E* or a *Z* double bond depending on which acid group is lost as CO_2 , but the transition state leading to the more stable *E* product must be lower in energy since the product has *E* geometry.

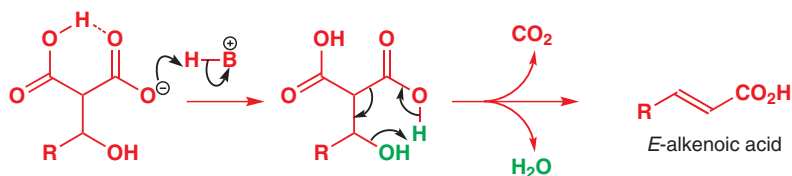

In the first part of this chapter we have looked at general solutions to the problem of controlling crossed aldol reactions. We'll now turn to the detailed ways those solutions are used with different classes of enolizable compounds.

How to control aldol reactions of esters

Among the enolates of carboxylic acid derivatives, esters are the most widely used. Ester enolates cannot be used as such in crossed aldols with aldehydes because the aldehyde is both more enolizable and more electrophilic than the ester. It will just condense with itself and ignore the ester. The same is true for ketones. A specific enol equivalent for the ester will therefore be needed for a successful aldol reaction of an ester enolate.

Fortunately, because this is a classic problem, many solutions are available. You can use the lithium enolate or the silyl enol ether, usually made best via the lithium enolate.

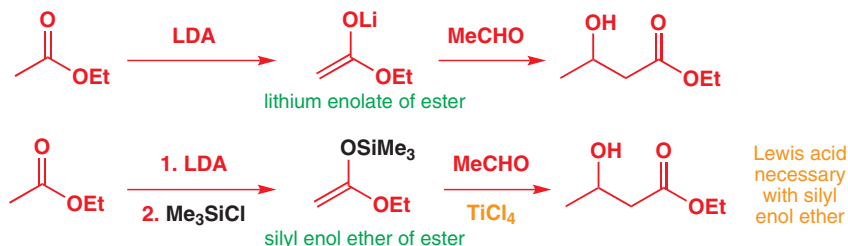

A good example is the first step in a synthesis of the natural product himalchene by Oppolzer and Snowden. Even though the ester and the aldehyde are both crowded with substituents, the aldol reaction works well with the lithium enolate of the ester. The cyclic mechanism ensures that the enolate adds directly to the carbonyl group of the aldehyde and not in a conjugate (Michael) fashion.

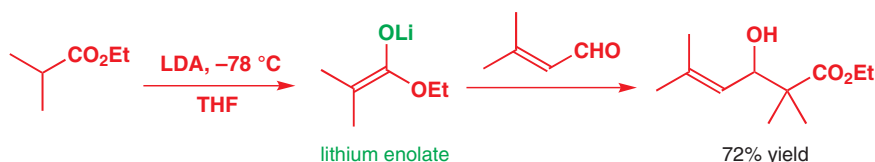

Zinc enolates, made from the bromoesters, are a good alternative to lithium enolates of esters. The mechanism for zinc enolate formation should remind you of the formation of a Grignard reagent.

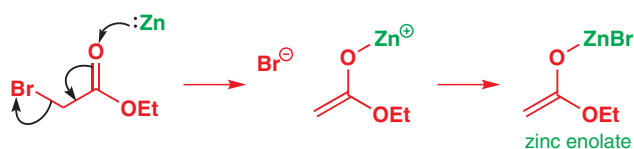

There is no danger of self-condensation with zinc enolates as they do not react with esters. But they do react cleanly with aldehydes and ketones to give aldols on work-up. You will appreciate that the use of zinc enolates is therefore special to esters: you cannot make a zinc enolate from a 2-bromoaldehyde or an α -bromoketone as then you *would* get self-condensation.

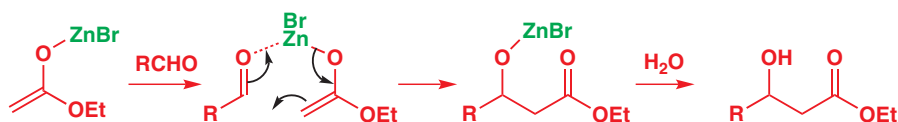

■ We have already discussed the special examples of malonate and phosphonoacetate esters above. Now we need to consider ester enolates more generally.

■ Forgive the reminder that a Lewis acid is necessary with silyl enol ethers.

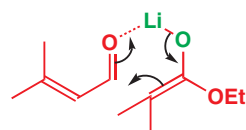

cyclic mechanism for ester aldol reaction

■ Aldol reactions of zinc enolates formed in this way are known as Reformatsky reactions.

■ The dehydration product from this aldol product is best made directly by one of the Wittig variants we discussed earlier (p. 628). The same bromoester is, of course, the starting material for the ylid synthesis.

• Ester enolate equivalents

For aldol reactions with an ester enolate equivalent, use:

- lithium enolates *or*
- silyl enol ethers *or*
- zinc enolates.

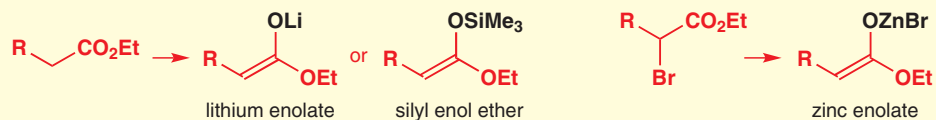

How to control aldol reactions of aldehydes

Aldehydes enolize very readily but also self-condense rather easily. Lithium enolates of aldehydes can't be made cleanly because the self-condensation reaction happens even at -78°C and is as fast as the enolization by LDA. Silyl enol ethers are a much better choice. They clearly must not be made via the lithium enolate, and amine bases are usually used. As each molecule of enolate is produced in the equilibrium, it is efficiently trapped by the silylating agent.

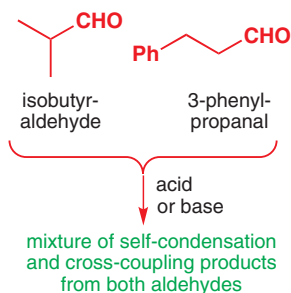
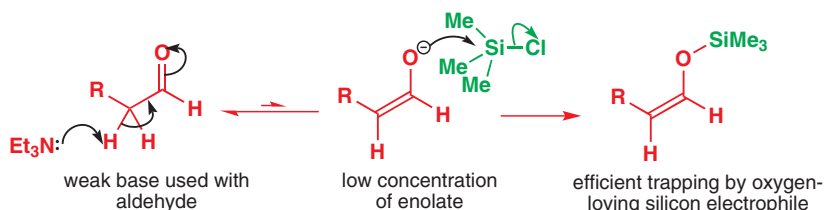

These silyl enol ethers are probably the best way of carrying out crossed aldol reactions with an aldehyde as the nucleophilic (enol or enolate) partner. An example is the reaction of the not very enolizable isobutyraldehyde with the very enolizable 3-phenylpropanal. Mixing the two aldehydes and adding base would of course lead to an orgy of self-condensation and cross-couplings.

Preliminary formation of the silyl enol ether from either aldehyde, *in the absence of the other*, would be trouble-free as Me_3SiCl captures the enolate faster than self-condensation occurs. Here we need the silyl enol ether from isobutyraldehyde. The other aldehyde is now added along with the necessary Lewis acid, here TiCl_4 . The mechanism described on p. 627 gives the aldol after work-up in an excellent 95% yield. No more than 5% of other reactions can have occurred.

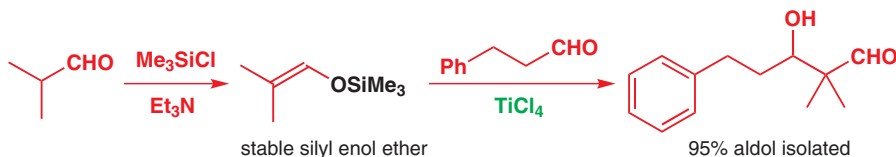

Other useful specific enol equivalents of aldehydes and ketones are enamines and aza-enolates, which you saw in use in alkylation reactions in Chapter 25. Aza-enolates—the lithium enolates of imines—derived from aldehydes are also useful in aldol reactions. Cyclohexylamine gives a reasonably stable imine even with acetaldehyde and this can be isolated and lithiated with LDA to give the aza-enolate. The mechanism is similar to the formation of lithium enolates and the lithium atom binds the nitrogen atom of the aza-enolate, just as it binds the oxygen atom of an enolate.

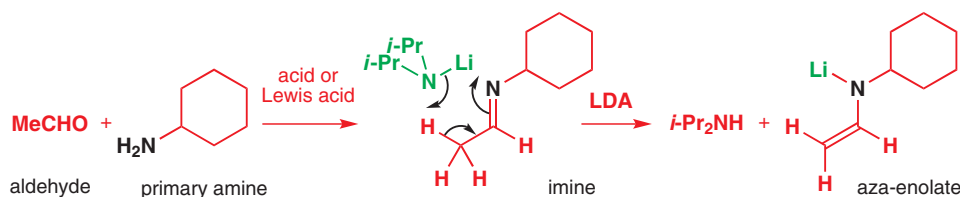

The aza-enolate reacts cleanly with other aldehydes or ketones to give aldol products. Even the most challenging of cross-couplings—attack on another similar enolizable aldehyde—occurs in good yield.

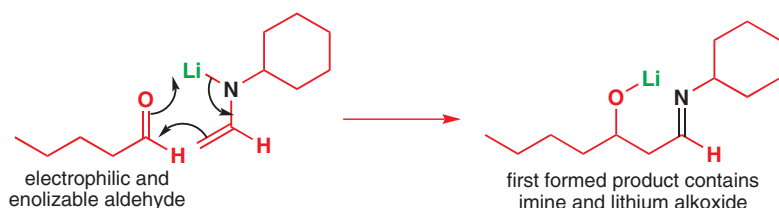

The initial product is a new imine, which is easily hydrolysed during acidic aqueous work-up. The alkoxide is protonated, the imine hydrolysed, and finally the aldol is dehydrated to give the enal—65% overall yield in this case.

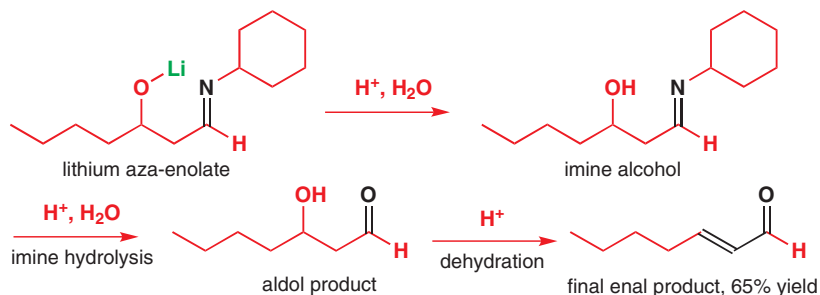

The key to the success of the aza-enolates is that the imine is first formed from the aldehyde with the primary amine, a relatively weak base, and under these conditions imine formation is faster than self-condensation. Only after the imine is formed is LDA added when self-condensation cannot occur simply because no aldehyde is left.

Except in certain cases (and you will meet some of these in Chapter 41) enamines are not generally used in aldol condensations, partly because they are not reactive enough, but mainly because they are too much in equilibrium with the carbonyl compound itself and exchange would lead to self-condensation and the wrong cross-couplings. You will see later that enamines come into their own when we want to acylate enols with the much more reactive acid chlorides.

● Aldehyde enolate equivalents

For crossed aldol reactions with an aldehyde as the enol partner, use:

- silyl enol ethers or
- aza-enolates.

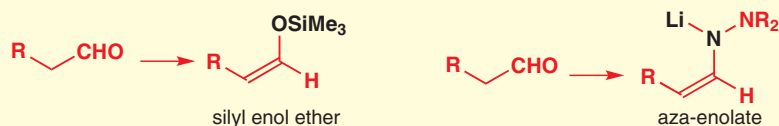

For acylation of aldehyde enolates (see later), use silyl enol ethers or enamines.

■ Imines are susceptible to hydrolysis and they are best not stored but used at once. To understand these reactions fully you should ensure you are familiar with the mechanisms of imine formation and hydrolysis from Chapter 11.

How to control aldol reactions of ketones

The enolization of ketones, unless they are symmetrical, poses a special problem. Not only do we need to prevent them self-condensing (although this is less of a problem than with aldehydes), but we also need to control which side of the carbonyl group the ketone enolizes. In this section we shall introduce aldol reactions with unsymmetrical ketones where one of two possible enols or enolates must be made.

Making the less substituted enolate equivalent: kinetic enolates

Treatment of methyl ketones with LDA usually gives only the lithium enolate on the methyl side. This is the enolate that forms the fastest and is therefore known as the kinetic enolate. It is formed faster *because*:

- the protons on the methyl group are more acidic
- there are three of them as against two on the other side, and
- there is steric hindrance to attack by LDA on the other side of the carbonyl group.

► Kinetic and thermodynamic enolates were introduced in Chapter 25, p. 601.

Gilbert Stork was born in Brussels and became an assistant professor of chemistry at Harvard in 1948. From 1953, Stork was at Columbia University in New York. He pioneered new synthetic methods, among them many involving enolates and enamines.

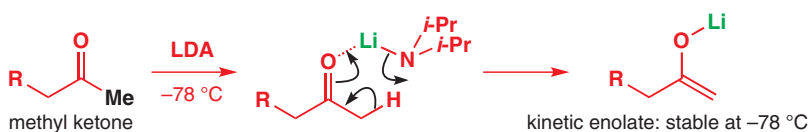

A simple example from the first report of this reaction by Gilbert Stork and his group in 1974 is the condensation of pentan-2-one with butanal to give the aldol and then the enone oct-4-en-3-one by acid-catalysed dehydration. The yields may seem disappointing, but this was the first time anyone had carried out a crossed aldol reaction like this with an unsymmetrical ketone and an enolizable aldehyde and got just one aldol product in any reasonable yield at all.

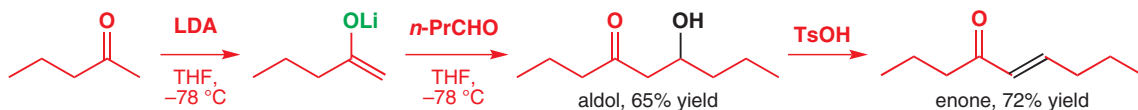

An uncontrolled ketone aldol

A more typical result from the days before specific enol condensation between butanone and butanal with equivalents had been invented is this attempted crossed catalytic base. Two products were isolated in low yield.

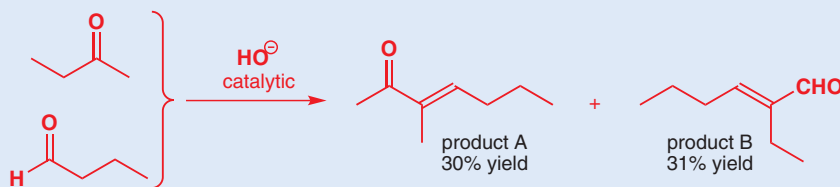

Product A is from the enolate of the more substituted side of the ketone reacting with the aldehyde, and product B is just the self-condensation product from the aldehyde.

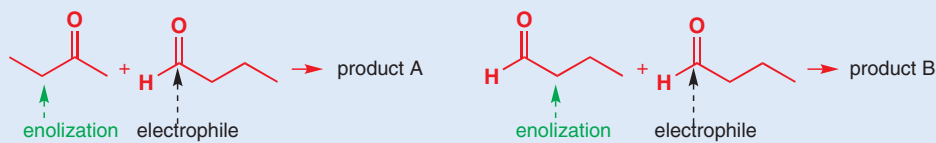

These kinetic lithium enolates are stable in THF at -78°C for a short time but can be preserved at room temperature in the form of their silyl ethers.



Aldol reactions can be carried out with either the lithium enolate or the silyl enol ether. As an example we shall use the synthesis of a component of the flavour of ginger. The hotness of ginger comes from ‘gingerol’—the ‘pungent principle’ of ginger. Gingerol is a 3-hydroxyketone, so we might consider using an aldol reaction to make it. We shall need the enol (or enolate) on the methyl side of an unsymmetrical ketone to react with a simple aldehyde (pentanal) as the electrophilic partner in the aldol reaction. Pentanal is an enolizable aldehyde, so we must stop it enolizing. The diagram summarizes the proposed aldol reaction.

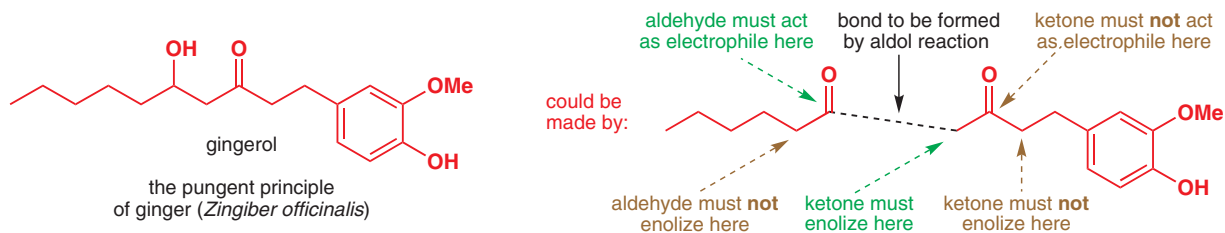

We might consider using the lithium enolate or the silyl enol ether. As we need the kinetic enolate (the enolate formed on the less substituted side of the ketone), we shall be using the lithium enolate to make the silyl enol ether, so it would make sense to try that first. There is another problem too. The ketone has a free OH group on the far side of the ring that will interfere with the reaction. We must protect that first as an ordinary silyl ether (not a silyl *enol* ether).

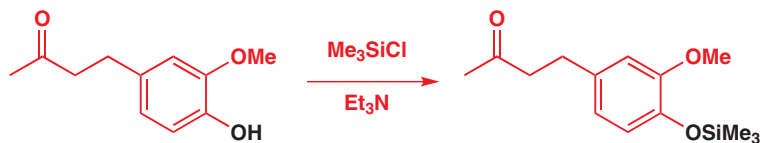

Now we can make the kinetic lithium enolate with a hindered lithium amide base. In fact, the one chosen here was even more hindered than LDA as it has two Me_3Si groups on the nitrogen atom.

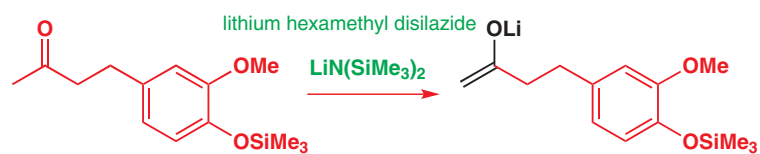

Lithium hexamethyldisilazide

Lithium hexamethyldisilazide (LiHMDS) is a little more hindered than LDA and a little less basic. It is made by deprotonating hexamethyldisilazane with BuLi.

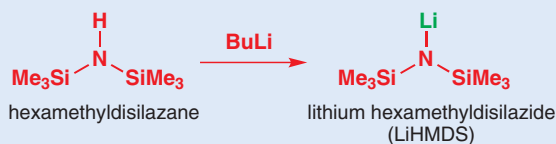

An aldol reaction with this lithium enolate on pentanal was successful and the protecting group (the silyl ether) was conveniently hydrolysed during work-up to give gingerol itself. However, the yield was only 57%. When the silyl enol ether was used with TiCl_4 as the Lewis

Teruaki Mukaiyama, of the Science University of Tokyo (and formerly of the Tokyo Institute of Technology and the University of Tokyo), was one of the foremost Japanese chemists of his generation, whose work has had a significant impact on the development of the aldol reaction and on other areas of organic synthesis.

acid catalyst, the yield jumped to 92%. This is one of the many successful uses of this style of aldol reaction by Mukaiyama, the inventor of the method.

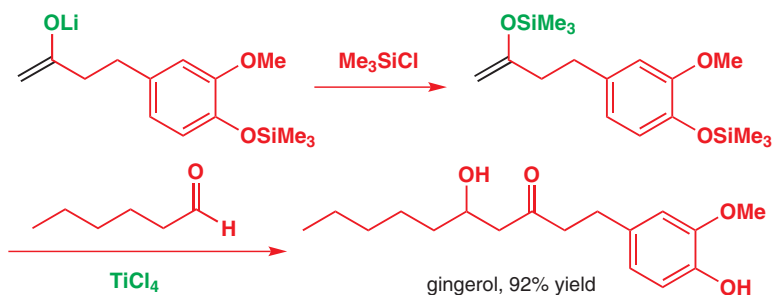

Making the more substituted enolate equivalent: thermodynamic enolates

Being an alkene, an enol or enolate is more stable if it has more substituents. So the way to make the more substituted enolate equivalent is to make it under conditions where the two enolates can interconvert: equilibration will give the more stable form. You have seen in Chapter 25 (p. 599) how the silyl enol ether on the more substituted side of a ketone can be made by treating the ketone with Me₃SiCl and a weak base, but these thermodynamic silyl enol ethers have been little used in aldol reactions. One successful example is the thermodynamic silyl enol ether of 1-phenylpropan-2-one: enolization on the conjugated side is overwhelmingly favoured thermodynamically. The aldol reaction with a 2-ketoaldehyde goes exclusively for the more reactive aldehyde group.

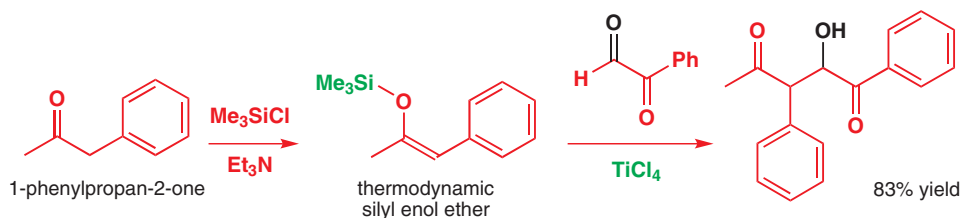

This concludes our general survey of specific enolates in the aldol reaction. Later you will see many of the same reagents used in acylation at carbon. We are left with some reactions that are particularly easy to do.

Intramolecular aldol reactions

Now for something easy. When an aldol reaction can form a five- or six-membered ring, you need no longer worry about specific enols or anything like that. Equilibrium methods with weak acids or bases are quite enough to give the cyclic product by an intramolecular aldol reaction because intramolecular reactions are faster than intermolecular ones. We shall illustrate intramolecular reactions by looking at the cyclization of a series of diketones of increasing complexity, starting with one that can form four equivalent enols: cyclodeca-1,6-dione.

It doesn't matter where enolization occurs because the same enol is formed. And once the enol is formed, there is only one thing it can reasonably do: attack the other ketone to form a stable five-membered ring. It also gives a reasonably stable seven-membered ring, but that is by the way. In weak acid or base, only a small proportion of carbonyl groups will be enolized, so the chance of two being in the same molecule is very low. No intermolecular condensation is found and the yield of the bicyclic enone from the intramolecular reaction is almost 100% (96% with Na₂CO₃).

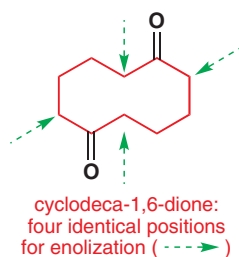

➔ Ring size and stability were discussed in Chapter 16.

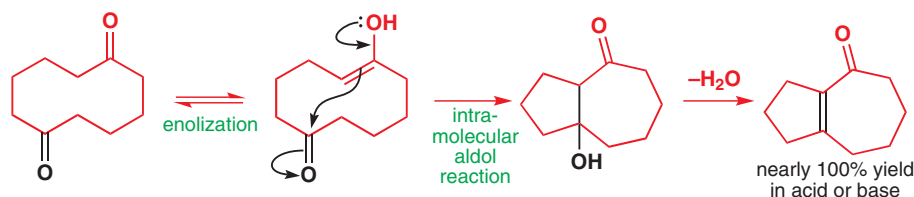

This may look like a long stretch for the enol to reach across the ten-membered ring to reach the other ketone, but the conformational drawing in the margin shows just how close they can be. You should compare this conformation with that of a decalin (Chapter 16).

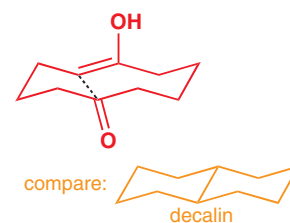

The key point to remember with intramolecular aldols is this:

- Intramolecular reactions giving five- or six-membered rings are preferred to those giving strained three- or four-membered rings on the one hand or medium rings (eight- to thirteen-membered) on the other.

➔ We come back to the importance of ring size in Chapter 31.

Acid-catalysed cyclization of the symmetrical diketone nona-2,8-dione could give two enols.

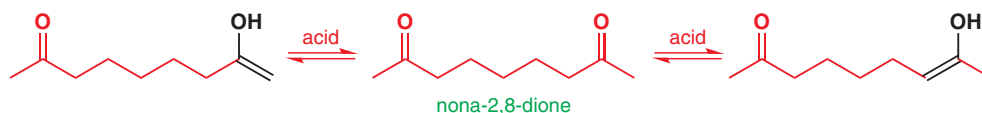

One enol can cyclize through an eight-membered cyclic transition state and the other through a six-membered one. In each case the product would first be formed as an aldol but would dehydrate to the cyclic enone having the same ring size as the transition state. In practice, only the less strained six-membered ring is formed and the enone can be isolated in 85% yield.

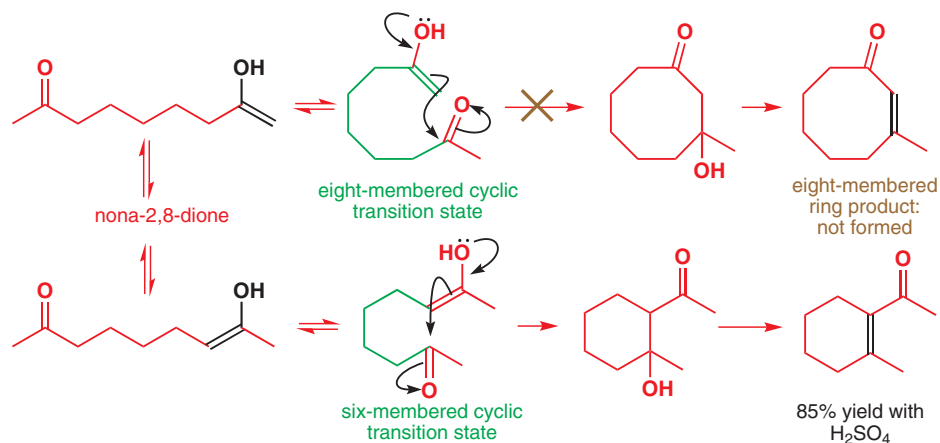

Interactive mechanism for intramolecular aldol reactions

Most diketones lack symmetry, and will potentially have four different sites for enolization. Consider what might happen when this diketone is treated with KOH. There are four different places where an enolate anion might be formed as there are four different carbon atoms. There are also two different electrophilic carbonyl groups so that there are many possibilities for inter- and intramolecular condensation. Yet only one product is formed, in 90% yield.

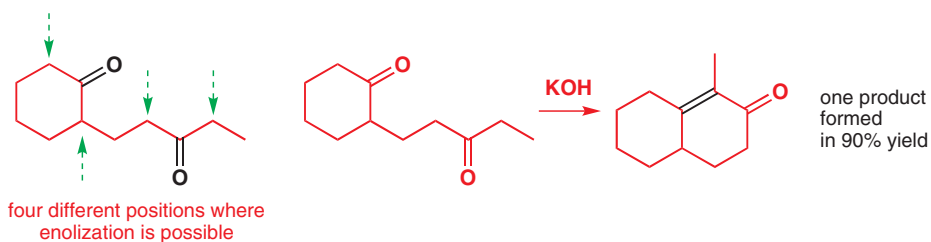

We can deduce the mechanism of the reaction simply from the structure of the product by working backwards. The double bond is formed from an aldol whose structure we can predict and hence we can see which enolate anion was formed and which ketone acted as the electrophilic partner.

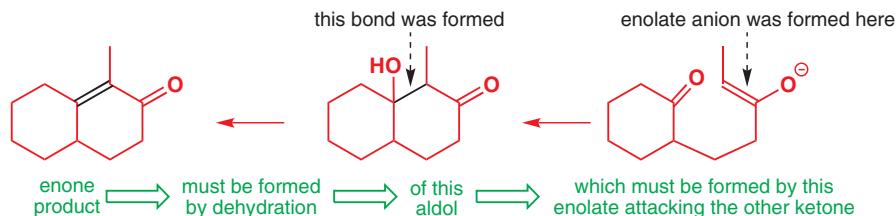

Must we argue that this one enolate is more easily formed than the other three? No, of course not. There is little difference between all four enolates and almost no difference between the three enolates from CH_2 groups. We *can* argue that this is the only aldol reaction that leads to a stable conjugated enone in a stable six-membered ring. This must be the mechanism; the others are just too slow to compete. Protonation and dehydration follow as usual.

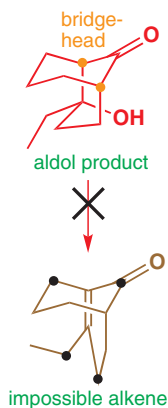
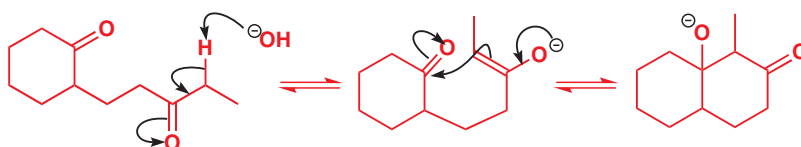

Now try some of the alternatives in which the same ketone forms an enolate on the other side. These reactions give unstable four-membered rings or bridged bicyclic systems that would revert to the enolate. Providing the reaction is done under equilibrating conditions, the whole process would go into reverse back to the original diketone and the observed (six-membered ring) cyclization would eventually predominate. The key point about the bridged compound in the margin is that dehydration is impossible. No enolate can form at the bridgehead because bridgehead carbons cannot be planar (Chapter 17, p. 389) and the enone product cannot exist for the same reason: the carbons marked (•) in the brown structure would all have to lie in the same plane. The aldol has a perfectly acceptable conformation but that elimination is impossible. The aldol product remains in equilibrium with the alternative aldol products, but only one elimination is possible—and that is irreversible, so eventually all the material ends up as the one enone.

The Robinson annelation

One of the most important applications of the intramolecular aldol reaction is a ring synthesis (annulation or annulation) that takes place in two steps, both involving enols. The compound made by Robinson in the first example is a bicyclic diketone that contains the basic structure of rings A and B of the steroids. The bonds made in the two steps are marked.

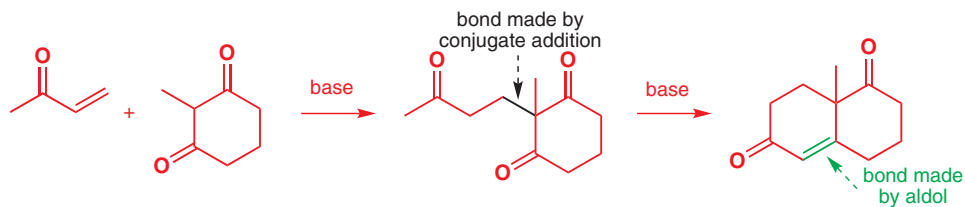

Robert Robinson (1886–1975) was a British chemist who won the Nobel Prize in 1947 for his work on the synthesis of alkaloids.

Only a weak base is needed to form the stable enolate of the 1,3-diketone and this does conjugate addition onto the enone (Chapter 25). The intermediate triketone may be isolated but often isn't.

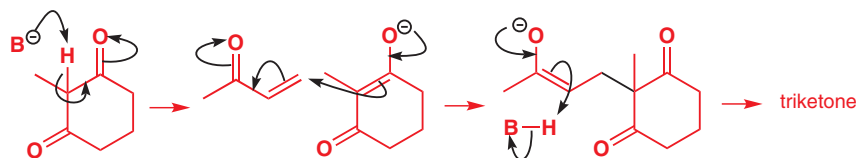

The second stage starts with the intramolecular aldol reaction. You should be able to see that the alternatives to a six-membered ring are a four-membered ring and bridged products. The hydroxy-ketone, which happens to have the *cis* stereochemistry, can also be isolated but eliminates by the E1cB mechanism to complete the aldol sequence.

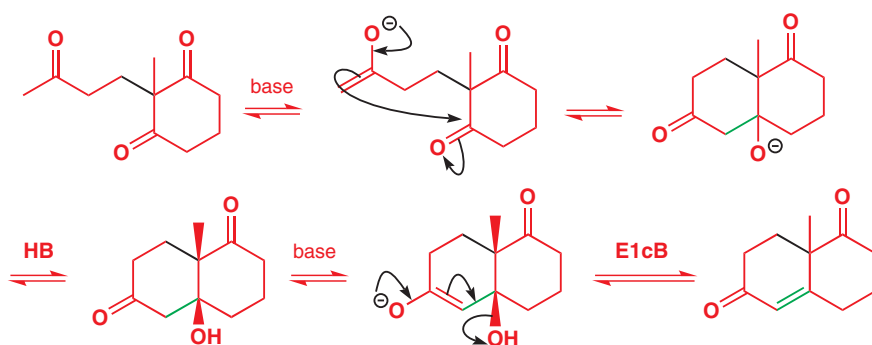

Other ways to carry out this same reaction are to use a secondary amine as the weak base. This gives an excellent yield of the hydroxyketone that can be converted into the enone with acid.

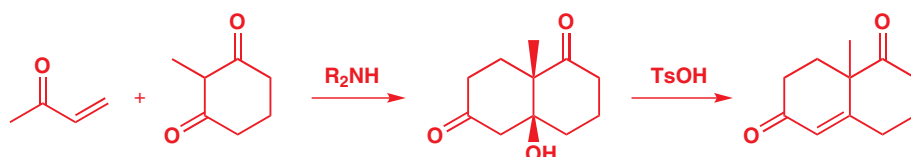

In this sequence the new ring is built onto the side of an old ring but this is not necessary. Any combination of an easily enolizable compound and an enone may give a Robinson annelation product. A simple example combines a non-enolizable enone with ethyl acetoacetate to give an excellent yield of a cyclohexenone. As these compounds are so robust a stronger base can be used.



The Darzens reaction

Tandem reactions, in which a second enolate reaction follows on from the first, can allow us to make cyclopropanes (see Chapter 25, p. 586), by conjugate addition followed by C-alkylation, or epoxides, by aldol addition followed by O-alkylation. This epoxide was used in the synthesis of the drug Darusentan.

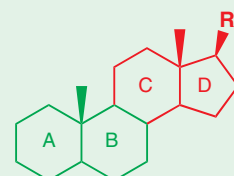

the steroid skeleton

There is more on steroids in Chapter 42.

Interactive mechanism for Robinson annelation

You will discover in Chapter 41 that using the natural amino acid proline as the amine favours a single enantiomer of this product.

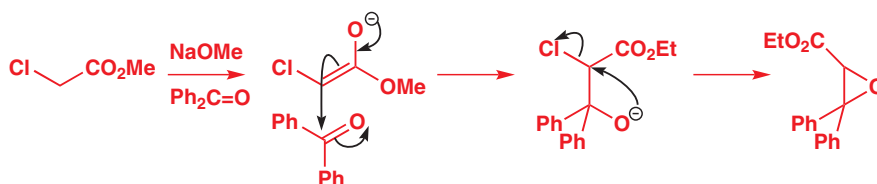

The formation of epoxides in this way complements their formation from alkenes with *m*-CPBA because it involves construction of a C–C bond. Epoxide formation from α -halogenated carbonyl compounds is known as the **Darzens reaction**.

Acylation at carbon

Introduction: the Claisen ester condensation and the aldol reaction compared

We began this chapter with the treatment of acetaldehyde with base. This led initially to the formation of an enolate anion and then to the aldol reaction. We are going to start this section by looking at what happens if you just treat ethyl acetate with base. To start with, there is hardly any difference. We shall use ethoxide as base rather than hydroxide as hydroxide would hydrolyse the ester, but otherwise the first steps are very similar. Here they are, side by side.



The next step in both cases is nucleophilic attack by the enolate ion on unenolized carbonyl compound. The concentration of enolate is low and each enolate ion is surrounded by unenolized aldehyde or ester molecules, so this reaction is to be expected. Here is that step, again shown for both aldehyde and ester.

the aldol step with acetaldehyde

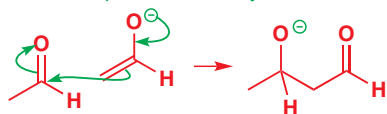

the 'aldol' step with ethyl acetate

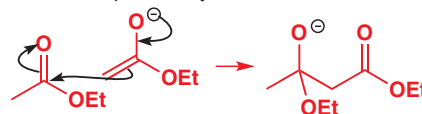

Only now does something different happen. The aldehyde dimer simply captures a proton from the solvent to give an aldol product. The 'aldol' from the ester (not, in fact, an aldol at all) has a leaving group, EtO^- , instead of a hydrogen atom and is actually the tetrahedral intermediate in a nucleophilic substitution at the carbonyl group. Compare the two different steps again.

completion of the aldol with acetaldehyde

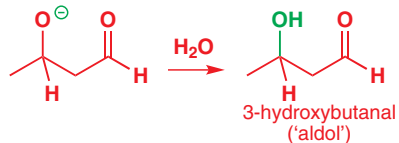

the Claisen condensation with ethyl acetate

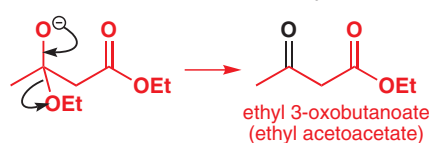

Even though the last step is different, the two products are quite similar. Both are dimers of the original two-carbon chain and both have carbonyl groups at the end of the chain and oxygen substituents at position three. The two reactions obviously belong to the same family but are usually given different names. The ester reaction is sometimes known as the **Claisen ester condensation** and sometimes as the **Claisen–Schmidt reaction**. More important than remembering the name is being familiar with the reaction and its mechanism.

This is another of those reactions where the base is not strong enough to transform the ester entirely into the enolate. Only a small equilibrium concentration is produced, which reacts with the ester electrophile. The by-product from the reaction is ethoxide ion and so it looks at first sight as though we get our catalyst back again—the aldol, if you remember, is catalytic in base. But not the Claisen reaction. The second step of the reaction is also really an equilibrium, and the reaction works only because the product can be irreversibly deprotonated by the ethoxide by-product, consuming ethoxide in the process. You recall that the aldol reaction often works best when there is an extra driving force to push it across—dehydration to an enone, for example. Similarly, the ester dimerization works best when the product reacts with the ethoxide ion to give a stable enolate ion.

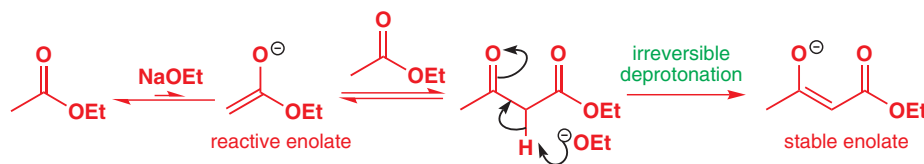

Interactive mechanism for Claisen ester condensation

The point is that the base used, ethoxide ion EtO^- , is too weak (EtOH has a pK_a of about 16) to remove the proton completely from ethyl acetate (pK_a about 25), but is strong enough to remove a proton from the acetoacetate product (pK_a about 10). Under the conditions of the reaction, a small amount of the enolate of ethyl acetate is produced—just enough to let the reaction happen—but the product is completely converted into its enolate. The neutral product, ethyl acetoacetate itself, is formed on acidic work-up.

the complete Claisen ester condensation

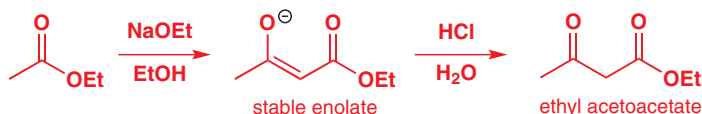

The final product has been formed by the acylation at carbon of the enolate of an ester. This general process—acylation at carbon—is the subject of the second part of this chapter. It so happened in this case that the acylating agent was another molecule of the same ester, but the general process we shall consider is the acylation of enolates at carbon. We shall use a variety of enols, enolates, and specific enol equivalents and a variety of acylating agents, but the basic idea is that the enolate of one carbonyl compound will have an acyl group (here the R^2CO group in orange) added to the enolate carbon atom.

enolate acylation at C

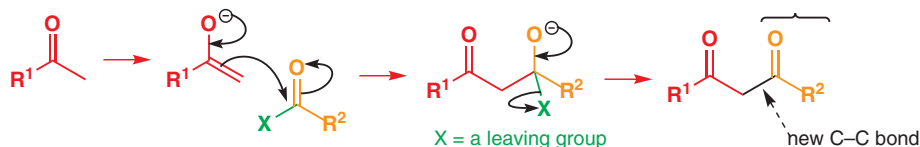

Problems with acylation at carbon

The main problem with the acylation of enolates is that reaction tends to occur at oxygen rather than at carbon.

enolate acylation at O

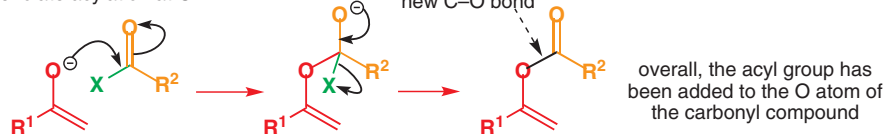

■ You have seen reaction at oxygen before. Enolates react on oxygen with silicon electrophiles and we found the products, silyl enol ethers, useful in further reactions. Enol esters also have their uses—as precursors of lithium enolates, for example. You saw one being used like this on p. 454.

The product of acylation on oxygen is an **enol ester**. The tendency to attack through oxygen is most marked with reactive enolates and reactive acylating agents. The combination of a lithium enolate and an acid chloride, for example, is pretty certain to give an enol ester.

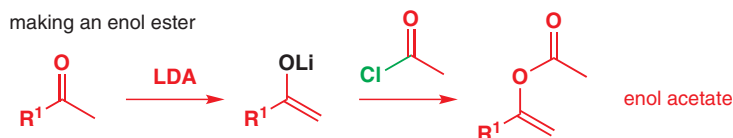

If we want acylation at carbon we must use *either*:

- less reactive specific enol equivalents, such as enamines or silyl enol ethers, with reactive acylating agents such as acid chlorides *or*
- reactive enols, such as the enolate anions themselves, with less reactive acylating agents such as esters.

We introduced this chapter with an example of the second type of reaction, and we shall continue with a more detailed consideration of the Claisen ester condensation and related reactions.

Reaction at oxygen—not a problem in the aldol reaction

Earlier in this chapter, we mentioned no trouble with reaction at oxygen in the aldol reaction. This may now seem surprising, in view of what we have said about esters, as the electrophiles were aldehydes and ketones—not so very different from esters. We can resolve this by looking at what would happen if an aldehyde did attack an enolate on the oxygen atom.

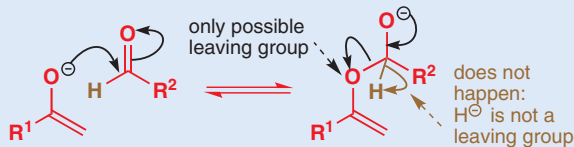

The only plausible leaving group from the intermediate is the enolate oxygen: the reaction just reverses.

The Claisen ester condensation and other self-condensations

■ We have already considered reactions of ethyl acetoacetate: now you see how it is made.

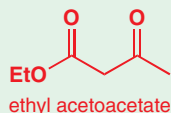

The self-condensation of ethyl acetate is the most famous example of the Claisen ester condensation and it works in good yield under convenient conditions. The product (ethyl acetoacetate) is commercially available for this very reason—and cheap too—so you are unlikely to want to do this particular example.

A more generally useful reaction is the self-condensation of simple substituted acetates $\text{RCH}_2\text{CO}_2\text{Et}$. These work well under the same conditions (EtO^- in EtOH). The enolate anion is formed first in low concentration and in equilibrium with the ester. It then carries out a nucleophilic attack on the more abundant unenolized ester molecules.

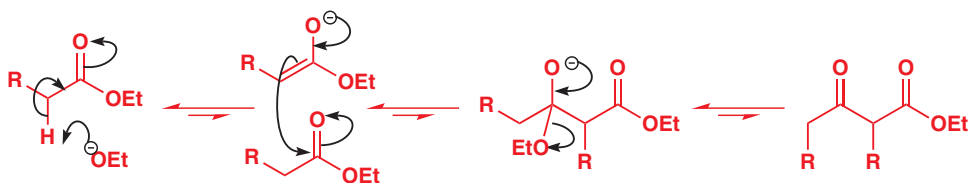

These steps are all unfavourable equilibria and, on their own, would give very little product. However, as we mentioned before, the reaction works because the equilibrium is driven over by the essentially irreversible formation of a stable, delocalized enolate from the product.

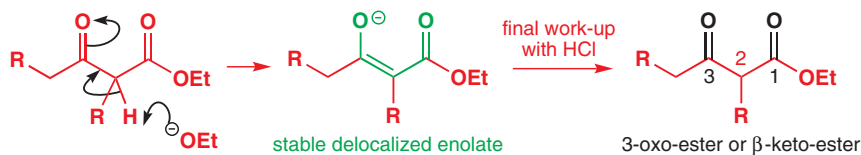

Finally, the reaction is worked up in acid and the β keto-ester product is formed. Notice that all products of Claisen ester condensations have a 1,3-dicarbonyl relationship. These compounds are useful in the preparation of specific enol equivalents and you have seen them in action in Chapters 20 and 25, and in this chapter.

► We shall discuss the significance of the 1,3-relationship in Chapter 28.

How do we know that deprotonation drives the reaction?

If the original ester has two substituents on the α carbon atom (C2 of the ester), the formation of the stable enolate of the product is no longer possible as there are no hydrogen atoms left to remove.

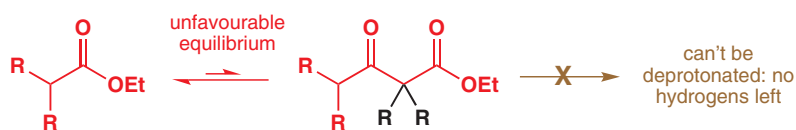

As you might expect, all the equilibria are now unfavourable, and this reaction does not go well under the normal equilibrating conditions (EtO^- in EtOH). It can be made to go in reasonable yield if a stronger base is used. Traditionally, triphenylmethyl sodium is chosen. This is made from Ph_3CCl and sodium metal, and is a very conjugated carbanion.

Triphenylmethyl carbanion is a strong enough base to convert an ester entirely into its enolate. Reaction of the enolate with a second molecule of ester then gives the keto-ester in good yield.

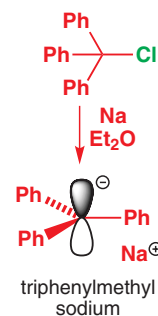
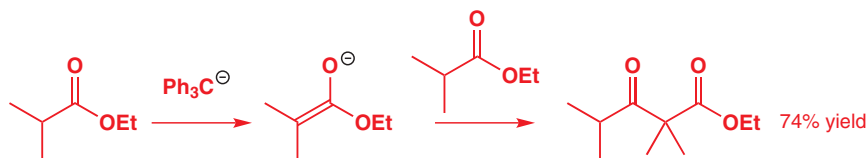

Crossed ester condensations

Much the same arguments apply here as applied in the crossed aldol reaction. We must be quite sure that we know which compound is going to act as the enol partner and which as the acylation partner.

Reactive esters that cannot enolize

There are several useful esters of this kind, of which the four in the margin are the most important. They cannot act as the enol partner, and the first three are more electrophilic than most esters, so they should acylate an ester enolate faster than the ester being enolized can.

These four are arranged in order of reactivity towards nucleophiles, the most electrophilic at the top and the least electrophilic at the bottom. Oxalates are very reactive because each carbonyl group makes the other more electrophilic. The molecular LUMO is the *sum* of the two π^* orbitals and is lower in energy than either.

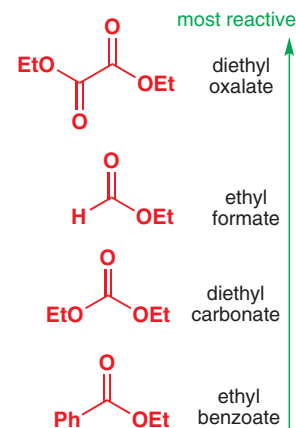

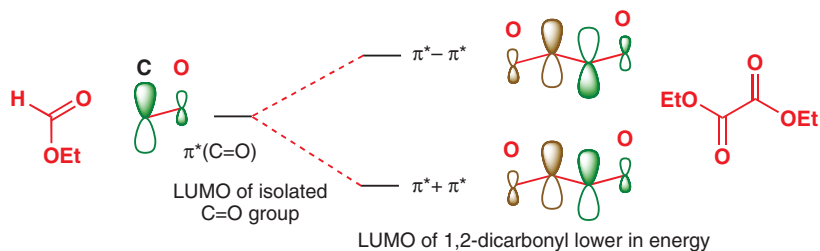

Formate esters look a bit like aldehydes but their ester character dominates. The hydrogen atom just makes them very electrophilic as they lack the σ conjugation (and steric hindrance) of simple esters.

Carbonates are particularly useful as they introduce a CO_2R group on to an enolate. It is perhaps not immediately obvious why they are more electrophilic than simple esters. Normal esters are (slightly) less electrophilic than ketones because the deactivating lone pair donation by the oxygen atom is more important than the inductive effect of the electronegative oxygen atom.

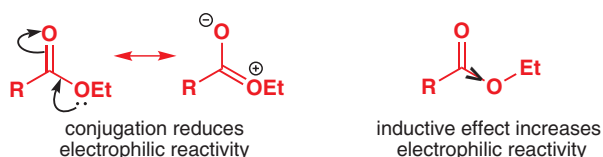

The result is a small difference between two large effects. In carbonate esters there are two oxygen atoms on the same carbonyl group. Both can exert their full inductive effect but the lone pairs have to share the same π^* orbital. The balance is changed—the summed inductive effects win out—and carbonates are more electrophilic than ordinary esters.

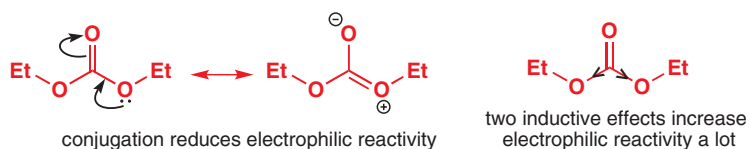

Finally, esters of aromatic acids cannot enolize but are less reactive than ordinary esters because of conjugation from the aromatic ring. These compounds may still be useful, as we shall see.

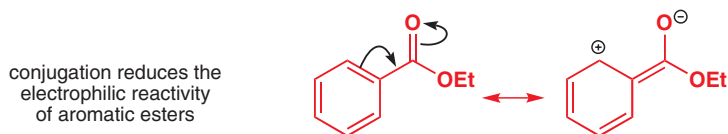

Crossed Claisen ester condensations between two different esters

To illustrate some Claisen reactions which are easy to do, we shall now give a few examples of crossed Claisen ester condensations between ordinary esters and the compounds we have just discussed. First, a reaction between a simple linear ester and diethyl oxalate performed under equilibrating conditions with ethoxide as the base. The weak base means a lower enolate concentration.

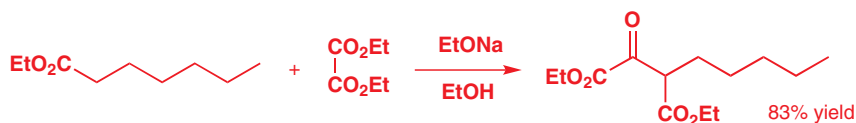

Only the simple ester can give an enolate, and the low concentration of this enolate reacts preferentially with the more electrophilic diethyl oxalate in a typical acylation

at carbon. No self-condensation of the simple ester occurs as the oxalate is much more electrophilic.

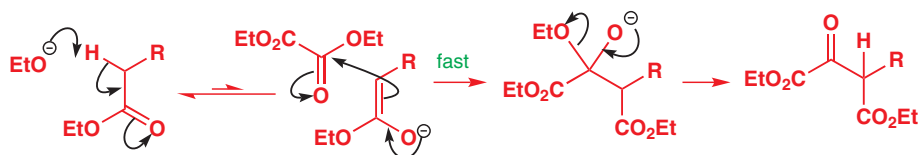

The product has an acidic hydrogen atom so it is immediately converted into a stable enolate, which is protonated on work-up in aqueous acid to give the tricarboxyl compound back again.

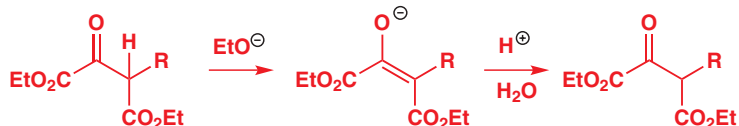

Another important example leads to the preparation of diethyl phenylmalonate. This compound cannot be made by 'alkylation' of diethyl malonate as aryl halides do not undergo nucleophilic substitution (Chapter 22).

A crossed Claisen ester condensation between very enolizable ethyl phenylacetate and unenolizable but electrophilic diethyl carbonate works very well indeed under equilibrating conditions.

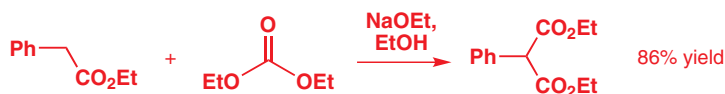

Claisen condensations between ketones and esters

Claisen condensations are acylations that always involve esters as the electrophilic partner, but enolates of other carbonyl compounds—ketones, for example—may work equally well as the enol partner. In a reaction with a carbonate, only the ketone can enolize and the reactive carbonate ester is more electrophilic than another molecule of the ketone. A good example is this reaction of cyclooctanone. It does not matter which side of the carbonyl group enolizes—they are both the same.

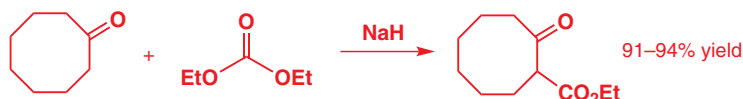

Unsymmetrical ketones often give a single product, even without the use of a specific enol equivalent, as reaction usually occurs on the less substituted side. This is another consequence of the final enolization being the irreversible step. In this example, both possible products may form, but only one of them can form a stable enolate. Under the equilibrating conditions of the reaction, only the enolate is stable, and all the material ends up as the isomer shown.

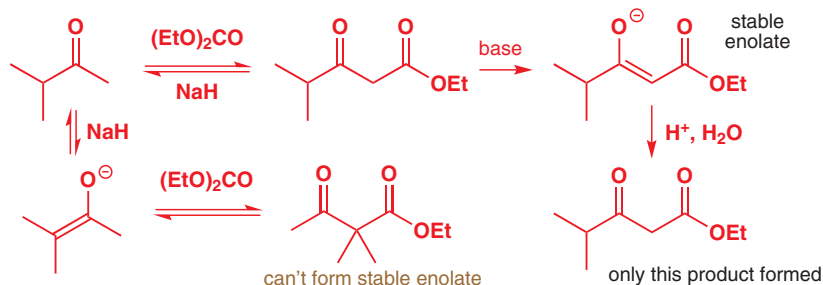

This compound was made because it was needed in a synthesis of multicolic acid, a metabolite of a penicillium mould. It is easy to see which atoms of the natural product (shown in black) were provided by the compound we have just made in a single easy step.

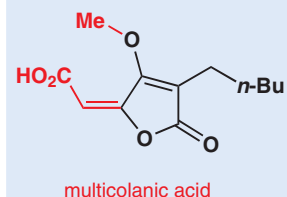

■ We're including carbonates as esters here: they are esters of carbonic acid.

Unsymmetrical ketones work well even when one side is a methyl group and the other a primary alkyl chain. This example gives an impressive yield and shows that, as expected, a remote alkene does not affect the reaction.

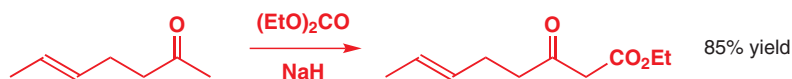

Even when both enolates can form, the less substituted dicarbonyl enolate is preferred because it constrains fewer groups to lie in the hindered plane of the tetrasubstituted enolate double bond.

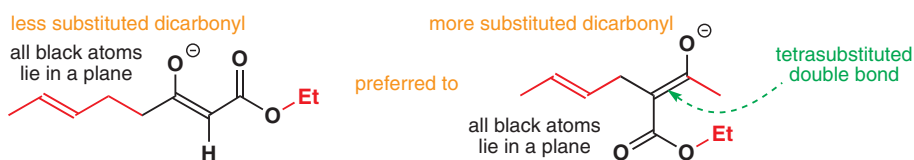

Diethyl oxalate also gives well-controlled condensations with ketones and we shall take the synthesis of a new drug as an example. One way to try to prevent heart disease is to reduce the amount of 'bad' lipoproteins in the blood. The drug Acifran does this, and a key step in its synthesis is the base-catalysed reaction between diethyl oxalate and a methyl ketone.

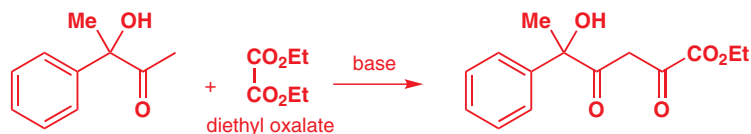

Notice that the hydroxyl group on the ketone does not interfere with the reaction. No doubt the first molecule of base removes the OH proton and the second molecule forms the enolate (the only possible enolate in either molecule). Fast condensation with highly electrophilic diethyl oxalate follows. The drug itself results from simple acid treatment of this product.

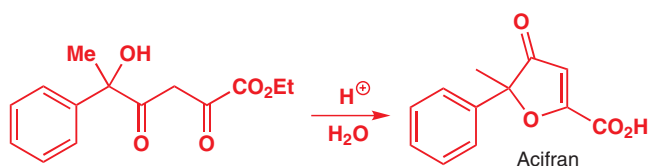

The other two unenolizable esters we mentioned on p. 643 undergo cross-condensations with ketones. Unlike formaldehyde, formate esters are well behaved—no special method is necessary to correspond with the Mannich reaction in aldol chemistry. Here is what happens with cyclohexanone.

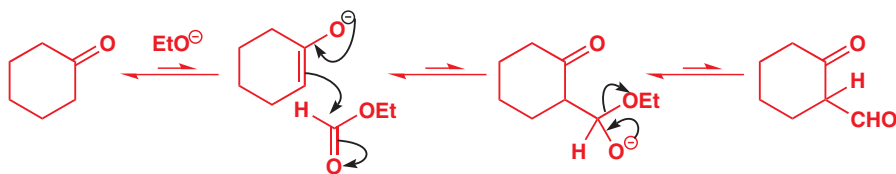

The product aldehyde is not at risk from nucleophilic attack, as it appears to be, because it immediately enolizes in base. On work-up, the product is formed as a stable enol with an intramolecular hydrogen bond.

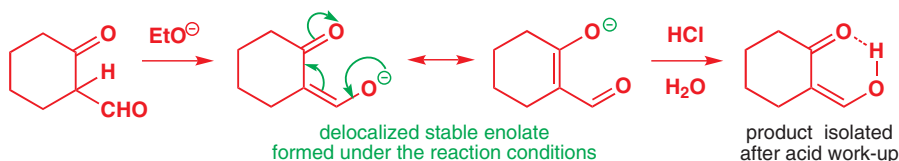

Summary of the preparation of keto-esters by the Claisen reaction

It is worth pausing at this moment to summarize which keto-esters can be made easily by the two methods we have discussed, namely

- Claisen ester condensation
- acylation of ketones with carbonates.

Ethyl acetoacetate (ethyl 3-oxobutyrates) can of course be made by the self-condensation of ethyl acetate. This ester is cheap to buy but homologues, available by the self-condensation of other esters, are usually made in the laboratory. Which esterifying group is used (OEt, OMe, etc.) is not important as long as the same alkoxide is used as the base.

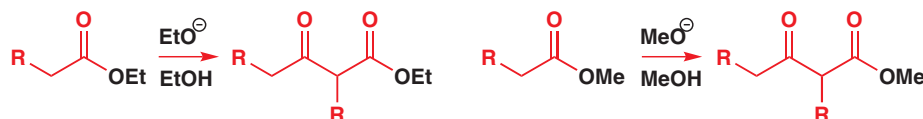

Compounds with only one of the R substituents in this structure are also easy to make. If the R substituent is at C2, it is best introduced by alkylation of the unsubstituted ester (see Chapter 25, p. 595).

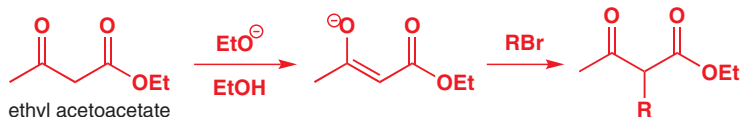

Attempts to make this compound by the Claisen ester condensation would require one of the approaches in the diagram below. The dashed curly arrows suggest the general direction of the condensation required and the coloured bonds are those that would be formed *if* the reaction worked.

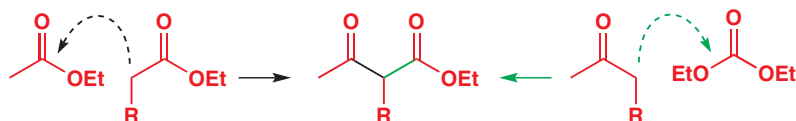

But neither reaction will work! The black route requires a controlled condensation between two different enolizable esters—a recipe for a mixture of products. The simple alkylation route above removes the need for control. The green route requires a condensation between an unsymmetrical ketone and diethyl carbonate. This condensation will work all right, but not to give this product. As you saw on p. 645, Claisen condensations prefer to give the less substituted dicarbonyl compound, and condensation would occur at the methyl group of the ketone on the right to give the other unsymmetrical keto-ester. So this isomer can be made easily too.

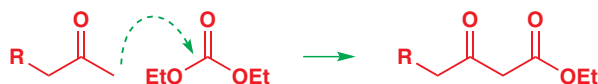

β -Keto esters

We pointed out on p. 643 that the Claisen reaction generates 1,3-dicarbonyl compounds. The examples here are a subset of such compounds: they are all β -keto esters:

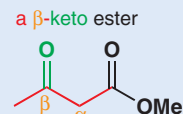

• Making β keto-esters: a checklist

A combination of self-condensation, condensation with diethyl carbonate, and alkylation of keto-esters prepared by one of these means will allow us to make most β keto-esters that we are likely to want. Look out for all the usual problems of enolate chemistry and if any of these is a problem, try an alkylation route.

- Will the right carbonyl compound enolize?
- If it is a ketone, will it enolize in the right way?
- Will the enolate react with the right acylation partner?

Controlling acylation with specific enol equivalents

In the first part of this chapter we saw how specific enol equivalents could be used to control aldol reactions. We now need to look at the same type of control in the acylation of enolates and extend our discussion to specific enolates of carboxylic acid derivatives.

We established in Chapter 10 a hierarchy for the electrophilic reactivity of acid derivatives that should by now be very familiar to you—acyl chlorides at the top to amides at the bottom. But what about the reactivity of these same derivatives towards enolization at the position, that is, the CH_2 group between R and the carbonyl group in the various structures? You might by now be able to work this out. The principle is based on the mechanisms for the two processes.

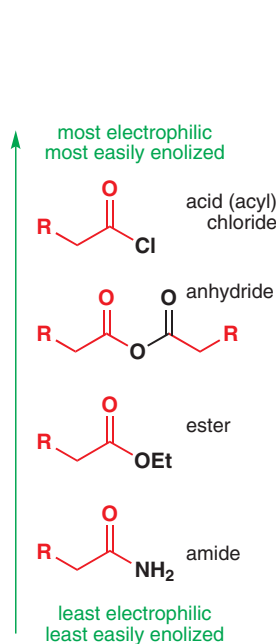
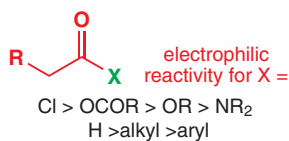

mechanism of nucleophilic attack

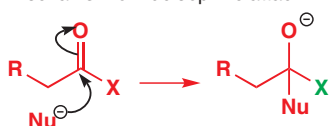

mechanism of enolate formation

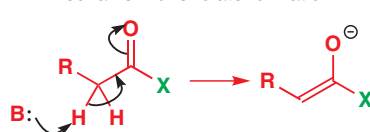

See how similar these two mechanisms are. In particular, they are the same at the carbonyl group itself. Electrons move into the $\text{C}=\text{O}$ π^* orbital: the $\text{C}=\text{O}$ bond becomes a $\text{C}-\text{O}$ single bond as a negative charge develops on the oxygen atom. It should come as no surprise that *the order of reactivity for enolization is the same as the order of reactivity towards nucleophilic attack*. Aldehydes are more electrophilic and more easily enolized than ketones and ketones are more electrophilic and more easily enolized than esters, although exact comparisons between aldehydes and ketones on the one hand and acid derivatives on the other are unwise.

In Chapter 20 we established that enolates can be formed from acid chlorides, but that they decompose to ketenes. Enolates can be formed from amides with difficulty, but with primary or secondary amides one of the NH protons is likely to be removed instead. For the remainder of this section we shall look at how to make specific enol equivalents of acids, esters, aldehydes, and ketones.

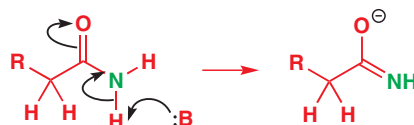
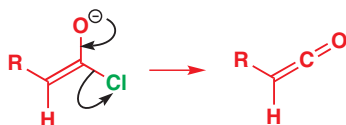

Directed C-acylation of esters

The danger we have to face is that acylation is inclined to occur on oxygen rather than on carbon. In the extreme case, naked enolates (those with completely non-coordinating cations) acylate cleanly on oxygen with anhydrides or acid chlorides.

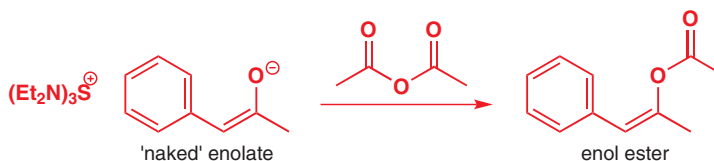

Fortunately, the reagents we have just discussed for aldol reactions (lithium and zinc enolates) are also acylated at carbon rather than on oxygen. Even with acid chlorides magnesium enolates, particularly those of 1,3-dicarbonyl compounds, give reliable C-acylation. The magnesium atom bonds strongly to both oxygens, lessening their effective negative charge.

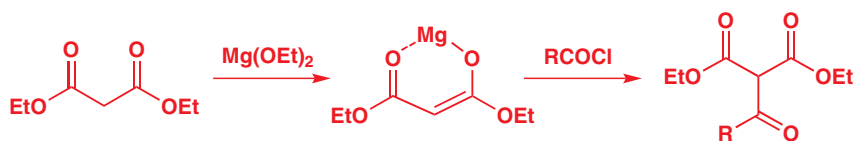

Hydrolysis and decarboxylation in the usual way lead to keto-esters or keto-acids. Of the more common metals used to form enolates, lithium is the most likely to give good C-acylation as, like magnesium, it forms a strong O–metal bond. It is possible to acylate simple lithium enolates with enolizable acid chlorides.

➔ See p. 597 for a discussion of decarboxylation.

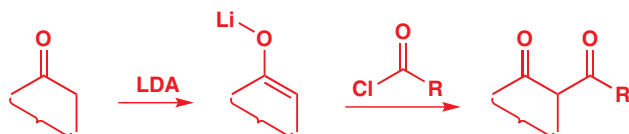

We shall describe two examples of this reaction being used as part of the synthesis of natural products. The first is pallescensin A, a metabolite of a sponge. It is quite a simple compound and some chemists in Milan conceived that it might be made from the chloro-diketone shown below, which might in turn be made by acylation of the enolate of a symmetrical ketone.

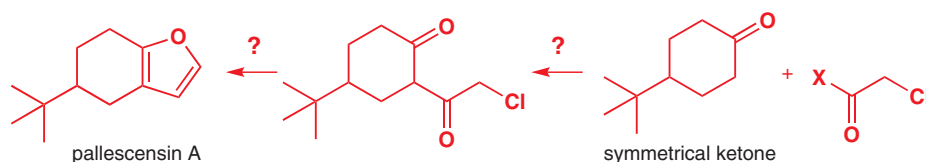

The route chosen was to react the lithium enolate of 4-*t*-butyl cyclohexanone with the correct acid chloride. This reaction worked well, as did the rest of the synthesis of pallescensin A, which was first made by this route. The key step, the acylation of the lithium enolate, is interesting because alkylation could have occurred instead. The acid chloride is more electrophilic than the alkyl chloride in this reaction, although alkylation does occur in the next step. Notice how the lithium atom holds the molecules together during the reaction.



Even the dilithio derivatives of carboxylic acids, made by treating a carboxylic acid with two molecules of LDA, can give good reactions with acid chlorides. In these reactions it is not necessary to have a proton remaining between the two carbonyl groups of the product as the reaction is between a strong nucleophile and a strong electrophile and is under kinetic control.

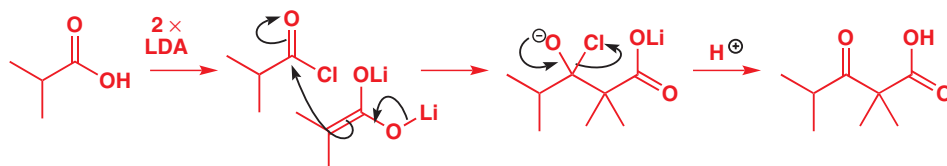

It is rather more common to use enamines or silyl enol ethers in acylations with acid chlorides. These are more general methods—enamines work well for aldehydes and ketones while silyl enol ethers work for all classes of carbonyl compounds. It is possible to combine two enolizable molecules quite specifically by these methods, and we shall consider them next.

The acylation of ketones via enamines and aza-enolates

Enamines are made from secondary amines and aldehydes or ketones via the iminium salt: you met them in Chapter 11 and have seen them in action in Chapters 20 and 25. In Chapter 25 we saw that reliable C-alkylation of enamines occurs with reactive allyl halides and

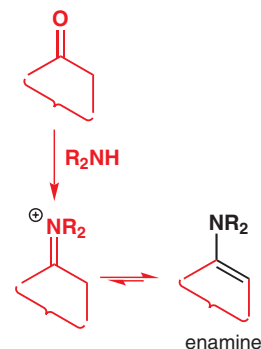

α -halocarbonyl compounds, but that unwanted *N*-alkylation often competes with simple alkyl halides. We also noted earlier in this chapter that they are rarely used for aldol reactions as they are not reactive enough.

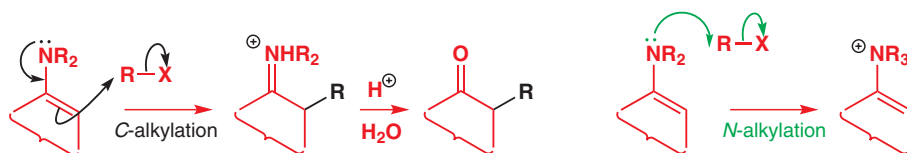

Acylation with the much more reactive acid chlorides could follow the same two pathways, but with one big difference. The products of *N*-acylation are unstable salts and *N*-acylation is reversible. Acylation on carbon, on the other hand, is irreversible. For this reason enamines end up acylated reliably on carbon.

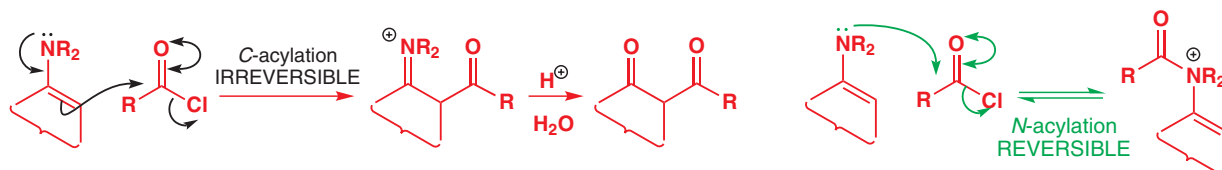

The Swiss chemist Oppolzer used just such a reaction in a synthesis of the natural product longifolene. He first prepared an acid chloride from cyclopentadiene, and the enamine from cyclopentanone and the secondary amine morpholine.

■ Morpholine is frequently used in the preparation of enamines. See p. 592.

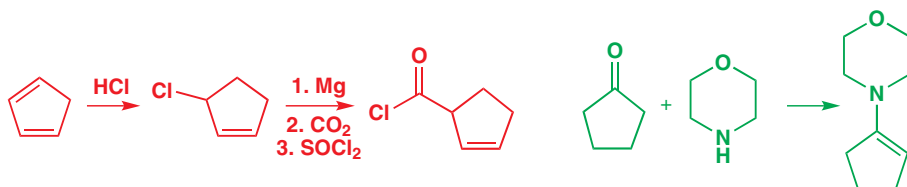

Combining the enamine with the acid chloride led to a clean acylation at carbon in 82% yield and eventually to a successful synthesis of longifolene.

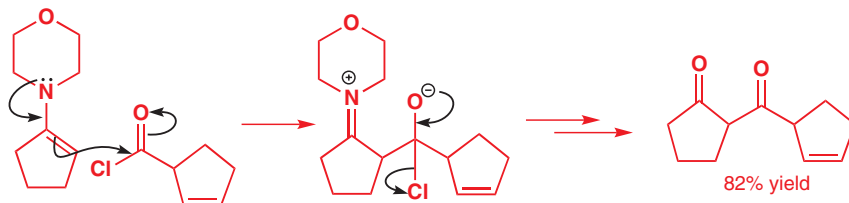

Aza-enolates also react cleanly at carbon with acid chlorides. Good examples come from dimethylhydrazones of ketones. When the ketone is unsymmetrical, the aza-enolate forms on the less substituted side, even when the distinction is between primary and secondary carbons. The best of our previous regioselective acylations have distinguished only methyl from more highly substituted carbon atoms.

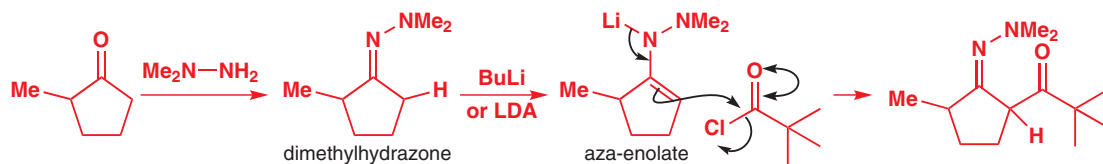

You will not be surprised to find that the immediate product tautomerizes to an acyl-enamine further stabilized by an internal hydrogen bond. Mild acidic work-up releases the diketone product. The overall procedure may sound complicated— Me_2NNH_2 then base then acyl chloride then acidic methanol—but it is performed in a single flask and the products, the 1,3-diketones, are formed in excellent yield—in this case 83% overall.

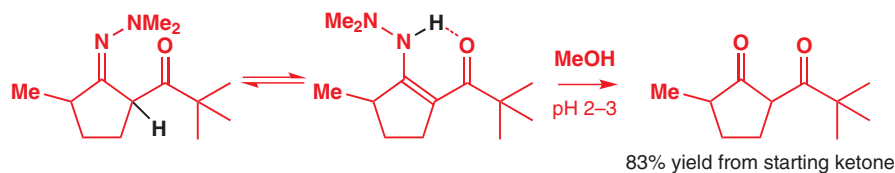

Hydrazone, as we explained on p. 232 of Chapter 11, are much less electrophilic than ketones. Even BuLi can be used as a base: it does not attack the $\text{C}=\text{N}$ bond.

Interactive mechanism for hydrazone enolate alkylation

Acylation of ketones under acidic conditions

Acylation of ketone enols with anhydrides are catalysed by Lewis acids such as BF_3 . This process will remind you of Friedel–Crafts acylation (p. 477) but a better analogy is perhaps the aldol reaction, where metals such as lithium hold the reagents together so that reaction can occur around a six-membered ring.

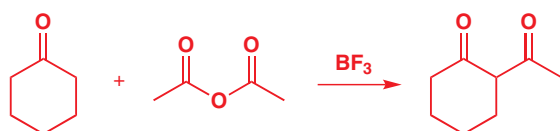

The mechanism obviously involves attack by the enol (or 'boron enolate') of the ketone on the anhydride, catalysed by the Lewis acid. Probably the boron atom holds the reagents together, much as the lithium atom does in aldol reactions of lithium enolates (p. 625).

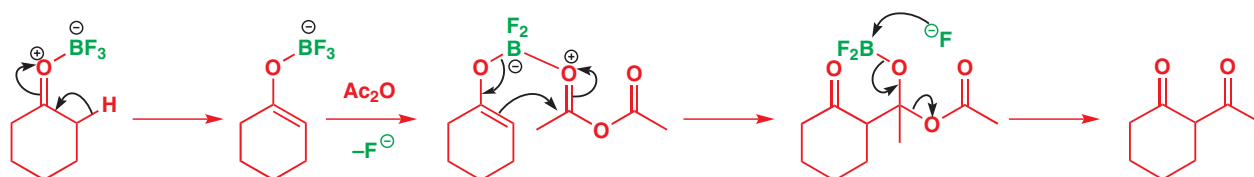

Under the conditions of the reaction, the product forms a stable boron enolate, which needs to be decomposed to the diketone with refluxing aqueous sodium acetate.

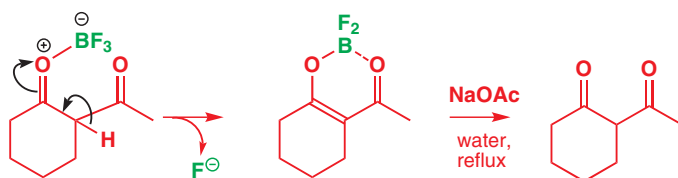

Acylation of free carboxylic acids

You might think that the presence of the acidic proton in a carboxylic acid would present an insuperable barrier to the formation and use of any enol derivatives. In fact, this is not a problem with either the lithium enolates or the silyl enol ethers. Addition of BuLi or LDA to a carboxylic acid immediately results in the removal of the acidic proton and the formation of the lithium salt of the carboxylic acid. If BuLi is used, the next step is addition of BuLi to the carbonyl group and the eventual formation of a ketone (see Chapter 10, p. 218). But, if LDA is used, it is possible to form the lithium enolate of the lithium derivative of the carboxylic acid.

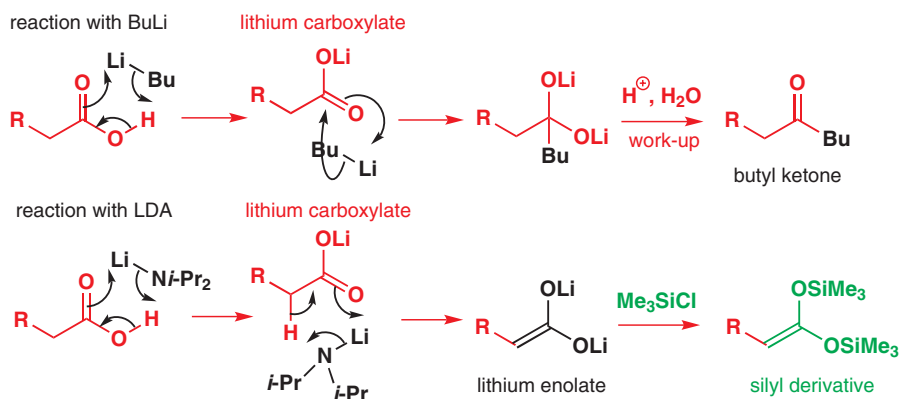

■ Silyl enol ethers of acids or esters are called silyl ketene acetals. See p. 609 for more on this.

The enolate derivative is rather strange as it has two OLi groups on the same double bond, but it can be cleanly converted to the corresponding silyl enol ether. Both lithium enolates and silyl enol ethers from acids can be used in aldol reactions.

● Useful enolates for the aldol reaction and for acylation at carbon

Enolate type	Aldehyde	Ketone	Ester	Acid
lithium enolate	×	√	√	√
silyl enol ether	√	√	√	√
enamine	√	√	×	×
aza-enolate	√	√	×	×
zinc enolate	×	×	√	×

This concludes our general survey of specific enolates in acylation at carbon. We are left with some reactions that are particularly easy to do.

Intramolecular crossed Claisen ester condensations

In the same way as with intramolecular aldol condensations, we do not have to worry so much about controlling where enolization occurs providing that one product is more stable than the others—for example, it might have a five- or a six-membered ring (rather than a four- or eight-membered one)—and we carry out the reaction under equilibrating conditions. A couple of examples should show what we mean. Although there are two sites for enolate formation, one would give a four-membered ring and can be ignored. Only enolization of the methyl group leads to a stable six-membered ring.

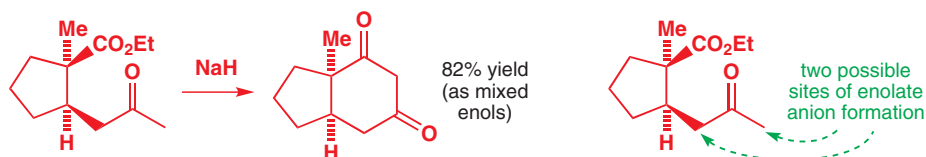

In this next example the two possible sites for enolate anion formation would both lead to stable five-membered rings. The product forms a stable enolate under the reaction conditions but the alternative cannot form a stable enolate as there is no hydrogen atom between the two carbonyl groups.

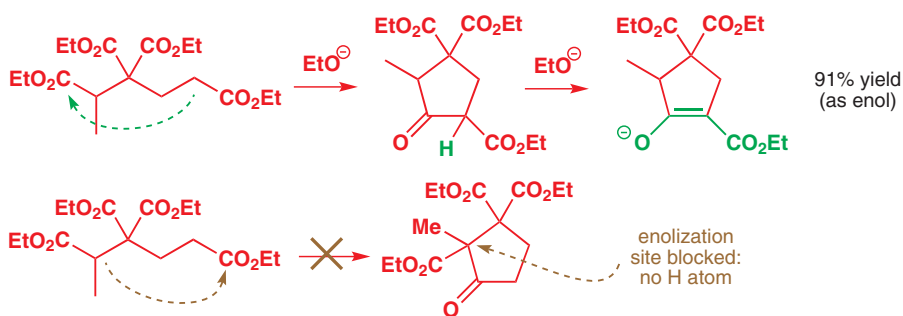

In the next example, there are three possible sites for enolate anion formation, but only one product is formed and in good yield too. If we consider all three possible enolate anions, the choice is more easily made. First, the reaction that *does* happen. An enolate anion is formed from the ketone at the green site and acylation at carbon follows. The product is a fused rather than a bridged bicyclic structure and can easily form a stable enolate anion.

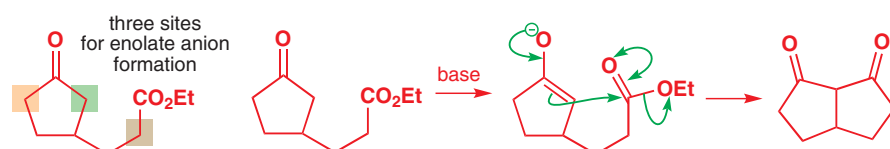

We could form the enolate anion on the other side of the ketone at the orange site and attack the ester in the same way. The product would be a bridged bicyclic diketone, and is not formed (see above). The third possible enolate site (brown) could give an aldol reaction but the product would again be a bridged bicyclic compound and is not formed.

Symmetry in intramolecular crossed Claisen condensations

If cyclization is to be followed by decarboxylation, a cunning plan can be set in motion. Addition of an amine by an S_N2 reaction to an α halo-ester followed by conjugate addition to an unsaturated ester gives a substrate for Claisen ester cyclization.

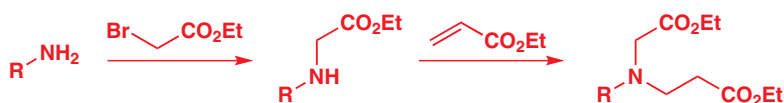

This diester is unsymmetrical so cyclization is likely to lead to two different keto-esters. Either can form a stable enolate so both are indeed formed. This sounds like very bad news since it gives a mixture of products.

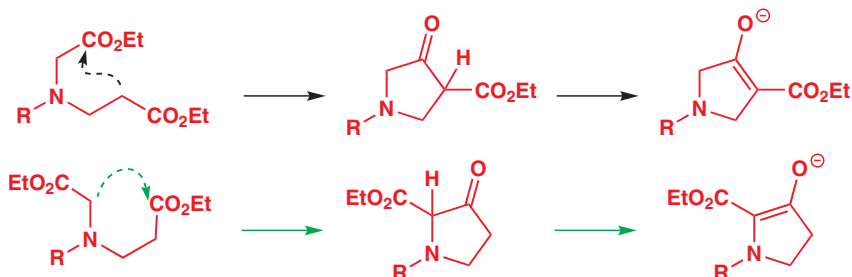

The cunning plan is that the relative positions of the ketone and the nitrogen atom in the five-membered ring are the same in both products. All that differs is the position of the

Bicyclic compounds

In Chapter 32 we will discuss the differences between fused compounds (one bond in common), *spiro* compounds (one atom in common), and bridged compounds (rings joined at two non-adjacent atoms). Each of these three examples has two five-membered rings.

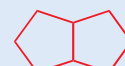

fused bicyclic



spirocyclic



bridged bicyclic

CO₂Et group. When the two different products are hydrolysed and decarboxylated they give the same amino-ketone!

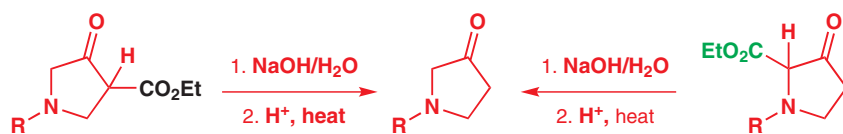

Just occasionally it is possible to carry out cross-condensations between two different enolizable molecules under equilibrating conditions. A notable example is the base-catalysed reaction between methyl ketones and lactones. With sodium hydride—a strong base that can convert either starting material entirely into its enolate anion—good yields of products from the attack of the enolate of the ketone on the electrophilic lactone can be obtained.

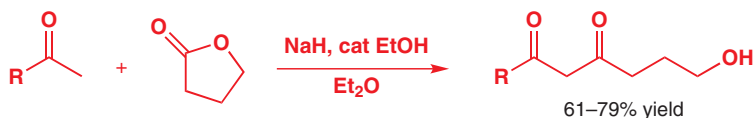

Kinetic enolate formation must occur at the methyl group of the ketone followed by acylation with the lactone. Lactones are rather more electrophilic than non-cyclic esters, but the control in this sequence is still remarkable. Notice how a stable enolate is formed by proton transfer within the first-formed product.

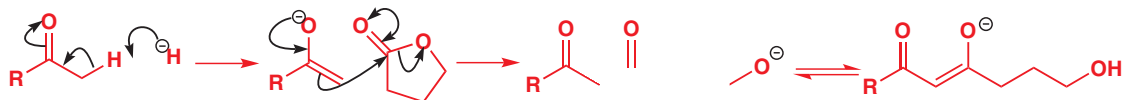

Carbonyl chemistry—where next?

This chapter concludes a survey of the reactions of carbonyl compounds which started way back in Chapter 6 with an introduction to addition reactions at the C=O group, and moved on through the following stages:

Chapter 9: C–C bonds by adding organometallics to C=O

Chapter 10: Substitution at C=O (carboxylic acid derivatives)

Chapter 11: Substitution at C=O with loss of the carbonyl O (acetals, imines, etc.)

Chapter 20: Enols and enolates

Chapter 25: Alkylating enolates

Chapter 26: Adding enols and enolates to C=O groups: the aldol and Claisen reactions

Carbonyl groups are the ‘hooks’ that allow chemists to put molecules together, and in the chapter after next (Chapter 28) we will discuss how we think about the science of synthesis using carbonyl reactivity. We will revisit many of the reactions you have seen not just in this next chapter, but beyond—in particular in the synthesis of heterocycles (Chapter 30) and in diastereoselective and enantioselective reactions (Chapters 33 and 41).

Further reading

S. Warren, *Chemistry of the Carbonyl Group*, Wiley, Chichester, 1974: section 5 is ‘Building Organic Molecules from Carbonyl Compounds.’ More advanced treatment: P. Wyatt and S. Warren, *Organic Synthesis: Strategy and Control*, Wiley, Chichester, 2007, chapters 3–6. The ultimate source for all types of aldol reaction is A. T. Nielsen and W. J. Houlihan, *Organic Reactions*, 1968, 16, whole volume. And for the

Claisen style condensations, J. P. Schaefer and J. J. Bloomfield, *The Dieckmann Condensation: G. Jones, The Knoevenagel Condensation: Organic Reactions*, 1967, 15, whole volume.

F. A. Carey and R. J. Sundberg, *Advanced Organic Chemistry B, Reactions and Synthesis*, 5th edn, Springer 2007, chapter 2.

Check your understanding



To check that you have mastered the concepts presented in this chapter, attempt the problems that are available in the book's Online Resource Centre at <http://www.oxfordtextbooks.co.uk/orc/clayden2e/>

27

Sulfur, silicon, and phosphorus in organic chemistry

Connections

➔ Building on

- Carbonyl chemistry [ch6](#), [ch10](#), & [ch11](#)
- Wittig reaction [ch11](#)
- Kinetic and thermodynamic control [ch12](#)
- Stereochemistry [ch14](#)
- Elimination reactions [ch17](#)
- Conjugate addition [ch22](#)
- Reduction [ch23](#)
- Chemistry of enol(ate)s [ch25](#) & [ch26](#)

➔ Arriving at

- Organic S and Si chemistry
- S, Si, and P in the synthesis of alkenes
- Why *E/Z* control matters
- Ways to control *E/Z* geometry
- Equilibration of alkenes gives *trans*
- Effects of light and how we see
- Julia olefination and the Wittig reaction at work
- Reliable reduction of alkynes

➔ Looking forward to

- Diastereoselectivity [ch33](#)
- Pericyclic reactions [ch34](#) & [ch35](#)
- Fragmentations [ch36](#)
- Radicals and carbenes [ch37](#) & [ch38](#)
- Asymmetric synthesis [ch41](#)

Useful main group elements

Electronegativities

C (2.5)	N (3.0)	O (3.5)	F (4.0)
Si (1.8)	P (2.1)	S (2.5)	Cl (3.0)

Organic chemists make use of most elements in the periodic table: you have already seen organic compounds of Li, B, F, Na, Mg, Al, Si, P, S, Cl, K, Cu, Br, and I—but that's only the start. Three of the most important of these are sulfur, phosphorus, and silicon. They all form stable organic compounds and play nearly as important roles in organic chemistry as oxygen, nitrogen, and the halogens. They are second row elements, coming immediately below carbon, nitrogen, and oxygen, to which they have some similarity. Electronegativity (shown in the margin) diminishes from right to left and downwards.

The main difference from C, N, and O is that Si, P, and S can form more bonds than the first row elements. This is because they have more orbitals: the five 3d orbitals added to the 3s and three 3p orbitals. Silicon forms tetrahedral silanes, rather like alkanes, but also forms stable five-valent anions. Phosphorus forms phosphines, rather like amines, but also tetrahedral phosphine oxides. Sulfur can have any coordination number from zero to seven, forming sulfides, like ethers, and tetrahedral sulfones with six bonds to sulfur. And it is with sulfur that we start.

Spelling sulfur

If you look in the Oxford English dictionary you will see 'sulphur' (along with 'sulphuric', 'sulphate'...). These are peculiarly British spellings, and it was agreed some years ago that chemists the world over should use a uniform spelling: 'sulfur'.

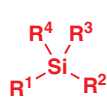

a silane



a five-valent Si anion

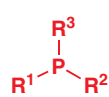

a phosphine

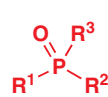

a phosphine oxide

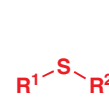

a sulfide

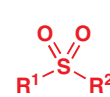

a sulfone

Sulfur: an element of contradictions

The first organosulfur compounds in this book were the dreadful smell of the skunk and the wonderful smell of the truffle, which pigs can detect through a metre of soil and which is so

Online support. The icon  in the margin indicates that accompanying interactive resources are provided online to help your understanding: just type www.chemtube3d.com/clayden/123 into your browser, replacing **123** with the number of the page where you see the icon. For pages linking to more than one resource, type **123-1**, **123-2** etc. (replacing **123** with the page number) for access to successive links.

delightful that truffles cost more than their weight in gold. Sulfur compounds can be reducing or oxidizing agents, anions or cations, nucleophiles or electrophiles as well as foul- or sweet-smelling.

Useful sulfur compounds include the leprosy drug dapsone (Chapter 6), the arthritis drug feldene (Chapter 20), glutathione (Chapter 22), a scavenger of oxidizing agents that protects most living things against oxidation and contains the natural amino acid cysteine, and, of course, the famous antibiotics, the penicillins, mentioned in several chapters.

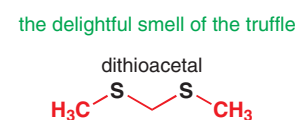
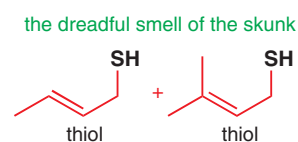
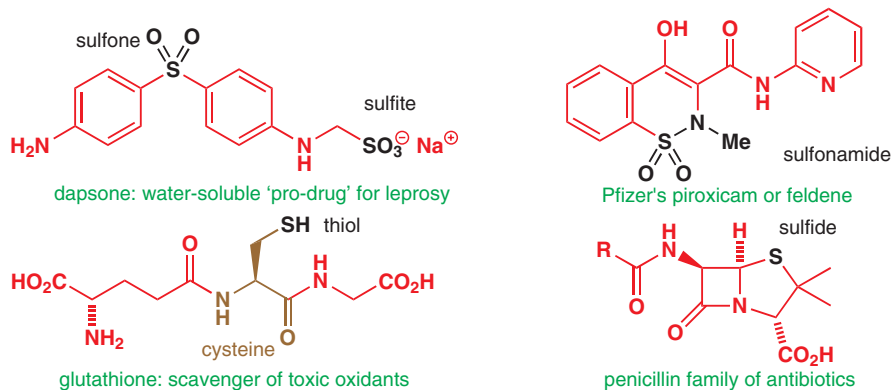

Important reactions include sulfur as nucleophile and leaving group in the $\text{S}_{\text{N}}2$ reaction, sulfonation of aromatic rings (Chapter 21), and formation and reduction of thioacetals (Chapter 23). This $\text{S}_{\text{N}}2$ reaction uses a sulfur nucleophile and a sulfur-based leaving group.

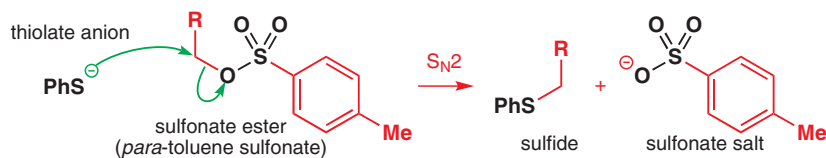

Some facts about sulfur

Sulfur is a p-block element in group VI (or 16 if you prefer) immediately below oxygen and between phosphorus and chlorine. It is natural for us to compare sulfur with oxygen but we will, strangely, compare it with carbon as well.

Sulfur is much less electronegative than oxygen; in fact, it has the same electronegativity as carbon, so it is no good trying to use the polarization of the C–S bond to explain anything! It forms reasonably strong bonds to carbon—strong enough for the compounds to be stable but weak enough for selective cleavage in the presence of the much stronger C–O bonds. It also forms fairly strong bonds to itself. Elemental crystalline yellow sulfur consists of S_8 molecules—eight-membered rings of sulfur atoms.

Because sulfur is in the second row of the periodic table it forms many types of compounds not available to oxygen. Compounds with S–S and S–halogen bonds are quite stable and can be isolated, unlike the unstable and often explosive O–halogen and O–O compounds. Sulfur's d orbitals allow it to have oxidation states of 0, 2, 4, or 6 and coordination numbers from 0 to 7. Here is a selection of compounds.

Compounds of sulfur

Oxidation state	S(II)			S(IV)		S(VI)		
coordination number	0	1	2	3	4	4	6	7
example	S^{2-}	RS^-	R_2S	$\text{R}_2\text{S}=\text{O}$	SF_4	R_2SO_2	SF_6	SF_7^-

Sulfur is a very versatile element

As well as this variety of oxidation states, sulfur shows a sometimes surprising versatility in function. Simple S(II) compounds are good nucleophiles, as you would expect from the

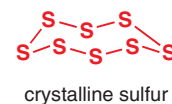

Typical bond strengths, kJ mol^{-1}

X =	C	H	F	S
C–X	376	418	452	362
S–X	362	349	384	301

high-energy non-bonding lone pairs ($3sp^3$ rather than the $2sp^3$ of oxygen). A mixture of a thiol (RSH, the sulfur equivalent of an alcohol) and NaOH reacts with an alkyl halide to give the sulfide alone by nucleophilic attack of RS^- .

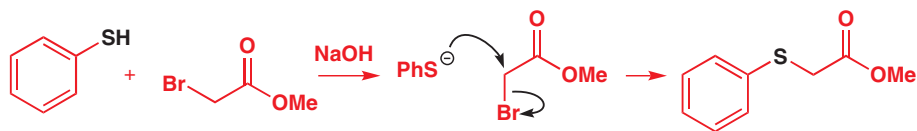

Thiols (RSH) are more acidic than alcohols so the first step is a rapid proton exchange between the thiol and hydroxide ion. The thiolate anion then carries out a very efficient S_N2 displacement on the alkyl bromide to give the sulfide. Notice that the thiolate anion does not attack the carbonyl group. Small basic oxyanions have high charge density and low-energy filled orbitals—they are hard nucleophiles that prefer to attack protons and carbonyl groups. Large, less basic thiolate anions have high-energy filled orbitals and are soft nucleophiles. They prefer to attack saturated carbon atoms. Thiols and thiolates are good soft nucleophiles.

➔ This 'hard or soft' nature of nucleophiles is discussed with S_N2 reactions in general in Chapter 15.

● Thiols (RSH) are more acidic than alcohols (ROH) but sulfur compounds are better nucleophiles than oxygen compounds towards saturated carbon atoms (S_N2).

■ Thionyl chloride $SOCl_2$ is electrophilic at sulfur but sulfuryl chloride SO_2Cl_2 is electrophilic at chlorine. Contradictory again!

They are also good soft electrophiles. Sulfenyl chlorides ($RSOCl$) are easily made from disulfides ($RS-SR$) and sulfuryl chloride (SO_2Cl_2). This S(VI) chloride has electrophilic chlorine atoms and is attacked by the nucleophilic disulfide to give two molecules of $RSOCl$ and gaseous SO_2 . There's a lot of sulfur chemistry here! We start with a nucleophilic attack by one sulfur atom of the disulfide. The intermediate contains a tricoordinate sulfur cation or sulfonium salt. The chloride ion now attacks the other sulfur atom of this intermediate and two molecules of $RSOCl$ result. Each atom of the original disulfide has formed an S-Cl bond. One sulfur atom was a nucleophile towards chlorine and the other an electrophile.

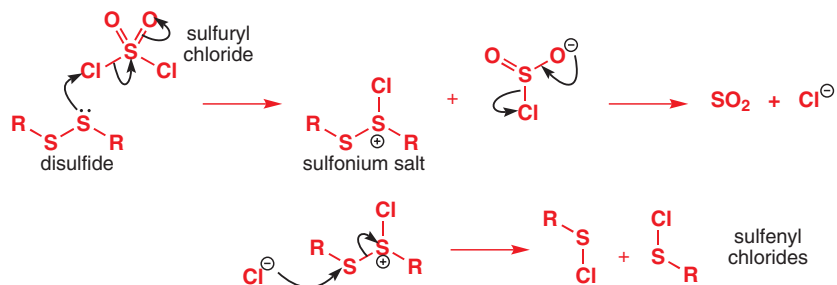

The product of this reaction, the sulfenyl chloride, is also a good soft electrophile towards carbon atoms, particularly towards alkenes. The reaction is very like bromination, with a three-membered cyclic sulfonium ion intermediate replacing the bromonium ion of Chapter 19. The reaction is stereospecific and the product is *anti*.

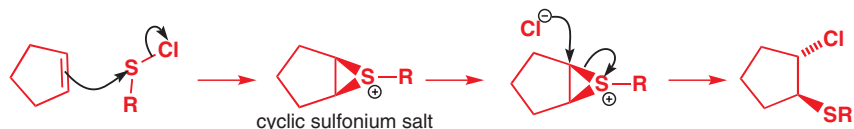

At higher oxidation states the compounds become harder electrophiles as the positive charge on sulfur increases. We have already mentioned tosyl (*para*-toluenesulfonyl) chloride, $TsCl$, as an electrophile for alkoxide ions in this chapter and in earlier chapters.

At this higher oxidation state it might seem unlikely that sulfur could also be a good nucleophile, but consider the result of reacting $TsCl$ with zinc metal. Zinc provides two electrons and turns the compound into an anion. This anion can also be drawn in two ways.

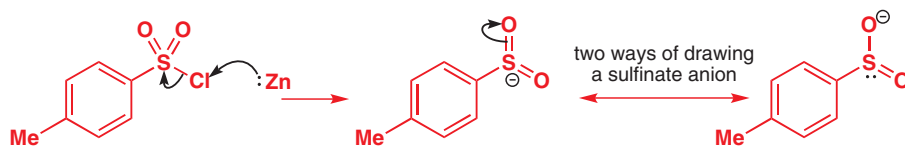

Surprisingly, this anion is also a good soft nucleophile and attacks saturated carbon atoms through the sulfur atom. In this case attack occurs at the less substituted end of an allylic bromide to give an allylic sulfone, which we will use later on.

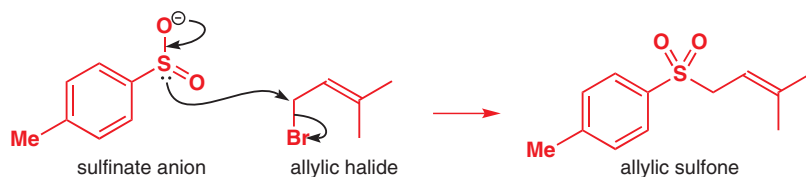

- Sulfur compounds may be good nucleophiles and good electrophiles.

Sulfur-based functional groups

You have already met a number of sulfur-containing functional groups: the following list brings them together for reference.

Name	Structure	Importance	Example	Example details
thiol (or mercaptan)	RSH	strong smell, usually bad, but heavenly in low concentrations		smell and taste of coffee and grapefruit
thiolate anion	RS ⁻	good soft nucleophiles		
disulfide	RS-SR	cross-links proteins		cystine
sulfonyl chloride	RS-Cl	good soft electrophiles		
sulfide (or thioether)	R-S-R	molecular link		smell and taste of pineapple
sulfonium salt	R ₃ S ⁺	important reagents		ylid used in epoxidations
sulfoxide	R ₂ S=O or R ₂ S ⁺ -O ⁻	many reactions; can be chiral		DMSO (dimethyl sulfoxide)
sulfone	R ₂ SO ₂	anion-stabilizing group		
sulfonic acid	RSO ₂ OH	strong acids		p-toluenesulfonic acid, TsOH
sulfonyl chloride	RSO ₂ Cl	turns alcohols into leaving groups		p-toluenesulfonyl chloride, TsCl

As this chapter develops you will see other examples of the versatility of sulfur. You will see that it can be removed from organic compounds in either an oxidative or a reductive fashion, and you will see that it can stabilize anions or cations on adjacent carbon atoms. The stabilization of anions is the first main section of the chapter.

Sulfur-stabilized anions

The stabilization of anions by sulfides, sulfoxides, and sulfones is a theme that runs right through this chapter. Sulfur has six electrons in its outer shell. As a sulfide, therefore, the sulfur atom carries two lone pairs. In a sulfoxide, one of these lone pairs is used in a bond to an oxygen atom—sulfoxides can be represented in at least two alternative but equivalent ways. The sulfur atom in a sulfone uses both of its lone pairs in bonding to oxygen, and is usually represented with two S=O double bonds.

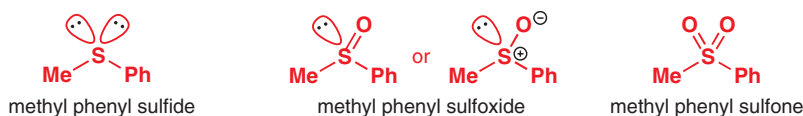

Chiral sulfoxides

Sulfoxides have the potential for chirality—the tetrahedral sulfur atom is surrounded by four different groups (here Ph, Me, O, and the lone pair) and (unlike, say, the tetrahedral nitrogen atom of an amide) has a stable tetrahedral configuration. We will revisit chirality in sulfoxides later in the chapter.

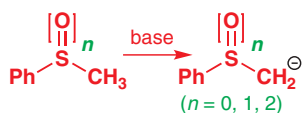
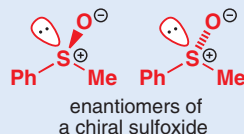

Treatment of any of these compounds with strong base produces an anion on what was the methyl group. How does the sulfur stabilize the anion? This question has been the subject of many debates and we have not got space to go into the details of all of them. There are at least two factors involved, and the first is evident from this chart of pK_a values for protons next to sulfone, sulfoxide, and sulfide functional groups.

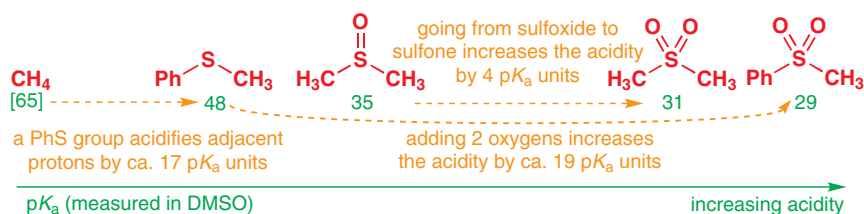

■ Carbanions next to sulfones are planar, while anions next to sulfoxides and sulfides are thought to be pyramidal (sp^3 hybridized).

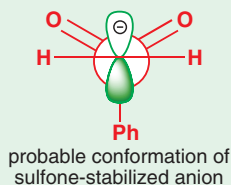

Clearly, the oxygen atoms are important—the best anion stabilizer is the sulfone, followed by the sulfoxide and then the sulfide. You could compare deprotonation of a sulfone with deprotonation of a ketone to give an enolate (Chapter 20). Enolates have a planar carbon atom and the anion is mainly on the oxygen atom. Sulfone-stabilized carbanions have two oxygen atoms and the anionic carbon atom is probably planar, with the negative charge in a p orbital aligned midway between the S=O bonds.

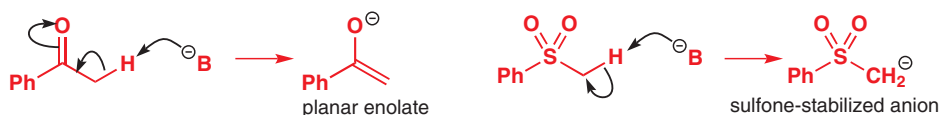

Yet the attached oxygen atoms cannot be the sole reason for the stability of anions next to sulfur because even the sulfide functional group also acidifies an adjacent proton quite significantly. There is some controversy over exactly why this should be, but the usual explanation is that polarization of the sulfur's 3s and 3p electrons (which are more diffuse, and therefore more polarizable, than the 2s and 2p electrons of oxygen) contributes to the stabilization.

Anion stabilization by adjacent sulfur

It was long thought that delocalization into sulfur's empty 3d orbitals provided the anion stabilization required, but theoretical work in the last 20 years or so suggests this may not be the case. Thus, *ab initio* calculations suggest that the C–S bond in $-\text{CH}_2\text{SH}$ is longer than that in CH_3SH . The converse would be true if delocalization into the sulfur's d orbitals were important. Delocalization would shorten the bond because it would have partial double-bond character. More likely as an additional factor is delocalization into the σ^* orbital of the C–S bond on the other side of the sulfur atom—the equatorial proton of dithiane (see p. 662 for more on dithiane) is more acidic than the axial one, and the equatorial anion is more stable because it is delocalized into the C–S bond's σ^* orbital.

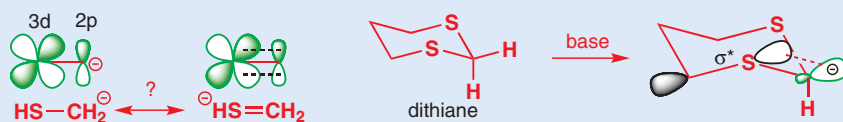

A sulfoxide-stabilized anion in a synthesis

A sulfoxide alkylation formed the key step of a synthesis of the important vitamin biotin. Biotin contains a five-membered heterocyclic sulfide fused to a second five-membered ring, and the bicyclic skeleton was easy to make from a simple symmetrical ester. The vital step is a double $\text{S}_{\text{N}}2$ reaction on primary carbon atoms.

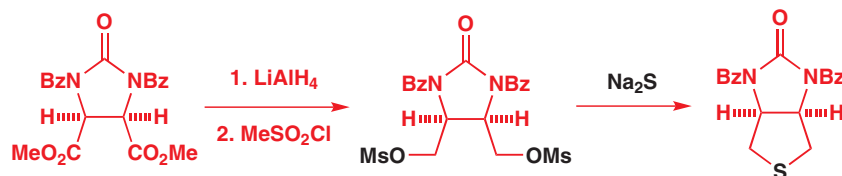

The next step was to introduce the alkyl chain—this was best done by first oxidizing the sulfide to a sulfoxide, using sodium periodate. The sulfoxide was then deprotonated with *n*-BuLi and alkylated with an alkyl iodide containing a carboxylic acid protected as its *tert*-butyl ester. Reduction of the sulfoxide and hydrolysis back to the free acid gave biotin.

➔ This synthesis involves some stereochemistry, which will be revisited in Chapter 32.

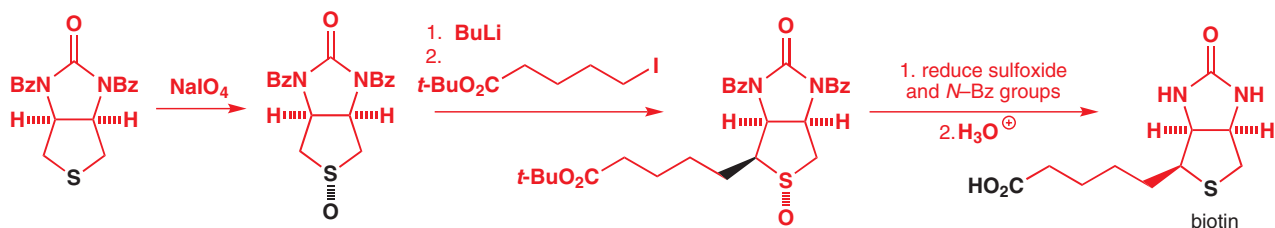

Thioacetals

Although sulfide deprotonations are possible, the protons adjacent to *two* sulfide sulfur atoms are rather more acidic and alkylation of thioacetals is straightforward.

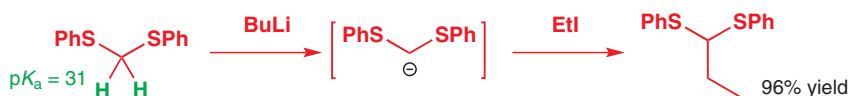

In general, thioacetals can be made in a similar way to ‘normal’ (oxygen-based) acetals—by treatment of an aldehyde or a ketone with a thiol and an acid catalyst—although a Lewis acid such as BF_3 is usually needed rather than a protic acid. The most easily made, most stable toward hydrolysis, and most reactive towards alkylation are cyclic thioacetals derived from 1,3-propanedithiol, known as dithianes.

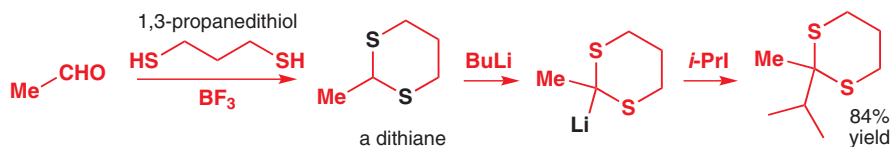

Dithianes are extremely important compounds in organic synthesis because *going from carbonyl compound to thioacetal inverts the polarity at the functionalized carbon atom*. Aldehydes, as you are well aware, are electrophiles at the $\text{C}=\text{O}$ carbon atom, but dithioacetals, through deprotonation to an anion, are nucleophilic at this same atom.

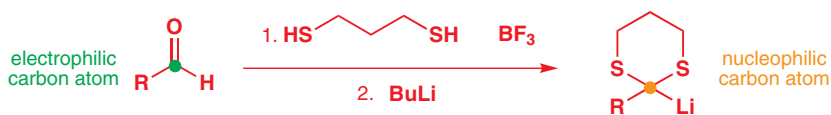

Dithianes in synthesis

An example: chemists wanted to make this compound (a ‘metacyclophane’) because they wanted to study the independent rotation of the two benzene rings, which is hindered in such a small ring. An ideal way would be to join electrophilic benzylic bromides to nucleophilic carbonyl groups, if that were possible.

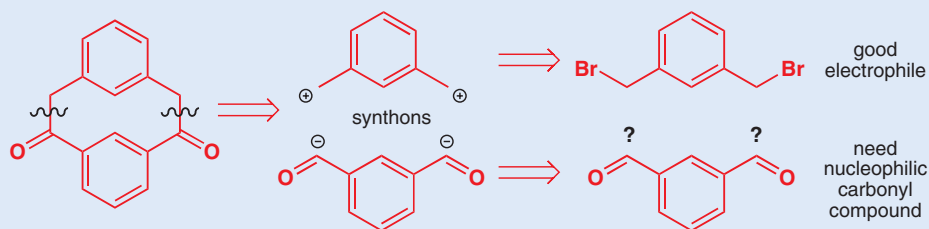

The dibromide and dialdehyde were both available—what they really wanted was a nucleophilic equivalent of the dialdehyde to react with the dibromide. So they made the dithiane. Sulfur is less basic than oxygen, so the protonated species is lower in concentration at a given pH, and the sulfur 3p lone pairs are less able to form a stable π bond to carbon than are the oxygen 2p lone pairs.

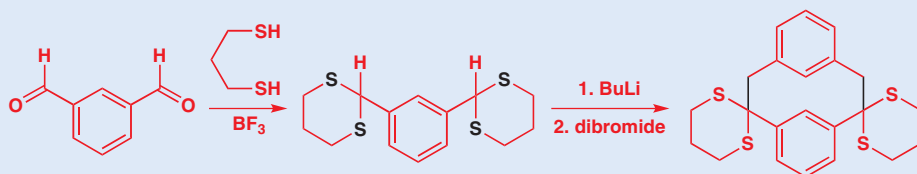

After the dithianes have been alkylated, they can be hydrolysed to give back the carbonyl groups. Alternatively, hydrogenation using Raney nickel replaces the thioacetal with a CH_2 group and gives the unsubstituted cyclophane.

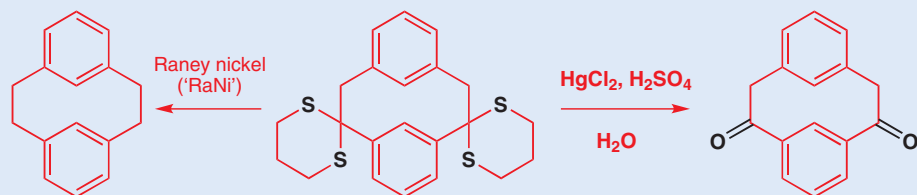

➔ See Chapter 28 for an explanation of these open ‘retrosynthetic’ arrows and the word ‘synthon’.

Dithianes are rather more stable than acetals, and special reagents have to be used to assist their hydrolysis and reveal the hidden carbonyl group. Sulfur is less basic than oxygen, so the protonated species is lower in concentration at a given pH, and the sulfur 3p lone pairs are less able to form a stable π bond to carbon than are the oxygen 2p lone pairs.

poor reaction...

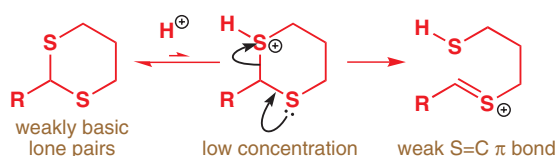

good reaction...

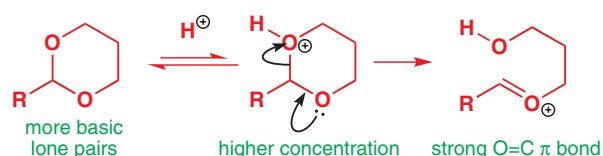

- Sulfur compounds are less basic than oxygen compounds and C=S compounds are less stable than C=O compounds.

The most obvious solution to this problem is to provide a better electrophile than the proton for sulfur. Mercury, Hg(II), is one solution. Another is oxidation of one sulfur to the sulfoxide. Protonation can now occur on the more basic oxygen atom of the sulfoxide and the concentration of the vital intermediate is increased.

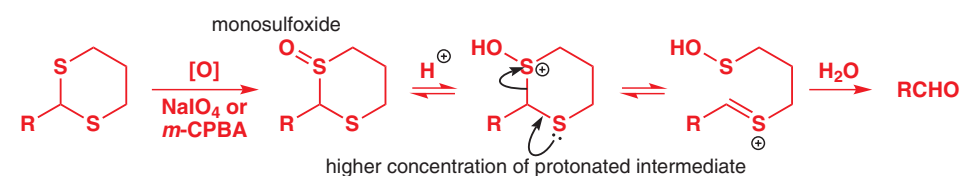

A third solution is methylation, since sulfur is a better nucleophile than oxygen for saturated carbon. The sulfonium salt can decompose in the same way to give the free aldehyde. There are many more methods for hydrolysing dithioacetals and their multiplicity should make you suspicious that none is very good.

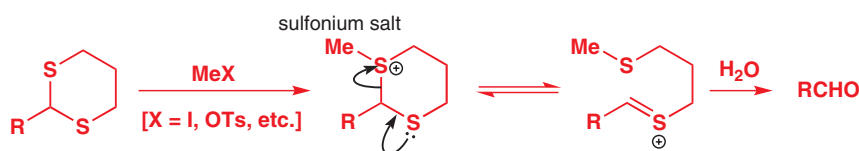

Hydrogenation of C–S bonds in both sulfides and thioacetals is often achieved with **Raney nickel**, the finely divided form of nickel made by dissolving away the aluminium from a powdered nickel–aluminium alloy using alkali. It can be used either as a catalyst for hydrogenation with gaseous hydrogen or as a reagent since it often contains sufficient adsorbed hydrogen (from the reaction of aluminium with alkali) to effect reductions alone. Thioacetalization followed by Raney nickel reduction is a useful way of replacing a C=O group with CH₂.

➔ Raney nickel was introduced on p. 537.

- Dithianes are 'acyl anion equivalents'

A sequence in which a carbonyl group has been masked as a sulfur derivative, alkylated with an electrophile, and then revealed again is a **nucleophilic acylation**. These nucleophilic equivalents of carbonyl compounds are known as **acyl anion equivalents**. In the retrosynthetic terms of Chapter 28 they are d¹ reagents corresponding to the acyl anion synthon.

Anions from sulfones

If the sulfur is at a higher oxidation level, it is much easier to make adjacent anions, and sulfones excel in this regard. The allylic sulfone we made earlier in the chapter (p. 659) can be deprotonated and added to an unsaturated ester to give a cyclopropane. Notice how much weaker a base (MeO[−]) is needed here, as the anion is stabilized by sulfone and alkene.

■ You will see more reactions of this sort in which sulfur has a dual role as anion-stabilizing and as leaving group in the section on sulfonium salts.

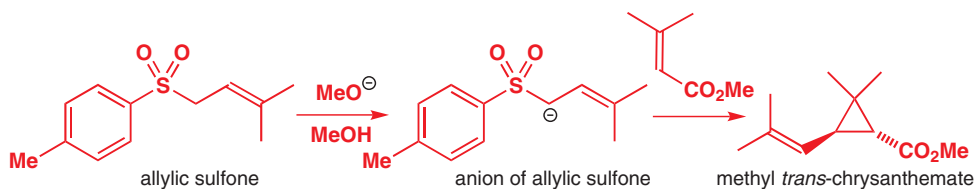

The first step is conjugate addition of the highly stabilized anion. The intermediate enolate then closes the three-membered ring by favourable nucleophilic attack on the allylic carbon. The leaving group is the sulfinate anion and the stereochemistry comes from the most favourable arrangement in the transition state for this ring closure. The product is the methyl ester of the important chrysanthemic acid found in the natural pyrethrum insecticides.

■ In Chapter 22 we established that more stable nucleophiles, and hence more reversible reactions, are likely to favour conjugate addition.

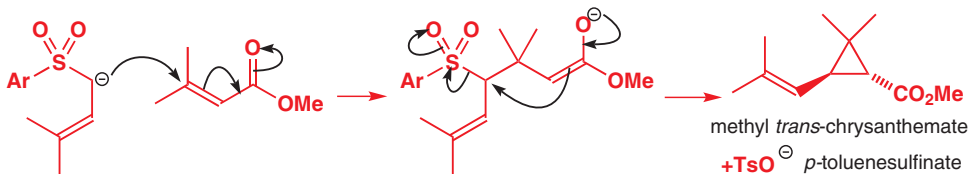

Sulfonium salts

Sulfides are nucleophiles even when not deprotonated—the sulfur atom will attack alkyl halides to form sulfonium salts. This is, of course, a familiar pattern of reactivity for amines, and you have seen phosphonium salts formed in a similar way.

This reaction is an equilibrium and it may be necessary in making sulfonium salts from less reactive sulfides (sterically hindered ones, for example) to use more powerful alkylating agents with non-nucleophilic counterions, for example Me₃O⁺ BF₄[⊖], trimethyloxonium fluoroborate (also known as Meerwein's salt). The sulfur atom captures a methyl group from O⁺, but the reverse does not happen and the BF₄[⊖] anion is not a nucleophile. Not only is dimethyl ether a poor nucleophile, it is also a gas and is lost from the reaction mixture. The same principle is used to make sulfides from other sulfides.

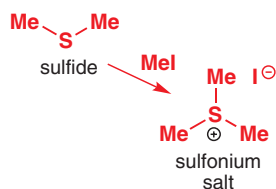

The most important chemistry of sulfonium salts is based on one or both of two attributes:

1. Sulfonium salts are electrophiles: nucleophilic substitution displaces a neutral sulfide leaving group.
2. Sulfonium salts can be deprotonated to give sulfonium ylids.

Sulfonium salts as electrophiles

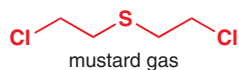

During the First World War, mustard gas was developed as a chemical weapon—it causes the skin to blister and is an intense irritant of the respiratory tract. Its reactivity towards human tissue is related to the following observation and is gruesome testimony to the powerful electrophilic properties of sulfonium ions.



In both cases, intramolecular displacement of the chloride leaving group by the sulfur atom—or, as we should call it, **participation by sulfur**—gives a three-membered cyclic sulfonium ion intermediate (an **episulfonium** or **thiiranium ion**). Nucleophilic attack on this electrophilic sulfonium ion, either by water or by the structural proteins of the skin, is very fast. Of course, mustard gas can react twice in this way. You will see several more examples of reactions in which a sulfonium ion intermediate acts as an electrophile in the next section.

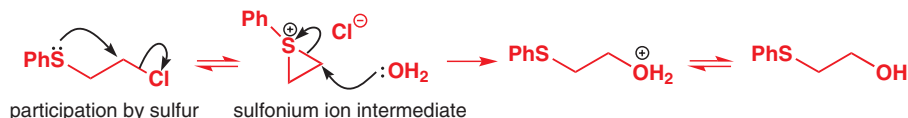

Sulfonium ylids

The positive charge carried by the sulfur atom means that the protons next to the sulfur atom in a sulfonium salt are significantly more acidic than those in a sulfide, and sulfonium salts can be deprotonated to give **sulfonium ylids**.

In Chapter 11 we discussed the Wittig reaction of phosphonium ylids with carbonyl compounds. Sulfonium ylids react with carbonyl compounds too, but in quite a different way—compare these two reactions.

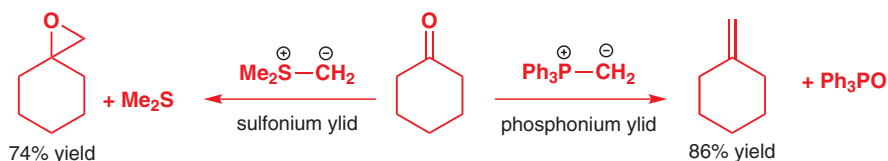

Phosphonium ylids give alkenes while sulfonium ylids give epoxides. Why should this be the case? The driving force in the Wittig reaction is formation of the strong P=O bond—that force is much less in the sulfur analogues (the P=O bond strength in Ph₃PO is 529 kJ mol⁻¹; in Ph₂SO the S=O bond strength is 367 kJ mol⁻¹). The first step is the same in both reactions: the carbanion of the ylid attacks the carbonyl group in a nucleophilic addition reaction. The intermediate in the Wittig reaction cyclizes to give a four-membered ring but this does not happen with the sulfur ylids. Instead, the intermediate decomposes by intramolecular nucleophilic substitution of Me₂S by the oxyanion.

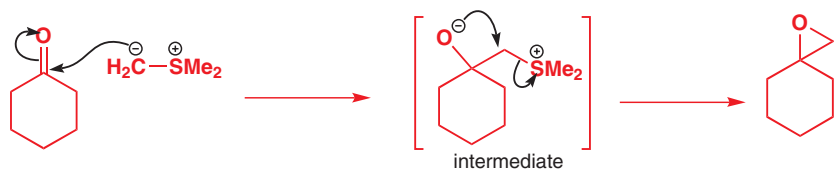

Sulfonium ylids are therefore useful for making epoxides from aldehydes or ketones; other ways you have met of making epoxides (Chapter 19) started with alkenes that might themselves be made with phosphorus ylids.

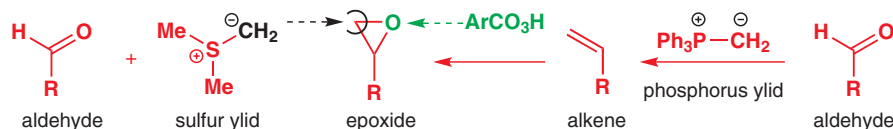

Some chemists working on a route to some potential β -blocker drugs needed the epoxide below, and since 4-cyclopropylbenzaldehyde was more readily available than 4-cyclopropyl styrene, they decided to use the aldehyde as the starting material and make the epoxide in one step using a sulfonium ylid.

► Participation is discussed in detail in Chapter 36.

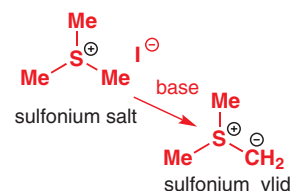

■ A reminder. An **ylid** is a species with positive and negative charges on adjacent atoms.

► The Wittig reaction of phosphonium ylids was introduced on p. 237 and appears again at the end of this chapter, p. 689.

🖱 Interactive mechanism for epoxide formation using sulfonium ylids

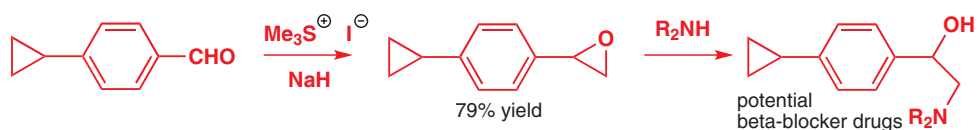

'Stabilized' sulfonium ylids

If there is a conjugating group on the carbanion carbon atom of the ylid, the ylid is more stable and its reactions may change. Firstly, an example where the ylid is stabilized by a cyanide. As you have just seen, the simple sulfonium ylid gives the epoxide from this α,β -unsaturated ketone. But the 'stabilized' ylid gives the cyclopropane instead.

➔ You saw similar reactions of enolates to form epoxides (the Darzens reaction) and cyclopropanes in Chapter 26.

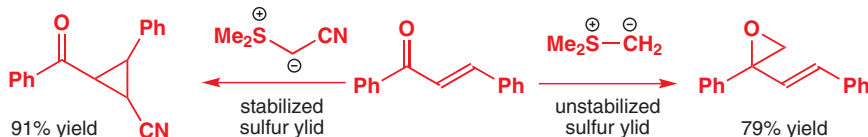

In the absence of the conjugated alkene, both types of ylid give epoxides—the ester-stabilized ylid, for example, reacts with the diketone known as benzil to give an epoxide but with methyl vinyl ketone (but-3-en-2-one) to give a cyclopropane.

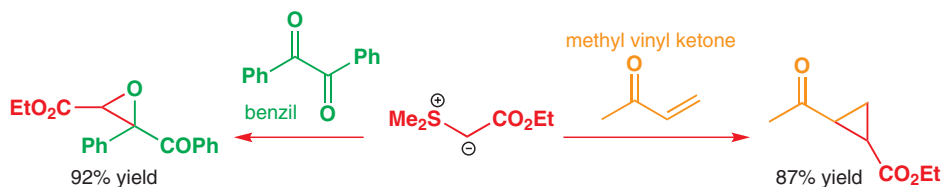

Why does the stabilized ylid prefer to react with the double bond? The enone has two electrophilic sites, but from Chapter 22, in which we discussed the regioselectivity of attack of nucleophiles on Michael acceptors like this, you would expect that direct 1,2-attack on the ketone is the faster reaction. This step is irreversible, and subsequent displacement of the sulfide leaving group by the alkoxide produces an epoxide. Whether a cyclopropane product would have been more stable is irrelevant to the outcome: the epoxide forms faster and is therefore the kinetic product.

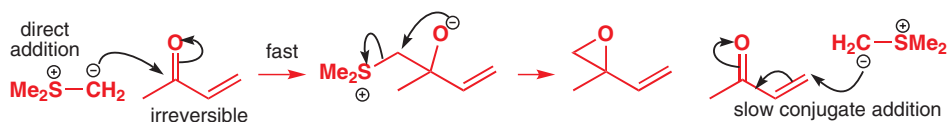

With a stabilized ylid, direct addition to the carbonyl group is, in fact, probably still the faster reaction. But in this case, the starting materials are sufficiently stable that the reaction is reversible, and the sulfonium ylid is re-expelled before the epoxide has a chance to form. Meanwhile, some ylid adds to the ketone in a 1,4 (Michael or conjugate) fashion. 1,4-Addition, although slower, is energetically more favourable because the new C–C bond is gained at the expense of a (relatively) weak C=C π bond rather than a (relatively) strong C=O π bond, and is therefore irreversible. Eventually, all the ylid ends up adding in a 1,4-fashion, generating an enolate as it does so, which cyclizes to give the cyclopropane, which is the thermodynamic product. This is another classic example of kinetic versus thermodynamic control, and you can add it to your mental list of examples.

➔ Other examples can be found on pp. 266 and 505.

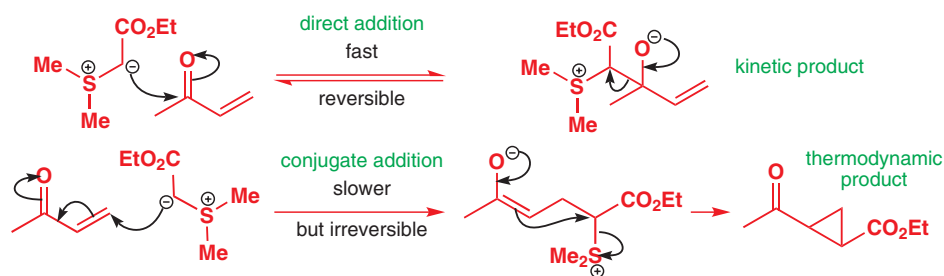

Sulfoxonium ylids

There is another, very important, class of stabilized sulfur ylids that owe their stability not to an additional anion-stabilizing substituent but to a more anion-stabilizing sulfur group. These are the **sulfoxonium ylids**, made from dimethylsulfoxide by S_N2 substitution with an alkyl halide. Note that the sulfur atom is the nucleophile rather than the oxygen atom in spite of the charge distribution. The high-energy sulfur lone pair is better at S_N2 substitution at saturated carbon—a reaction that depends very little on charge attraction (Chapter 15).

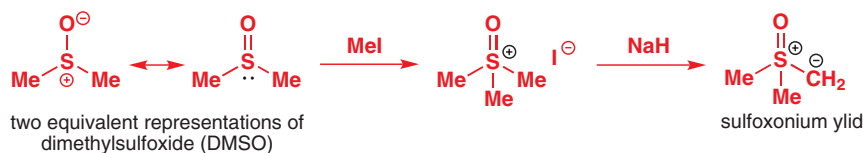

Sulfoxonium ylids react with unsaturated carbonyl compounds in the same way as the stabilized ylids that you have met already—they form cyclopropanes rather than epoxides. The example below shows one consequence of this reactivity pattern—by changing from a sulfonium to a sulfoxonium ylid, high yields of either epoxide or cyclopropane can be formed from an unsaturated carbonyl compound (this one is the terpene known as carvone).

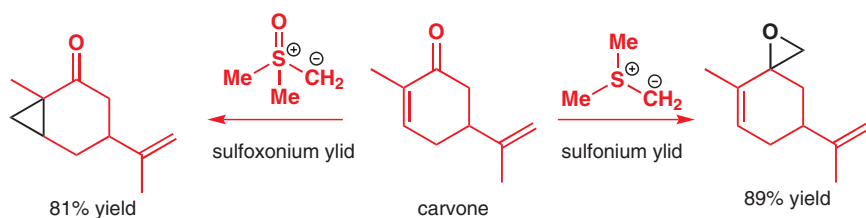

Interactive mechanism for three-membered ring formation with sulfonium and sulfoxonium ylids

The Swern oxidation

This important reaction featured briefly in Chapter 23 as an important method of oxidizing alcohols to aldehydes. We said there that we would discuss this interesting reaction later and now is the time.

the Swern oxidation

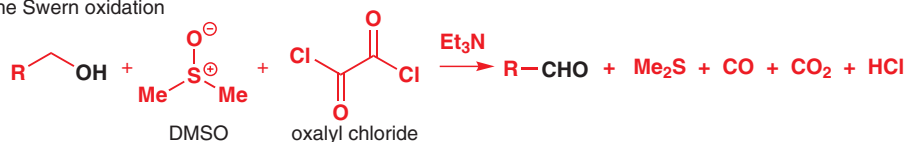

Turn to p. 545 for a comparison of the Swern oxidation with other similar methods.

In the first step, DMSO reacts with oxalyl chloride to give an electrophilic sulfur compound. You should not be surprised that it is the charged oxygen atom that attacks the carbonyl group rather than the soft sulfur atom. Chloride is released in this acylation and it attacks the positively charged sulfur atom, expelling a remarkable leaving group that fragments into three pieces: CO_2 , CO , and a chloride ion. Entropy favours this reaction.

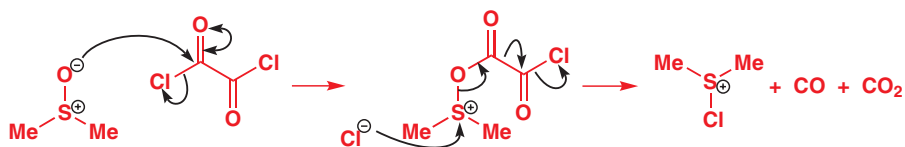

The alcohol has been a spectator in these events so far but the chlorosulfonium ion now formed can react with it to give a new sulfonium salt. This is the sole purpose of all the reactions up to this point. This sulfonium salt is deprotonated by the base (Et_3N) to form an ylid. The final step completes the redox reaction: the transfer of a proton to the anionic carbon gives an aldehyde, with overall reduction of dimethylsulfoxide (DMSO) to dimethylsulfide (DMS).

 Interactive mechanism of the Swern oxidation of alcohols

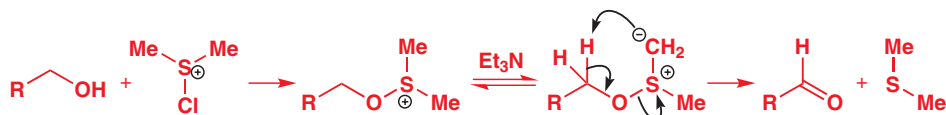

 In Chapter 35 you will learn to call this last step a pericyclic reaction.

Silicon and carbon compared

Silicon is immediately below carbon in the periodic table and the most obvious similarity is that both elements normally have a valency of four and both form tetrahedral compounds. There are important differences in the chemistry of carbon and silicon—silicon is less important and many books are devoted solely to carbon chemistry but relatively few to silicon chemistry. Carbon forms many stable trigonal and linear compounds containing π bonds; silicon forms few. The most important difference is the strength of the silicon–oxygen σ bond (368 kJ mol^{-1}) and the relative weakness of the silicon–silicon (230 kJ mol^{-1}) bond. Together these values account for the absence, in the oxygen-rich atmosphere of earth, of silicon analogues of the plethora of structures possible with a carbon skeleton.

Average bond energies, kJ mol^{-1}

X	H–X	C–X	O–X	F–X	Cl–X	Br–X	I–X	Si–X
C	416	356	336	485	327	285	213	290
Si	323	290	368	582	391	310	234	230
ratio	1.29	1.23	0.91	0.83	0.84	0.92	0.91	1.26

Several of the values in the table give insight into the reactivity differences between carbon and silicon. Bonds to electronegative elements are generally stronger with silicon than with carbon; in particular, the silicon–fluorine bond is one of the strongest single bonds known, while bonds to electropositive elements are weaker. Silicon–hydrogen bonds are much weaker than their carbon counterparts and can be cleaved easily. Here are a few organosilicon compounds.

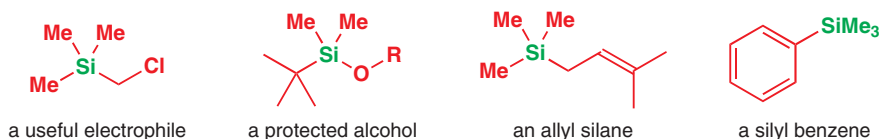

In this section we will mostly discuss compounds with four Si–C bonds. Three of these bonds will usually be the same so we will often have a Me_3Si group attached to an organic molecule. We shall discuss reactions in which something interesting happens to the organic molecule as one of the Si–C bonds reacts to give a new Si–F or Si–O bond. We shall also discuss organosilicon compounds as reagents, such as triethylsilane (Et_3SiH), which is a reducing agent whereas $\text{Et}_3\text{C–H}$ is not.

The carbon–silicon bond is strong enough for the trialkyl silyl group to survive synthetic transformations on the rest of the molecule but weak enough for it to be cleaved specifically when we want. In particular, fluoride ion is a poor nucleophile for carbon compounds but attacks silicon very readily. Another important factor is the length of the C–Si bond (1.89 Å)—it is significantly longer than a typical C–C bond (1.54 Å). Silicon has a lower electronegativity (1.8) than carbon (2.5) and therefore C–Si bonds are polarized towards the carbon. This makes the silicon susceptible to attack by nucleophiles. The strength of the C–Si bond means that alkyl silanes are stable but the most useful chemistry arises from carbon substituents other than simple alkyl groups.

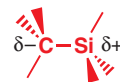

Silicon has an affinity for electronegative atoms

The most effective nucleophiles for silicon are the electronegative ones that will form strong bonds to silicon. Those based on oxygen or halide ions (chloride and fluoride) are pre-eminent. You saw this in the choice of reagent for the selective cleavage of silyl ethers in Chapter 23. Tetrabutylammonium fluoride is often used as this is an organic-soluble ionic fluoride and forms a silyl fluoride as the by-product. The mechanism is not a simple S_N2 process and has no direct analogue in carbon chemistry. It looks like a substitution at a hindered tertiary centre, which ought to be virtually impossible. Two characteristics of silicon facilitate the process: the long silicon–carbon bonds relieve the steric interactions and the d orbitals of silicon provide a target for the nucleophile that does not have the same geometric constraints as a C–O σ^* orbital.

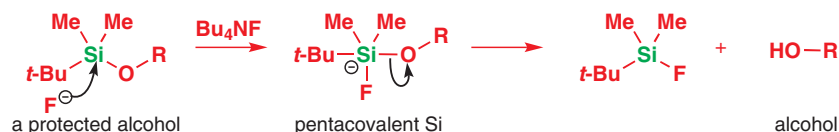

Attack of the fluoride on the empty d orbital leads to a negatively charged pentacoordinate intermediate that breaks down with loss of the alkoxide. The discrete pentacoordinate trigonal bipyramid intermediate contrasts with the similarly shaped pentacoordinate transition state of a carbon-based S_N2 reaction. It is often omitted in mechanistic schemes because it is formed slowly and decomposes quickly, and the mechanism is still referred to as ' S_N2 at silicon'.

- Silicon forms strong bonds with oxygen and very strong bonds with fluorine.

Nucleophilic substitution at silicon

You may wonder why trimethylsilyl chloride does not use the S_N1 mechanism familiar from the analogous carbon compound *t*-butyl chloride. There is, in fact, nothing wrong with the Me_3Si^+ cation—it can be detected in mass spectra, for example. The reason is simply that the ' S_N2 ' reaction at silicon is too good for S_N1 to compete.

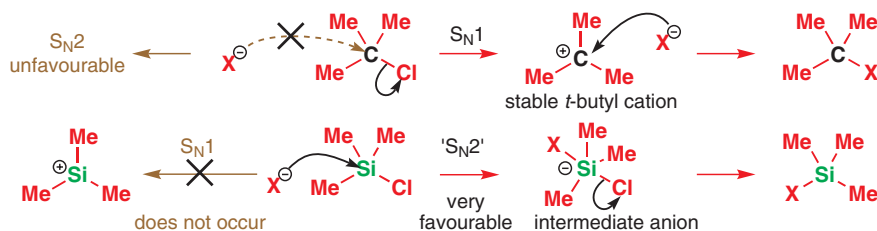

There are some important differences between the S_N2 substitutions at Si and at C. Alkyl halides are soft electrophiles but silyl halides are hard electrophiles. Alkyl halides react only very slowly with fluoride ion but silyl halides react more rapidly with fluoride than with any other nucleophile. The best nucleophiles for saturated carbon are neutral or based on elements down the periodic table (S, Se, I) or both. The best nucleophiles for silicon are charged and based on highly electronegative atoms (chiefly F, Cl, and O). A familiar example is the reaction of enolates at carbon with alkyl halides but at oxygen with silyl chlorides (Chapter 20).

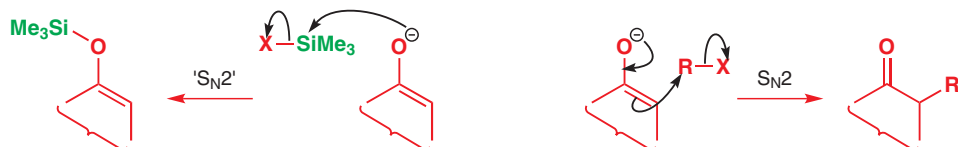

When a Me_3Si group is removed from an organic molecule with hydroxide ion, the product is not the silanol as you might expect but the silyl ether 'hexamethyldisiloxane'.



The other side of the coin is that the $\text{S}_{\text{N}}2$ reaction at carbon is *not* much affected by partial positive charge (δ^+) on the carbon atom. The ' $\text{S}_{\text{N}}2$ ' reaction at silicon *is* affected by the charge on silicon. The most electrophilic silicon compounds are the silyl triflates and it is estimated that they react some 10^8 – 10^9 times faster with oxygen nucleophiles than do silyl chlorides. Trimethylsilyl triflate is, in fact, an excellent Lewis acid and can be used to form acetals or silyl enol ethers from carbonyl compounds, and to react these two together in aldol-style reactions. In all three reactions the triflate attacks an oxygen atom. In the acetal formation, silylation occurs twice at the carbonyl oxygen atom and the final leaving group is hexamethyldisiloxane. You should compare this with the normal acid-catalysed mechanism described in Chapter 11, where the carbonyl group is twice protonated and the leaving group is water.

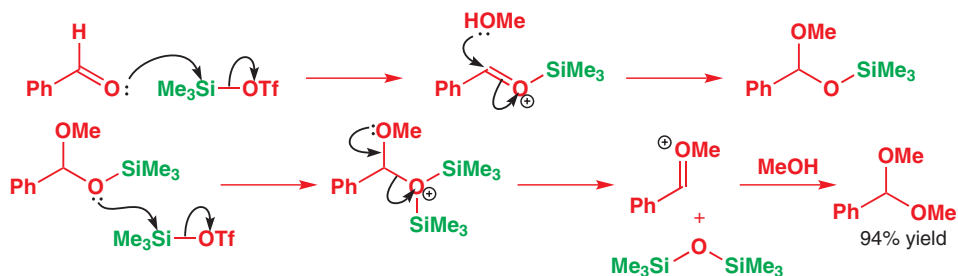

Silyl ethers are versatile protecting groups for alcohols

Silicon-based protecting groups for alcohols are the best because they are the most versatile. They are removed by nucleophilic displacement with fluoride or oxygen nucleophiles and the rate of removal depends mostly on the steric bulk of the silyl group. The simplest is trimethylsilyl (Me_3Si or often just TMS), which is also the most easily removed as it is the least hindered. In fact, it is removed so easily by water with a trace of base or acid that special handling is required to keep this labile group in place. These protecting groups are discussed in Chapter 23.

Replacement of the one of the methyl groups with a much more sterically demanding tertiary butyl group gives the *t*-butyldimethylsilyl (TBDMS) group, which is stable to normal handling and survives aqueous work-up or column chromatography on silica gel. The stability to these isolation and purification conditions has made TBDMS (sometimes over-abbreviated to TBS) a very popular choice for organic synthesis. TBDMS is introduced by a substitution reaction on the corresponding silyl chloride with imidazole in DMF. Yields are usually virtually quantitative and the conditions are mild. Primary alcohols are protected in the presence of secondary alcohols. Removal relies on the strong affinity of fluoride for silicon and is usually very efficient and selective.

However, a protecting group is useful only if it can be introduced and removed in high yield without affecting the rest of the molecule and if it can survive a wide range of conditions in the course of the synthesis. The extreme steric bulk of the *t*-butyldiphenylsilyl (TBDPS) group makes it useful for selective protection of unhindered primary alcohols in the presence of secondary alcohols.

The most stable common silyl protecting group (triisopropylsilyl or TIPS) has three branched alkyl substituents to protect the central silicon from attack by nucleophiles, which would lead to cleavage. All three hindered silyl groups (TBDMS, TBDPS, and TIPS) have excellent stability but can still be removed with fluoride.

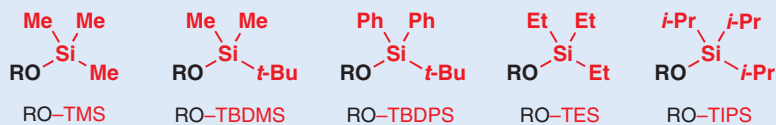

The Peterson elimination

There are many reactions in organic chemistry in which an Me_3Si group acts like a proton. Just as acidic protons are removed by bases, silicon is readily removed by hard nucleophiles, particularly F^- or RO^- , and this can promote an elimination. An example is shown here.

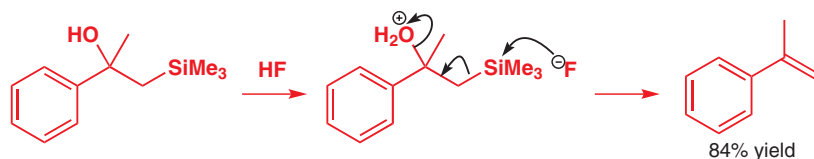

Interactive mechanism for Peterson elimination

This reaction is known as the **Peterson elimination**. It is rather like those we discussed in Chapter 17—eliminations of alcohols under acidic conditions to give alkenes. But, unlike those reactions, it is fully regioselective and so is particularly useful for making double bonds where other elimination methods might give the wrong regioisomer or mixtures of regioisomers. In this next example only one product is formed, in high yield, and it has an exocyclic double bond. Just think what would have happened without the silicon atom (ignore the one attached to the oxygen—that's just a protecting group). This compound is, in fact, an intermediate in a synthetic route to the important anticancer compound Taxol.

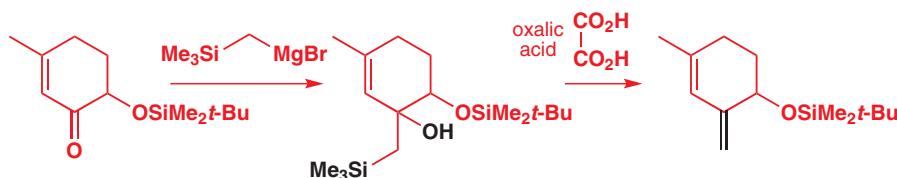

The Peterson reaction is particularly useful for making terminal or exocyclic double bonds connectively because the starting material (the magnesium derivative shown above) is easily made from available $\text{Me}_3\text{SiCH}_2\text{Br}$.

Alkynyl silanes are used for protection and activation

Terminal alkynes have an acidic proton ($\text{p}K_a$ ca. 25) that can be removed by very strong bases such as organometallic reagents (Grignards, RLi , etc.). While this is often what is intended, in other circumstances it may be an unwanted side reaction that would consume an organometallic reagent or interfere with the chosen reaction. Exchange of the terminal proton of an alkyne for a trimethylsilyl group exploits the relative acidity of the proton and provides a neat solution to these problems. The SiMe_3 group protects the terminus of the alkyne during the reaction but can then be removed with fluoride or sodium hydroxide. A classic case is the removal of a proton next door to a terminal alkyne.

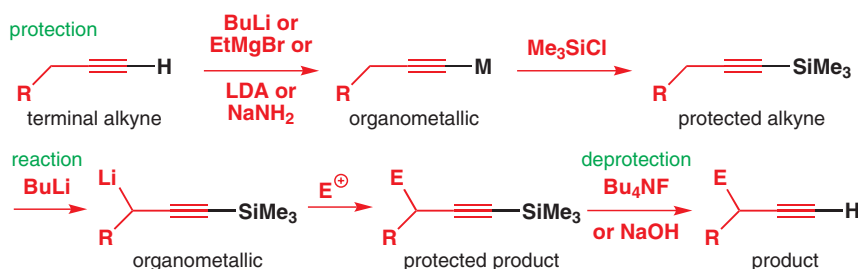

■ The position 'next door' to an alkyne is sometimes called a 'propargylic' position. Propargyl alcohol is $\text{HC}\equiv\text{CCH}_2\text{OH}$.

➔ Alkynyl lithiums and Grignards were made in this way in Chapter 9.

Additionally, acetylene itself is a useful two-carbon building block but is not very convenient to handle as it is an explosive gas. Trimethylsilylacetylene is a distillable liquid that is a convenient substitute for acetylene in reactions involving the lithium derivative as it has only one acidic proton. The synthesis of this alkynyl ketone is an example. Deprotonation with butyl lithium provides the alkynyl lithium that reacted with the alkyl chloride in the presence of iodide as nucleophilic catalyst (see Chapter 15). Removal of the trimethylsilyl

group with potassium carbonate in methanol allowed further reaction on the other end of the alkyne.

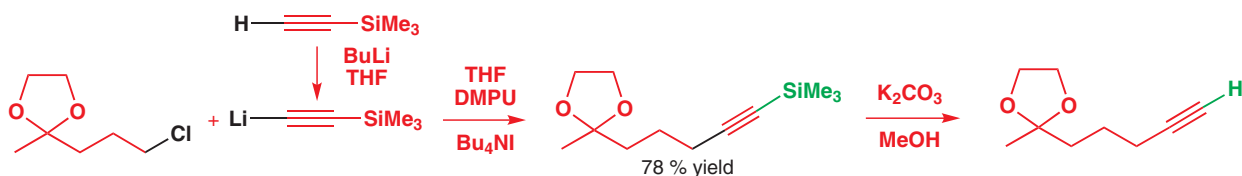

Silicon stabilizes a positive charge on the β carbon

In common with ordinary alkynes, silylated alkynes are nucleophilic towards electrophiles. The presence of the silicon has a dramatic effect on the regioselectivity of this reaction: attack occurs only at the atom directly bonded to the silicon. This must be because the intermediate cation is stabilized.

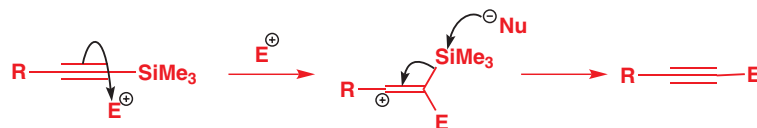

➔ This was explained in Chapter 15.

The familiar hierarchy of carbocation stability—tertiary > secondary > primary—is due to the stabilization of the positive charge by donation of electron density from adjacent C–H or C–C bonds (their filled σ orbitals to be precise) that are aligned correctly with the vacant orbital. The electropositive nature of silicon makes C–Si bonds even more effective donors: a silyl group β to a positive charge (i.e. attached to the next-door carbon) stabilizes a positive charge so effectively that the course of a reaction involving cationic intermediates is often completely controlled. This is stabilization by σ donation.

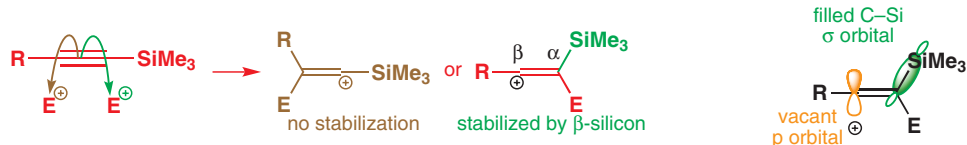

■ The nucleophile does not need to be very powerful because of the weakening of the C–Si bond. Many neutral molecules with a lone pair and almost any anion will do, even triflate ($\text{CF}_3\text{SO}_2\text{O}^-$).

The stabilization of the cation also weakens the C–Si bond by delocalization so that the bond is more easily broken. Attack of a nucleophile (particularly a halogen or oxygen nucleophile) on silicon removes it from the organic fragment and the net result is electrophilic substitution in which the silicon has been replaced by the electrophile.

This is useful for the synthesis of alkynyl ketones, which are difficult to make directly with conventional organometallic reagents such as alkynyl–Li or –MgBr because they add a second time to the ketone product. Alkynyl silanes react in a Friedel–Crafts manner with acid chlorides in the presence of Lewis acids, such as aluminium chloride, to give the ketones.

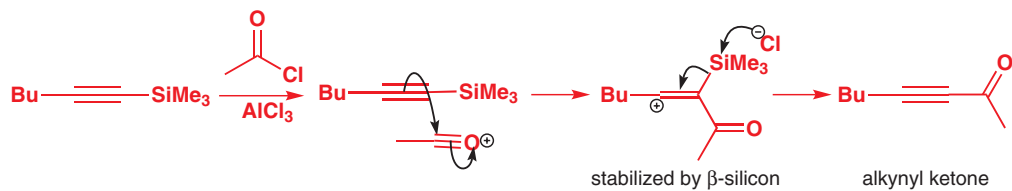

Aryl silanes undergo *ipso* substitution with electrophiles

Exactly the same sort of mechanism accounts for the reactions of aryl silanes with electrophiles under Friedel–Crafts conditions. Instead of the usual rules governing *ortho*, *meta*, and *para* substitution using the directing effects of the substituents, there is just one rule: the silyl group is replaced by the electrophile at the same atom on the ring—this is known as *ipso*

substitution. Actually, this selectivity comes from the same principles as those used for ordinary aromatic substitution (Chapter 21): the electrophile reacts to produce the most stable cation—in this case β to silicon. Cleavage of the weakened C–Si bond by any nucleophile leads directly to the *ipso* product.

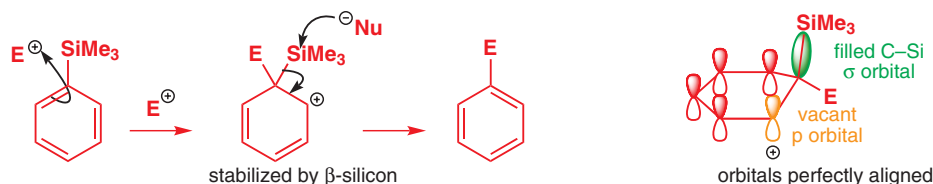

There is an alternative site of attack *meta* to silicon that would lead to a cation β to Si. But this cation is not particularly stable because the vacant p orbital is orthogonal to the C–Si bond and so cannot interact with it as the C–Si bond is still in the plane of the ring. This illustrates that it is more important to understand the origin of the effect based on molecular orbitals rather than simply to remember the result.



This reactivity of aryl silanes is used to convert stable phenyldimethylsilyl compounds into more reactive compounds such as alcohols by a reaction such as that shown in the margin. Several reagents can be used, all of which induce *ipso* substitution of the phenyl silane. The reaction with bromine is typical. Bromobenzene is produced together with a silyl bromide that is activated towards subsequent oxidation.

The mechanism of electrophilic desilylation is the same as that for electrophilic aromatic substitution except that the proton is replaced by the trimethylsilyl group. The silicon stabilizes the intermediate cation, and hence the transition state leading to it, to such an extent that the rate is many orders of magnitude faster. This is the first step with bromine.

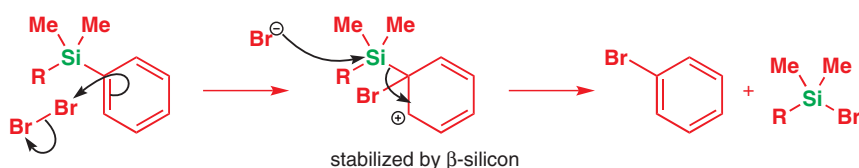

The rest of the reaction sequence involves displacement of Br^- by HOO^- , addition of hydroxide, rearrangement, and hydrolysis.

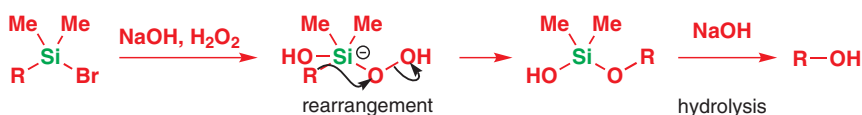

● Trimethylsilyl and other silyl groups stabilize a positive charge on a β carbon and are lost very easily. They can be thought of as very reactive protons or 'super protons'.

Vinyl silanes offer a regio- and stereoselective route to alkenes

Vinyl silanes react with electrophiles in a similarly regioselective process in which the silicon is replaced by the electrophile at the *ipso* carbon atom. The stereochemistry of the vinyl silane is important because this exchange usually occurs with retention of geometry as well.

■ The Latin word *ipso* means 'itself'—the *self same* site as that occupied by the SiR_3 group. A reminder:

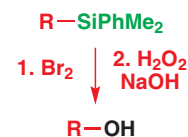
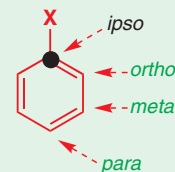

■ A group of similar Si to OH conversions are known as Fleming–Tamao oxidations, after the two independent discoverers.

➔ This mechanism should remind you of the mechanism of the oxidation of boranes, which often follows on from hydroboration—see Chapter 19, p. 446.



This is a curious and interesting reaction that deserves explanation. Addition of the electrophile next to silicon leads to the more stable cation β to silicon. In the vinyl silane the C–Si bond is orthogonal to the p orbitals of the π bond, but as the electrophile attacks the π bond, say from underneath, the Me_3Si group starts to move upwards. As it rotates, the angle between the C–Si bond and the remaining p orbital decreases from 90° . As the angle decreases, the interaction between the C–Si bond and the empty p orbital of the cation increases. There is every reason for the rotation to continue in the same direction and no reason for it to reverse. The diagram shows that, in the resulting cation, the electrophile is in the position formerly occupied by the Me_3Si group, *trans* to Ph. Loss of the group now gives retention of stereochemistry.

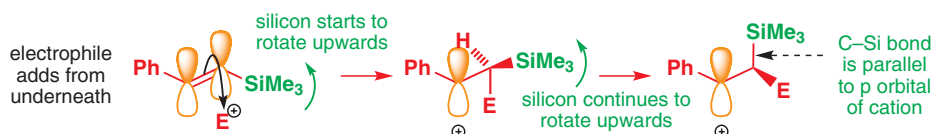

The intermediate cation has only a single bond and so rotation might be expected to lead to a mixture of geometrical isomers of the product but this is not observed. The bonding interaction between the C–Si bond and the empty p orbital means that rotation is restricted. This stabilization weakens the C–Si bond and the silyl group is quickly removed before any further rotation can occur. The stabilization is effective only if the C–Si bond is correctly aligned with the vacant orbital, which means it must be in the same plane—rather like a π bond. Here is the result for both *E* and *Z* isomers of the vinyl silane.

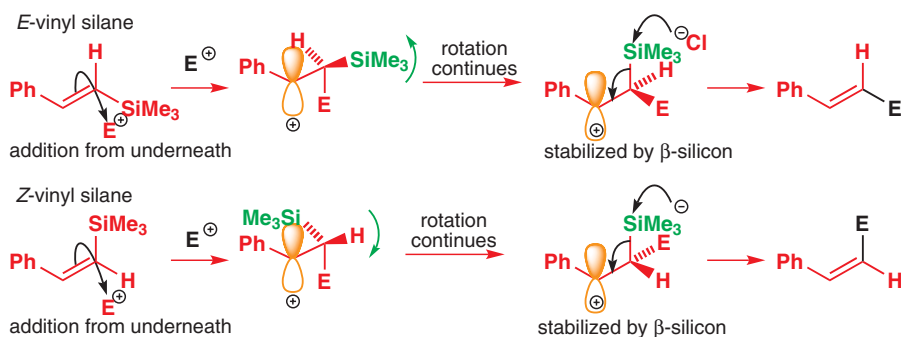

Interactive mechanism for reaction of vinyl silanes with electrophiles

■ Geometrically pure vinyl halides are important starting materials for transition-metal-catalysed alkene synthesis (Chapter 40).

It is unusual for silicon to be required in the final product of a synthetic sequence and the stereospecific removal of silicon from vinyl silanes makes them useful reagents that can be regarded as rather stable vinylic organometallic reagents that will react with powerful electrophiles, preserving the double bond location and geometry. Protodesilylation, as the process of replacing silicon with a proton is known, is one such important reaction. The halogens are also useful electrophiles while organic halides, particularly acid chlorides, in the presence of Lewis acids, form vinyl halides and unsaturated ketones of defined geometry.

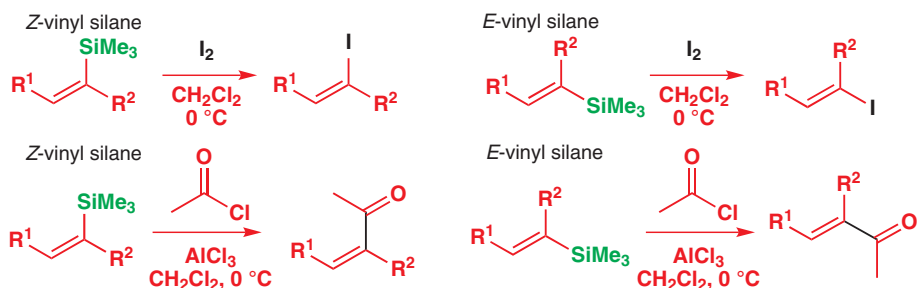

Allyl silanes as nucleophiles

If the silyl group is moved along the carbon chain by just one atom, an allyl silane results. Allyl silanes can be produced from allyl organometallic reagents but there is often a problem over which regioisomer is produced and mixtures often result. Better methods control the position of the double bond. Two useful examples take advantage of the Wittig reaction and the Peterson elimination to construct the alkene linkage. The reagents are prepared from trimethylsilyl halides either by formation of the corresponding Grignard reagent or alkylation with a primary Wittig reagent and deprotonation to form a new ylid. The Grignard reagent, with added cerium trichloride, adds twice to esters to give the corresponding tertiary alcohol, which loses one of its Me_3Si groups in a Peterson elimination to reveal the remaining Me_3Si group as part of allyl silane.

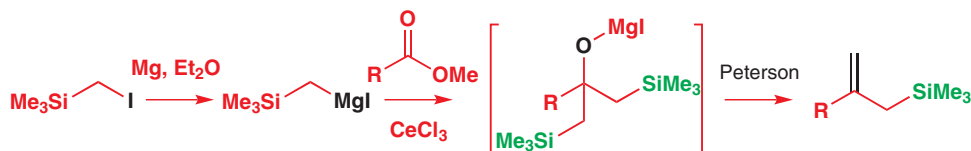

The Wittig reagent is made by alkylation of the simplest ylid with the same silicon reagent. Notice that the leaving group (iodide) is on the carbon next to silicon, not on the silicon itself. Anion formation occurs next to phosphorus because Ph_3P^+ is much more anion-stabilizing than Me_3Si . The ylid reacts with carbonyl compounds such as cyclohexanone in the usual way to produce the allyl silane with no ambiguity over which end of the allyl system is silylated.

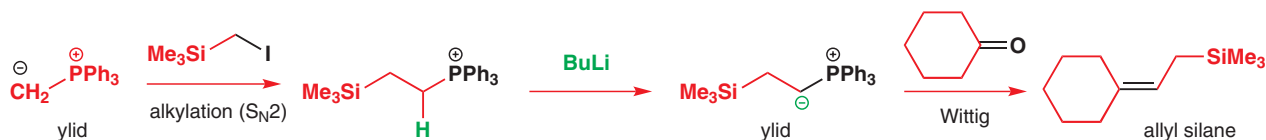

The carbon–silicon bond has two important effects on the adjacent alkene. The presence of a high-energy filled σ orbital of the correct symmetry to interact with the π system produces an alkene that is more reactive with electrophiles, due to the higher-energy HOMO, and the same σ orbital stabilizes the carbocation if attack occurs at the remote end of the alkene. This lowers the transition state for electrophilic addition and makes allyl silanes much more reactive than isolated alkenes.

Allyl silanes are more reactive than vinyl silanes but also react through β -silyl cations

Vinyl silanes have C–Si bonds orthogonal to the p orbitals of the alkene—the C–Si bond is in the nodal plane of the π bond—so there can be no interaction between the C–Si bond and the π bond. Allyl silanes, by contrast, have C–Si bonds that can be, and normally are, parallel to the p orbitals of the π bond so that interaction is possible.

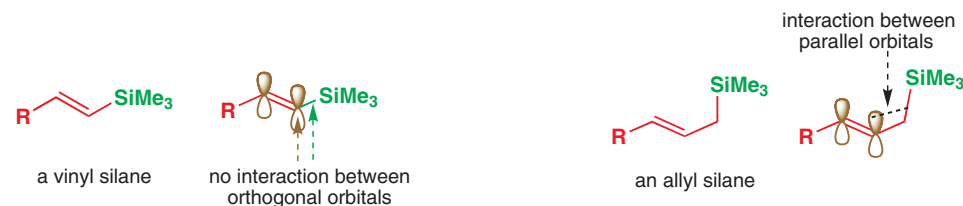

Allyl silanes react with electrophiles with even greater regioselectivity than that of vinyl silanes. The cation β to the silyl group is again formed but there are two important differences. Most obviously, the electrophile attacks at the other end of the allylic system and there is no rotation necessary as the C–Si bond is already in a position to overlap efficiently with the intermediate cation. The process is terminated by loss of silicon in the usual way to regenerate an alkene.

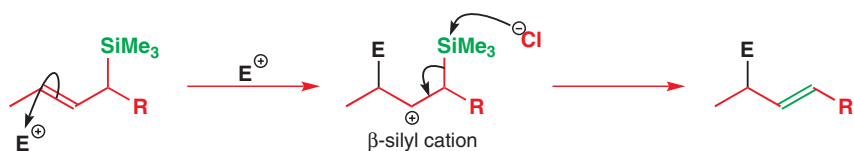

Molecular orbitals demonstrate the smooth transition from the allyl silane, which has a π bond and a C–Si σ bond, to the allylic product with a new π bond and a new σ bond to the electrophile. The intermediate cation is mainly stabilized by σ donation from the C–Si bond into the vacant p orbital but it has other σ -donating groups (C–H, C–C, and C–E) that also help. The overall process is electrophilic substitution with allylic rearrangement. Both the site of attachment of the electrophile and the position of the new double bond are dictated by the silicon.

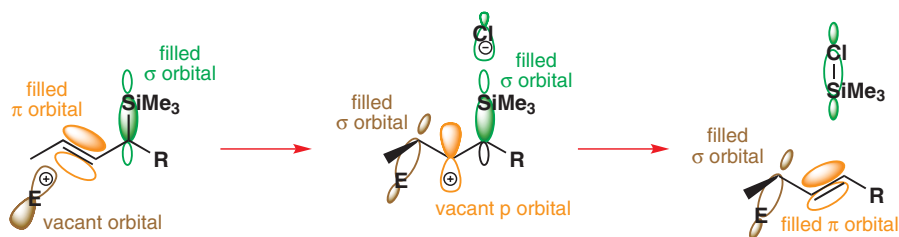

Allyl silanes are rather like silyl enol ethers: they react with electrophiles, provided they are activated, for example by a Lewis acid. Titanium tetrachloride is widely used but other successful Lewis acids include boron trifluoride, aluminium chloride, and trimethylsilyl triflate. Electrophiles include acylium ions produced from acid chlorides, carbocations from tertiary halides or secondary benzylic halides, activated enones, and epoxides all in the presence of Lewis acid. In each case the new bond is highlighted in black.

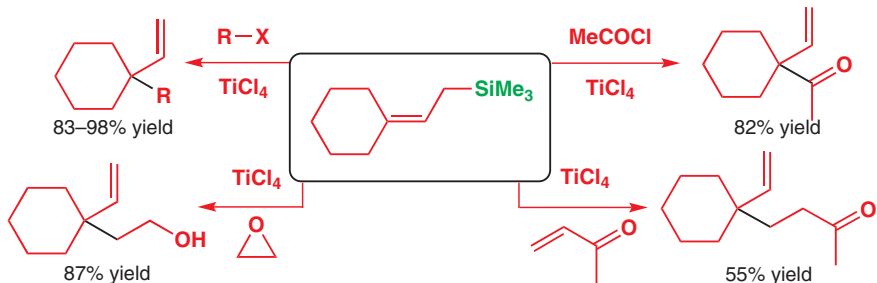

• β -Silyl cations are important intermediates

Vinyl and aryl silanes react with electrophiles at the same (*ipso* or α) atom occupied by silicon. Allyl silanes react at the end of the alkene furthest from silicon (γ). In both cases a β -silyl cation is an intermediate.

Lewis acids promote couplings via oxonium ions

■ Homoallylic means allylic plus one carbon.

Allyl silanes will also attack carbonyl compounds when they are activated by coordination of the carbonyl oxygen atom to a Lewis acid. The Lewis acid, usually a metal halide such as $TiCl_4$ or $ZnCl_2$, activates the carbonyl compound by forming an oxonium ion with a metal–oxygen bond. The allyl silane attacks in the usual way and the β -silyl cation is desilylated with the halide ion. Hydrolysis of the metal alkoxide gives a homoallylic alcohol.

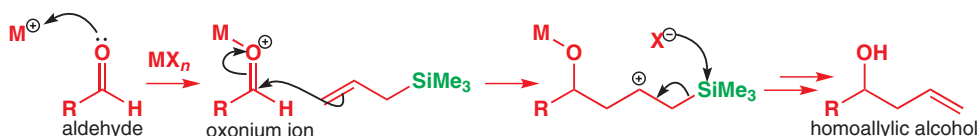

A closely related reactive oxonium ion can be prepared by Lewis acid catalysed breakdown of the corresponding acetal. Alternatively, especially if the acetal is at least partly a silyl acetal, the same oxonium ion can be produced *in situ* using yet more silicon in the form of TMSOTf as the Lewis acid catalyst. All these intermediate oxonium ions act as powerful electrophiles towards allyl silanes, producing homoallylic alcohols or ethers.

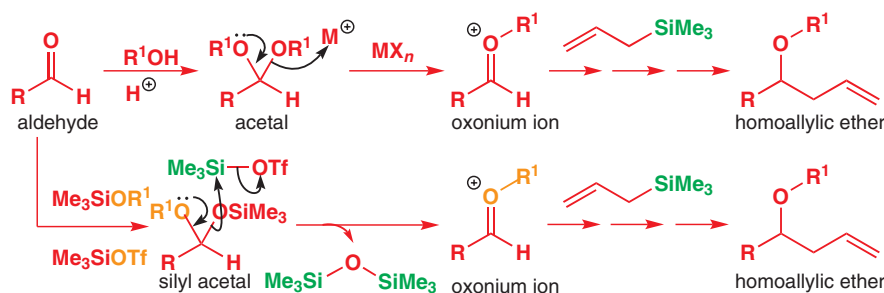

■ Note how the Me₃Si group mimics the behaviour of a proton even to the extent of producing (Me₃Si)₂O—the silicon analogue of water.

The regiocontrol that results from using an allyl silane to direct the final elimination is illustrated by this example of an intramolecular reaction on to an acetal promoted by tin tetrachloride. The same reaction can be run in the absence of silicon but the intermediate cation can then lose a range of protons to produce five different products!

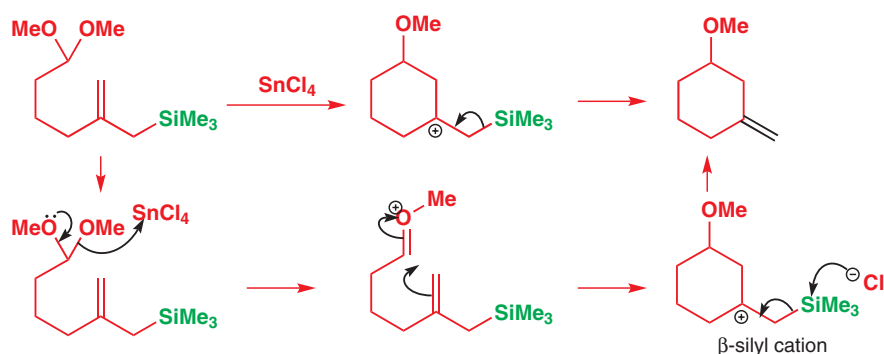

The selective synthesis of alkenes

S, Si, P, and other main group elements have several important functions in organic chemistry, and one in which all of S, Si, and P each play a star role is in the synthesis of alkenes. You have met alkenes participating in reactions in a number of chapters, but our discussion of how to *make* alkenes has so far been quite limited. Chapter 17 was about elimination reactions, and there you met E1 and E2 reactions. You had a glimpse of the importance of phosphorus in alkene synthesis in Chapter 11, where you met the Wittig reaction, and earlier in this chapter you saw silicon participating in the Peterson elimination. We're now going to look at related reactions in more detail, addressing especially how to form alkenes with control over their *geometry*. First we need to establish that this is an important task and remind you of some reactions you have already met that can be used for it.

The properties of alkenes depend on their geometry

Geometrical isomers of alkenes are different compounds with different physical, chemical, and biological properties. They are often hard to separate by chromatography or distillation, so it is important that chemists have methods for making them as single isomers.

Different physical properties: maleate and fumarate

These two compounds, *Z*- and *E*-dimethyl but-2-enedioate, are commonly known as dimethyl maleate and dimethyl fumarate. They provide a telling example of how different the physical properties of geometrical isomers can be. Dimethyl maleate is a liquid with a boiling point of 202°C (it melts at -19°C), while dimethyl fumarate is a crystalline compound with a melting point of 103–104°C.

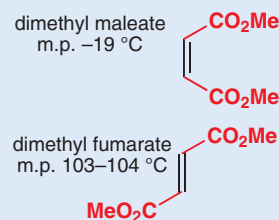

Different biological properties: juvenile hormone as a pest control

If insect pests can be prevented from maturing they fail to reproduce and can thus be brought under control. Juvenile insects control their development by means of a 'juvenile hormone', one of which is the monoepoxide of a triene:

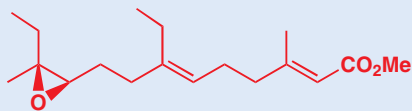

cecropia juvenile hormone: activity = 1000

Synthetic analogues of this compound, such as the trienes below, are also effective at arresting insect development, *providing that the double bond geometry is controlled*. The *Z,E,E* geometrical isomer of the triene is over twice as active as the *E,E,E* isomer, and over 50 times as active as the *Z,Z,E* or *Z,E,Z* isomers.

activity of juvenile hormone analogues (natural hormone = 1000)

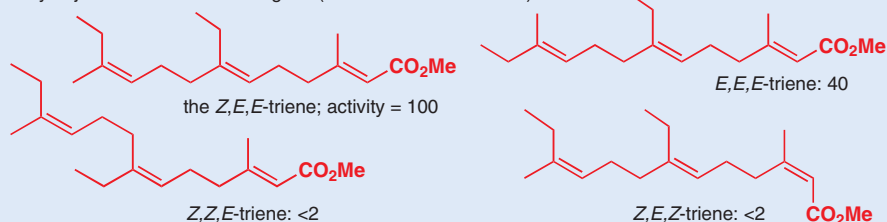
**Elimination reactions and stereoselectivity**

Unfortunately, most elimination reactions (Chapter 17) offer little control over the geometry of the product: treating *sec*-butanol in acid, for example, gives mainly the more substituted 2-butene, but as a 3:1 mixture of geometrical isomers. But there are some important exceptions. If the product has the double bond inside a ring of less than eight members, it has to be a *cis* double bond. Examples include the simple dehydration of a cyclopentanol and an intramolecular aldol reaction. The six-membered ring is formed before the dehydration step.

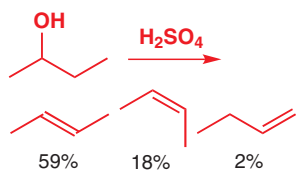

■ You should recognize the second of these reactions as the last step of the Robinson annelation you met in Chapter 26.

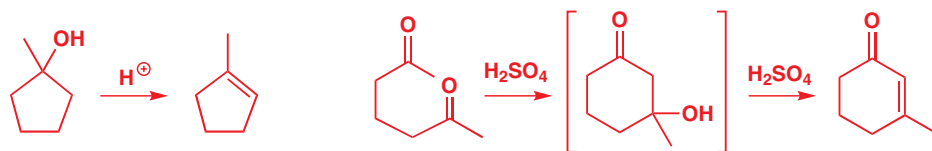

■ Some people call geometrical isomers diastereoisomers, which they are in a sense: they are stereoisomers that are not mirror images. However, we shall avoid this usage since for most chemists the word *diastereoisomer* carries implications of three-dimensional stereochemistry.

But how can we use elimination reactions to give single geometrical isomers of open-chain compounds? These reactions fall into four main classes, and we shall look at each in turn before summarizing the most important methods at the end of the chapter.

● **Ways of making single geometrical isomers of double bonds**

1. Using the fact that only one geometrical isomer is possible (for example, a *cis* double bond in a six-membered ring).
2. The geometrical isomers are in equilibrium and the more stable (usually *E*) is formed.
3. The reaction is stereoselective and the *E* alkene or the *Z* alkene is formed as the main product by kinetic control.
4. The reaction is stereospecific and the alkene geometry depends on the stereochemistry of the starting materials and the mechanism of the reaction.

Exploiting cyclic compounds

You may think that this method is rather too trivial to be called a method for controlling the geometry of double bonds, as it's only of any use for making cyclic alkenes. Well, chemists are more ingenious than that! It is not necessary to have an all-carbon ring to preserve the *cis* geometry of a double bond. Lactones (cyclic esters) and cyclic anhydrides are useful too.

A double bond in a five- or six-membered compound must have a *cis* configuration and compounds like these are readily made. Dehydration of this hydroxylactone can give only a *cis* double bond and ring-opening with a nucleophile (alcohol, hydroxide, amine) gives an open-chain compound also with a *cis* double bond.

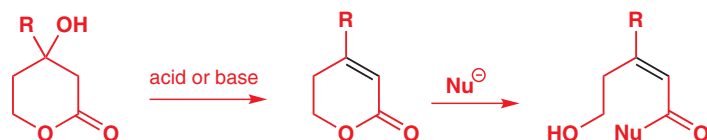

E J Corey used a similar idea to make the insect hormone we introduced on p. 678). He realized that the essential *Z* double bond would be easy to make if he were to start with a cyclic molecule (in which only *cis* double bonds are possible) that could be ring-opened to the compound he needed. This is how he did it.

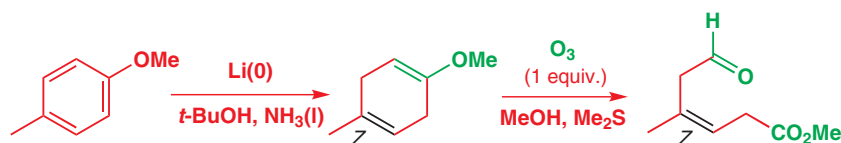

Birch reduction (Chapter 23, p. 542) of a simple aromatic ether generated two *cis* double bonds. The more reactive (because it is more electron-rich) of these reacts with ozone to give an aldehyde-ester in which the *Z* geometry is preserved. NaBH₄ reduces the aldehyde group to a hydroxyl group, which needs to be got rid of: a good way to do this is to tosylate and reduce with LiAlH₄, which substitutes H for OTs. The LiAlH₄ also does the job of reducing the ester to an alcohol, giving the *Z*-configured compound that Corey needed.

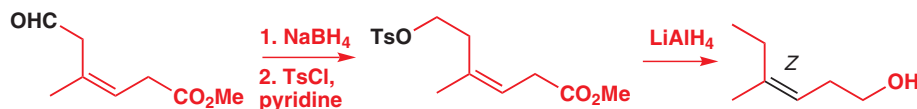

Equilibration of alkenes

Acyclic *E* alkenes are usually more stable than acyclic *Z* alkenes because they are less sterically hindered. Yet *Z* alkenes do not spontaneously convert to *E* alkenes because the π bond prevents free rotation: the energy required to break the π bond is about 260 kJ mol⁻¹ (rotation about a σ bond requires about 10 kJ mol⁻¹). You may therefore find the following result surprising. Dimethyl maleate is easily made by refluxing maleic anhydride in methanol with an acid catalyst. If the product is isolated straight away, a liquid boiling at 199–202°C is obtained. This is dimethyl maleate. However, if the product is left to stand, crystals of *dimethyl fumarate* (the *E* isomer of dimethyl maleate) form. How has the geometry been inverted so easily?

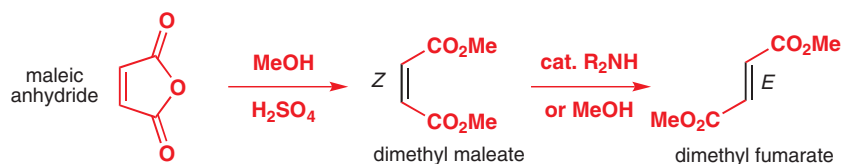

A clue is that the process is accelerated enormously by a trace of amine. Michael addition of this amine, or of methanol, or any other nucleophile, provides a chemical mechanism by which the π bond can be broken. There is free rotation in the intermediate, and re-elimination of the nucleophile can give either *E* or *Z* alkene. The greater stability and crystallinity of the *E* alkene means that it dominates the equilibrium. Michael addition therefore provides a mechanism for the equilibration of *Z* alkenes to *E* alkenes.

Double bonds in rings

The smallest stable ring that can contain a *trans* double bond is cyclooctene—*trans*-cycloheptene can exist but is very unstable.

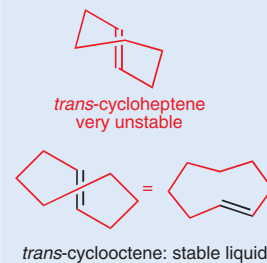

➔ You met ozone as a reagent for the oxidative cleavage of C=C double bonds in Chapter 19. The products have carbonyl groups at the ends of the old alkene. The mechanism is described in more detail in Chapter 34.

Nomenclature alert

Beware! The terms *cis* and *trans* do not always translate directly into *Z* and *E*. Consider the preparation of an enamine from cyclohexanone, which forms a double bond that you'd probably call *cis* (it's in a ring). But applying the rigorous rules laid down for *E/Z* nomenclature (p. 405), it is *E*. The same is true for the green double bond in the Birch reduction product above. As with the useful terms *syn* and *anti* (Chapter 14), there are no rigid rules for deciding whether a double bond is *cis* or *trans*. So there must be a diagram to make things clear if you use *cis* and *trans*.

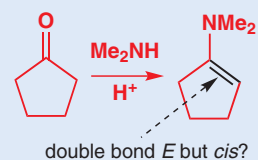

■ This reaction is, of course, another simple example of the type we have just been discussing: the *Z* alkene arises from the cyclic starting material.

■ For this reason, it can be very difficult to make *Z* alkenes conjugated to reactive electrophilic groups such as aldehydes.

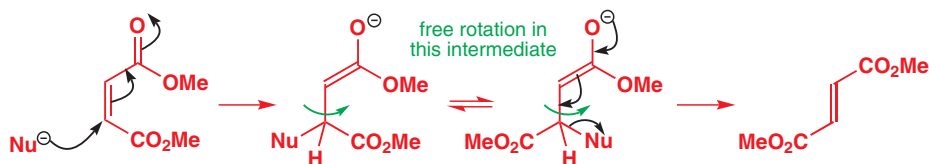

Similar mechanisms account for the double bond geometry obtained in aldol reactions followed by dehydration to give α,β -unsaturated carbonyl compounds. Any *Z* alkene that is formed is equilibrated to *E* by reversible Michael addition during the reaction. The two examples which follow illustrate how effective this method is.

dba

The double aldol product from acetone and benzaldehyde, known as dibenzylidene acetone (dba), is a constituent of some sun-protection materials and is used in organometallic chemistry as a metal ligand.

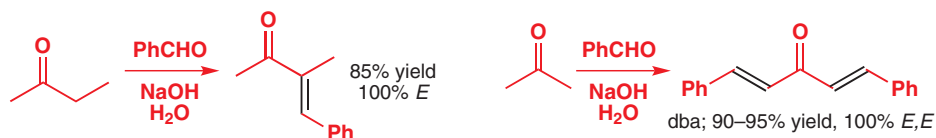

Equilibration of non-conjugated alkenes

Iodine will add reversibly not only to Michael acceptors but also to most other alkenes. It can therefore be a useful reagent for equilibrating double bond geometrical isomers.

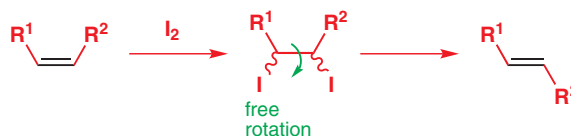

Some Japanese chemists needed the *E,E* diene below for a synthesis of a neurotoxic compound that they had isolated from poison dart frogs. Unfortunately, their synthesis (which used a Wittig reaction—described in detail later in this chapter) gave only 4:1 *E* selectivity at one of the double bonds. To produce pure *E,E* diene, they equilibrated the *E,Z* diene to *E,E* by treating with iodine and irradiating with a sun-lamp.

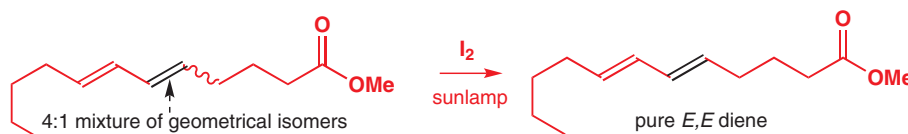

Using light to make *Z* alkenes from *E* alkenes

Light allows the interconversion of the two isomers of an alkene by promoting a π electron into the π^* orbital and transiently breaking the π bond, but the way light favours formation of the *Z* isomer is rather subtle. One difference between *cis* and *trans* alkenes is that the *trans* alkenes usually absorb light better than the *cis* alkenes—they absorb light of a higher wavelength and they absorb more of it, particularly when conjugated with carbonyl groups. Steric hindrance forces the *cis* alkene to twist about the σ bond joining the alkene to the carbonyl group and conjugation is then less efficient. In a mixture of *E* and *Z* alkenes, the *E* alkene is more prone to isomerization by light, so the *Z* isomer builds up in the mixture.

Here is an example. Aldol condensation of cyclohexanone and benzaldehyde gives pure *E* alkene for the reasons explained above. Irradiation with longer-wavelength UV light equilibrates this to the *Z* alkene in excellent yield.

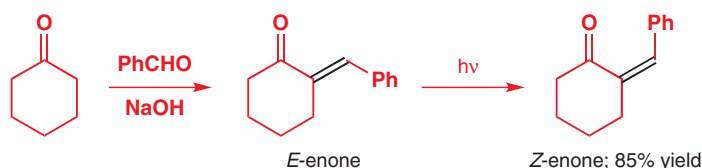

■ The wiggly bonds usually mean that the stereochemistry is unknown or that the compound is a mixture. Here they also mean that it doesn't matter!

■ The addition–elimination of iodine can follow either an ionic or a radical pathway. As explained in Chapter 24 (p. 572), the radical pathway is encouraged by irradiation with light. In this reaction, light energy is absorbed by iodine to make I^* radicals; in the next section it is the alkene itself which absorbs the light.

It is not possible for the benzene ring and the enone system to be planar in the *Z*-enone and so they twist, making conjugation not as good as in the *E*-enone. Longer-wavelength light is absorbed only by the *E*-enone, which is continually equilibrated back to the excited state. Eventually, all the *E*-enone is converted to the *Z*-enone, which is not as efficiently excited by the light. The final mixture of *E*- and *Z*-enone is known as a 'photostationary state'.

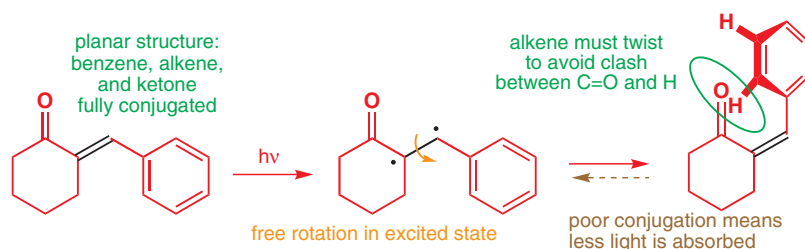

■ The excited state, in which an electron from the π orbital has been promoted to the π^* orbital, can be represented as a 'diradical'—the π bond is effectively broken, with the two electrons which formed it now residing, unpaired, on the two C atoms.

The chemistry of vision

The human eye uses a *cis* alkene, 11-*cis*-retinal, to detect light, and a *cis*–*trans* isomerism reaction is at the heart of the chemical mechanism by which we see. The light-sensitive pigment in the cells of the retina is an imine, formed by reaction of 11-*cis*-retinal with a lysine residue of a protein, opsin. Absorption of light by the opsin–retinal compound, known as rhodopsin, promotes one of

the electrons in the conjugated polyene system to an antibonding orbital. Free rotation in this excited state allows the *cis* double bond to isomerize to *trans*, and the conformational changes in the protein molecule that result trigger a cascade of reactions that ultimately leads to a nerve signal being sent to the brain.

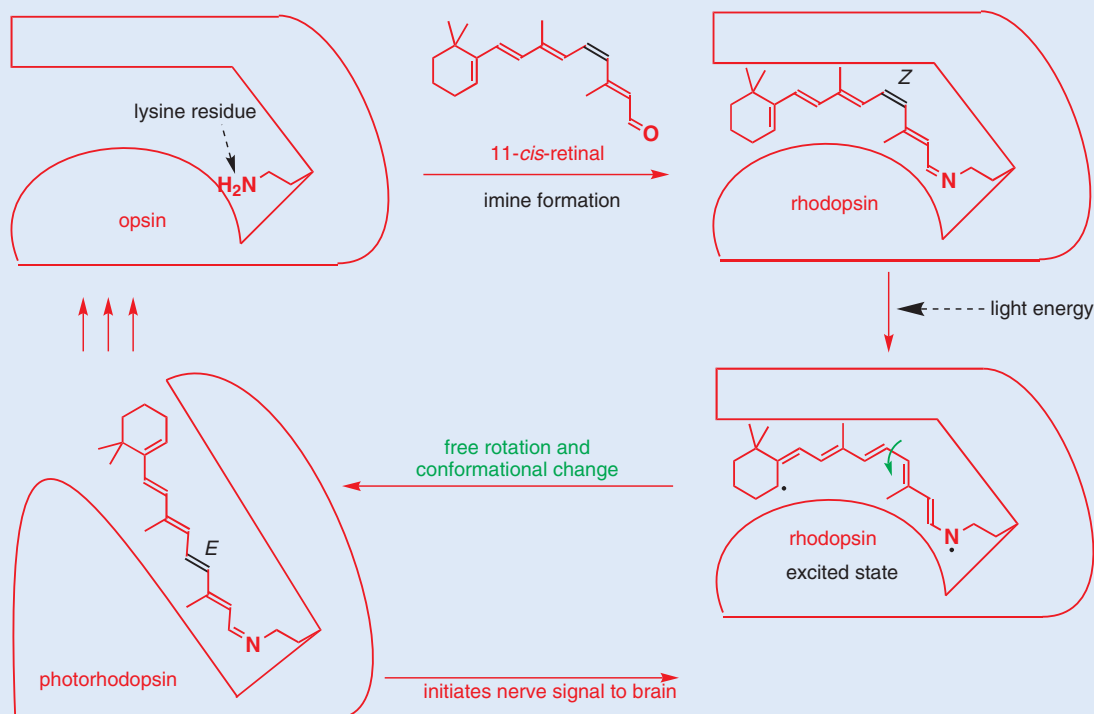

E and Z alkenes can be made by stereoselective addition to alkynes

Alkenes can be made from alkynes by reduction or addition, and under the right conditions either the *Z* double bond or the *E* double bond can be formed stereoselectively.

Z-selective reduction of alkynes using Lindlar's catalyst

The *Z* alkene below was needed pure for studies on the mechanism of a rearrangement reaction. In Chapter 23 you met catalytic hydrogenation as a means of reducing alkenes to alkanes,

■ The reason that catalytic hydrogenation often results in *syn* addition of hydrogen to *alkenes* was discussed in Chapter 23.

and we introduced Lindlar's catalyst (palladium and lead acetate on a support of calcium carbonate) as a means of controlling chemoselectivity so that *alkynes* could be reduced to *alkenes*. What we did not emphasize then was that the two hydrogen atoms add to the alkyne in a *syn* fashion and the alkene produced is a *Z* alkene. The stereoselectivity arises because two hydrogen atoms, bound to the catalyst, are delivered simultaneously to the alkyne.

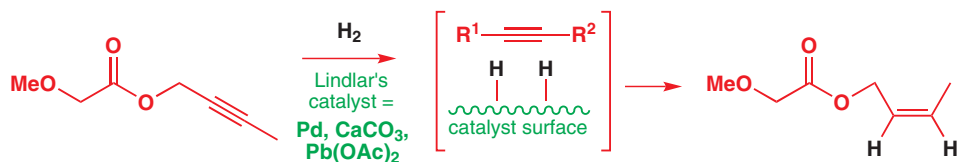

➔ We will discuss the selectivity of the Wittig reaction on p. 690.

The compound below is the pheromone of a destructive beetle. The synthetic pheromone can be used to trap the beetles, but it is active only as the *Z* isomer. Reduction of the alkyne with the Lindlar catalyst gives pure *Z* isomer, while the alternative way of making *Z* alkenes, the Wittig reaction, gives significant amounts of the *E* isomer.

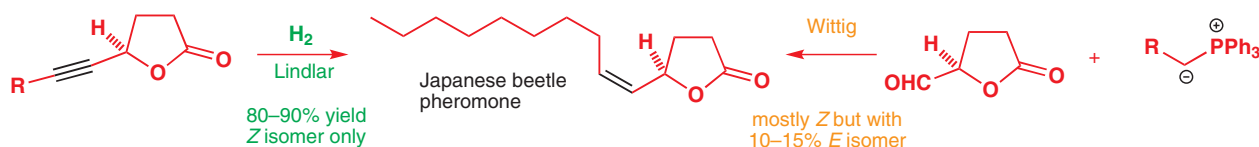

E-selective reduction of alkynes using sodium in liquid ammonia

The best way of ensuring *anti* addition of hydrogen across any triple bond is to treat the alkyne with sodium in liquid ammonia.

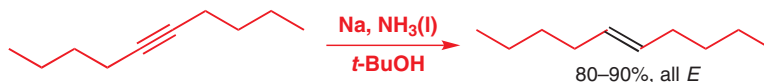

The sodium donates an electron to the LUMO of the triple bond (one of the two orthogonal π^* orbitals). The resulting radical anion can pick up a proton from the ammonia solution to give a vinyl radical. A second electron, supplied again by the sodium, gives an anion that can adopt the more stable *trans* geometry. A final proton quench by a second molecule of ammonia or by an added proton source (*t*-butanol is often used, as in the Birch reduction) forms the *E* alkene.

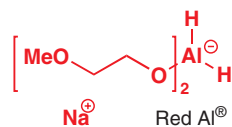
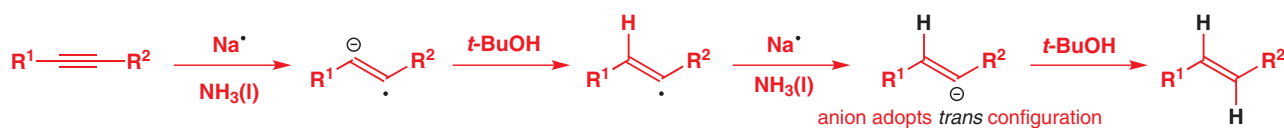

An alternative, and more widely used, method is to reduce alkynes with LiAlH₄ or the related reducing agent known as RedAl. This reaction works only if there is a hydroxy or an ether functional group near to the alkyne because it relies on delivery of the reducing agent to the triple bond through complexation to this oxygen atom.



Making alkenes by addition to alkynes offers two distinct advantages. Firstly, the starting materials can often be made straightforwardly by alkylation of alkynyl anions. Secondly, the same alkyne can be used to make either *E* or *Z* alkene. In some early work on sphingosine (a constituent of cell membranes), some Swiss chemists needed to make both *E* and *Z*

isomers of the naturally occurring compound. This was an easy task once they had made the alkyne.

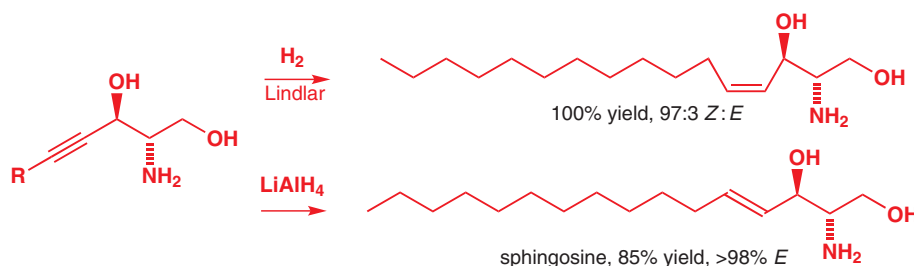

Earlier in this chapter you were introduced to the significance of geometrically pure vinyl silanes, which can act as precursors to other alkenes. Controlled reduction of alkynyl silanes gives the corresponding vinyl silanes, with the method of reduction dictating the stereochemistry. Lindlar hydrogenation adds a molecule of hydrogen across the alkyne in a *cis* fashion to produce the *Z*-vinyl silane. RedAl reduction of a propargylic alcohol leads instead to the *E* isomer.

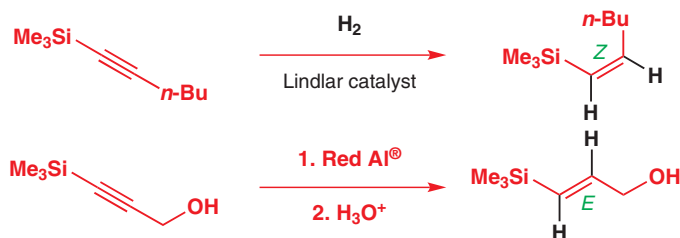

The mechanism of the aluminium hydride reductions with LiAlH_4 or RedAl involve a *trans* hydroalumination helped by coordination of Al to the triple bond and external nucleophilic attack. The regioselectivity of the hydroalumination is again determined by silicon: the electrophilic Al attacks the alkyne on the carbon bearing the silyl group (the *ipso* carbon).

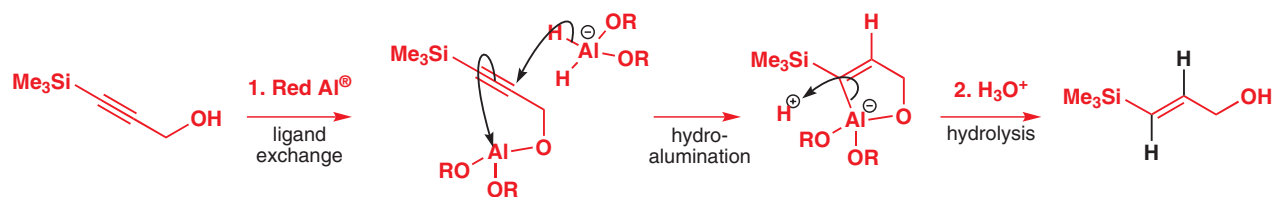

■ In Chapter 40 you will meet further important ways of building alkenes by using Pd-catalysed coupling reactions of related vinylic compounds, in particular vinyl halides and vinyl stannanes. Many of the substrates for those reactions can be made using chemistry related to the reactions you see here.

Addition of nucleophiles to alkynes

This rarer, and rather surprising, approach to *Z* alkenes can give excellent results, particularly in the addition of nucleophiles to butadiyne. The base-catalysed addition of methanol gives an excellent yield of *Z*-1-methoxybut-1-en-3-yne. This reaction is so easy to do that the product is available commercially. Notice that methanol adds once only: you would not expect nucleophiles to add to a simple alkyne and it is the conjugation that makes addition possible.

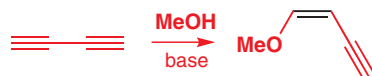

Methoxide ion adds to one of the alkynes to give a conjugated anion. The anion is linear with the negative charge delocalized into the second alkyne. The charge is therefore in a *p* orbital in the plane of the molecule, with a second conjugated π system oriented at right angles to the plane of the molecule.

■ We showed you in Chapter 19 (p. 435) how molecular orbitals explain why dienes are both more nucleophilic and more electrophilic than simple alkenes. The same arguments apply to diynes.

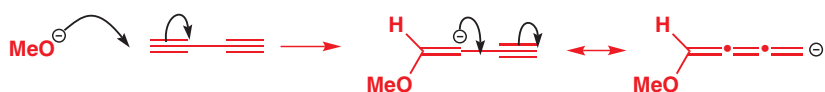

When the anion reacts with a molecule of methanol, protonation occurs on the lobe of the p orbital away from the MeO group and the *Z* alkene is formed.



Predominantly *E* alkenes can be formed by stereoselective elimination reactions

► If you are unclear on the difference between *stereoselective* and *stereospecific* reactions, or between *kinetic* and *thermodynamic* control, go back and re-read Chapters 12 and 17—these concepts are very important for this chapter. The anti-periplanar transition state preferred by E2 reactions is described on p. 395.

In Chapter 17 you saw that E1 elimination reactions usually give mainly *E* alkenes (there's an example earlier in this chapter) because the transition state leading to an *E* double bond is lower in energy than that leading to a *Z* double bond. In other words, E1 reactions are **stereoselective**, and their stereoselectivity is **kinetically controlled**. E2 reactions are similar if there is a choice of protons that can be removed: the *E* alkene is preferred, but a mixture is still formed. Again, this is kinetic control.

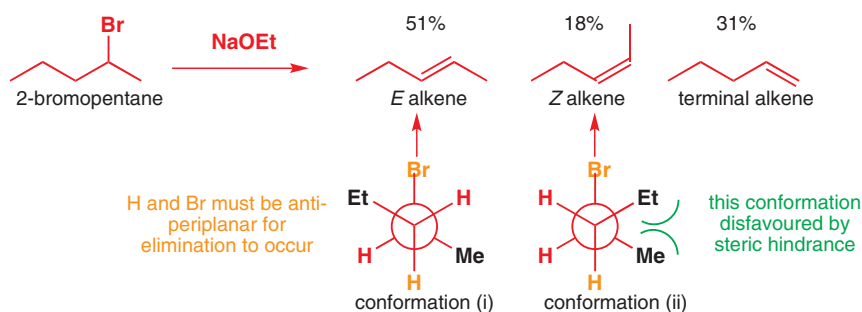

Both stereo- and regioselectivity are usually better in E1cB reactions, such as the opening of this unsaturated lactone in base. The double bond inside the ring remains *Z* but the new one, formed as the ring opens, prefers the *E* geometry. The transition state for the elimination step already looks like the product and prefers the *E* geometry for simple steric reasons.

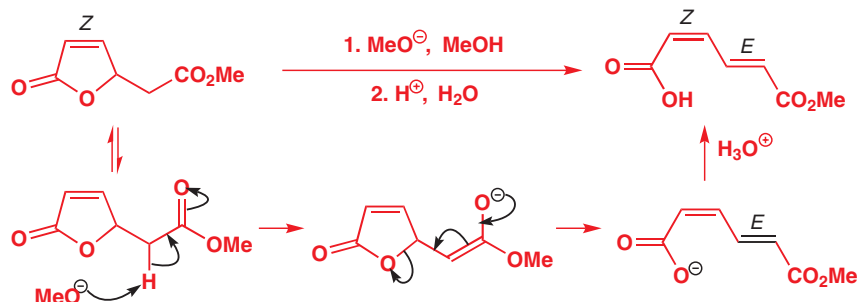

Sulfoxide elimination—oxidation to enones

Sulfoxides occupy a useful and interesting part of the middle ground between sulfides and sulfones—they are weakly nucleophilic, like sulfides (and can be alkylated with methyl

iodide to give sulfoxonium salts, as we saw on p. 667), but at the same time they stabilize anions almost as well as sulfones. They are easily made by controlled oxidation of sulfides and the chart below gives the main ways to get from sulfides to the two oxidized functional groups.

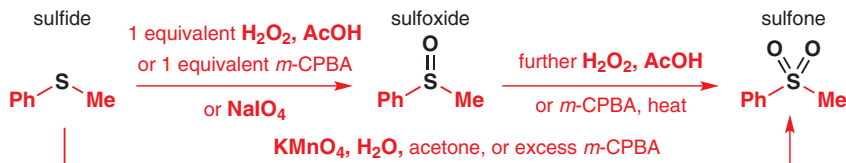

Sulfoxides can be used to make alkenes stereoselectively because sulfoxides next to electron-withdrawing or conjugating groups are unstable on heating, decomposing by an elimination process. The rather unstable phenylsulfenic acid (PhSOH) is eliminated and the reaction occurs partly because of the creation of conjugation and partly because PhSOH decomposes to volatile products. The starting material was made from cycloheptanone by sulfonylation of its enolate followed by oxidation.

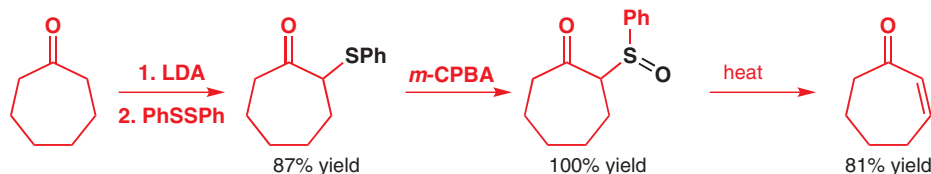

The elimination follows a type of mechanism we call a pericyclic reaction. Once you have read Chapter 34 you should be able to identify the reaction as a reverse cycloaddition, but for now you can just think of it as an elimination in which the proton is removed by the leaving group. The alkene product in this case is in a seven-membered ring—it has to be *cis*.

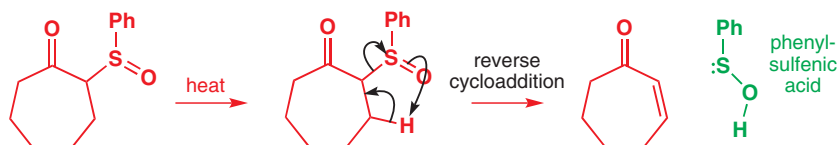

 Interactive mechanism for sulfoxide elimination

This reaction provides a useful way of introducing a double bond next to a carbonyl group. Here it is in a synthesis of the Queen Bee Substance (the compound fed by the workers to those bee larvae destined to become queens). The compound is also a pheromone of the termite and is used to trap these destructive pests. The sulfur is introduced by reacting the enolate of the ester with the sulfur electrophile MeSSMe. Next, the protecting group is removed with acid, and the sulfide is oxidized to the sulfoxide with sodium periodate (NaIO₄) ready for elimination. Heating to 110°C then gives the Queen Bee Substance in 86% yield.

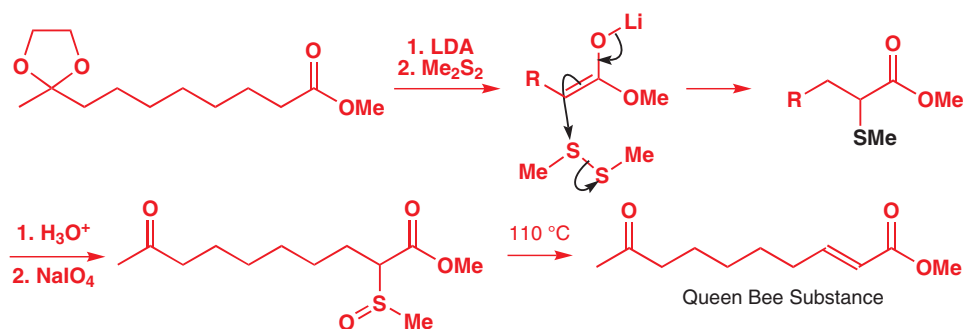

This elimination takes place more easily still when sulfur is replaced by a selenium—PhSe groups can be introduced by the same method, and oxidized to selenoxides with *m*-CPBA at

■ Sulfur and selenium have many properties in common, and much sulfur chemistry is mirrored by selenium chemistry. In general, organoselenium compounds tend to be less stable and more reactive than organosulfur ones because the C–Se bond is even weaker than the C–S bond. They also have even fouler odours.

Marc Julia (1922–2010) was born in Paris, did his PhD at Imperial College, London, with Sir Derek Barton and then worked at the École Normale Supérieure in Paris.

■ **Olefin** is an alternative name for alkene and **olefination** simply means alkene synthesis, usually by the formation of both σ and π bonds.

low temperature. The selenoxides are rarely isolated because the elimination takes place rapidly at room temperature.

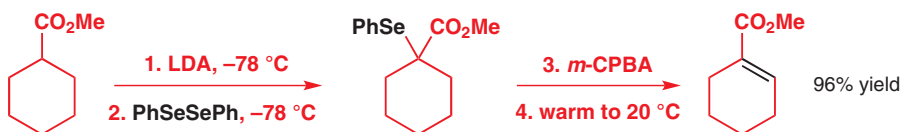

The Julia olefination is regioselective and connective

Sulfoxide eliminations are a valuable way of introducing a double bond to an already intact carbon skeleton. The alkene synthesis we are about to show you is also based on sulfur chemistry, but is *connective*—the alkene is formed by joining together two separate fragments. It is called the **Julia olefination** and is probably the most important application of the sulfone-stabilized anions you saw earlier in the chapter. Only the alkene shown is formed, with the double bond joining the two carbons that carried the PhSO_2 and PhCO_2 groups. This elimination is promoted by a reducing agent, traditionally sodium amalgam (a solution of sodium metal in mercury) and works for a variety of compounds providing they have a phenylsulfonyl group adjacent to a leaving group.

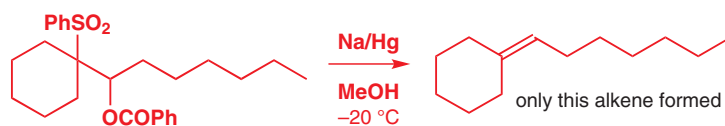

Common leaving groups are carboxylates such as acetate or benzoate, and the starting materials are very easily made. The sulfone-stabilized anion adds to aldehydes and a simple esterification step, which can be done in the same reaction vessel, introduces the acetate or benzoate group. This is how the starting material for the elimination above was made.

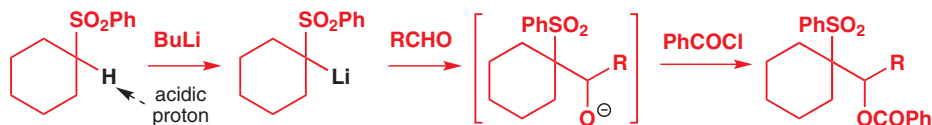

The Julia olefination is stereoselective

Here are the results of a few simple Julia olefinations. Notice that deprotonations can be with BuLi or EtMgBr and that the acylation step works with acetic anhydride or with benzoyl chloride. As you can see, they are all highly stereoselective for the *E* isomer, and the Julia olefination is one of the most important ways of making *E* double bonds connectively.

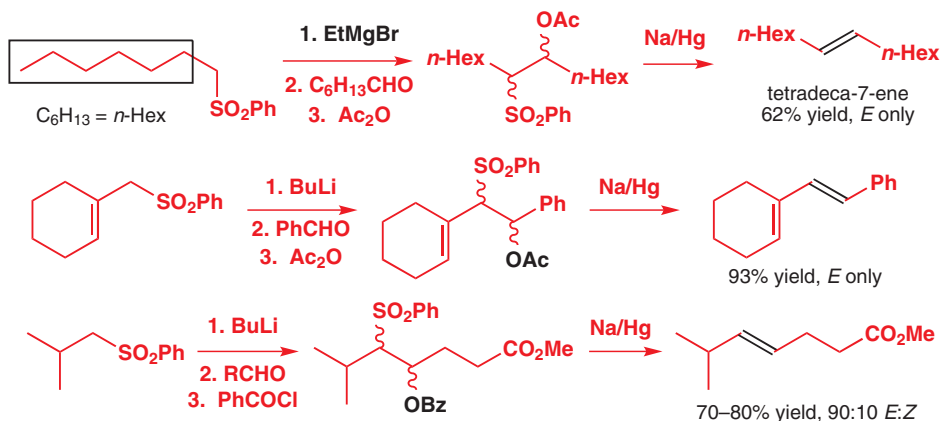

The reason for the *E* selectivity lies in the mechanism of the elimination. The details are not fully clear, but the first step, under the basic conditions of the reduction, appears to be the elimination of the acetate or benzoate ester to give a vinyl sulfone.

 Interactive mechanism for Julia olefination

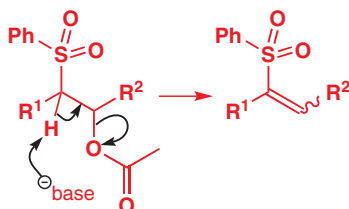

The stereochemistry of the vinyl sulfone does not matter because it is immediately reduced by an electron from sodium to give a vinyl radical. Much as you saw above, in the Birch reduction of alkynes, the vinyl radical collects a second electron and becomes a vinyl anion, which chooses to adopt the more stable *E* configuration before being protonated to give the predominantly *E* alkene.

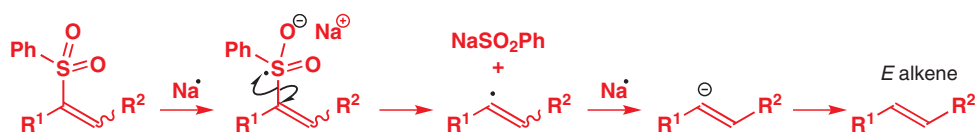

We know that there must be an anion intermediate because the elimination is *not stereospecific*—in other words, whichever diastereoisomer of the starting material you use (all of the examples in this section have been mixtures of diastereoisomers) you always get the *E* alkene product.

The one-step Julia olefination

The Julia reaction is remarkably versatile but it does need three steps to make the alkene: addition, acylation, and reduction. A more recent version of the reaction cuts this down to one by using not a phenylsulfone but instead a sulfone carrying an electron-deficient heterocycle, for example a tetrazole. The anion of the sulfone is made with a strong base (here potassium hexamethyldisilazide, KHMDS—see p. 635) and is added to an aldehyde to give an alkene directly.

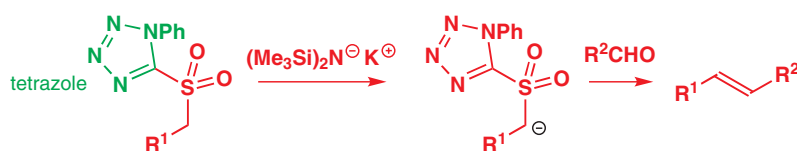

The elimination works because after the addition to the aldehyde, the alkoxide that is formed makes itself into a leaving group by grabbing the heterocyclic ring from the sulfur.

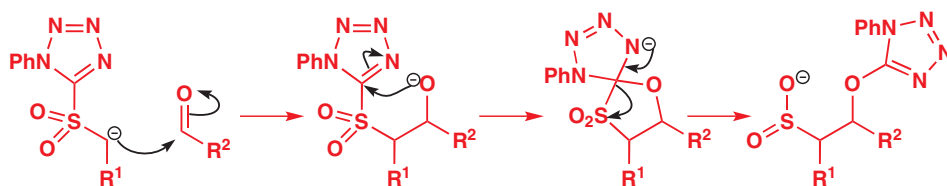

The final elimination is driven by loss of SO₂, and typically gives an *E* alkene, although by choosing carefully the base and solvent the selectivity can be tuned to give predominantly *Z*.

■ Tetrazoles look alarmingly unstable, but are in fact commonly used in medicinal chemistry. You will meet them again shortly, in the chapters on heterocyclic chemistry (29 and 30).

The one-step 'heterocyclic' modification of the Julia olefination was discovered by Marc Julia's brother, Sylvestre Julia, who also worked at the École Normale Supérieure. The use of tetrazolyl-sulfones was a contribution of Philip Kociński, and the reaction is sometimes known as the Julia–Kociński reaction.

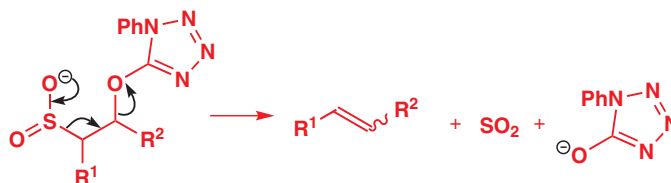

Stereospecific eliminations can give pure single isomers of alkenes

You met a stereospecific elimination in Chapter 17. The requirement for the H and the Br to be anti-periplanar in the E2 transition state meant that the two diastereoisomers of this alkyl bromide eliminated to alkenes with different double bond geometries (p. 396).

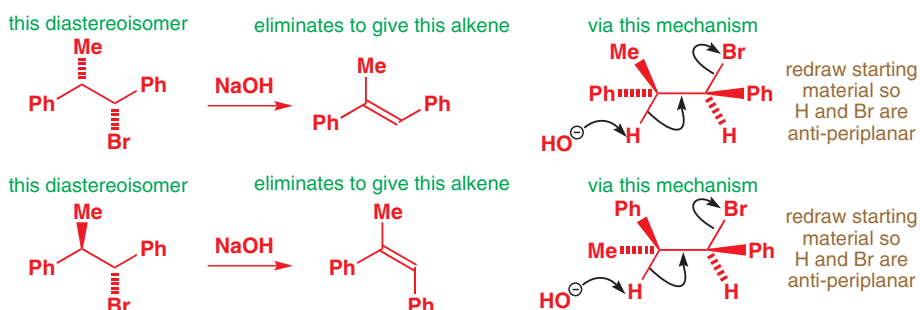

However, reactions like this are of limited use—their success relies on the base's lack of choice of protons to attack. Logic dictates that only trisubstituted double bonds can be made stereospecifically in this way: the reaction must not have a choice of hydrogen atoms or an *E* alkene will result stereoselectively (as in the example on p. 684). The answer is, of course, to move away from eliminations involving H, and we can do this by returning to the Peterson elimination, which you met on p. 671.

The Peterson reaction is stereospecific

The stereospecificity of this elimination involving silicon arises because it is an E2 elimination proceeding via an anti-periplanar transition state. In principle, it can therefore be used to make single geometrical isomers of alkenes, the geometry depending on the relative stereochemistry of the starting material. However, this use of the Peterson reaction is limited by difficulties in making diastereoisomerically pure starting materials.

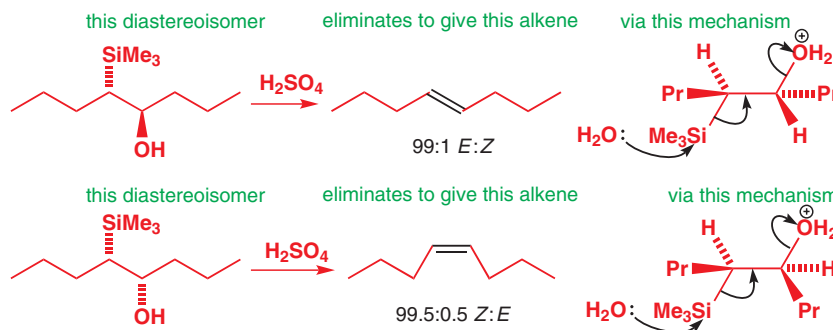

There is another, complementary, version of the Peterson reaction that uses base to promote the elimination. The starting materials are the same as for the acid-promoted Peterson reaction. When base (such as sodium hydride or potassium hydride) is added, the hydroxyl group is deprotonated and the oxyanion attacks the silicon atom *intramolecularly*. Elimination takes

place this time via a *syn-periplanar* transition state—it has to because the oxygen and the silicon are now bonded together, and it is the strength of this bond that drives the elimination forward.

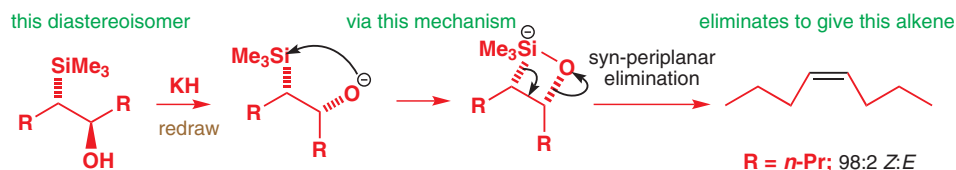

Interactive mechanism for stereospecific base-promoted Peterson elimination

The two versions of the Peterson reaction give opposite geometrical isomers from the same diastereoisomer of the starting material, so from any single diastereoisomer of hydroxy silane we can make either geometrical isomer of alkene product by choosing whether to use acid or base. The problem is still making those single diastereoisomers!

In Chapter 17 you saw that anti-periplanar transition states are usually preferred for elimination reactions because this alignment provides the best opportunity for good overlap between the orbitals involved. Syn-periplanar transition states can, however, also lead to elimination—and the base-promoted Peterson reaction should remind you of the Wittig reaction, which you first met in Chapter 11, with its four-membered cyclic intermediate. It is with the Wittig reaction, and a detailed discussion of its stereoselectivity, that we now finish this chapter.

Perhaps the most important way of making alkenes—the Wittig reaction

The Wittig reaction is another member of the class we have been talking about—it's an elimination that does not involve loss of H. You met it in Chapter 11, where we gave a brief outline of its mechanism.

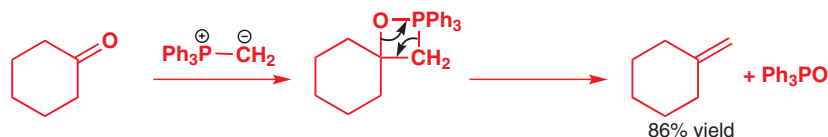

➔ This Wittig reaction appeared on p. 237. We also used the Wittig reaction to help us control enolates on p. 627 of Chapter 26.

Interactive mechanism for the Wittig reaction

Conceptually, the Wittig reaction is like the base-promoted Peterson reaction: it is a *syn* elimination, driven by the strength of an oxygen–heteroatom bond, although in this case the heteroatom is phosphorus. But the elimination step of the Wittig reaction occurs only from an intermediate and not from isolated starting materials. This intermediate is made *in situ* in the reaction and decomposes spontaneously: the Wittig reaction is therefore another connective alkene-forming reaction, but its simplicity makes it more widely used than the Julia or Peterson reactions.

To understand the details of the reaction, we must start at the beginning. Phosphorus atoms, especially those that are positively charged or that carry electronegative substituents, can increase the acidity of protons adjacent to them on the carbon skeleton. Phosphonium salts (made in a manner analogous to the formation of ammonium salts from amines, in other words by reaction of an alkyl halide with a phosphine) can therefore be deprotonated by a moderately strong base to give a species known as an **ylid** (sometimes spelled **ylide**), carrying (formally) a positive and a negative charge on adjacent atoms. Ylids can alternatively be represented as doubly bonded species, called **phosphoranes**.

■ Phosphorus is like sulfur in this regard: you can compare the phosphonium ylid with the sulfonyl-stabilized anions you met earlier.

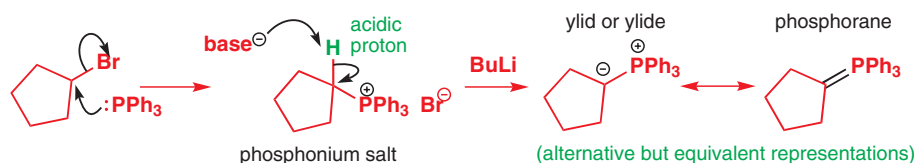

Ylids can be isolated, but are usually used in reactions immediately they are formed. They are nucleophilic species that will attack the carbonyl groups of aldehydes or ketones, generating the four-membered ring oxaphosphetane intermediates. Oxaphosphetanes are unstable: they undergo elimination to give an alkene (65% yield for this particular example) with a phosphine oxide as a by-product. The phosphorus–oxygen double bond is extremely strong and it is this that drives the whole reaction forward.

■ In Chapter 11, to help you understand the reaction, we showed the addition to the carbonyl group to make the four-membered ring taking place in two steps. These steps are probably in fact concerted (they both happen at the same time), and a better representation of the reaction is the single-step formation of the four-membered ring shown here.

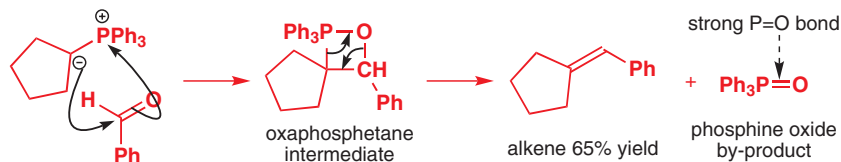

Stereoselectivity in the Wittig reaction depends on the ylid

The Wittig reactions below were all used in the synthesis of natural products. You will notice that some reactions are *Z* selective and some are *E* selective. Look closer, and you see that the stereoselectivity is dependent on the *nature of the substituent* on the carbon atom of the ylid.

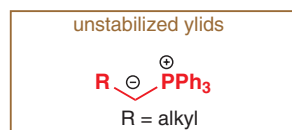
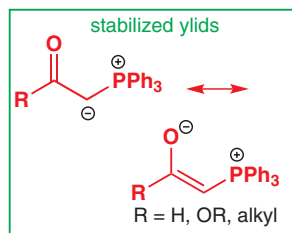
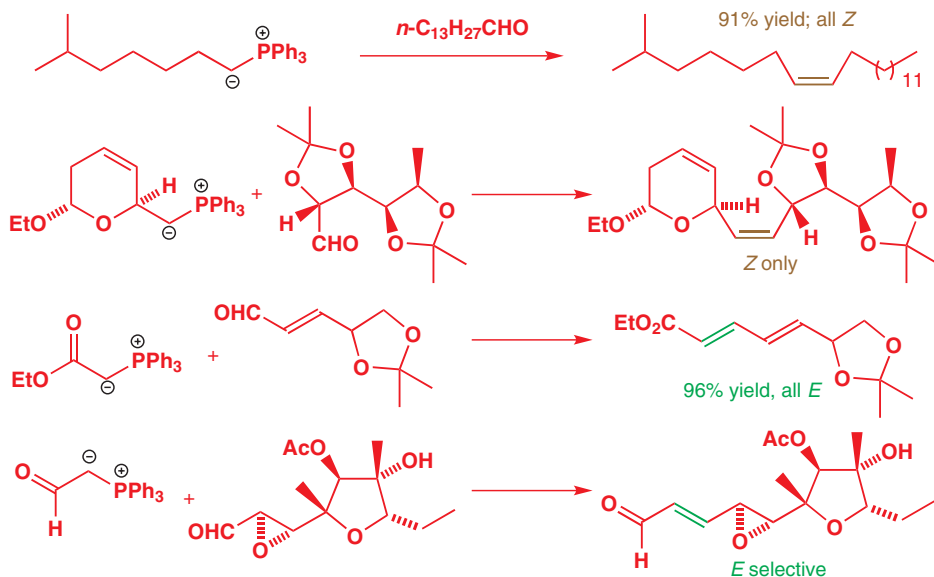

We can divide ylids into two types: those with conjugating or anion-stabilizing substituents adjacent to the negative charge (such as carbonyl groups) and those without. We call the first sort **stabilized ylids** because the negative charge is stabilized not only by the phosphorus atom but by the adjacent functional group—we can draw an alternative enolate-type structure to represent this extra stabilization. The rest we call **unstabilized ylids**.

● The stereochemistry of the Wittig reaction

The general rule is:

- with *stabilized* ylids the Wittig reaction is *E* selective
- with *unstabilized* ylids the Wittig reaction is *Z* selective.

The *Z*-selective Wittig reaction

The *Z* selectivity observed with simple alkyl R groups is nicely complementary to the *E* selectivity observed in the Julia olefination. This complementarity was exploited by some chemists who wanted to make isomers of capsaicin (the compound that gives chilli peppers

their ‘hotness’) to follow up suggestions that capsaicin might be carcinogenic. The key intermediates in the synthesis of the *E* and *Z* isomers of capsaicin were the *E* and *Z* unsaturated esters shown below. By using a Wittig reaction with an unstabilized ylid it was possible to make the *Z* isomer selectively, whilst the Julia olefination gave the *E* isomer.

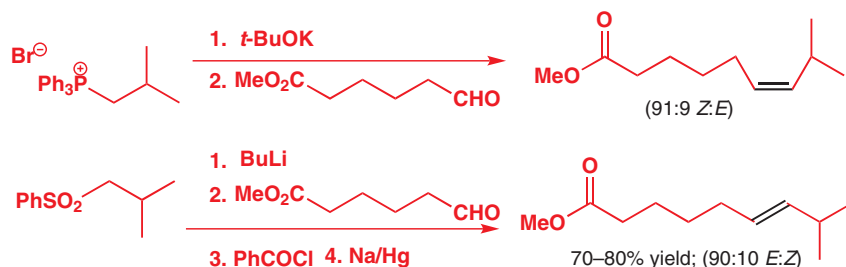

How can the *Z* selectivity in Wittig reactions of unstabilized ylids be explained? We have a more complex situation in this reaction than we had for the other eliminations we considered because we have two separate processes to consider: formation of the oxaphosphetane and decomposition of the oxaphosphetane to the alkene. The elimination step is the easier one to explain—it is stereospecific, with the oxygen and phosphorus departing in a *syn*-periplanar transition state. Addition of the ylid to the aldehyde can, in principle, produce two diastereoisomers of the intermediate oxaphosphetane. Provided that this step is irreversible, then the stereospecificity of the elimination step means that the ratio of the final alkene geometrical isomers will reflect the stereoselectivity of this addition step.

When R is not conjugating or anion-stabilizing, the *syn* diastereoisomer of the oxaphosphetane is formed preferentially, and the predominantly *Z* alkene that results reflects this. The *Z*-selective Wittig reaction therefore consists of a stereoselective first step, to form the *syn* oxaphosphetane, followed by a stereospecific elimination from this intermediate to give a *Z* alkene.

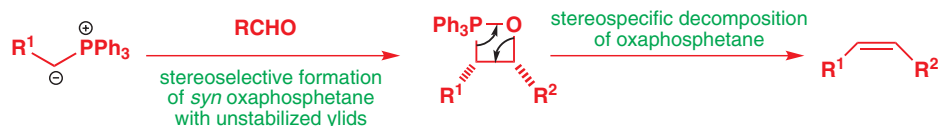

Why the *syn* oxaphosphetane is favoured with unstabilized ylids is the subject of much debate because the mechanism by which the oxaphosphetane is formed is not entirely understood. One possible explanation relies on rules of orbital symmetry, which you will meet in Chapters 34 and 35—we need not explain them in detail here but there is good reason to believe that, if the ylid and carbonyl compound react together to give the oxaphosphetane in one step, they will do so by approaching one another at right angles. Here we have drawn the ylid in its phosphorane form, adding to benzaldehyde. Keeping the large substituents apart produces a transition state like that shown below, which (correctly) predicts that the oxaphosphetane will have *syn* stereochemistry.

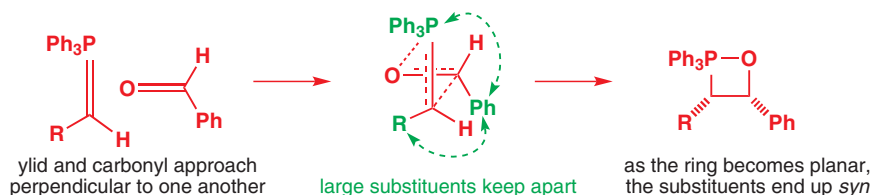

Interactive mechanism of *Z*-selective Wittig reaction

The *E*-selective Wittig reaction

Stabilized ylids, that is ylids whose anion is stabilized by further conjugation, usually with a carbonyl group, give *E* alkenes on reaction with aldehydes.

➔ These ylids are also enolates and were discussed in Chapter 26, p. 627.

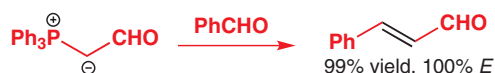

These stabilized ylids really are stable—this one, for example, can be recrystallized from water and the ylid is more stable than the phosphonium salt from which it might be made. This stability means though that they are not very reactive, and often it is better not to use the phosphonium salt but a phosphonate instead.

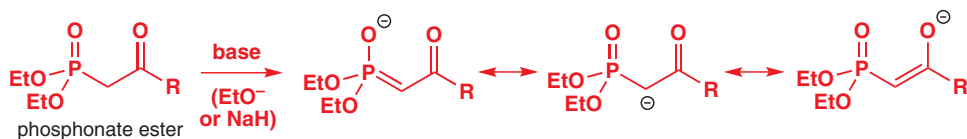

Phosphonate esters can be deprotonated with sodium hydride or alkoxide anions to give enolate-type anions that react well with aldehydes or ketones to give *E* alkenes. Alkene-forming reactions with phosphonates are called **Horner–Wadsworth–Emmons** (or Horner–Emmons, Wadsworth–Emmons, or even Horner–Wittig) **reactions**. This example is a reaction that was used by some Japanese chemists in the synthesis of polyzonimine, a natural insect repellent produced by millipedes.

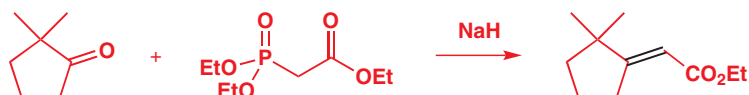

The synthesis below offers a nice illustration of the contrasting selectivity of the two classes of Wittig reagent. The female silkworm moth attracts mates by producing a pheromone known as bombykol. Bombykol is an *E,Z*-diene, and in this synthesis two successive Wittig reactions use first a stabilized and second an unstabilized ylid to control the stereochemistry of the product.

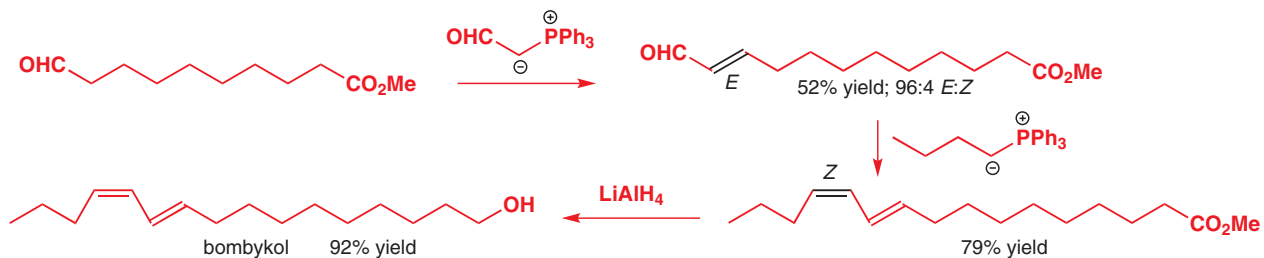

So why is there a change to *E* stereoselectivity when the ylid is stabilized? Again, the details are still unclear, and there are several possible explanations. Here we give one which is gaining ground, supported by recent experimental and computational evidence. It seems that, as with unstabilized ylids, the stereochemistry of the alkene product is determined by the stereochemistry of the intermediate oxaphosphetane, which with stabilized ylids must be *anti*.

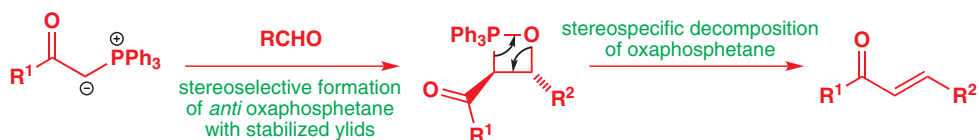

It used to be thought that the formation of the *anti* oxaphosphetane was under thermodynamic control, but it now seems likely that it too is formed stereoselectively under kinetic control. The difference from the alkyl-substituted unstabilized ylids lies in the repulsion experienced between the polarized C=O bond of the aldehyde and the electronegative stabilizing group shown here as an ester CO₂R. As the four-membered ring flattens out, the CO₂R and Ph groups end up on opposite sides of the four-membered ring.

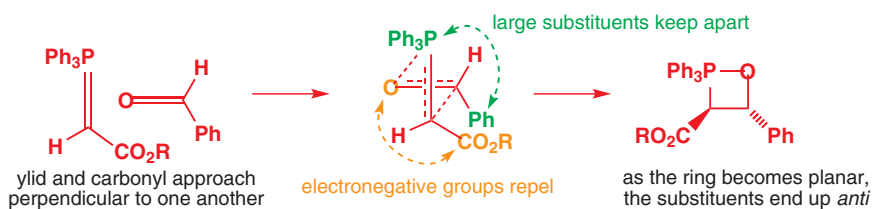

Interactive mechanism for *E*-selective Wittig reaction

To conclude

In this chapter we have dealt for the first time with the problem of producing compounds as single stereoisomers—the stereoisomers concerned were geometrical isomers of alkenes. In future chapters we shall look in more detail at making stereoisomers, but we shall move out of two dimensions into three and consider reactions that exhibit diastereoselectivity and enantioselectivity. Methods for controlling stereochemistry in two and in three dimensions are closely related: single diastereoisomers are often made by addition reactions of single geometrical isomers of double bonds and, as you saw with the Peterson and Wittig reactions, single diastereoisomers can lead stereospecifically to single geometrical isomers.

● Summary of methods for making alkenes stereospecifically

To make <i>cis</i> (<i>Z</i>) alkenes	To make <i>trans</i> (<i>E</i>) alkenes
Wittig reaction of <i>unstabilized</i> ylid	Wittig reaction of <i>stabilized</i> ylid
Constrain the alkene in a ring	Equilibration to the more stable isomer
	Julia olefination
	Simple unselective elimination reactions
<i>Syn</i> addition of hydrogen across an alkyne	<i>Trans</i> selective reduction of alkyne
Peterson elimination	Peterson elimination

Further reading

If you want to read more about the elegant experiments that have been used to probe the structure of sulfonyl anions, see E. Block, *Reactions of organosulfur compounds*, Academic Press, New York, 1978.

Chemistry of Boron and Silicon is treated in S. E. Thomas, *Organic Synthesis: The Roles of Boron and Silicon*, Oxford Primer, OUP, Oxford, 1991.

For a recent discussion of the mechanism of the Wittig Reaction see R. Robiette, J. Richardson, V. K. Aggarwal, and J. N. Harvey, *J. Am. Chem. Soc.*, 2006, **128**, 2394.

For a comprehensive treatment of double bond geometry control see P. Wyatt and S. Warren, *Organic Synthesis: Strategy and Control*, Wiley, Chichester, 2007 chapters 7–13 and the accompanying *Workbook*, also Wiley, 2008.

Check your understanding



To check that you have mastered the concepts presented in this chapter, attempt the problems that are available in the book's Online Resource Centre at <http://www.oxfordtextbooks.co.uk/orc/clayden2e/>

28

Retrosynthetic analysis

Connections

➔ Building on

- Carbonyl chemistry [ch6](#), [ch10](#), & [ch11](#)
- S_N1 and S_N2 reactions [ch15](#)
- Electrophilic aromatic substitution [ch21](#)
- Chemistry of enols and enolates [ch20](#), [ch25](#), & [ch26](#)
- Conjugate addition [ch22](#)

Arriving at

- Synthesis and retrosynthesis
- Thinking backwards
- How to make amines and ethers
- What are synthons?
- Choosing which C–C bonds to make
- Two-group disconnections are best
- Logical planning in enolate chemistry

➔ Looking forward to

- Diastereoselectivity [ch32](#) & [ch33](#)
- Pericyclic reactions [ch34](#) & [ch35](#)
- Synthesis of aromatic heterocycles [ch30](#)
- Asymmetric synthesis [ch41](#)
- Natural products [ch42](#)

Creative chemistry

Chemistry is above all a creative science. Nearly all that you have learned so far in this book has had one underlying aim: to teach you how to make molecules. This is after all what most chemists do, for whatever reason. Small amounts of many drugs can be isolated from plants or marine animals; much greater quantities are made by chemists in laboratories. A limited range of dyes can be extracted from plants; many more vivid and permanent ones are made by chemists in the laboratory. Synthetic polymers, created by chemists, have replaced more expensive and less durable alternatives like rubber. Despite the bad press it has received, the use of PVC as insulating material for electric wires has prevented numerous fires and saved many lives. Food is healthier and people live longer because well-designed and controlled pesticides allow agriculture to supply copious quantities of disease-free food to the shelves of our shops, markets, and supermarkets. Most of the improvements in the quality of life over the last 50 to 100 years can be traced to new molecules created by chemists. But, faced with the challenge of making a new compound, how do chemists go about deciding how to make it?

Synthetic planning starts with the product, which is fixed and unchangeable, and works backwards towards the starting materials. This process is called *retrosynthesis*, and the art of planning the synthesis of a target molecule is called *retrosynthetic analysis*. The aim of this chapter is to introduce you to the principles of retrosynthetic analysis: once you have read and understood it you will be well on the way to designing your own organic syntheses.

Retrosynthetic analysis: synthesis backwards

Most of the chemistry you have learned so far has concentrated on *reactions* (questions like ‘What do you need to add to X to get Y?’) or on *products* (questions like ‘What will happen if X and Y react together?’). Now we’re looking at starting materials (questions like ‘What X and Y do you need to react together to make Z?’). We’re looking at reactions in reverse, and we have a special symbol for a reverse reaction called a retrosynthetic arrow (the ‘implies’ arrow from logic). A scheme with a retrosynthetic arrow (margin) means ‘Z could be made from X plus Y’.



Online support. The icon  in the margin indicates that accompanying interactive resources are provided online to help your understanding: just type www.chemtube3d.com/clayden/123 into your browser, replacing **123** with the number of the page where you see the icon. For pages linking to more than one resource, type **123-1**, **123-2** etc. (replacing **123** with the page number) for access to successive links.

Here's a very simple first example. This compound is used as an insect repellent. As it's an ester, we know that it can be made from alcohol plus acyl chloride, and we can represent this using a retrosynthetic arrow.

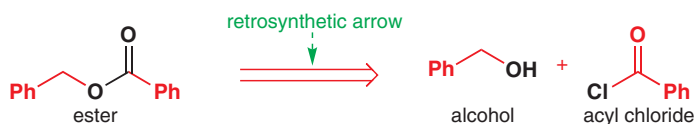

The aromatic amide amelfolide is a cardiac antiarrhythmic agent. Because we see that it is an amide, we know that it can be made quite simply from *p*-nitrobenzoyl chloride and 2,6-dimethylaniline—again, we can represent this using a retrosynthetic arrow. Mentally breaking a molecule into its component parts like this is known as **disconnection**, and it's helpful to indicate the site of the disconnection with a wiggly line as we have here.

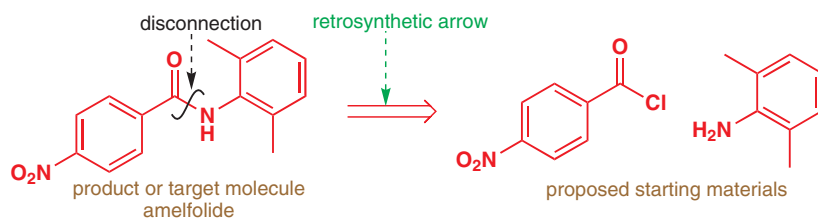

Disconnections must correspond to known, reliable reactions

The chemists who first made amelfolide chose to make it from an amine and an acyl chloride because they knew that this reaction, a standard way of making an amide, had a very good chance of success. They chose to disconnect the C–N bond because this disconnection corresponds to a reliable reaction in a way that no other possible disconnection of this molecule does.

Now that you've seen the principle of retrosynthetic analysis at work, you should be able to suggest a reasonable disconnection of the compound in the margin, known as daminozide. You probably spotted immediately that daminozide is again an amide, so the best disconnection is the C–N bond, which could take us back to acyl chloride and dimethylhydrazine. This time we've written 'C–N amide' above the retrosynthetic arrow as a reminder of why we've made the disconnection and we advise you to follow this practice.

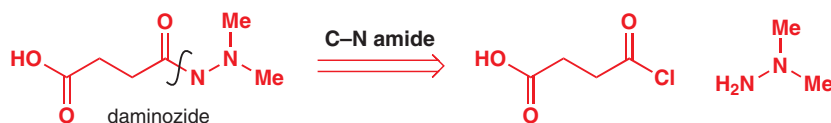

Now, in fact, there is a problem with this acyl chloride—it would be unstable as it can cyclize to an anhydride. But this poses no problem for the synthesis of daminozide—we could just use the anhydride instead, since the reaction should be just as reliable. A better retrosynthesis therefore gives the anhydride and indeed this is how daminozide is made.

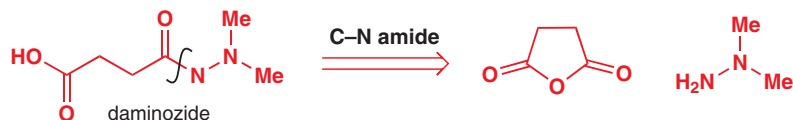

Synthons are idealized reagents

In the synthesis of daminozide an anhydride is used out of necessity rather than out of choice, but it often turns out that there are several alternative reagents all corresponding to

Arrows

You now know four types of arrow: the simple reaction arrow \longrightarrow meaning 'reacts to give', the delocalization arrow \longleftrightarrow meaning 'two different ways to draw the same delocalized structure', the equilibrium arrow \rightleftharpoons meaning 'these two structures are interconverting', and now the retrosynthesis arrow \Longrightarrow meaning 'could be made from'.

■ This chapter will rely heavily on the reactions you have met earlier in the book, and should therefore provide you with the opportunity to revise them and check you understand how they work. If you come across a reaction you aren't familiar with, look it up before carrying on to the next one.

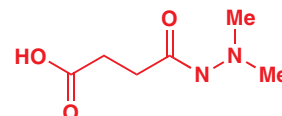

Daminozide is an agrochemical used to stunt the growth of chrysanthemums and dwarf fruit trees artificially.

the same disconnection. Paracetamol, for example, is an amide that can be disconnected either to amine + acyl chloride or to amine + anhydride.

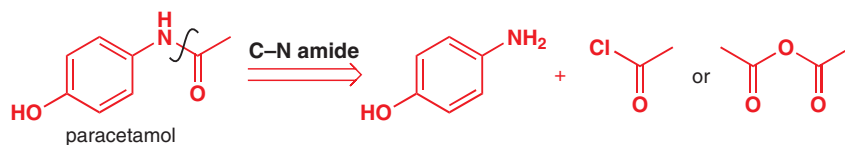

Which reagent is best can often only be determined by experimentation—commercially, paracetamol is made from *para*-aminophenol and acetic anhydride largely because the by-product, acetic acid, is easier to handle than HCl. In a retrosynthetic analysis, we don't really want to be bothered by this sort of decision, which is best made later, so it's useful to have a single way of representing the key attributes of alternative reagents. We can depict both anhydride and acyl chloride in this scheme as an 'idealized reagent'—an electrophilic acetyl group MeCO^+ .

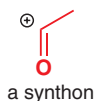

We call such idealized reagents **synthons**. Synthons are fragments of molecules with an associated polarity (represented by a '+' or '-') which stand for the reagents we are going to use in the forward synthesis. They are not themselves reagents, although they may occasionally turn out to be intermediates along the reaction pathway. By disconnecting bonds to synthons rather than to actual reagents we can indicate the polarity of the bond-forming reaction we are going to use without having to specify details of the reagents.

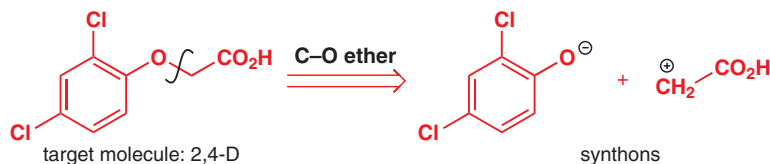

■ You will find that you learn much more and much faster if you try to do the retrosynthetic analyses in this chapter as you read it, before looking at the suggested solutions. Use a piece of paper to cover up the rest of the page as you read, and write some ideas down on another piece of paper. Don't just say 'oh I can do that' and move on—you'll miss out on the chance of teaching yourself a lot of chemistry. Don't waste the opportunity! Next time you read this chapter you'll have your memory as an aid—and retrosynthetic analysis isn't about remembering; it's about deducing. Another important thing about retrosynthetic analysis is that there is rarely one single 'right' answer, so even if your suggestions don't match up with ours, don't be discouraged. Aim to learn from the points where your attempts differ from our suggestions.

We can apply these ideas to the synthesis of the herbicide 2,4-D (2,4-dichlorophenoxyacetic acid). The most reasonable disconnection of an ether is the C–O bond because we know that ethers can be made from alkyl halides by substitution with an alkoxide anion. We don't at this stage need to decide exactly which alkyl halide or alkoxide to use, so we just write the synthons.

Once the retrosynthetic analysis is done, we can go back and use our knowledge of chemistry to think of reagents corresponding to these synthons. Here, for example, we should certainly choose the anion of the phenol as the nucleophile and some functionalized acetic acid molecule with a leaving group in the α position.

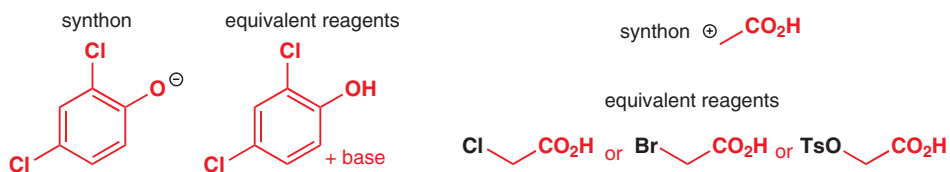

We can then write out a suggested synthesis in full from start to finish. It isn't reasonable to try to predict exact conditions for a reaction: to do that you would need to conduct a thorough search of the chemical literature and do some experiments. However, all of the syntheses in this chapter are real examples and we shall often give full details of conditions to help you become familiar with them.

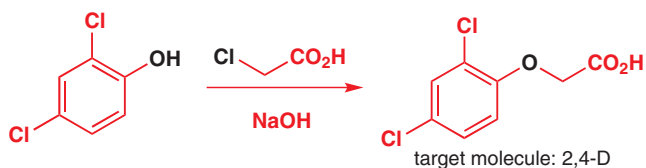

● Some definitions of terms used in synthesis

target molecule (or TM)	the molecule to be synthesized
retrosynthetic analysis or retrosynthesis	the process of mentally breaking down a molecule into starting materials
retrosynthetic arrow	an open-ended arrow, \Longrightarrow , used to indicate the reverse of a synthetic reaction
disconnection	an imaginary bond cleavage, corresponding to the reverse of a real reaction
synthon	idealized fragments resulting from a disconnection (<i>synthons</i> need to be replaced by <i>reagents</i> in a suggested synthesis)
reagent	a real chemical compound used in the synthesis, perhaps as the equivalent of a synthon

Choosing a disconnection

The hardest task in designing a retrosynthetic analysis is spotting where to make the disconnections. We shall offer some guidelines to help you, but the best way to learn is through experience and practice. The overall aim of retrosynthetic analysis is to get back to starting materials that are available from chemical suppliers, and to do this as efficiently as possible.

● Guideline 1

Disconnections must correspond to known, reliable reactions.

We have already mentioned that disconnections must correspond to known reliable reactions and it's the most important thing to bear in mind when working out a retrosynthesis. When we disconnected the ether 2,4-D we chose to disconnect next to the oxygen atom because we know about the synthesis of ethers. We chose *not* to disconnect on the aryl side of the oxygen atom because we know of no reliable reaction corresponding to nucleophilic attack of an alcohol on an unactivated aromatic ring.

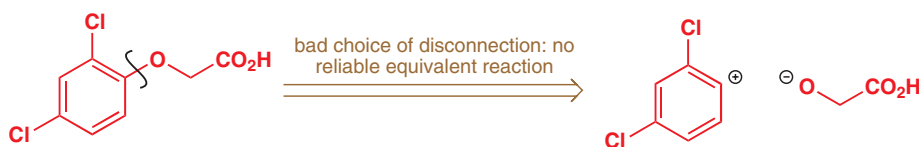

➡ We talked about cases where nucleophilic aromatic substitution is possible in Chapter 22.

● Guideline 2

For compounds consisting of two parts joined by a heteroatom, disconnect next to the heteroatom.

In all the retrosynthetic analyses you've seen so far there is a heteroatom (N or O) joining the rest of the molecule together, and in each case we made the disconnection next to that N or O. This guideline works for esters, amides, ethers, amines, acetals, sulfides, and so on because these compounds are often made by a substitution reaction. Chlorbenside is used to kill ticks and mites. Using Guideline 2 we can suggest a disconnection next to the sulfur atom; using Guideline 1 we know that we must disconnect on the alkyl and not on the aryl side.

chlorbenside:
retrosynthetic analysis

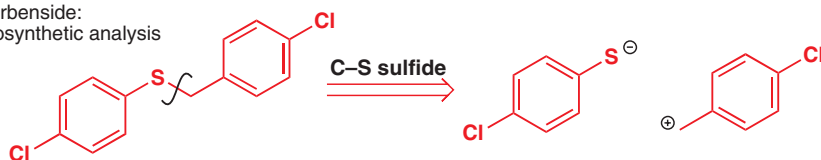

We can now suggest reagents corresponding to the synthons and propose a synthetic scheme.

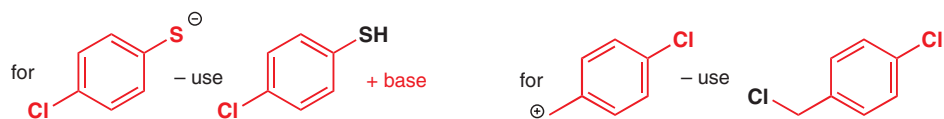

■ You shouldn't have expected to predict that sodium ethoxide would be the base used for this reaction, but you should have been aware that a base is needed, and have had some idea of the base strength required to deprotonate a thiol.

chlorbenside:
synthesis

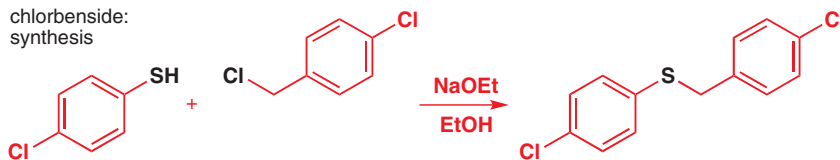

The next example is the ethyl ester of, and precursor to, cetaben, a drug that can be used to lower blood lipid levels. It is an amine, so we disconnect next to the nitrogen atom.

■ You don't always need to write out the synthons first—here the reagents are simple so we just write those instead.

cetaben ethyl ester:
retrosynthetic analysis
(R = *n*-C₁₅H₃₁)



The alkyl bromide is available but we shall need to make the aromatic amino-ester and the best disconnection for an ester is the C–O bond between the carbonyl group and the esterifying group.

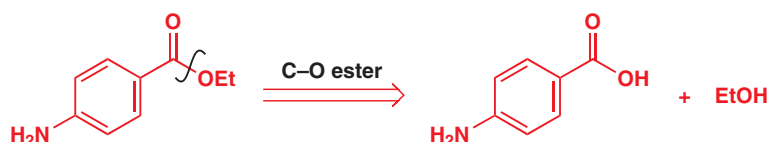

We have now designed a two-step synthesis of our target molecule, and this is how it is carried out.

cetaben ethyl ester:
synthesis
(R = *n*-C₁₅H₃₁)

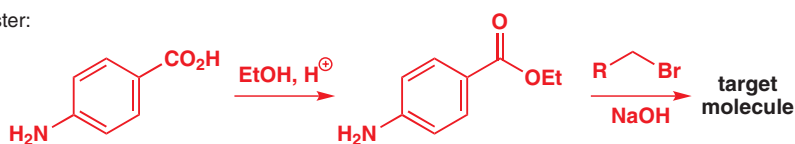

Multiple step syntheses: avoid chemoselectivity problems

The next compound was an intermediate in the synthesis of the potential anti-obesity drug ICI-D7114. You can spot that, with two ethers and an amine functional group, it requires several disconnections to take it back to simple compounds. The question is, which do we do first? One way to solve the problem is to write down all the possibilities and see which looks best. Here there are four reasonable disconnections: one at each of the ether groups (*a* and *b*) or on either side of the amine (*c* and *d*).

ICI-D7114 intermediate: retrosynthetic analysis

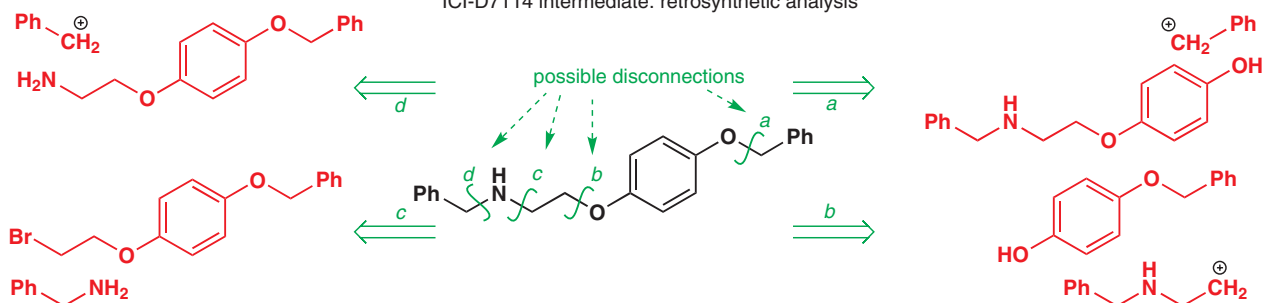

Both (a) and (b) pose problems of chemoselectivity as it would be hard to alkylate the phenol in the presence of the basic nitrogen atom. Between (c) and (d), (c) appears to be the better choice because the next disconnection after (d) will have to be an alkylation of O in the presence of an NH₂ group. To avoid chemoselectivity problems like this, we want to try to *introduce reactive groups late in the synthesis*. In terms of retrosynthetic analysis, then, we can formulate another guideline.

➔ We talked about this type of thing in Chapter 23.

● **Guideline 3**

Consider alternative disconnections and choose routes that avoid chemoselectivity problems—often this means disconnecting reactive groups first.

This guideline helps us in the next retrosynthetic step for the ICI-D7114 intermediate. Disconnection (c) gave us a compound with two ethers that might be disconnected further by disconnection (e) or (f).

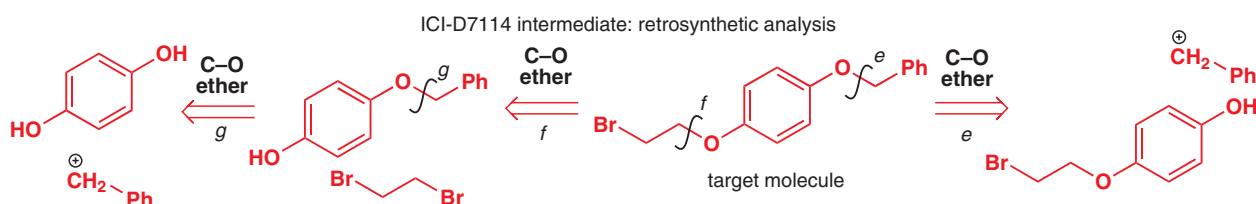

Disconnection (e) requires alkylation of a compound that is itself an alkylating agent. Disconnection (f) is much more satisfactory and leads to a compound that is easily disconnected to 4-hydroxyphenol and 1,2-dibromoethane. Using Guideline 3, we can say that it's best to disconnect the bromoethyl group (f) before the benzyl group (g) because the bromoethyl group is more reactive and more likely to cause problems of chemoselectivity.

ICI-D7114 intermediate: synthesis

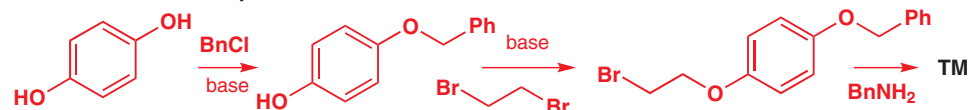

■ TM stands for target molecule.

Functional group interconversion

The antihypertensive drug ofornine contains an amide and an amine functional group, and we need to decide which to disconnect first. If we disconnect the secondary amine first (b), we will have chemoselectivity problems constructing the amide in the presence of the resulting NH₂ group.

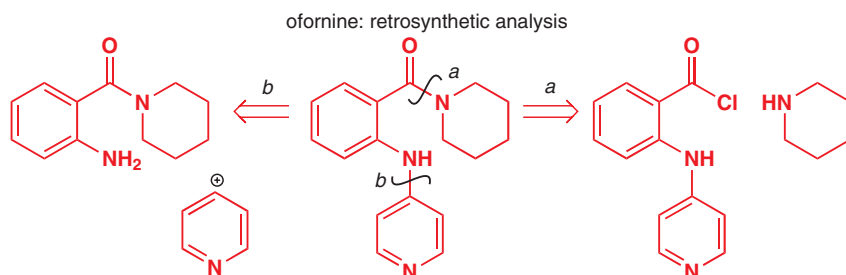

Yet disconnection (a), on the face of it, seems to pose an even greater problem because we now have to construct an amine in the presence of an acyl chloride! However, we shall want to make the acyl chloride from the carboxylic acid, which can then easily be disconnected to 2-aminobenzoic acid (anthranilic acid) and 4-chloropyridine.

➔ We discussed nucleophilic substitutions on electron-poor aromatic rings like this in Chapter 22 and there is more detail on chloropyridines in Chapter 29.

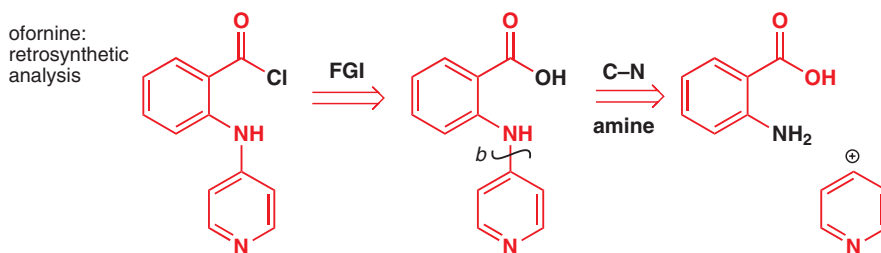

The retrosynthetic transformation of an acyl chloride to a carboxylic acid is not really a disconnection because nothing is being disconnected. We call it instead a functional group interconversion, or FGI, as written above the retrosynthetic arrow. Functional group interconversions often aid disconnections because the sort of reactive functional groups (acyl chlorides, alkyl halides) we want in starting materials are not desirable in compounds to be disconnected because they pose chemoselectivity problems. They are also useful if the target molecule contains functional groups that are not easily disconnected.

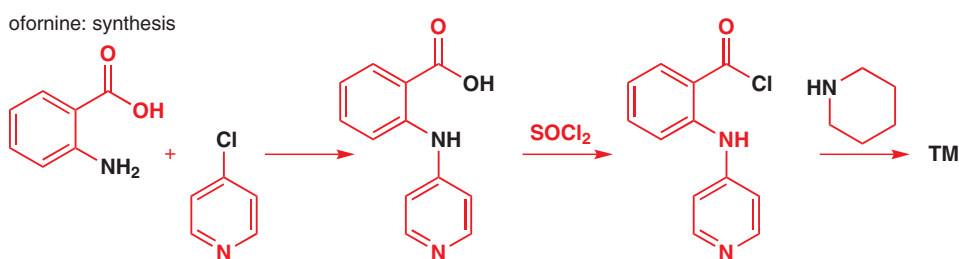

By using an appropriate reagent or series of reagents, almost any functional group can be converted into any other. You should already have a fair grasp of reasonable functional group interconversions. They mostly fall into the categories of oxidations, reductions, and substitutions (Chapters 10, 11, 15, and 23).

Amine synthesis using functional group interconversions

The synthesis of amines poses a special problem because only in certain cases is the obvious disconnection successful.



➔ We discussed this in Chapters 11 and 23.

The problem is that the product is usually more reactive than the starting material and there is a danger that multiple alkylation will take place.

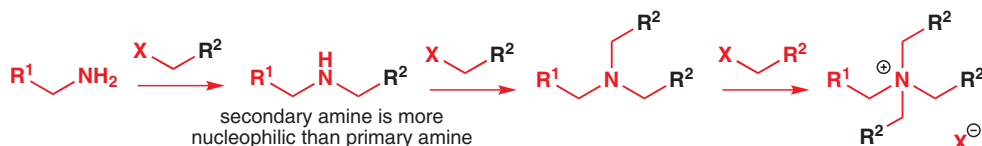

The few successful examples you have seen so far in this chapter have been exceptions, for either steric or electronic reasons, and from now on we advise you to avoid disconnecting an amine in this way. Sometimes further alkylation is made unfavourable by the increased steric hindrance that would result: this is probably the case for the cetaben ethyl ester we made by this reaction.

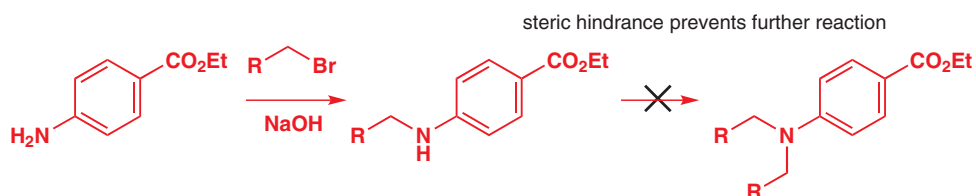

If the alkylating agent contains an inductive electron-withdrawing group, the product may be less reactive than the starting material—benzylamine was only alkylated once by the alkyl bromide in the synthesis of ICI-D7114 on p. 699 because of the electron-withdrawing effect of the aryloxy group.

What are the alternatives? There are two main ones, and both involve functional group interconversion, with the reactive amine being converted to a less reactive derivative before disconnection. The first solution is to convert the amine to an amide and then disconnect that. The reduction of amide to amine is quite reliable, so the FGI is a reasonable one.

amines: retrosynthetic analysis 1

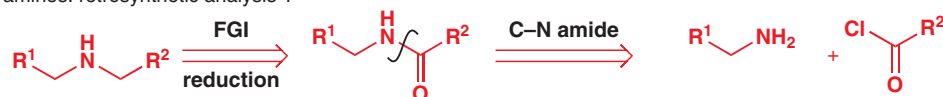

amines: synthesis 1

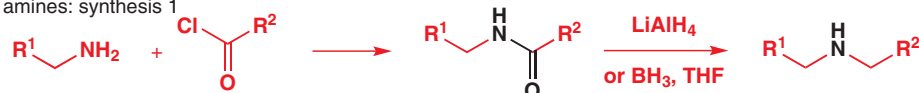

■ Notice that we write 'reduction' below the FGI arrow because we are talking about the *forward* reaction we are going to do at this step.

The amide reduction approach was used in a synthesis of this amine, although catalytic hydrogenation was used to reduce the amide.

retrosynthetic analysis:

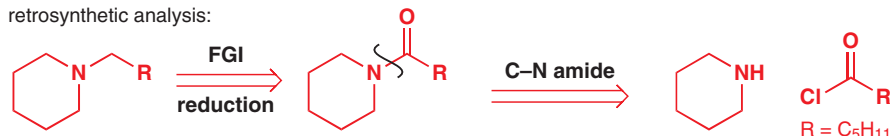

synthesis:

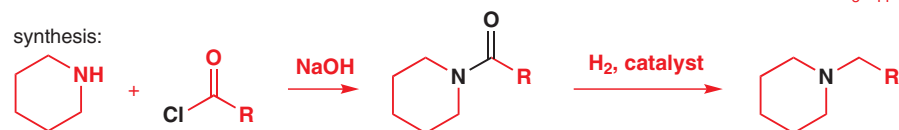

The second alternative is to convert to an imine, which can be disconnected to amine plus carbonyl compound. This approach is known as reductive amination and we discussed it in detail in Chapter 11.

amines: retrosynthetic analysis 2

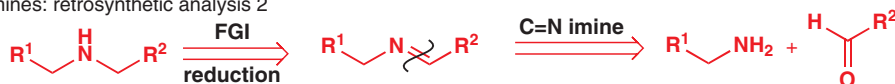

amines: synthesis 2 (reductive amination)

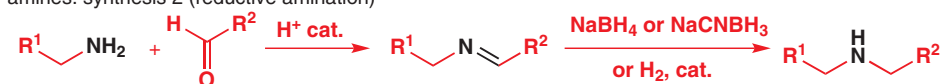

Ocfentanil is an opioid painkiller that lacks the addictive properties of morphine. Disconnection of the amide gives a secondary amine that we can convert to an imine for disconnection to a ketone plus 2-fluoroaniline.

ocfentanil:
retrosynthetic
analysis

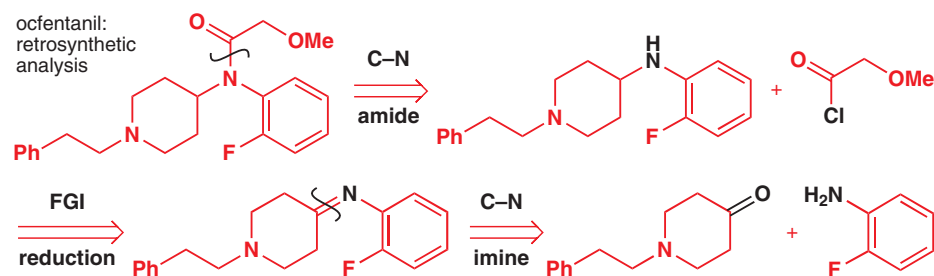

The synthesis is straightforward: a reductive amination followed by acylation of the only remaining NH group. The tertiary amine in the left-hand ring interferes with neither of these reactions.

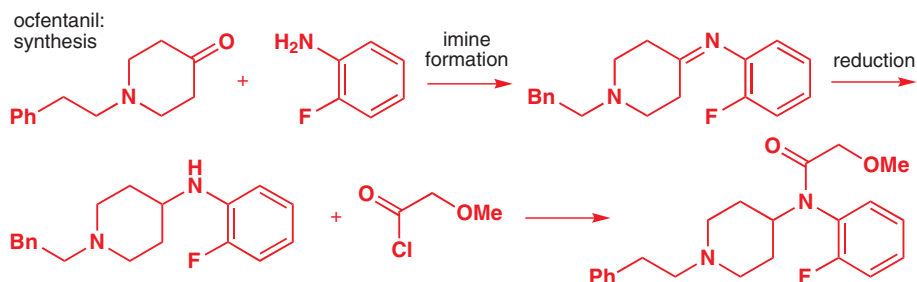

There are several conceivable routes to the neuroactive drug fenfluramine—one analysis, which uses both the amide and the imine FGI methods, is shown below and this is the route used to make the drug. Notice that the oxime is used instead of the imine. *N*-unsubstituted imines are very unstable, and the much more stable—indeed isolable—oxime serves the same purpose. Oximes are generally reduced with LiAlH_4 .

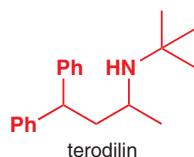
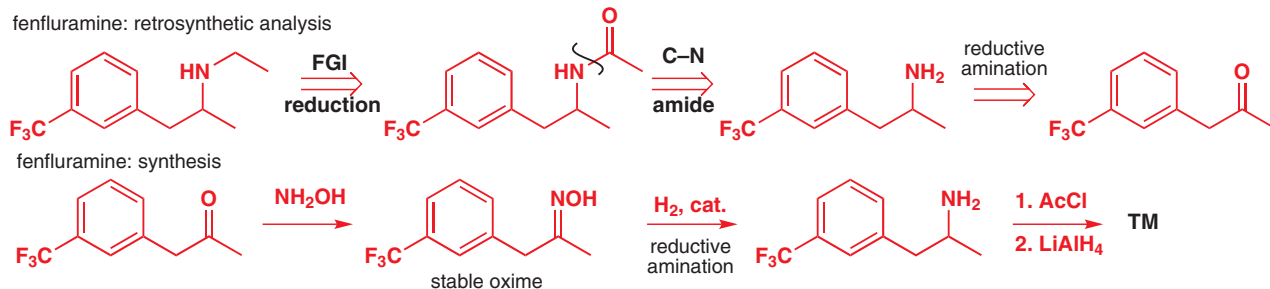

You should now be able to suggest a plausible analysis of the secondary amine terodilin. The structure is in the margin; write down a retrosynthetic analysis and suggested synthesis before looking at the actual synthesis below.

You should find yourself quite restricted in choice: the amide route clearly works only if there is a CH_2 group next to the nitrogen (this comes from the $\text{C}=\text{O}$ reduction), so we have to use an imine.

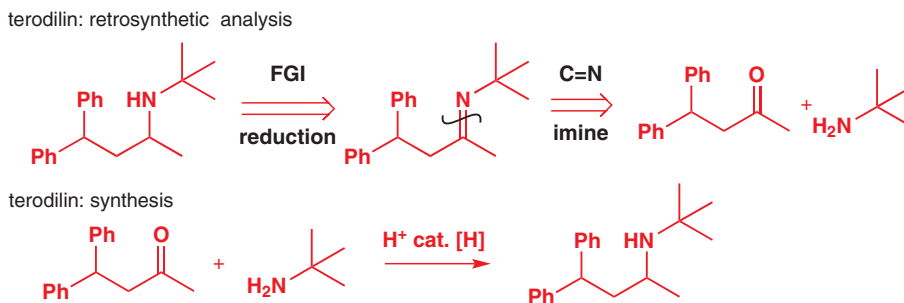

➡ See Chapter 23 for more on this.

In the synthesis of terodilin, it was not necessary to isolate the imine—reduction of imines is faster than reduction of ketones, so formation of the imine in the presence of a mild reducing agent (usually NaCNBH_3 or catalytic hydrogenation) can give the amine directly.

Two-group disconnections are better than one-group disconnections

This compound was needed for some research into the mechanisms of rearrangements. We can disconnect on either side of the ether oxygen atom, but (b) is much better because (a) does not correspond to a reliable reaction: it might be hard to control selective alkylation of the primary hydroxyl group in the presence of the secondary one.

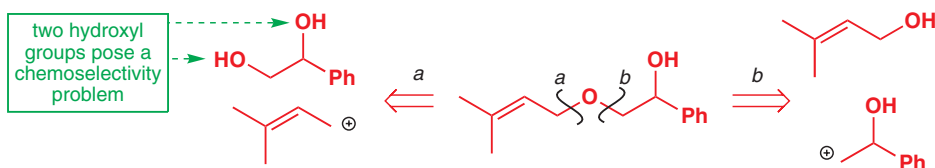

You might think that the best reagent to use as the equivalent of the synthon B would be bromide C. Be more ingenious! A much better solution is to use the epoxide D. Nucleophilic attack on the less hindered terminal carbon atom of the epoxide gives us the type of compound we want, and this was how the target molecule was made.

In using the epoxide we have gone one step beyond all the disconnections we have talked about so far because we have *used one functional group to help disconnect another*—in other words, we noticed the alcohol adjacent to the ether we wanted to disconnect and managed to involve them both in the disconnection. Such disconnections are known as two-group disconnections, and you should always be on the look-out for opportunities of using them because they are an efficient way of getting back to simple starting materials. We call this epoxide disconnection a 1,2-disconnection because the two functional groups in the two-group disconnection are in a 1,2-relationship.

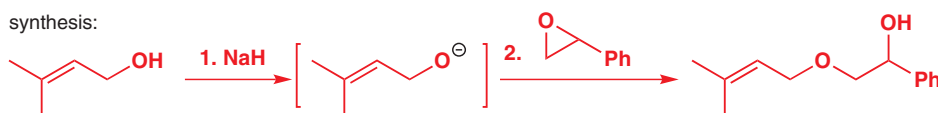
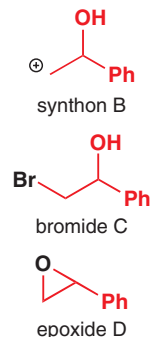

Drug molecules often have 1,2-related functional groups: 2-amino alcohols form one important class. Phenyramidol, for example, is a muscle relaxant. A simple two-group disconnection takes it straight back to 2-amino pyridine and styrene oxide.

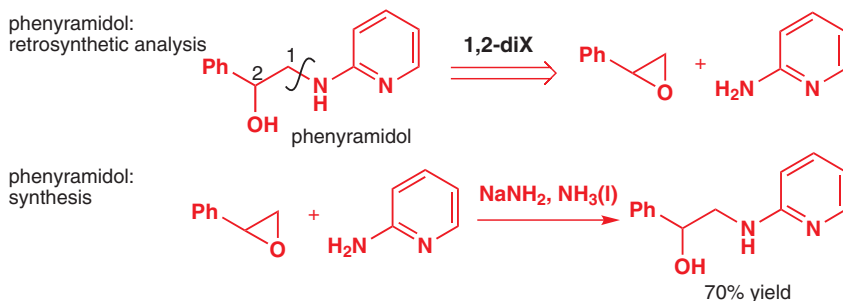

Notice that we have written '1,2-diX' above the arrow to show that it's a two-group ('diX') disconnection—we've also numbered the carbon atoms in the starting material to show the 1,2-relationship. It may seem trivial in such a simple example, but it's a useful part of the process of writing retrosynthetic analyses because it helps you to spot opportunities for making two-group disconnections.

1,2-Disconnections

The drug propranolol is a beta-blocker that reduces blood pressure and was once one of the top-selling drugs worldwide. It has two 1,2-relationships in its structure but it is best to disconnect the more reactive amine group first. The second disconnection can't make use of an epoxide, but a simple ether disconnection takes us back to 1-naphthol and epichlorohydrin, a common starting material for this type of compound.

■ The observant among you may now be questioning why this synthesis is successful—after all, we have made a secondary amine by alkylating a primary one with an epoxide—exactly the sort of thing we advised against on p. 700. Alkylations with epoxides usually stop after the first step because the inductively electron-withdrawing hydroxyl group in the product makes it less nucleophilic than the starting material. In the synthesis of ICID7114 intermediate on p. 699, it's this same effect that prevents the amine being multiply alkylated.

Epichlorohydrin

Epichlorohydrin is a useful starting material for 1,2,3-substituted compounds. The epoxide is more electrophilic than the C—Cl bond, and the mechanism of the first step of the synthesis is surprising.

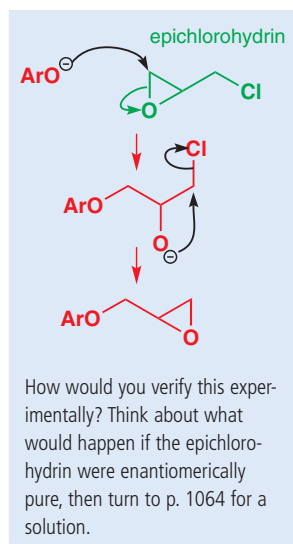

propranolol: retrosynthetic analysis

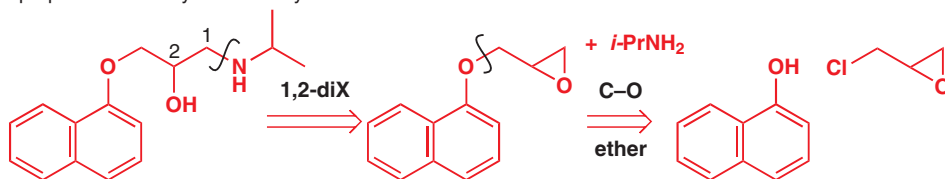

propranolol: synthesis

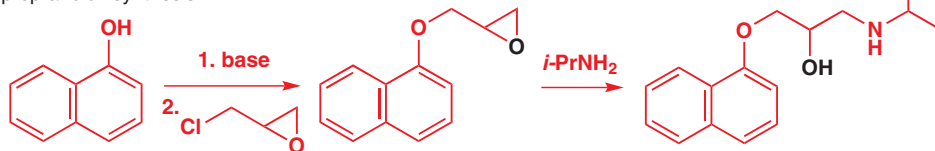

Moxnidazole is an antiparasitic drug, and our next target molecule is an important intermediate in its synthesis. The obvious first disconnection is of the carbamate group, revealing two 1,2-relationships. A 1,2-diX disconnection gives an epoxide that can be made by alkylation of morpholine with epichlorohydrin.

moxnidazole intermediate: retrosynthesis

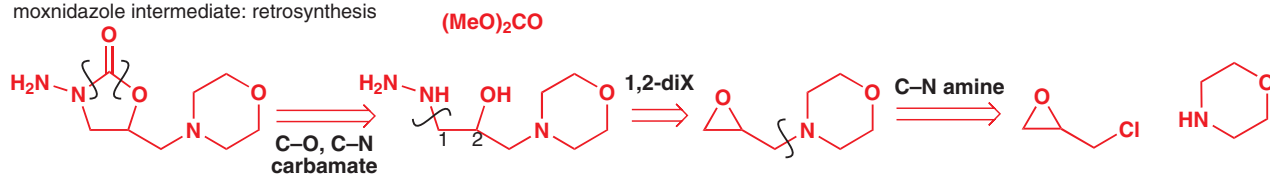

moxnidazole intermediate: synthesis

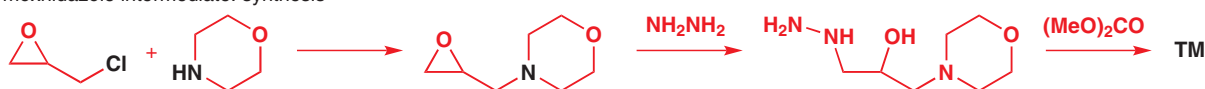

1,2-Disconnections with carbonyl compounds

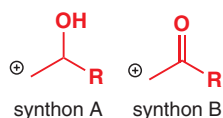

Just as epoxides are useful reagents for synthon A, so α -halocarbonyl compounds are useful reagents for the carbonyl equivalent, synthon B. We can consider disconnection to this synthon to be a two-group disconnection because the α -halocarbonyl compounds are easily made by halogenation of a ketone, ester, or carboxylic acid (see Chapter 20) and the carbonyl group adjacent to the halide makes them extremely reactive electrophiles (Chapter 15).

Nafimidone is an anticonvulsant drug with an obvious two-group disconnection of this type. The α -chloroketone is simply made by chlorination, and substitution is rapid and efficient even with the weakly basic (Chapter 8) heterocycle imidazole.

nafimidone: retrosynthetic analysis

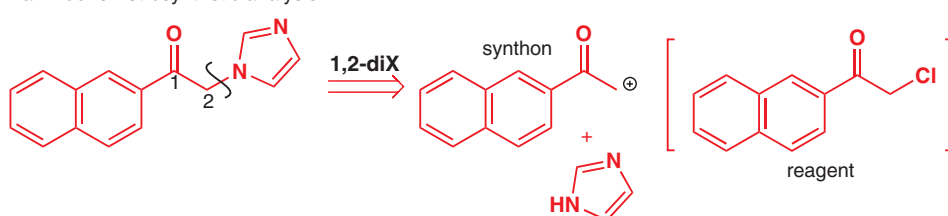

nafimidone: synthesis

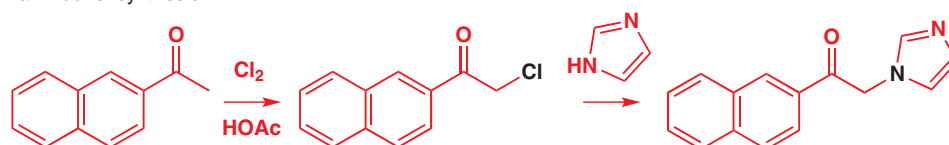

The aldehyde below was needed by ICI when they were developing a thromboxane antagonist. Two-group disconnection gives a 2-halo-aldehyde that can be made from isobutyraldehyde.

ICI aldehyde: retrosynthetic analysis

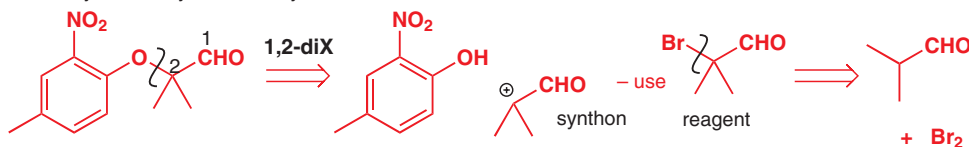

The synthesis requires a normal bromination of a carbonyl compound in acid solution but the next step is a most unusual S_N2 reaction at a *tertiary* centre. This happens because of the activation by the aldehyde group (Chapter 15) and is further evidence that the functional groups must be thought of as working together in this type of synthesis.

ICI aldehyde: synthesis

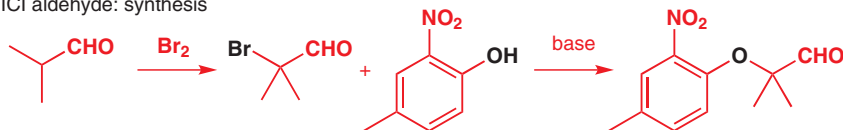

1,3-Disconnections

In Chapter 22 you saw how α,β -unsaturated carbonyl compounds undergo conjugate additions—reactions like this:

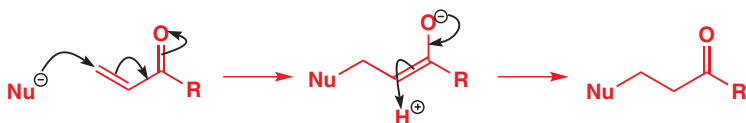

Two-group 1,3-disconnections are therefore possible because they correspond to this forward reaction. These Michael acceptors have an electrophilic site two atoms away from the carbonyl group, and are therefore the reagents corresponding to this synthon.

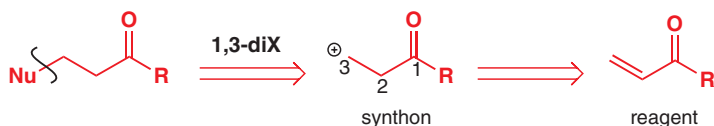

This type of reaction is available only when the alkene is conjugated to an electron-withdrawing group—usually carbonyl, but it can be nitro, cyanide, etc. (Chapter 22). This disconnection is available only at this oxidation level. We can do a two-group 1,3-disconnection on this sulfide, for example.

retrosynthetic analysis

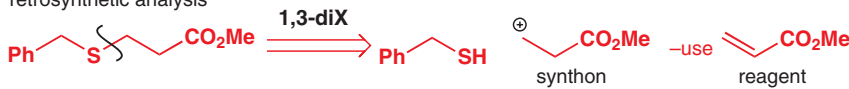

synthesis



➔ Don't be tempted to try using β -haloesters as equivalents for this synthon! They are hard to make and unstable and they undergo rapid $E1cB$ elimination (see Chapter 17).

Remember that not all nucleophiles will successfully undergo Michael additions—you must bear this in mind when making a 1,3-disconnection of this type. Most reliable are those based on nitrogen, sulfur, and oxygen (Chapter 22). Our second example is an amine structurally similar to the 'deadly nightshade' drug, atropine, which has the ability to calm involuntary muscle movements. There is a 1,3-relationship between the amine and ketone functional groups, and 1,3-disconnection takes us back to piperidine and an unsaturated ketone.

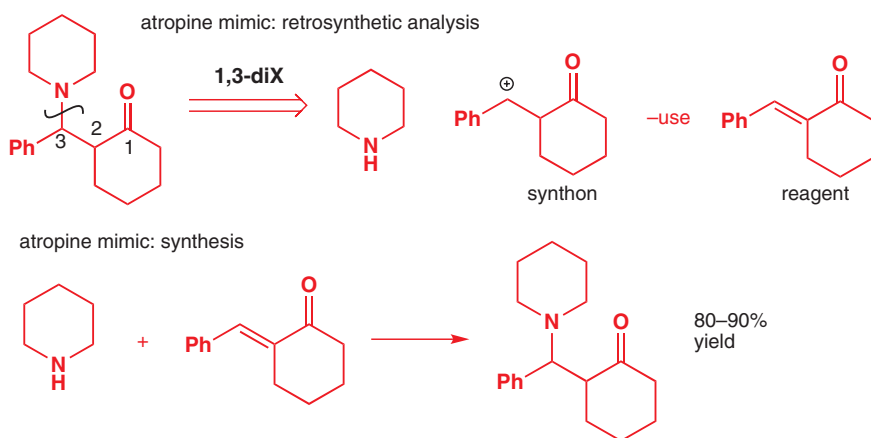

► We shall discuss ways of disconnecting this starting material, and other α,β -unsaturated carbonyl compounds, later in the chapter.

To summarize...

Before we leave C–X disconnections and go on to look at C–C disconnections we should just review some important points. We suggested three guidelines for choosing disconnections and now that you have met the principle of two-group disconnections, we can add a fourth:

● Guidelines for good disconnections

- 1 Disconnections must correspond to known, reliable reactions.
- 2 For compounds consisting of two parts joined by a heteroatom, disconnect next to the heteroatom.
- 3 Consider alternative disconnections and choose routes that avoid chemoselectivity problems—often this means disconnecting reactive groups first.
- 4 Use two-group disconnections wherever possible.

Two-group disconnections reduce the complexity of a target molecule more efficiently than one-group disconnections, and you should always be on the look-out for them. You will meet more two-group disconnections in the next section, which deals with how to disconnect C–C bonds.

C–C disconnections

The disconnections we have made so far have all been of C–O, C–N, or C–S bonds, but, of course, the most important reactions in organic synthesis are those that build the carbon skeleton by forming C–C bonds. We can analyse C–C disconnections in much the same way as we've analysed C–X disconnections. Consider, for example, how you might make the simple compound in the margin, which is an intermediate in the synthesis of a carnation perfume.

The only functional group is the triple bond, and we shall want to use the chemistry of alkynes to show us where to disconnect. You know that alkylation of alkynes is a reliable reaction, so a sensible disconnection is next to the triple bond.

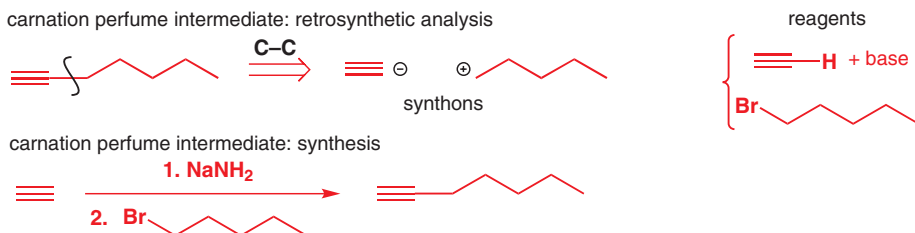

► The alkylation of alkyne anions is described in Chapter 9.

Alkynes are particularly valuable as synthetic intermediates because they can be reduced either to *cis* or to *trans* double bonds.



➔ You met these reductions in Chapter 27.

It's often a good idea to start retrosynthetic analysis of target molecules containing isolated double bonds by considering FGI to the alkyne because C–C disconnections can then become quite easy. The *cis*-alkene below is an intermediate in the synthesis of a component of violet oil. FGI to the alkyne reveals two further disconnections that make use of alkyne alkylations. The reagent we need for the first of these is, of course, the epoxide as there is a 1,2-relationship between the OH group and the alkyne.

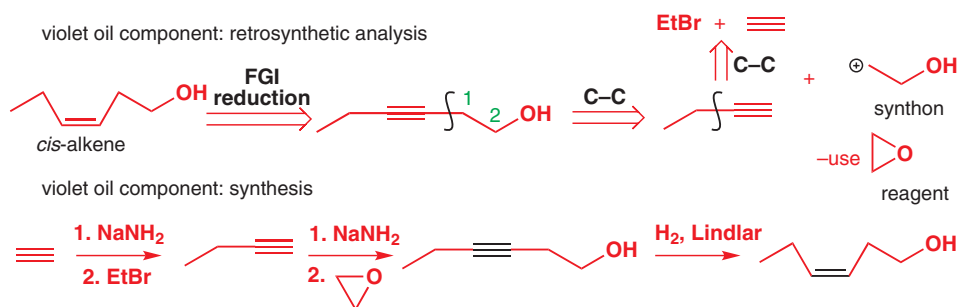

■ There are, of course, many other ways of disconnecting double bonds: you are about to meet an important disconnection of double bonds conjugated with carbonyl groups. Chapter 27 covered the alternative methods available for making double bonds and controlling their stereochemistry.

The next example is the pheromone of the pea-moth, and can be used to trap the insects. After disconnecting the ester, FGI on the *trans* double bond gives an alkyne.

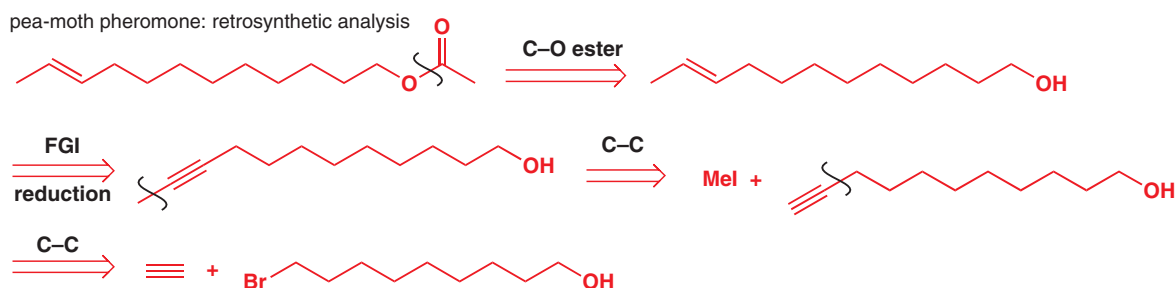

Disconnection on either side of the alkyne leads us back to a bromo-alcohol alkylating agent. In the synthesis of the pheromone, it turned out to be best if the hydroxyl group was protected as its THP ether. You should be able to think of other alkylation-type reactions that you have met that proceed reliably and therefore provide a good basis for a disconnection—the alkylation of enolates of esters or ketones, for example (Chapter 25).

➔ Protecting groups were discussed in detail in Chapter 23 and THP is on p. 551.

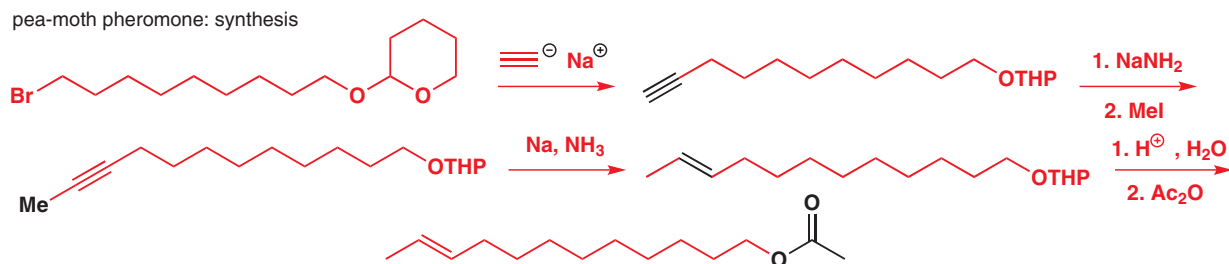

1,2 C–C disconnections

This next ester was needed for a synthesis of the sedative roglitimide (see later for the full synthesis). The ethyl group is disconnected because it can be readily introduced by alkylation of the ester enolate.

rogletimide intermediate: retrosynthetic analysis

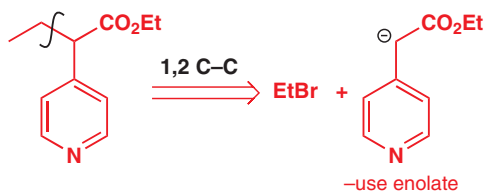

rogletimide intermediate: synthesis

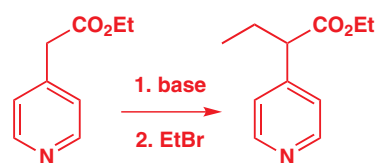

We have labelled the disconnection '1,2 C-C' because the new C-C bond is forming two atoms away from the carbonyl group. To spot disconnections of this sort, you need to look for alkyl groups in this 2-position.

Arildone is a drug that prevents polio and herpes simplex viruses from 'unwrapping' their DNA, and renders them harmless. It has just the structural characteristic you should be looking for: a branch next to a carbonyl group,

arildone: retrosynthetic analysis

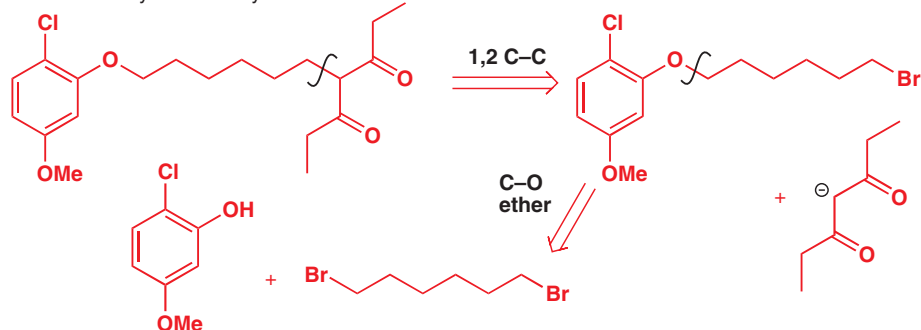

■ Look back to Chapter 25 if you don't understand why.

With two carbonyl groups, the alkylation should be particularly straightforward since we can use a base like methoxide. The ether disconnection is then immediately obvious. In the synthesis of arildone the alkyl iodide was used for the alkylation.

arildone: synthesis

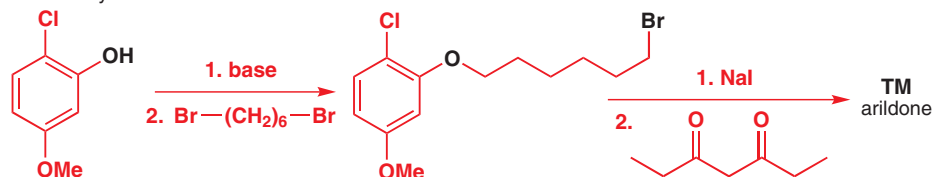

We introduced the chemistry of malonate esters in Chapters 20 and 25 as a useful way of controlling the enolization of carbonyl compounds. Alkylation followed by decarboxylation means that we can treat acetoacetate and malonate esters as equivalent for these synthons.

■ Having read Chapter 26, you should be able to suggest why the enolate of acetone itself would not be a good choice in this reaction.



This unsaturated ketone is an important industrial precursor to β -carotene, vitamin A, and other similar molecules. Disconnection using the carbonyl group gives a synthon for which a good reagent will be acetoacetate.

carotene precursor: retrosynthetic analysis

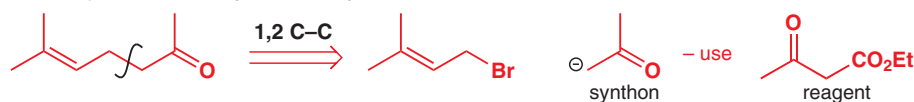

carotene precursor: synthesis

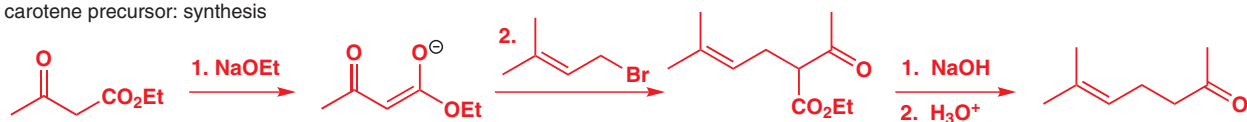

This organophosphorus compound, belfosil, is a Ca^{2+} channel blocker. You haven't met many phosphorus compounds yet, but you should be able to reason that a good disconnection will be the C–P bond by analogy with the sulfides you met earlier in the chapter. We could use bromide as a leaving group, but alkyl bromides are inconvenient to disconnect further, so we go back to the more versatile diol—in the forward synthesis we shall need a way of making the OH groups into good leaving groups. There is still no obvious disconnection of the diol, but FGI to the ester oxidation level reveals a malonate derivative.

belfosil: retrosynthetic analysis

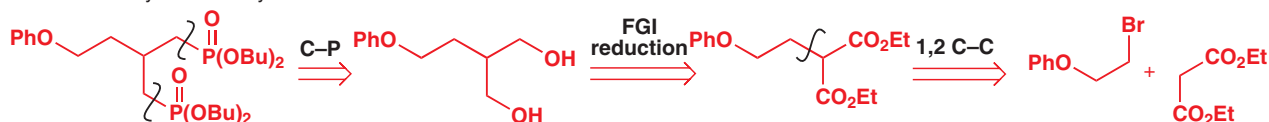

In the synthesis, the diol was converted to the bis-tosylate (see Chapter 15 if you've forgotten about tosylates and mesylates) and combined with a phosphorus nucleophile.

belfosil: synthesis

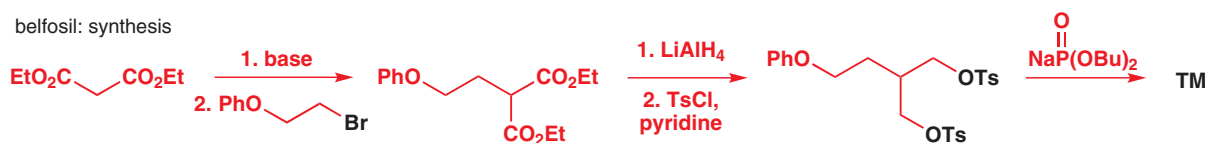

Notice how we disconnected the phosphorus-based functional groups straight back to alcohols in the retrosynthetic analysis, and not, say, to alkyl halides. Oxygen-based functional groups (alcohols, aldehydes, ketones, esters, and acids) have one important property in common—versatility. They are easily converted into each other by oxidation and reduction, and into other groups by substitution. What is more, many of the C–C disconnections you will meet correspond to reactions of oxygen-based groups, and particularly carbonyl groups. Faced with an unusual functional group in a target molecule the best thing to do is convert it to an oxygen-based group at the same oxidation level—it usually makes subsequent C–C disconnections simpler. So we add a new guideline.

● Guideline 5

Convert to oxygen-based functional groups to facilitate C–C disconnections.

In each of the cases you have met so far, we have used a functional group present in the molecule to help us to disconnect the C–C bond using a 1,2 C–C disconnection. You can look for 1,2 C–C disconnections in alkynes, carbonyl compounds, and alkylated aromatic rings. And, if the target isn't a carbonyl compound, consider what would be possible if functional groups such as hydroxyl groups were converted to carbonyl groups (just as we did with belfosil).

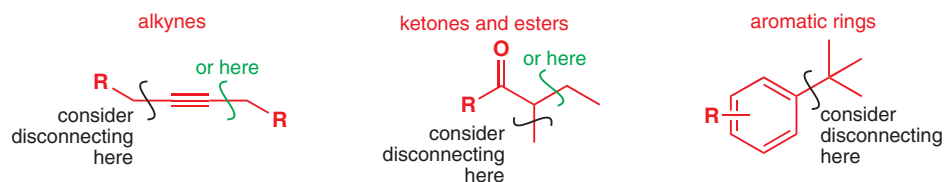

1,1 C–C disconnections

All of these disconnections relied on the reaction of a carbon electrophile with a nucleophilic functional group. The alternative, reaction of a carbon nucleophile (such as a Grignard reagent) with an electrophilic functional group, allows us to do C–C disconnections on alcohols. For example, this compound, which has a fragrance reminiscent of lilac, is a useful perfume in soap because (unlike many other perfumes that are aldehydes or ketones) it is stable to alkali.

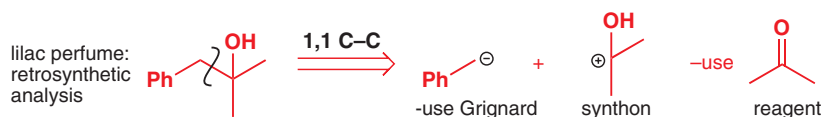

We look to the one functional group, the hydroxyl, to tell us where to disconnect, and disconnection next to the OH group gives two synthons for which sensible reagents are a Grignard reagent and acetone. The perfume is made from benzyl chloride and acetone in this way. Notice that we label these disconnections 1,1 C–C because the bond being disconnected is attached to the same carbon atom as the hydroxyl functional group.

lilac perfume: synthesis

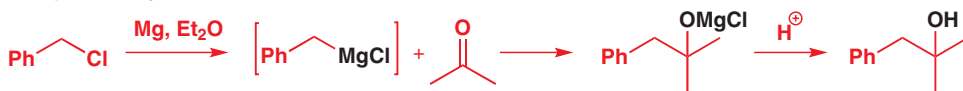

This similar alcohol has a 'peony-like fruity odour' and could be disconnection in three ways.

fruity peony perfume: retrosynthetic analysis

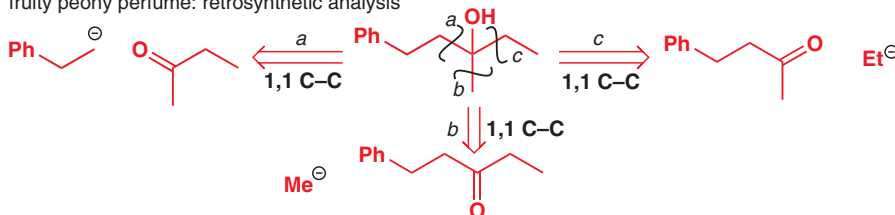

Disconnection (c) leads back to a ketone, which is cheaply made starting from acetone and benzaldehyde, and this was the route that was chosen for the synthesis.

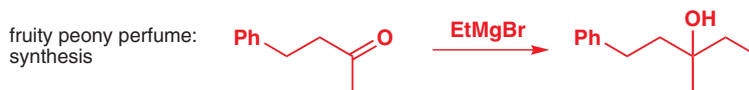

■ The synthesis of this starting material involves an aldol reaction between acetone and benzaldehyde of the sort discussed in Chapter 26 followed by hydrogenation of the double bond.

Double disconnections can be a short cut

Tertiary alcohols with two identical groups next to the hydroxyl group are often made by attack of two equivalents of a Grignard reagent on an ester. The synthesis of the antihistamine compound fenpiprane provides an example: the tertiary alcohol is a precursor to the drug and can be disconnected to ester + Grignard reagent because of the two Ph groups. The ester required has a 1,3 functional group relationship, and can be disconnected to amine plus Michael acceptor.

fenpiprane precursor: retrosynthetic analysis

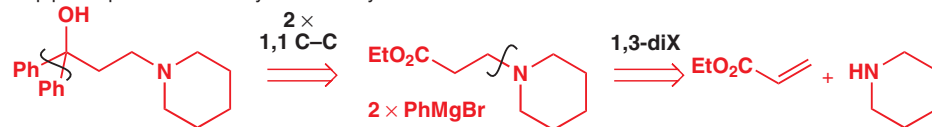

fenpiprane precursor: synthesis

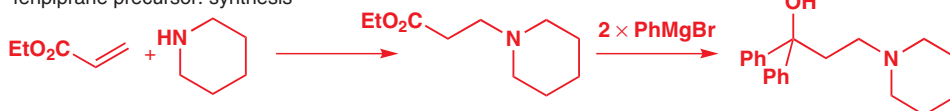

➔ We talked about a few ways of doing this type of reaction in Chapter 10.

The fact that Grignard reagents add twice to esters means that disconnection of a ketone in this way is often not reliable because the Grignard reagent adds to the ketone.



An alternative is to first convert to the alcohol oxidation level, then disconnect. This was the method chosen for this starting material for the synthesis of chlorphedianol.

chlorphedianol starting material: retrosynthetic analysis

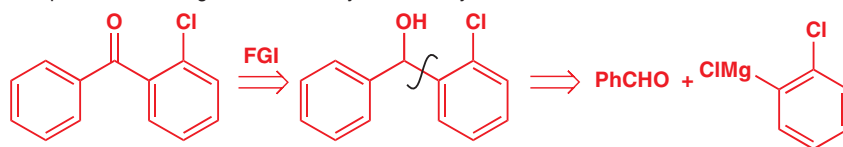

chlorphedianol starting material: synthesis

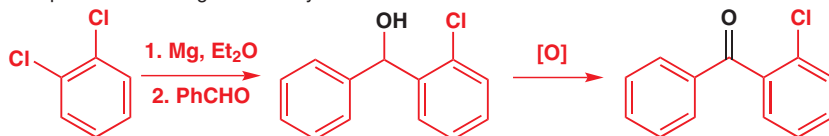

• A summary: 1,1-disconnections using Grignard reagents

secondary alcohols

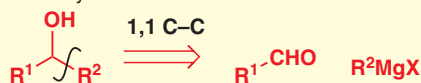

tertiary alcohols

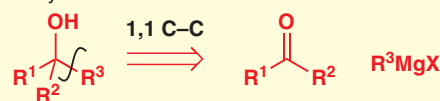

ketones

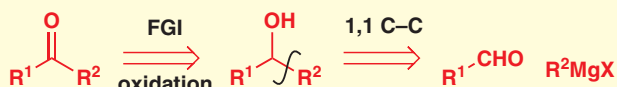

tertiary alcohols with $R^2 = R^3$

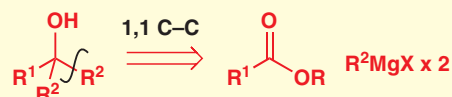

Available starting materials

Although any of the three routes to the 'fruity peony perfume' on p. 710 would give an acceptable synthesis, the key factor in choosing route (c) was the ease of synthesis of the starting materials from available compounds. But how can you know which materials will be available? So far in this chapter we have avoided this question, and often our retrosynthetic analyses have been incomplete because the suggested starting materials must themselves be synthesized in the laboratory. From now on, however, we will take every analysis back to available starting materials to help you get a feel for what is, and is not, available.

The only way to be absolutely sure what you can buy is to look up a compound in a supplier's catalogue, and this is what a chemist would do when assessing possible alternative synthetic routes. A good rule of thumb is that **compounds with up to about six carbon atoms and with one functional group** (alcohol, aldehyde, ketone, acid, amine, double bond, or alkyl halide) are usually available. This is less true for heavily branched compounds, but most straight-chain compounds with these functional groups are available up to eight or more carbon atoms. Cyclic compounds with one functional group from five-to eight-membered are also available. Of course, many other compounds are available too, including some difunctional compounds. Here are a few of them.

acetoacetates

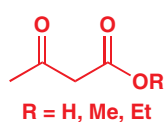

malonates

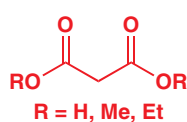

acrylates ($R = \text{H}$); methacrylates ($R = \text{Me}$)

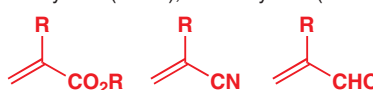

You will soon start to appreciate what is available as you see which compounds we use as starting materials. Supplier's catalogues are available free for the asking and make quite useful

textbooks. You could consider getting one. In addition, online and CD catalogues are available in most chemistry departments and can be searched by structure.

Donor and acceptor synthons

You've now met a variety of synthons and it's useful to be able to classify them as *donor* or *acceptor* synthons. We call a negatively polarized synthon a donor synthon and give it the symbol 'd'. Positively polarized synthons are called acceptor synthons and are given the symbol 'a'.

We can classify the synthons further according to where the functional group is in relation to the reactive site. The first synthon in the diagram below, which corresponds to an aldehyde, we call an a¹ synthon because it is an acceptor that carries a functional group on the same carbon as its reactive centre. The second is a d² synthon because it is a donor whose reacting site is in the 2-position relative to the carbonyl group. Earlier you met two other types of synthon, corresponding to epoxide and Michael acceptor, and we can now classify these as a² and a³ synthons.

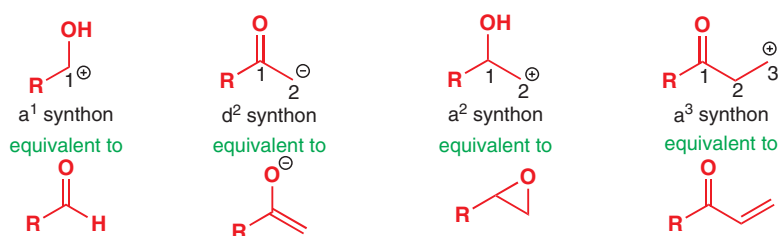

This terminology is useful because it reduces synthons to the bare essentials: what polarity they are and where the polarity is sited. The actual functional group they carry is, as you now appreciate, less important because FGI will usually allow us to turn one functional group into another.

- Synthons are classified as a (acceptor) or d (donor)

A number shows the position of the acceptor or donor site relative to a functional group. An example of an a¹ synthon is a carbonyl compound and an example of a d² synthon is an enolate or an enolate equivalent.

Two-group C–C disconnections

1,3-Difunctionalized compounds

It's not only Grignard reagents that will react with aldehydes or ketones to make alcohols: enolates will too—we spent Chapter 26 discussing this reaction, the aldol reaction, its variants, and ways to control it.

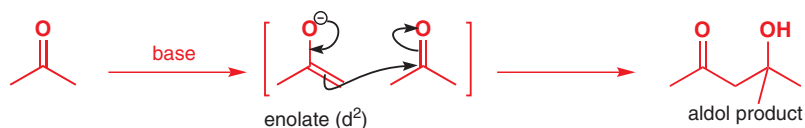

The aldol reaction is extremely important in organic synthesis because it makes compounds with two functional groups in a 1,3-relationship. Whenever you spot this 1,3-relationship in a target molecule—think aldol! In disconnection terms we can represent it like this.

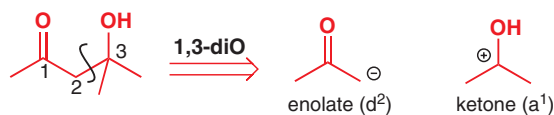

We call this disconnection a two-group C–C disconnection because we are using the OH and the C=O groups together to guide our disconnection. The disconnection gives us a d^2 synthon, for which we shall use an enolate equivalent, and an a^1 synthon, for which we shall use an aldehyde or a ketone. Chapter 26 has many examples and perhaps gingerol is the best. As soon as you see the 1,3-relationship, the disconnection should be obvious.

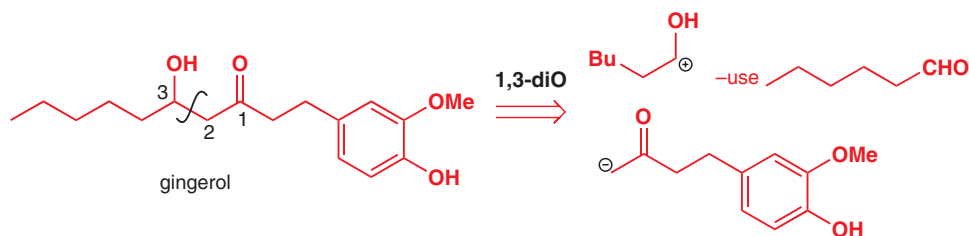

The β -hydroxy carbonyl products of aldol reactions are often very easily dehydrated to give α,β -unsaturated carbonyl compounds and if you spot an α,β -unsaturated carbonyl group in the molecule, you should aim to make it by an aldol reaction. You will first need to do an FGI to the β -hydroxy carbonyl compound, then disconnect as before.

oxanamide intermediate: retrosynthetic analysis

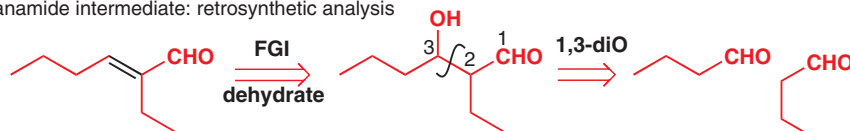

This aldehyde is an intermediate in the synthesis of the tranquillizer oxanamide. Because both components of the aldol reaction are the same, no special precautions need to be taken to prevent side reactions occurring. In the synthesis, the dehydration happens spontaneously.

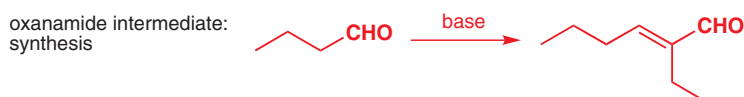

■ The elimination is easy because it goes by an $E1cB$ mechanism—see Chapters 17 and 26.

Because this disconnection of unsaturated carbonyl compounds is so common, it's often written using a shorthand expression.

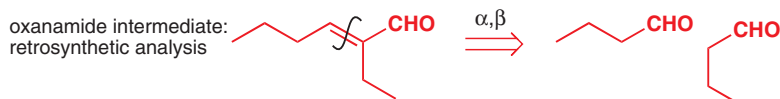

The next compound was needed for an early synthesis of carotene. Again, it's an α,β -unsaturated ketone so we can disconnect using the same ' α,β ' disconnection. The aldehyde generated by this first disconnection is also α,β -unsaturated, so we can do another α,β disconnection, back to a ketone whose synthesis we have already discussed (p. 708).

carotene intermediate: retrosynthetic analysis

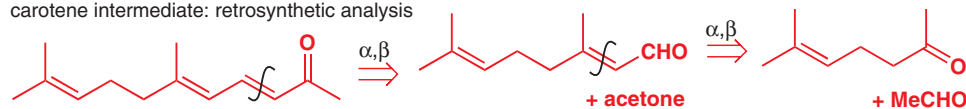

An aldol reaction using the enolate of acetaldehyde and requiring it to react with a ketone is doomed to failure: acetaldehyde itself is far too good an electrophile. In the forward synthesis, therefore, this first step was carried out at the ester oxidation level, and the ester was subsequently converted to the aldehyde by a reduction of the kind discussed in Chapter 23.

➔ The ester aldol with the zinc enolate is an example of the Reformsky reaction, p. 631.

carotene intermediate: synthesis

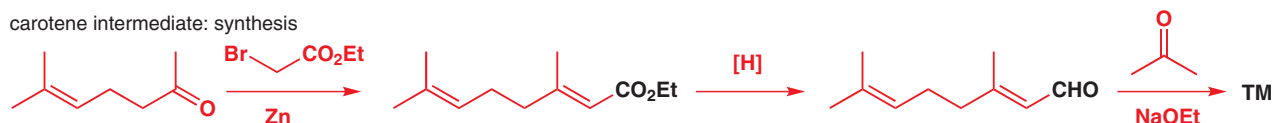

■ If you don't understand what we are saying here, you must go back and read Chapter 26 on selectivity in the aldol reaction.

There was no problem with selectivity in the second aldol reaction because the aldehyde is not enolizable. The Reformatsky reaction in this sequence illustrates the fact that, as you saw in Chapter 26, aldol-type reactions happen at the ester oxidation level as well, and you should equally look to disconnect β -hydroxy or α,β -unsaturated esters, acids, or nitriles in this way. Just remember to look for 1,3-relationships, convert the functional groups to oxygen-based ones, and disconnect them to d^2 plus a^1 synthons.

The next compound was needed when chemists were developing a thromboxane antagonist to inhibit blood clot formation. You can immediately spot the 1,3-relationship between the ester and the hydroxyl group, so 1,3-diO disconnection is called for.

thromboxane antagonist intermediate: retrosynthetic analysis

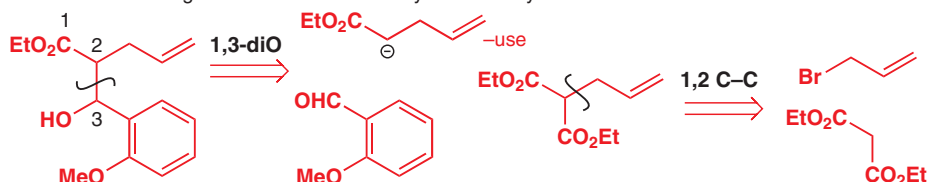

► Malonate alkylation is discussed in Chapter 25, p. 596.

A good equivalent for the 'ester enolate' d^2 synthon is a β -dicarbonyl compound because it can easily be disconnected to diethyl malonate and an alkylating agent.

thromboxane antagonist intermediate: synthesis

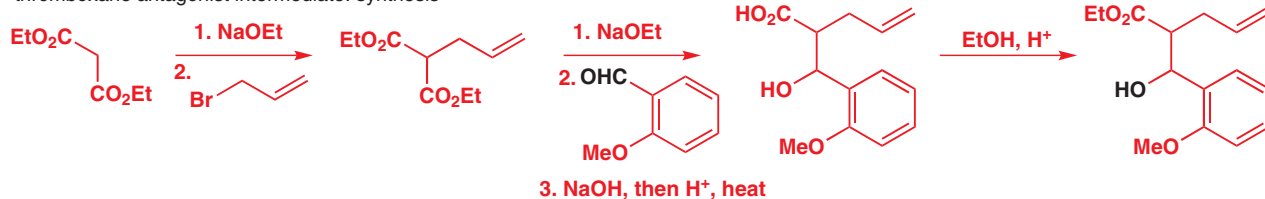

This unsaturated amide is known as cinflumide and is a muscle relaxant. Disconnection of the amide gives an acid chloride that we can make by FGI from the acid. You should then spot the α,β -unsaturated carbonyl disconnection, a masked 1,3-diO disconnection, back to *m*-fluorobenzaldehyde.

cinflumide: retrosynthetic analysis

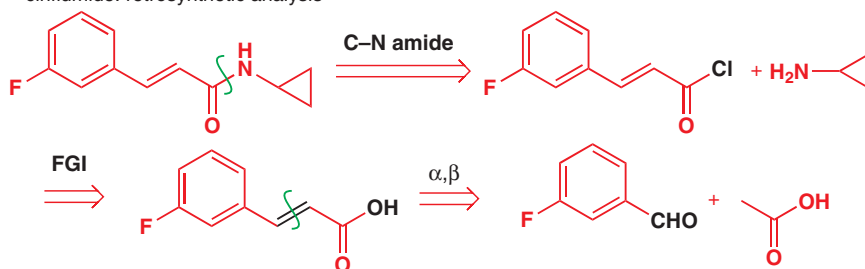

Again, the forward reaction was best done using malonate chemistry, but the variant with malonic acid was used (p. 630). The cyclopropylamine unit (here as an amide) is present in many biologically active compounds and the free amine is available.

cinflumide: synthesis

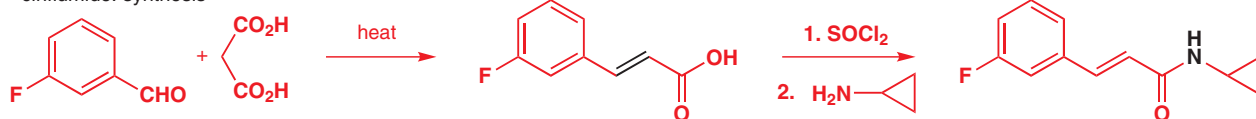

Look out for concealed functional group relationships

The analgesic doxypicomine is a more difficult problem than those you have seen so far. At first sight it has no useful disconnections, especially as there are no carbonyl groups. However,

removal of the acetal reveals a 1,3-diol that could be formed by reduction of a much more promising diester.

doxpicomine: retrosynthetic analysis I

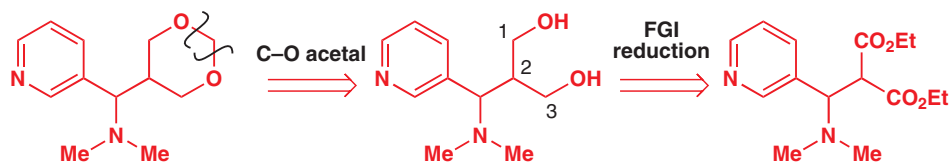

The diester has a 1,3-diCO relationship and could be disconnected but we have in mind using malonate so we would rather disconnect the alternative 3-amino carbonyl compound (the Me₂N group has a 1,3-relationship with both ester groups) by a 1,3-diX disconnection giving an unsaturated ester. This α,β -unsaturated ester disconnects nicely to a heterocyclic aldehyde and diethyl malonate.

doxpicomine: retrosynthetic analysis II

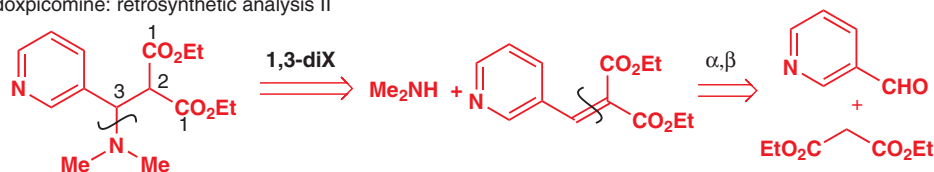

The synthesis is shorter than the retrosynthetic analysis and involves only four steps. Good retrosynthetic analysis, using two-group disconnections, should lead to short syntheses.

doxpicomine: synthesis

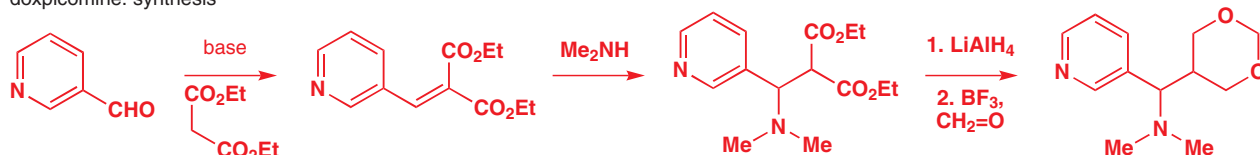

Aldol-style disconnections with N and O in a 1,3-relationship: I

Nitriles form another important class of compounds that undergoes aldol-type additions to aldehydes and ketones. Because nitriles can be reduced to amines, this reaction provides another useful route to 3-amino alcohols.

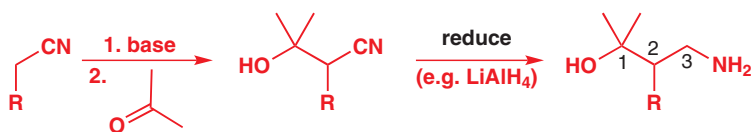

This reaction, coupled with the reduction of cyanohydrins (Chapter 6), means that compounds with either a 1,3- or a 1,2-relationship between N and O can be made from nitriles.

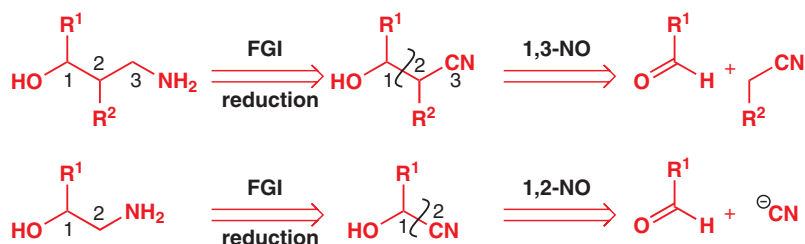

Venlafaxine is an antidepressant and, like many neuroactive agents, it is an amino-alcohol. In this case, the two functional groups are 1,3-related, so we aim to use a 1,3-diO disconnection. Usually, you would convert the amine to an alcohol to simplify the disconnection, but

by spotting the opportunity for using a nitrile you can avoid the need for this extra step. A preliminary removal of the two *N*-Me groups is necessary.

venlafaxine: retrosynthetic analysis

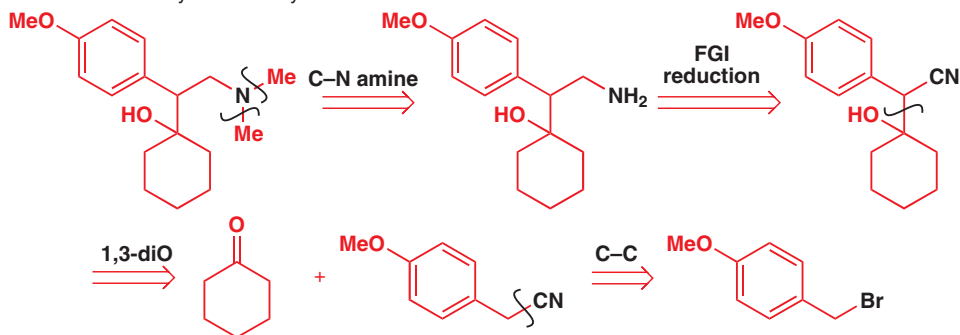

■ This useful way of adding two methyl groups to a primary amine by reductive amination is sometimes called the Eschweiler–Clarke reaction. For more on formic acid as a reducing agent, see Chapter 41, p. 1116.

In the forward synthesis, it turned out that the nitrile reduction was best done using hydrogen and a metal (Rh) catalyst. The final methylation of the primary amine had to be done via the imine and iminium ion (see Chapter 23) to prevent further unwanted alkylations. The reagent was an excess of formaldehyde (methanal $\text{CH}_2=\text{O}$) in the presence of formic acid (HCO_2H), which acts as a reducing agent.

venlafaxine: synthesis

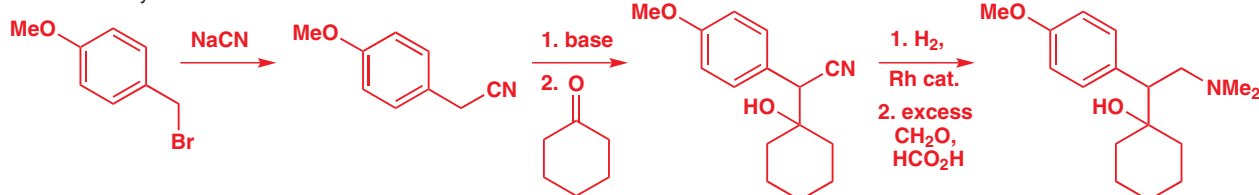

Aldol-style disconnections with N and O in a 1,3-relationship: II—the Mannich reaction

Another important reaction for making amines with a 1,3-relationship to a carbonyl group is the Mannich reaction. You met this reaction in Chapter 26 as a way of doing otherwise unreliable aldol additions to formaldehyde. Because the amine is introduced directly and not by reduction of a nitrile, it can have two alkyl groups from the start. Compare this scheme with the one above using a nitrile group as the source of the amine.

the Mannich disconnection

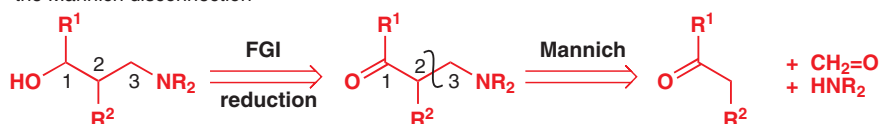

Our example is clobutinol—an antitussive (cough medicine). A preliminary 1,1 C–C disconnection of the tertiary alcohol is necessary to provide a 3-amino ketone that we can make by a Mannich reaction. The product is a mixture of diastereoisomers.

clobutinol: retrosynthetic analysis

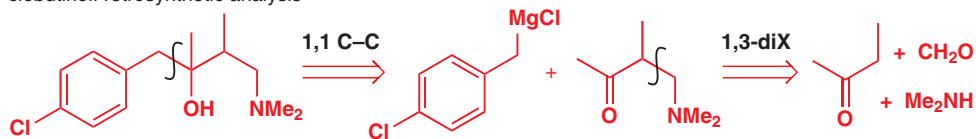

clobutinol: synthesis

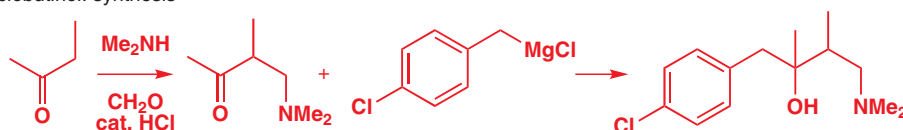

You can immediately spot the 1,3 relationship in this analogue of the antidepressant nisoxetine, but, unfortunately, it can't be disconnected straight back to an amino-alcohol because that would require nucleophilic substitution on an electron-rich aromatic ring. We have to disconnect the ether on the other side, giving an alkyl chloride.

nisoxetine analogue: retrosynthetic analysis

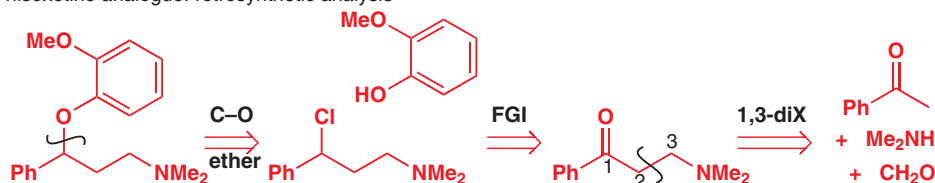

Using Guideline 5 (p. 709) we want to convert the halide to an oxygen-based group, and a sensible solution is to choose the ketone. 1,3-Disconnection of this compound corresponds to a Mannich reaction. This is another case where FGI of the amine to an alcohol is not desirable because the Mannich reaction will produce the amine directly.

nisoxetine analogue: synthesis

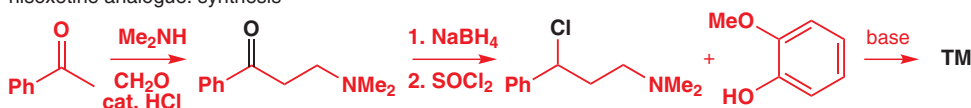

The Claisen ester disconnection: a 1,3-diO relationship needing two carbonyl groups

1,3-Diketones can be disconnected in a similar way: this time the disconnection corresponds to a Claisen condensation, but it's still 1,3-diO and again you need to look out for the 1,3 relationship. The synthons are still d² plus a¹ but the a¹ synthon is used at the ester oxidation level. This diketone is the starting material for the synthesis of the antidepressant tazadolene. With 1,3-diketones, there's always a choice where to disconnect, and you should be guided by which disconnection (a) corresponds to the most reliable reaction and (b) gives the simplest starting materials. In this case, it's much better to disconnect back to cyclohexanone.

tazadolene starting material: retrosynthetic analysis

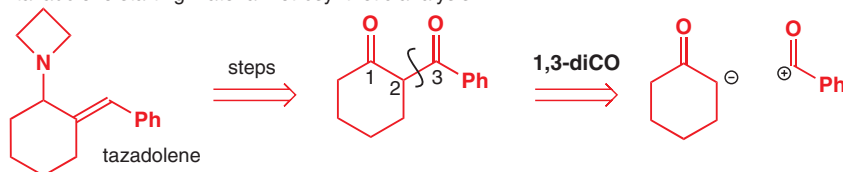

The synthesis is interesting because, after the acylation of the enamine, the amino group is introduced by a clever reductive amination with benzylamine (PhCH₂NH₂) that forms the C–N bond, reduces the ketone, and hydrogenolyses the *N*-benzyl bond (Chapter 23). Dehydration and double alkylation then gives tazadolene. Step 3, the attack of benzylamine on the diketone, has interesting chemoselectivity. Only the ketone in the six-membered ring is attacked while the less reactive conjugated phenyl ketone is not affected.

➔ Enamine acylation is discussed in Chapter 26.

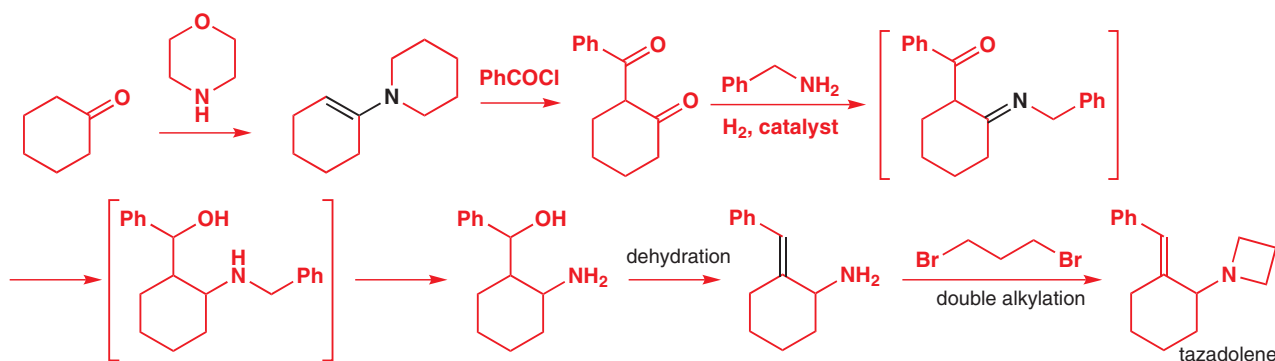

The 1,3-dicarbonyl relationship may not be revealed in the target molecule and C–heteroatom disconnections or FGIs may be needed before the 1,3-diO C–C disconnection. Bropiramine is a bromine-containing antiviral and anticancer drug. The bromine atom can be put in last of all by electrophilic bromination.

bropiramine: retrosynthetic analysis

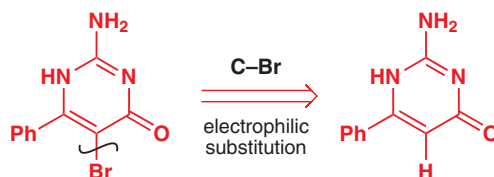

Disconnection of two C–N bonds removes a molecule of guanidine and reveals a 1,3-dicarbonyl relationship with a straightforward disconnection.

➔ Guanidine, the strong delocalized organic base, appeared on p. 175.

bropiramine: retrosynthetic analysis

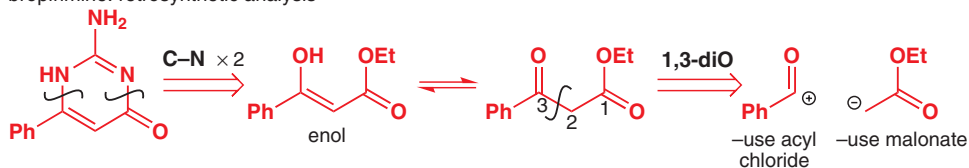

In the event, the 1,3-dicarbonyl was made using malonate chemistry with an unusual twist: the lithium derivative gave C–acylation in good yield. Simply refluxing the product with guanidine formed the heterocycle and bromination gave bropiramine.

bropiramine: synthesis

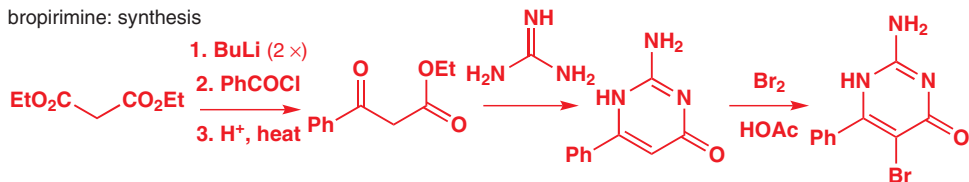

■ This example doubles up as an early demonstration that you can use carbonyl chemistry to make aromatic heterocycles. Aromatic heterocycles are the subject of the next two chapters, 29 and 30.

● Summary: 1,3-diO disconnections

3-hydroxy carbonyls and α,β -unsaturated carbonyls: use the aldol reaction

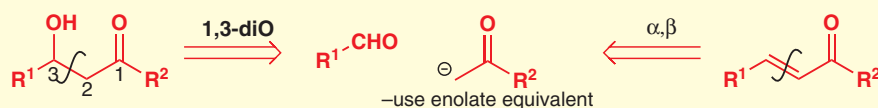

3-amino ketones and alcohols: use Mannich or nitrile aldol

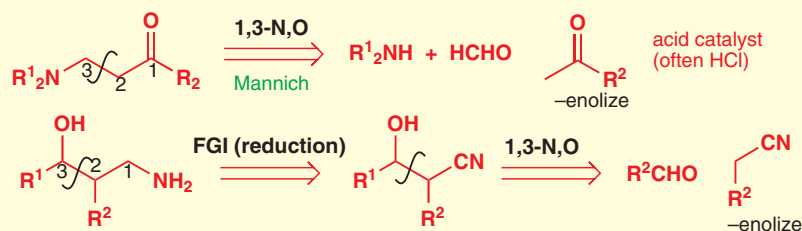

1,3-diketones: use the Claisen condensation

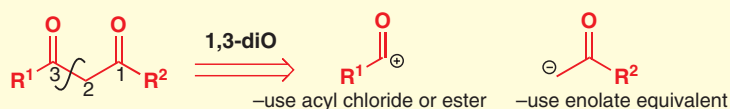

1,5-Related functional groups

This compound has a 1,5 rather than a 1,3 relationship between two carbonyl groups. Disconnection to give an enolate as one reagent therefore requires an a^3 rather than an a^1 synthon: in other words a Michael acceptor.

1,5-dicarbonyl compounds: retrosynthetic analysis



As discussed in Chapter 25, the synthesis will be successful only if (a) the right reagent enolizes and (b) the nucleophile undergoes conjugate (and not direct 1,2-) addition to the unsaturated carbonyl compound. Malonate derivatives enolize easily *and* do Michael additions and are therefore a good choice for this type of reaction.

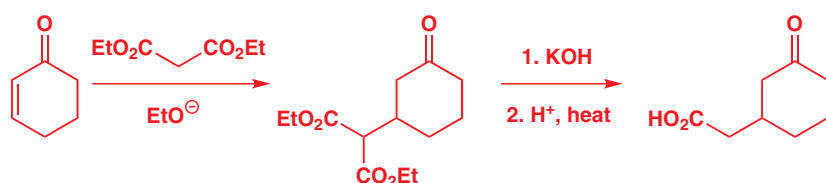

Michael addition of enolates to α,β -unsaturated compounds is a good way of making 1,5-difunctionalized compounds, and you should look for these 1,5-relationships in target molecules with a view to making them in this way. Our example is rogetimide, a sedative that can be disconnected to a 1,5-diester. Further 1,5-diCO disconnection gives a compound we made earlier by ethylation of the ester enolate.

rogetimide: retrosynthetic analysis



The synthesis was most efficient with an unsaturated amide as Michael acceptor.

rogetimide: synthesis

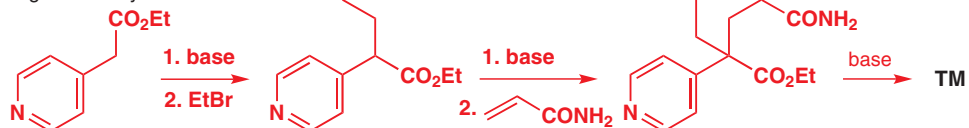

➔ There are many examples of conjugate addition of enolates in Chapter 26.

'Natural reactivity' and 'umpolung'

Cast your mind back over the synthons we have used in these two-group C-C disconnections.

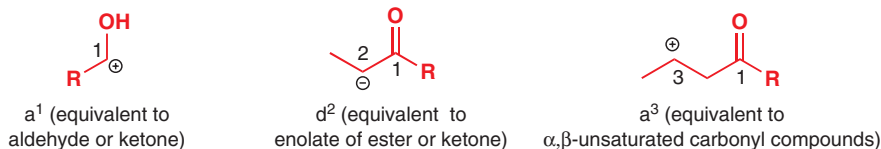

Notice that the acceptor synthons have odd numbers; the donor synthon has an even number: donor and acceptor properties alternate along the chain as we move away from a carbonyl group. This ‘natural reactivity’ of carbonyl compounds explains why we find it easy to discuss ways of making 1,3- and 1,5-difunctionalized compounds—because they arise from $a^1 + d^2$ and from $a^3 + d^2$. Reagents corresponding to synthons like d^1 or a^2 are rarer, and therefore compounds with 1,2- or 1,4-related functional groups require special consideration retrosynthetically.

You have in fact met one example of each of the ‘unnatural’ synthons with a^2 and d^1 reactivity. Such synthons are given the German name *umpolung*, meaning ‘inverse polarity’, because their natural reactivity is reversed, and *umpolung* reagents are the key to the synthesis of 1,2- and 1,4-difunctionalized compounds.

two *umpolung* synthons and equivalent reagents



We shall finish this chapter by looking at disconnections of 1,2- and 1,4-difunctionalized compounds because these require us to use reagents with *umpolung* equivalent to d^1 , d^3 , a^2 , and a^4 synthons. There are very many reagents for these synthons—if you are interested to learn more, consult a specialized book.

1,2-Difunctional compounds

You met ways of making 1,2-difunctionalized compounds when we first talked about two-group disconnections, and we used an epoxide as an a^2 synthon. Epoxides are, of course, also 1,2-functionalized, and in fact this is often the key to making 1,2-functionalized compounds: use something with the 1,2 relationship already in place. You saw lots of examples of this type of strategy earlier in this chapter. Perhaps the simplest approach is electrophilic addition to alkenes. If the alkene is made by a Wittig reaction, the disconnection is (eventually) between the two functionalized carbon atoms in the target molecule. This example shows dihydroxylation as the electrophilic addition but there is also epoxidation, bromination, and bromination in water to give Br and OH as the functional groups.

➔ All of the electrophilic additions to alkenes were discussed in Chapter 19. Dihydroxylation is on p. 442.

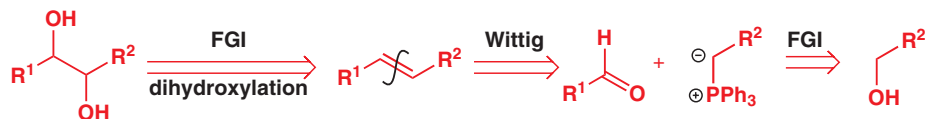

A normal C–C disconnection is also a possibility, but disconnection to the ‘natural’ a^1 synthon and the *umpolung* d^1 is necessary. One very useful *umpolung* reagent is cyanide, and you can see it in action in this synthesis of the tranquilizer phenaglycodol. The tertiary alcohol with two R groups the same should prompt you to think of doing a double Grignard addition to an ester. FGI then reveals the nitrile functional group necessary for a 1,2-diX disconnection to cyanide plus ketone.

phenaglycodol: retrosynthetic analysis

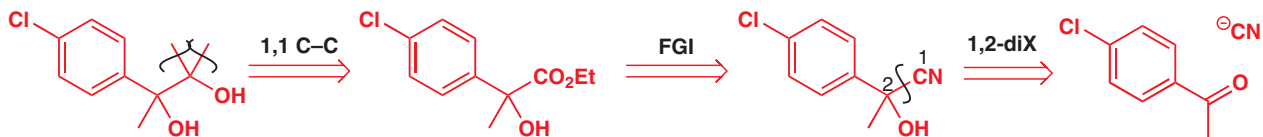

The starting material is obviously available by a Friedel–Crafts acylation of chlorobenzene and the rest of the synthesis follows. Note that the nitrile can be converted directly into the ester with acidic ethanol and that an excess of Grignard reagent is needed because the free OH group destroys some of it.

phenaglycodol: synthesis

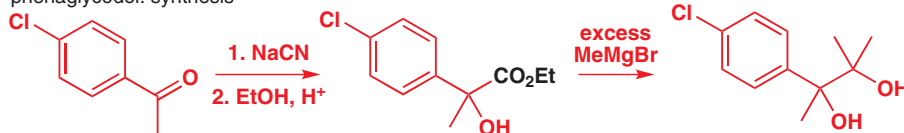

1,4-Difunctional compounds

There are more possibilities here and we shall finish this chapter with a brief analysis of them to show you how much of this subject lies beyond what we can do in this book.

If we start with a 1,4-dicarbonyl compound we might consider first disconnection of the central bond.

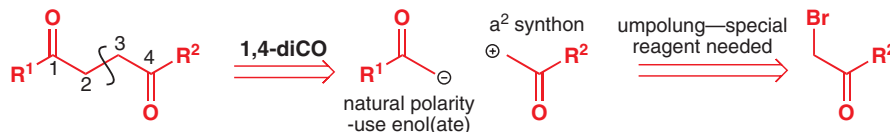

We can use an enolate for one reagent but the other will have to have umpolung. This is not a very difficult kind of umpolung as an α -bromo carbonyl compound will do the job nicely if we select our enol(ate) equivalent carefully. In Chapter 25 we suggested enamines for this job. The synthesis becomes:

synthesis of 1,4-diketone

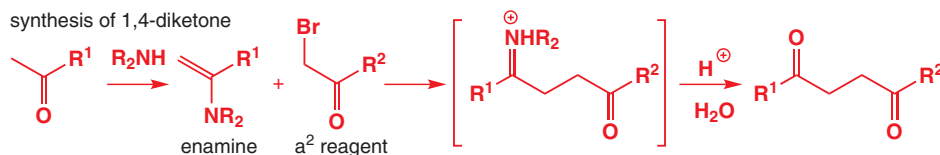

If we attempt the disconnection of one of the other bonds, two possibilities are available because the two fragments are different. We can use either a $d^1 + a^3$ strategy or an $a^1 + d^3$ strategy. In each case we have one natural synthon and one with umpolung.

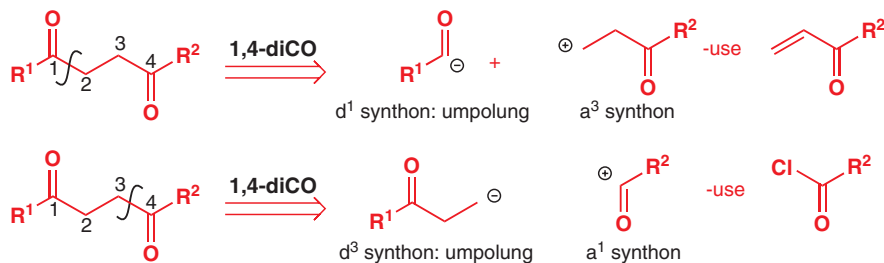

These strategies are more difficult to realize with the reagents you have met so far but conjugate addition of a cyanide to an unsaturated carbonyl compound would be an example of the $d^1 + a^3$ strategy. We have included these to try to convince you that there is no escape from umpolung in the synthesis of a 1,4-dicarbonyl compound. If you were making this keto-ester you would have to consider seriously two of the above three strategies.

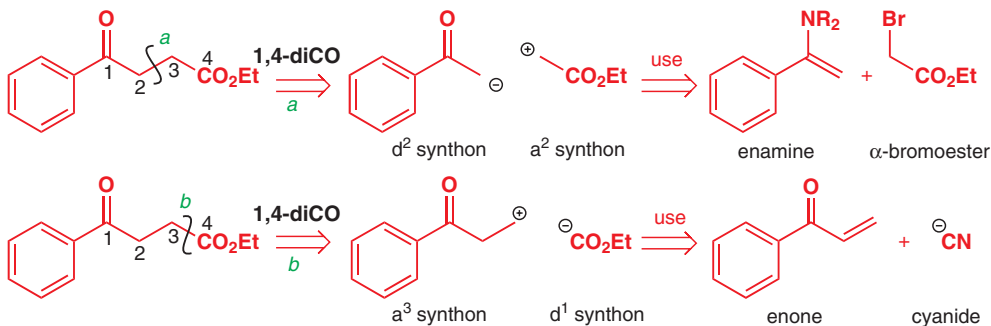

There is one way to avoid umpolung and that is to make the disconnection outside the 1,4 relationship. As it happens, we have already seen this strategy in action (p. 568). It involves a Friedel–Crafts acylation of benzene (Chapter 21) with a cyclic anhydride and leads directly to this product by quite a short route. This strategy is available only if there happens to be a starting material available to suit any particular case.

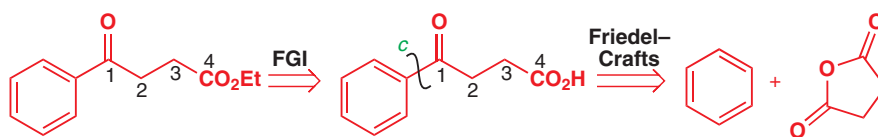

To conclude...

The best synthetic route to a molecule cannot be predicted with certainty. Retrosynthetic analysis allows you to suggest several different strategies for any given target molecule, and thorough literature searching plus experimentation in the laboratory will allow you to whittle the possibilities down to the most likely to succeed. Thinking like this underpins the design of syntheses of molecules, from the relatively simple molecules forming the next generation of drugs or agrochemicals to the most complex molecules known. Retrosynthetic thinking also reinforces the concept that the combination of electrophile and nucleophile is the basis for the understanding of organic reactions. Synthesis and reactions are two sides of the same coin. From now on we shall use the methods and terminology introduced in this chapter when we think that they will help you to develop your understanding.

Further reading

S. Warren and P. Wyatt, *Organic Synthesis: the Disconnection Approach*, Wiley, Chichester, 2008; S. Warren and P. Wyatt, *Workbook for Organic Synthesis: the Disconnection Approach*, Wiley, Chichester, 2009.

Most of the examples are of medicinal compounds and the data are from the patent literature. We suggest you don't try to use that but, if you are interested in the original work, look at these papers:

Phenylramidol: A. P. Gray, D. E. Heitmeyer, and E. E. Spinner, *J. Am. Chem. Soc.*, 1959, **81**, 4351.

Propranolol: R. Howe and R. G. Shanks, *Nature*, 1966, **210**, 1336; A. F. Crowther and L. H. Smith, *J. Med. Chem.*, 1968, **11**, 1009.

Moxnidazole: C. Rufer, H.-J. Kessler, and E. Schröder, *J. Med. Chem.*, 1971, **14**, 94.

Arildone: G. D. Diana, *et al.*, *J. Med. Chem.*, 1977, **20**, 757.

Rogletimide: A. M. Boss, D. W. Clissold, J. Mann, A. J. Markson, and C. P. Thickitt, *Tetrahedron*, 1989, **45**, 6011.

Doxpicomine: R. N. Booher, S. E. Smits, W. W. Turner, and A. Pohland, *J. Med. Chem.*, 1977, **20**, 885.

Venlafaxine: J. P. Yardley *et al.*, *J. Med. Chem.*, 1990, **33**, 2899.

Oxanamide: K. W. Wheeler, M. G. van Campen, and R. S. Shelton, *J. Org. Chem.*, 1960, **25**, 1021.

Bropirimine: H. I. Skulnik, S. D. Weed, E. E. Eidson, H. E. Renis, W. Wierenga, and D. A. Stringfellow, *J. Med. Chem.*, 1985, **28**, 1864.

Check your understanding



To check that you have mastered the concepts presented in this chapter, attempt the problems that are available in the book's Online Resource Centre at <http://www.oxfordtextbooks.co.uk/orc/clayden2e/>

Aromatic heterocycles 1: reactions

29

Connections

➔ Building on

- Aromaticity **ch7**
- Enols and enolates **ch20**
- Electrophilic aromatic substitution **ch21**
- Nucleophilic attack on aromatic rings **ch22**
- Reactions of enols and enolates **ch25 & ch26**

Arriving at

- Aromatic systems conceptually derived from benzene: replacing CH with N to get pyridine
- Replacing CH=CH with N to get pyrrole
- How pyridine reacts
- How pyridine derivatives can be used to extend pyridine's reactivity
- How pyrrole reacts
- How furan and thiophene compare with pyrrole
- Putting more nitrogens in five- and six-membered rings
- Fused rings: indole, quinoline, isoquinoline, and indolizine
- Rings with nitrogen and another heteroatom: oxygen or sulfur

➔ Looking forward to

- Synthesis of aromatic heterocycles **ch30**
- Saturated heterocycles **ch31**
- Biological chemistry **ch42**

Introduction

Benzene is aromatic because it has six electrons in a cyclic conjugated system. We know it is aromatic because it is exceptionally stable, it has a ring current and hence large chemical shifts in the proton NMR spectrum, and it has special chemistry involving substitution rather than addition with electrophiles. This chapter and the next are about the very large number of other aromatic systems in which one or more atoms in the benzene ring are replaced by heteroatoms such as N, O, and S. There are thousands of these systems with five- and six-membered rings, and we will examine just a few.

➔ The rather precise chemical definition of 'aromatic' is explained in Chapter 7. You will find the reactions of benzene and its aromatic derivatives described in Chapters 21 and 22: those two chapters are essential reading before you tackle this one.

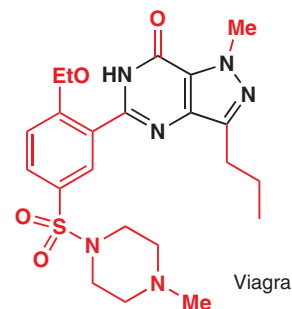
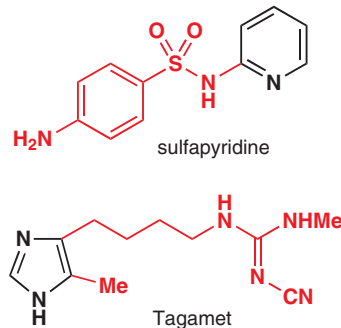
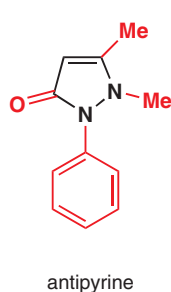
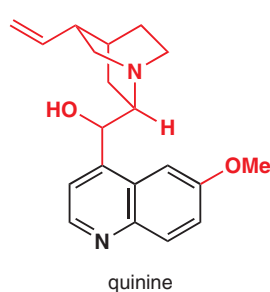

Online support. The icon  in the margin indicates that accompanying interactive resources are provided online to help your understanding: just type www.chemtube3d.com/clayden/123 into your browser, replacing 123 with the number of the page where you see the icon. For pages linking to more than one resource, type 123-1, 123-2 etc. (replacing 123 with the page number) for access to successive links.

Our subject is aromatic heterocycles and it is important that we treat it seriously because most—probably about two-thirds—organic compounds belong to this class, and they number among them some of the most significant compounds for human beings. If we think only of drugs we can define the history of medicine by heterocycles. Even in the sixteenth century quinine was used to prevent and treat malaria, although the structure of the drug was not known. The first synthetic drug was antipyrine (1887) for the reduction of fevers. The first effective antibiotic was sulfapyridine (1938). The first multi-million pound drug (1970s) was Tagamet, the anti-ulcer drug, and among the most topical of current drugs is Viagra (1997) for treatment of male impotence.

All these compounds have heterocyclic aromatic rings shown in black. Three have single rings, five- or six-membered, two have five- or six-membered rings fused together. The number of nitrogens in the rings varies from one to four. We will start by looking at the simple six-membered ring with one nitrogen atom: pyridine.

Aromaticity survives when parts of benzene's ring are replaced by nitrogen atoms

There is no doubt that benzene is aromatic. Now we must ask: how can we insert a heteroatom into the ring and retain aromaticity? What kind of atom is needed? If we want to replace one of the carbon atoms of benzene with a heteroatom, we need an atom that can be trigonal to keep the flat hexagonal ring, and that has a p orbital to keep the six delocalized electrons. Nitrogen fits all of these requirements. This is what happens if we replace a CH group in benzene with a nitrogen atom.

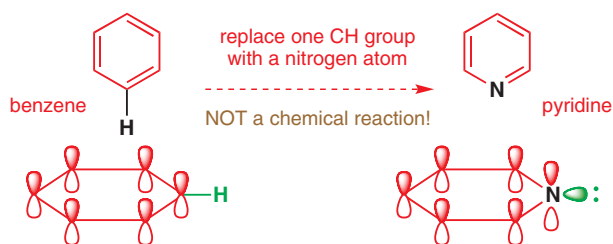

 Interactive structure of pyridine

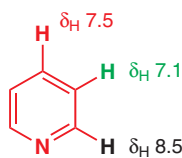

¹H NMR spectrum of pyridine

The orbitals in the ring have not changed in position or shape and we still have the six electrons from the three double bonds. One obvious difference is that nitrogen is trivalent and thus there is no NH bond. Instead, a lone pair of electrons occupies the space of the C–H bond in benzene.

In theory then, pyridine is aromatic. But is it in real life? The most important evidence comes from the proton NMR spectrum. The six protons of benzene resonate at 7.27 ppm, some 2 ppm downfield from the alkene region, clear evidence for a ring current (Chapter 13). Pyridine is not as symmetrical as benzene but the three types of proton all resonate in the same region. As we will see, pyridine is also very stable and, by any reasonable assessment, pyridine is aromatic.

We could continue the process of replacing, on paper, more CH groups with nitrogen atoms, and would find three new aromatic heterocycles: pyridazine, pyrimidine, and pyrazine:

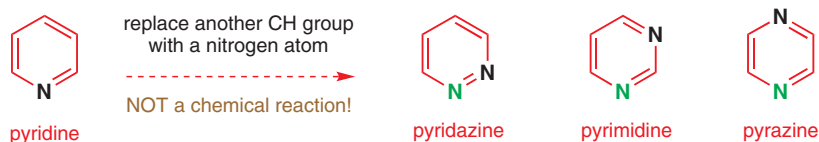

There is another way in which we might transform benzene into a heterocycle. Instead of using just one electron from N to replace an electron in the π system, we could use nitrogen's lone pair of electrons to replace two electrons in the π system. We can substitute a CH=CH unit in benzene with a nitrogen atom providing that we can use the lone pair in the delocalized system. This means putting it into a p orbital. We still have the four electrons from the

Nomenclature

One of the most annoying things about heterocyclic chemistry is the mass of what appear to be illogical names. You should not, of course, attempt to learn them all, but a basic idea of how they are designed will help you. We will give you a guide on which names to learn shortly. For the moment accept that 'amine' ends in '-ine' and any heterocyclic compound whose name ends in '-ine' is a nitrogen heterocycle. The syllable 'azo-' also implies nitrogen and 'pyr-' (usually) implies a six-membered ring (except in pyrrole!).

remaining double bonds and, with the two electrons of the lone pair on nitrogen, that makes six in all. The nitrogen atom must still be trigonal with the lone pair in a p orbital so the N–H bond is in the plane of the five-membered ring.

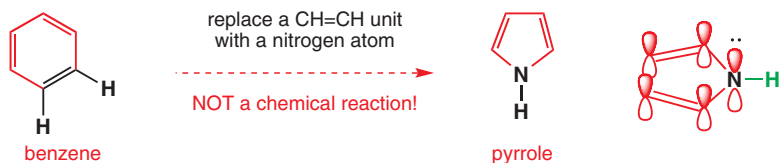

The ^1H NMR spectrum of pyrrole is slightly less convincing as the two types of proton on the ring resonate at higher field (6.5 and 6.2 ppm) than those of benzene or pyridine but they still fall in the aromatic rather than the alkene region. Pyrrole is also more reactive towards electrophiles than benzene or pyridine, but it does the usual aromatic substitution reactions (Friedel–Crafts, nitration, halogenation) rather than addition reactions: pyrrole is also aromatic.

Inventing heterocycles by further replacement of CH groups by nitrogen in pyrrole leads to two compounds, pyrazole and imidazole, after one replacement, to two triazoles after two replacements, and to a single tetrazole after three.

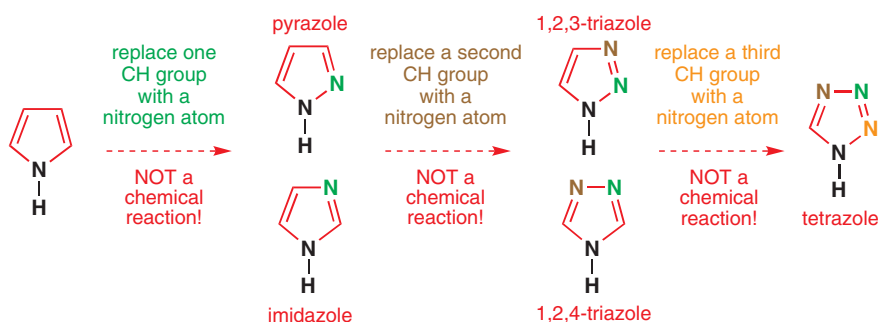
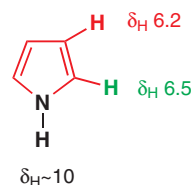

All of these compounds are generally accepted as aromatic too as they broadly have the NMR spectra and reactivities expected for aromatic compounds. As you may expect, introducing heteroatoms into the aromatic ring and, even more, changing the ring size actually affect the chemistry a great deal. We must now return to pyridine and work our way more slowly through the chemistry of these important heterocycles to establish the principles that govern their behaviour.

More nomenclature

The ending '-ole' is systematic and refers to a five-membered heterocyclic ring. All the five-membered aromatic heterocycles with nitrogen in the ring are sometimes called 'the azoles'. Oxazole and thiazole are used for the oxygen and sulfur analogues of imidazole.

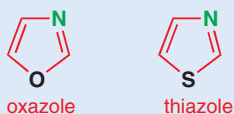

Pyridine is a very unreactive aromatic imine

The nitrogen atom in the pyridine ring is planar and trigonal with the lone pair in the plane of the ring. This makes it an imine. Most of the imines you have met before (in Chapter 11, for example), have been unstable intermediates in carbonyl group reactions, but in pyridine we have a stable imine—stable because of its aromaticity. All imines are more weakly basic than saturated amines and pyridine is a weak base with a $\text{p}K_{\text{a}}$ (for its conjugate acid) of 5.5. This means that the pyridinium ion is about as strong an acid as a carboxylic acid.

Pyridine is also toxic and has a foul smell—so there are disadvantages in using pyridine as a solvent. But it is cheap and remains a popular solvent in spite of the problems.

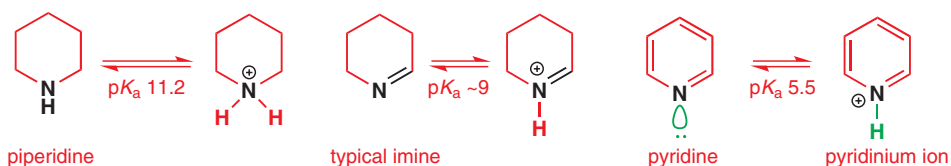

Pyridine is a reasonable nucleophile for carbonyl groups and is often used as a nucleophilic catalyst in acylation reactions. Esters are often made in pyridine solution from alcohols and acid chlorides (the full mechanism is on p. 199 of Chapter 10).

Interactive mechanism for pyridine nucleophilic catalysis

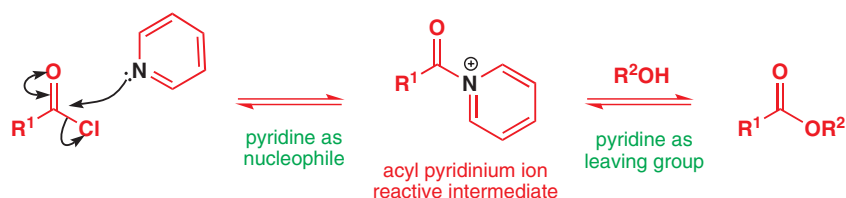

DMAP

One particular amino-pyridine has a special role as a more effective acylation catalyst than pyridine itself. This is DMAP (*N,N*-dimethylaminopyridine) in which the amino group is placed to reinforce the nucleophilic nature of the nitrogen atom. Whereas acylations 'catalysed' by pyridine are normally carried out in solution in pyridine, only small amounts of DMAP in other solvents are needed to do the same job.

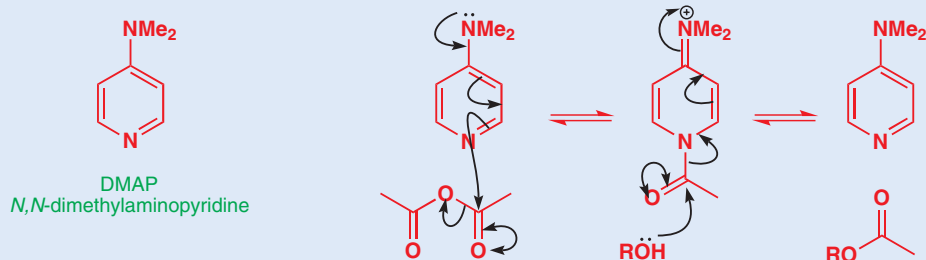

Pyridine is nucleophilic at the nitrogen atom because *the lone pair of electrons on nitrogen cannot be delocalized around the ring*. They are in an sp^2 orbital orthogonal to the p orbitals in the ring and there is no interaction between orthogonal orbitals. Try it for yourself, drawing arrows. All attempts to delocalize the electrons lead to impossible results!

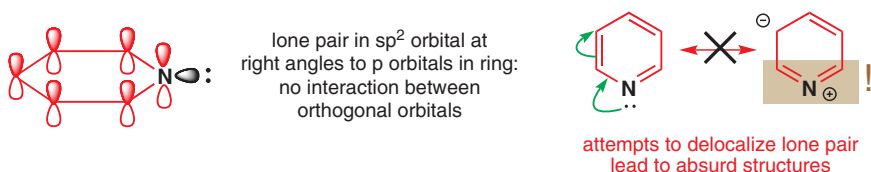

- The lone pair of pyridine's nitrogen atom is not delocalized.

Our main question about the reactivity of pyridine must be this: what does the nitrogen atom do to the rest of the ring? The important orbitals—the p orbitals of the aromatic system—are superficially the same as in benzene, but the more electronegative nitrogen atom will lower the energy of all the orbitals. Lower-energy filled orbitals mean a *less* reactive nucleophile but a lower-energy LUMO means a *more* reactive electrophile. This is a good guide to the chemistry

of pyridine. It is less reactive than benzene in electrophilic aromatic substitution reactions, but nucleophilic substitution, which is difficult for benzene, comes easily to pyridine.

Pyridine is bad at electrophilic aromatic substitution

The lower energy of the orbitals of pyridine's π system means that electrophilic attack on the ring is difficult. Another way to look at this is to see that the nitrogen atom destabilizes the cationic would-be intermediate, especially when it can be delocalized onto nitrogen.

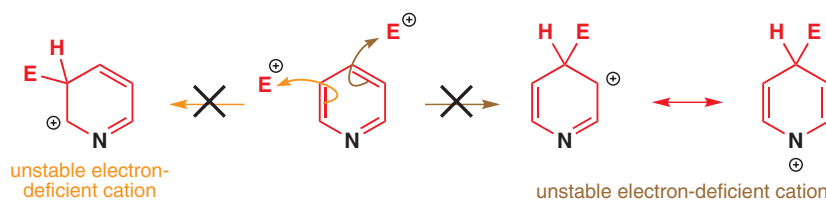

An equally serious problem is that the nitrogen lone pair is basic and a reasonably good nucleophile—this is the basis for its role as a nucleophilic catalyst in acylations. The normal reagents for electrophilic substitution reactions, such as nitration, are acidic. Treatment of pyridine with the usual mixture of HNO_3 and H_2SO_4 merely protonates the nitrogen atom. Pyridine itself is not very reactive towards electrophiles: the pyridinium ion is totally unreactive.

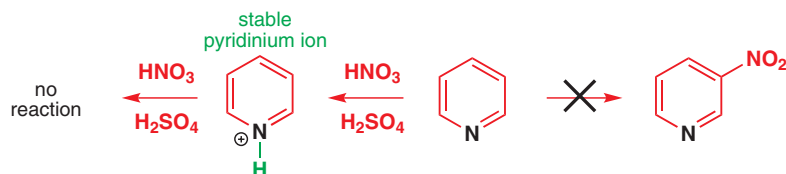

Other reactions, such as Friedel–Crafts acylations, require Lewis acids and these too react at nitrogen. Pyridine is a good ligand for metals such as $Al(III)$ or $Sn(IV)$ and, once again, the complex with its cationic nitrogen is completely unreactive towards electrophiles.

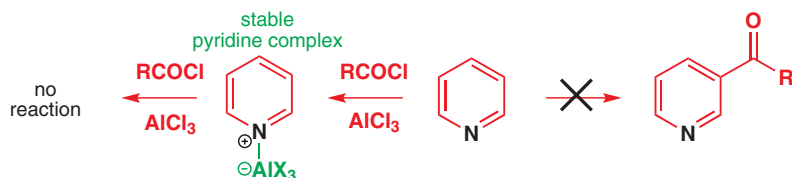

➔ Electrophilic substitution in benzene is discussed in Chapter 21.

■ Contrast the unstable electron-deficient cationic intermediate with the stable pyridinium ion. The nitrogen lone pair is used to make the pyridinium ion but is not involved in the unstable intermediate. Note that reaction at the 3-position is the best option but still doesn't occur. Reaction at the 2- and 4-positions is worse.

● Pyridine does not undergo electrophilic substitution

Aromatic electrophilic substitution on pyridine is not a useful reaction. The ring is unreactive and the electrophilic reagents attack nitrogen, making the ring even less reactive. Avoid nitration, sulfonation, halogenation, and Friedel–Crafts reactions on simple pyridines.

Nucleophilic substitution is easy with pyridines

By contrast, the nitrogen atom makes pyridines *more* reactive towards nucleophilic substitution, particularly at the 2- and 4-positions, by lowering the LUMO energy of the π system of pyridine. You can see this effect in action in the ease of replacement of halogens in these positions by nucleophiles.

➔ Nucleophilic substitution in benzene is discussed in Chapter 22.

Interactive mechanism for nucleophilic substitution on pyridines

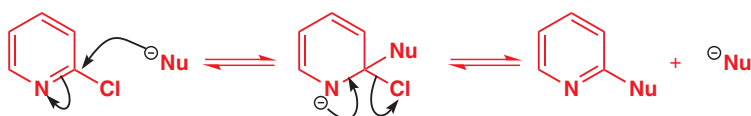

The intermediate anion is stabilized by electronegative nitrogen and by delocalization round the ring. These reactions have some similarity to nucleophilic aromatic substitution (Chapter 22) but are more similar to carbonyl reactions. The intermediate anion is a tetrahedral intermediate that loses the best leaving group to regenerate the stable aromatic system. Nucleophiles such as amines or thiolate anions work well in these reactions.

➔ Note the similarity to nucleophilic substitution on the carbonyl group (Chapter 10).

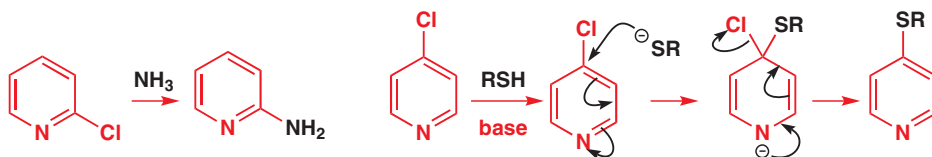

The leaving group does not have to be as good as chloride in these reactions. Continuing the analogy with carbonyl reactions, 2- and 4-chloropyridines are rather like acid chlorides but we need only use less reactive pyridyl ethers, which react like esters, to make amides. Substitution of a 2-methoxypyridine allows the synthesis of flupirtine.

➔ You will see more of this synthesis later in the chapter.

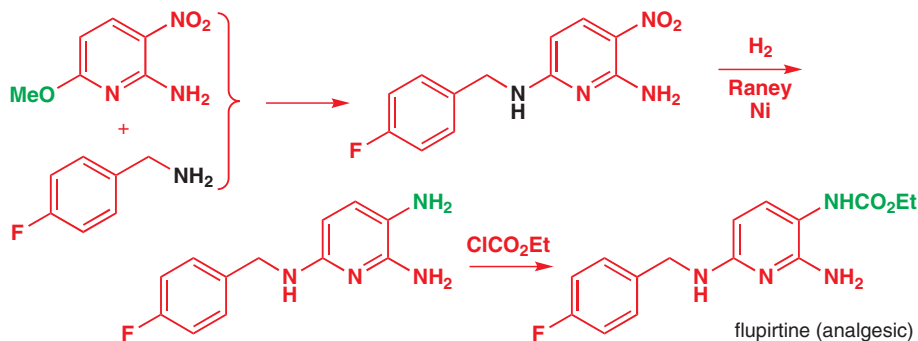

The first step is a nucleophilic aromatic substitution. In the second step the nitro group is reduced to an amino group without any effect on the pyridine ring—another piece of evidence for its aromaticity. Finally, the one amino group whose lone pair is not delocalized onto the pyridine N is acylated in the presence of two others.

Pyridones are good substrates for nucleophilic substitution

The starting materials for these nucleophilic substitutions (2- and 4-chloro- or methoxypyridines) are themselves made by nucleophilic substitution on *pyridones*. If you were asked to propose how 2-methoxypyridine might be made, you would probably suggest, by analogy with the corresponding benzene compound, alkylation of a phenol. Let us look at this in detail.



The starting material for this reaction is a 2-hydroxypyridine that can tautomerize to an amide-like structure known as a pyridone by the shift of the acidic proton from oxygen to nitrogen. In the phenol series there is no doubt about which structure will be stable as the ketone is not aromatic; for the pyridine both structures are aromatic.

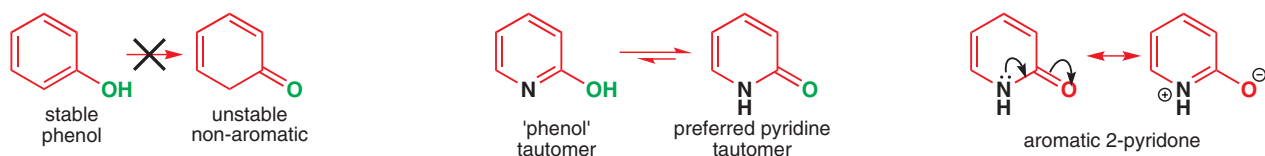

In fact, 2-hydroxypyridine prefers to exist as the 'amide' because that has the advantage of a strong C=O bond and is still aromatic. There are two electrons in each of the C=C double bonds and two also in the lone pair of electrons on the trigonal nitrogen atom of the amide. Delocalization of the lone pair in typical amide style makes the point clearer.

Pyridones are easy to prepare (see Chapter 30) and can be alkylated on oxygen as predicted by their structure. A more important reaction is the direct conversion to chloropyridines with POCl_3 . The reaction starts by attack of the oxygen atom at phosphorus to create a leaving group, followed by aromatic nucleophilic substitution. The overall effect is very similar to acyl chloride formation from a carboxylic acid (Chapter 10).

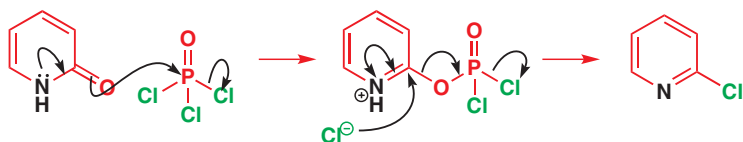

The same reaction occurs with 4-pyridone, which is also delocalized in the same way and exists in the 'amide' form, but not with 3-hydroxypyridine, which exists in the 'phenol' form. Its only tautomer is a zwitterion but the pyridine nitrogen is too weak to remove a proton from the hydroxyl group.

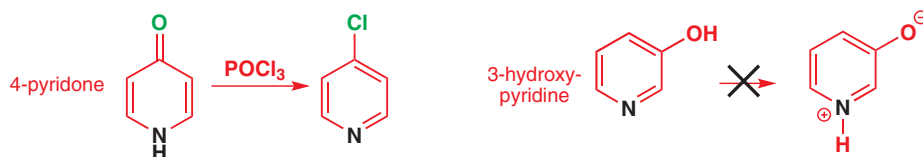

● Pyridines undergo nucleophilic substitution

Pyridines can undergo *electrophilic* substitution only if they are activated by electron-donating substituents (see next section) but they readily undergo *nucleophilic* substitution without any activation other than the ring nitrogen atom.

Activated pyridines will do electrophilic aromatic substitution

Useful electrophilic substitutions occur only on pyridines having electron-donating substituents such as NH_2 or OMe . These activate benzene rings too (Chapter 21) but here their help is vital. They supply a non-bonding pair of electrons that raises the energy of the HOMO and carries out the reaction. Simple amino- or methoxypyridines react reasonably well *ortho* and *para* to the activating group. These reactions happen in spite of the molecule being a pyridine, not because of it.

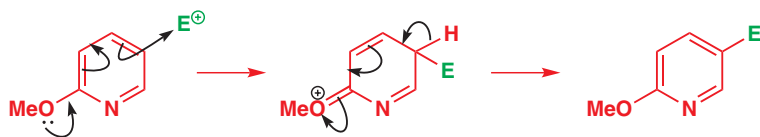

A practical example occurs in the manufacture of the analgesic flupirtine where a doubly activated pyridine having both MeO and NH_2 groups is nitrated just as if it were a benzene ring. The nitro group goes in *ortho* to the amino group and *para* to the methoxy group. The activation is evidently enough to compensate for the molecule being almost entirely protonated under the conditions of the reaction.

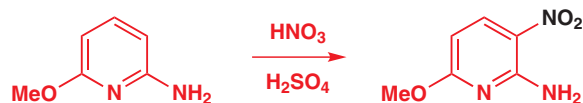

Interactive tautomerism between 2-hydroxypyridine and pyridone

➔ This is the starting material for the flupirtine synthesis on p. 728.

Pyridine *N*-oxides are reactive towards both electrophilic and nucleophilic substitution

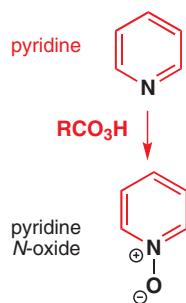

This is all very well if the molecule has such activating groups, but supposing it doesn't? How are we to nitrate pyridine itself? The answer involves an ingenious trick. We need to activate the ring with an electron-rich substituent that can later be removed and we also need to stop the nitrogen atom reacting with the electrophile. All of this can be done with a single atom!

Because the nitrogen atom is nucleophilic, pyridine can be oxidized to pyridine *N*-oxide with reagents such as *m*-CPBA or just H₂O₂ in acetic acid. These *N*-oxides are stable dipolar species with the electrons on oxygen delocalized round the pyridine ring, raising the HOMO of the molecule. Reaction with electrophiles occurs at the 2- (*ortho*) and 4- (*para*) positions, chiefly at the 4-position to keep away from positively charged nitrogen.

Interactive structure of pyridine *N*-oxide

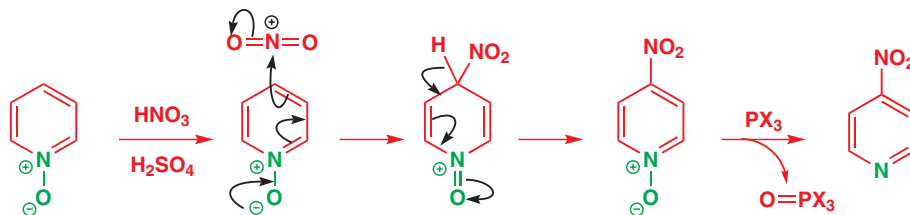

Now the oxide must be removed and this is best done with trivalent phosphorus compounds such as (MeO)₃P or PCl₃. The phosphorus atom detaches the oxygen atom in a single step to form the very stable P=O double bond. In this reaction the phosphorus atom is acting as both a nucleophile and an electrophile, but mainly as an electrophile since PCl₃ is more reactive here than (MeO)₃P.

The same activation that allowed simple electrophilic substitution—oxidation to the *N*-oxide—can also allow a useful *nucleophilic* substitution. The positive nitrogen atom encourages nucleophilic attack and the oxygen atom can be turned into a leaving group with PCl₃. Our example is nicotinic acid, whose biological importance we will discuss in Chapter 42.

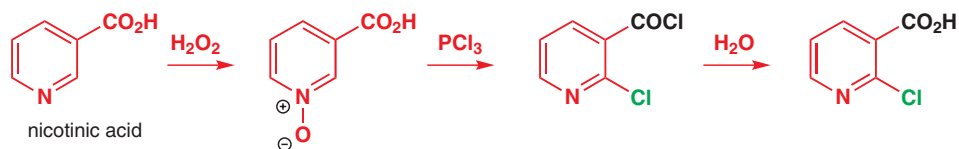
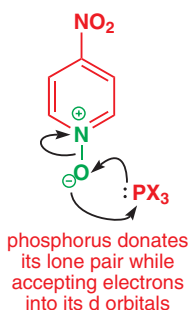

The *N*-oxide reacts with PCl₃ through oxygen and the chloride ion released in this reaction adds to the most electrophilic position between the two electron-withdrawing groups. Now a simple elimination restores aromaticity and gives a product looking as though it results from chlorination rather than nucleophilic attack.

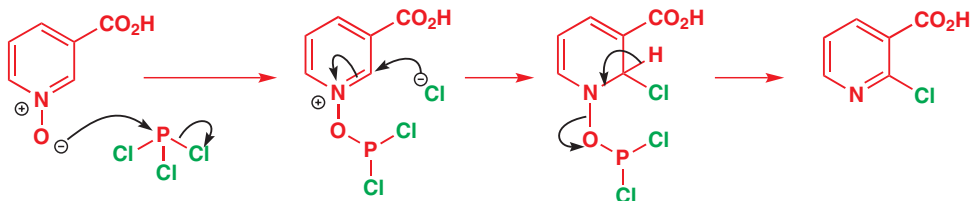

Interactive mechanism for nucleophilic substitution on pyridine *N*-oxide

The reagent PCl₃ also converts the carboxylic acid to the acyl chloride, which is hydrolysed back again in the last step. This is a useful sequence because the chlorine atom has been introduced into the 2-position, from which it may in turn be displaced by, for example, amines.

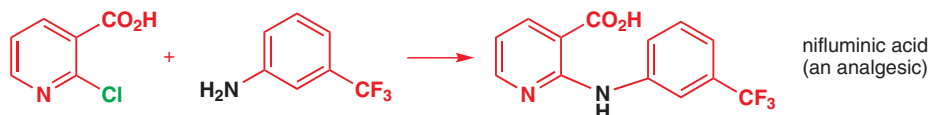

● Pyridine *N*-oxides

Pyridine *N*-oxides are useful for both electrophilic and nucleophilic substitutions on the same carbon atoms (2-, 4-, and 6-) in the ring.

Nucleophilic addition at an even more distant site is possible on reaction with acid anhydrides if there is an alkyl group in the 2-position. Acylation occurs on oxygen as in the last reaction but then a proton is lost from the side chain to give an uncharged intermediate.

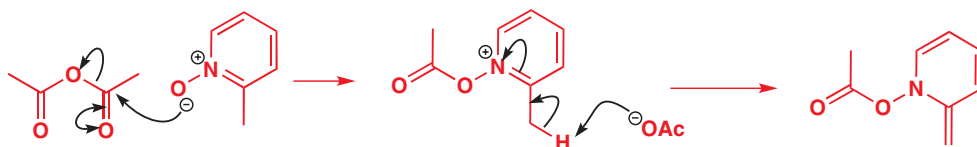

This compound rearranges with migration of the acetate group to the side chain and the restoration of aromaticity. This may be an ionic reaction or a type of rearrangement that you will learn to call a [3,3]-sigmatropic rearrangement (Chapter 35).

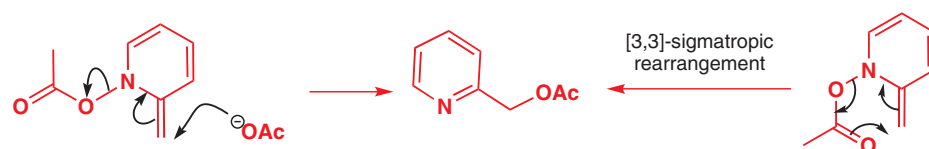

Pyridine as a catalyst and reagent

Since pyridine is abundant and cheap and has an extremely rich chemistry, it is not surprising that it has many applications. One of the simplest ways to brominate benzenes is not to bother with the Lewis acid catalysts recommended in Chapter 21 but just to add liquid bromine to the aromatic compound in the presence of a small amount of pyridine. Only about one mole per cent is needed and even then the reaction has to be cooled to stop it getting out of hand.

As we have seen, pyridine attacks electrophiles through its nitrogen atom. This produces the reactive species, the *N*-bromo-pyridinium ion, which is attacked by the benzene. Pyridine is a better nucleophile than benzene and a better leaving group than bromide. This is another example of **nucleophilic catalysis**.

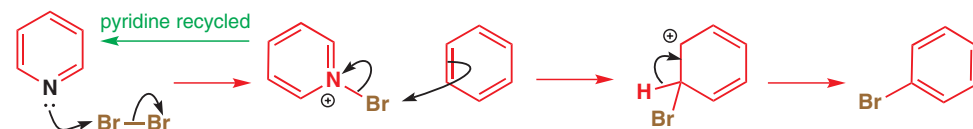
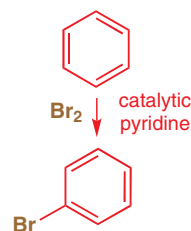

➔ Nucleophilic catalysis is discussed on p. 200.

Another way to use pyridine in brominations is to make a stable crystalline compound to replace the dangerous liquid bromine. This compound, known by names such as pyridinium tribromide, is simply a salt of pyridine with the anion Br_3^- . It can be used to brominate reactive compounds such as alkenes (Chapter 19).

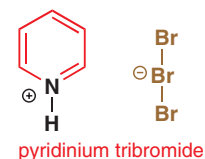
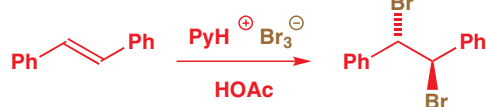

Both of these methods depend on the lack of reactivity of pyridine's π system towards electrophiles such as bromine. Notice that, in the first case, both benzene and pyridine are present together. The pyridine attacks bromine only through nitrogen (and reversibly at that) and never through carbon.

Oxidation of alcohols is normally carried out with Cr(VI) reagents (Chapter 23) but these, like the Jones' reagent ($\text{Na}_2\text{Cr}_2\text{O}_7$ in sulfuric acid), are usually acidic. Some pyridine complexes

of Cr(VI) compounds solve this problem by having the pyridinium ion (pK_a 5) as the only acid. The two most famous are PDC (pyridinium dichromate) and PCC (pyridinium chlorochromate). Pyridine forms a complex with CrO_3 but this is liable to burst into flames. Treatment with HCl gives PCC, which is much less dangerous. PCC is particularly useful in the oxidation of primary alcohols to aldehydes as over-oxidation is avoided in the only slightly acidic conditions (Chapter 23).

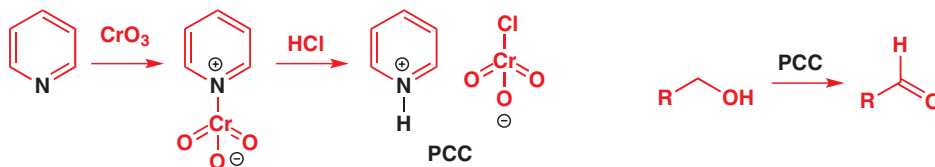

Bipyridyl (bipy)

The ability of pyridine to form metal complexes is greatly enhanced in a dimer—the famous ligand ‘bipy’ or 2,2′-bipyridyl. It is bidentate and because of its ‘bite’ it is a good ligand for many transition metals, with a partiality for Fe(II).

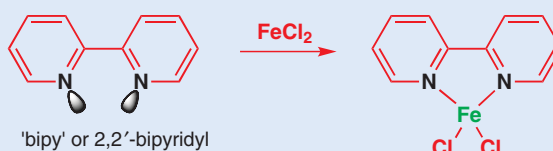

It looks like a rather difficult job to persuade two pyridine rings to join together in this way to form bipy. It is indeed very difficult unless you make things easier by using a reagent that favours the product. And what better than Fe(II) to do the job? Bipy is manufactured by treating pyridine with $\text{FeCl}_2 \cdot 4\text{H}_2\text{O}$ at high temperatures and high pressures. Only a small proportion of the pyridine is converted to the Fe(II) complex of bipy (about 5%) but the remaining pyridine goes back in the next reaction. This is probably a radical process (Chapter 37) within the coordination sphere of Fe(II).

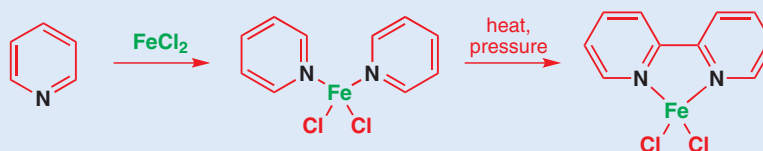

Six-membered aromatic heterocycles can have oxygen in the ring

Although pyridine is overwhelmingly the most important of the six-membered aromatic heterocycles, there are oxygen heterocycles, pyrones, that resemble the pyridones. The pyrones are aromatic, although α -pyrone is rather unstable.

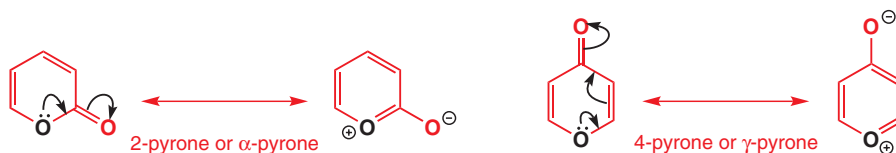

The pyrylium salts are stable aromatic cations and are responsible as metal complexes for some flower colours. Heterocycles with six-membered rings based on other elements (for example, P) do exist but they are outside the scope of this book.

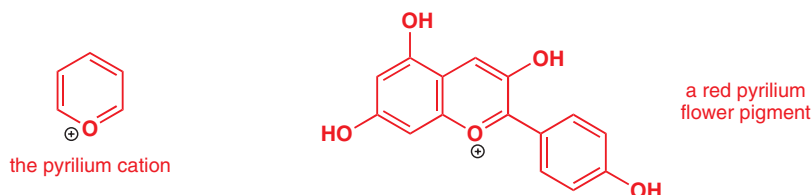

Five-membered aromatic heterocycles are good at electrophilic substitution

Just about everything is the other way round with pyrrole. Electrophilic substitution is much easier than it is with benzene—almost too easy in fact—while nucleophilic substitution is more difficult. Pyrrole is not a base nor can it be converted to an *N*-oxide. We need to find out why this is. The big difference is that the nitrogen lone pair is delocalized round the ring. The NMR spectrum suggests that all the positions in the ring are about equally electron-rich with chemical shifts about 1 ppm smaller than those of benzene. The ring is flat and the bond lengths are very similar, although the bond opposite the nitrogen atom is a bit longer than the others.

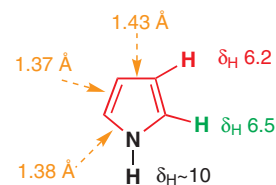

Interactive structure of pyrrole

The delocalization of the lone pair can be drawn equally well to any ring atom because of the five-membered ring and we shall soon see the consequences of this. All the delocalization pushes electrons from the nitrogen atom into the ring and we expect the ring to be electron-rich at the expense of the nitrogen atom. The HOMO should go up in energy and the ring become more nucleophilic.

An obvious consequence of this delocalization is the decreased basicity of the nitrogen atom and the increased acidity of the NH group. In fact, the $\text{p}K_{\text{a}}$ of pyrrole acting as a base is about -4 , and protonation occurs at carbon below $\text{pH} -4$. By contrast, the NH proton ($\text{p}K_{\text{a}}$ 16.5) can be removed by much weaker bases than those that can remove protons on normal secondary amines. The nucleophilic nature of the ring means that pyrrole is attacked readily by electrophiles. Reaction with bromine requires no Lewis acid and leads to substitution (confirming the aromaticity of pyrrole) at all four free positions. Contrast pyridine's reactivity with bromine (p. 731): it reacts just once, at nitrogen.

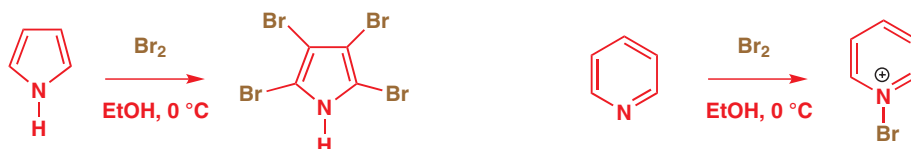

This is a fine reaction in its way, but we don't usually want four bromine atoms in a molecule so one problem with pyrrole is to control the reaction to give only monosubstitution. Another problem is that strong acids cannot be used. Although protonation does not occur at nitrogen, it does occur at carbon and the protonated pyrrole then adds another molecule like this.

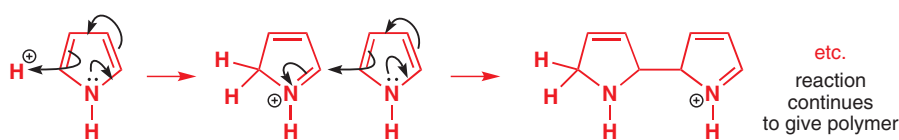

● Pyrrole polymerizes!

Strong acids, those such as H_2SO_4 with a $\text{p}K_{\text{a}}$ of less than -4 , cannot be used without polymerization of pyrrole.

Some reactions can be controlled to give good yields of monosubstituted products. One is the Vilsmeier reaction, in which a combination of an *N,N*-dimethylamide and POCl_3 is used to make a carbon electrophile in the absence of strong acid or Lewis acid. It is a substitute for the Friedel–Crafts acylation, and works with aromatic compounds at the more reactive end of the scale (where pyrrole is).

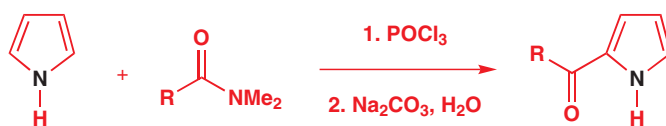

In the first step, the amide reacts with POCl_3 , which makes off with the amide oxygen atom and replaces it with chlorine. This process would be very unfavourable but for the formation of the strong P–O bond, and is the direct analogy of the chloropyridine-forming reaction you have just seen.

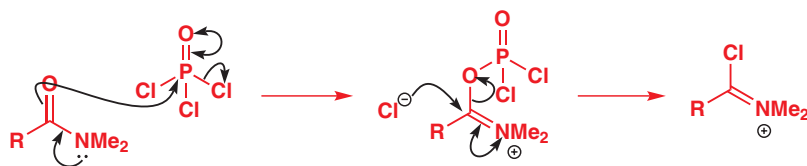

The product from this first step is an iminium cation that reacts with pyrrole to give a more stable iminium salt. The extra stability comes from the conjugation between the pyrrole nitrogen and the iminium group. The work-up with aqueous Na_2CO_3 hydrolyses the imine salt and removes any acid formed. This method is particularly useful because it works well with Me_2NCHO (DMF) to add a formyl (CHO) group. This is difficult to do with a conventional Friedel–Crafts reaction.

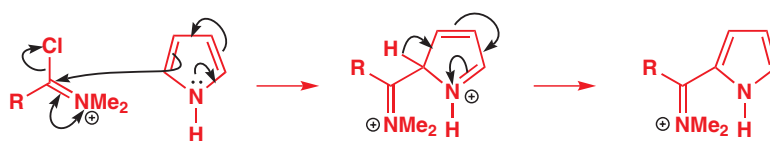

Interactive mechanism for Vilsmeier reaction of pyrrole

➔ Remind yourself of the Mannich reaction on p. 621 of Chapter 26.

You may have noticed that the reaction occurred only at the 2-position on pyrrole. Although all positions react with reagents like bromine, most reagents go for the 2- (or 5-) position and attack the 3- (or 4-) position only if the 2- and 5-positions are blocked. A good example is the Mannich reaction. In these two examples *N*-methylpyrrole reacts cleanly at the 2-position while the other pyrrole with both 2- and 5-positions blocked by methyl groups reacts cleanly at the 3-position. These reactions are used in the manufacture of the non-steroidal anti-inflammatory compounds tolmetin and clopirac.

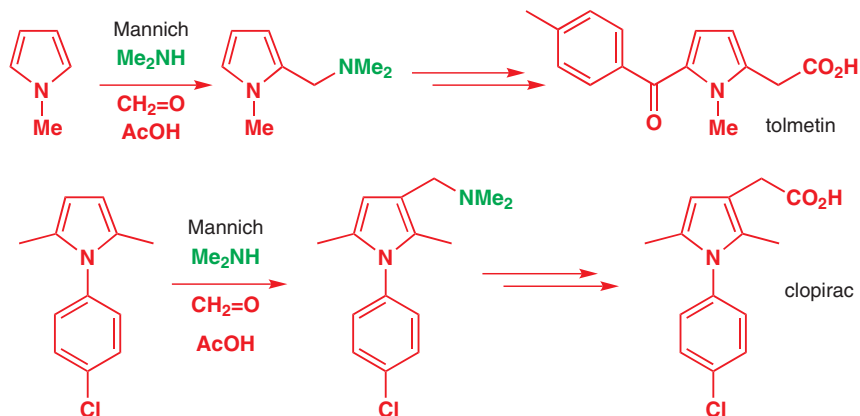

Interactive mechanism for the Mannich reaction on pyrrole

Now we need an explanation. The mechanisms for both 2- and 3-substitutions look good and we will draw both, using a generalized E^+ as the electrophile. Both mechanisms can occur very readily. Reaction in the 2-position is somewhat better than in the 3-position but the difference is small. Substitution is favoured at *all* positions. Calculations show that the HOMO of pyrrole does indeed have a larger coefficient in the 2-position, and one way to explain this result is to look at the structure of the intermediates. The intermediate from attack at the

2-position has a linear conjugated system. In both intermediates the two double bonds are, of course, conjugated with each other, but only in the first intermediate are both double bonds conjugated with N^+ . The second intermediate is 'cross-conjugated', while the first has a more stable linear conjugated system.

reaction with electrophiles in the 2-position

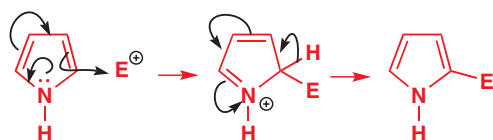

reaction with electrophiles in the 3-position

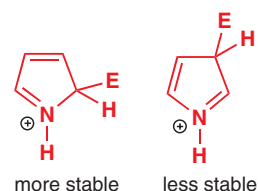
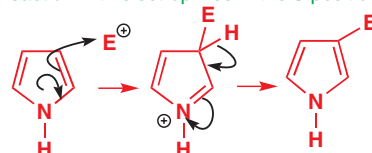

Since electrophilic substitution on pyrroles occurs so easily, it can be useful to block substitution with a removable substituent. This is usually done with an ester group. Hydrolysis of the ester (this is particularly easy with *t*-butyl esters—see Chapter 23) releases the carboxylic acid, which decarboxylates on heating. There is no doubt that the final electrophilic substitution must occur at C2.

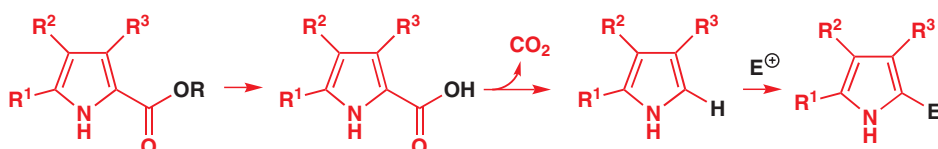

The decarboxylation is a general reaction of pyrroles: it's a kind of reverse Friedel–Crafts reaction in which the electrophile is a proton (provided by the carboxylic acid itself) and the leaving group is carbon dioxide. The protonation may occur anywhere but it leads to reaction only if it occurs where there is a CO_2H group.

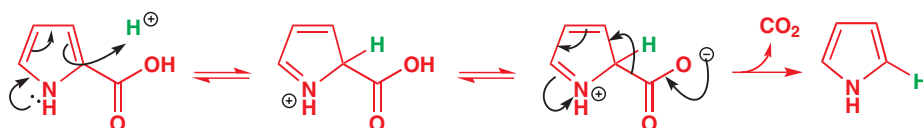

Furan and thiophene are oxygen and sulfur analogues of pyrrole

The other simple five-membered heterocycles are furan, with an oxygen atom instead of nitrogen, and thiophene, with a sulfur atom. They also undergo electrophilic aromatic substitution very readily, although not so readily as pyrrole. Nitrogen is the most powerful electron donor of the three, oxygen the next, and sulfur the least. Thiophene is very similar to benzene in reactivity.

Thiophene is the least reactive of the three because the *p* orbital of the lone pair of electrons on sulfur that conjugates with the ring is a 3*p* orbital rather than the 2*p* orbital of N or O, so overlap with the 2*p* orbitals on carbon is less good. Both furan and thiophene undergo more or less normal Friedel–Crafts reactions, although the less reactive anhydrides (here acetic anhydride, Ac_2O) are used instead of acid chlorides, and weaker Lewis acids than $AlCl_3$ are preferred.

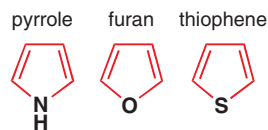

Notice that the regioselectivity is the same as it was with pyrrole—the 2-position is more reactive than the 3-position in both cases. The product ketones are less reactive towards electrophiles than the starting heterocycles and deactivated furans can even be nitrated

with the reagents used for benzene derivatives. Notice that reaction has occurred at the 5-position in spite of the presence of the ketone. The preference for 2- and 5-substitution is quite marked.

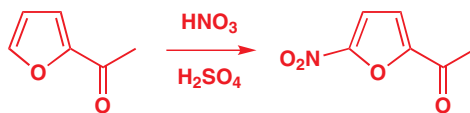

Electrophilic addition may be preferred to substitution with furan

So far, thiophenes and furans look much the same as pyrrole but there are other reactions in which they behave quite differently and we shall now concentrate on those. Furan is less aromatic than pyrrole, and if there is the prospect of forming stable bonds such as C–O single bonds by addition, this may be preferred to substitution. A famous example is the reaction of furan with bromine in methanol. In non-hydroxylic solvents, polybromination occurs as expected, but in MeOH no bromine is added at all!

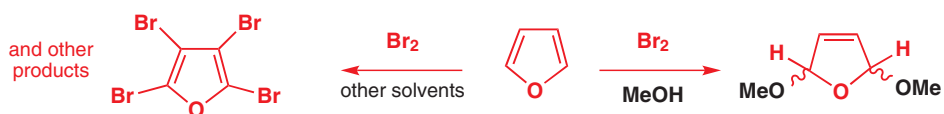

Bromination must start in the usual way, but a molecule of methanol captures the first formed cation in a 1,4-addition to furan.



The bromine atom that was originally added is now pushed out by the furan oxygen atom to make a relatively stable conjugated oxonium ion, which adds a second molecule of methanol.



This product conceals an interesting molecule. At each side of the ring we have an acetal, and if we were to hydrolyse the acetals, we would have ‘maleic dialdehyde’ (*cis*-butenedial) — a molecule that is too unstable to be isolated. The furan derivative may be used in its place.

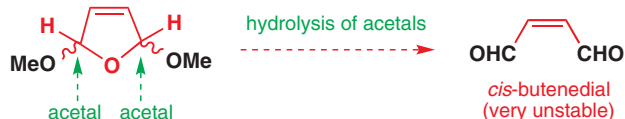

The same 1,4-dialdehyde can be made by oxidizing furan with the mild oxidizing agent dimethyldioxirane, which you met on p. 432. In this sequence, it is trapped in a Wittig reaction to give an *E,Z*-diene, which is easily isomerized to *E,E*.

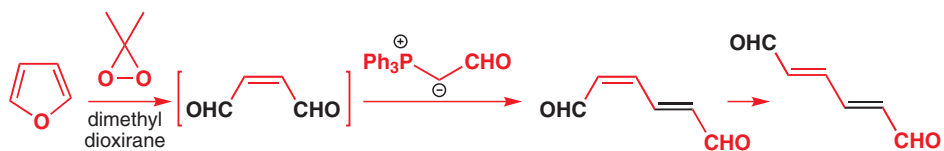

We can extend this idea of furan being the origin of 1,4-dicarbonyl compounds if we consider that furan is, in fact, an enol ether on both sides of the ring. If these enol ethers were hydrolysed we would get a 1,4-diketone.

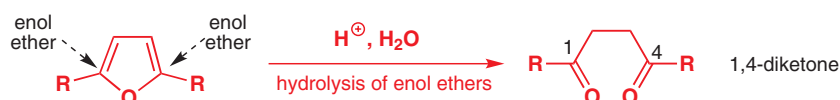

This time the arrow is solid, not dotted, because this reaction really happens. You will discover in the next chapter that furans can also be made from 1,4-diketones so this whole process is reversible. The example we are choosing has other features worth noting. The cheapest starting material containing a furan is furan-2-aldehyde or ‘furfural’, a by-product of breakfast cereal manufacture. Here it reacts in a typical Wittig process with a stabilized ylid.

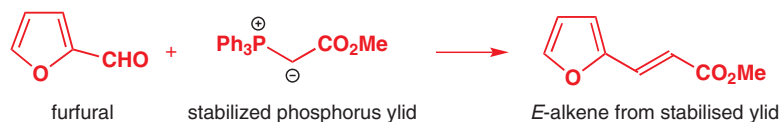

Now comes the interesting step: treatment of this furan with acidic methanol gives a white crystalline compound having two 1,4-dicarbonyl relationships. You might like to try and draw a mechanism for this reaction.

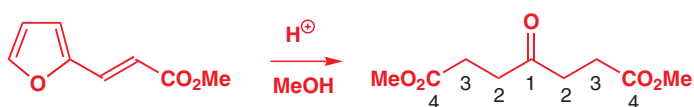

The thiophene ring can also be opened up, but in a very different way. Reductive removal of the sulfur atom with Raney nickel reduces not only the C–S bonds but also the double bonds in the ring and the four carbons in the ring form a saturated alkyl chain. If the reduction follows two Friedel–Crafts reactions on thiophene the product is a 1,6-diketone instead of the 1,4-diketones from furan. Thiophene is well behaved in Friedel–Crafts acylations, and reaction occurs at the 2- and 5-positions unless these are blocked.

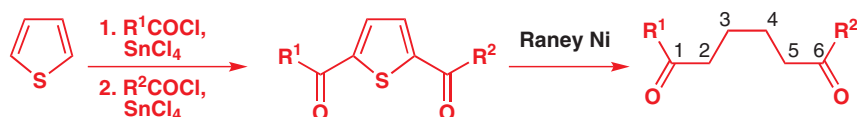

Lithiation of thiophenes and furans

A reaction that furans and thiophenes do particularly well and that fits well with these last two reactions is metallation, particularly lithiation, of a C–H group next to the heteroatom. Metallation of benzene rings (Chapter 24) is carried out by lithium–halogen (Br or I) exchange—a method that works well for heterocycles too as we will see later with pyridine—or by directed (*ortho*) lithiation of a C–H group next to an activating group such as OMe. With thiophene and furan, the heteroatom in the ring provides the necessary activation.



Activation is by coordination of O or S to Li followed by proton removal by the butyl group—the by-product is gaseous butane. These lithium compounds have a carbon–lithium σ bond and are soluble in organic solvents. We shall represent them very simply, but in fact they are typically dimers or more complex aggregates, with the coordination sphere of Li completed by THF molecules.

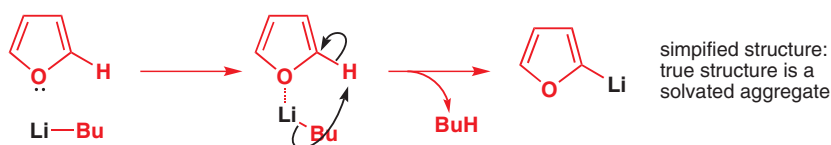

➔ We explained some of the challenges in making 1,4-difunctionalized compounds in Chapter 28.

➔ Raney nickel was introduced in Chapter 23, p. 537.

These lithium compounds are very reactive and will combine with most electrophiles—in this example the organolithium is alkylated by a benzylic halide. Treatment with aqueous acid gives the 1,4-diketone by hydrolysis of the two enol ethers.

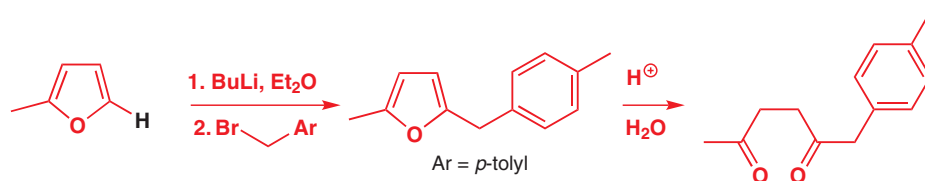

Treatment of this diketone with *anhydrous* acid would cause recyclization to the same furan (see Chapter 30) but it can alternatively be cyclized in base by an intramolecular aldol reaction (Chapter 26) to give a cyclopentenone.

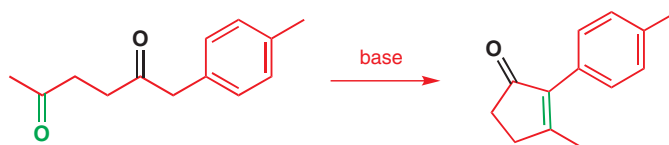

This completes our exploration of chemistry special to thiophene and furan, and we now return to all three heterocycles (pyrrole in particular) and look at *nucleophilic* substitution.

More reactions of five-membered heterocycles

Nucleophilic substitution requires an activating group

Nucleophilic substitution is a relatively rare reaction with pyrrole, thiophene, or furan and requires an activating group such as nitro, carbonyl, or sulfonyl, just as it does with benzene (Chapter 22). This intramolecular example is used to make the painkiller ketorolac.

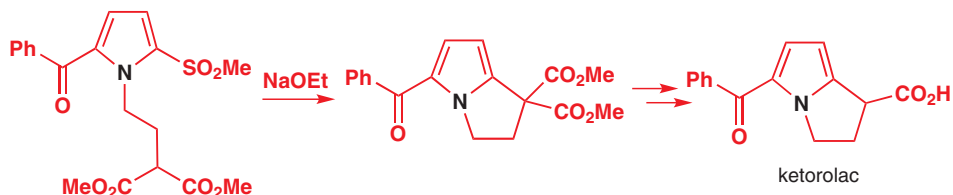

The nucleophile is a stable enolate and the leaving group is a sulfinate anion. An intermediate must be formed in which the negative charge is delocalized onto the carbonyl group on the ring, just as you saw in the benzene ring examples in Chapter 22. Attack occurs at the 2-position because the leaving group is there and because the negative charge can be delocalized onto the ketone from that position.

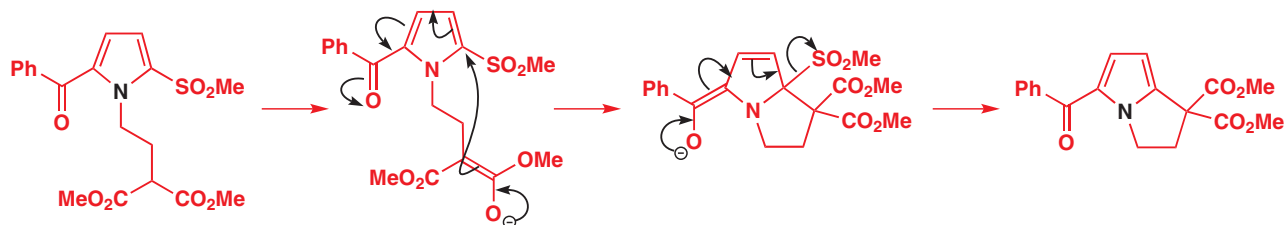

Five-membered heterocycles act as dienes in Diels–Alder reactions

All of the reactions of pyrrole, furan, and thiophene we have discussed so far have been variations on reactions of benzene. But heterocycles also do reactions totally unlike those of benzene and we are now going to explore two of them.

The first is a reaction you will meet in detail in Chapter 34. It is known as the Diels–Alder reaction, and although it has a number of subtleties we will not discuss here, it has a simple cyclic mechanism in which six electrons (three curly arrows) move around to form a new six-membered ring.

Here is an example with the Boc derivative of pyrrole. The electron-deficient Boc group makes pyrrole less nucleophilic and promotes the Diels–Alder reaction with an alkynyl sulfone. Benzene, and even many other heterocycles, will not do this sort of reaction.

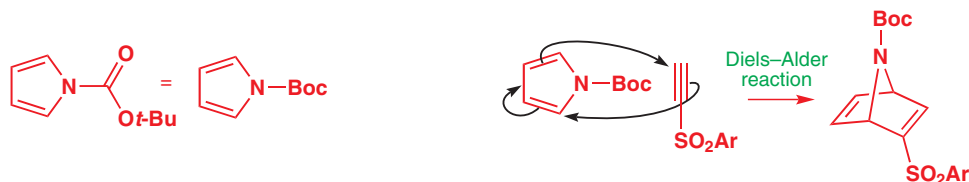

The product is a useful intermediate in the synthesis of the analgesic epibatidine. Selective reduction of the non-conjugated double bond is followed by addition of a pyridine nucleophile (a lithium derivative can be prepared from a bromopyridine) to the vinyl sulfone.

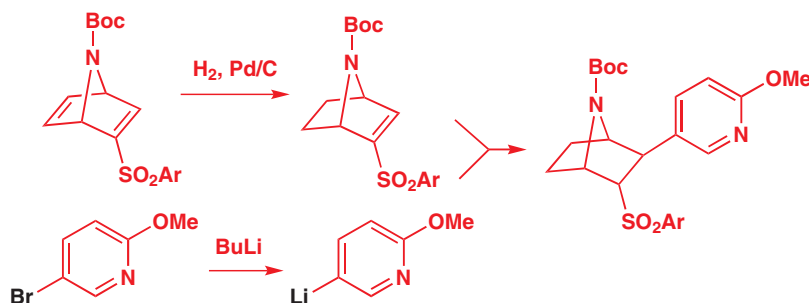

Furan is particularly good at Diels–Alder reactions but it gives the thermodynamic product, the *exo* adduct, because with this aromatic diene the reaction is reversible.

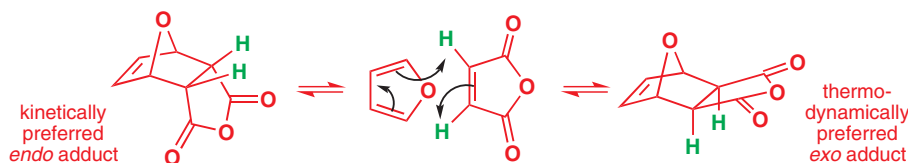

Aromaticity prevents thiophene taking part in Diels–Alder reactions, but oxidation to the sulfone destroys the aromaticity because both lone pairs become involved in bonds to oxygen. The sulfone is unstable and reacts with itself but will also do Diels–Alder reactions. With an alkyne, loss of SO_2 gives a substituted benzene derivative.

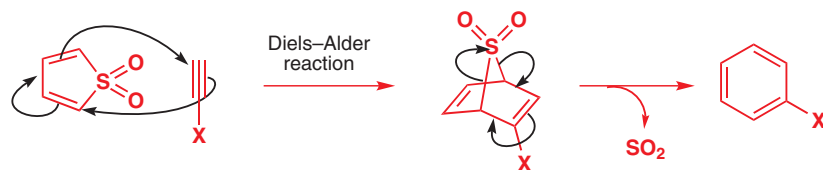

Similar reactions occur with α -pyrones. These are also rather unstable and barely aromatic and they react with alkynes by Diels–Alder reactions followed by reverse Diels–Alder reactions to give benzene derivatives with the loss of CO_2 .

➔ The Boc protecting group is discussed in Chapter 23, p. 558.

Epibatidine was discovered in the skin of Ecuadoran frogs in 1992. It is an exceptionally powerful analgesic and works by a different mechanism from that of morphine so there is hope that it will not be addictive. The compound can now be synthesized so there is no need to kill the frogs to get it—indeed, they are a protected species.

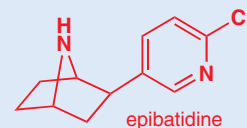

➔ *Endo* and *exo* Diels–Alder adducts are explained in Chapter 34.

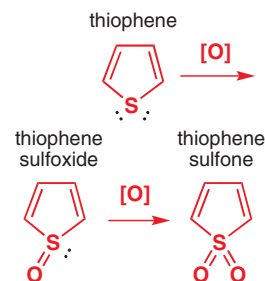

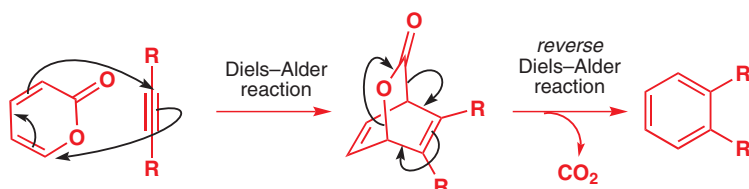

Nitrogen anions can be easily made from pyrrole

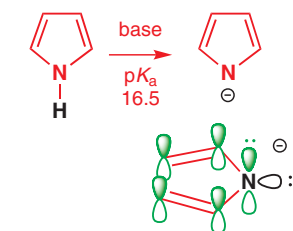
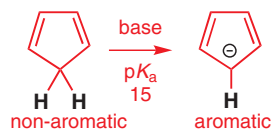
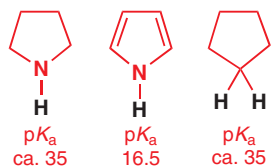

Pyrrole is much more acidic than comparable saturated amines. The pK_a of pyrrolidine is about 35, but pyrrole has a pK_a of 16.5, making it some 10^{23} times more acidic! Pyrrole is about as acidic as a typical alcohol so bases stronger than alkoxides will convert it to its anion. We should not be too surprised at this as the corresponding hydrocarbon, cyclopentadiene, is also extremely acidic, with a pK_a of 15. The reason is that the anions are aromatic with six delocalized π electrons. The effect is much greater for cyclopentadiene because the hydrocarbon is not aromatic and much less for pyrrole because it is already aromatic and has less to gain.

In all of the reactions of pyrrole that we have so far seen, new groups have added to the carbon atoms of the ring. The anion of pyrrole is useful because it reacts at nitrogen. The nitrogen atom has two lone pairs of electrons in the anion: one is delocalized around the ring but the other is localized in an sp^2 orbital on nitrogen. This high-energy pair is the new HOMO and this is where the molecule reacts. *N*-acylated derivatives in general can be made in this way. A commonly used base is sodium hydride (NaH) but weaker bases produce enough anion for reaction to occur.

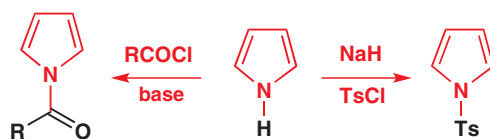

- Anions of pyrroles react with electrophiles at the *nitrogen* atom.

This is how the *N*-Boc pyrrole was made for use in the synthesis of epibatidine on p. 739. The base used was the pyridine derivative DMAP, which you met earlier in the chapter (p. 726). Its conjugate acid has a pK_a of 9.7 and so produces small, equilibrating amounts of the anion as well as acting as a nucleophilic catalyst. 'Boc anhydride' is used as the acylating agent.

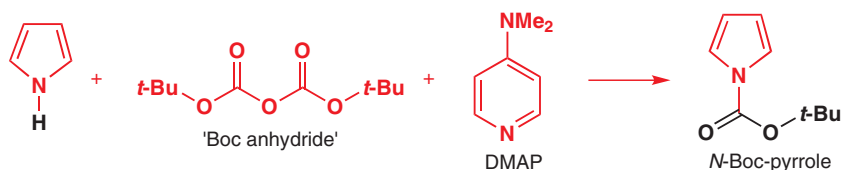

Anion formation is important in the next main section of this chapter, which is about what happens when we insert more nitrogen atoms into the pyrrole ring.

Five-membered rings with two or more nitrogen atoms

Imidazole

At the beginning of this chapter we imagined adding more nitrogen atoms to the pyrrole ring and noticed then that there were two compounds with two nitrogen atoms: pyrazole and imidazole.

➔ DMAP's pK_a of 9.7 is between those of pyridine (5.5) and tertiary alkyl amines (ca. 10) but is much closer to the latter.

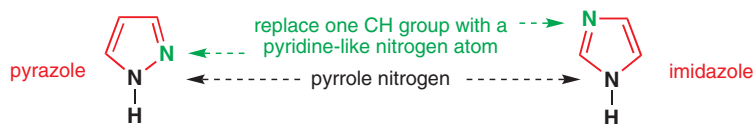

Only one nitrogen atom in a five-membered ring can contribute two electrons to the aromatic sextet. The other replaces a CH group, has no hydrogen, and is like the nitrogen atom in pyridine. The black nitrogens are the pyrrole-like nitrogens; the green ones are pyridine-like. The lone pairs on the black nitrogens are delocalized round the ring; those on the green nitrogens are localized in sp^2 orbitals on nitrogen. We can expect these compounds to have properties intermediate between those of pyrrole and pyridine. Imidazole is a stronger base than either pyrrole or pyridine—the imidazolium ion has a pK_a of almost exactly 7, meaning that it is 50% protonated in neutral water. Imidazole is also more acidic than pyrrole, with a pK_a of 14.5.

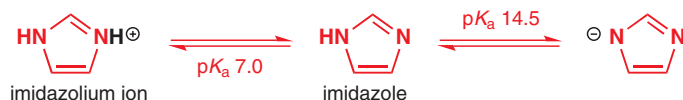

These curious results are a consequence of the 1,3 relationship between the two nitrogen atoms. Both the (protonated) cation and the (deprotonated) anion share the charge equally between the two nitrogen atoms—they are perfectly symmetrical and unusually stable. Another way to look at the basicity of imidazole would be to say that both nitrogen atoms can act at once on the proton being attacked. It has to be the pyridine-like nitrogen that actually captures the proton but the pyrrole nitrogen can help by using its delocalized electrons like this:

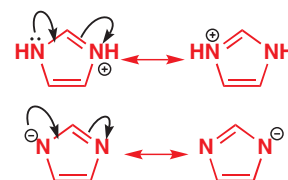

➔ A similar effect accounts for the basicity of DBU, see p. 175.

Nature makes use of this property by having imidazole groups attached to proteins in the form of the amino acid histidine and using them as nucleophilic, basic, and acidic catalytic groups in enzyme reactions (this will be discussed in Chapter 42). We use this property in the same way when we add a silyl group to an alcohol. Imidazole is a popular catalyst for these reactions.



A weakly basic catalyst is needed here because we want to discriminate between the primary and secondary alcohols in the diol. Imidazole is too weak a base to remove protons from an alcohol ($pK_a \sim 16$) but it can remove a proton after the OH group has attacked the silicon atom.

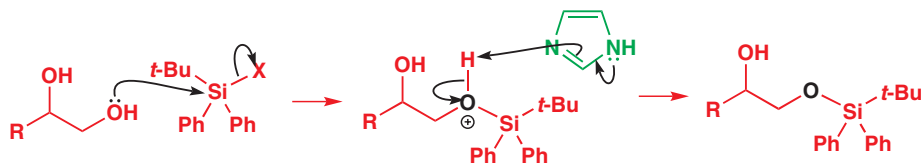

In fact, the imidazole is also a nucleophilic catalyst of this reaction, and the first step is substitution of Cl by imidazole—that is why the leaving group in the last scheme was shown as 'X'. The reaction starts off like this:

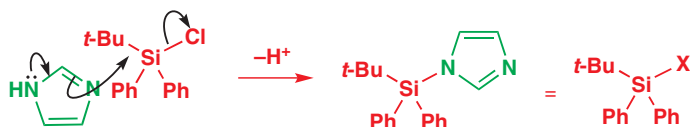

The same idea leads to the use of carbonyl diimidazole (CDI) as a double electrophile when we want to link two nucleophiles together by a carbonyl group. Phosgene (COCl_2) has been used for this but it is appallingly toxic (it was used in the First World War as a poison gas with dreadful effects). CDI is safer and more controlled. In these reactions imidazole acts (twice) as a leaving group.

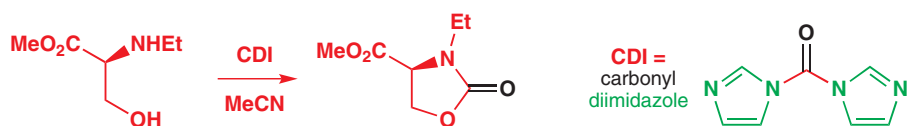

The amino group probably attacks first to displace one imidazole anion, which returns to deprotonate the ammonium salt. The alcohol can then attack intramolecularly, displacing the second imidazole anion, which deprotonates the OH group in its turn. The other product is just two molecules of imidazole.

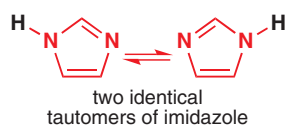
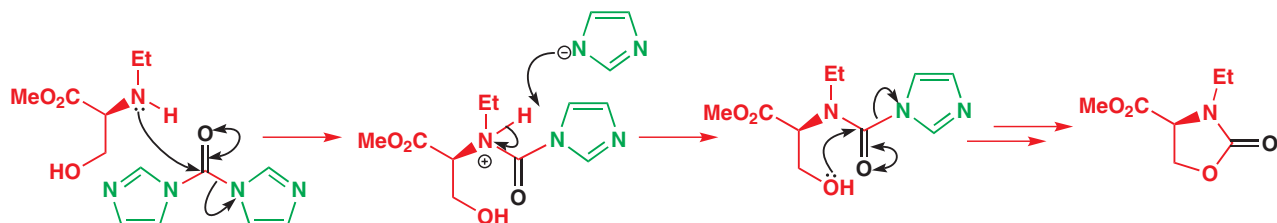

The relationship between the delocalized imidazole anion and imidazole itself is rather like that between an enolate anion and an enol. It will come as no surprise therefore that, like an enol, imidazole tautomerizes rapidly at room temperature in solution. For the parent compound the two tautomers are the same, but with unsymmetrical imidazoles the tautomerism is more interesting. We will explore this question alongside electrophilic aromatic substitution of imidazoles. Imidazoles with a substituent between the two nitrogen atoms (position 2) can be nitrated with the usual reagents and the product consists of a mixture of tautomers.

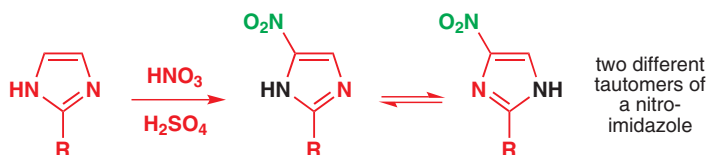

The initial nitration may occur at either of the remaining sites on the ring with the electrons coming from the pyrrole-like nitrogen atom. Tautomerism after nitration gives the mixture. Tautomerism is rapid and the tautomers cannot be separated.

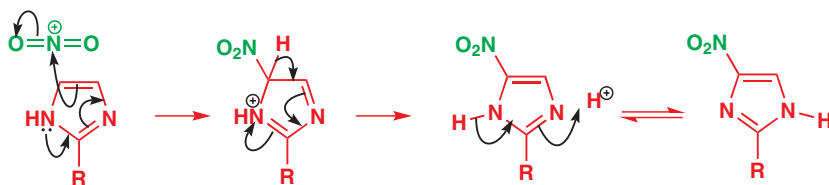

The tautomerism can be stopped by alkylation at one of the nitrogen atoms. If this is done in basic solution, the anion is an intermediate and the alkyl group adds to the nitrogen atom next to the nitro group. Again, it does not matter from which tautomer the anion is derived—there is only one anion delocalized over both nitrogen atoms and the nitro group. One reason for the formation of this isomer is that it has the linear conjugated system between the pyrrole-like nitrogen and the nitro group (see p. 734).

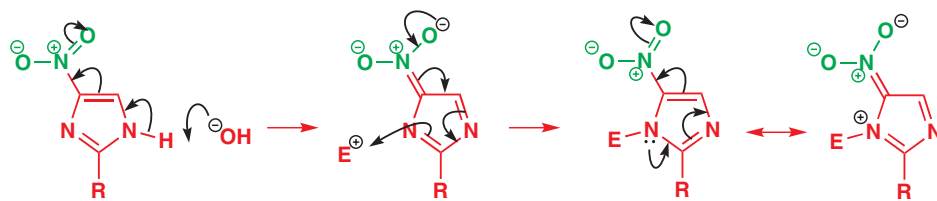

Important medicinal compounds are made in this way. The antiparasitic metronidazole comes from 2-methyl imidazole by nitration and alkylation with an epoxide in base.

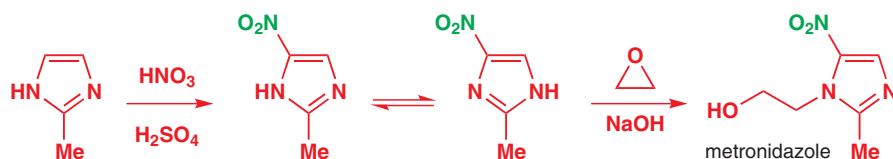

The triazoles

There are two triazoles, and each has one pyrrole-like nitrogen and two pyridine-like nitrogens. Both triazoles have the possibility of tautomerism (in 1,2,3-triazole the tautomers are identical) and both give rise to a single anion.

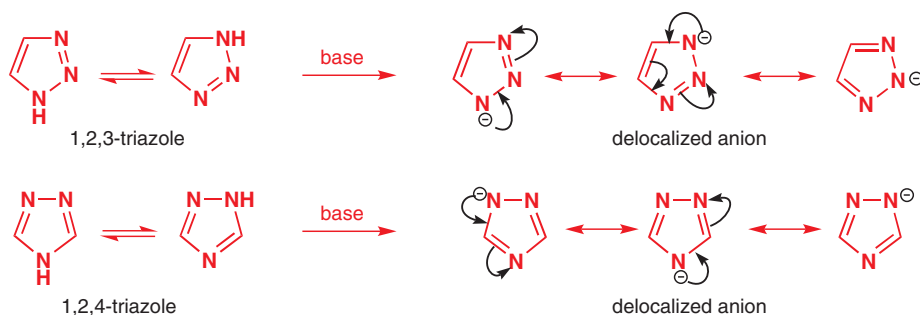

The 1,2,4-triazole is more important because it is the basis of the best modern agricultural fungicides as well as drugs for fungal diseases in humans. The extra nitrogen atom, inevitably of the pyridine type, makes it more weakly basic than imidazole, but it increases its acidity so that the anion is now easy to make.

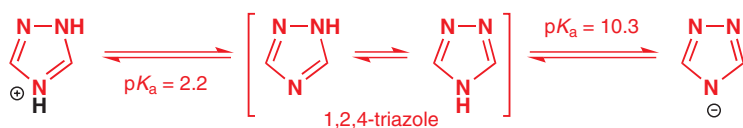

The fungicides are usually made by the addition of the triazole anion to an epoxide or other carbon electrophile. The anion normally reacts at one of the two linked nitrogen atoms (it does not matter which—the product is the same).

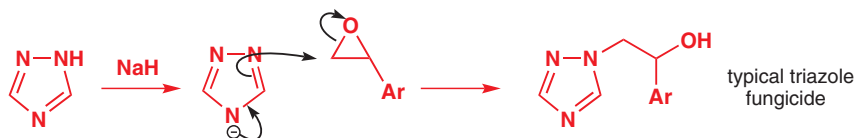

A modern example of an agent used against human fungal infections is Pfizer's fluconazole, which actually contains two triazoles. The first is added as the anion to an α -chloroketone and the second is added to an epoxide made with the sulfur ylid chemistry you met in Chapter 27. Note that weak bases were used to catalyse both of these reactions. Triazole is acidic enough for even NaHCO_3 to produce a small amount of the anion.

manufacture of Pfizer's fluconazole

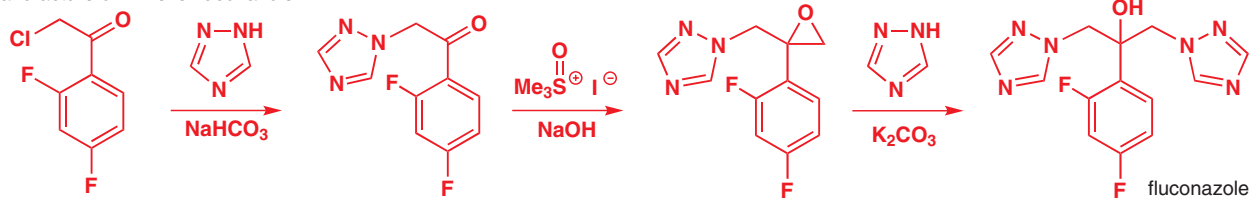

Tetrazole

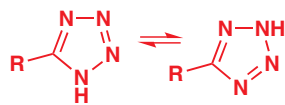

two tautomers of a tetrazole

There is only one isomer of tetrazole or of C-substituted tetrazoles, as there is only one carbon atom in the ring, although there may be several tautomers. The main interest in tetrazoles is that they are rather acidic: the $\text{p}K_a$ for the loss of the NH proton to form an anion is about 5, essentially the same as that of a carboxylic acid. The anion is delocalized over all four nitrogen atoms (as well as the one carbon atom), and four nitrogen atoms do the work of two oxygen atoms.

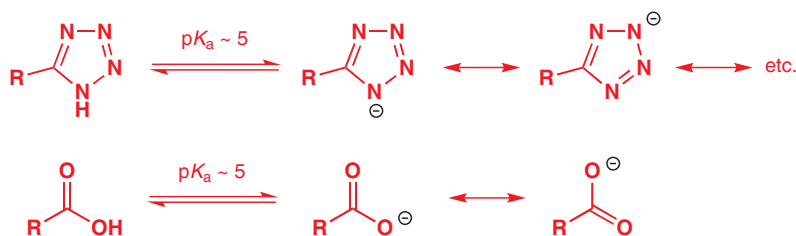

Because tetrazoles have similar acidities to those of carboxylic acids, they have been used in drugs as replacements for the CO_2H unit when the carboxylic acid has unsatisfactory properties for human medicine. A simple example is the anti-arthritis drug indomethacin whose carboxylic acid group may be replaced by a tetrazole with no loss of activity.

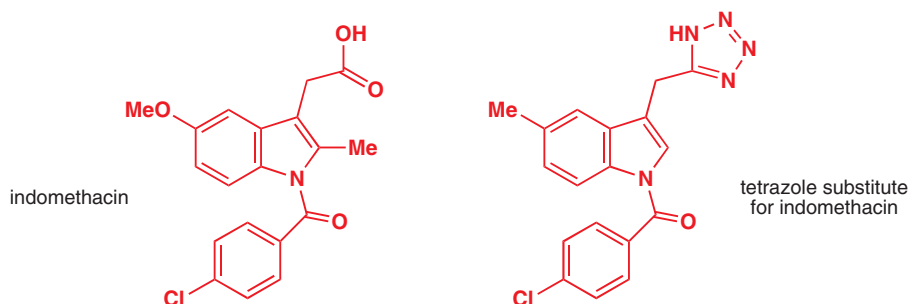

Nitrogen atoms and explosions

Compounds with even two or three nitrogen atoms joined together, such as diazomethane (CH_2N_2) or azides (RN_3), are potentially explosive because they can suddenly give off stable gaseous nitrogen. Compounds with more nitrogen atoms, such as tetrazoles, are likely to be more dangerous and few people have attempted to prepare pentazoles. The limit is reached with diazotetrazole, with the amazing formula CN_6 ! It is made by diazotization of 5-amino-1H-tetrazole, which first gives a diazonium salt.

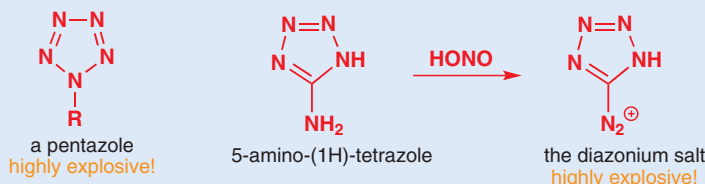

The diazonium salt is extremely dangerous: 'It should be emphasised that [the diazonium salt] is extremely explosive and should be handled with great care. We recommend that no more than 0.75 mmol be isolated at one time. Ethereal solutions are somewhat more stable but explosions have occurred after standing at $-70\text{ }^{\circ}\text{C}$ for 1 hr.' So much for that, but what about the diazo compound? It is extremely unstable and decomposes to a carbene with loss of one molecule of nitrogen and then loses two more to give...

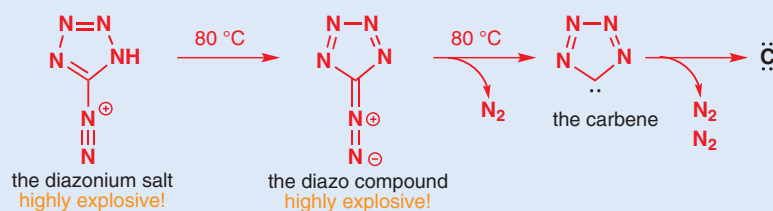

All that is left is a carbon atom and this is one of very few ways to make carbon atoms chemically. The carbon atoms have remarkable reactions and these have been studied briefly, but the hazardous preparation of the starting materials discourages too much research. However, you will see in the next chapter that 1-amino tetrazole is a useful starting material for making an anti-allergic drug.

Benzo-fused heterocycles

Indoles are benzo-fused pyrroles

Indomethacin and its tetrazole analogue contain pyrrole rings with benzene rings fused to the side. Such bicyclic heterocyclic structures are called **indoles** and are our next topic. Indole itself has a benzene ring and a pyrrole ring sharing one double bond, or, if you prefer to look at it this way, it is an aromatic system with 10 electrons—eight from four double bonds and the lone pair from the nitrogen atom.

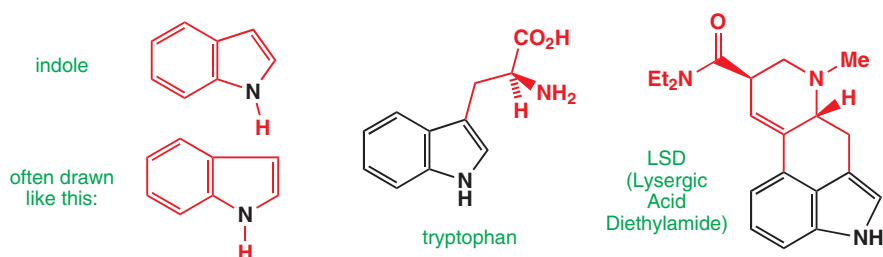

Indole is an important heterocyclic system because it is built into proteins in the form of the amino acid tryptophan (Chapter 42) because it is the basis of important drugs such as indomethacin, and because it provides the skeleton of the **indole alkaloids**—biologically active compounds from plants including strychnine and LSD (alkaloids are discussed in Chapter 42).

In many ways the chemistry of indole is that of a reactive pyrrole ring with a relatively unreactive benzene ring standing on one side—electrophilic substitution almost always occurs on the pyrrole ring, for example. But indole and pyrrole differ in one important respect. In indole, electrophilic substitution is preferred in the 3-position with almost all reagents whereas it occurs in the 2-position with pyrrole. Halogenation, nitration, sulfonation, Friedel–Crafts acylation, and alkylation all occur cleanly at that position.

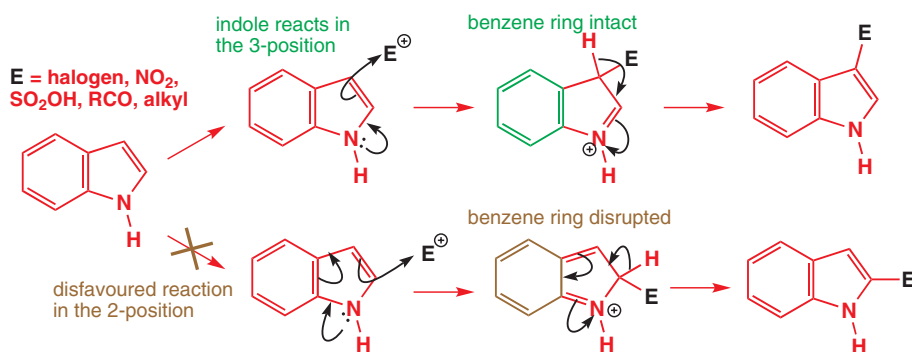

This is, of course, the reverse of what happens with pyrrole. Why should this be? A simple explanation is that reaction at the 3-position simply involves the rather isolated enamine system in the five-membered ring and does not disturb the aromaticity of the benzene ring. The positive charge in the intermediate is, of course, delocalized round the benzene ring, but it gets its main stabilization from the nitrogen atom. It is not possible to get reaction in the 2-position without seriously disturbing the aromaticity of the benzene ring.

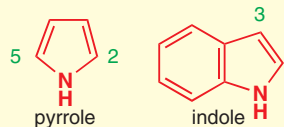

• **Electrophilic substitution on pyrrole and indole**

Pyrrole reacts with electrophiles at all positions but prefers the 2- and 5-positions, while indole much prefers the 3-position.

A simple example of electrophilic substitution is the Vilsmeier formylation with DMF and POCl_3 , showing that indole has similar reactivity, if different regioselectivity, to pyrrole. If the 3-position is blocked, reaction occurs at the 2-position and this at first seems to suggest that it is all right after all to take the electrons the ‘wrong way’ round the five-membered ring. This intramolecular Friedel–Crafts alkylation is an example.

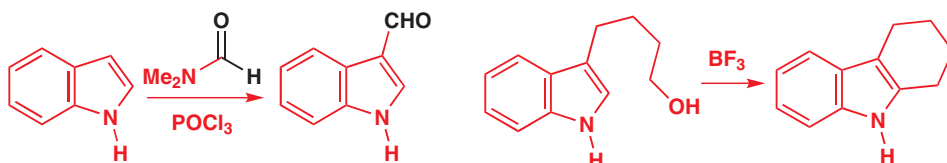

An ingenious experiment showed that this cyclization is not as simple as it seems. If the starting material is labelled with tritium (radioactive ^3H) next to the ring, the product shows exactly 50% of the label where it is expected and 50% where it is not.

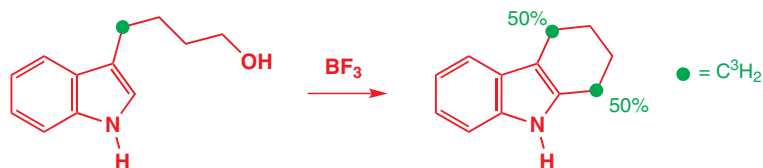

To give this result, the reaction must have a symmetrical intermediate and the obvious candidate arises from attack at the 3-position. The product is formed from the intermediate *spiro* compound, which has the five-membered ring at right angles to the indole ring—each CH_2 group has an exactly equal chance of migrating.

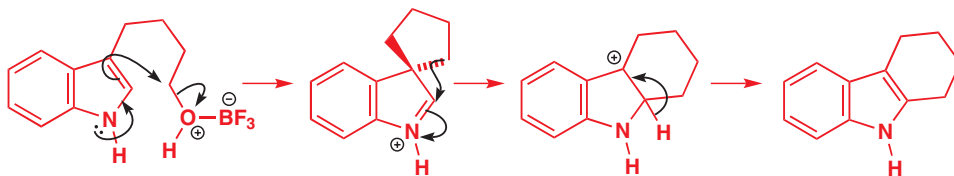

➔ The migration is a pinacol-like rearrangement similar to those in Chapter 36.

It is now thought that most substitutions in the 2-position go by this migration route but that some go by direct attack with disruption of the benzene ring. A good example of indole's 3-position preference is the Mannich reaction, which works as well with indole as it does with pyrrole or furan.

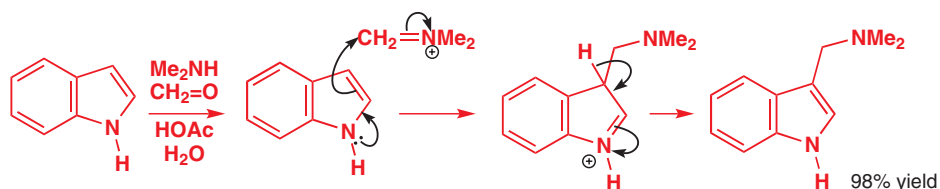

The electron-donating power of the indole and pyrrole nitrogens is never better demonstrated than in the use to which these Mannich bases (the products of the reaction) are put. You may remember that normal Mannich bases can be converted to other compounds by alkylation and elimination (see p. 621). No alkylation is needed here as the indole nitrogen can even expel the Me_2N group when NaCN is around as a base and nucleophile. The reaction is slow and the yield not wonderful but it is amazing that it happens at all. The reaction is even easier with pyrrole derivatives.

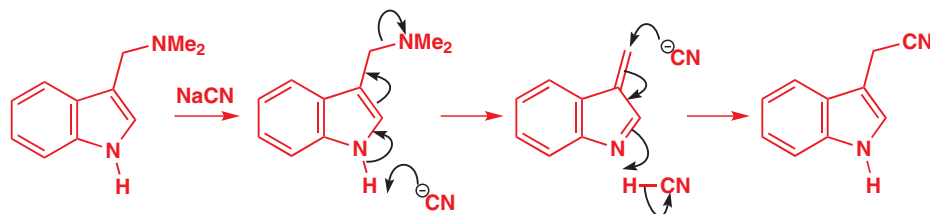

All of the five-membered rings we have looked at have their benzo-derivatives but we will concentrate on just one, 1-hydroxybenzotriazole, both because it is an important compound and because we have said little about simple 1,2,3-triazoles.

HOBt is an important reagent in peptide synthesis

1-Hydroxybenzotriazole (HOBt) is a friend in need in the lives of biochemists. It is added to many reactions where an activated ester of one amino acid is combined with the free amino group of another (see Chapter 23 for some examples). It was first made in the nineteenth century by a remarkably simple reaction.

The structure of HOBt appears quite straightforward, except for the unstable N–O single bond, but we can easily draw some other tautomers in which the proton on oxygen—the only one in the heterocyclic ring—can be placed on some of the nitrogen atoms. These structures are all aromatic, the second and third are nitrones, and the third structure looks less good than the other two.

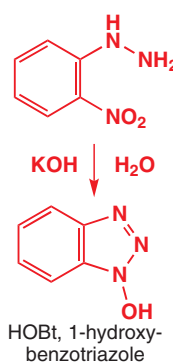
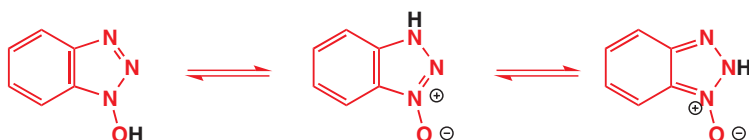

➔ You will meet some nitrone chemistry in Chapter 34.

HOBt comes into play when amino acids are being coupled together in the laboratory. The reaction is an amide formation, but in Chapter 23 we mentioned that amino-acyl chlorides cannot be used to make polypeptides—they are too reactive and they lead to side reactions. Instead, activated amino-esters (with good RO^- leaving groups) are used, such as the phenyl esters of Chapter 23. It is even more common to form the activated ester in the coupling reaction, using a coupling reagent, the most common being DCC, dicyclohexylcarbodiimide. DCC reacts with carboxylic acids like this:

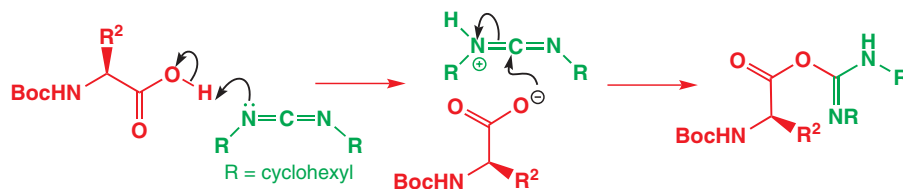

The product ester is activated because substitution with any nucleophile expels this very stable urea as a leaving group.

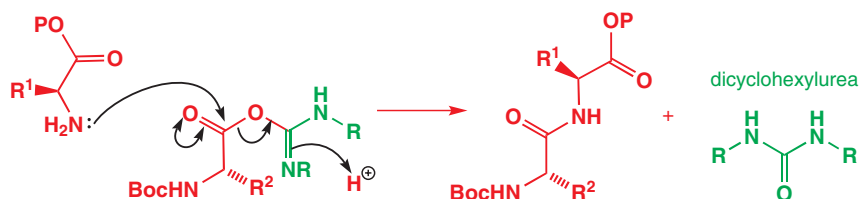

The problem with attacking this ester directly with the amino group of the second amino acid is that some racemization of the active ester is often found. A better method is to have plenty of HOBT around. It intercepts the activated ester first and the new intermediate does not racemize, mostly because the reaction is highly accelerated by the addition of HOBT. The second amino acid, protected on the carboxyl group, attacks the HOBT ester and gives the dipeptide in a very fast reaction without racemization.

➔ You saw in Chapter 26 that the most electrophilic carboxylic acid derivatives are also the most enolizable.

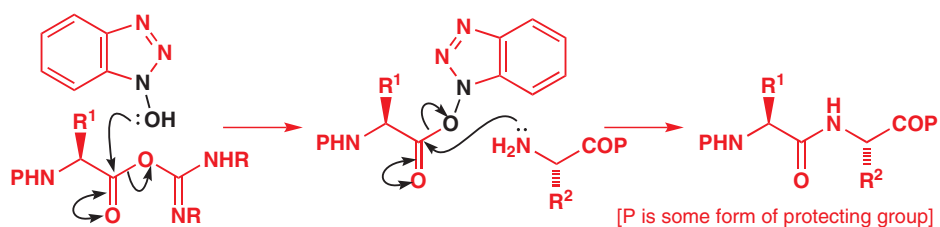

Putting more nitrogen atoms in a six-membered ring

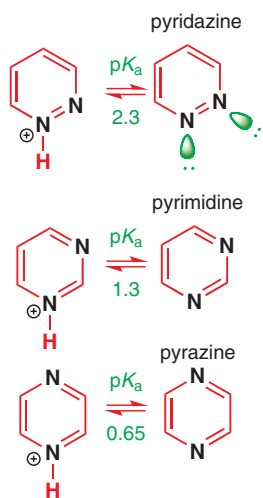

At the beginning of the chapter we mentioned the three six-membered aromatic heterocycles with two nitrogen atoms—pyridazine, pyrimidine, and pyrazine. In these compounds both nitrogen atoms must be of the pyridine sort, with lone pair electrons not delocalized round the ring.

We are going to look at these compounds briefly here. Pyrimidine is more important than either of the others because of its involvement in DNA and RNA—you will find this in Chapter 42. All three compounds are very weak bases—hardly basic at all in fact. Pyridazine is slightly more basic than the other two because the two adjacent lone pairs repel each other and make the molecule more nucleophilic (the α effect again: see p. 513). The chemistry of these very electron-deficient rings mostly concerns nucleophilic attack and displacement of leaving groups such as Cl by nucleophiles such as alcohols and amines. To introduce this subject we need to take one heterocyclic synthesis at this point, although these are properly the subject of the next chapter. The compound maleic hydrazide has been known for some time because it is easily formed when hydrazine is acylated twice by maleic anhydride.

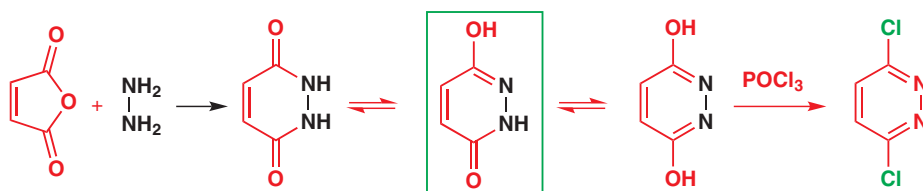

The compound actually prefers to exist as the second tautomer (in the green frame). Reaction with POCl_3 in the way we have seen for pyridine gives the undoubtedly aromatic pyridazine dichloride. Now we come to the point. Each of these chlorides can be displaced in turn with an oxygen or nitrogen nucleophile. Only one chloride is displaced in the first reaction, if that is required, and then the second can be displaced with a different nucleophile.

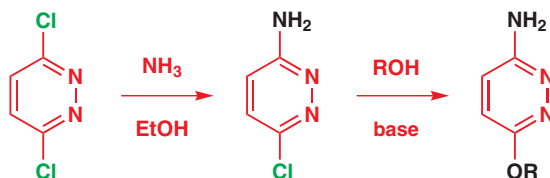

How is this possible? The mechanism of the reactions is addition to the pyridazine ring followed by loss of the leaving group. When the second nucleophile attacks it is forced to attack a less electrophilic ring. An electron-withdrawing group (Cl) has been replaced by a strongly electron-donating group (NH₂) so the rate-determining step, the addition of the nucleophile, is slower.

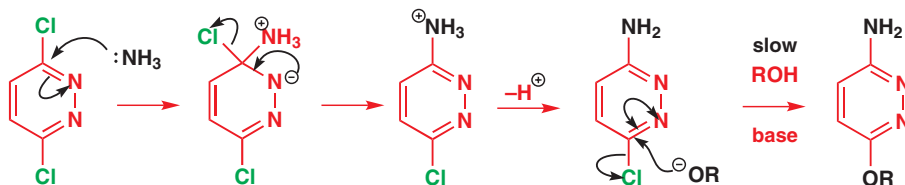

The same principle applies to other easily made symmetrical dichloro derivatives of these rings and their benzo analogues. The nitrogen atoms can be related 1,2, 1,3, or 1,4, as in these examples. The first two are used to link the quinine-derived ligands required for the Sharpless asymmetric dihydroxylation, which will be described in Chapter 41.

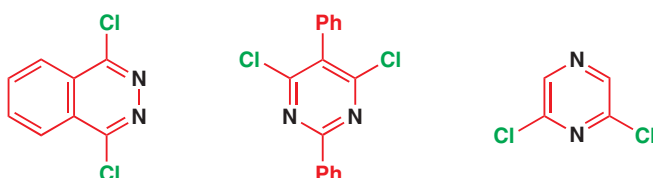

Fusing rings to pyridines: quinolines and isoquinolines

A benzene ring can be fused on to the pyridine ring in two ways, giving the important heterocycles quinoline, with the nitrogen atom next to the benzene ring, and isoquinoline, with the nitrogen atom in the other possible position. Quinoline forms part of quinine (structure at the head of this chapter) and isoquinoline forms the central skeleton of the isoquinoline alkaloids, which we will discuss in Chapter 42. In this chapter we need not say much about quinoline because it behaves rather as you would expect—its chemistry is a mixture of that of benzene and pyridine. Electrophilic substitution favours the benzene ring and nucleophilic substitution favours the pyridine ring. So nitration of quinoline gives two products—the 5-nitroquinolines and the 8-nitroquinolines—in about equal quantities (although you will realize that the reaction really occurs on protonated quinoline).

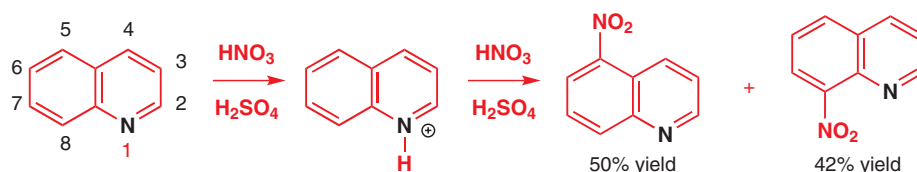
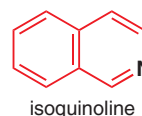
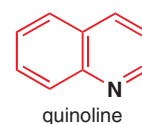

This is obviously rather unsatisfactory but nitration is actually one of the better behaved reactions. Chlorination gives ten products (at least!), of which no fewer than five are chlorinated quinolines of various structures. The nitration of isoquinoline is rather better behaved, giving 72% of one isomer (5-nitroisoquinoline) at 0 °C.

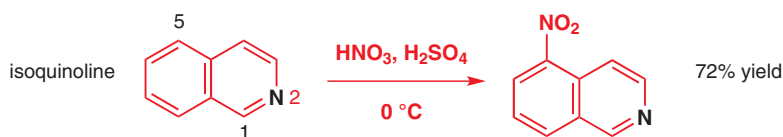

To get reaction on the pyridine ring, the *N*-oxide can be used—as with pyridine itself. A good example is acridine, with two benzene rings, which gives four nitration products, all on the benzene rings. Its *N*-oxide, on the other hand, gives just one product in good yield—nitration takes place at the only remaining position on the pyridine ring.

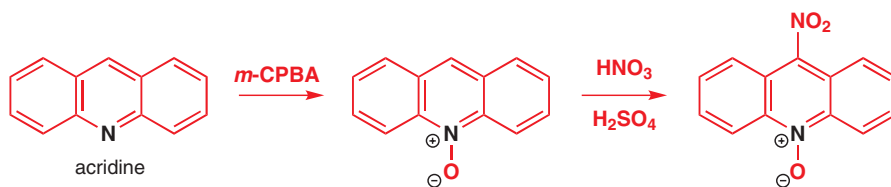

In general, these reactions are not of much use and most substituents are put into quinolines during ring synthesis from simple precursors, as we will explain in the next chapter. There are a couple of quinoline reactions that are unusual and interesting. Vigorous oxidation goes for the more electron-rich ring, the benzene ring, and destroys it leaving pyridine rings with carbonyl groups in the 2- and 3-positions.

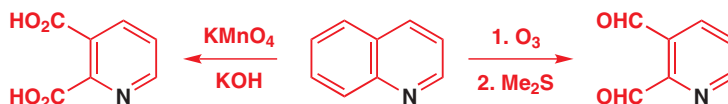

A particularly interesting nucleophilic substitution occurs when quinoline *N*-oxide is treated with acylating agents in the presence of nucleophiles. These two examples show that nucleophilic substitution occurs in the 2-position and you may compare these reactions with those of pyridine *N*-oxide. The mechanism is similar.

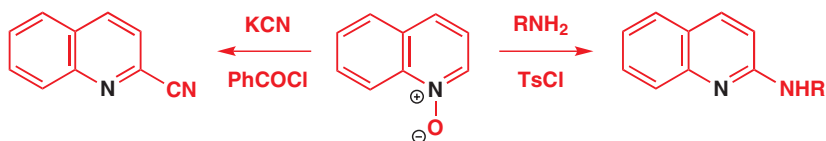

In considering quinolines and indoles with their fused rings we kept the benzene and heterocyclic rings separate. Yet there is a way in which they can be combined more intimately, and that is to have a nitrogen atom at a ring junction.

A nitrogen atom can be at a ring junction



It has to be a pyrrole-type nitrogen as it must have three σ bonds, so the lone pair must be in a *p* orbital. This means that one of the rings must be five-membered and the simplest member of this interesting class is called indolizine—it has pyridine and pyrrole rings fused together along a C–N bond. If you examine this structure you will see that there is definitely a pyrrole ring but that the pyridine ring is not all there. Of course, the lone pair and the π electrons are all delocalized but this system, unlike indole and quinoline, is much better regarded as a ten-electron outer ring than as two six-electron rings joined together. Indolizine reacts with electrophiles on the five-membered rings by substitution reactions as expected.

Fused rings with more than one nitrogen

It is easily possible to continue to insert nitrogen atoms into fused ring systems and some important compounds belong to these groups. The purines are part of DNA and RNA, one example is adenine and another is guanine in the box below, but simple purines play an important part in our lives. Coffee and tea owe their stimulant properties to caffeine, a simple trimethyl purine derivative. It has an imidazole ring fused to a pyrimidine ring and is aromatic in spite of the two carbonyl groups.

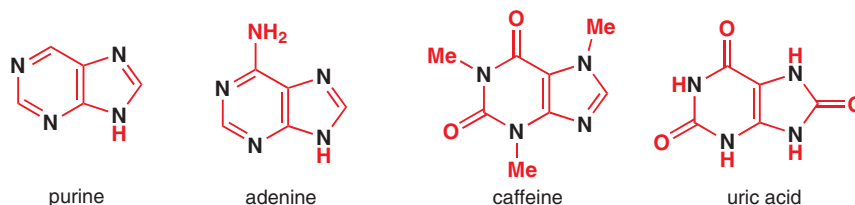

Uric acid, gout, and allopurinol

Another purine, uric acid, occurs widely in nature—it is used by birds, and to some extent by humans, as a way to excrete excess nitrogen—but it causes much distress in humans when crystalline uric acid is deposited in joints. We call the pain 'gout'. The solution is a specific inhibitor of the enzyme producing uric acid and it is no surprise that a compound closely resembling uric acid, allopurinol, is the best.

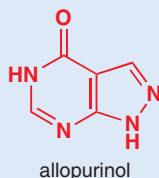

Two of the carbonyl groups have gone and the imidazole ring has been replaced by a pyrazole ring. Purines from DNA are degraded in the body to xanthine, which is oxidized to uric acid. Allopurinol binds to the enzyme xanthine oxidase but inactivates it by not reacting. In fact it imitates not uric acid but the true substrate xanthine in a competitive fashion. This enzyme plays a minor part in human metabolism so inhibiting it is not serious—it just prevents over-production of uric acid.

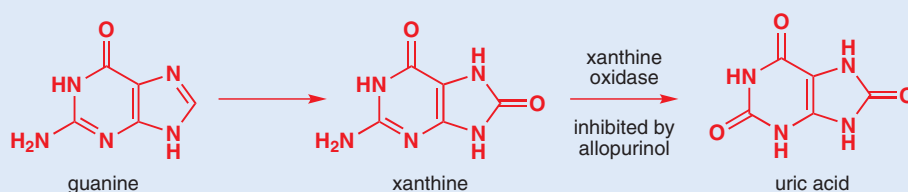

Other fused heterocycles have very attractive flavour and odour properties. Pyrazines, in general, are important in many strong food flavours: a fused pyrazine with a ring junction nitrogen atom is one of the most important components in the smell of roast meat. You can read about the simple pyrazine that provides green peppers with their flavour in the box on the next page.

Finally, the compounds in the margin form a medically important group of molecules, which includes antitumour compounds for humans and anthelmintics (compounds that get rid of parasitic worms) for animals. They are derived from a 6/5 fused aromatic ring system that resembles the ten-electron system of the indolizine ring system but has three nitrogen atoms.

All this multiple heteroatom insertion is possible only with nitrogen and we need to look briefly at what happens when we combine nitrogen with oxygen or in heterocycles.

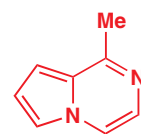

smell of roast meat

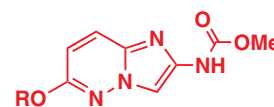

useful medicinal compounds

Aromatic heterocycles can have many nitrogens but only one sulfur or oxygen in any ring

A neutral oxygen or sulfur atom can have only two bonds and so it can never be like the nitrogen atom in pyridine—it can only be like the nitrogen atom in pyrrole. We can put as many pyridine-like nitrogens as we like in an aromatic ring, but never more than one pyrrole-like nitrogen. Similarly, we can put only one oxygen or sulfur atom in an aromatic ring. The simplest examples are oxazoles and thiazoles, and their less stable isomers isoxazoles and isothiazoles.

The instability of the 'iso-' compounds comes from the weak O–N or S–N bond. These bonds can be cleaved by reducing agents, which then usually reduce the remaining functional groups further. The first product from reduction of the N–O bond is an unstable imino-enol. The enol tautomerizes to the ketone and the imine may be reduced further to the amine.

Such heterocycles with even more nitrogen atoms exist but are relatively unimportant and we shall mention just one, the 1,2,5-thiadiazole, because it is part of a drug, timolol.



oxazole



thiazole



isoxazole



isothiazole

■ Timolol is a β -blocker that blocks one action of adrenaline (epinephrine) and keeps heart disease at bay by counteracting high blood pressure.

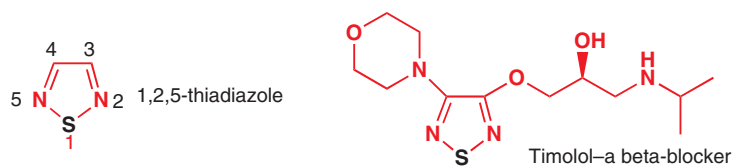

The flavour of green peppers

The discovery of the compound responsible for the flavour of green peppers provides us with a chance to review some spectroscopy. This powerful compound was isolated from the oil of the green pepper (*Capsicum annuum* var. *grossum*). The oil makes up about 0.0001% of the mass of the peppers and the main pepper flavour comes from one compound which is 30% of the oil. It had an even molecular ion at 166 and looks like a compound without nitrogen, perhaps $C_{11}H_{18}O$. But a high-resolution mass spectrum revealed that M^+ was actually 166.1102, which corresponds almost exactly to $C_9H_{14}N_2O$ (166.1106).

The IR had no OH, NH, or C=O peaks, and the proton NMR looked like this.

δ_H , ppm	Integral	Shape	J , Hz	Comments
0.91	6H	d	6.7	Me_2CH^-
1.1–2.4	1H	m	?	
2.61	2H	d	7.0	CH_2CH^-
3.91	3H	s	—	—OMe?
7.80	1H	d	2.4	aromatic
7.93	1H	d	2.4	aromatic

The 'CH' feature in the Me_2CH and CH_2CH signals must be the same CH and it must be the signal at 1.1–2.4 ppm described as a 'multiplet' as it is the only one showing enough coupling. It will be a septuplet of triplets, that is, 21 lines. We can easily reconstruct the aliphatic part of the molecule because it has two methyl groups and a CH_2 group joined to the same CH group.

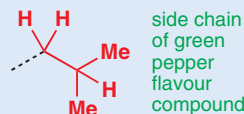

We also have an OMe group (only oxygen is electronegative enough to take a methyl group to nearly 4 ppm). This adds up to $C_5H_{12}O$. What is left? Only $C_4H_2N_2$ —and no clue yet as to the nitrogen functionality. We also have an aromatic ring that must have nitrogen in it (because there are only five carbon atoms—not enough for a benzene ring!) and the coupling constant between the two aromatic hydrogens is 2.4 Hz. So could we perhaps have a pyrrole ring? Well, no, and for two reasons. If we try and construct such a molecule, we can't fit in the last nitrogen! If we put it on the end of the dotted line, it would have to be an NH_2 group, and there isn't one.

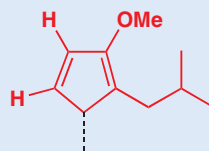

A better reason is that the chemical shifts are all wrong. The protons on an electron-rich pyrrole ring come at around 6–6.5 ppm, upfield from benzene (7.27 ppm). But these protons are at 7.8–8.0 ppm, downfield from benzene. We have a deshielded (electron-poor) ring, not a shielded (electron-rich) ring. From what you now know of heterocyclic chemistry, the ring must be a six-membered one, and we must put both nitrogen atoms in the ring. There are three ways to do this.

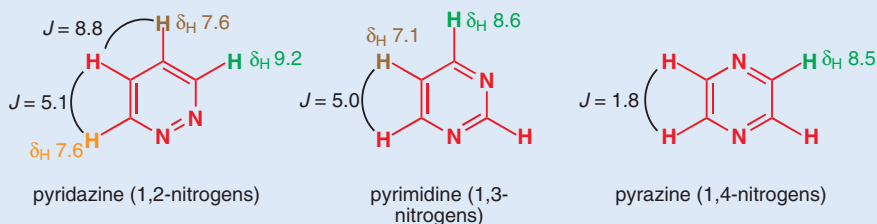

The small coupling constant really fits the pyrazine alone and the chemical shifts are about right for that molecule too, although not as far downfield. But we have a MeO group on the ring feeding electrons into the aromatic system and that will increase the shielding slightly and move the protons upfield. This gives us a unique structure.

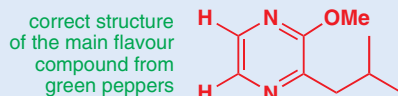

There is only one way to be sure and that is to make this compound and see if it is the same as the natural product in all respects, including biological activity. The investigators did this but then wished that they hadn't! The structure was indeed correct but the biological activity—the smell of green peppers—was so intense that they had to seal up the laboratory where the work was done as no one would work there. Human beings can detect 2 parts in 10^{12} of this compound in water.

There are thousands more heterocycles out there

But we're not going to discuss them and we hope you're grateful. In fact, it's about time to stop, and we shall leave you with a hint of the complexity that is possible. If pyrrole is combined with benzaldehyde a good yield of a highly coloured crystalline compound is formed: a porphyrin. Now, what about this ring system—is it aromatic? It's certainly highly delocalized and your answer to the question clearly depends on whether you include the nitrogen electrons or not. In fact, if you ignore the pyrrole-like nitrogen atoms but include the pyridine-like nitrogens and weave round the periphery, you have nine double bonds and hence 18 electrons—a $4n + 2$ number. Most people agree that these compounds are aromatic.

Some heterocycles are simple, some very complex, but we cannot live without them. We shall end this chapter with a wonderful story of heterocyclic chemistry at work. Folic acid is much in the news today as a vitamin that is particularly important for pregnant women, but is involved in the metabolism of all living things. Folic acid is built up in nature from three pieces: a heterocyclic starting material (red), *p*-aminobenzoic acid (black), and the amino acid glutamic acid (green). Here you see the precursor, dihydrofolic acid.

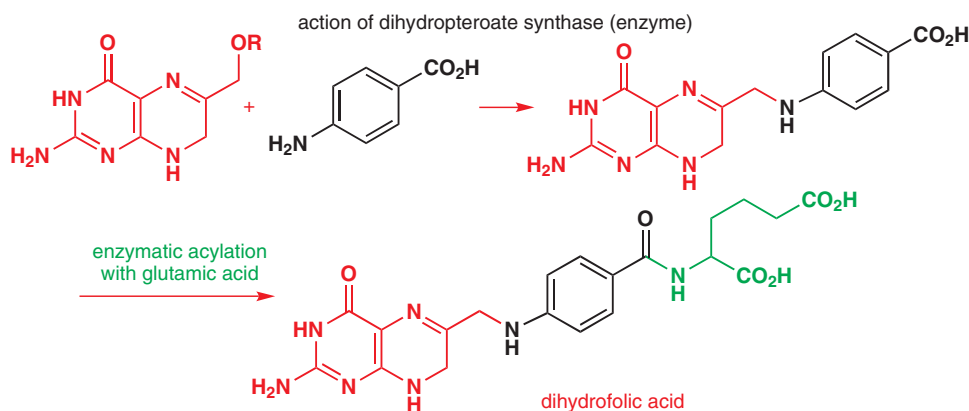

Although folic acid is vital for human health, we don't have the enzymes to make it: it's a vitamin, which means we must take it in our diet or we die. Bacteria, on the other hand, do make folic acid. This is very useful because it means that if we inhibit the enzymes of folic acid synthesis we can kill bacteria but we cannot possibly harm ourselves as we don't have those enzymes. The sulfa drugs, such as sulfamethoxypyridazine or sulfamethoxazole, imitate *p*-aminobenzoic acid and inhibit the enzyme dihydropteroate synthase. Each has a new heterocyclic system added to the sulfonamide part of the drug.

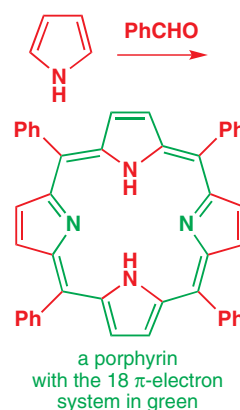
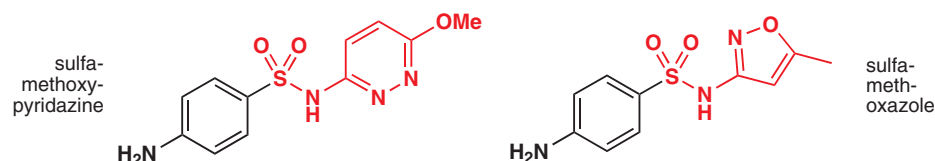

The next step in folic acid synthesis is the reduction of dihydrofolate to tetrahydrofolate. This can be done by both humans and bacteria, and although it looks like a rather trivial reaction (see black portion of molecules), it can only be done by the very important enzyme **dihydrofolate reductase**.

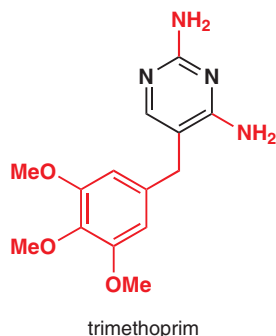
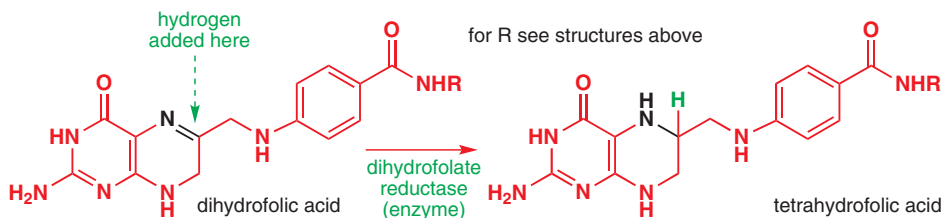

Although both bacteria and humans have this enzyme, the bacterial version is different enough for us to attack it with specific drugs. An example is trimethoprim—yet another heterocyclic compound with a pyrimidine core (black on diagram). These two types of drugs that attack the folic acid metabolism of bacteria are often used together.

We will see in the next chapter how to make these heterocyclic systems and, in Chapter 42, other examples of how important they are in living things.

Which heterocyclic structures should you learn?

This is, of course, nearly a matter of personal choice. Every chemist really must know the names of the simplest heterocycles and we give those below along with a menu of suggestions. First of all, those every chemist must know:



pyridine



pyrrole



thiophene



furan

Now the table gives a suggested list of five ring systems that have important roles in the chemistry of life and in human medicine—many drugs are based on these five structures.

1 Imidazole

the most important five-membered ring with two nitrogen atoms



part of the amino acid histidine, occurs in proteins and is important in enzyme mechanisms

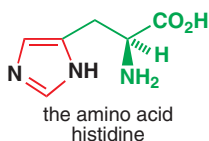

a substituted imidazole is an essential part of the anti-ulcer drug cimetidine

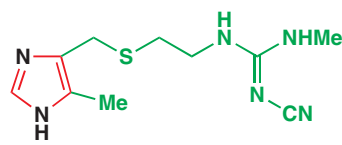

the anti-ulcer drug cimetidine (Tagamet)
a selective histidine mimic

2 Pyrimidine

the most important six-membered ring with two nitrogen atoms

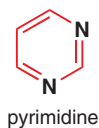

three functionalized pyrimidines are part of DNA and RNA structure, e.g. uracil

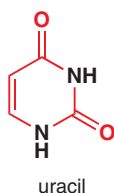

many antiviral drugs, particularly anti-HIV drugs, are modified pieces of DNA and contain pyrimidines

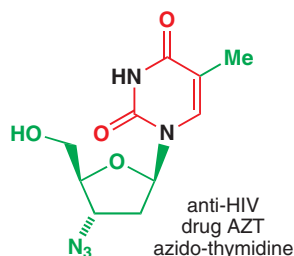

3 Quinoline

one of two benzo-pyridines with many applications

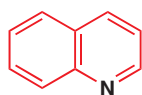

quinoline

occurs naturally in the important antimalarial drug quinine

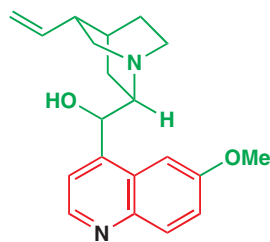

quinine

'cyanine' dyestuffs used as sensitizers for particular light wavelengths in colour photography

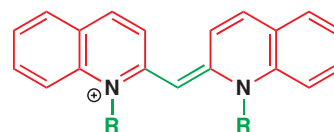

a 'cyanine' dyestuff

4 Isoquinoline

the other benzo-pyridine with many applications

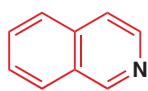

isoquinoline

occurs naturally in the benzyl isoquinoline alkaloids like papaverine

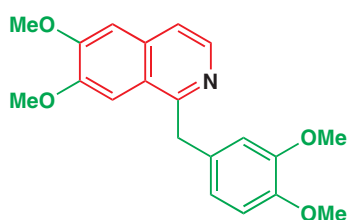

papaverine—a benzyl isoquinoline alkaloid

5 Indole

the more important benzo-pyrrole

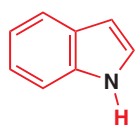

indole

occurs in proteins as tryptophan and in the brain as the neurotransmitter serotonin (5-hydroxytryptamine)

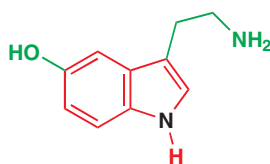

serotonin—a neurotransmitter

important modern drugs are based on serotonin, including sumatriptan for migraine and ondansetron, an antiemetic for cancer chemotherapy

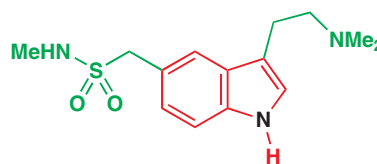

sumatriptan: for treatment of migraine

Further reading

Basic introduction: *Aromatic Heterocyclic Chemistry*, D. T. Davies, Oxford Primer, OUP, 1992. The best general text on heterocycles is J. A. Joule and K. Mills, *Heterocyclic Chemistry*, 4th edn, Chapman and Hall, London, 2010. S. Warren and P. Wyatt, *Workbook for Organic Synthesis: the Disconnection Approach*, Wiley, Chichester, 2009, chapters 32, 34, and 35.

Reference for the green pepper compound: R. G. Buttery, R.M. Seifert, R. E. Lundin, D. G. Guadagni, and L. C. Ling, *Chemistry and Industry (London)*, 1969, 490.

Diazotetrazole was made by P. B. Shevlin, *J. Am. Chem. Soc.* 1972, 94, 1379 and used in a reaction with buckminsterfullerene by R. M. Strongin and group, *J. Org. Chem.*, 1998, 63, 3522.

Check your understanding



To check that you have mastered the concepts presented in this chapter, attempt the problems that are available in the book's Online Resource Centre at <http://www.oxfordtextbooks.co.uk/orc/clayden2e/>

Aromatic heterocycles 2: synthesis

30

Connections

➔ Building on

- Aromaticity [ch7](#)
- Enols and enolates [ch20](#)
- Michael additions of enolates [ch25](#)
- Aldol reactions and acylation of enolates [ch26](#)
- Retrosynthetic analysis [ch28](#)
- Reactions of heterocycles [ch29](#)

Arriving at

- Thermodynamics is on our side
- Disconnecting the carbon–heteroatom bonds first
- How to make pyrroles, thiophenes, and furans from 1,4-dicarbonyl compounds
- How to make pyridines and pyridones
- How to make pyridazines and pyrazoles
- How to make pyrimidines from 1,3-dicarbonyl compounds and amidines
- How to make thiazoles
- How to make isoxazoles and tetrazoles by 1,3-dipolar cycloadditions
- The Fischer indole synthesis
- Making drugs: Viagra, sumatriptan, ondansetron, indomethacin
- How to make quinolines and isoquinolines

➔ Looking forward to

- Cycloadditions [ch34](#)
- Biological chemistry [ch42](#)

In this chapter you will revisit the heterocyclic systems you have just met and find out how to make them. You'll also meet some new heterocyclic systems and find out how to make those. With so many heterocycles to consider, you'd be forgiven for feeling rather daunted by this prospect, but do not be alarmed. Making heterocycles is easy—that's precisely why there are so many of them. Just reflect...

- Making C–O, C–N, and C–S bonds is easy.
- Intramolecular reactions are preferred to intermolecular reactions.
- Forming five- and six-membered rings is easy.
- We are talking about aromatic, that is, very stable molecules.

If we are to use these bullet points to our advantage we must think strategy before we start. When we were making benzene compounds we usually started with a preformed simple benzene derivative—toluene, phenol, aniline—and added side chains by electrophilic substitution. In this chapter our strategy will usually be to build the heterocyclic ring with most of its substituents already in place and add just a few others, perhaps by electrophilic substitution, but mostly by nucleophilic substitution.

We will usually make the rings by cyclization reactions with the heteroatom (O, N, S) as a nucleophile and a suitably functionalized carbon atom as the electrophile. This electrophile

Online support. The icon  in the margin indicates that accompanying interactive resources are provided online to help your understanding: just type www.chemtube3d.com/clayden/123 into your browser, replacing **123** with the number of the page where you see the icon. For pages linking to more than one resource, type **123-1**, **123-2** etc. (replacing **123** with the page number) for access to successive links.

will almost always be a carbonyl compound of some sort and this chapter will help you revise your carbonyl chemistry from Chapters 10, 11, 20, 25, and 26 as well as the approach to synthesis described in Chapter 28.

Thermodynamics is on our side

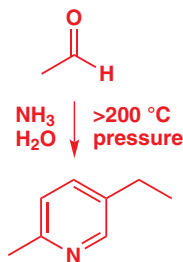

➡ Allopurinol was discussed in Chapter 29, p. 751.

Some of the syntheses we will meet will be quite surprisingly simple! It sometimes seems that we can just mix a few things together with about the right number of atoms and let thermodynamics do the rest. A commercial synthesis of pyridines combines acetaldehyde and ammonia under pressure to give a simple pyridine.

The yield is only about 50%, but what does that matter in such a simple process? By counting atoms we can guess that four molecules of aldehyde and one of ammonia react, but exactly how is a triumph of thermodynamics over mechanism. Much more complex molecules can sometimes be made very easily too. Take allopurinol, for example, which you met in the last chapter. It is not too difficult to work out where the atoms go—the hydrazine obviously gives rise to the pair of adjacent nitrogen atoms in the pyrazole ring and the ester group must be the origin of the carbonyl group (the colours and numbers illustrate this)—but would you have planned this synthesis?

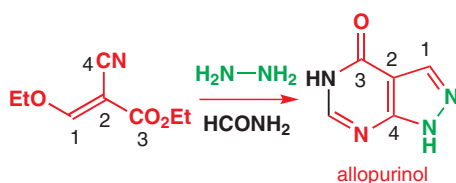

We will see that this sort of ‘witch’s brew’ approach to heterocyclic synthesis is restricted to a few basic ring systems and that, in general, careful planning is just as important here as elsewhere. The difference is that the synthesis of aromatic heterocycles is very forgiving—it often ‘goes right’ instead of going wrong. We’ll now look seriously at planning the synthesis of aromatic heterocycles.

Disconnect the carbon–heteroatom bonds first

The simplest synthesis for a heterocycle emerges when we remove the heteroatom and see what electrophile we need. We shall use pyrroles as examples. The nitrogen forms an enamine on each side of the ring and we know that enamines are made from carbonyl compounds and amines.

➡ These arrows are the retrosynthetic arrows you met in Chapter 28.

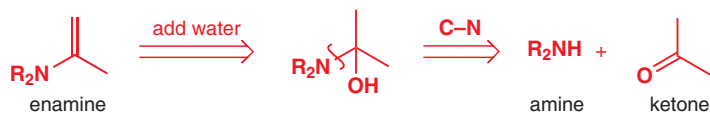

If we do the same disconnection with a pyrrole, omitting the intermediate stage, we can repeat the C–N disconnection on the other side too:

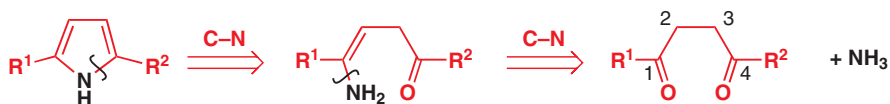

What we need is an amine—ammonia in this case—and a diketone. If the two carbonyl groups have a 1,4 relationship we will get a pyrrole out of this reaction. So hexane-2,5-dione reacts with ammonia to give a high yield of 2,5-dimethyl pyrrole. Making furans is even easier because the heteroatom (oxygen) is already there. All we have to do is to dehydrate the 1,4-diketone instead of making enamines from it. Heating with acid is enough.



Avoiding the aldol product

1,4-Diketones also self-condense rather easily in an intramolecular aldol reaction (see Chapter 26, p. 636) to give a cyclopentenone with an all-carbon five-membered ring. This too is a useful reaction but we need to know how to control it. The usual rule is:

- Base gives the cyclopentenone.
- Acid gives the furan.

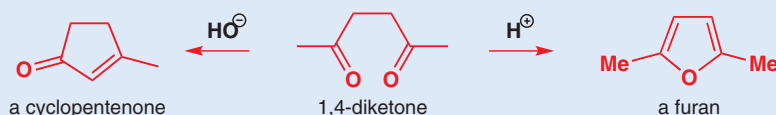

For thiophenes we could in theory use H_2S or some other sulfur nucleophile but, in practice, an electrophilic reagent is usually used to convert the two $\text{C}=\text{O}$ bonds to $\text{C}=\text{S}$ bonds. Thioketones are much less stable than ketones and cyclization is swift. Reagents such as P_2S_5 or Lawesson's reagent are the usual choice here.

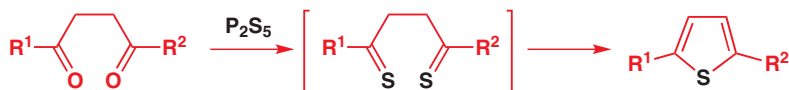

• Making five-membered heterocycles

Cyclization of 1,4-dicarbonyl compounds with nitrogen, sulfur, or oxygen nucleophiles gives the five-membered aromatic heterocycles pyrrole, thiophene, and furan.

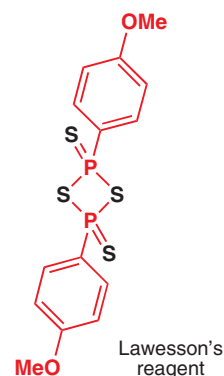

It seems a logical extension to use a 1,5-diketone to make substituted pyridines but there is a slight problem here as we will introduce only two of the required three double bonds when the two enamines are formed. To get the pyridine by enamine formation we should need a double bond somewhere in the chain between the two carbonyl groups. But here another difficulty arises—it will have to be a *cis* (*Z*) double bond or cyclization would be impossible.

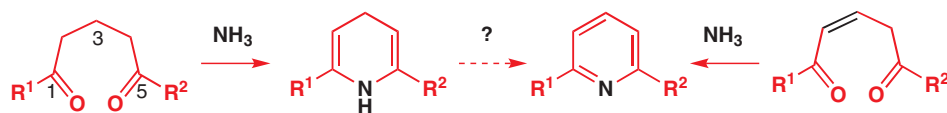

On the whole it is easier to use the saturated 1,5-diketone and oxidize the product to the pyridine. As we are going from a non-aromatic to an aromatic compound, oxidation is easy and we can replace the question mark above with almost any simple oxidizing agent, as we shall soon see.

• Making six-membered heterocycles

Cyclization of 1,5-dicarbonyl compounds with nitrogen nucleophiles leads to the six-membered aromatic heterocycle pyridine.

Heterocycles with two nitrogen atoms come from the same strategy

Reacting a 1,4-diketone with hydrazine (NH_2NH_2) makes a double enamine again and this is only an oxidation step away from a pyridazine. This is also a good synthesis.

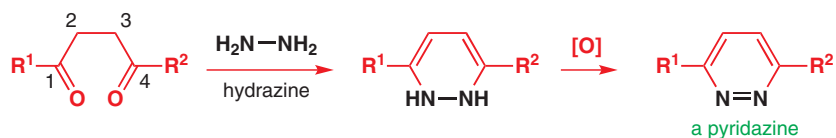

If we use a 1,3-diketone instead we will get a five-membered heterocycle and the imine and enamine formed are enough to give aromaticity without any need for oxidation. The product is a pyrazole. The two heteroatoms do not, of course, need to be joined together for this strategy to work. If an amidine is combined with the same 1,3-diketone we get a six-membered heterocycle. As the nucleophile contains one double bond already, an aromatic pyrimidine is formed directly.

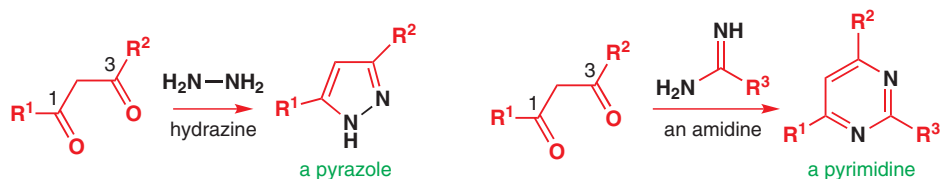

Since diketones and other dicarbonyl compounds are easily made by enolate chemistry (Chapters 25, 26, and 28) this strategy has been very popular and we will look at some detailed examples before moving on to more specialized reactions for the different classes of aromatic heterocycles.

Pyrroles, thiophenes, and furans from 1,4-dicarbonyl compounds

We need to make the point that pyrrole synthesis can be done with primary amines as well as with ammonia and a good example is the pyrrole needed for clopirac, a drug we discussed in Chapter 29. The synthesis is very easy.

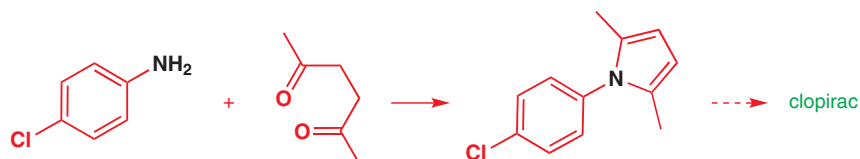

For an example of furan synthesis we choose menthofuran, which contributes to the flavour of mint. It has a second ring, but that is no problem if we simply disconnect the enol ethers as we have been doing so far.

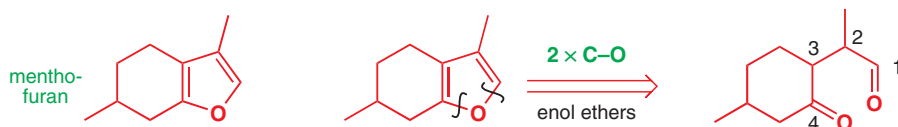

The starting material is again a 1,4-dicarbonyl compound but as there was no substituent at C1 of the furan, that atom is an aldehyde rather than a ketone. This might lead to problems in the synthesis so a few changes (using the notation you met in Chapter 28) are made to the intermediate before further disconnection.

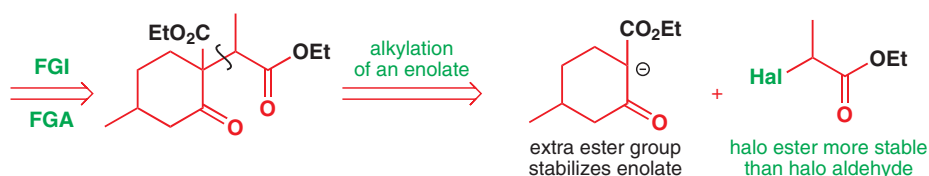

■ Halo aldehydes are unstable and should be avoided.

Notice in particular that we have ‘oxidized’ the aldehyde to an ester to make it more stable—in the synthesis reduction will be needed. Here is the alkylation step of the synthesis, which does indeed go very well with the α -iodo-ester.

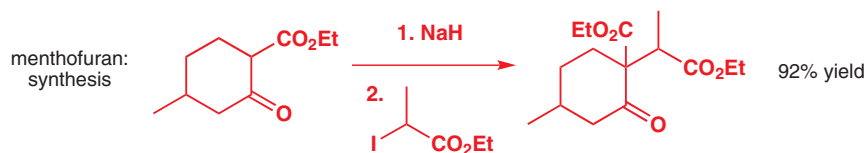

Cyclization with acid now causes a lot to happen. The 1,4-dicarbonyl compound cyclizes to a lactone, not to a furan, and the redundant ester group is lost by hydrolysis and decarboxylation. Notice that the double bond moves into conjugation with the lactone carbonyl group. Finally, the reduction gives the furan. No special precautions are necessary—as soon as the ester is partly reduced, it loses water to give the furan whose aromaticity prevents further reduction even with LiAlH_4 .

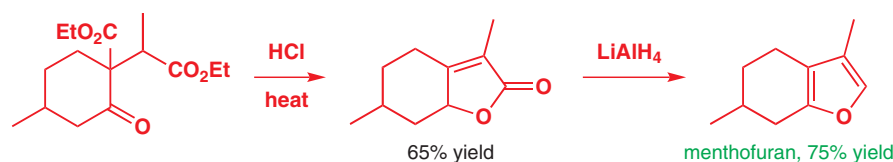

● **A reminder**

Cyclization of 1,4-dicarbonyl compounds with nitrogen, sulfur, or oxygen nucleophiles gives the five-membered aromatic heterocycles pyrrole, thiophene, and furan.

Now we need to take these ideas further and discuss an important pyrrole synthesis that follows this strategy but includes a cunning twist. It all starts with the porphyrin found in blood. In Chapter 29 we gave the structure of porphyrin and showed that it contains four pyrrole rings joined in a macrocycle. We are going to look at one of those pyrroles.

Porphyrins can be made by joining together the various pyrroles in the right order and what is needed for this one (and also, in fact, for another—the one in the north-east corner of the porphyrin) is a pyrrole with the correct substituents in positions 3 and 4, a methyl group in position 5, and a hydrogen atom at position 2. Position 2 must be free. Here is the molecule drawn somewhat more conveniently, together with the disconnection we have been using so far.

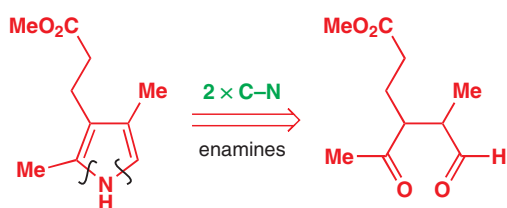

No doubt such a synthesis could be carried out but it is worth looking for alternatives for a number of reasons. We would prefer not to make a pyrrole with a free position at C2 as that would be very reactive and we know from Chapter 29 that we can reversibly block such a position with a *t*-butyl ester group. This gives us a very difficult starting material with four different carbonyl groups.

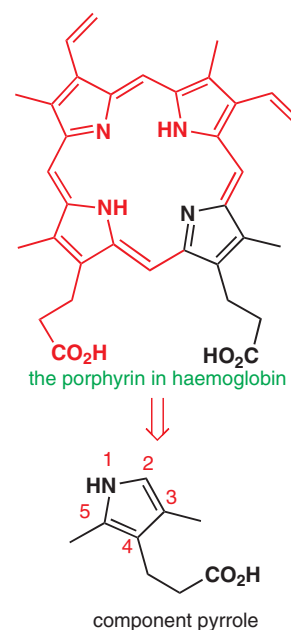
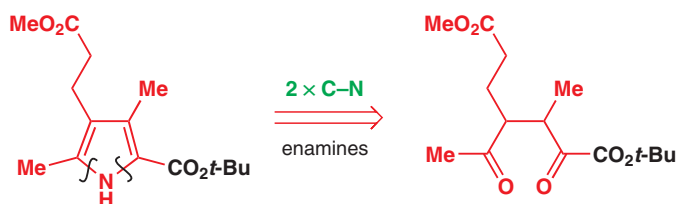

➔ See p. 733 for a discussion of how to control pyrrole's reactivity.

We have made a problem for ourselves by having two carbonyl groups next to each other. Could we escape from that by replacing one of them with an amine? We should then have an ester of an α amino acid, a much more attractive starting material, and this corresponds to disconnecting just one of the C–N bonds.

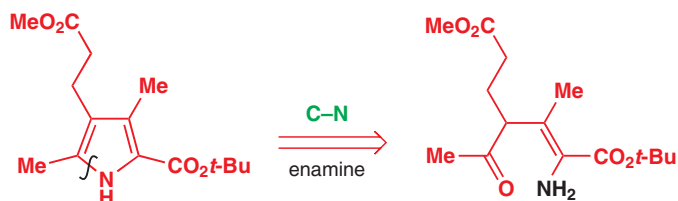

At first we seem to have made no progress but just see what happens when we move the double bond round the ring into conjugation with the ketone. After all, it doesn't matter where the double bond starts out—we will always get the aromatic product.

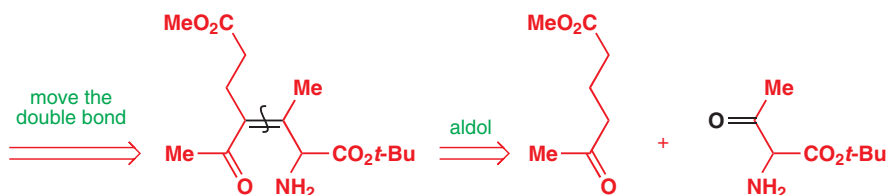

■ Conjugate additions with 1,3-dicarbonyl compounds were discussed in Chapter 26. If you have read Chapter 28 then you should be aware that such reactions are an excellent way of making 1,5-difunctionalized compounds.

Each of our two much simpler starting materials needs to be made. The keto-ester is a 1,5-dicarbonyl compound so it can be made by a conjugate addition of an enolate, a process greatly assisted by the addition of a second ester group.

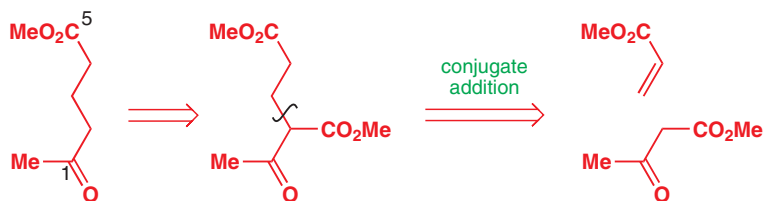

The other compound is an amino-keto-ester and will certainly react with itself if we try to prepare it as a pure compound. The answer is to release it directly into the reaction mixture and this can be done by nitrosation and reduction (Chapter 20) of another stable enolate.

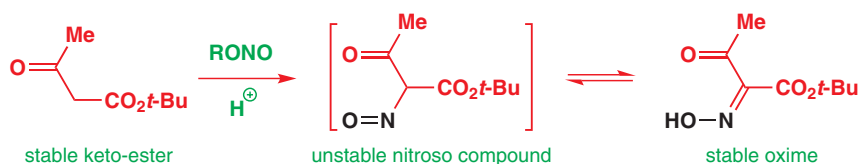

Zinc in acetic acid (Chapter 23) reduces the oxime to the amine and we can start the synthesis by doing the conjugate addition and then reducing the oxime in the presence of the keto-diester.

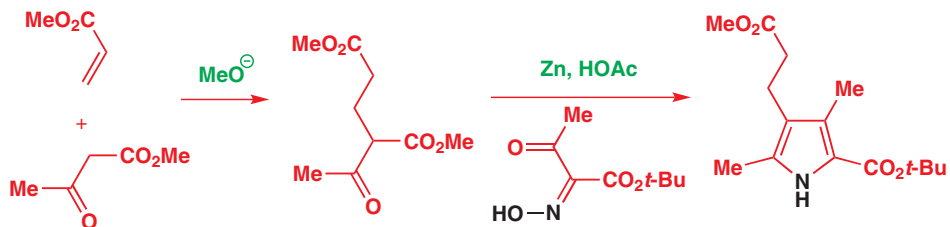

This reaction forms the required pyrrole in one step! First, the oxime is reduced to an amine, then the amino group forms an imine with the most reactive carbonyl group (the

ketone) in the ketodiester. Finally, the very easily formed enamine cyclizes onto the other ketone.

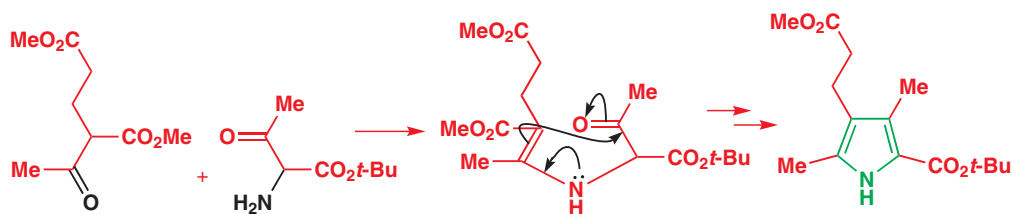

This pyrrole synthesis is important enough to be given the name of its inventor—it is the Knorr pyrrole synthesis. Knorr himself made a rather simpler pyrrole in a remarkably efficient reaction. See if you can work out what is happening here.

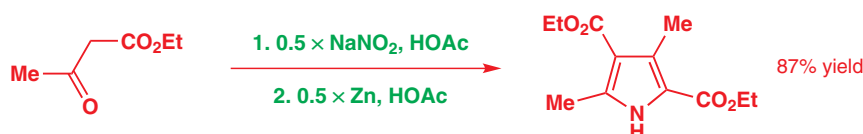

Names for heterocyclic syntheses

Standard heterocyclic syntheses tend to have a name associated with them and it is simply not worthwhile learning these names. Few chemists use any but the most famous of them: we will mention the Knorr pyrrole synthesis, the Hantzsch pyridine synthesis, and the Fischer and Reissert indole syntheses. We did not mention that the synthesis of furans from 1,4-dicarbonyl compounds is known as the Feist–Benary synthesis, and there are many more like this. If you are really interested in these other names we suggest you consult a specialist book on heterocyclic chemistry.

How to make pyridines: the Hantzsch pyridine synthesis

The idea of coupling two keto-esters together with a nitrogen atom also works for pyridines except that an extra carbon atom is needed. This is provided as an aldehyde and another important difference is that the nitrogen atom is added as a nucleophile rather than an electrophile. These are features of the **Hantzsch pyridine synthesis**. This is a four-component reaction from simple starting materials.

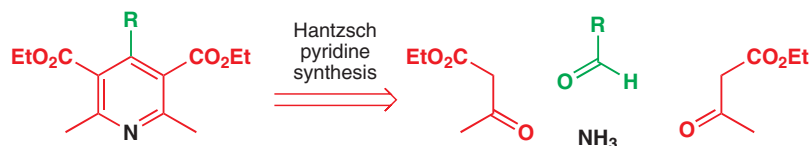

You are hardly likely to understand the rationale behind this reaction from that diagram so let's explore the details. The product of the reaction is actually the dihydropyridine, which has to be oxidized to the pyridine by a reagent such as HNO_3 , Ce(IV) , or a quinone.

The reaction is very simply carried out by mixing the components in the right proportions in ethanol. The presence of water does not spoil the reaction and the ammonia, or some added amine, ensures the slightly alkaline pH necessary. Any aldehyde can be used, even formaldehyde, and yields of the crystalline dihydropyridine are usually very good.

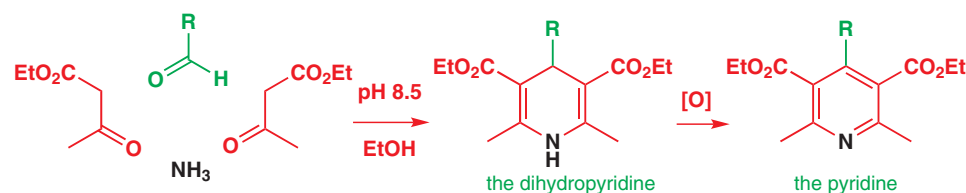

Arthur Hantzsch, 1857–1935, the 'fiery stereochemist' of Leipzig, was most famous for the work he did with Werner at the ETH in Zurich where in 1890 he suggested that oximes could exist in *cis* and *trans* forms.

This reaction is an impressive piece of molecular recognition by small molecules and writing a detailed mechanism is a bold venture. We can see that certain events have to happen, but which order they happen in is a matter of conjecture. The ammonia has to attack the ketone groups, but it would prefer to attack the more electrophilic aldehyde so this is probably not the first step. The enol or enolate of the keto-ester has to attack the aldehyde (twice!) so let us start there.

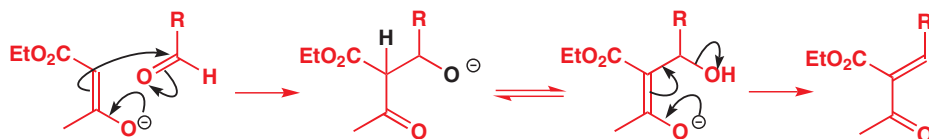

This adduct is in equilibrium with the stable enolate from the keto-ester and elimination now gives an unsaturated carbonyl compound. Such chemistry is associated with the aldol reactions we discussed in Chapter 26. The new enone has two carbonyl groups at one end of the double bond and is therefore a very good Michael acceptor (Chapter 25). A second molecule of enolate does a conjugate addition to complete the carbon skeleton of the molecule. Now the ammonia attacks either of the ketones and cyclizes on to the other. As ketones are more electrophilic than esters it is to be expected that ammonia will prefer to react there.

Interactive mechanism for Hantzsch pyridine synthesis

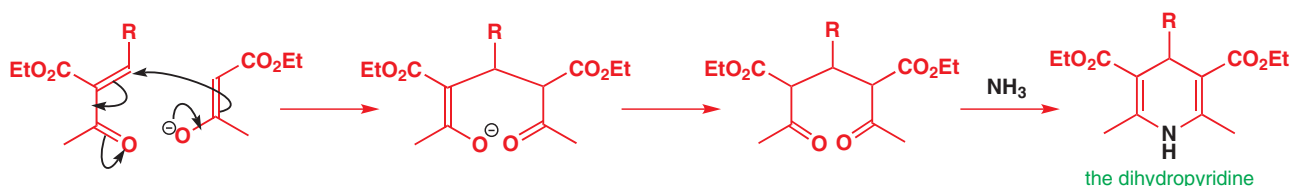

■ We will show in Chapter 42 that Nature uses related dihydropyridines as reducing agents in living things.

The necessary oxidation is easy both because the product is aromatic and because the nitrogen atom can help to expel the hydrogen atom and its pair of electrons from the 4-position. If we use a quinone as oxidizing agent, both compounds become aromatic in the same step.

Interactive mechanism for quinone oxidation of dihydropyridines

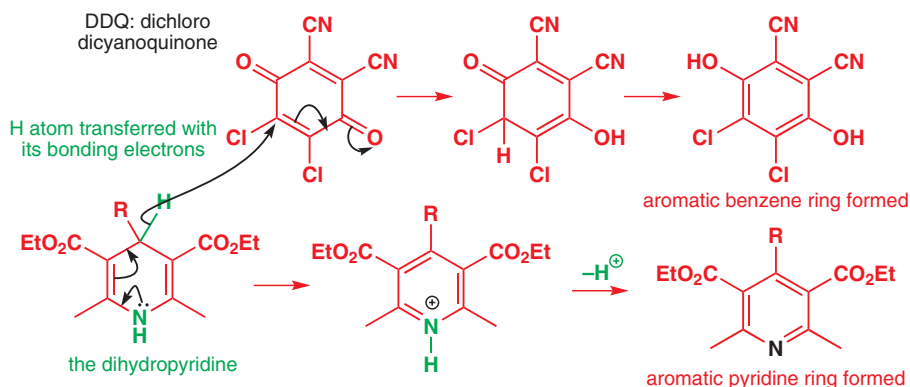

To recap this mechanism, the essentials are:

- aldol reaction between the aldehyde and the keto-ester
- Michael (conjugate) addition to the enone
- addition of ammonia to one ketone
- cyclization of the imine or enamine on to the other ketone

although several of the steps could happen in a different order.

The Hantzsch pyridine synthesis is an old discovery (1882) which sprang into prominence in the 1980s with the discovery that the dihydropyridine intermediates prepared from aromatic aldehydes are calcium channel-blocking agents and therefore valuable drugs for heart disease with useful effects on angina and hypertension.

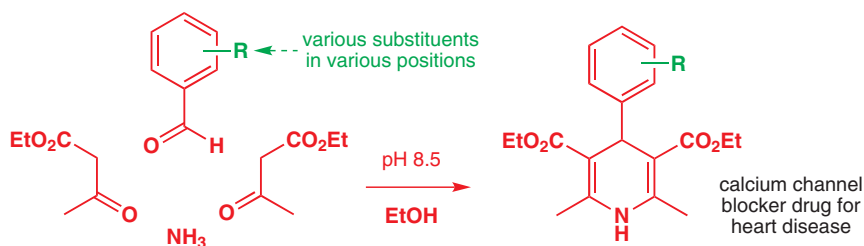

So far, so good. But it also became clear that the best drugs were unsymmetrical—some in a trivial way such as felodipine but some more seriously such as Pfizer's amlodipine. At first sight it looks as though the very simple and convenient Hantzsch synthesis cannot be used for these compounds.

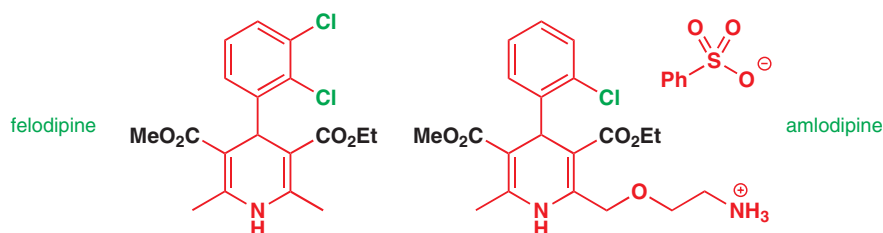

These drugs inhibit Ca²⁺ ion transport across cell membranes and relax muscle tissues selectively without affecting the working of the heart. They allow high blood pressure to be reduced. Pfizer's amlodipine (Istin™ or Norvasc™) is a very important drug.

Clearly, a modification is needed in which half of the molecule is assembled first. The solution lies in early work by Robinson, who made the very first enamines from keto-esters and amines. One half of the molecule is made from an enamine and the other half from a separately synthesized enone. We can use felodipine as a simple example.

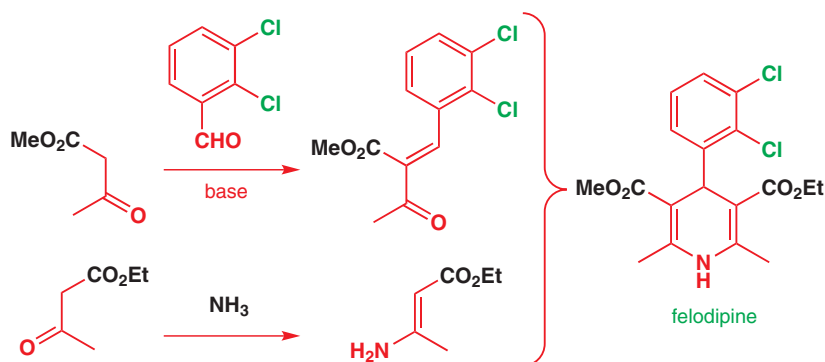

Other syntheses of pyridines

The Hantzsch synthesis produces a reduced pyridine but there are many syntheses that go directly to pyridines. One of the simplest is to use hydroxylamine (NH₂OH) instead of ammonia as the nucleophile. Reaction with a 1,5-diketone gives a dihydropyridine but then water is lost and no oxidation is needed.

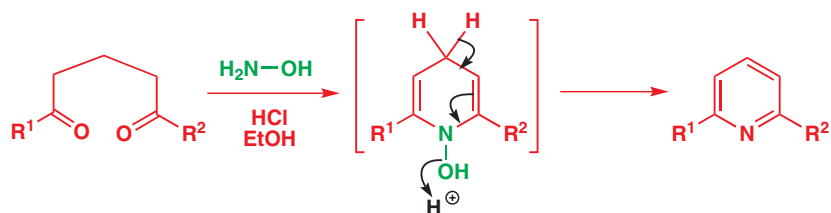

The example below shows how these 1,5-diketones may be quickly made by the Mannich (Chapter 26) and Michael (Chapter 25) reactions. Our pyridine has a phenyl substituent and a fused saturated ring. First we must disconnect to the 1,5-diketone.

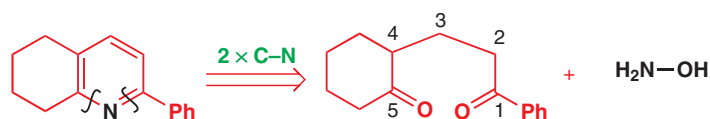

Further disconnection reveals a ketone and an enone. There is a choice here and both alternatives would work well.

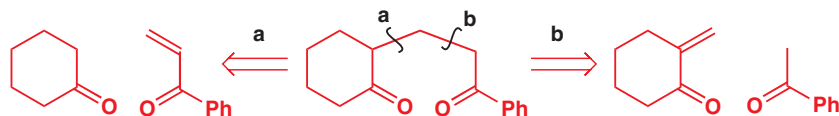

It is convenient to use the amine products of Mannich reactions ('Mannich bases') instead of the very reactive unsaturated ketones and we will continue with disconnection 'a'.

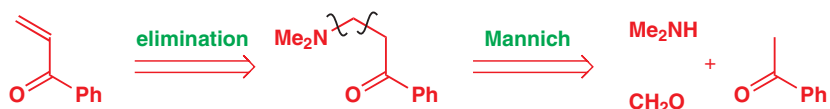

The synthesis is extraordinarily easy. The stable Mannich base is simply heated with the other ketone to give a high yield of the 1,5-diketone. Treatment of that with the HCl salt of NH_2OH in EtOH gives the pyridine directly, also in good yield.

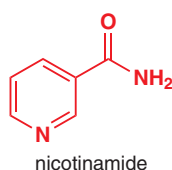
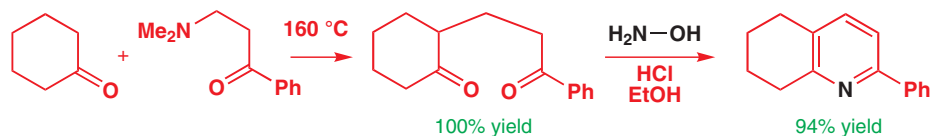

Another direct route leads, as we shall now demonstrate, to pyridones. These useful compounds are the basis for nucleophilic substitutions on the ring (Chapter 29). We choose an example that puts a nitrile in the 3-position. This is significant because the role of nicotinamide in living things (Chapter 42) makes such products interesting to make. Aldol disconnection of a 3-cyano pyridone starts us on the right path. If we now disconnect the C–N bond forming the enamine on the other side of the ring we will expose the true starting materials. This approach is unusual in that the nitrogen atom that is to be the pyridine nitrogen is not added as ammonia but is already present in a molecule of cyanoacetamide.

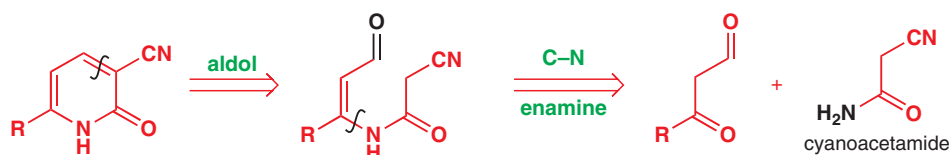

The keto-aldehyde can be made by a simple Claisen ester condensation (Chapter 26) using the enolate of the methyl ketone with ethyl formate (HCO_2Et) as the electrophile. It actually exists as a stable enol, like so many 1,3-dicarbonyl compounds (Chapter 20).

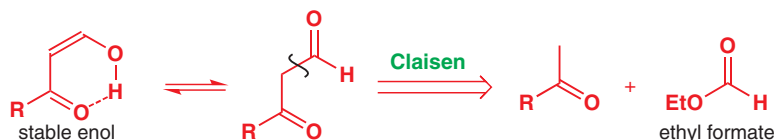

In the synthesis, the product of the Claisen ester condensation is actually the enolate anion of the keto-aldehyde and this can be combined directly without isolation with cyanoacetamide to give the pyridone in the same flask.

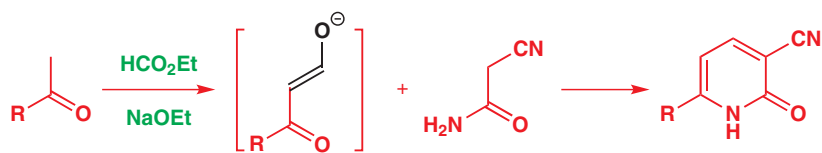

■ If dehydration occurred first, only the *Z* alkene could cyclize and the major product, the *E* alkene, would be wasted.

What happens here is that the two compounds must exchange protons (or switch enolates if you prefer) before the aldol reaction occurs. Cyclization probably occurs next through C–N bond formation and, finally, dehydration is forced to give the *Z* alkene.

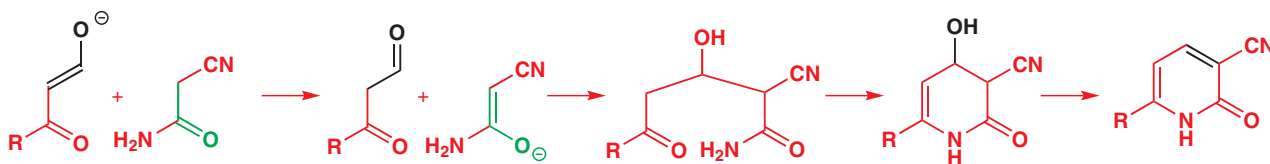

In planning the synthesis of a pyrrole or a pyridine from a dicarbonyl compound, considerable variation in oxidation state is possible. The oxidation state is chosen to make further disconnection of the carbon skeleton as easy as possible. We can now see how these same principles can be applied to pyrazoles and pyridazines.

Pyrazoles and pyridazines from hydrazine and dicarbonyl compounds

Disconnection of pyridazines reveals a molecule of hydrazine and a 1,4-diketone with the proviso that, just as with pyridines, the product will be a dihydropyridazine and oxidation will be needed to give the aromatic compound. As with pyridines, we prefer to avoid the *cis* double bond problem.

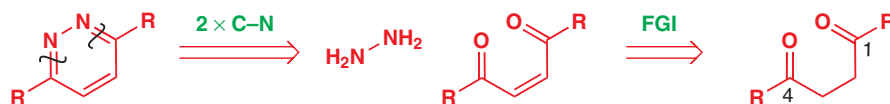

As an example we can take the cotton herbicide made by Cyanamid. Direct removal of hydrazine would require a problematic *cis* double bond in the starting material.

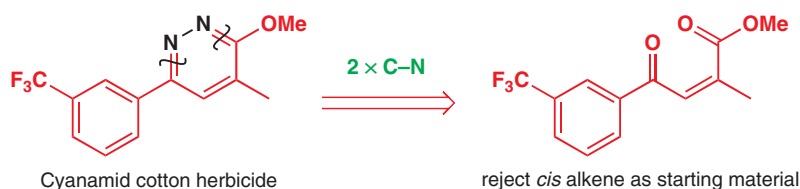

■ The herbicide kills weeds in cotton crops rather than the cotton plant itself!

If we remove the double bond first, a much simpler compound emerges. Note that this is a ketoester rather than a diketone.

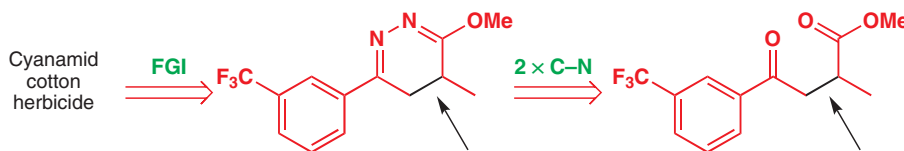

When hydrazine is added to the keto-ester an imine is formed with the ketone but acylation occurs at the ester end to give an amide rather than the imino-ester we had designed.

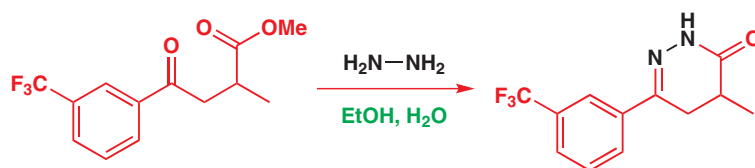

Aromatization with bromine gives the aromatic pyridazolone by bromination and dehydrobromination, and now we invoke the nucleophilic substitution reactions introduced in Chapter 29. First we make the chloride with POCl_3 and then displace with methanol.

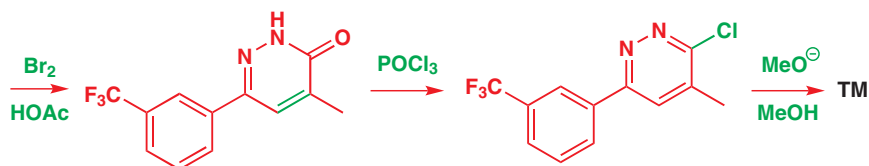

The five-membered ring pyrazoles are even simpler as the starting material is a 1,3-dicarbonyl compound available from the aldol or Claisen ester condensations.

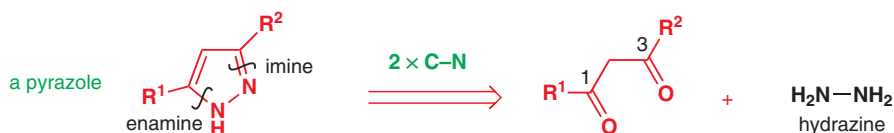

Chemistry hits the headlines—Viagra

In 1998 chemistry suddenly appeared in the media in an exceptional way. Normally not a favourite of TV or the newspapers, chemistry produced a story with all the right ingredients—sex, romance, human ingenuity—and all because of a pyrazole. In the search for a heart drug, Pfizer uncovered a compound that allowed impotent men to have active sex lives. They called it Viagra. The molecule contains a sulfonamide and a benzene ring as well as the part that interests us most—a bicyclic aromatic heterocyclic system of a pyrazole fused to a pyrimidine. We shall discuss in detail how Pfizer made this part of the molecule and just sketch in the rest. The sulfonamide can be made from the sulfonic acid that can be added to the benzene ring by electrophilic aromatic sulfonation (Chapter 21).

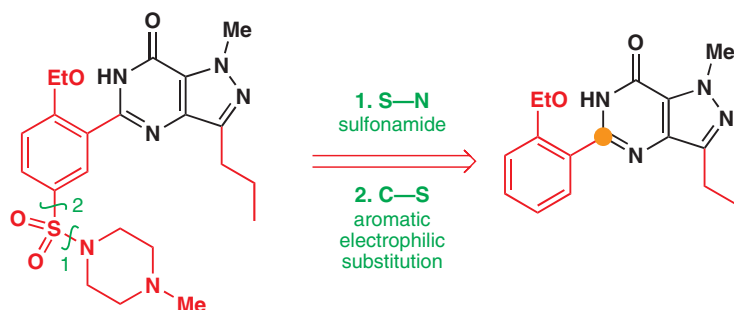
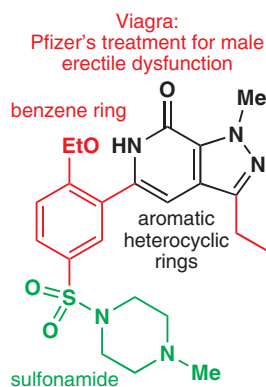

Inspection of what remains reveals that the carbon atom in the heterocycles next to the benzene ring (marked with an orange blob) is at the oxidation level of a carboxylic acid. If, therefore, we disconnect both C–N bonds to this atom we will have two much simpler starting materials.

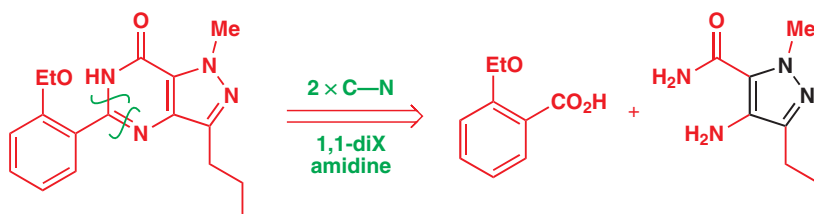

The aromatic acid is available and we need consider only the pyrazole (the core pyrazole ring in black in the diagram). The aromatic amino group can be put in by nitration and reduction, and the amide can be made from the corresponding ester. This leaves a carbon skeleton, which must be made by ring synthesis.

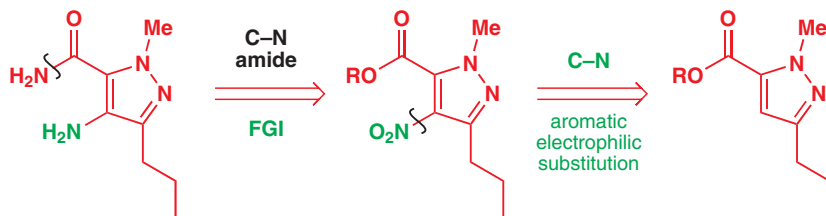

Following the methods we have established so far in this chapter, we can remove the hydrazine portion to reveal a 1,3-dicarbonyl compound. In fact, this is a tricarbonyl compound, a diketo-ester, because of the ester already present and it contains 1,2-, 1,3-, and 1,4-dicarbonyl relationships. The simplest synthesis is by a Claisen ester condensation and we choose the disconnection so that the electrophile is a reactive (oxalate) diester that cannot enolize. The only control needed will then be in the enolization of the ketone.

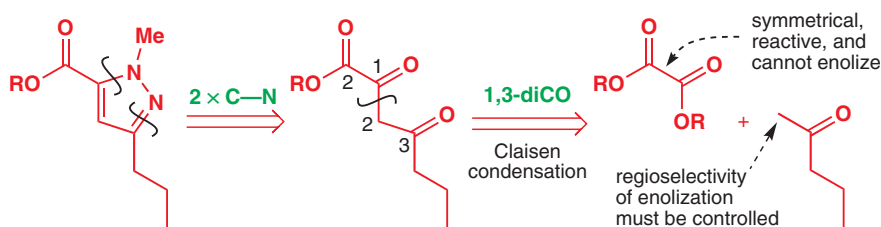

The Claisen ester condensation gives the right product just by treatment with base. The reasons for this are discussed in Chapter 26. We had then planned to treat the keto-diester with methylhydrazine but there is a doubt about the regioselectivity of this reaction—the ketones are more electrophilic than the ester all right, but which ketone will be attacked by which nitrogen atom?

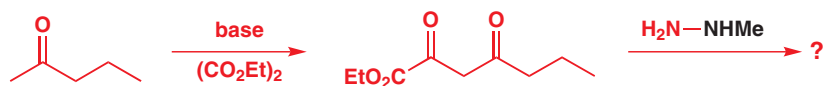

We have already seen the solution to this problem in Chapter 29. If we use symmetrical hydrazine, we can deal with the selectivity problem by alkylation. Dimethyl sulfate turns out to be the best reagent.

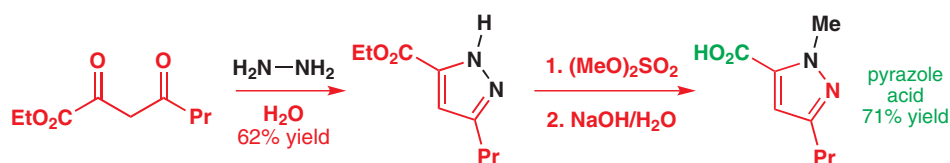

The stable pyrazole acid from the hydrolysis of this ester is a key intermediate in Viagra production. Nitration can occur only at the one remaining free position and then amide formation and reduction complete the synthesis of the amino pyrazole amide ready for assembly into Viagra.

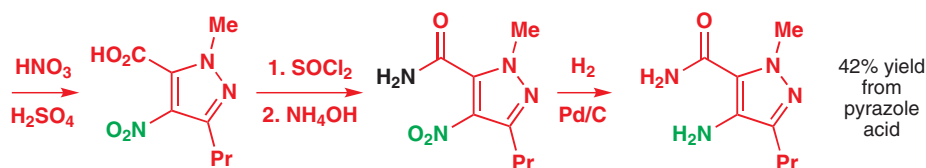

■ The alkylation is regioselective because the methylated nitrogen must become the pyrrole-like nitrogen atom and the molecule prefers the longest conjugated system involving that nitrogen and the ester.

lone pair delocalized into ester carbonyl group

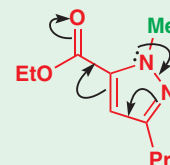

The rest of the synthesis can be summarized very briefly as it mostly concerns material outside the scope of this chapter. You might like to notice how easy the construction of the second heterocyclic ring is—the nucleophilic attack of the nitrogen atom of one amide on to the carbonyl of another would surely not occur unless the product were an aromatic heterocycle.

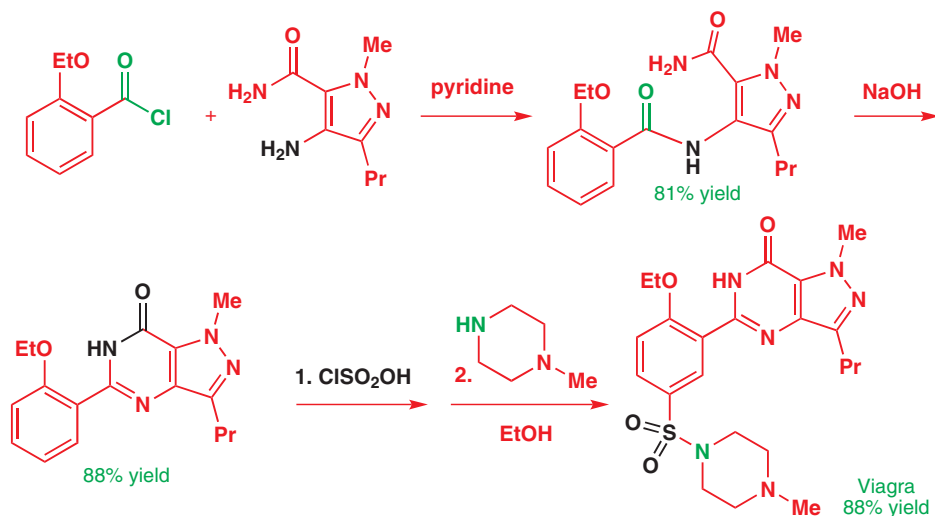

Pyrimidines can be made from 1,3-dicarbonyl compounds and amidines

In Chapter 29 we met some compounds that interfere in folic acid metabolism and are used as antibacterial agents. One of them was trimethoprim and it contains a pyrimidine ring (black on the diagram). We are going to look at its synthesis briefly because the strategy used is the opposite of that used with the pyrimidine ring in Viagra. Here we disconnect a molecule of guanidine from a 1,3-dicarbonyl compound.

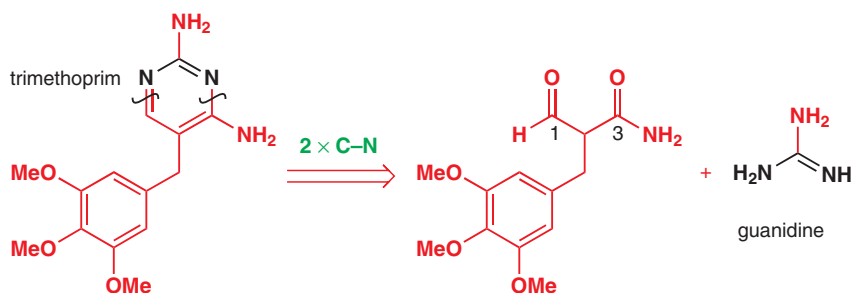

The 1,3-dicarbonyl compound is a combination of an aldehyde and an amide but is very similar to a malonic ester so we might think of making this compound by alkylation of that stable enolate (Chapter 25) with the convenient benzylic bromide.

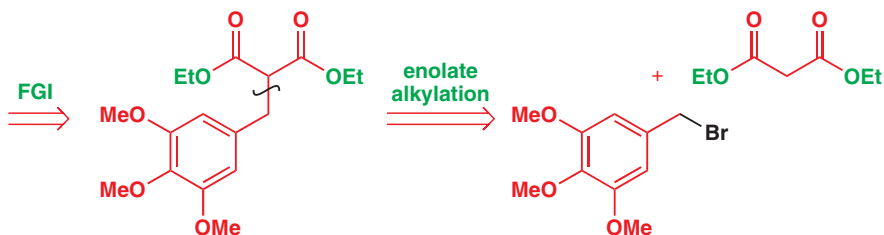

The alkylation works fine but it turns out to be better to add the aldehyde as an electrophile (cf. the pyridone synthesis on p. 766) rather than try to reduce an ester to an aldehyde. The other ester is already at the right oxidation level.

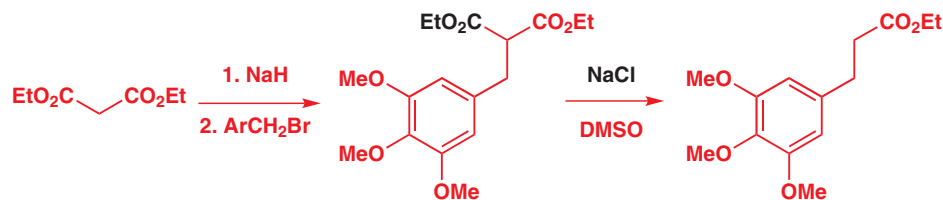

■ Notice the use of the NaCl method of decarboxylation (Chapter 25, p. 597).

Condensation with ethyl formate (HCO₂Et) and cyclization with guanidine gives the pyrimidine ring system but with an OH instead of the required amino group. Aromatic nucleophilic substitution the pyridone style from Chapter 29 gives trimethoprim.

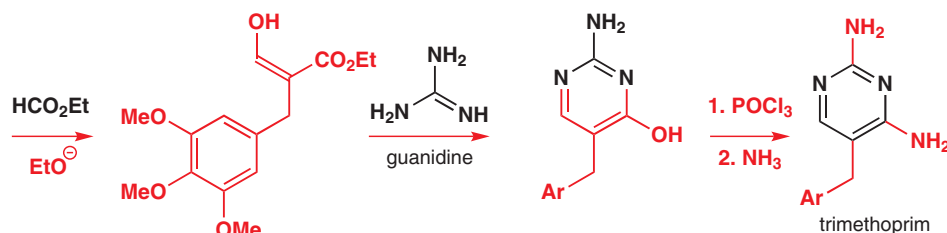

Unsymmetrical nucleophiles lead to selectivity questions

The synthesis of thiazoles is particularly interesting because of a regioselectivity problem. If we try out the two strategies we have just used for pyrimidines, the first requires the reaction of a carboxylic acid derivative with a most peculiar enamine that is also a thioenol. This does not look like a stable compound.

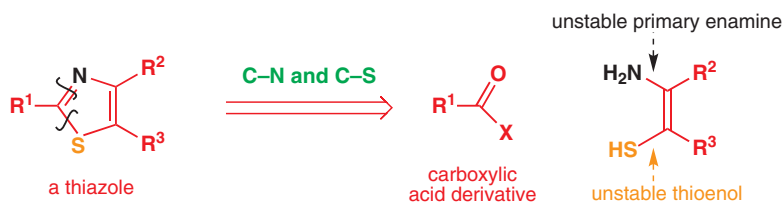

The alternative is to disconnect the C–N and C–S bonds on the other side of the heteroatoms. Here we must be careful what we are about or we will get the oxidation state wrong. We shall do it step by step to make sure. We can rehydrate the double bond in two ways. We can first try putting the OH group next to nitrogen.

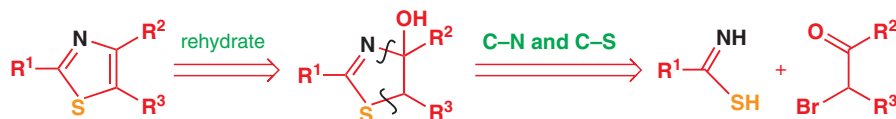

Or we can rehydrate it the other way round, putting the OH group next to the sulfur atom, and disconnect in the same way. In both cases we require an electrophilic carbon atom at the alcohol oxidation level and one at the aldehyde or ketone oxidation level. In other words we need an α -haloketone.

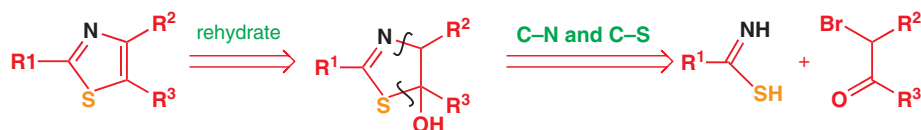

➔ The structure of Lawesson's reagent is on p. 759.

The nucleophile is the same in both cases and it is an odd-looking molecule. That is, until we realize that it is just a tautomer of a thioamide. Far from being odd, thioamides are among the few stable thiocarbonyl derivatives and can be easily made from ordinary amides with P_2S_5 or Lawesson's reagent.

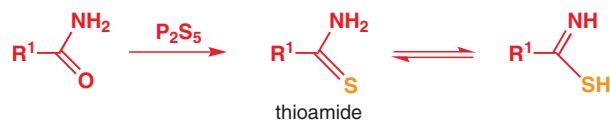

So the only remaining question is: when thioamides combine with α -haloketones, which nucleophilic atom (N or S) attacks the ketone, and which atom (N or S) attacks the alkyl halide? Carbonyl groups are 'hard' electrophiles—their reactions are mainly under charge control and so they react best with basic nucleophiles (Chapter 10). Alkyl halides are 'soft' electrophiles—their reactions are mainly under frontier orbital control and they react best with large uncharged nucleophiles from the lower rows of the periodic table. The ketone reacts with nitrogen and the alkyl halide with sulfur.

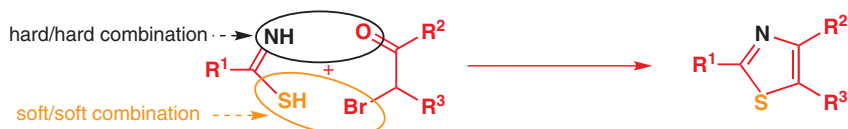

Fentiazac, a non-steroidal anti-inflammatory drug, is a simple example. Disconnection shows that we need thiobenzamide and an easily made α -haloketone (easily made because the ketone can enolize on this side only—see Chapter 20).

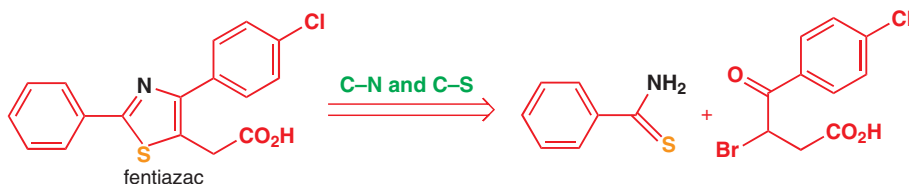

The synthesis involves heating these two compounds together and the correct thiazole forms easily with the double bonds finding their right positions in the product—the only positions for a stable aromatic heterocycle.

■ We will cover cycloadditions in detail in Chapter 34—in fact you have met an example already in the last chapter: the Diels–Alder reaction (p. 739) is also a cycloaddition. The cycloadditions here involve a 1,3-dipole and form a five-membered ring, by a cyclic mechanism involving six electrons.

Isoxazoles are made from hydroxylamine or by cycloaddition

The two main routes for the synthesis of isoxazoles are (a) the attack of hydroxylamine (NH_2OH) on diketones and (b) a reaction of nitrile oxides called a 1,3-dipolar cycloaddition. They thus form a link between the strategy we have been discussing (cyclization of a nucleophile with two heteroatoms and a compound with two electrophilic carbon atoms) and the next strategy—cycloaddition reactions.

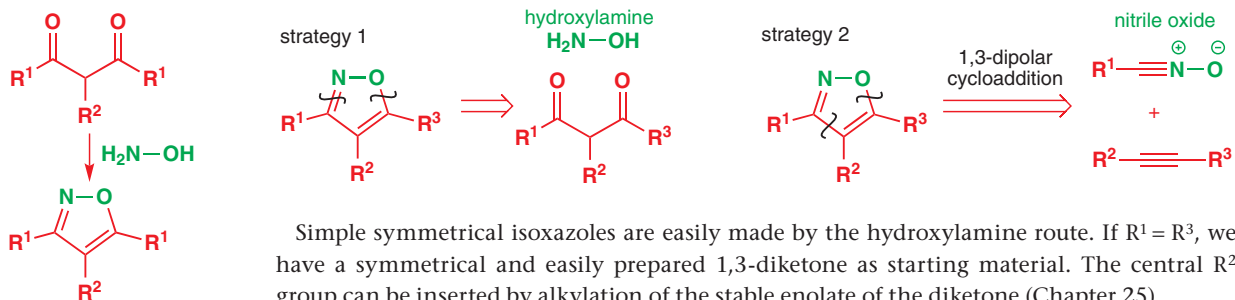

Simple symmetrical isoxazoles are easily made by the hydroxylamine route. If $R^1 = R^3$, we have a symmetrical and easily prepared 1,3-diketone as starting material. The central R^2 group can be inserted by alkylation of the stable enolate of the diketone (Chapter 25).

When $R^1 \neq R^3$, we have an unsymmetrical dicarbonyl compound and we must be sure that we know which way round the reaction will proceed. The more nucleophilic end of NH_2OH will attack the more electrophilic carbonyl group. It seems obvious that the more nucleophilic end of NH_2OH will be the nitrogen atom but that depends on the pH of the solution. Normally, hydroxylamine is supplied as the crystalline hydrochloride salt and a base of some kind added to give the nucleophile. The relevant $\text{p}K_a$ s are shown in the margin. Bases such as pyridine or sodium acetate produce some of the reactive neutral NH_2OH in the presence of the less reactive cation, but bases such as NaOEt produce the anion. Reactions of keto-aldehydes with acetate-buffered hydroxylamine usually give the isoxazole from nitrogen attack on the aldehyde as expected.

state of hydroxylamine changes with pH: the more nucleophilic atom is marked in black

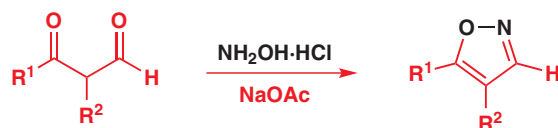
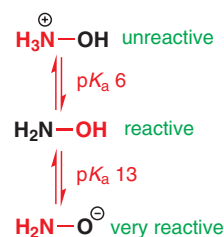

Modification of the electrophile may also be successful. Reaction of hydroxylamine with 1,2,4-diketo-esters usually gives the isoxazole from attack of nitrogen at the more reactive keto group next to the ester.

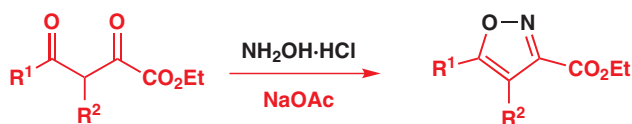

A clear demonstration of selectivity comes from the reactions of bromoenones. It is not immediately clear which end of the electrophile is more reactive but the reactions tell us the answer.

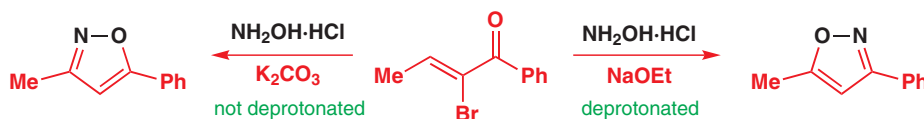

The alternative approach to isoxazoles relies on the reaction of nitrile oxides with alkynes. We shall see in Chapter 34 that there are two good routes to these reactive compounds, the γ -elimination of chlorooximes or the dehydration of nitroalkanes.

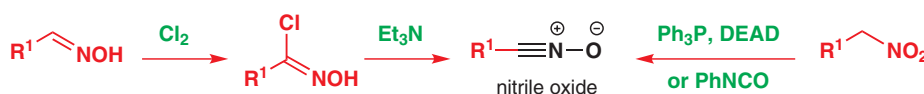

Interactive mechanism for nitrile oxide formation

A few nitrile oxides are stable enough to be isolated (those with electron-withdrawing or highly conjugating substituents, for example) but most are prepared in the presence of the alkyne by one of these methods because otherwise they dimerize rapidly. Both methods of forming nitrile oxides are compatible with their rapid reactions with alkynes. With aryl alkynes the reaction is usually clean and regioselective.

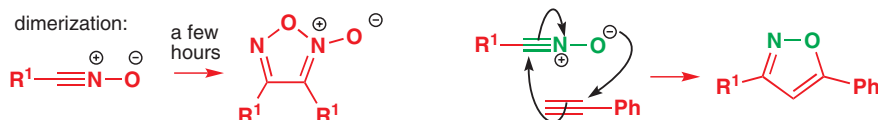

Interactive mechanism for nitrile oxide cycloaddition

The reaction forms the five-membered ring in a single step: it is a cycloaddition, in which the alkyne is using its HOMO to attack the LUMO of the nitrile oxide (see Chapter 34 for an explanation). If the alkyne has an electron-withdrawing group, mixtures of isomers are usually formed as the HOMO of the nitrile oxide also attacks the LUMO of the alkyne. Intramolecular reactions are usually clean regardless of the preferred electronic orientation if

the tether is too short to allow any cyclization except one. In this example, even the more favourable orientation looks very bad because of the linear nature of the reacting species, but only one isomer is formed.

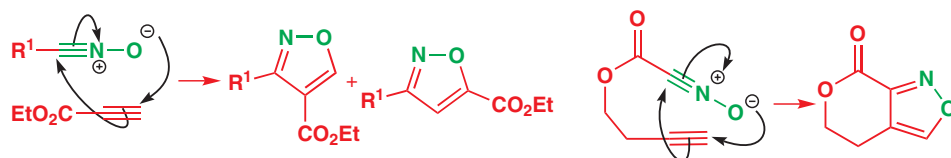

Tetrazoles and triazoles are also made by cycloadditions

Disconnection of tetrazoles with a 1,3-dipolar cycloaddition in mind is easy to see once we realize that a nitrile (RCN) is going to be one of the components. It can be done in two ways: disconnection of the neutral compound would require the dangerous hydrazoic acid (HN₃) as the dipole but the anion disconnects directly to azide ion.



Unpromising though this reaction may look, it actually works well if an ammonium chloride-buffered mixture of sodium azide and the nitrile is heated in DMF. The reagent is really ammonium azide and the reaction occurs faster with electron-withdrawing substituents in R. In the reaction mixture, the anion of the tetrazole is formed but neutralization with acid gives the free tetrazole.

■ You saw in Chapter 29 that tetrazoles are about as acidic as carboxylic acids.

Interactive mechanism for tetrazole formation

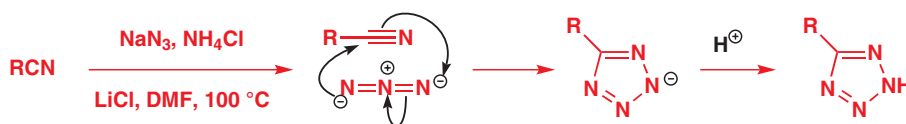

As nitriles are generally readily available this is the main route to simple tetrazoles. More complicated ones are made by alkylation of the product of a cycloaddition. The tetrazole substitute for indomethacin that we mentioned in Chapter 29 is made by this approach. First, the nitrile is prepared from the indole. The 1,3-dipolar cycloaddition works well by the azide route we have just discussed, even though this nitrile will form an 'enol' rather easily. Finally, the indole nitrogen atom must be acylated. The tetrazole is more acidic so it is necessary to form a dianion to get reaction at the right place. The usual rule is followed (see Chapter 23)—the second anion formed is less stable and so it reacts first.

➔ The synthesis of indoles with this substitution pattern by the Fischer indole synthesis is described on p. 777.

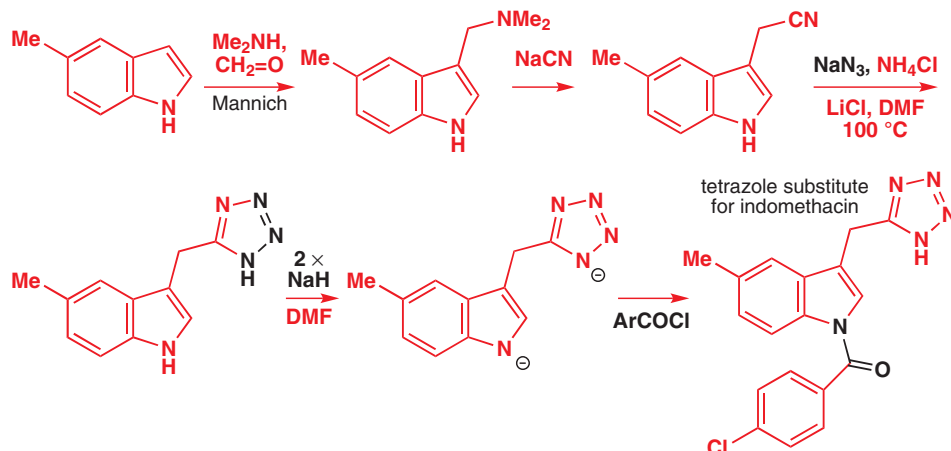

The synthesis of the anti-inflammatory drug broperamole illustrates modification of a tetrazole using its anion. The tetrazole is again constructed from the nitrile—it's an aromatic nitrile with an electron-withdrawing substituent so this will be a good reaction.

Conjugate addition to acrylic acid (Chapter 22) occurs to give the other tautomer to the one we have drawn. The anion intermediate is, of course, delocalized and can react at any of the nitrogen atoms. Amide formation completes the synthesis of broperamole.

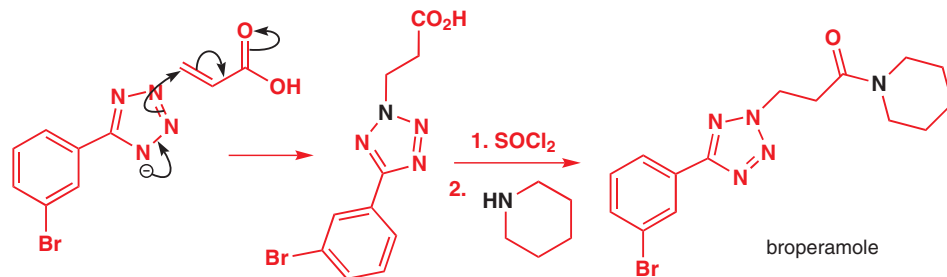

One of the best reactions of all is the related cycloaddition of a substituted azide to an alkyne. Just mixing together and heating an azide and an alkyne will give a triazole, but often as a mixture of two regioisomers.

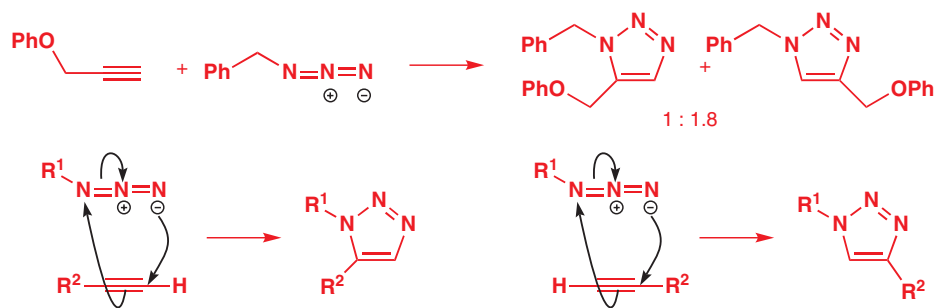

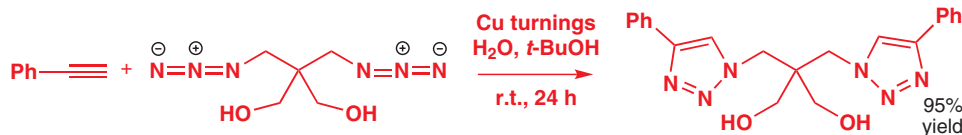

However, a simple addition to the reaction mixture improves the situation hugely: a catalytic amount of Cu(I), often made *in situ* by adding CuSO₄ and a mild reducing agent, makes the reaction much faster and gives the 1,4-disubstituted triazole selectively. The work of Sharpless has turned this reaction into not only a very powerful way of making triazoles, but also a very simple way of linking two otherwise relatively unreactive molecules together—the reaction even works in water.

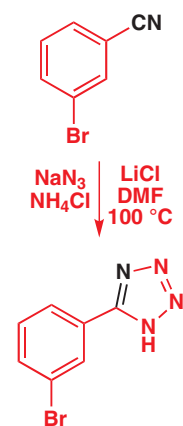
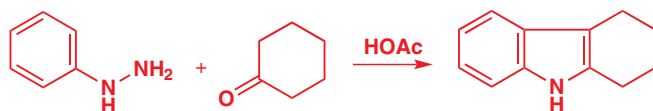

The Fischer indole synthesis

You are about to see one of the great inventions of organic chemistry. It is a remarkable reaction, amazing in its mechanism, and it was discovered in 1883 by one of the greatest organic chemists of all, Emil Fischer. Fischer had earlier discovered phenylhydrazine (PhNHNH₂) and, in its simplest form, the Fischer indole synthesis occurs when phenylhydrazine is heated in acidic solution with an aldehyde or ketone.



 Interactive mechanism for triazole formation

■ 1,2,4-Triazoles are usually made from the reaction of the unsubstituted 1,2,4-triazole anion with electrophiles, as described in Chapter 29.

■ It may look as though the more nucleophilic end of the azide has attacked the wrong end of the alkyne but you will see in Chapter 34 that (1) it is very difficult to predict which is the more nucleophilic end of a 1,3-dipole and (2) it may be either HOMO (dipole) and LUMO (alkyne), or LUMO (dipole) and HOMO (alkyne) that dominate the reaction.

Emil Fischer (1852–1919), discovered phenylhydrazine as a PhD student in 1875, succeeded Hofmann at Berlin in 1900 where he built the then largest chemical institute in the world, and was awarded the Nobel prize in 1902. As well as his work on indoles, he laid the foundations of carbohydrate chemistry by completing the structure and synthesis of the main sugars. If only he hadn't also invented Fischer projections.

■ This step is a [3,3]-sigmatropic rearrangement, as you will discover in Chapter 35: the new single bond (C–C) bears a 3,3 relationship to the old single bond (N–N).

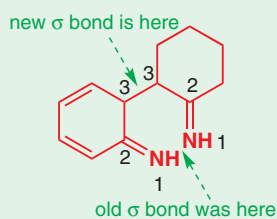

Interactive mechanism for Fischer indole synthesis

The first step in the mechanism is formation of the phenylhydrazone (the imine) of the ketone. This can be isolated as a stable compound (Chapter 11).

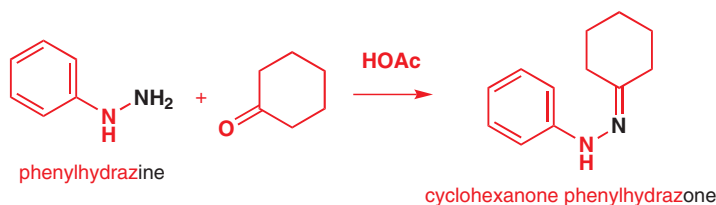

The hydrazone then needs to tautomerize to the enamine, and now comes the key step in the reaction. The enamine can rearrange with formation of a strong C–C bond and cleavage of the weak N–N single bond by moving electrons round a six-membered ring.

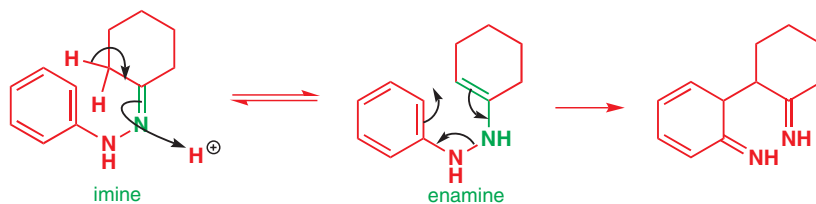

Next, re-aromatization of the benzene ring (by proton transfer from carbon to nitrogen) creates an aromatic amine that immediately attacks the other imine. This gives an aminal, the nitrogen equivalent of an acetal.

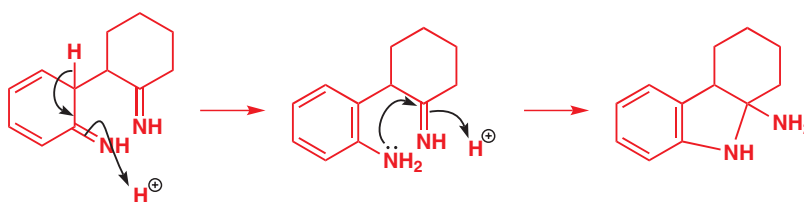

Finally, acid-catalysed decomposition of the aminal in acetal fashion with expulsion of ammonia allows the loss of a proton and the formation of the aromatic indole.

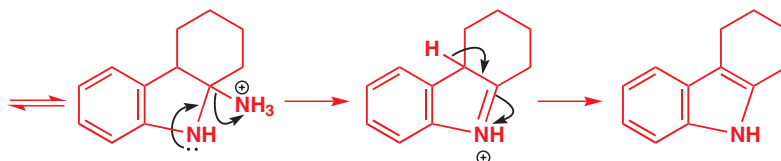

This is admittedly a complicated mechanism but if you remember the central step—the rearrangement of the enamine—the rest should fall into place. The key point is that the C–C bond is established at the expense of a weak N–N bond. Naturally, Fischer had no idea of any of the steps in the mechanism. He was sharp enough to see that something remarkable had happened and skilful enough to find out what it was.

The Fischer method is the main way of making indoles, but it is not suitable for them all. We need now to consider its applicability to various substitution patterns. If the carbonyl compound can enolize on one side only, as is the case with an aldehyde, then the obvious product is formed.

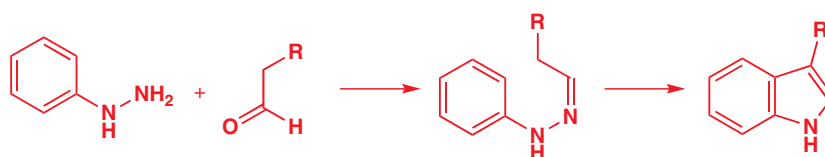

If the benzene ring has only one *ortho* position, then again cyclization must occur to that position. Other substituents on the ring are irrelevant.

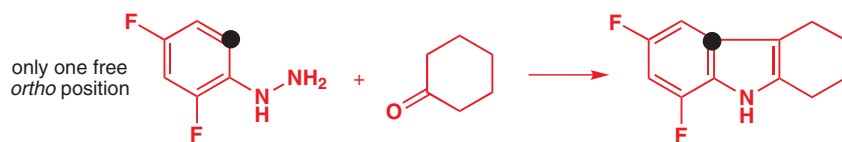

■ At this point we shall stop drawing the intermediate phenylhydrazone.

Another way to secure a single indole as product from the Fischer indole synthesis is to make sure the reagents are symmetrical. These two examples should make plain the types of indole available from symmetrical starting materials.

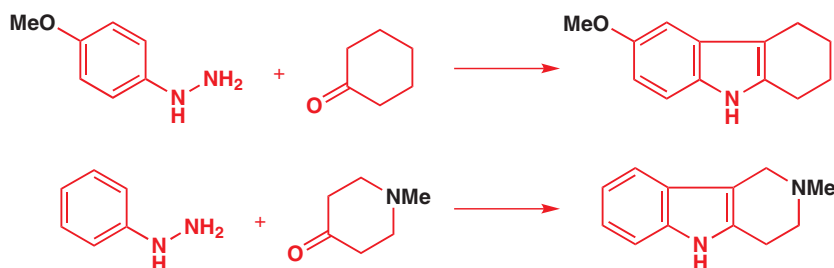

The substitution pattern of the first example is particularly important as the neurotransmitter serotonin is an indole with a hydroxyl group in the 5-position, and many important drugs follow that pattern. Sumatriptan (marketed as Imigran, the migraine treatment) is an analogue of serotonin, whose synthesis starts with the formation of a diazonium salt (Chapter 22) from the aniline shown below. Nitrosation gives the diazonium salt, and reduction with SnCl_2 and HCl returns the salt of the phenylhydrazine.

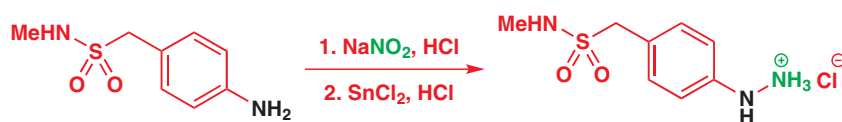
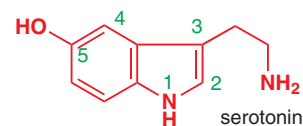

The required aldehyde (3-cyanopropanal) is added as an acetal to prevent self-condensation. The acidic conditions release the aldehyde, which forms the phenylhydrazone, ready for the next step.

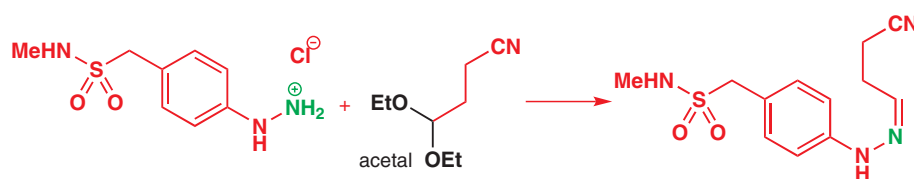

The Fischer indole synthesis itself is catalysed in this case by polyphosphoric acid (PPA), a sticky gum based on phosphoric acid (H_3PO_4) but dehydrated so that it contains some oligomers. It is often used as a catalyst in organic reactions and residues are easily removed in water.

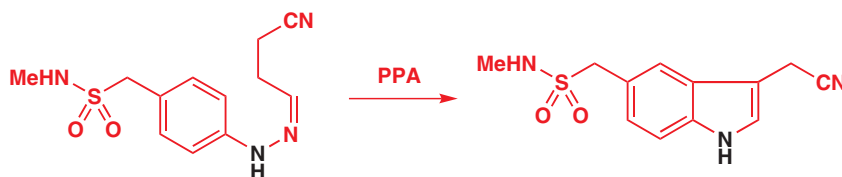

All that remains is to introduce the dimethylamino group. The nitrile is reduced by hydrogenation and the two methyl groups added by reductive amination with formaldehyde. The reducing agent is formic acid, and the reaction works by sequential formation

■ The dimethylation of primary amines (or methylation of secondary amines) by this method is sometimes called the Eschweiler–Clarke method, and was also mentioned in Chapter 28, p. 716.

and reduction of an imine, followed by an iminium formation and reduction to introduce the second methyl group.

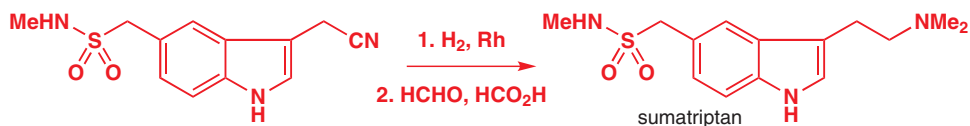

For some indoles it is necessary to control regioselectivity with unsymmetrical carbonyl compounds. Ondansetron, the anti-nausea compound that is used to help cancer patients take larger doses of antitumour compounds than was previously possible, is an example. It contains an indole and an imidazole ring.

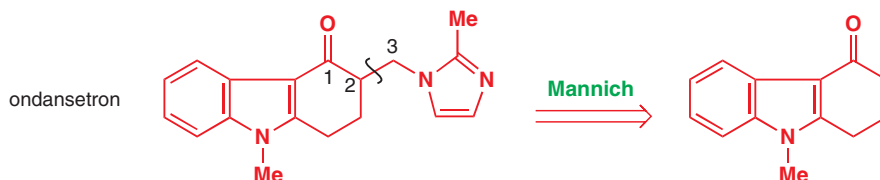

The 1,3 relationship between C–N and C–O suggests a Mannich reaction to add the imidazole ring (Chapters 26 and 28), and that disconnection reveals an indole with an unsymmetrical right-hand side, having an extra ketone group. Fischer disconnection will reveal a diketone as partner for phenylhydrazine. We shall leave aside for the moment when to add the methyl group to the indole nitrogen.

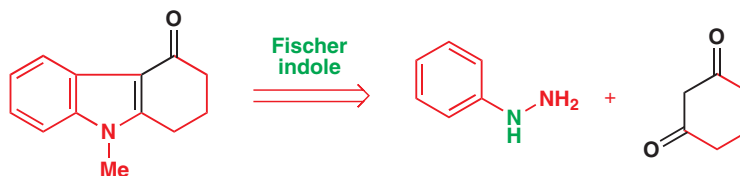

The diketone has two identical carbonyl groups and will enolize (or form an enamine) exclusively towards the other ketone. The phenylhydrazone therefore forms only the enamine we want.

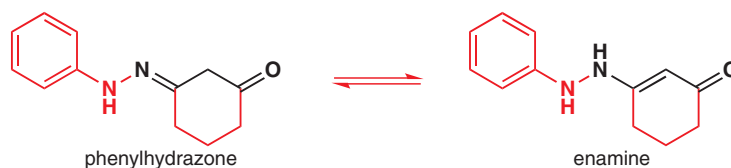

In this case, the Fischer indole reaction was catalysed by a Lewis acid, ZnCl_2 , and base-catalysed methylation followed. The final stages are summarized below.

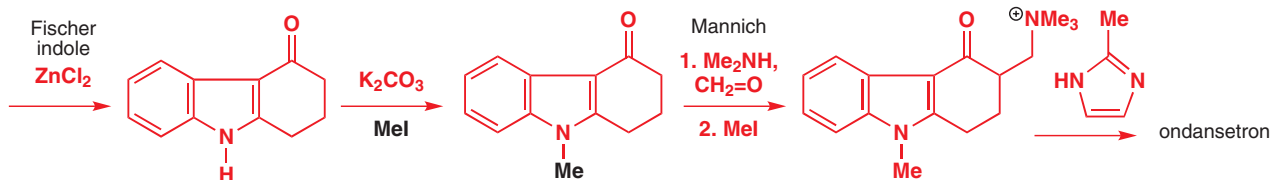

In the worst case, there is no such simple distinction between the two sites for enamine formation and we must rely on other methods of control. The non-steroidal anti-inflammatory drug indomethacin is a good example. Removing the *N*-acyl group reveals an indole with substituents in both halves of the molecule.

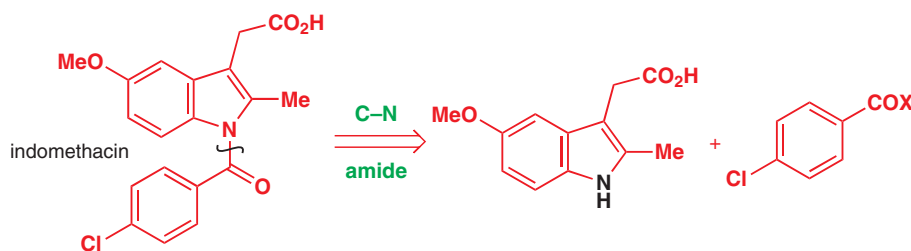

The benzene ring portion is symmetrical and is ideal for the Fischer synthesis but the right-hand half must come from an unsymmetrical open-chain keto-acid. Is it possible to control such a synthesis?

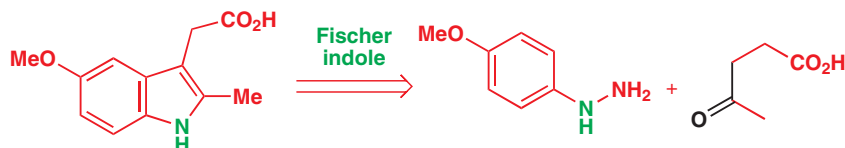

The Fischer indole is acid-catalysed so we must ask: on what side of the ketone is enolization (and therefore enamine formation) expected in acid solution? The answer (see Chapter 20) is away from the methyl group and into the alkyl chain. This is what we want and the reaction does indeed go this way. In fact, the *tert*-butyl ester is used instead of the free acid.

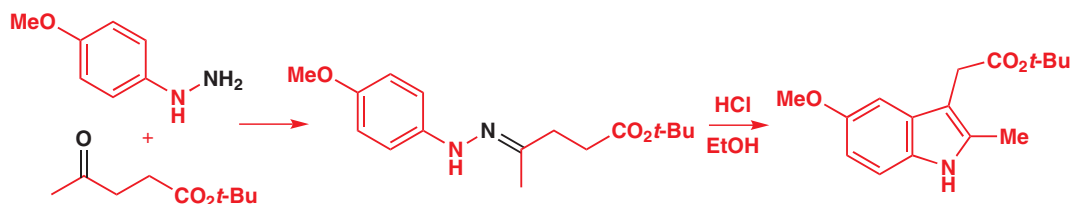

Acylation at the indole nitrogen atom is achieved with acid chloride in base and removal of the *t*-butyl ester gives free indomethacin.

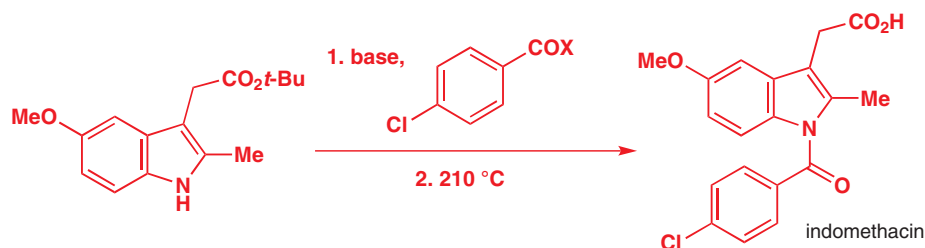

There are many other indole syntheses but we will give a brief mention to only one other, which allows the synthesis of indoles with a different substitution pattern in the benzene ring. If you like names, you may call it the Reissert synthesis, and this is the basic reaction.

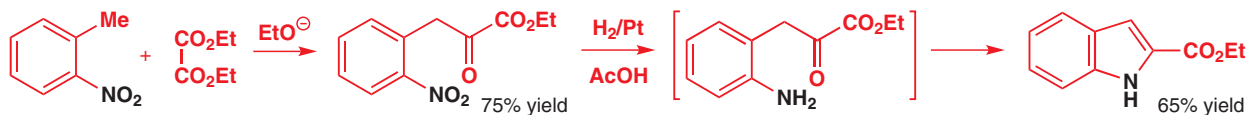

Ethoxide is a strong enough base to remove a proton from the methyl group, delocalizing the negative charge into the nitro group. The anion then attacks the reactive diester (diethyl oxalate) and is acylated by it.

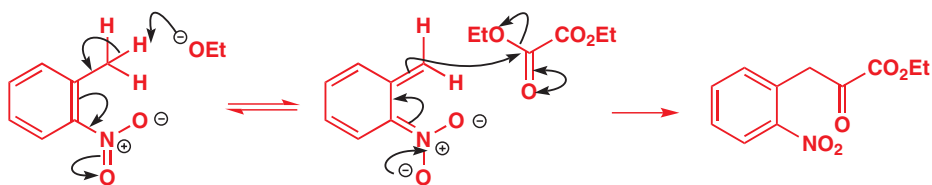

Fischer vs Reissert

We can contrast the types of indole made by the Fischer and Reissert syntheses by the different ideal positions for substituents. These are, of course, not the only possible substitution patterns.

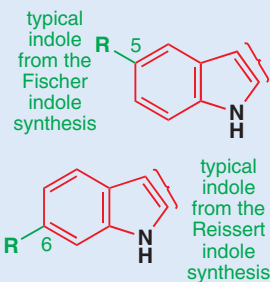

The rest of the synthesis is more straightforward: the nitro group can be reduced to an amine, which immediately forms an enamine by intramolecular attack on the more reactive carbonyl group (the ketone) to give the aromatic indole. Since the nitro compound is made by nitration of a benzene ring, the preferred symmetry is very different from that needed for the Fischer synthesis. Nitration of *para*-xylene (1,4-dimethylbenzene) is a good example.

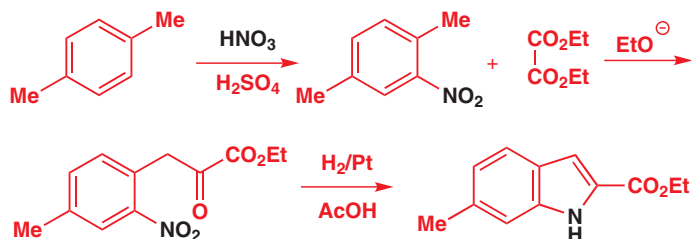

The ester products we have been using so far can be hydrolysed and decarboxylated by the mechanism described in the last chapter if a free indole is required. In any case, it is not necessary to use diethyl oxalate as the electrophilic carbonyl compound. The synthesis below, using the acetal of DMF as the electrophile, forms part of the synthesis of the strange antibiotic chuangxinmycin.

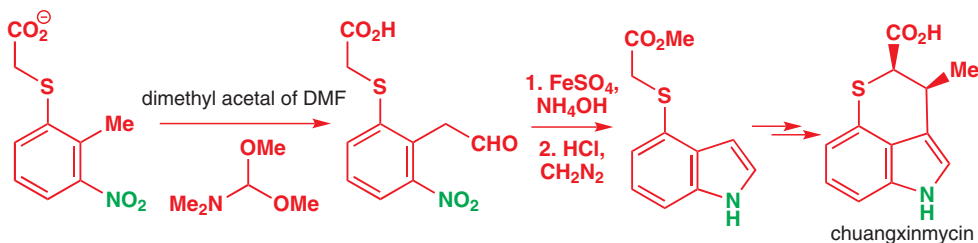

Quinolines and isoquinolines

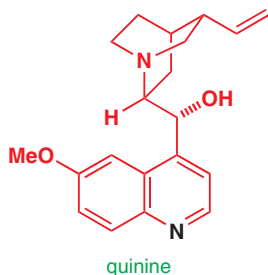

Quinoline forms part of the structure of quinine, the malaria remedy found in cinchona bark and known since the time of the Incas. The quinoline in quinine has a 6-MeO substituent and a side chain attached to C4. In discussing the synthesis of quinolines, we will be particularly interested in this pattern. This is because the search for anti-malarial compounds continues and other quinolines with similar structures are among the available anti-malarial drugs.

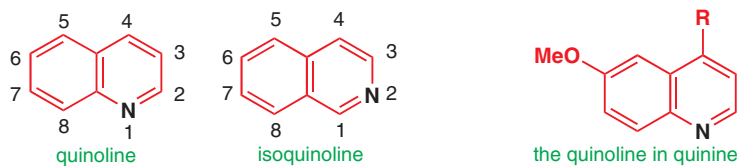

We shall also be very interested in quinolones, analogous to pyridones, with carbonyl groups at positions 2 and 4, as these are useful antibiotics. A simple example is pefloxacin, which has typical 6-F and 7-piperazine substituents.

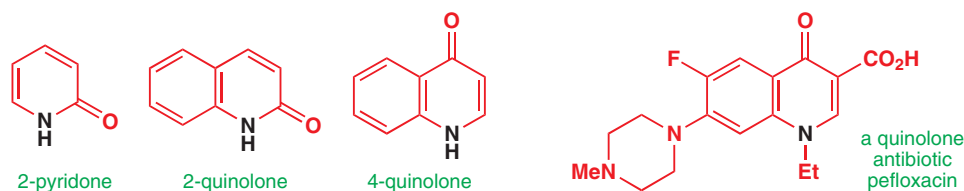

When we consider the synthesis of a quinoline, the obvious disconnections are, first, the C–N bond in the pyridine ring and, then, the C–C bond that joins the side chain to the benzene ring. We will need a three-carbon (C_3) synthon, electrophilic at both ends, which will yield two double bonds after incorporation. The obvious choice is a 1,3-dicarbonyl compound.

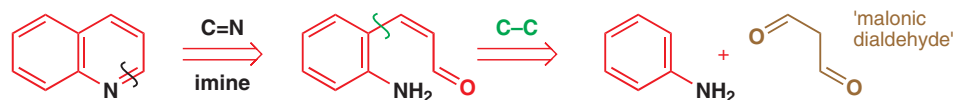

The choice of an aromatic amine is a good one as the NH_2 group reacts well with carbonyl compounds and it activates the *ortho* position to electrophilic attack. However, the dialdehyde is malonic dialdehyde, a compound that does not exist, so some alternative must be found. If the quinoline is substituted in the 2- and 4-positions this approach looks better.

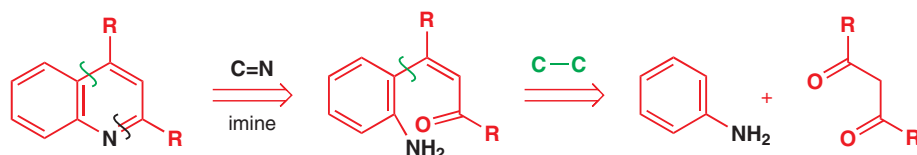

The initially formed imine will tautomerize to a conjugated enamine and cyclization now occurs by electrophilic aromatic substitution. The enamine will normally prefer to adopt the first configuration shown in which cyclization is not possible, and (perhaps for this reason or perhaps because it is difficult to predict which quinoline will be formed from an unsymmetrical 1,3-dicarbonyl compound) this has not proved a very important quinoline synthesis. However, the synthetic plan is sound, and we shall describe two important variants on this theme, one for quinolines and one for quinolones.

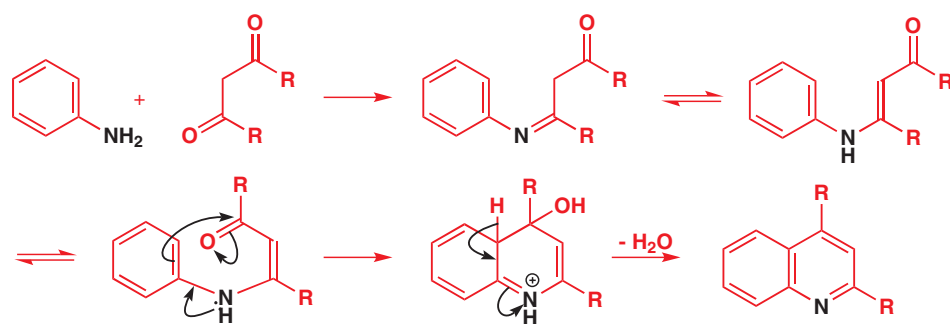

In the synthesis of pyridines it proved advantageous to make a dihydropyridine and oxidize it to a pyridine afterwards. The same idea works well in probably the most famous quinoline synthesis, the Skraup reaction. The diketone is replaced by an unsaturated carbonyl compound so that the quinoline is formed regioselectively. The first step is conjugate addition of the amine. Under acid catalysis the ketone now cyclizes in the way we have just described to give a dihydroquinoline after dehydration. Oxidation to the aromatic quinoline is an easy step accomplished by many possible oxidants.

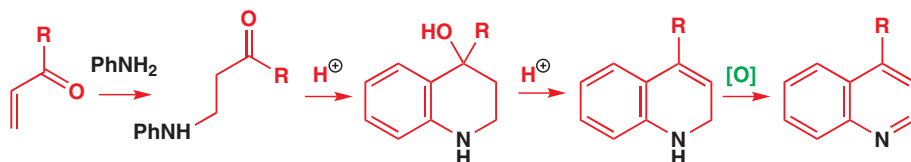

Traditionally, the Skraup reaction was carried out by mixing everything together and letting it rip. A typical mixture to make a quinoline without substituents on the pyridine ring would be the aromatic amine, concentrated sulfuric acid, glycerol, and nitrobenzene all heated up in a large flask at over 100 °C with a wide condenser.

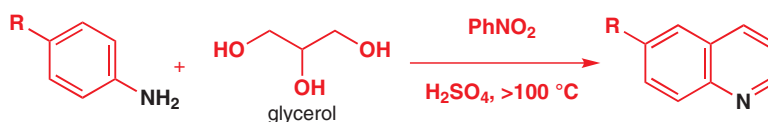

The ugly name of the Skraup reaction appropriately applies to the worst 'witch's brew' of all the heterocyclic syntheses. Some workers have added strange oxidizing agents such as arsenic acid, iron (III) salts, tin (IV) salts, nitrobenzenes of various substitution patterns, or iodine to make it 'go better'.

The glycerol was to provide acrolein ($\text{CH}_2=\text{CH}\cdot\text{CHO}$) by dehydration, the nitrobenzene was to act as oxidant, and the wide condenser...? All too often Skraup reactions did let rip—with destructive results. A safer approach is to prepare the conjugate adduct first, cyclize it in acid solution, and then oxidize it with one of the reagents we described for pyridine synthesis, particularly quinones such as DDQ.

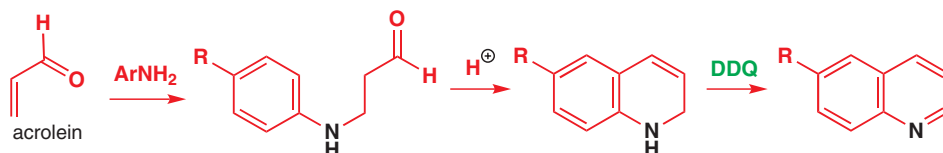

The more modern style of Skraup synthesis is used to make 8-quinolinol or 'oxine'. *ortho*-Aminophenol has only one free position *ortho* to the amino group and is very nucleophilic, so acrolein can be used in weak acid with only a trace of strong acid. Iron(III) is the oxidant, with a bit of boric acid for luck, and the yield is excellent.

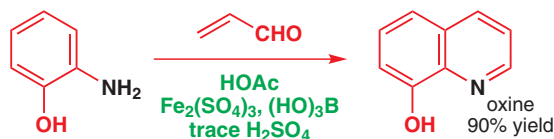

Oxine

This compound is important because it forms unusually stable metal complexes with metal ions such as Mg(II) or Al(III). It is also used as a corrosion inhibitor on copper because it forms a stable layer of the Cu(II) complex that prevents oxidation of the interior.

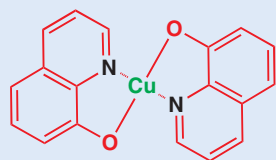

oxine complex of copper

Quinolones also come from anilines by cyclization to an *ortho* position

The usual method for making quinolone antibiotics is possible because they all have a carboxylic acid in the 3-position. The disconnection we used for quinoline suggests a rather unstable malonic ester derivative as starting material.

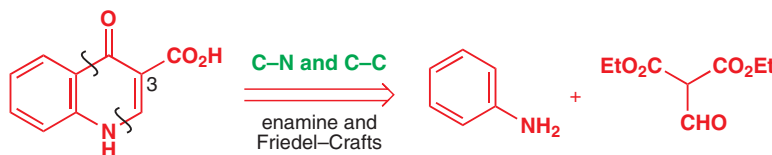

In fact, the enol ether of this compound is easily made from diethyl malonate and ethyl orthoformate [$\text{HC}(\text{OEt})_3$]. The aromatic amine reacts with this compound by an addition-elimination sequence, giving an enamine that cyclizes on heating. This time the geometry of the enamine is not a concern.

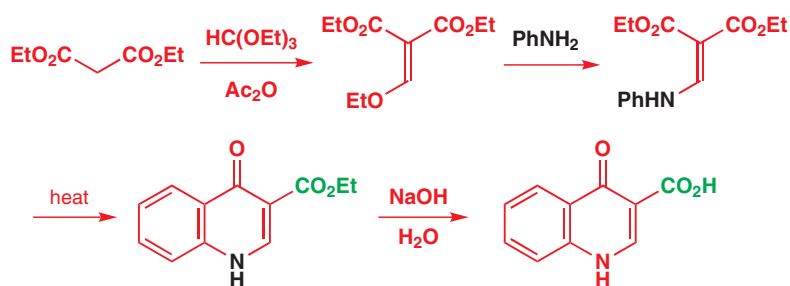

For examples of quinolone antibiotics we can choose ofloxacin, whose synthesis was discussed in detail in Chapter 22, and rosoxacin, whose synthesis is discussed below. Both molecules contain the same quinolone carboxylic acid framework, outlined in black, with another heterocyclic system at position 7 and various other substituents here and there.

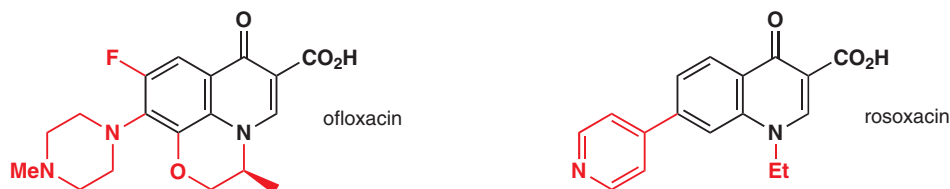

To make rosoxacin two heterocyclic systems must be constructed. Workers at the pharmaceutical company Sterling decided to build the pyridine in an ingenious version of the Hantzsch synthesis using acetylenic esters on 3-nitrobenzaldehyde. The ammonia was added as ammonium acetate. Oxidation with nitric acid made the pyridine, hydrolysis of the esters and decarboxylation removed the acid groups, and reduction with Fe(II) and HCl converted the nitro group into the amino group required for the quinolone synthesis.

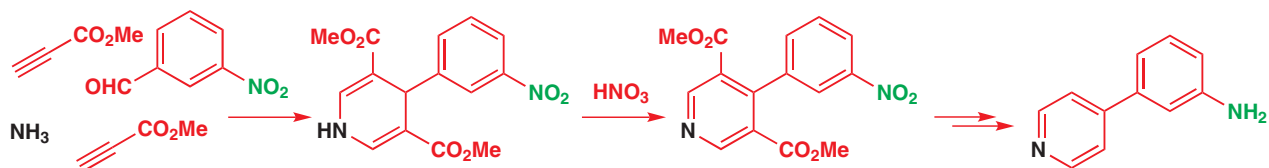

Now the quinolone synthesis can be executed with the same reagents we used before and all that remains is ester hydrolysis and alkylation at nitrogen. Notice that the quinolone cyclization could in theory have occurred in two ways as the two positions *ortho* to the amino group are different. In practice cyclization occurs away from the pyridine ring as the alternative quinolone would be impossibly crowded.

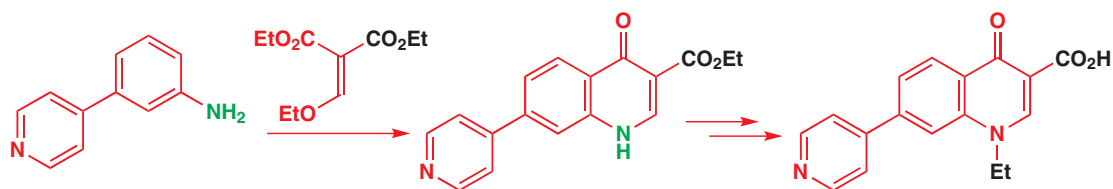

Since quinolones, like pyridones, can be converted into chloro-compounds with POCl_3 , they can be used in nucleophilic substitution reactions to build up more complex quinolines.

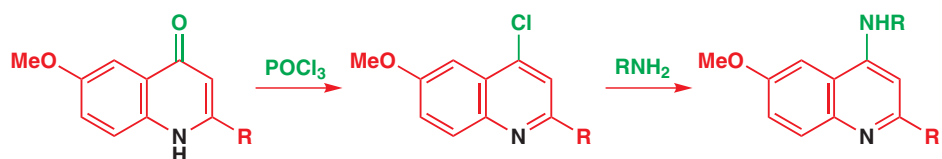

■ The Vilsmeier reaction with DMF is on p. 734.

■ The reaction with Pd is simply the reverse of a Pd-catalysed hydrogenation.

We will give just one important synthesis of isoquinolines here. It is a synthesis of a dihydroisoquinoline by what amounts to an intramolecular Vilsmeier reaction in which the electrophile is made from an amide and POCl_3 . Oxidation (in this case a dehydrogenation with $\text{Pd}(0)$) gives the quinoline.

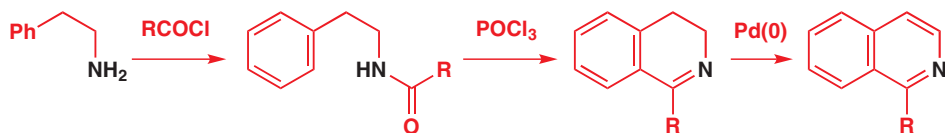

More heteroatoms in fused rings mean more choice in synthesis

The imidazo-pyridazine ring system forms the basis for a number of drugs in human and animal medicine. The synthesis of this system uses the chemistry discussed in Chapter 29 to build the pyridazine ring. There we established that it was easy to make dichloropyridazines and to displace the chlorine atoms one by one with different nucleophiles. Now we will move on from these intermediates to the bicyclic system.

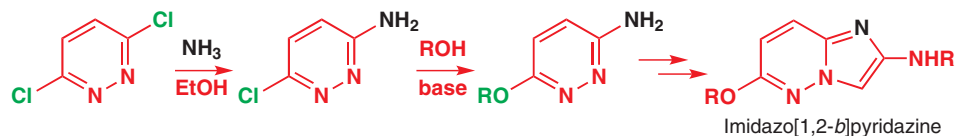

A 2-bromo-acid derivative is the vital reagent. It reacts at the amino nitrogen atom with the carbonyl group and at the pyridazine ring nitrogen atom with the alkyl halide. This is the only way the molecule can organize itself into a ten-electron aromatic system.

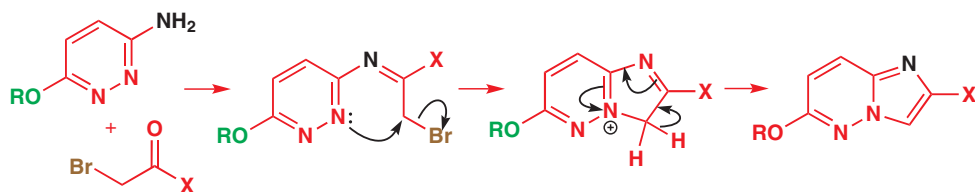

In Chapter 29 we also gave the structure of timolol, a thiadiazole-based β -blocker drug for reduction of high blood pressure. This compound has an aromatic 1,2,5-thiadiazole ring system and a saturated morpholine as well as an aliphatic side chain. Its synthesis relies on ring formation by rather a curious method followed by selective nucleophilic substitution, rather in the style of the last synthesis. The aromatic ring is made by the action of S_2Cl_2 on 'cyanamide'.

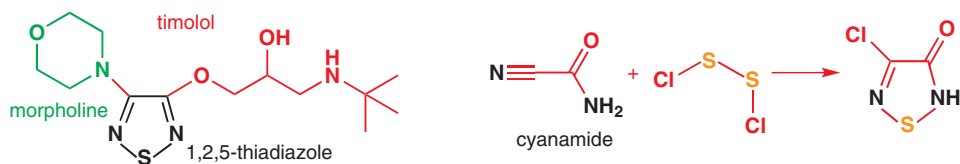

This reaction must start by attack of the amide nitrogen on the electrophilic sulfur atom. Cyclization cannot occur while the linear nitrile is in place so chloride ion (from disproportionation of ClS^\ominus) must first attack CN . Thereafter cyclization is easy.

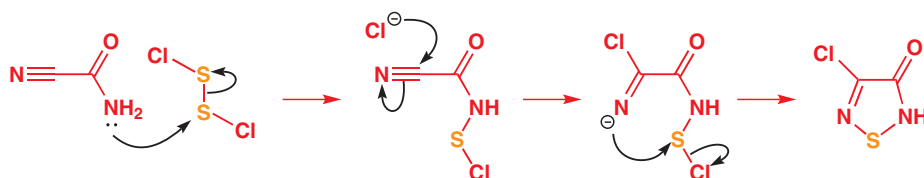

Reaction with epichlorohydrin followed by amine displacement puts in one of the side chains and nucleophilic substitution with morpholine on the ring completes the synthesis.

➔ We used epichlorohydrin a lot in Chapter 28.

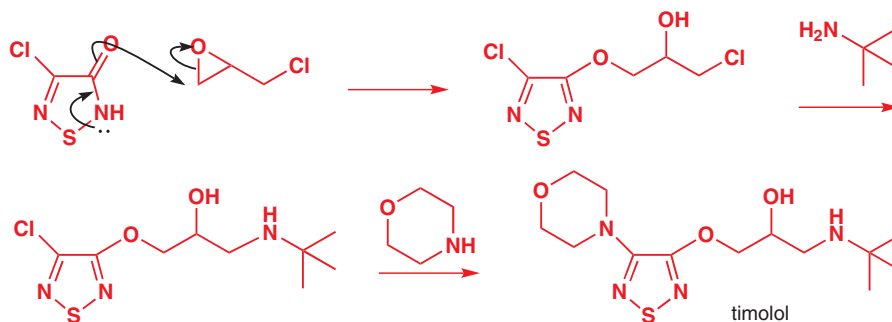

Summary: the three major approaches to the synthesis of aromatic heterocycles

We end this chapter with summaries of the three major strategies in the synthesis of heterocycles:

- ring construction by ionic reactions
- ring construction by cycloadditions
- modification of existing rings by electrophilic or nucleophilic aromatic substitution or by lithiation and reaction with electrophiles.

We will summarize the different applications of these strategies, and also suggest cases for which each strategy is not suitable. This section revises material from Chapter 29 as well since most of the ring modifications appear there.

Ring construction by ionic cyclization

The first strategy you should try out when faced with the synthesis of an aromatic heterocyclic ring is the disconnection of bonds between the heteroatom or atoms and carbon, with the idea of using the heteroatoms as nucleophiles and the carbon fragment as a double electrophile.

Heterocycles with one heteroatom

five-membered rings

- pyrroles, thiophenes, and furans ideally made by this strategy from 1,4-dicarbonyl compounds

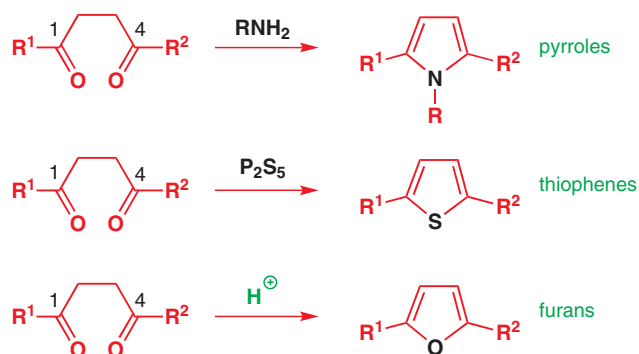

■ This is only a summary. There are more details in the relevant sections of Chapters 29 and 30. There are also many, many more ways of making all these heterocycles. These methods are just where we suggest you start.

six-membered rings

- pyridines made by this strategy from 1,5-dicarbonyl compounds with oxidation

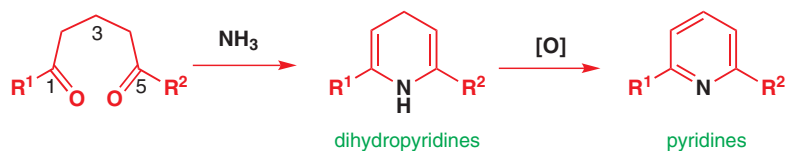

Heterocycles with two adjacent heteroatoms

five-membered rings

- pyrazoles and isoxazoles ideally made by this strategy from 1,3-dicarbonyl compounds

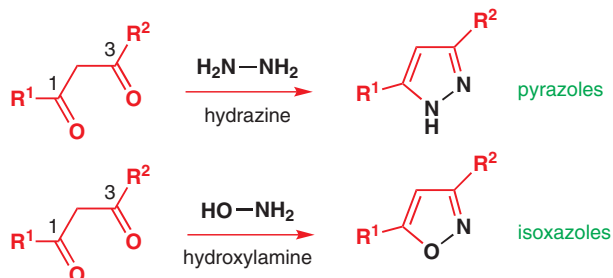

Note. This strategy is *not* suitable for isothiazoles as 'thiolamine' does not exist

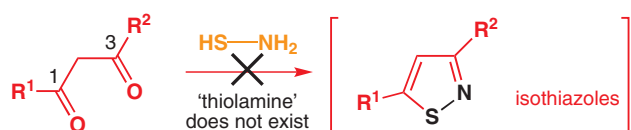

six-membered rings

- pyridazines ideally made by this strategy from 1,4-dicarbonyl compounds with oxidation

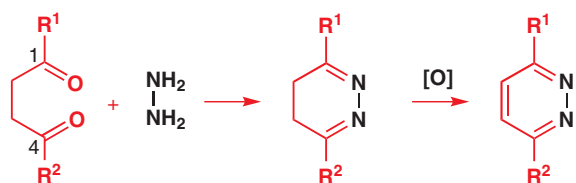

Heterocycles with two non-adjacent heteroatoms

five-membered rings

- imidazoles and thiazoles ideally made by this strategy from α -halocarbonyl compound

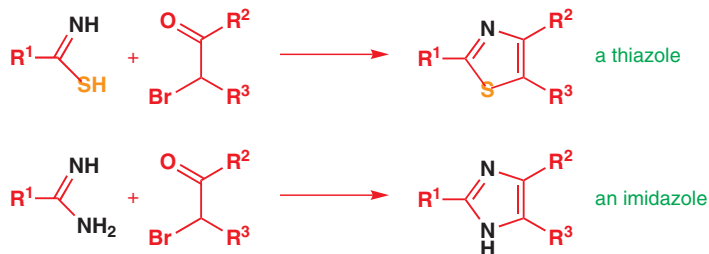

Note. This strategy is *not* suitable for oxazoles as amides are not usually reactive enough: cyclization of acylated carbonyl compounds is usually preferred

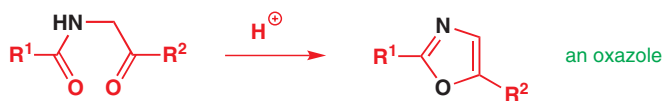

six-membered rings

- pyrimidines ideally made by this strategy from 1,3-dicarbonyl compounds

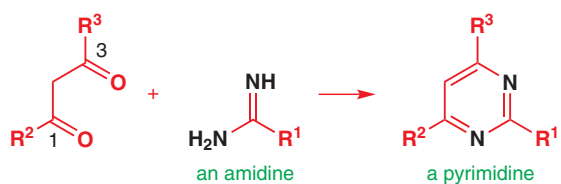

Ring construction by cycloadditions

1,3-dipolar cycloaddition reactions

- ideal for the construction of isoxazoles, 1,2,3-triazoles, and tetrazoles

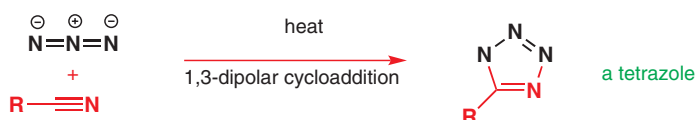
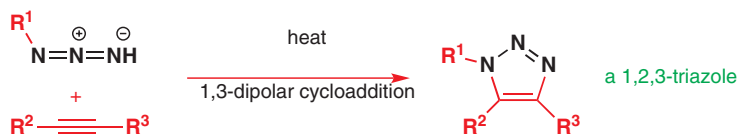
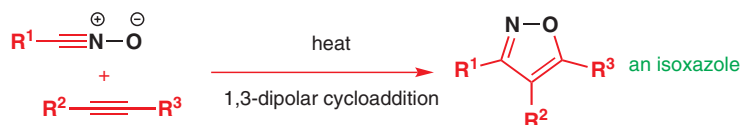

...or sigmatropic rearrangements

- a special reaction that is the vital step of the Fischer indole synthesis

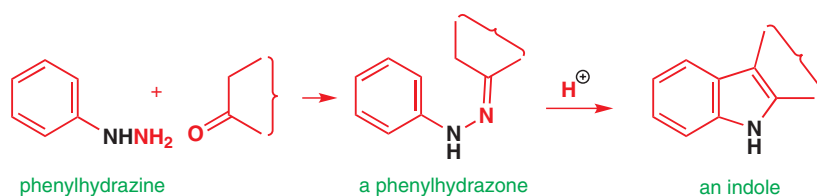

Ring modification

Electrophilic aromatic substitution

- works very well on pyrroles, thiophenes, and furans, where it occurs best in the 2- and 5-positions and nearly as well in the 3- and 4-positions
- often best to block positions where substitution not wanted
- works well for indole—occurs only in the 3-position but the electrophile may migrate to the 2-position



pyrrole



thiophene



furan

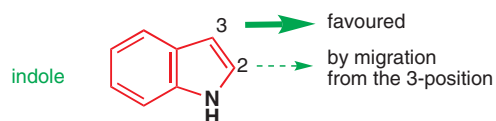
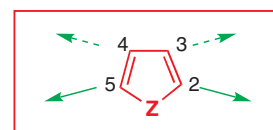

- works well for five-membered rings with a sulfur, oxygen, or pyrrole-like nitrogen atom and occurs anywhere that is not blocked (see earlier sections)

Note. Not recommended for pyridine, quinoline, or isoquinoline

Nucleophilic aromatic substitution

- works particularly well for pyridine and quinoline where the charge in the intermediate can rest on nitrogen

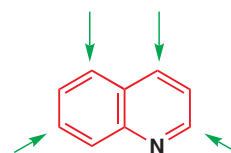
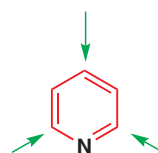

- especially important for pyridones and quinolones with conversion to the chloro-compound and displacement of chlorine by nucleophiles and, for quinolines, displacement of fluorine atoms on the benzene ring

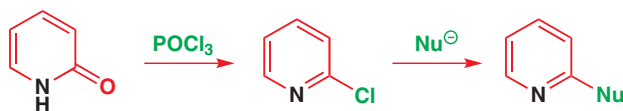

- works well for the six-membered rings with two nitrogens (pyridazines, pyrimidines, and piperazines) in all positions

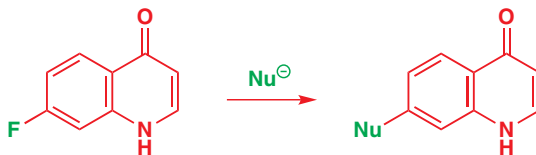

Lithiation and reaction with electrophiles

- works well for pyrrole (if NH blocked), thiophene, or furan next to the heteroatom. Exchange of Br or I for Li works well for most electrophiles providing any acidic hydrogens (including the NH in the ring) are blocked

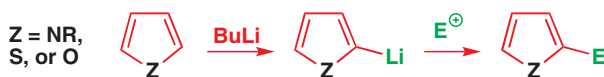

Further reading

The best general text on heterocycles is J. A. Joule and K. Mills, *Heterocyclic Chemistry* 4th edn, Chapman and Hall, London, 2010.

S. Warren and P. Wyatt, *Workbook for Organic Synthesis: the Disconnection Approach*, Wiley, Chichester, 2009, chapters 34–35.

Check your understanding



To check that you have mastered the concepts presented in this chapter, attempt the problems that are available in the book's Online Resource Centre at <http://www.oxfordtextbooks.co.uk/orc/clayden2e/>

Saturated heterocycles and stereoelectronics

31

Connections

➔ Building on

- Acetals and hemiacetals [ch11](#)
- Stereochemistry [ch13](#)
- The conformation of cyclic molecules [ch16](#)
- Stereospecific elimination reactions [ch17](#)
- Proton NMR [ch18](#)
- Aldol reactions [ch26](#)
- Aromatic heterocycles [ch29 & ch30](#)

Arriving at

- Putting a heteroatom in a ring changes the reactivity of the heteroatom
- Ring-opening reactions: the effect of ring strain
- Lone pairs in heterocycles have precise orientations
- Some substituents prefer to be axial on some six-membered saturated heterocycles
- Interactions of lone pairs with empty orbitals can control conformation
- Ring-closing reactions: why five-membered rings form quickly and four-membered rings form slowly
- Baldwin's rules: why some ring closures work well while others don't work at all
- How conformation and ring size affect coupling constants
- Geminal coupling
- The relationship between symmetry and NMR spectra: diastereotopicity

➔ Looking forward to

- Stereoselectivity in cyclic systems [ch32](#)
- Diastereoselectivity [ch33](#)
- Asymmetric synthesis [ch41](#)
- Chemistry of life [ch42](#)

Introduction

Rings make a difference to the way molecules react and the ways they can be made, and we have just devoted two chapters to the reactions and synthesis of flat, aromatic heterocycles. In this chapter and the one that follows we shall continue to look at rings, but not flat aromatic ones. Once you put saturated atoms into rings the rings become flexible and display interesting chemical features. We introduced ways of talking about conformation in rings in Chapter 16, and we will revisit ideas from that chapter—in particular we will build on the idea that rings make it easier to think about stereochemistry because they restrict the number of conformations a molecule can adopt. We will also introduce a theme which we develop over the next few chapters of the book: *stereoselectivity*—how to make single diastereoisomers of a product.

It may seem strange that heterocycles—rings containing not just carbon atoms, but oxygen, nitrogen, or sulfur as well—deserve three whole chapters, but you will soon see that this is justified both by the sheer number and variety of heterocycles that exist and by their special chemical features. We dealt with the special stereochemical features of *aromatic* heterocycles

Online support. The icon  in the margin indicates that accompanying interactive resources are provided online to help your understanding: just type www.chemtube3d.com/clayden/123 into your browser, replacing 123 with the number of the page where you see the icon. For pages linking to more than one resource, type 123-1, 123-2 etc. (replacing 123 with the page number) for access to successive links.

in the last two chapters, in particular their distinctive reactivity, stability, and ease of synthesis. Some examples of *saturated* heterocycles, a few of which may be familiar to you, are shown below.

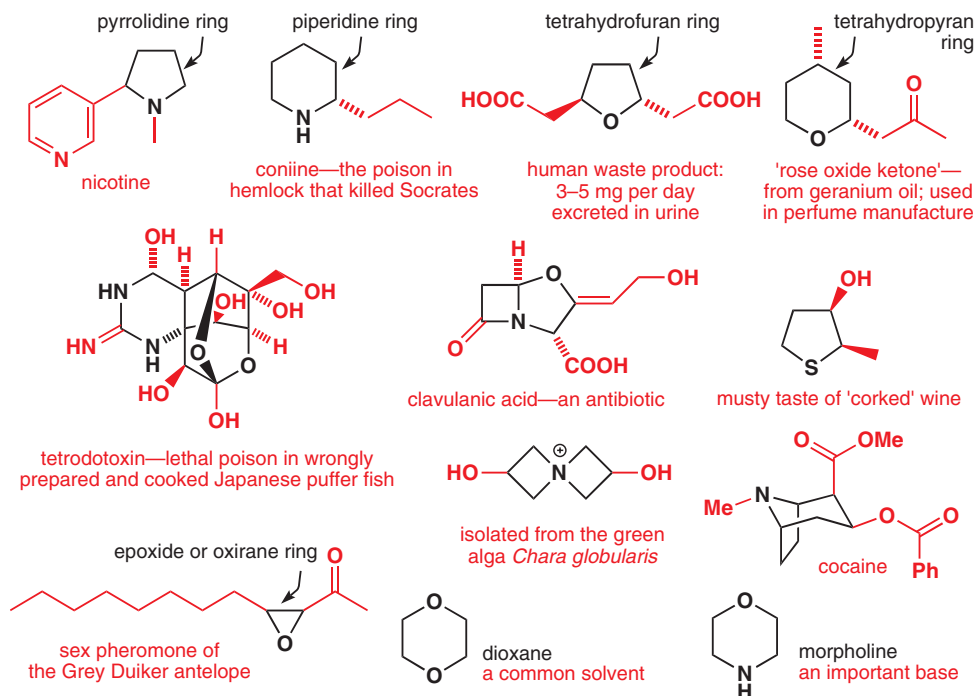

The saturated heterocyclic rings are shown in black, and names for the most important ring types are given: some (like piperidine, morpholine) you will need to remember; others (tetrahydrofuran, pyrrolidine) are more obviously derived from the names for aromatic heterocycles you met in the last chapter. Some of these compounds (nicotine, coniine, cocaine) are plant products falling into the class called alkaloids, which are discussed in Chapter 42. Another important class of saturated heterocycles, sugars, will also appear in Chapter 42.

But what are the 'special chemical features' of saturated heterocycles? Putting a heteroatom into a ring does two important things, and these lead to the most important new topics in this chapter.

- Firstly, the heteroatom makes the ring easy to make by a ring-closing reaction, or (in some cases) easy to break by a ring-opening reaction. Closing and opening reactions of rings are subject to constraints that you will need to know about, and the principles that govern these reactions are discussed later in the chapter.
- Secondly, the ring fixes the orientation of the heteroatom—and, in particular, the orientation of its lone pairs—relative to the atoms around it. This has consequences for the reactivity and conformation of the heterocycle which can be explained using the concept of stereoelectronics.

• **Stereoelectronic effects are chemical consequences of the arrangement of orbitals in space.**

Reactions of saturated heterocycles

Saturated nitrogen heterocycles: amines, but more nucleophilic

In many reactions the simple saturated nitrogen heterocycles—piperidine, pyrrolidine, piperazine, and morpholine—behave simply as secondary amines that happen to be cyclic.

■ Although this is the only chapter in which stereoelectronics appears in the title, you will soon recognize the similarity between the ideas we cover here and concepts like the stereospecificity of E2 elimination reactions (Chapter 17) and the effect of orbital overlap on NMR coupling constants (Chapter 18). We will also use orbital alignment to explain the Karplus relationship (Chapter 32), the Felkin–Anh transition state (Chapter 33), and the conformational requirements for rearrangement and fragmentation reactions (Chapter 36).

They do the sorts of things that other amines do, acting as nucleophiles in addition and substitution reactions. Morpholine, for example, is acylated by 3,4,5-trimethoxybenzoyl chloride to form the tranquillizer and muscle relaxant trimetozine, and *N*-methylpiperazine can be alkylated in an S_N1 reaction with diphenylmethyl chloride to give the travel-sickness drug cyclizine.

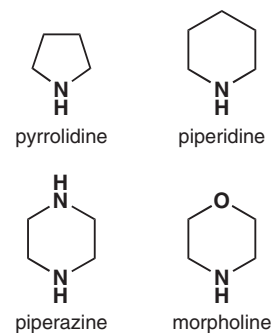
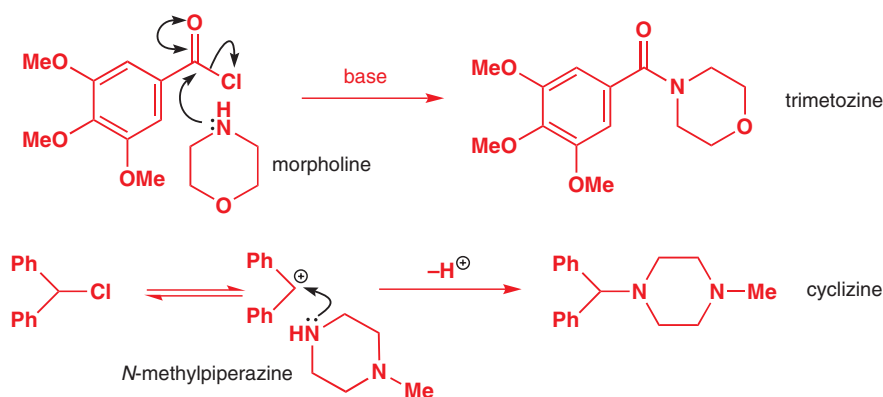

The addition of pyrrolidine to aldehydes and ketones is a particularly important reaction because it leads to enamines, the valuable enol equivalents discussed in Chapter 25.

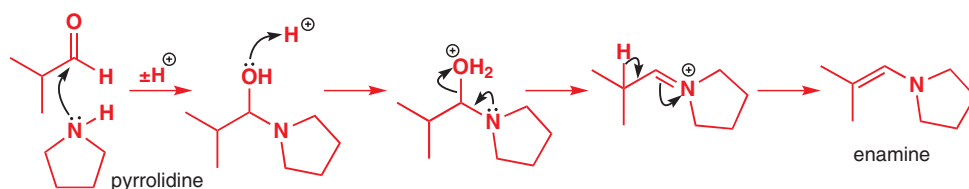

Enamines formed from pyrrolidine and piperidine are particularly stable because pyrrolidine and piperidine are rather more nucleophilic than comparable acyclic amines such as diethylamine. This is a general feature of cyclic amines (and cyclic ethers, too, as you will see shortly), and is a steric effect. The alkyl substituents, being tied back into a ring, are held clear of the nucleophilic lone pair, allowing it to approach an electrophile without hindrance. This effect is well illustrated by comparing the rates of reaction of methyl iodide with three amines—tertiary this time. The two cyclic compounds are bridged—quinuclidine is a bridged piperidine while the diamine known as DABCO (1,4-diazabicyclo[2.2.2]octane) is a bridged piperazine. The table below shows the relative rates, along with pK_a values, for triethylamine, quinuclidine, and DABCO.

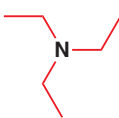
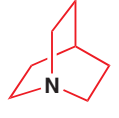
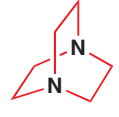

Rates of reaction of amines with methyl iodide

			
	triethylamine	quinuclidine	DABCO
relative rate of reaction ^a	1	63	40
pK_a of R_3NH^+	10.7	11.0	8.8 (and 3.0)

^aRelative rate of reaction with MeI in MeCN at 20°C.

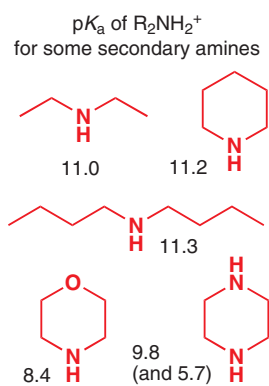

■ To clarify: the pK_a s we are talking about here are the pK_a values of the ammonium ions $R_2NH_2^+$.

Quinuclidine and DABCO are 40–60 times more reactive than triethylamine. This is again due to the way the ring structures keep the nitrogen's substituents away from interfering with the lone pair as it attacks the electrophile. You should contrast the effect that the cyclic structure has on the basicity of the amines: none! Triethylamine and quinuclidine are equally basic and, as you can see in the margin, so (more or less) are diethylamine, dibutylamine, and piperidine. A proton is so small that it cares very little whether the alkyl groups are tied back or not.

Much more important in determining pK_a is how electron-rich the nitrogen is, and this is the cause of the glaring discrepancy between the basicity of quinuclidine and that of DABCO, or between the basicities of piperidine (pK_a 11.2) and morpholine (pK_a 9.8) or piperazine (pK_a 8.4). The extra heteroatom, through an inductive effect, withdraws electron density from the nitrogen atom, making it less nucleophilic and less basic. In this sense, morpholine can be a very useful base, less basic than triethylamine but somewhat more so than pyridine (pK_a 5.2). Notice how much lower is the second pK_a (that is, the pK_a for protonation of the second nitrogen) of the diamines DABCO and piperazine: the protonated nitrogen of the monoprotonated amine withdraws electrons very effectively from the unprotonated one.

The Baylis–Hillman reaction

One of the most important uses of DABCO is in the Baylis–Hillman reaction, discovered in 1972 by two chemists at the Celanese Corporation in New York. Their reaction is a modification of the aldol reaction (Chapter 26), except that instead of the enolate being formed by deprotonation it is formed by conjugate addition. You have seen the enolate products of conjugate addition being trapped by alkylating agents in Chapter 25, but in the Baylis–Hillman reaction the electrophile is an aldehyde and is present right from the start of the reaction, which is done just by stirring the components at room temperature. Here is a typical example.

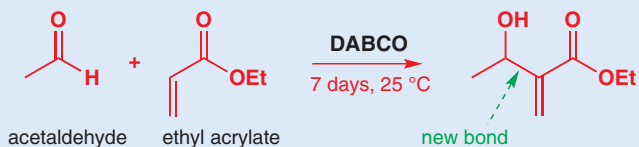

The reaction starts with the (relatively nucleophilic) DABCO undergoing conjugate addition to ethyl acrylate. This will form an enolate that can then attack the acetaldehyde in an aldol reaction.

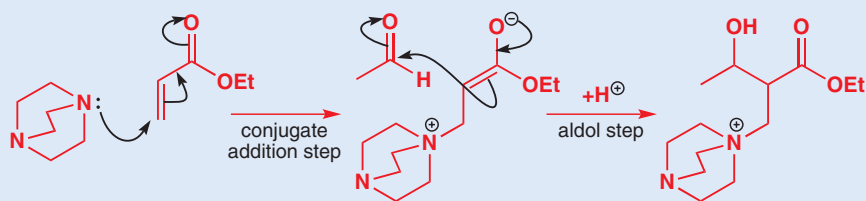

$E1cB$ eliminations often follow aldol reactions and lead to α,β -unsaturated products. In this case, though, DABCO is a much better leaving group than the hydroxyl group, so enolization leads to loss of DABCO in an $E1cB$ elimination, giving the product of the reaction. DABCO is recovered and is a catalyst.

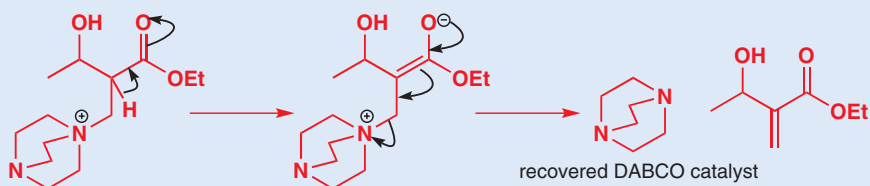

A disadvantage of the Baylis–Hillman reaction is its rate: typically, several days' reaction time are required. Pressure helps speed the reaction up, but as a catalyst DABCO is about the best. It is nucleophilic because of the 'tied back' alkyl groups, but importantly it is a good leaving group because it has a relatively low pK_a , meaning that it leaves easily in the last step. As you have seen before, good nucleophiles are usually bad leaving groups, although there are many exceptions. DABCO's combination of nucleophilicity and leaving group ability is perfect here.

The exposed nature of the nitrogen atom in cyclic amines means that nitrogen heterocycles are very frequently encountered in drug molecules, particularly those operating on the central nervous system (cocaine, heroin, and morphine all contain nitrogen heterocycles, as do codeine and many tranquilizers, such as Valium). But the ring can also be used as a support for adding substituents that hinder the nitrogen's lone pair. Just as the nitrogen atom of piperidine is permanently exposed, the nitrogen atom of 2,2,6,6-tetramethylpiperidine (TMP) nestles deep in a bed of methyl groups. The lithium salt of TMP (LiTMP) is an analogue of LDA—a base that experiences enormous steric hindrance that can be used in situations where the selectivity even of LDA fails.

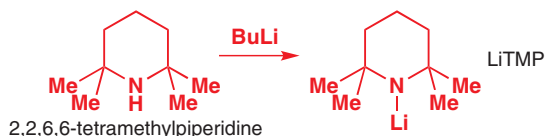

■ With LDA, one or other of the isopropyl groups always has the option of rotating to place only a C–H group close to the N–Li bond. In LiTMP, there are unavoidably four Me groups close to Li.

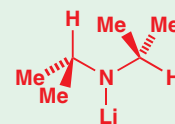

Aziridine: ring strain promotes ring opening

Aziridine and azetidine are stable, if volatile, members of the saturated nitrogen heterocycle family, and aziridine has some interesting chemistry of its own. Like pyrrolidine and piperidine, aziridine can be acylated by treatment with an acyl chloride, but the product is not stable. The ring opens with attack of chloride, a relatively poor nucleophile, and an open-chain secondary amide results.

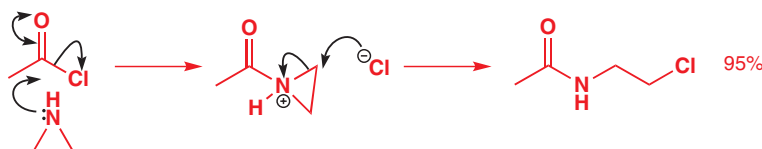

You can view this ring opening as very similar to the ring opening of an epoxide (Chapter 19)—in particular, a *protonated* epoxide, in which the oxygen bears a positive charge. The positive charge is very important for aziridine opening because, when the reaction is done in the presence of a base, removal of the proton leads immediately to the neutral acyl aziridine, which is stable.

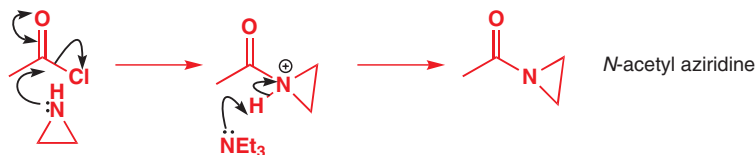

The ring opening of aziridine is a useful way of making larger heterocycles: anything that puts a positive charge on nitrogen encourages the opening by making N a better leaving group, whether it's protonation or, as shown below, alkylation. Alkylation of aziridine in base gives the *N*-substituted aziridine as you might expect, but a second alkylation leads to a positively charged aziridinium salt that opens immediately to a useful bromoamine.

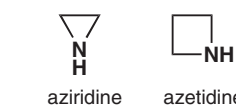
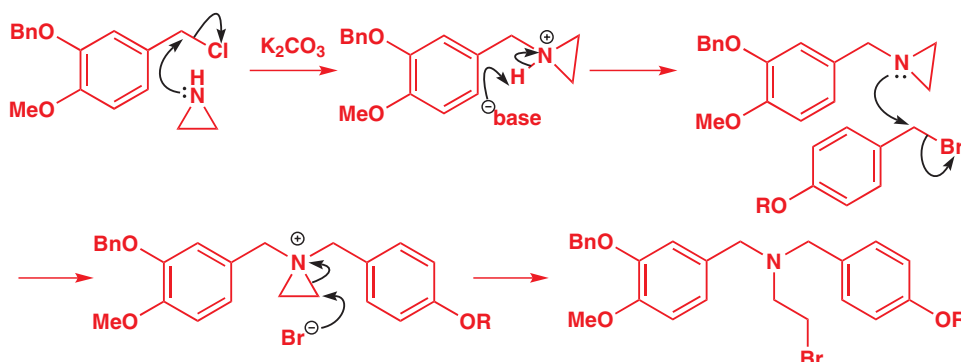

Systematic nomenclature of saturated heterocycles

The names aziridine and azetidine are derived from a reasonably logical system of nomenclature, which assigns three-part heterocycle names according to: (a) the heteroatom ('az-' = nitrogen, 'ox-' = oxygen, 'thi-' = sulfur), (b) the ring size ('-ir-' = 3, from tri; '-et-' = 4, from tetra; '-ol-' = 5; nothing for 6; '-ep-' = 7, from hepta; '-oc-' = 8, from octa; etc.), and (c) the degree of saturation ('-ene' or '-ine' for unsaturated, '-idine' or '-ane' for saturated). Hence az-ir-idine, az-et-idine, di-ox-ol-ane, and ox-ir-ane.

■ In this case, the product is an intermediate in the synthesis of two natural products, sandaverine and corgoine.

We have just mentioned the protonation of aziridine, and you might imagine from what we said earlier about the comparative nucleophilicity and basicity of nitrogen heterocycles and their acyclic counterparts that aziridine will be even more nucleophilic than pyrrolidine, and about as basic. Well, it isn't. The idea that 'tying back' the alkyl groups increases nucleophilicity is only valid for unstrained five or six-membered rings: with small rings another effect takes over.

Aziridine is, in fact, much less basic than pyrrolidine and piperidine: the pK_a for its protonation is only 8.0. This is much closer to the pK_a of a compound containing an sp^2 hybridized nitrogen atom—the imine in the margin, for example. This is because the nitrogen's lone pair is in an orbital with much more s character than is typical for an amine, due to the three-membered ring. This is an effect we have discussed before, in Chapter 18, and you should re-read pp. 412–415 if you need to refresh your memory. There we compared three-membered rings with alkynes, explaining that both could be deprotonated relatively easily. The anion carries a negative charge in a low-energy orbital with much s character: the same type of orbital carries aziridine's lone pair.

The s character of the aziridine nitrogen's lone pair has other effects too. The lone pair interacts very poorly with an adjacent carbonyl group, so N -acyl aziridines such as the one you saw on p. 973 behave not at all like amides. The nitrogen atom is pyramidal and not planar, and the stretching frequency of the $C=O$ bond (1706 cm^{-1}) is much closer to that of a ketone (1710 cm^{-1}) than that of an amide (1650 cm^{-1}).

The s character of the lone pair means that the nitrogen atom inverts very slowly, rather like a phosphine. Usually it is not possible for nitrogen to be a stereogenic centre because inversion is too rapid—the transition state for nitrogen inversions (in which the lone pair is in a p orbital) is low in energy. But with an aziridine, getting the lone pair into a p orbital requires much more activation energy, so nitrogen can be stereogenic. The two stereoisomers of the N -substituted aziridine in the margin can be separated and isolated.

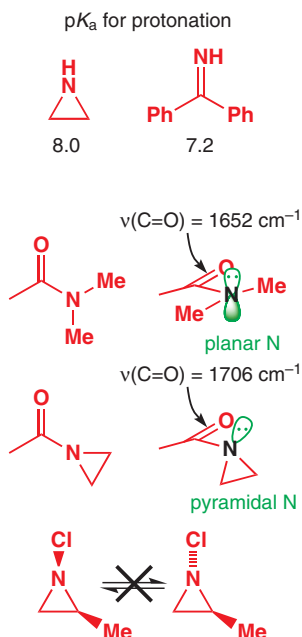

Oxygen heterocycles

Ring-opening chemistry is characteristic of oxygen heterocycles too, and there is no need for us to revisit epoxide opening here. Epoxides are particularly reactive because ring-opening releases ring strain, driving the reaction forward. In general, though, oxygen heterocycles, as cyclic ethers, are relatively unreactive: ethers are the least reactive of all the common functional groups. This is one of the main reasons why THF and dioxane are such important solvents. A second reason is that they solvate organometallics by donating a lone pair to stabilize an electron-deficient metal cation (Li, for example). Cyclic ethers are better donors (more nucleophilic) than acyclic ones for the same reason that cyclic amines are more nucleophilic than acyclic ones.

This interaction of the lone pair with a Lewis acid can be exploited to make ethers more reactive. BF_3 is commonly used to activate cyclic ethers towards nucleophilic attack, and even with epoxides it increases the rate and yield of the reaction when organometallic reagents are used as nucleophiles. $n\text{-BuLi}$ does not react with oxetane unless a Lewis acid, such as BF_3 , is added, when it opens the four-membered ring to give a quantitative yield of n -heptanol. Without ring strain to help the reaction along, THF, by contrast, gives only a low yield of the product even with a Lewis acid.

➔ Epoxide opening under acidic and basic conditions was covered in Chapter 19.

■ BF_3 is most easily handled as its complex with diethyl ether, written $BF_3 \cdot OEt_2$ or $BF_3 \bullet OEt_2$, in which the ether lone pair donates into the boron's empty p orbital. In related reactions HBr , BBr_3 , or Me_3SiCl are used to activate methyl and benzyl ethers of phenols towards nucleophilic attack. See Chapters 15, p. 351 and 23, p. 551.

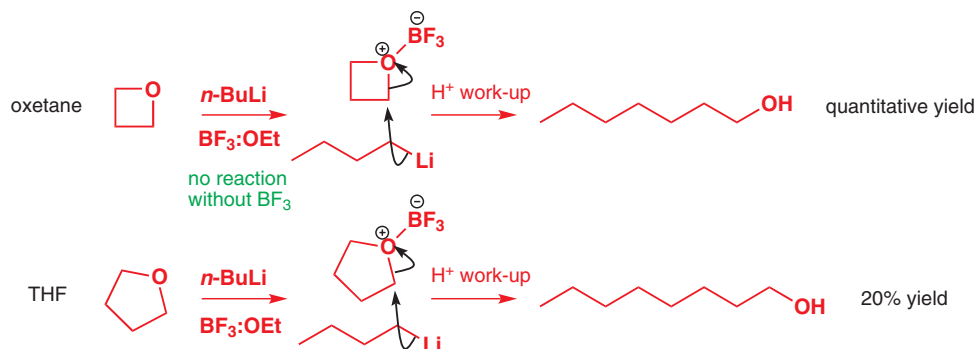

A more common (if often unwanted) reaction between BuLi and THF is not nucleophilic attack, but deprotonation. You will have noticed that reactions involving BuLi in THF are invariably carried out at temperatures of 0 °C or below—usually –78 °C. This is because, at temperatures above 0 °C, deprotonation of THF begins to take place. The deprotonated THF is unstable, and it undergoes a reaction we call a reverse [2 + 3] cycloaddition (see Chapter 34). Here is the mechanism (we have represented the organolithium as an anion to help with the arrows). The products are: (1) the (much less basic) enolate of acetaldehyde and (2) ethylene. The first tends to polymerize, and the second usually (but see the box below!) evaporates from the reaction mixture.

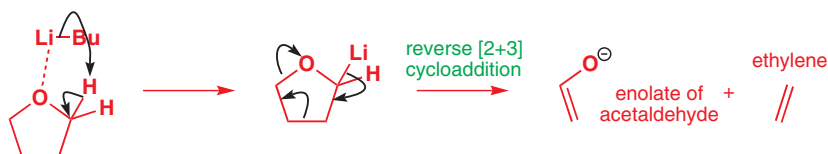

The case of the unexpected ethyl group

Some chemists in Belgium were studying the reactions of the organolithium shown here to find out whether the anionic centre would attack the double bond to form a five-membered ring. The reaction was slow, and they stirred the organolithium in THF for 6 hours at 0 °C. When they worked the reaction up they found no five-membered ring products: instead they got a compound with an extra ethyl group! They showed that this ethyl group, in fact, comes from THF: the organolithium did not add to the double bond in the same molecule, but it did add slowly and in low yield to the double bond of the ethylene that is formed by decomposition of THF.

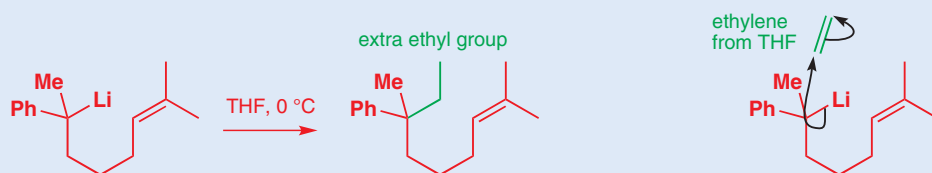

The most common use of tetrahydropyran derivatives is as protecting groups: you met this in Chapter 23.

Sulfur heterocycles

As you saw in Chapter 27, sulfur stabilizes an adjacent anion, meaning that sulfur heterocycles are much easier to deprotonate than THF. The most important of these contains two sulfur atoms: dithiane. Deprotonation of dithiane occurs in between the two heteroatoms, and you saw some chemistry that arises from this on p. 661. The series of reactions below illustrates nicely both dithiane chemistry and the ring opening of oxygen heterocycles in the presence of BF_3 . This substituted derivative of dithiane is deprotonated by BuLi to give a nucleophilic organolithium that will attack electrophiles—even oxygen heterocycles—provided BF_3 is present. The products are formed in excellent yield, even when the electrophile is THP, with no ring strain to drive the reaction. After the addition reaction the dithiane ring can be hydrolysed with mercury(II) to give a ketone carrying other useful functional groups.

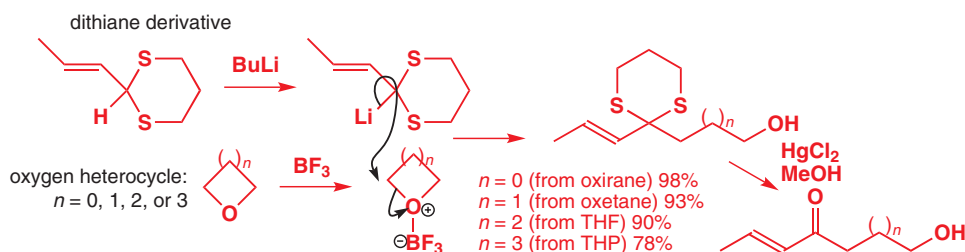

THF stability

The half-life of *n*-BuLi in THF (in the presence of TMEDA) is 40 minutes at 20 °C, 5.5 hours at 0 °C, and 2 days at –20 °C. Diethyl ether is much less readily deprotonated: at 20 °C in ether *n*-BuLi has a half life of 10 hours. With more basic organolithiums, the rate of decomposition of THF is even faster, and *t*-BuLi can be used in THF only at –78 °C. At –20 °C *t*-BuLi has a half-life in THF of only 45 minutes; in ether its half-life at this temperature is 7.5 hours.

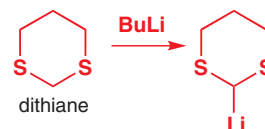

■ Dithiolane, the five-membered version of dithiane, cannot be used in this reaction because, although it is easy to deprotonate, the anion which forms decomposes by the same mechanism as lithiated THF.

➔ Coupling in alkenes is described on p. 293; coupling in cyclohexanes on p. 415.

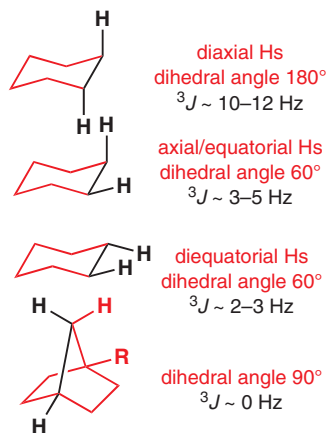

Dihedral angles

The dihedral angle is obvious in a Newman projection—it is the angle between the two C–H bonds projected on a plane orthogonal to the C–C bond. In a Newman projection this plane is the plane of the paper, and here the angle is 180° .

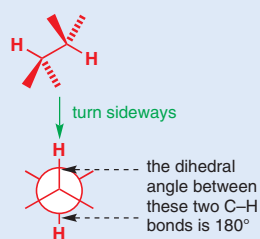

Another way to think of the dihedral angle is by imagining the C–C bond lying along the spine of a partially opened book. If the C–H bonds are written one on one page and the other on the other, then the dihedral angle is the angle between the pages of the book.

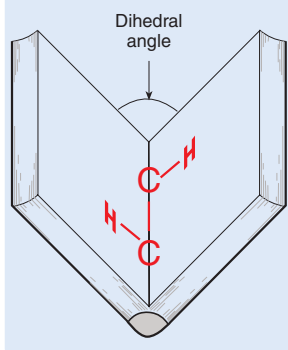

Conformation of saturated heterocycles

Using NMR to study conformation: the Karplus relationship

In Chapters 13 and 18 we explained that coupling in NMR spectra is a *through-bond* (and not a *through-space*) effect—that is why *trans* alkenes have bigger coupling constants than *cis* alkenes, and why axial–axial coupling in six-membered rings is larger than axial–equatorial or equatorial–equatorial coupling. We now need to build some more detail into your understanding of the relationship between conformation and coupling constants so we can use NMR to probe the conformations adopted by saturated rings.

The coupling constants in a cyclohexane tell us that coupling is greatest when the C–H bonds involved are most parallel—in other words when their dihedral angle is close to 180° or 0° . C–H bonds in simple cyclohexanes can have dihedral angles of only 60° or 180° , but by examining coupling constants in a range of other compounds, it is possible to draw up a description of the way coupling varies with dihedral angle. For example, in the bicyclic compound in the margin, the black protons have a dihedral angle close to 90° and the coupling constant is 0 Hz. The complete correlation was worked out by Karplus in the 1960s and is called the Karplus relationship. It is easiest to understand as a graph of J against dihedral angle.

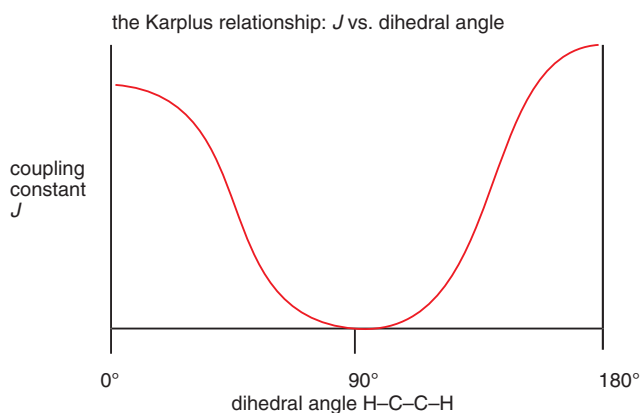

Examine the graph above carefully and note these principal features:

- Coupling is largest at 180° when the orbitals of the two C–H bonds are perfectly parallel (the situation in a *trans* alkene or the *trans*-diaxial C–H bonds of a cyclohexane).
- Coupling is nearly as large at 0° when the orbitals are in the same plane but not parallel (the situation in a *cis* alkene).
- Coupling is zero when the dihedral angle is 90° —orthogonal orbitals do not interact.
- The curve is flattened around 0° , 90° , and 180° — J varies little in these regions from compound to compound.
- The curve slopes steeply at about 60° and 120° — J varies a lot in this region with small changes of angle and from compound to compound.
- Numerical values of J vary with substitution, ring size, etc., but the Karplus relationship still works—it gives good *relative* values.

The determination of *conformation* by NMR may determine *configuration* at the same time. This often occurs when there are two or more substituents on the ring. Here is a simple example: you saw in Chapter 16 that the reduction of 4-*t*-butylcyclohexanone can be controlled by choice of reagent to give either a *cis* or a *trans* alcohol.



The products are easy to tell apart because the green H appears quite different in the NMR spectrum in the two cases. In one it is quite a fine multiplet; in the other it is much broader.

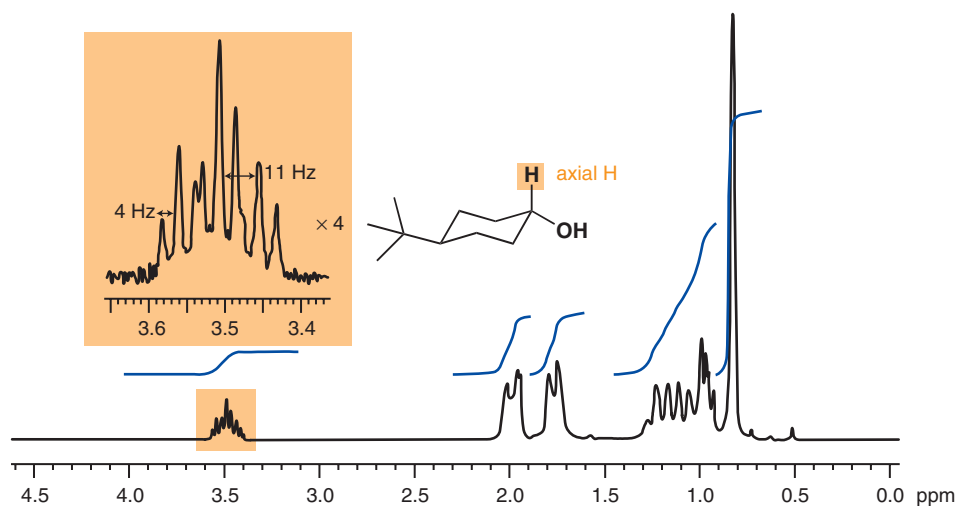
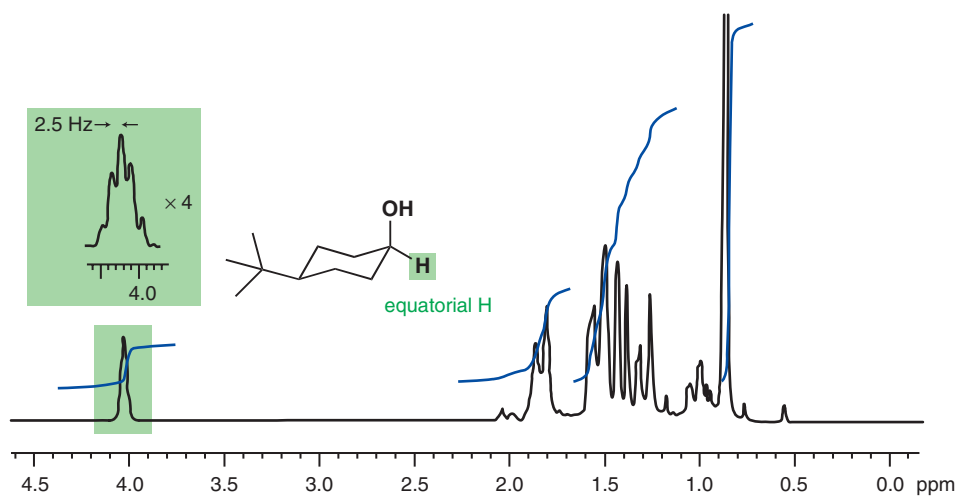

The bulky *t*-butyl group always goes equatorial, and each OH group has two identical axial neighbours and two identical equatorial neighbours (two are shown in black in the scheme at the bottom of p. 796—there are two more at the front). Each coloured H appears as a triplet of triplets. In the *cis* alcohol both couplings are small (2.72 and 3.00 Hz) but in the *trans* alcohol the axial–axial coupling is much larger (11.1 Hz) than the axial–equatorial (4.3 Hz) coupling.

The same ideas can be used to study conformation in saturated *heterocyclic* systems. Hydrogenation of the double bond in this unsaturated acetal gives the saturated compound as a single isomer. But which one? Are the two substituents, Me and OEt, *cis* or *trans*?

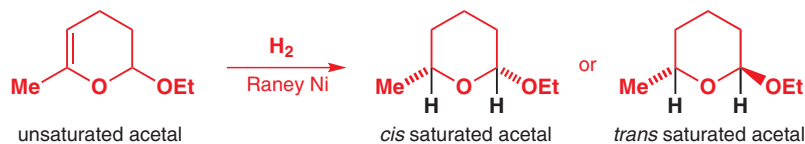

The appearance of the two black hydrogens in the NMR spectrum reveals the answer and also shows what conformation the molecule adopts. There is a 1H signal at 3.95 ppm (which is therefore next to oxygen) and it is a double quartet. It must be the hydrogen next to the methyl group because of the quartet coupling. The quartet coupling constant has the 'normal'

You can draw a general conclusion from this observation: an NMR signal is roughly as wide as the sum of all its couplings. In any given compound, an axial proton will have a much *wider* signal than an equatorial proton.

δ_{H} 3.95, 1H, dq, J 9 and 6.5 Hz
 δ_{H} 4.40, 1H, dd, J 9 and 2 Hz

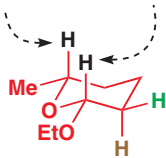

J value of 6.5 Hz. The doublet coupling is 9 Hz and this is too large to be anything other than an axial–axial coupling. This hydrogen is axial.

There is another 1H signal at 4.40 ppm (next to *two* oxygens), which is a double doublet with $J = 9$ and 2 Hz. This must also be an axial proton as it shows an axial–axial (9 Hz) and an axial–equatorial coupling. We now know the conformation of the molecule.

Both black hydrogens are axial so both substituents are equatorial. That also means in this case that they are *cis*. But note that this is because they are both on the same, upper side of the ring, not because they are both equatorial! The hydrogen at the front has two neighbours—an axial (brown) H, $J = 9$, and an equatorial (green) H, $J = 2$ Hz. All this fits the Karplus relationship as expected. You may have spotted that the H at the back appears to be missing a small coupling to its equatorial neighbour. No doubt it does couple, but that small coupling is not noticed in the eight lines of the double quartet. Small couplings can easily be overlooked.

When this compound is allowed to stand in slightly acidic ethanol it turns into an isomer. This is the *trans* compound and its NMR spectrum is again very helpful. The proton next to the methyl group is more or less the same but the proton in between the two oxygen atoms is quite different. It is at 5.29 ppm and is an unresolved signal of width about 5 Hz. In other words it has no large couplings and must be an equatorial proton. The conformation of the *trans* compound is shown in the margin.

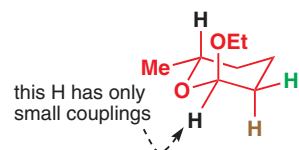

■ This switch of the OEt group from the (usually favoured) equatorial to the axial position may seem odd, but will be explained in the next section.

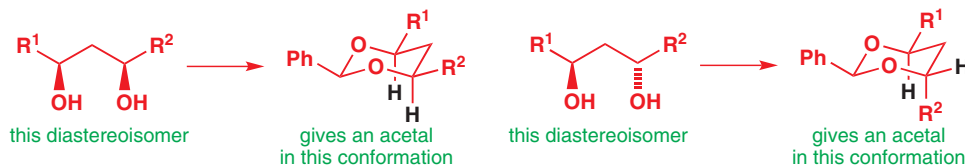
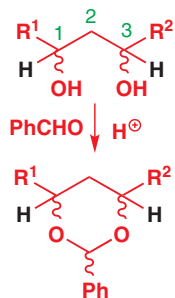

Now the molecule has a fixed conformation and the coupling constants of the black Hs to the neighbouring CH_2 group can be determined—an axial H will show one large J value, an equatorial H only small J values.

Deducing the stereochemistry of a new antibiotic

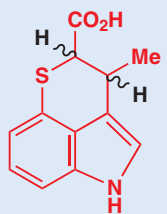

chuangxinmycin

Only fully saturated six-membered rings are really chairs or boats. Even with one double bond in the ring, the ring is partly flattened: here we will look at an even flatter example. A unique antibiotic has been discovered in China and called 'chuangxinmycin' (meaning 'a new kind of mycin' where mycin = antibiotic). It is unique because it is a sulfur-containing indole: few natural products and no other antibiotics have this sort of structure.

The structure itself was easy to elucidate, but the stereochemistry of the two black hydrogens was not so obvious. The coupling constant (3J) was 3.5 Hz. During attempts to synthesize the compound, Kozikowski hydrogenated the alkene ester below to give an undoubted *cis* product (hydrogenation is *cis* selective: see Chapter 23, p. 535).

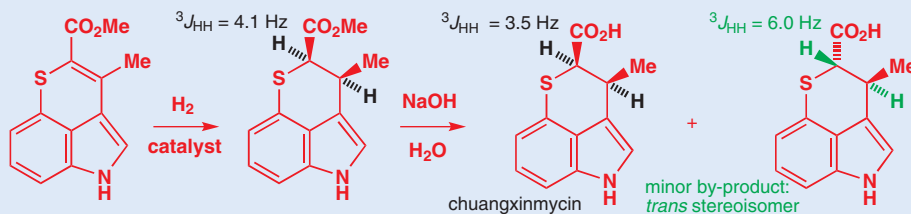

The 3J coupling between the black hydrogens in this compound was 4.1 Hz, much the same as in the antibiotic and, when the ester group was hydrolysed in aqueous base, the main product was identical to natural chuangxinmycin. However, there was a minor product, which was the *trans* isomer. It had $^3J = 6.0$ Hz. Note how much smaller this value is than the axial–axial couplings of 10 Hz or more in saturated six-membered rings. The flattening of the ring reduces the dihedral angle, reducing the size of J .

Coupling constants do not always give unambiguous information about stereochemistry, and in the next section we look at one technique which allows structural information to be extracted from NMR spectra without relying on coupling.

Determining stereochemistry when coupling constants are no help: the nuclear Overhauser effect

The coupling constant between the green protons of the compound below is rather large, at 11 Hz—about the same as the *trans* diaxial coupling in a cyclohexane. The Karplus relationship suggests the green protons must therefore spend much of their time with their bonds arranged with a dihedral angle close to 180° , and from this we can deduce that the compound has the conformation, as well as the configuration, shown. A more difficult problem is the assignment of the stereochemistry of the elimination product from this bromoamine and base. It's not a simple question, because the elimination also involves rearrangement of the amino group. The product is an alkene with two possible geometries.

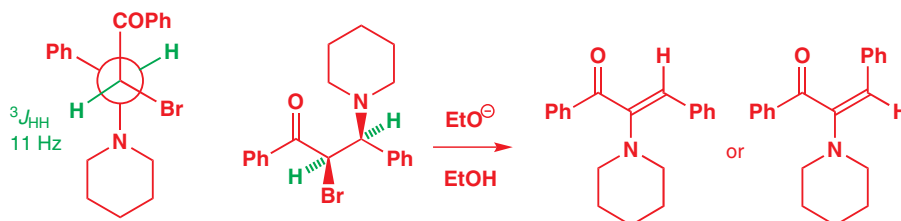

Usually we would use coupling constants to determine alkene geometry, but they are no use here as there is only one proton on the alkene: it will be a singlet in both compounds. In such cases, we can make use of a quirk of NMR known as the **nuclear Overhauser effect** (NOE). NOE is rather different from coupling in the information it provides: it tells us which hydrogens are **close in space** rather than their relationship through bonds as revealed by coupling constants.

The details of the origin of the nuclear Overhauser effect are beyond the scope of this book, but we can give you a general idea of what the effect is. As you learned in Chapters 3 and 13, when a proton NMR spectrum is acquired, a pulse of radio frequency electromagnetic radiation jolts the spins of the protons in the molecule into a higher energy state. The signal we observe is generated by those spins dropping back to their original states. So far we have assumed that the drop back down is spontaneous, just like a rock falling off a cliff. In fact it isn't—something needs to 'help' the protons to drop back again—a process called **relaxation**. And that 'something' is other nearby magnetically active nuclei—usually more protons. Notice *nearby*—nearby in space not through bonds. With protons, relaxation is always fast, and the number of nearby protons does not affect the appearance of the NMR spectrum.

Although in a normal spectrum peak intensity is independent of the number of nearby protons, by using methods whose description is beyond the scope of this book it is possible to modify the intensity of the peaks very slightly according to the number of protons that are nearby. The basis of the method is that certain protons (or groups of identical protons) are irradiated selectively (in other words, they are jolted into their high energy state and held there by a pulse of radiation at exactly the right frequency—not the broad pulse needed in a normal NMR experiment). Under the conditions of the experiment, this causes protons that were relying on those irradiated protons to relax them to appear as a slightly more intense (by maybe just a few per cent) peak in the NMR spectrum. This effect is known as the nuclear Overhauser effect, and the increase in intensity of the peak the nuclear Overhauser enhancement. Both are shortened to 'NOE'.

➔ See p. 293 for details of how to determine alkene geometry using the size of coupling constants.

Why you can't integrate ^{13}C NMR spectra

Relaxation is the real reason why you can't integrate ^{13}C signals. Relaxation of ^{13}C is slow, but is fastest with lots of nearby protons. This is the reason that you will often find that $-\text{CH}_3$ groups show strong signals in the ^{13}C NMR, while quaternary carbons, with no attached protons, show weak ones: quaternary carbons relax only slowly, so we don't detect such an intense peak. Allowing plenty of time for all ^{13}C atoms to relax between pulses gives more proportionally sized peaks, but at the expense of a very long NMR acquisition time.

All you need to be aware of at this stage is that irradiating protons in an NOE experiment gives rise to enhancements at other protons that are nearby in space—no coupling is required, and NOE is *not* a through-bond phenomenon. The effect also drops off very rapidly: the degree of enhancement is proportional to $1/r^6$ (where r is the distance between the protons) so moving two protons twice as far apart decreases the enhancement one can give to the other by a factor of 64. NOE spectra are usually presented as differences: the enhanced spectrum minus the unenhanced, so that the small enhancements of intensity in the peaks of certain protons can be spotted immediately.

Applying NOE to the problem in hand solves the structure. If the protons next to the nitrogen atom in the piperidine ring are irradiated, the signal for the alkene proton increases in intensity, so these two groups of protons must be near in space. The compound is the *E* alkene.

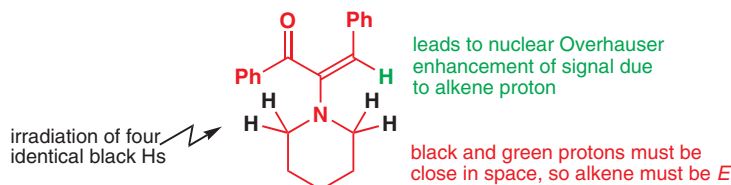

Data from NOE experiments nicely supplement information from coupling constants in the determination of three-dimensional stereochemistry too. Reduction of this bicyclic ketone with a bulky hydride reducing agent gives one diastereoisomer of the alcohol, but which? Irradiation of the proton next to the OH group leads to an NOE to the green proton. This suggests that the two protons are on the same side of the molecule and that reduction has occurred by hydride delivery to the face of the ketone opposite the two methyl groups on the three-membered ring.

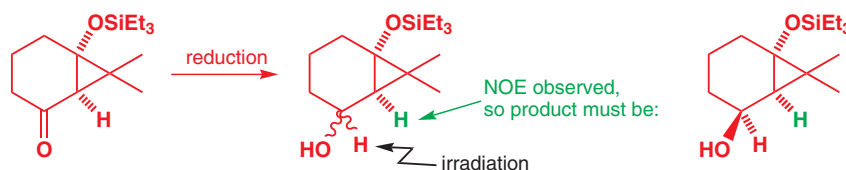

A combination of coupling constants and NOE effects is routinely used to assign the stereochemistry of reaction products.

Heteroatoms in rings have axial and equatorial lone pairs

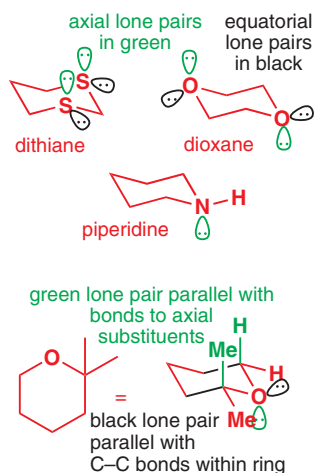

To a first approximation, the conformation of five- and six-membered saturated heterocycles follows very much the same principles as the conformation of carbocyclic compounds that we detailed in Chapter 16. For dithiane the conformation is as shown in the margin. Since the sulfur atoms have lone pairs, they too occupy axial and equatorial positions. The same is true of dioxane or of piperidine.

We have coloured the lone pairs green or black according to whether they are axial or equatorial, but you can also consider the colour coding in a different way: black lone pairs are parallel with C–C or C–heteroatom bonds in the ring; green lone pairs are parallel with axial C–H bonds outside the ring, or, if the ring has substituents, with the bonds to those substituents. This substituted tetrahydropyran illustrates all this. Notice that the equatorial substituents next to the heteroatom are parallel with neither the green nor the black lone pair.

Why is this important? There are many reactions in which lone pairs have an important role to play. For example, in an acetal hydrolysis, stabilization of the forming positive charge by an adjacent lone pair facilitates the elimination step of the mechanism. Let's consider what happens in this acetal hydrolysis where the acetal is a saturated heterocycle. From Chapter 11, you expect this to be the mechanism:



Yet when we try to draw the conformation of the lone pairs we run into a problem: neither overlaps with the C–O bond that is breaking and so neither can donate its electron density into the C–O σ^* . Another way of looking at this is to say that the intermediate oxonium ion—with a C=O double bond formed by one of the oxygen's lone pairs—would be extremely strained. Not surprisingly, the rate of hydrolysis of this acetal is very slow compared with similar ones in which overlap between the oxygen lone pair and the C–O σ^* is possible. The acetal on the right hydrolyses about 10^{10} times faster.

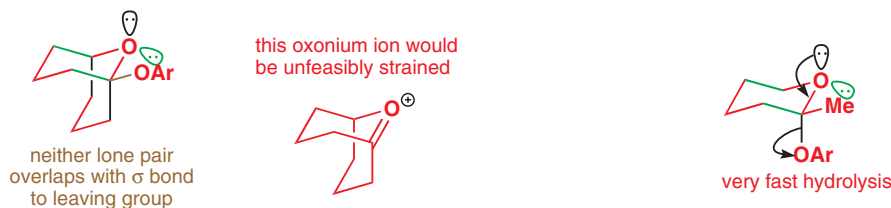

You have just seen that overlap between orbitals governs NMR coupling constants; other situations where orbital overlap is important are:

- E2 elimination reactions (Chapter 17)
- reactions of cyclic molecules (Chapter 32)
- the Felkin–Anh transition state conformation (Chapter 33)
- fragmentations and rearrangements (Chapter 36).

Together, these effects are called *stereoelectronic effects* because they all depend on the *orientation* of orbitals.

Some substituents of saturated heterocycles prefer to be axial: the anomeric effect

Many of the stereoelectronic effects in the list above govern *reactivity*, but the next section will deal with how stereoelectronic effects affect *structure*—and in particular *conformation*. Some of the most important saturated oxygen heterocycles are the sugars. Glucose is a cyclic hemiacetal—a pentasubstituted tetrahydropyran if you like—whose major conformation in solution is shown below. About two-thirds of glucose in solution exists as this stereoisomer, but hemiacetal formation and cleavage is rapid, and this is in equilibrium with a further one-third that carries the hemiacetal hydroxyl group axial (<1% is in the open-chain form).

➔ We introduced the hemiacetal structure of glucose in Chapter 6, p. 137.

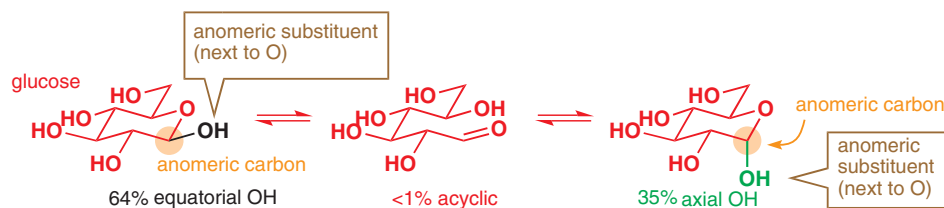

Having read Chapter 16 you will not be surprised that glucose prefers all its substituents to be equatorial. For four of them, of course, there is no choice: they are either all-equatorial or all-axial, and the only way they can get from one to the other is by ring-flipping. But for the fifth substituent, the hydroxyl group next to the ring oxygen (known as the anomeric hydroxyl group), a choice between axial or equatorial is made available by hemiacetal cleavage and re-formation—it can invert its configuration. What is perhaps surprising is that the equatorial preference of this hydroxyl group is so small—only 2:1. Even more surprising is that, for most derivatives of glucose, the anomeric substituents *prefer* to be axial rather than equatorial.

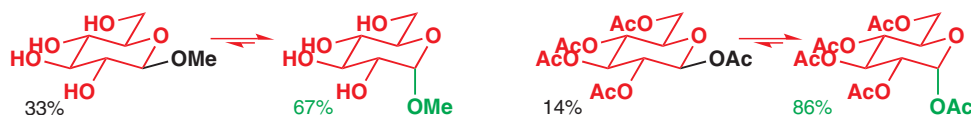

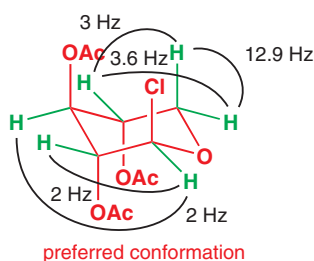
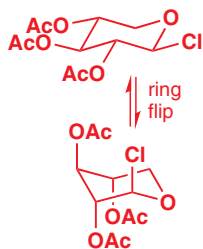
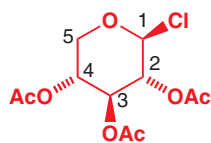

Move away from glucose and the effect is still there in other substituted tetrahydropyrans. Listed below are the NMR signals of the chloro compound in the margin. There are now only two possible conformations (no configurational changes are possible because this is not a hemiacetal)—both shown—and from the NMR spectrum you should be able to work out which one this compound has.

δ			J , Hz	
5.78	1H	t	2.0	H1
5.03	2H	m		H2, H3
4.86	1H	m		H4
4.37	1H	dd	12.9, 3.0	H5a
3.75	1H	ddd	12.9, 3.7, 0.6	H5b
2.10	9H	s		OAc \times 3

The key point is that axial–axial couplings are large (>8 Hz, say), even with adjacent electronegative atoms (which tend to lower coupling constants). So if H1 were an axial proton, you would expect it to have a large coupling to H2. But it doesn't—it couples to H2 with J of only 2.0 Hz. (The other coupling is a W-coupling to H3, also of 2.0 Hz: see p. 296.) Similarly, we know that the 12.9 Hz coupling shared by the two H5 protons must be a geminal (2J) coupling. One of H5a or H5b must be axial, yet both couple to H4 with $J < 4$ Hz, so H4 cannot be axial. With this evidence, we have to conclude that H1 and H4 (and therefore H2 and H3) are equatorial, so the compound must exist mainly in the all-equatorial conformation. (The 0.6 Hz coupling to H5b is another W-coupling, and shows that H5b is the equatorial proton and H5a therefore the axial one.) This axial preference is called the **anomeric effect**.

• The anomeric effect

In general, any tetrahydropyran bearing an electronegative substituent in the 2-position will prefer that substituent to be axial. This is known as the **anomeric effect**.

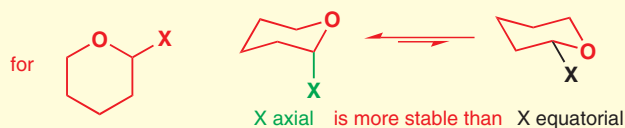

But why? This goes against all of what we said in Chapter 16 about axial substituents being more hindered, making conformations carrying axial substituents disfavoured. The key again is stereoelectronics, and we can now link up with the message we left you with at the end of the last section: elimination reactions are possible only when the orbitals involved are parallel.

An amide is more stable (less reactive) than a ketone because the p orbital of the N and the low-lying C=O π^* of the carbonyl can lie parallel—they can overlap and electron density can move from nitrogen into the C=O bond, weakening C=O. (Evidence for this comes from the lower IR stretching frequency of an amide C=O, among other things.) But C–X bonds also have low-lying antibonding orbitals—the C–X σ^* —so we would expect a molecule likewise to be stabilized if an adjacent heteroatom could donate electrons into this orbital. Take the generalized tetrahydropyran in the box above, for example, with X=Cl, say. This molecule is most stable if an oxygen lone pair can overlap with C–Cl σ^* , as shown in the margin.

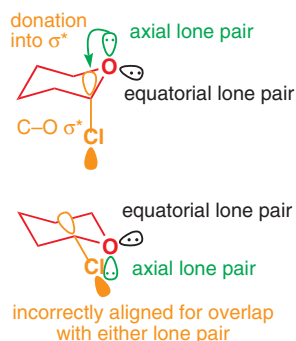

But it can do this only if the chlorine is axial! Remember what we pointed out earlier: the oxygen's equatorial lone pairs are parallel with nothing but bonds in the ring, so the oxygen's axial lone pair is the only one that can help stabilize the molecule, and it can only do this when the Cl is axial. Only the axial conformation benefits from the stabilization, and this is the origin of the anomeric effect.

How shall we represent the stabilization? Comparing again with the amide stabilization, you might think about how to represent it with curly arrows: this is straightforward with the amide and you have seen it many times. But it looks odd with our heterocycle: electron density moves

from O to Cl, and the C–Cl bond is weakened. If the process carried right on, Cl[−] would leave. This is exactly what did happen in the acetal we presented you with as an example on p. 801: only the axial OAr could leave, however, because of the same requirement for overlap with an oxygen lone pair. In the real structure that we are now looking at, the Cl is still there: the C–Cl bond is weaker, and some of the oxygen's electron density is delocalized on to Cl. This can be seen in crystal structures: compounds exhibiting an anomeric effect have a longer (and therefore weakened) bond outside the ring and a shorter, stronger C–O bond within the ring.

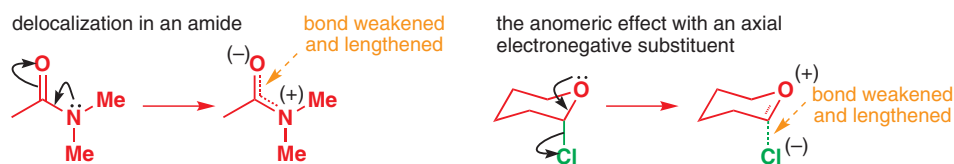

The anomeric effect in spiroketals

Now that you know about the anomeric effect, you should add it to your mental array of possible ways to explain 'unexpected' results. Here is an example. Many fruit flies have pheromones based around a 'spiroketal' structure, which we could represent without stereochemistry as shown below. You can imagine the spiroketal (that is, an acetal of a ketone made of two rings joined at a single atom) being made from a dihydroxyketone—and, indeed, this is very often how they are made synthetically. But this is a bad representation because these compounds do have stereochemistry, and the stereochemistry is very interesting.

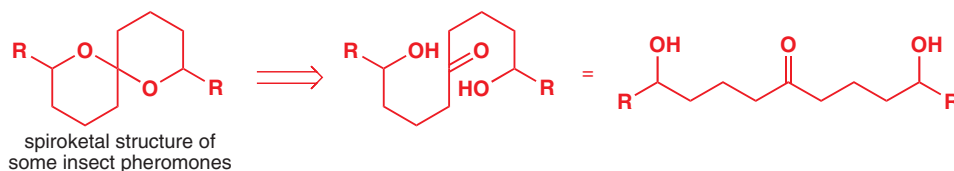

Let's start with the simplest example, with R=H (a pheromone of the olive fly). Once you have drawn one ring in its chair conformation, there are three ways of attaching the other ring, shown here. If you think they all look the same, consider the orientation of each C–O bond with respect to the ring that it is not part of: you can have each C–O axial or equatorial, and there are three possible arrangements (three conformations).

of the three conformations of the spiroketal...

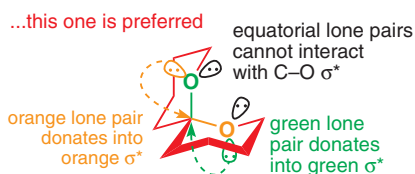
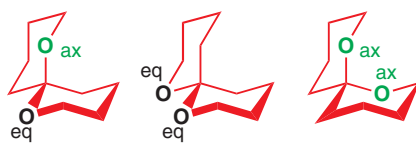

Without knowing about the anomeric effect, you would find it hard to predict which conformation is favoured, and, indeed, you might expect to get a mixture of all three. But NMR tells us that this compound exists entirely in one conformation: the last one here, in which each oxygen is axial on the other ring. Only in this conformation can both C–O bonds benefit from an anomeric effect—this is often known as the **double anomeric effect**.

Related effects in other types of compounds

The key requirement for the anomeric effect is that there is a heteroatom with a lone pair (O, N, S usually) adjacent to (that is, in a position to interact with) a low-lying antibonding orbital—usually a C–X σ^* (where X=halogen or O). The C–X bond doesn't have to be within the ring—for example, the nitrogen heterocycle on the left prefers to have the R group axial so that the nitrogen gets an equatorial lone pair. Equatorial lone pairs are parallel with bonds within the ring, one of which is C–O, and this conformation is therefore stabilized by an N lone pair/C–O σ^* interaction.

■ This is a chiral compound, even though the acetal centre is not a chiral centre: no conformation has a plane of symmetry.

Hint on drawing spiroacetals

If you try to draw these spirocyclic acetals you will soon find there is a trick to getting them to look right: the *spiro* carbon has to be one of the four that aren't at the 'point' of either ring; otherwise one ring ends up looking flat.

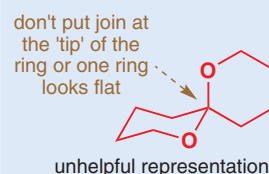

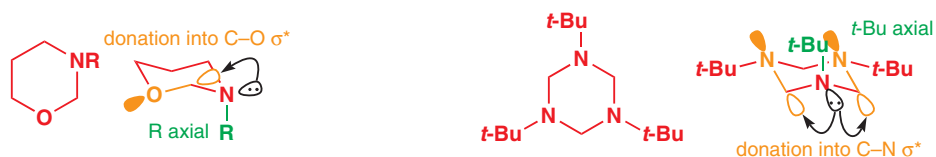

It would be a bit much for the 1,3,5-triazine on the right to have all three *t*-butyl groups axial (too much steric hindrance), but it can get away with having one of them axial, benefitting from the resulting equatorial lone pair, which can overlap with two C–N σ^* s in the ring.

It's not only in six-membered rings that stereoelectronic interactions between filled and unfilled orbitals stabilize some conformations more than others. Stereoelectronic effects control the conformations of many types of molecules.

- Any conformation in which a lone pair is *anti*-periplanar to a low-energy antibonding orbital will be stabilized by a stereoelectronic interaction.

We shall look at three common compounds that are stabilized by stereoelectronic effects: in two cases, the stabilization is specific to one conformation, and we can use stereoelectronics to explain what would otherwise be an unexpected result.

We start with a compound that is so simple that it has only one conformation because it has no rotatable bonds: dichloromethane. You may have wondered why it is that, while methyl chloride (chloromethane) is a reactive electrophile that takes part readily in substitution reactions, dichloromethane is so unreactive that it can be used as a solvent in which substitution reactions of other alkyl halides take place. You may think that this is a steric effect: indeed, Cl is bigger than H. But CH_2Cl_2 is much less reactive as an electrophile than ethyl chloride or propyl chloride: there must be more to its unreactivity. And there is: dichloromethane benefits from a sort of 'permanent anomeric effect'. One lone pair of each chlorine is always *anti*-periplanar to the other C–Cl bond so that there is always stabilization from this effect.

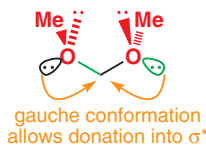
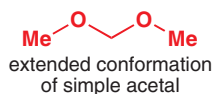
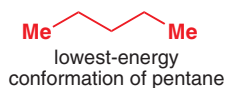
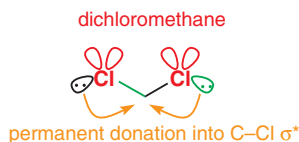

➡ Terms used to describe conformations (*gauche*, *synclinal* etc.) are defined on p. 365.

Among the most widespread classes of acyclic compounds to exhibit stereoelectronic control over conformation are acetals. Take the simple acetal of formaldehyde and methanol, for example: what is its conformation? An obvious suggestion is to draw it fully extended so that every group is fully *anti*-periplanar to every other—this would be the lowest energy conformation of pentane, which you get if you just replace the Os with CH_2 s.

The trouble is, in this conformation none of the oxygen lone pairs get the chance to donate into the C–O σ^* orbitals. Although putting the bonds *anti*-periplanar to one another makes steric sense, electronically, the molecule much prefers to put the lone pairs *anti*-periplanar to the C–O bonds, so the bonds themselves end up *gauche* (*synclinal*) to one another. This is known as the *gauche* effect, but is really just another way in which the stereoelectronic effects that give rise to the anomeric effect turn up in acyclic systems.

Finally, an even more familiar example that you may never have thought about. You are well aware now that amides are planar, with partially double C–N bonds, and that tertiary amides have one alkyl group *cis* to oxygen and one *trans*. But what about esters? Esters are less reactive than acyl chlorides because of donation from the oxygen p orbital into the carbonyl π^* , so we expect them to be planar too, and they are. But there are two possible planar conformations for an ester: one with R *cis* to oxygen and one with R *trans*. Which is preferred?

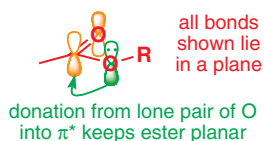

Here are the two conformations drawn out for ethyl acetate. When the ethyl group (= R) and O are *cis*, not only can one oxygen lone pair interact with the C=O π^* , but the other lone pair can also donate into the σ^* of the C=O bond. This is not possible when Et and O are *trans*: they are no longer anti-periplanar. The *cis* conformation of esters is generally the preferred one, even in formate esters, where the alkyl group ends up in what is clearly a more sterically hindered orientation.

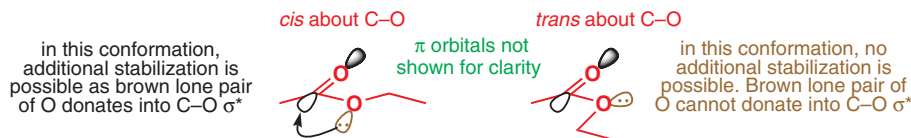

Cyclic esters—lactones—cannot lie *cis* because of the ring, and this is one of the reasons why lactones are distinctly more reactive than esters and in many reactions behave more like ketones: lactones are quite easy to reduce with NaBH_4 , for example.

more reactive *trans* arrangement enforced by ring

Making heterocycles: ring-closing reactions

We have talked about the structure of saturated heterocycles, particularly with regard to stereoelectronic control over conformation, and before that we looked at some of their reactions. We will now look at how to *make* them. By far the most important way of making them is by ring-closing reactions because we can usually use the heteroatom as the nucleophile in an intramolecular substitution or addition reaction. Ring-closing reactions are, of course, just the opposite of the ring-opening reactions we talked about earlier in the chapter, and we can start with a reaction that works well in both directions: ring closure to form an epoxide. You know well that epoxides can be formed using *m*-CPBA and an alkene, but you have already seen examples where they form by an intramolecular substitution reaction such as this.

→ *m*-CPBA epoxidation is discussed in Chapter 19, p. 429.

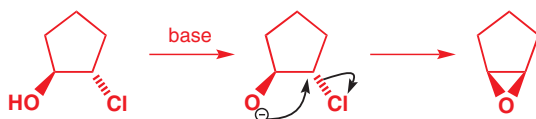

The same method can also be used to generate larger cyclic ethers. Oxetane, for example, is conveniently made by adding 3-chloropropyl acetate to hot potassium hydroxide. The first step in this reaction is the hydrolysis of the ester. The alkoxide produced then undergoes an intramolecular substitution reaction to yield oxetane.

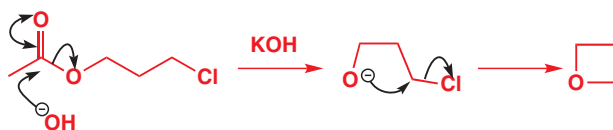

Tetrahydropyran was prepared as early as 1890 by a ring closure that occurs when a mixture of 1,5-pentanediol with sulfuric acid is heated.

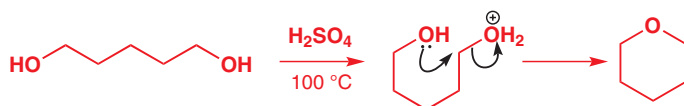

These are all $\text{S}_{\text{N}}2$ reactions, so you will not be surprised that nitrogen heterocycles can be prepared in the same way. Aziridine itself, for example, was first prepared in 1888 from 2-chloroethylamine. Related reactions can be used to form three-, five-, and six-membered nitrogen heterocycles, but fail to form four-membered rings. In fact, four-membered rings are generally among the hardest of all to form.

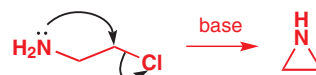

To illustrate this, the green columns of the table below show the rates (relative to six-membered ring formation = 1) at which bromoamines of various chain lengths cyclize to saturated nitrogen heterocycles of three to seven members.

Ring size	Product ⁹	Relative rate ^a	Product ^b	Relative rate ^a	Assessment of rate
3		0.07			moderate
4		0.0001		0.58	slow
5		100		833	very fast
6		1		1	fast
7		0.002		0.0087	slow
8				0.00015	very slow

^aRelative to six-membered ring formation; ^bE = CO₂Et

At first sight it may seem that these rates have been produced by a random number generator! There seems to be no rhyme or reason to them, and no consistent trend. To convince you that these numbers mean something, the table also shows, in the orange columns, the relative rates for another ring-closing reaction, this time forming four- to seven-membered rings that are not even heterocycles by intramolecular alkylation of a substituted malonate. Although the numbers are quite different in the two cases, the ups and downs are the same, and the final column summarizes the relative rates. Put another way, a rough guide (only rough—it doesn't work in all cases) to the rate of ring formation is this.

● **Rough guide to the rate of formation of saturated rings**

Fastest 5 > 6 > 3 > 7 > 4 > 8–10 slowest

■ Remind yourself of our definition of small, normal, medium, and large rings, and what ring strain means, by re-reading p. 366. We will deal with what happens in large rings a little later.

We show the numbers in colour to highlight the fact that this seemingly illogical ordering of numbers actually conceals two superimposed trends. Once you get to five-membered rings, the rate of formation drops consistently as the ring size moves from 'normal' (5 and 6) to 'medium' (8 to 13) sized rings. 'Small' (3 and 4) rings insert into the sequence after 6.

The reason for the two superimposed trends is two opposing factors. Firstly, small rings form slowly because forming them introduces ring strain. This ring strain is there even at the transition state, raising its energy and slowing down the reaction. The activation energy for forming

a three-membered ring is very high, due to strain, but decreases as the ring gets larger. This explains why three- and four-membered rings don't fit straightforwardly into the sequence.

But if the reaction rate simply depended on the strain of the product, the slowest reaction would be the formation of the three-membered ring, and six-membered rings (which are essentially strain-free) would form fastest. Yet the data shows that four-membered rings form more slowly than three-membered ones, and five-membered ones faster than six-membered ones. To explain this, we need to remind you of an equation we presented in Chapter 12.

$$\Delta G^\ddagger = \Delta H^\ddagger - T\Delta S^\ddagger$$

The activation energy barriers ΔG^\ddagger of our reactions are made up of two parts: an enthalpy of activation ΔH^\ddagger , which tells us about the energy required to bring atoms together against the strain and repulsive forces they usually have, and an entropy of activation ΔS^\ddagger , which tells us about how easy it is to form an ordered transition state from a wriggling and randomly rotating molecule.

ΔG^\ddagger for three- and four-membered ring formation is large because ΔH^\ddagger is large: energy is needed to bend the molecule into the strained small-ring conformation. ΔH^\ddagger for five-, six-, and seven-membered rings is smaller: this is the quantifiable representation of the 'ring strain' factor we have just introduced. The second factor is one that depends on ΔS^\ddagger : how much order must be imposed on the molecule to get it to react. Think of it this way: a long chain has a lot of disorder, and to get its ends to meet up and react means it has to give up a lot of freedom. So, for the formation of medium and large rings, ΔS^\ddagger is large and negative, contributing to a large ΔG^\ddagger and slow reactions. For three-membered rings, on the other hand, the reacting atoms are already very close together and almost no order needs to be imposed on the molecule to get it to cyclize: rotation about just one bond is all that is needed to ensure that the amine group is in the perfect position to attack the σ^* of the C–Br bond in our example above. ΔS^\ddagger is very small for three-membered rings so, while ΔH^\ddagger is large, there is little additional contribution from the $T\Delta S^\ddagger$ term and cyclization is relatively fast. Four-membered rings suffer the worst of both worlds: forming a four-membered ring introduces ring strain (ΔH^\ddagger) and requires order (ΔS^\ddagger) to be imposed on the molecule. They form very slowly as a result.

ring size 5–7

many possible conformations

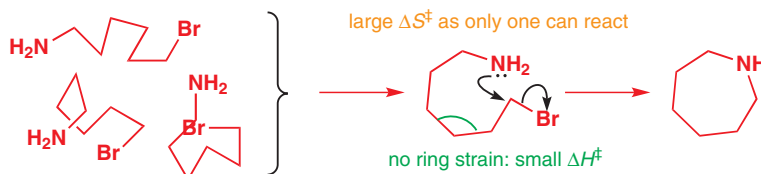

ring size 3 or 4

few possible conformations

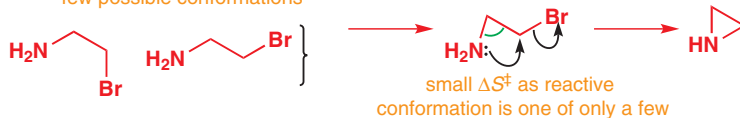

These results are summarized in the following box.

● Ring formation

- Three-membered ring formation is fast—the product is strained so ΔH^\ddagger is large but this is offset by the reacting atoms being as close as they can get in a freely rotating chain.
- Four-membered rings form slowly—the product is still significantly strained but the reacting atoms are now not right next to each other to offset this.
- Five-membered ring formation is often fastest of all. Significantly less strain and the ends are still not too far apart.
- Six-membered ring formation experiences no strain but neither does it have the advantage of the ends being close.
- Seven-membered rings and beyond form more slowly as ΔS^\ddagger increases.

Medium and large rings

Beyond seven-membered rings, the rates of ring formation stay low but begin to level off, and may start to rise again when the rings have 10 or 11 members. These are the 'medium rings', of about 8–13 members, and they suffer from a different sort of strain, evident in the graph on p. 368 (Chapter 16), due to interactions across the ring (transannular interactions). These are worst for rings of 8 and 9 members, and begin to be relieved once there are 10 or 11 atoms in the ring. For 14-membered rings and above, there is no transannular strain, and the rates of ring closure remain essentially constant at about the seven-membered ring mark. Rates of reactions in ring sizes of 14 and above are essentially little different from those in acyclic compounds. To get large rings to form, it is often necessary to carry out the cyclization reaction in very dilute solution to discourage competing intermolecular reactions.

transannular interactions hinder medium-ring formation

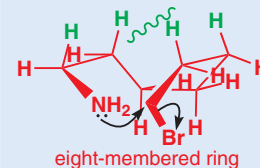

Thermodynamic control over ring size

In this section we have discussed the rate at which rings form: in other words the kinetics of ring formation. However, there are many ring-forming reactions that are under thermodynamic and not kinetic control. For example, you have already seen that glucose exists predominantly as a six-membered ring in solution. It could also exist as a five-membered ring: it doesn't because although five-membered rings form faster than six-membered ones, they are usually less stable (remember, a six-membered ring is essentially strain-free). For similar thermodynamic reasons, it doesn't exist as a seven-membered ring, even though you can draw a reasonable structure for it.

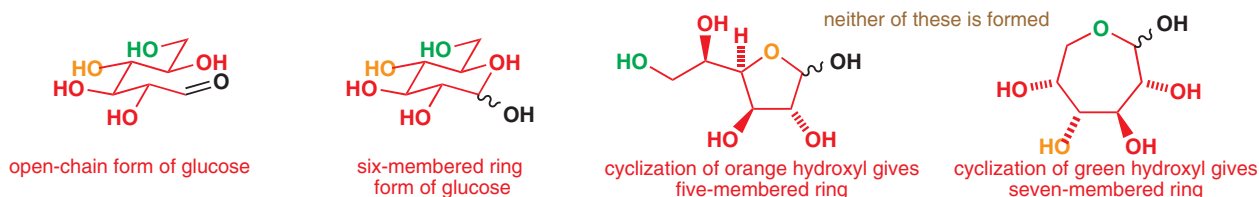

Thermodynamic control is important in other ways in carbohydrate chemistry because control over ring size allows selective protection of the hydroxyl groups of sugars. Compare these two reactions. Both of them give acetals from the same starting material, mannitol.

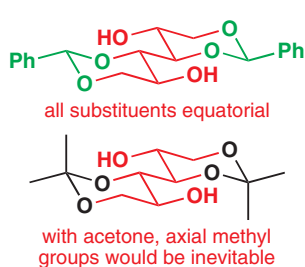
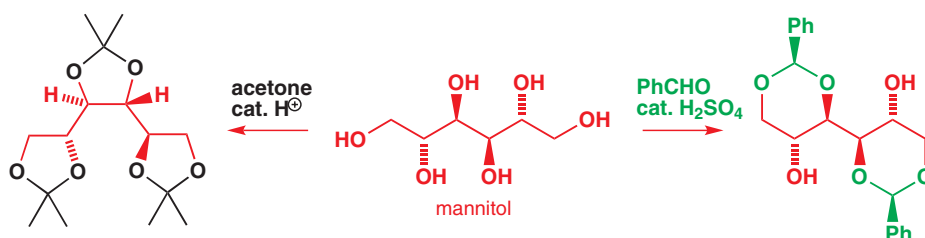

Don't be put off by the way in which we have had to twist half the molecule round to draw the left-hand structure: the stereochemistry hasn't changed. The important thing is that acetone reacts with mannitol to form three five-membered acetals (dioxolanes) while benzaldehyde forms only two six-membered acetals. This is quite a common result: when there is a choice, acetone prefers to react across a 1,2-diol to give a five-membered acetal, while aldehydes prefer to react across a 1,3-diol to form a six-membered acetal. Drawing a conformational diagram of the product on the right helps to explain why. All of the substituents are equatorial, making this a particularly stable structure. Now imagine what would happen if acetone formed this type of six-membered ring acetal. There would always be an axial methyl group, and the six-membered rings would be less stable.

Combatting ΔS^\ddagger —the Thorpe–Ingold effect

The rate of ring formation is affected not just by ring size but by substituents on the ring being formed. Compare the following relative rates (k_{rel}) for epoxide-forming cyclization reactions. The second looks as though it suffers more steric hindrance but nonetheless it is tens of thousands of times faster!



Adding substituents to other ring-forming reactions makes them go faster too: in the next two examples the products are oxetanes and pyrrolidines.

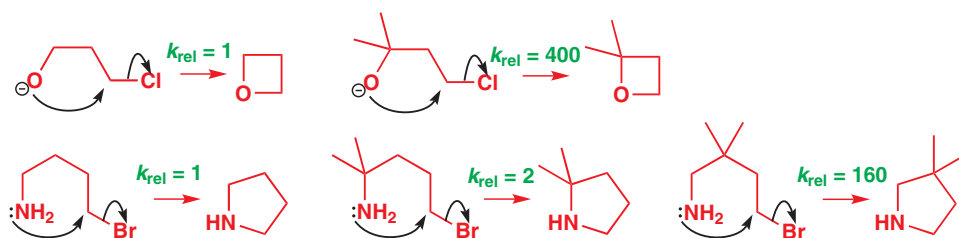

This effect is quite general, and is known as the Thorpe–Ingold effect after the first chemists to note its existence, in 1915.

● The Thorpe–Ingold effect

The Thorpe–Ingold effect is the way in which substituents on the ring increase the rate, or equilibrium constant, for ring-forming reactions.

As the box says, it's not only rate that can be affected by additional substitution. Here are the relative equilibrium constants for the formation of an anhydride from a 1,4-dicarboxylic acid (the unsubstituted acid is called succinic acid, and the values are scaled so that K_{rel} for the formation of succinic anhydride is 1). More substituents mean more cyclized product at equilibrium. The Thorpe–Ingold effect is both a kinetic and a thermodynamic phenomenon.

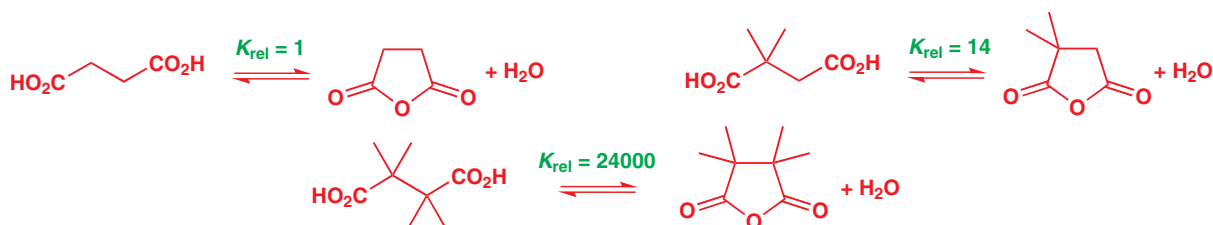

Now we need to explain why this is. The explanation comes in two parts, one of which may be more important than the other, depending on the ring being formed. The first part is more applicable to the formation of small rings, such as the first example we gave you.

If you measure the bond angles of chains of carbon atoms, you expect them to be close to the tetrahedral angle, 109.5° . The crystal structure of the 1,3-dicarboxylic acid in the margin, for example, shows a C–C–C bond angle of 110° . Now imagine adding substituents to the chain. They will repel the carbon atoms already there, and force them a little closer than they were, making the bond angle slightly less. X-ray crystallography tells us that adding two methyl groups to our 1,3-dicarboxylic acid decreases the bond angle by about 4° .

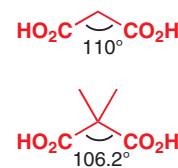

We can assume that the same is true in the alcohol starting materials for the epoxide-forming reactions on p. 808 (we can't measure the angle directly because the compounds aren't crystalline). Now consider what happens when both of these alcohols form an epoxide. The bond angle has to become about 60° , which involves about 50° of strain for the first diacid, but only 46° for the second. By distorting the starting material, the methyl groups have made it slightly easier to form a ring.

This part of the argument works only for small rings. For larger rings, we need another explanation, and it involves entropy. We'll use the pyrrolidine-forming reaction as an example. We have explained the effect of ΔS^\ddagger (entropy of activation) on the rate of ring formation: as larger rings form they have to lose more entropy at the transition state, and this contributes to a less favourable ΔG^\ddagger .



But, when the starting material has more substituents, it starts off with less entropy anyway. More substituents mean that some conformations are no longer accessible to the starting material—the green arcs on the structures on the right above show how the methyl groups hinder rotation of the N and CH₂Br substituents into that region of space. Of those fewer conformations, many approximate to the conformation in the transition state, and moving from starting material to transition state involves a smaller loss of entropy: ΔS^\ddagger is less negative so $\Delta G^\ddagger (= \Delta H^\ddagger - T\Delta S^\ddagger)$ is more negative and the ring forms faster. The same arguments apply to ΔS for the reaction as a whole (the difference in entropy between starting material and products), so increased substitution favours ring closure even under thermodynamic control.

Baldwin's rules

Nearly all of the cyclization reactions that we have discussed have been intramolecular S_N2 reactions where one end of the molecule acted as the nucleophile displacing the leaving group on the other end. We kept to this sort of reaction in order to make valid comparisons between different ring sizes. But you can imagine making saturated heterocycles in plenty of other ways—intramolecular substitution at a carbonyl group, for example, such as happens in this lactonization reaction, or intramolecular addition of an oxyanion on to an alkyne.

➔ You saw a related alkyne addition in Chapter 27, p. 683.

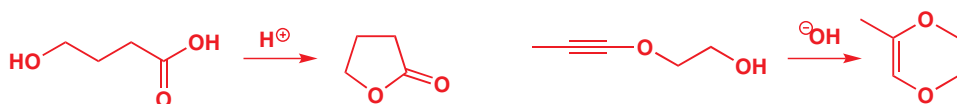

Cyclization reactions can be classified by a simple system involving: (1) the ring size being formed, (2) whether the bond that breaks as the ring forms is inside (*endo*) or outside (*exo*) the new ring, and (3) whether the electrophile is an sp (digonal), sp² (trigonal), or sp³ (tetrahedral) atom. This system places three of the cyclizations just shown in the following classes.

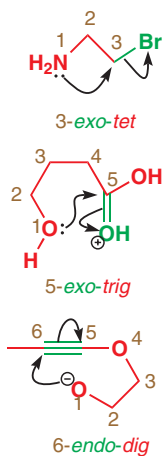

1. The ring being formed has three members; the breaking C–Br bond is outside the new ring (*exo*); the C carrying Br is a tetrahedral (sp³) atom (*tet*).
2. The ring being formed has five members; the breaking C=O bond is outside the new ring (*exo*); the C being attacked is a trigonal (sp²) atom (*trig*).
3. The ring being formed has six members; the breaking C≡C bond is inside the new ring (*endo*); the C being attacked is a digonal (sp) atom (*dig*).

The classes of cyclization reactions are important, not because we have a compulsive Victorian desire to classify everything, but because which class a reaction falls into determines whether or not it is likely to work. Not all cyclizations are successful, even though they may look fine on paper! The guidelines that describe which reactions will work are known as *Baldwin's rules*: empirical observations backed up by some sound stereoelectronic reasoning. Reactions can be classified according to these rules as 'favoured' and 'disfavoured'. We will deal with the rules step by step and then summarize them in a table at the end.

Firstly, and not surprisingly (because we have been talking about them for much of this chapter):

- all *exo-tet* cyclizations are favoured

and, similarly (again you can find many examples in this book):

- all *exo-trig* cyclizations are favoured

Interactive examples of Baldwin's rules

Despite the variation in rate we have described for this type of reaction, *exo-tet* cyclizations have no stereoelectronic problems: the lone pair and the C–X σ^* (X is the leaving group) can overlap successfully irrespective of ring size. The ring closures in the table on p. 809 all fall into this category. The same is true for *exo-trig* reactions: it is easy for the nucleophilic lone pair to overlap with the C=X π^* to form a new bond. Examples include lactone formation such as the one on p. 810.

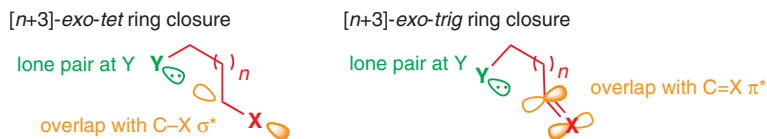

Endo-tet reactions are rather different. For a start:

● 5 and 6-*endo-tet* are disfavoured.

Endo-tet reactions would not actually make a ring, but they fall conveniently into the system and we will look at them here. Here is a reaction that looks as though it contradicts what we have just said. The arrows in the reasonable-looking mechanism on the right describe a 6-*endo-tet* process because the breaking Me–O bond is within the six-membered ring transition state (even if no ring is formed).

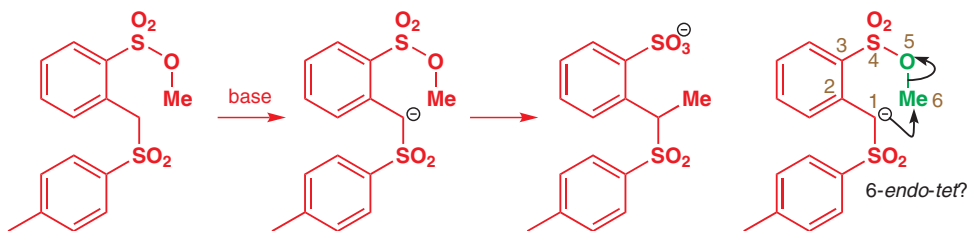

But Eschenmoser showed that, for all its appeal (intramolecular reactions usually outpace all alternatives), this mechanism is wrong. He mixed together the starting material for the reaction above with the hexadeuterated compound shown below, and re-ran the reaction. If the reaction had been intramolecular, the products would have contained either no deuterium, or six deuteriums. In the event, the product mixture contained about 25% of each of these compounds, with a further 50% containing three deuteriums. The products cannot have been formed intramolecularly, and this distribution is exactly what would be expected from an *intermolecular* reaction.

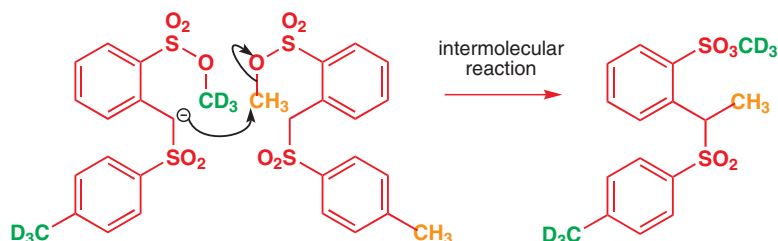

With *endo-trig* reactions, whether they work or not depends on the ring size.

● 3-, 4-, and 5-*endo-trig* are disfavoured; 6 and 7-*endo-trig* are favoured.

The most important case in the *endo-trig* class is the disfavoured 5-*endo-trig* reaction and, if there is one message you take away from this section, it should be that 5-*endo-trig* reactions are disfavoured. The reason we say this is that 5-*endo-trig* cyclizations are reactions that look perfectly fine on paper, and at first sight it seems quite surprising that they won't work. This intramolecular conjugate addition, for example, appears to be a reasonable way of making a substituted pyrrolidine.

Professor Sir Jack Baldwin worked in Oxford and adumbrated his Rules in 1976 while at the Massachusetts Institute of Technology. He has studied biosynthesis (the way living things make molecules) extensively, especially in relation to the penicillins, and has applied many biosynthetic ideas to laboratory synthetic problems. Baldwin's rules differ in a fundamental way from the Woodward–Hoffmann rules you will meet in Chapters 34 and 35.

The Woodward–Hoffmann rules were deduced from theory, and examples were gradually discovered that fitted them. They cannot be violated: a 'forbidden' reaction that appears to disobey the Woodward–Hoffmann rules is getting around them by following a different mechanism. Baldwin's rules were formulated by making observations of reactions that do, or do not, work. This is why they are couched in terms of 'favoured' and 'disfavoured' reactions, rather than 'allowed' and 'forbidden' ones.

■ This is a *crossover experiment*. See Chapter 39, p. 1038.

■ Amines are usually good at undergoing conjugate addition to unsaturated esters: see Chapter 22.

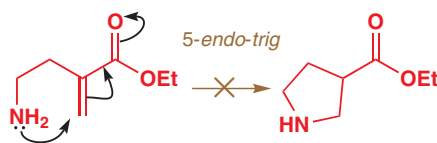

But this reaction doesn't happen: instead, the amine attacks the carbonyl group in a (favoured) 5-*exo-trig* cyclization.

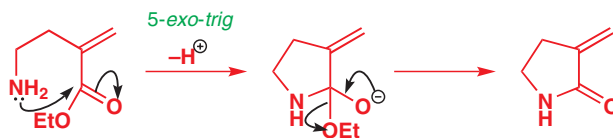

Why is 5-*endo-trig* so bad? The problem is that the nitrogen's lone pair has problems reaching round to the π^* orbital of the Michael acceptor. There is no problem reaching as far as the electrophilic carbon in the plane of the substituents but, if it bends out of this plane, which it must if it is to overlap with the π^* orbitals, it moves too far away from the methylene carbon to react. It's like a dog chained just out of reach of a bone.

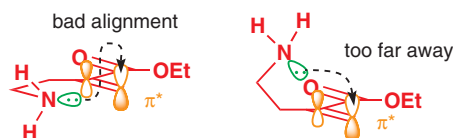

Lengthen the chain, though, and the dog gets his dinner. Here's a perfectly straightforward 6-*endo-trig*, for which orbital overlap presents no problem.

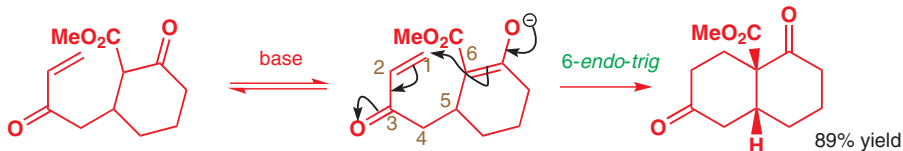

Interactive mechanism for 5-*endo-trig* vs 5-*exo-trig*

■ It's easier to see this with a model, and if you have a set of molecular models you should make one to see for yourself.

Interactive mechanism for 6-*endo-trig* cyclization

Exceptions to Baldwin's rules

Baldwin's rules are only guidelines and, when a reaction is thermodynamically very favourable (Baldwin's rules, of course, describe the *kinetic* favourability of a reaction) and there is no other possible pathway, 5-*endo-trig* reactions *can* take place. The most striking example is one that you met quite early on in this book (Chapter

11): the formation of a cyclic acetal (dioxolane) from a carbonyl compound and ethylene glycol. We don't need to give again the full mechanism here, but you should check that you can still write it. The key step with regard to Baldwin's rules is shown with a green arrow. It's a 5-*endo-trig* reaction but it works!

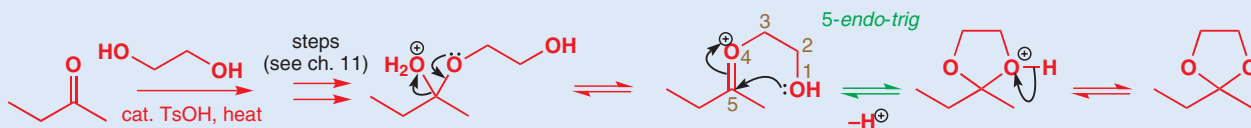

In fact, cations frequently disobey Baldwin's rules. Other well-defined exceptions to Baldwin's rules include pericyclic reactions (Chapters 34 and 35) and reactions in which second-row atoms such as sulfur are included in the ring.

This 5-*endo-trig* reaction, the sulfur analogue of the amine cyclization that didn't work, is fine. C–S bonds are long, and the empty 3d orbitals of sulfur may play a role by providing an initial interaction with the C–C π orbital.

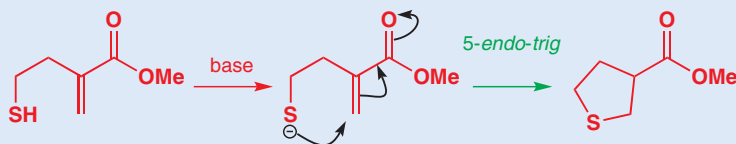

With *tet* and *trig* cyclizations, *exo* is better than *endo*; with *dig* cyclizations, the reverse is true.

● All *endo-dig* cyclizations are favoured.

Move from 5-*endo-trig* to 5-*endo-dig*, and the reactions become much easier: even 4-*endo-dig* reactions work. Here is an example of 5-*endo-dig*.

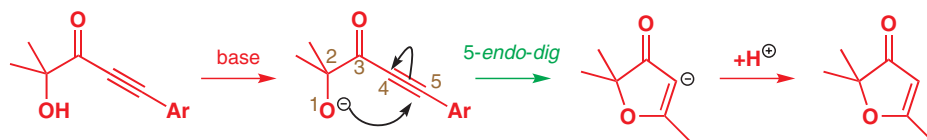

We warned you to look out for 5-*endo-trig* reactions because they are disfavoured even though on paper they look fine. Now the alert is the other way round! We expect you'd agree that these *endo-dig* reactions look awful on paper: the linear alkyne seems to put the electrophilic carbon well out of reach of the nucleophile, even further away than in the 5-*endo-trig* reaction. The important thing with *endo-dig* cyclizations, though, is that the alkyne has two π^* orbitals, one of which must always lie in the plane of the new ring, making it much easier for the nucleophile to get at.

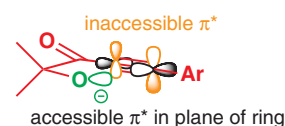

● 3 and 4-*exo-dig* are disfavoured; 5 to 7-*exo-dig* are favoured.

These reactions are less important and we will not discuss them in detail.

Baldwin's rules and ring opening

Baldwin's rules work because they are based on whether or not orbital overlap can be readily achieved in the conformation required at the transition state. But the transition state is the same whether the reaction is going forwards or backwards—the *principle of microscopic reversibility* (which is discussed further in Chapter 39) says that, if a reaction goes via a certain mechanism, the reverse reaction must follow exactly the same path in the opposite direction. So Baldwin's rules also apply to ring-opening reactions. This is where the unfavourability of 5-*endo-trig* really is important: this tetrahydrofuran-2-yl ester, for example, looks set up to do an E1cB elimination in base. Indeed, when it is treated with methoxide in deuterated methanol it exchanges the proton α to the ester for deuterium, proving that the enolate forms. But it does not eliminate: elimination would be a reverse 5-*endo-trig* process and is disfavoured.

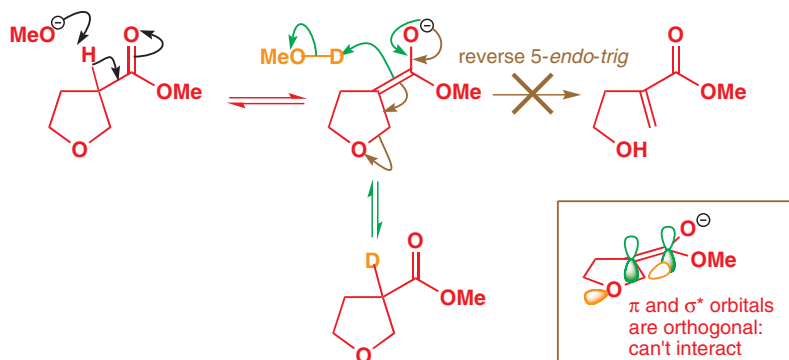

Whenever you think about a ring-opening reaction, consider its reverse, and assess whether it is favoured according to Baldwin's rules.

Baldwin's rules can be summarized in a chart. You should note the general outline of this chart: commit to memory that, broadly speaking, *endo-tet* and *endo-trig* are disfavoured; *exo-tet* and *exo-trig* are favoured, and the reverse for *dig*. Then you just need to learn the cut-off points that indicate the exceptions to this broad-brush view: 6-*endo-trig* falls into the favoured category while 4-*exo-dig* falls into the disfavoured one. And, if you really can remember only one thing, it should be that 5-*endo-trig* is disfavoured!

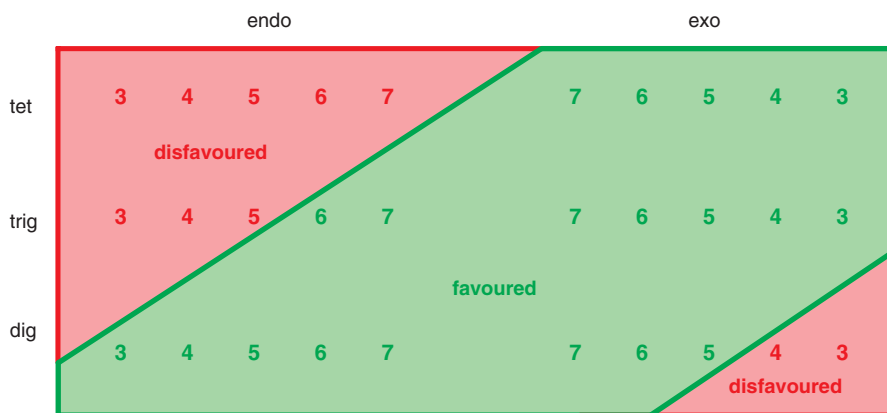

Ring size and NMR

On p. 796 we considered the effect of changes in the dihedral angle on coupling constants. But the dihedral angle is not the only angle worth measuring; we should also consider how the two C–H bonds are spread out in space. The dihedral angle is what we see when we look down the spine of the book in our earlier analogy—now we want to look at the pages in the normal way, at right angles to the spine, as if we were going to read the book. We can show what we mean by fixing the dihedral angle at 0° (the C–H bonds are in the same plane) and looking at the variation of J with the ring size of some simple cyclic alkenes.

■ The angles shown are calculated assuming the structures are regular planar polygons, and the coupling constants J are given in Hz.

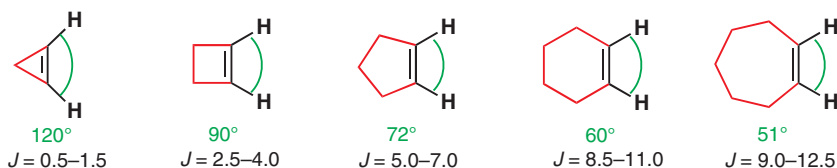

The wider apart the hydrogens are spread, the smaller the coupling constant. Remember, the dihedral angle stays the same (0°)—we are just varying the angle in the plane. A dramatic illustration of this comes with the product of dehydrogenation of the natural product guaïol with elemental sulfur. From the brown, smelly reaction mixture, guaiazulene, a deep blue oil, can be distilled.

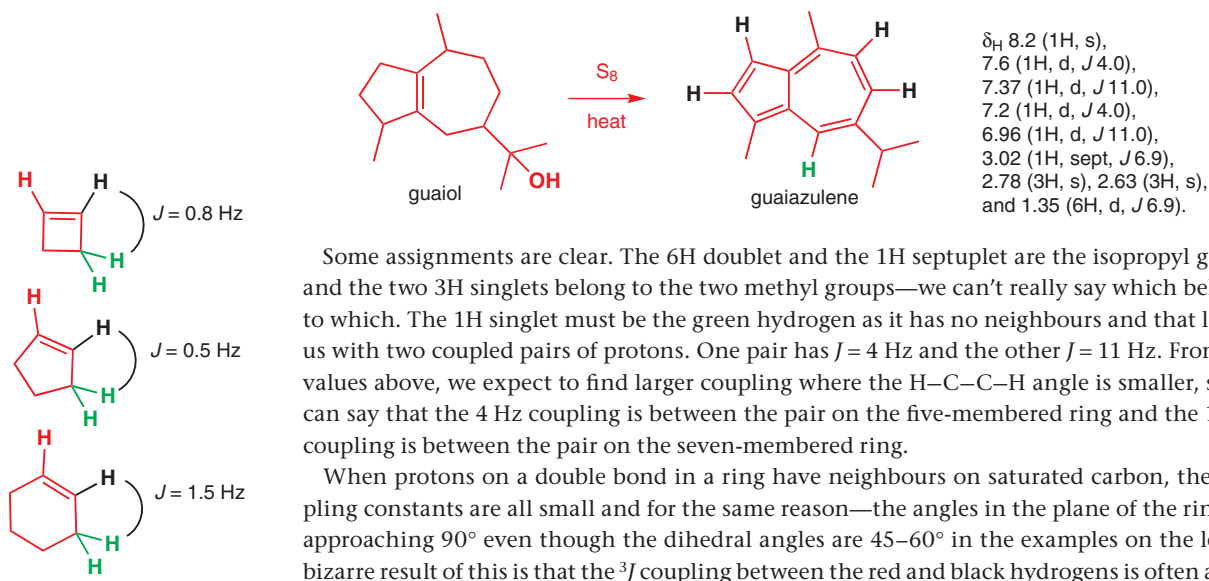

Some assignments are clear. The 6H doublet and the 1H septuplet are the isopropyl group, and the two 3H singlets belong to the two methyl groups—we can't really say which belongs to which. The 1H singlet must be the green hydrogen as it has no neighbours and that leaves us with two coupled pairs of protons. One pair has $J = 4$ Hz and the other $J = 11$ Hz. From the values above, we expect to find larger coupling where the H–C–C–H angle is smaller, so we can say that the 4 Hz coupling is between the pair on the five-membered ring and the 11 Hz coupling is between the pair on the seven-membered ring.

When protons on a double bond in a ring have neighbours on saturated carbon, the coupling constants are all small and for the same reason—the angles in the plane of the ring are approaching 90° even though the dihedral angles are $45\text{--}60^\circ$ in the examples on the left. A bizarre result of this is that the 3J coupling between the red and black hydrogens is often about

the same as the allylic (4J) coupling between the red and the green hydrogens. An example follows in a moment.

The 'spreading out' effect also affects vicinal (3J) couplings in simple saturated rings. No other ring size has so well defined a conformation as that of the six-membered ring, but we can still note useful trends as we move from 6 to 5 to 4 to 3. Briefly, in five-membered rings, *cis* and *trans* couplings are about the same. In four- and three-membered rings, *cis* couplings are larger than *trans*. But in all cases the absolute values of J go down as the ring gets smaller and the C–H bonds are 'spread out' more. Indeed, you can say that all coupling constants are smaller in small rings, as we shall see. But we need to examine a few examples in a bit more detail.

Three-membered rings

Three-membered rings have to be flat with all bonds eclipsed so the dihedral angle is 0° for *cis* Hs and 109° for *trans* Hs. Looking at the Karplus curve on p. 796, we expect the *cis* coupling to be larger, and it is. A good example is chrysanthemic acid, which is part of the pyrethrin group of insecticides found in the pyrethrum plant. Both *cis* and *trans* chrysanthemic acids are important, and in both isomers the coupling between the green proton on the ring and its brown neighbour on the double bond is 8 Hz. In the *cis* compound, the green proton is a triplet so the *cis* coupling in the ring is also 8 Hz. In the *trans* compound it is a double doublet with the second coupling, *trans* across the ring to the black H, of 5 Hz.

The most important three-membered rings are the epoxides. You saw in Chapter 13 (p. 295) that electronegative atoms reduce coupling constants by withdrawing electron density from the bonds that transmit the coupling 'information'. This means that epoxide couplings are very small—much smaller than those of their closely related alkenes, for example. Compare the four coupling constants in the diagram: for the epoxide, all couplings are small, but *cis* coupling is larger than *trans* coupling. In alkenes, *trans* coupling is larger (Chapter 13, p. 293). The table summarizes the coupling constants for alkenes, epoxides, and cyclopropanes.

Typical coupling constants J , Hz

Stereochemistry	Alkene	Cyclopropane	Epoxide
<i>cis</i>	10–12	8	5
<i>trans</i>	14–18	5	2

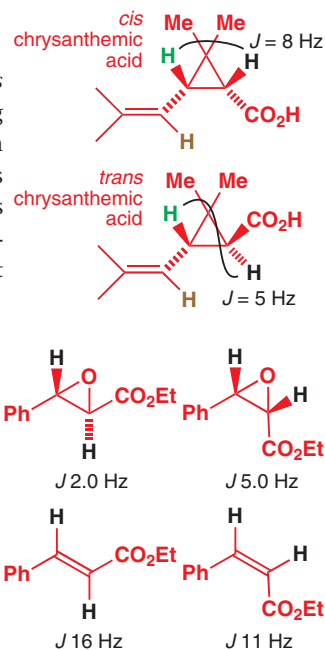

■ The epoxides have much smaller coupling constants than the alkenes because (1) the C–C bond is longer than the C=C bond, (2) there is an electronegative element, and (3) the 'spreading out' effect of the small ring comes into play.

Cerulenin

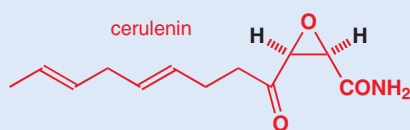

The natural product cerulenin is an antibiotic containing a *cis* epoxide. The coupling constant between the black hydrogens is 5.5 Hz. The compound has been made from an unsaturated lactone by epoxidation and ring opening. Follow what happens to the coupling constant between the black hydrogens as this sequence develops.

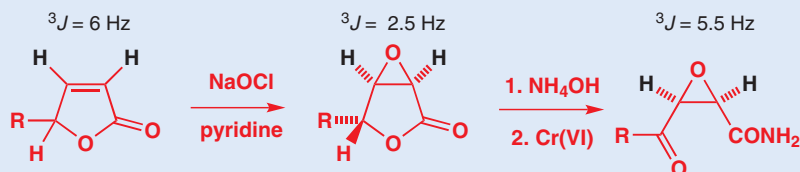

The *cis* coupling in the alkene is small because it is in a five-membered ring. It gets smaller in the bicyclic epoxide because the black Hs are now in both five- and three-membered rings and both are next to oxygen, but it gets larger in cerulenin itself because the five-membered ring has been opened.

Four-membered rings

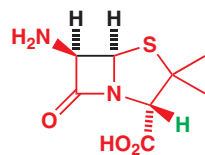

penicillanic acid

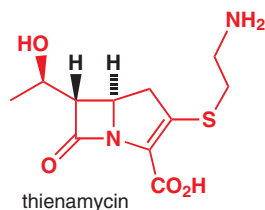

thienamycin

A similar situation exists with four-membered rings—the *cis* coupling is larger than the *trans* but they are generally both smaller than those in larger rings. A good example is the amino acid in the margin, the skeleton of the penicillins. The NMR spectrum contains three 1H signals in the middle regions. There is a singlet at δ_{H} 4.15 ppm that clearly belongs to the isolated green proton and two doublets at δ_{H} 4.55 and 5.40 ppm that must belong to the black protons. The coupling constant between them is 5 Hz and they are *cis*-related.

There are now large numbers of β -lactam antibiotics known and one family has the opposite (*trans*) stereochemistry around the four-membered ring. The typical member is thienamycin. We will analyse the spectrum in a moment, but first look at the differences—apart from stereochemistry—between this structure and the last. The sulfur atom is now outside the five-membered ring, the acid group is on a double bond in the same ring, and the amino group has gone from the β -lactam to be replaced by a hydroxyalkyl side chain.

Turning to the spectrum and the key question of stereochemistry, this is what the Merck discoverers said in their original article: '¹H NMR spectra of thienamycin (and derivatives)... show small vicinal coupling constants $J \leq 3$ Hz for the two β -lactam hydrogens. Past experience with penicillins... shows the *cis* relationship of the β -lactam hydrogens to be always associated with the larger coupling.'

As we have just seen penicillins have $J \sim 5$ Hz for these hydrogens. The NMR spectrum of a thienamycin derivative with protecting groups on the amine and carboxylic acids is shown below. Try your hand at interpreting it before you read the explanation. Your aim is to find the coupling constant across the four-membered ring.

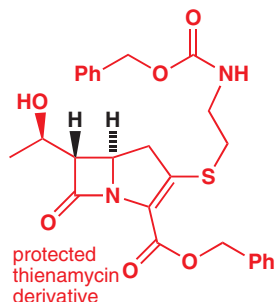

protected thienamycin derivative

NMR spectrum of thienamycin derivative in CD₃OD

Shift (δ_{H}), ppm	Integration	Multiplicity	Coupling constants (J), Hz
1.28	3H	d	6.5
2.95	2H	m	not resolved
3.08	1H	dd	9, 18
3.15	1H	dd	2.5, 7
3.35	1H	dd	9, 18
3.37	2H	m	not resolved
4.13	1H	dq	7, 6.5
4.19	1H	dt	2.5, 9
5.08	2H	s	—
5.23 and 5.31	2H	AB system ^a	AB system: ^a 12.5
5.80	1H	broad	—
7.34	10 H	multiplet	not resolved

^aSee p. 297 for discussion of AB systems.

The simple answer is 2.5 Hz. The signals at 3.15 and 4.19 ppm are the protons on the β -lactam ring and the 9 Hz extra coupling is to the CH₂ in the five-membered ring. If you went into this spectrum in detail you may have been worried about the 12.5 and especially the 18 Hz couplings. These are ² J (geminal) couplings and we will discuss them in the next section. The full assignment is shown below.

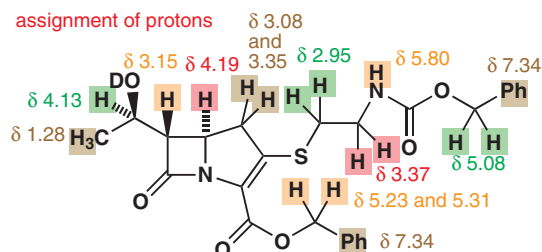

We should emphasize that a coupling constant of 5 or 2.5 Hz in isolation would not allow us to assign stereochemistry across the four-membered ring but, when we have both, we can say with confidence that the larger coupling is between *cis* Hs and the smaller coupling is between *trans* Hs.

Five-membered rings

You can visualize the conformation of a five-membered ring simply as a chair cyclohexane with one of the atoms deleted. But this picture is simplistic because the five-membered ring flexes (rather than flips) and any of the carbon atoms can be the one out of the plane. All the hydrogen atoms are changing positions rapidly and the NMR spectrum ‘sees’ a time-averaged result. Commonly, both *cis* and *trans* couplings are about 8–9 Hz in this ring size.

The best illustration of the similarity of *cis* and *trans* couplings in five-membered rings is a structure that was incorrectly deduced for that very reason. Canadensolide is an antifungal compound found in a *Penicillium* mould. The gross structure was quite easy to deduce from the mass spectrum, which gave the formula $C_{11}H_{14}O_4$ by exact mass determination, the infrared, which showed (at 1780 and 1667 cm^{-1}) a conjugated five-ring lactone, and some aspects of the proton NMR. The proposed structure is shown in the margin.

The stereochemistry of the ring junction Hs (shown in black and green) is not in question. They are certain to be *cis* as it is virtually impossible for two five-membered rings to be fused *trans*. The stereochemical uncertainty involves the third stereogenic centre on the left-hand ring. The coupling constant between the black and green Hs is 6.8 Hz, while that between the green and brown Hs is 4.5. Is this different enough for them to be *trans*? The original investigators decided that it was.

The mistake emerged when some Japanese chemists made this compound by an unambiguous route. The NMR spectrum was quite like that of canadensolide, but not the same. In particular, the coupling between the green and brown Hs was 1.5 Hz—quite different! So they also made the other possible diastereoisomer and found that it was identical to natural canadensolide. The details are in the margin.

An example of vicinal coupling in structural analysis: aflatoxins

We can bring together a lot of these points in the structure of one compound, the dreaded aflatoxin. Aflatoxins were mentioned in Chapter 19: they occur in moulds, including those that grow on some foods, and cause liver cancer. These slow-acting poisons are among the most toxic compounds known. Aflatoxin B_1 is an example. The four red protons on saturated carbons in the five-membered ring in the margin appear as two triplets: δ_H 2.61 (2H, t, J 5 Hz) and δ_H 3.42 (2H, t, J 5 Hz). The *cis* and *trans* couplings are the same. The yellow proton, on the junction between the two five-membered cyclic ethers, is a doublet δ_H 6.89 (1H, d, J 7 Hz). This is, of course, the *cis* coupling to the black hydrogen. The black hydrogen has this coupling too, but it appears as a doublet of triplets with a triplet coupling of 2.5 Hz: δ_H 4.81 (1H, dt, J 7, 2.5, 2.5 Hz). These small couplings can only be to the two green hydrogens: the 3J and 4J couplings are indeed the same.

Finally there is another strange coincidence—each green hydrogen appears as a triplet with 2.5 Hz couplings. Evidently, the *cis* coupling across the double bond is also 2.5 Hz. We expect *cis* coupling in a cyclopentene to be small (it was 4 Hz in the azulene on p. 814), but not that small—it must be the electronegative oxygen atom that is reducing the value still further.

Geminal (2J) coupling

For coupling to be seen, the two hydrogen atoms in question must have different chemical shifts—identical protons do not couple. For 2J , or geminal, couplings the two hydrogen atoms are on the same carbon atom, so in order to discuss geminal coupling we must first consider what leads the two hydrogens of a CH_2 group to have different shifts.

To introduce the topic, an example. It may seem to you that any six-membered ring might show different chemical shifts for axial and equatorial groups. But this doesn't happen. Consider the result of this Robinson annelation reaction.



➔ This conformation is sometimes called an ‘envelope’. See Chapter 32, p. 834.

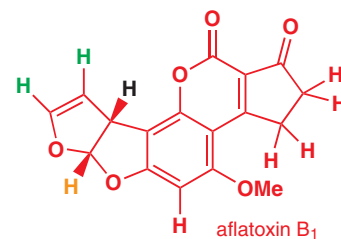
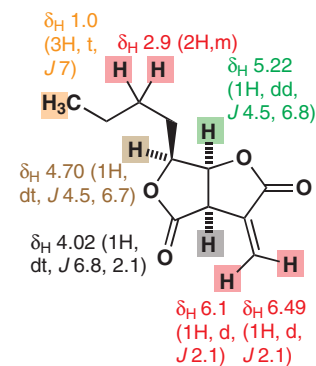
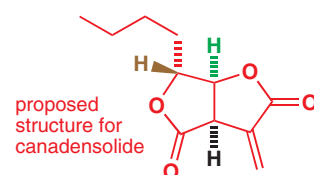

Coupling in furans

The size of coupling constants in five-membered rings containing oxygen is illustrated clearly in furfuraldehyde (furan-2-aldehyde): note how small the couplings are.

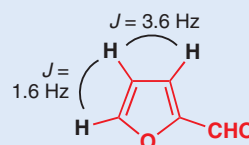

➔ The Robinson annelation was introduced in Chapter 26, p. 638. The 'flattened chair' conformation of cyclohexenones shown here is described in detail in Chapter 32, p. 830.

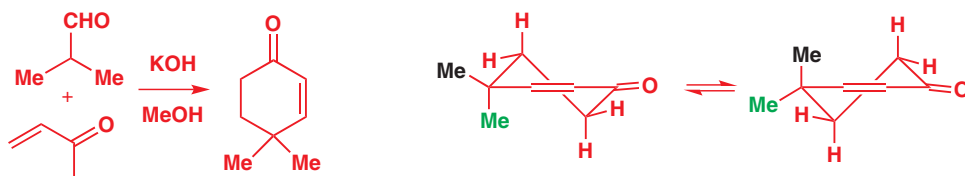

The two methyl groups at C4 give rise to a single signal in the ^{13}C NMR at 27.46 ppm. Even though one of them is (pseudo)axial and one (pseudo)equatorial, the molecule exists in solution as a rapidly equilibrating mixture of two conformations. The axial green methyl in the left-hand conformer becomes equatorial in the right-hand conformer, and vice versa for the black methyl group. The equilibrium position must be 50:50 and fast exchange averages the chemical shifts of the two methyl groups. The same is true for the CH_2 groups around the back of the ring, which each appear as a triplet.

However, the enone is not the only product of this reaction. A methanol adduct is also formed by Michael addition of methanol to the conjugated enone. This product has two methyl signals at 26.1 and 34.7 ppm. If we examine the molecule by conformational analysis as we did for the first product we see a similar situation.

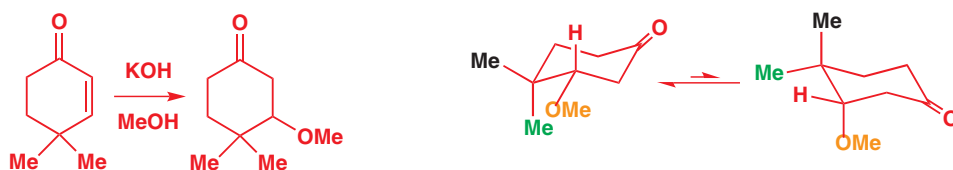

Similar but not the same. This time, the two conformations are not identical. One has the OMe group equatorial and the other has it axial. Even the two methyl groups do not entirely change places in the two conformations. True, the green methyl is axial on the left and equatorial on the right, but it has a gauche (dihedral angle 60°) relationship with the OMe group in *both* conformations. The black Me group is gauche to OMe on the left but anti-periplanar to the OMe group on the right. Averaging the two different conformations, in each of which the black and green methyl groups are different (that is, they don't just change places), does *not* lead to equalization of the two methyl groups.

Perhaps a simpler way to discover this is to use a configurational, rather than a conformational, diagram. The green methyl group is on the same face of the molecule as the MeO group, while the black methyl group is on the other face. No amount of ring flipping can make them the same. They are *diastereotopic*, a term we shall define shortly. And so are all three CH_2 groups in the ring. The green Hs are on the same face of the molecule as the MeO group while the black Hs are on the other face.

A proton NMR example confirms this, and here is one from an odd source. There are fungi that live on animal dung, called coprophilous fungi. They produce antifungal compounds, presumably to fight off competition! Anyway, in 1995 two new antifungal compounds were discovered in a fungus living on lemming dung. They were named coniochaetones A and B and their structures were deduced with the usual array of mass and NMR spectra. The proton spectra, run on a 600 MHz machine, are shown below, and they reveal considerable detail.

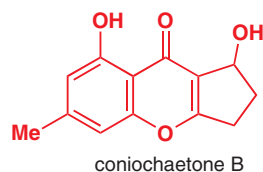
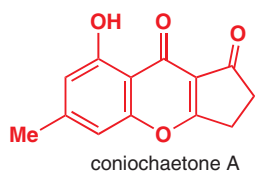
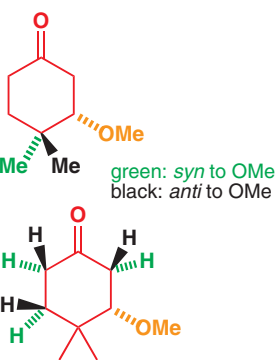

Some of the spectrum is essentially the same for the two compounds, but other parts are quite different. Coniochaetone A has a very simple spectrum, very easily assigned. Coniochaetone B is rather more interesting. The spectrum is much more complicated, even though it has only one more C-H (the grey one) than coniochaetone A. The reason is that addition of that H atom creates a stereogenic centre and makes the top and bottom faces of the molecule different. Each H in both CH_2 groups becomes differentiated from its partner.

Coniochaetone A		Coniochaetone B	
δ_{H} , ppm	Coupling	δ_{H} , ppm	Coupling
2.41 (3H)	s	2.38 (3H)	s
2.70 (2H)	m	5.43 (1H)	ddd, J 1.4, 3.3, 7.6 Hz
3.07 (2H)	m	2.49 (1H)	m
6.77 (1H)	broad s	2.03 (1H)	m
6.69 (1H)	broad s	3.10 (1H)	dddd, J 1.4, 5.1, 9.4, 18 Hz
12.21 (1H) ^a	s	2.81 (1H)	ddd, J 5.1, 9.3, 18 Hz
		6.70 (1H)	broad s
		6.62 (1H)	broad s
		12.25 (1H) ^a	s

^aExchanges with D₂O.

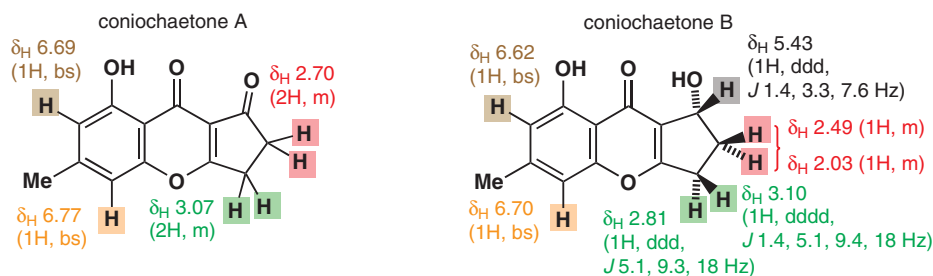

The green Hs are coupled to each other ($J = 18$ Hz) and to each of the black Hs with a different coupling constant. One of the green hydrogens also shows a long-range ($^4J = 1.4$ Hz) W-coupling to the red H. The black Hs are too complex to analyse, even at 600 MHz, but the different couplings to the red Hs are shown by the signal at 5.43 ppm.

The size of the geminal coupling constant

The 18 Hz geminal coupling constant between the green protons of coniochaetone B is large, but not unusually so for a geminal coupling. A more typical figure in a six-membered ring might be closer to 14 Hz, and we will see shortly why the value in coniochaetone B is bigger than this. The example below provides an opportunity to examine coupling constants in another example where NMR was essential for determining the structure. The compound is pederin, a toxic amide of the blister beetle *Paederus fuscipes*. After some incorrect early suggestions, the actual structure of the compound was eventually deduced as shown.

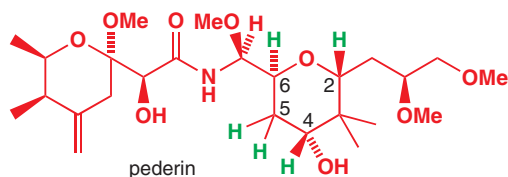

We are not going to discuss the full structure elucidation, but will concentrate on the stereochemistry of the right-hand ring. The five (green) protons on the ring gave the signals listed in the margin.

Three of the protons have shifts δ_{H} 3–4, and are obviously on carbons attached to oxygen atoms. The other two, δ_{H} about 2, must be the diastereotopic pair at C5. The coupling of 12 Hz, which appears in both signals, must be the geminal coupling and the other couplings are found in the signals at δ_{H} 3.75 and 3.85. The signal at δ_{H} 3.75 has no other couplings and must be from C4 so that leaves δ_{H} 3.85 for the hydrogen atom at C6, which is also coupled to the hydrogen in

δ_{H}
1.85 (1H, ddd, J 5, 10, 12)
2.10 (1H, ddd, J 3, 4, 12)
3.75 (1H, dd, J 4, 10)
3.85 (1H, ddd, J 3, 5, 8)
4.00 (1H dd, J 3, 7)

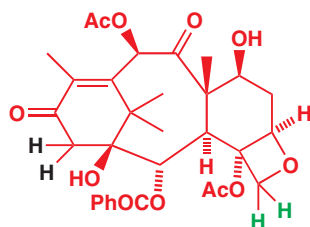
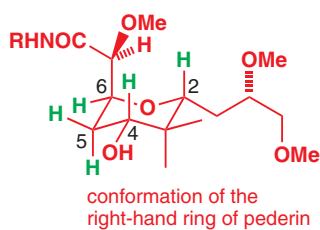

➔ The effect of electronegative atoms on coupling was discussed in Chapter 13, p. 295.

the side chain. The 10 Hz coupling must be axial–axial—the others are all much smaller, meaning there is just the one axial–axial coupling. The left-hand side chain must therefore occupy an axial position as shown in the margin. This is perhaps a bit surprising—it's large and branched—but the molecule has no choice but to place one of the two side chains axial.

One of the most important compounds from the last 25 years is Taxol, the anti-cancer compound isolated from the bark of the Pacific yew tree. Taxol's structure has four rings—with eight, six (twice), and four members—and is too complex to analyse in detail, but the NMR spectrum of the closely related compound in the margin gives us the opportunity to illustrate how much geminal couplings in rings may vary and to analyse some of the factors which control this variation. The coupling between the black Hs is 20 Hz while that between the green Hs is just 6 Hz.

20 Hz is a very large coupling constant, even for geminal coupling, and the reason it is so big is the adjacent π bond. If a CH_2 group is next to an alkene, aromatic ring, $\text{C}=\text{O}$ group, CN group, or any other π -bonded functional group, it will have a larger geminal coupling constant. This effect also explains the large 18 Hz coupling in coniochaetone B (p. 819).

But why is the green coupling so small? The reason is the four-membered ring. You saw on p. 814 that vicinal couplings are small in small rings; the same is true of geminal couplings. Another factor comes into play here as well—the adjacent oxygen atom. Electronegative atoms always tend to reduce coupling constants.

• The size of 2J and 3J coupling constants

We have now covered all of the important influences on the size of coupling constants. They are:

- dihedral angle: 3J greatest at 180° and 0° ; about 0 Hz at 90°
- ring size, which leads to 'spreading out' of bonds and lower 2J and lower 3J in small rings
- electronegative atoms, which decrease 2J and 3J coupling constants between protons
- π systems, which increase 2J coupling constants between protons.

Diastereotopic groups

■ To understand this discussion, it is very important that you understand the ideas that we covered in Chapter 14. You may need to refresh your memory of the stereochemical points there before you read further.

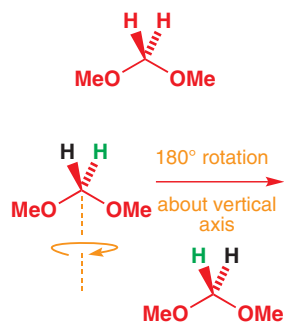

You have now seen several examples where two protons attached to the same carbon are not the same, and it is time to examine more closely the appearance of these CH_2 groups in NMR spectra. To do this, we shall have to discuss some aspects of symmetry that build on what you learned in Chapter 14. You will see that there are *three* possibilities for the symmetry associated with a CH_2 group, and these three possibilities have an effect both on the chemistry of the molecule and on what its NMR spectrum will look like.

First, an example in which the two hydrogens are indeed the same. Although the molecule is of course achiral, we may draw one hydrogen coming towards us and one going away, but the two Hs are the same. This is easy to demonstrate. If we colour one H black and one green, and then rotate the molecule through 180° , the black H appears in the place of the green H and vice versa. The rotated molecule hasn't changed because the *other* two substituents (OMe here) are also the same.

If we had given out uncoloured models of this molecule with this book, and asked each reader to paint one H green and one H black, we would have no way at all of giving instructions about which to paint what colour. But it wouldn't matter because, even without these instructions, every reader would produce an identical model, whichever way they painted their Hs.

The correct description for this pair of hydrogen atoms is **homotopic**. They are the same (*homo*) topologically and cannot be distinguished by chemical reagents, enzymes, NMR machines, or human beings.

• Homotopic groups

Homotopic groups cannot be distinguished by any means whatsoever: they are chemically entirely identical.

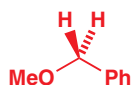

What happens when the other two substituents are different? At first sight the situation does not seem to have changed. Surely the two hydrogens are still the same as one another?

In fact, they aren't—not quite. If we had given out uncoloured models of this molecule and just said 'paint one H green and one H black', we would not have got just one type of model. However, this time we *could* give instructions about which H we wanted which colour. To get the first of these two, we just need to say 'Take the MeO group in your *left* hand and the Ph group in your *right*, kink the carbon chain upwards. The hydrogen coming towards you is to be painted black.' All the models produced by readers would then be identical—as long as the readers knew their left from their right. This is a very important point: the green and black hydrogens in this molecule (unlike the first one) can be described only in phrases incorporating the words 'left' or 'right', and are distinguishable only by a system that knows its left from its right.

Human beings are such a system: so are enzymes and the asymmetric reagents you will meet in Chapter 41. But NMR machines are not. NMR machines cannot distinguish right and left—the NMR spectra of two enantiomers are identical, for example. There is no question of enantiomers in the molecule in question—it has a plane of symmetry and is achiral. Nonetheless, the relationship between these two hydrogens is rather like the relationship between enantiomers (the two possible ways of colouring the Hs are enantiomers—mirror images) and so they are called **enantiotopic**. Enantiotopic protons appear identical in the NMR spectrum.

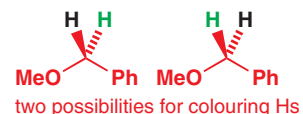

● Enantiotopic groups

Enantiotopic groups can be distinguished by systems that can tell right from left, but are still magnetically equivalent and appear identical in the NMR spectrum.

The third situation usually arises when the molecule has a stereogenic centre. As an example we can take the Michael product from the beginning of this section. It is now very easy to distinguish the two hydrogens on each ring carbon atom and, if we want to give instructions on how to paint a model of this molecule, we can just say 'Make all the Hs on the same side of the ring as OMe green, and the ones on the opposite side to OMe black.' We do not need to use the words 'right' or 'left' in the instructions, and it is not necessary to know your right from your left to tell the two types of Hs apart. Ordinary chemical reagents and NMR machines can do it. These Hs are different in the way that diastereoisomers are different and they are **diastereotopic**. We expect them to have different chemical shifts in the proton NMR spectrum. The same is true of the methyl groups: they too are diastereotopic and we expect them to have different shifts.

● Diastereotopic groups

Diastereotopic groups are chemically different: they can be distinguished even by systems that cannot tell right from left, and they can appear at different chemical shifts in the NMR spectrum.

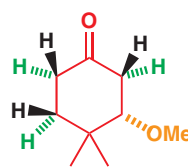

■ NMR machines *can* tell the difference, but it does not follow that they *will*. There are many examples of protons that are different but have the same chemical shift (toluene, PhMe, shows a singlet in the NMR for all its aromatic protons even though they are of three different kinds). Sometimes diastereotopic protons have the same chemical shift, sometimes slightly different chemical shifts, and sometimes very different chemical shifts.

How to tell if protons are homotopic, enantiotopic, or diastereotopic

What we have said so far explains to you why homotopic and enantiotopic groups always appear identical in the NMR spectrum, but diastereotopic protons may not. Now we will give a quick guide to determining what sort of pair you are dealing with in a given molecule.

The key is to draw your molecule twice. In each drawing (or model if you prefer) replace one of the Hs (we'll assume we're looking at protons, but the argument works for other groups too—Me groups, for example) with an imaginary group 'G'. Write down the first structure you get, with stereochemistry shown. Next, write down the structure you get by replacing the other H with the group G. Now the more difficult bit: identify the stereochemical relationship between the two molecules you have drawn.

- If they are identical molecules, the protons are homotopic.
- If they are enantiomers, the protons are enantiotopic.
- If they are diastereoisomers, the protons are diastereotopic.

This is really just a simpler way of doing what we did with black and green above, but it is easy to do for any molecule. Take the first of our examples, and replace each H in turn by G. These two molecules are identical because just turning one over gives the other: the protons are homotopic.

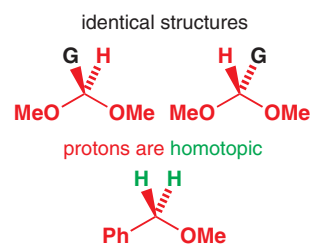

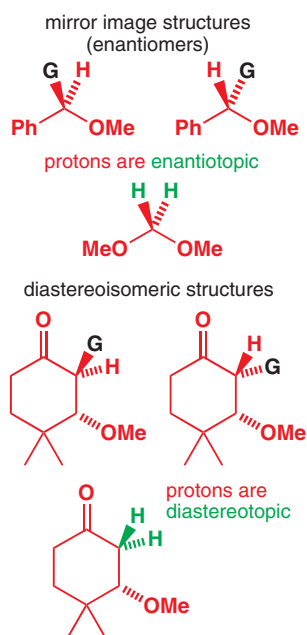

■ The shape of NMR signals where J and the chemical shift difference are of the same order of magnitude were discussed in Chapter 13. The arguments apply to any coupled protons of similar chemical shift—there we used disubstituted aromatic rings as the example—but are particularly relevant here.

■ It is not always easy to decide which proton gives rise to which signal in a diastereotopic AB system, although the information may be important in assigning stereochemistry. The size of other couplings, or the nuclear Overhauser effect (p. 799), may assist.

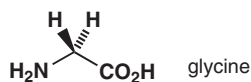

Now for the next example. The two molecules are not identical: to make one into the other you need to reflect in the plane of the paper, so they are enantiomers, and the Hs are *enantiotopic*. There is another term we must introduce you to in relation to this molecule, which will become useful in the next chapter, and that is 'prochiral'. The molecule we started with here was not chiral—it had a plane of symmetry. But by changing just one of the Hs to a different group we have made it chiral. Molecules that are achiral but can become chiral through one simple change are called **prochiral**.

Now we will choose one of the three pairs of Hs in the cyclohexanone example. The starting molecule is, of course, now chiral, and the two molecules we get when we replace each H by G are now diastereoisomers: one has G and OMe *anti*, the other *syn*, and the pairs of hydrogens are *diastereotopic*. The same is true for the other CH₂ groups. Furthermore, the methyl groups attached to the ring will be diastereotopic too, and we expect them to appear as two 3H singlets.

Spotting diastereotopic protons in the NMR spectrum

A CH₂ group with diastereotopic Hs isolated from any other Hs will give rise to two signals, one for each H, and they will couple to each other so that the complete signal is a pair of doublets. A typical geminal (²*J*) coupling constant is 14 Hz—relatively large. Because chemical shift differences ($\Delta\delta$) between Hs on the same carbon atom tend to be small—usually less than 1 ppm—the signals have $\Delta\delta \sim J$ and are distorted into a 'roof-topped' AB system.

Here is an example. The pheromone frontalin is a remarkable compound used by both insects and by elephants to attract a mate. Its structure and ¹H NMR spectrum are shown below.

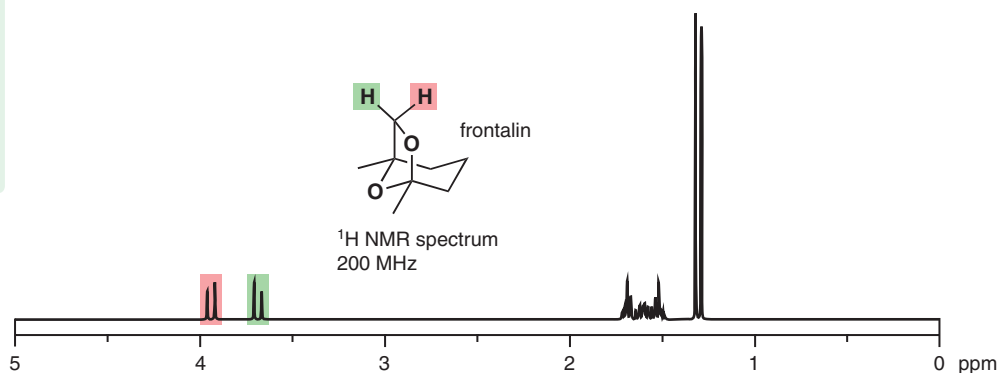

The red and green hydrogens are diastereotopic, and have no other couplings. They give the pair of doublets at 3.42 and 3.93 ppm., each with J 7 Hz (an AB system) in the ¹H NMR. The coupling constant here is small for ²*J*—only 7 Hz—but that should not surprise you since we have a five-membered ring and a nearby oxygen atom.

The coupling constant in an AB system is easy to extract—it is the difference in Hz between the two lines highlighted same colour in the spectrum above. But the chemical shifts are not so easily measured. The chemical shift of each proton is at the weighted mean of the two lines—the more distorted the signal, the nearer the chemical shift to that of the larger inner line.

Diastereotopic protons in acyclic compounds

The same principles apply to open-chain compounds, such as amino acids. All of the amino acids in proteins except glycine are chiral. Glycine has a CH₂ group that gives a singlet in the NMR spectrum as its Hs are enantiotopic. Similarly, the *N*-benzyl derivative of glycine has a second CH₂ group (NCH₂Ph) that gives another singlet in the NMR spectrum as these Hs too are enantiotopic.

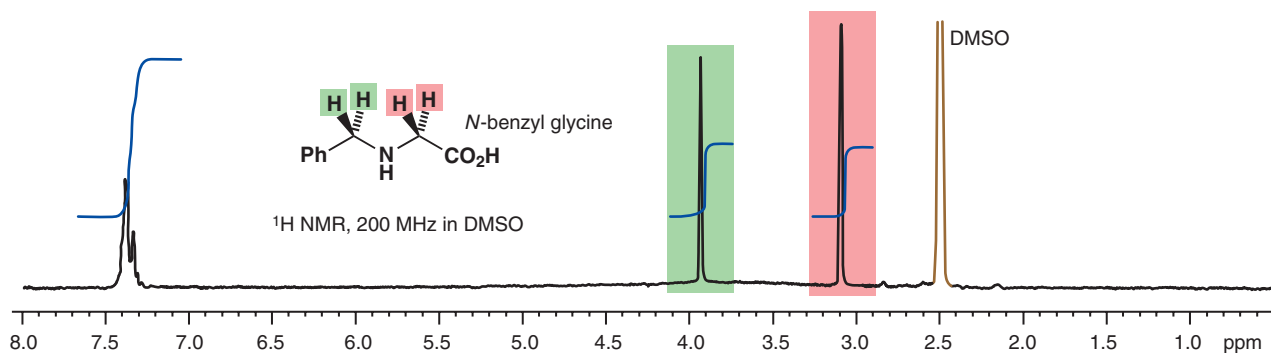

The plane of the paper is a plane of symmetry for both of the CH_2 groups of *N*-benzyl glycine in the way it is drawn here. But for the other amino acids, which are all chiral, the symmetry is different. The ^1H NMR spectrum of *N*-benzyl alanine is shown below. There is now no plane of symmetry, so the Hs of the NCH_2Ph group are diastereotopic. The CH_2 group appears as an AB pattern.

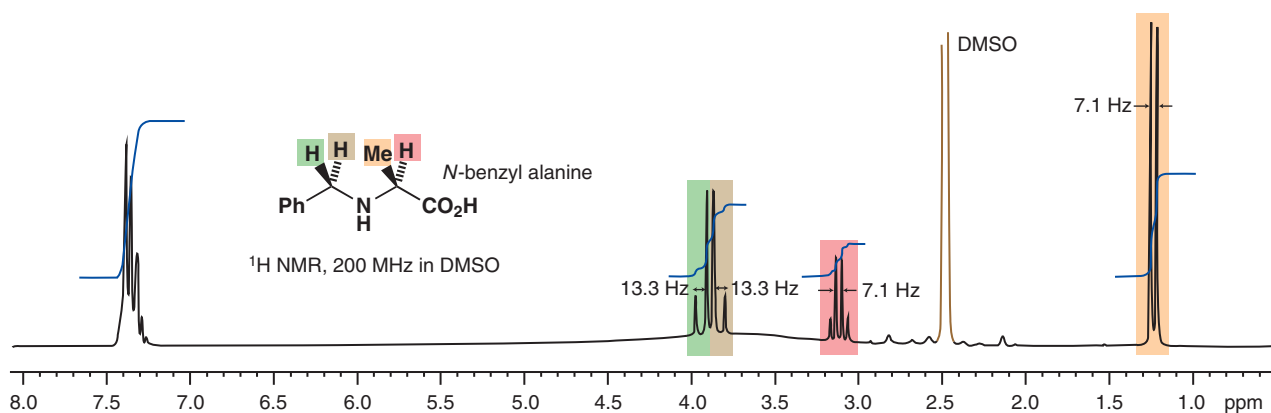

In the way in which the molecule is drawn, the green H is on the same side as the Me group and the brown H on the other. It does not matter that there is free rotation in this molecule—the two diastereotopic protons are never in the same environment so even after averaging over all the conformations available to the molecule they always appear at different chemical shift. If a molecule is chiral, all CH_2 groups in that molecule—however flexible it may be and however far they are from any chiral centre—are diastereotopic, and can potentially appear in the spectrum as an AB system.

It is more common to find diastereotopic CH_2 groups with neighbours, and an example arises when aspartic acid is dissolved in D_2O with NaOD present. The NH_2 protons are exchanged for deuterium atoms and do not show in the spectrum—the molecule exists as its dianion.

■ For an illustration of diastereotopic CH_2 groups which may or may not appear as AB systems, look back at the spectrum of thienamycin on p. 816. Compare the two OCH_2Ph groups: both have a diastereotopic CH_2 pair, but one appears as a singlet and one as an AB system.

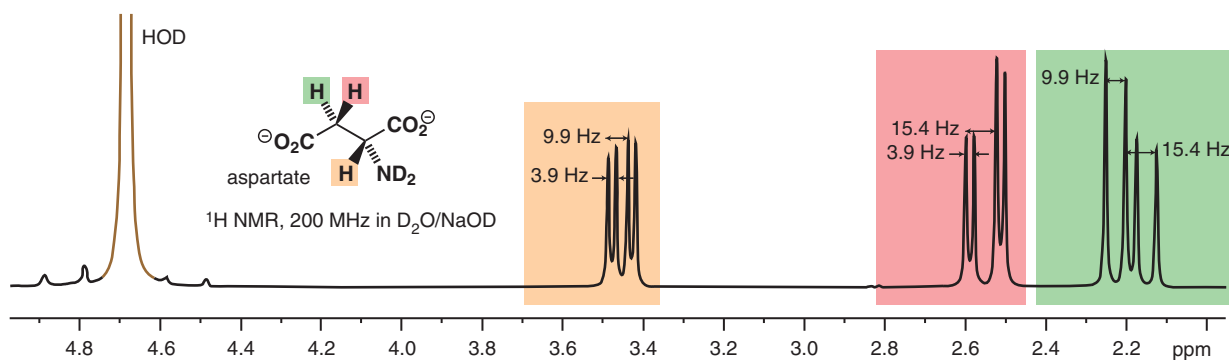

To summarize...

We have covered a lot of ground in this chapter, and have used the huge topic of saturated heterocycles to explain a lot, not just about the reactivity and conformation of rings. Many of these explanations involved consideration of the alignment of orbitals—we called these stereoelectronic effects. The same analysis allowed us to make sense of the NMR spectra, and in particular the coupling constants, of cyclic molecules, both heterocyclic and carbocyclic. And by thinking about symmetry in these cyclic molecules we were also able to deduce the origins of symmetry-related features (such as diastereotopic protons) in the NMR spectra of acyclic compounds.

The next chapter is the fourth consecutive chapter to take rings as a theme. It will introduce you to practical ways of controlling stereochemistry in cyclic systems—the first step towards making molecules with a particular stereochemistry, which will continue in Chapter 33 and culminate in Chapter 41 on asymmetric synthesis.

Further reading

Another reminder: you will find it an advantage to have one of the short books on spectroscopic analysis to hand as they give explanations, comprehensive tables of data, and problems. We recommend D. H. Williams and Ian Fleming, *Spectroscopic Methods in Organic Chemistry*, McGraw-Hill, London, 6th edn, 2007.

For stereoelectronics, a short introduction is A. J. Kirby, *Stereoelectronic effects*, OUP, Oxford, 1996, and a longer book is P. Deslongchamps, *Stereoelectronic Effects in Organic Chemistry*, Pergamon, London, 1983.

Check your understanding



To check that you have mastered the concepts presented in this chapter, attempt the problems that are available in the book's Online Resource Centre at <http://www.oxfordtextbooks.co.uk/orc/clayden2e/>

Stereoselectivity in cyclic molecules

32

Connections

➔ Building on

- Stereochemistry [ch14](#)
- Conformational analysis [ch16](#)
- Saturated heterocycles and stereoelectronics [ch31](#)

Arriving at

- Stereoselectivity in cyclic systems is easy to understand
- Flattened four- and five-membered rings are attacked *anti* to large substituents
- Flattened six-membered rings are attacked from an axial direction
- Bicyclic structures are attacked on the outside face
- Tethering together nucleophile and electrophile forces one stereochemical outcome
- Hydrogen bonding can reverse the normal stereochemical outcome of a reaction

➔ Looking forward to

- Diastereoselectivity [ch33](#)
- Pericyclic reactions [ch34 & ch35](#)
- Asymmetric synthesis [ch41](#)

Introduction

In the last chapter we looked at how the NMR spectra of cyclic molecules tell us a lot about their shape—both their conformation and their configuration. We are now going to go beyond simply studying stereochemistry and start to explain how to control stereochemistry. We have already, in Chapter 27, spent some time looking at controlling one aspect of stereochemistry—double bond geometry. But stereochemistry is about much more than this, and in this chapter and the next we will explain how to make single diastereoisomers and single enantiomers.

We start with stereochemistry in rings. Not only is stereochemistry easier to understand in cyclic compounds, it is also *better behaved* in cyclic compounds. Suppose you were to reduce this ketone to one of the corresponding alcohols.

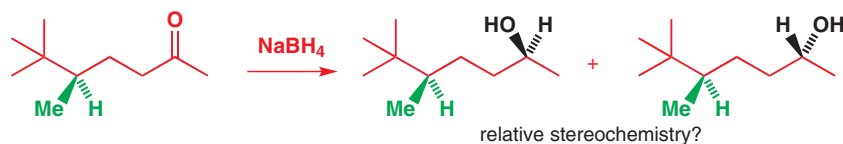

To achieve a stereoselective reaction at the new stereogenic centre (shown in black) the green stereogenic centre would somehow have to influence the direction of attack of the nucleophile on the C=O group. Separated from it by three bonds, in a molecule with a high degree of flexibility, makes this a very tall order. A more or less 50:50 mixture of the two diastereoisomers would be expected.

Online support. The icon  in the margin indicates that accompanying interactive resources are provided online to help your understanding: just type www.chemtube3d.com/clayden/123 into your browser, replacing **123** with the number of the page where you see the icon. For pages linking to more than one resource, type **123-1**, **123-2** etc. (replacing **123** with the page number) for access to successive links.

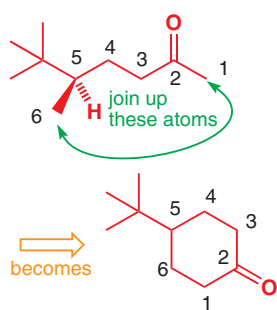

■ If your memory of Chapter 16's discussion of the effect of substituents on the conformation of six-membered rings is dim, you should refresh it now. Conformational analysis underpins much of this chapter and you need to be fully familiar with its concepts and terminology.

► Stereoselective reactions of acyclic compounds are dealt with in Chapter 33.

However, if we join up the molecule into a ring, as shown in the margin, things are suddenly quite different. (This is not, of course, a chemical reaction—just a thought process!) The cyclic ketone has a fixed conformation controlled by the determination of the *tert*-butyl group to be equatorial. The two faces of the carbonyl group are therefore clearly quite different, and in fact by careful choice of reducing agent it is possible to attack either at will, giving almost exclusively either the axial or the equatorial alcohol. As we will explain shortly (p. 828) large reagents prefer to approach equatorially while small reagents prefer to approach axially, putting the new OH group into an equatorial position. These are *stereoselective* reactions and, because the two different outcomes are diastereoisomers, we can call them *diastereoselective*.

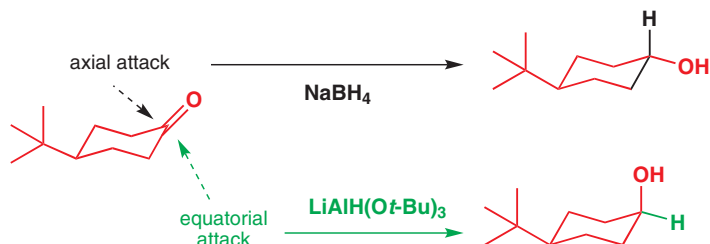

The key to the difference between these two compounds is in their conformations. The six-membered ring of the cyclic ketone has one conformation and the two approaches to the faces of the ketone are very different. In the open-chain compound rotation about all the C–C bonds is possible and very many conformations will be populated. In any one conformation, attack on one face of the ketone or the other may happen to be preferred, but summed over all of them the average selectivity will be close to 1:1. There is all the difference in the world between cyclic and open-chain compounds when it comes to stereoselective reactions.

In this chapter we shall look at reactions happening to cyclic compounds, reactions with cyclic intermediates, and reactions with cyclic transition states. We shall investigate what happens to stereochemistry when two (or even more) rings are joined together at a bond or at an atom. You have already looked in detail at reactions which close rings (Chapter 31, p. 805), and many of the *reactions* in this chapter you will have met earlier in the book. Our task is to reveal new features and subtleties, and to show you how to use these reactions to control stereochemistry.

Stereochemical control in six-membered rings

As you saw in Chapter 16, cyclohexanes benefit from very well defined conformational preferences. Substituents are orientated either axially or equatorially, and usually prefer the equatorial orientation, especially when they are large. The strong preference for substituents to adopt the equatorial position means that when diastereoisomeric cyclohexanes equilibrate by processes such as enolization they may give high selectivity for the all-equatorial compound. For example, this fine perfumery material is made worthless by enolization.

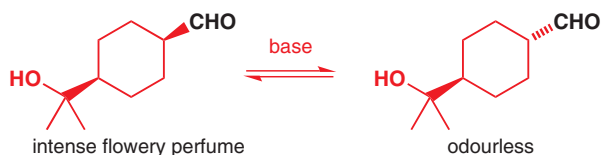

The reason the equilibrium favours the worthless *trans* isomer (it forms 92% of the equilibrium mixture) is that the two substituents are both in the more stable equatorial positions.

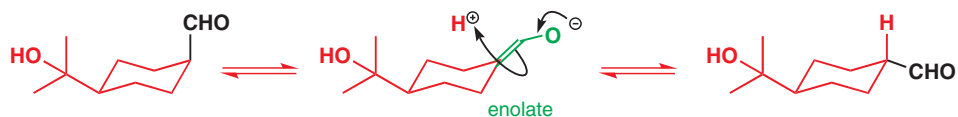

■ Although a disadvantage here, in other cases equilibration to the more stable all-equatorial conformation can be a useful source of stereochemical control. For an example, see p. 829.

Six-membered rings containing one sp^2 -hybridized carbon atom: cyclohexanone

If we're interested in the reactions of six-membered rings, then we are going to have to consider what happens to their conformation when they contain reactive functional groups such as carbonyl groups and alkenes—in other words, the effect of introducing sp^2 C atoms into the ring. For just one sp^2 carbon atom the simple answer is that nothing changes—the conformation is not significantly altered by the presence of just one sp^2 centre in a ring. The conformations of methylenecyclohexene and cyclohexanone are shown below.

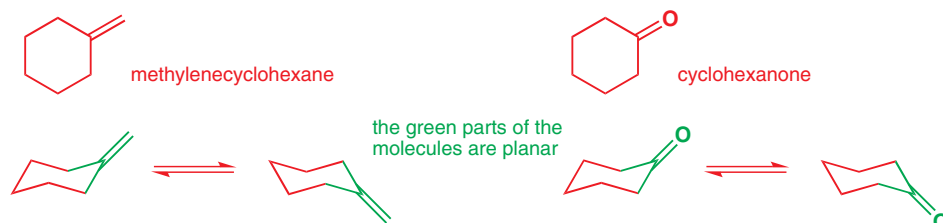

Six-membered rings with *more than one* sp^2 C atom do lose their chair conformation—they become flattened to some degree when there are one or more double bonds included in the ring and we shall come on to those in the next section.

Axial or equatorial attack is possible on a cyclohexanone

So, what happens when a cyclohexanone is attacked by a nucleophile? For cyclohexanone itself, the reaction below gives a product which can adopt either of the two conformations shown, with Nu axial or equatorial, depending on the relative size of Nu and OH. This reaction does not tell us much about the attack on the C=O group itself—we can't tell, for example, whether Nu^- attacked the axial or the equatorial face of the C=O group.

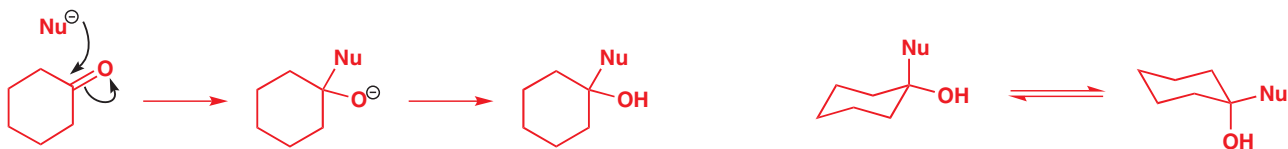

Now think of a nucleophile attacking 4-*t*-butylcyclohexanone. Since the *t*-butyl group locks the ring (*t*-Bu can never be axial), whether Nu is axial or equatorial will depend only on which face of the C=O group it attacks. Attack on the same face as the *t*-butyl group leaves the nucleophile axial and the hydroxyl group equatorial; attack on the opposite face leaves the nucleophile equatorial and the hydroxyl group axial. The nucleophile is said to attack either in an axial or equatorial manner, depending on where it ends up. It's easier to see this in a diagram.

axial attack of the nucleophile

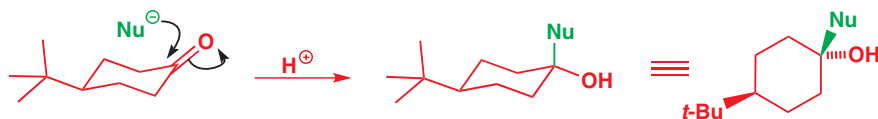

equatorial attack of the nucleophile

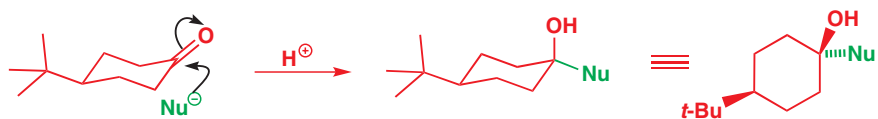

Now for an observation—we'll try and explain it shortly. In general, large nucleophiles attack equatorially and small nucleophiles attack axially. For example, reduction of 4-*t*-butylcyclohexanone with lithium aluminium hydride in Et_2O gives 90% of the *trans* alcohol: 90%

Drawing cyclohexanones

Make sure you point the ketone in the right direction! It should bisect the angle there would be between the axial and equatorial substituents, if the carbon atom were tetrahedral. It's always best to put the carbonyl group at one of the 'end' carbons of the ring: it's much harder to get it right if you join it to one of the middle ones.

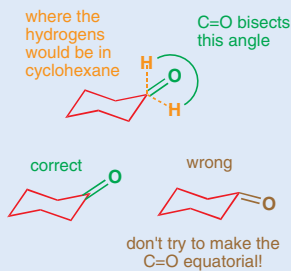

of the hydride has added axially. AlH_4^- is quite small as nucleophiles go: to make more of the *cis* alcohol we need a larger nucleophile—lithium tri-*sec*-butylborohydride, for example, sold under the name of L-selectride®. This is so large that it attacks only equatorially, yielding typically 95% of the *cis* alcohol.

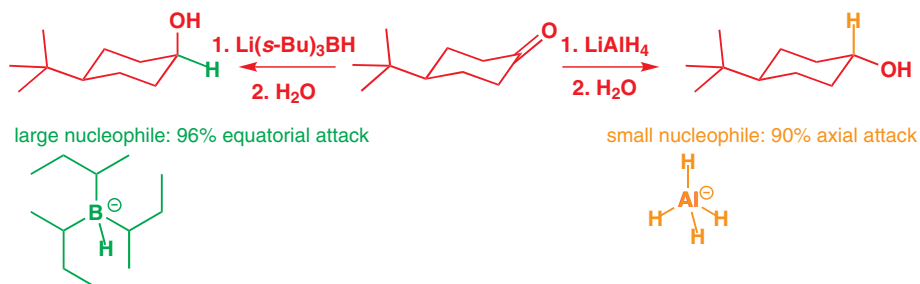

Carbon-centred nucleophiles follow the same trend—the table shows that, as size increases from the slender ethynyl anion through primary and secondary organometallics to *t*-BuMgBr, the axial selectivity drops off correspondingly. PhLi behaves as though it were quite small because it is flat.

Nucleophile	% of product resulting from	
	Axial attack	Equatorial attack
$\text{HC}\equiv\text{CLi}$	88	12
MeLi	35	65
PhLi	42	58
MeMgBr	41	59
EtMgBr	29	71
<i>i</i> -PrMgBr	18	82
<i>t</i> -BuMgBr	0	100

Now the difficult part—why? This is a question to which the answer really is not known for certain. It's certainly true that the direction of approach for axial attack is more hindered than for equatorial attack, and this is certainly the reason large nucleophiles prefer to attack equatorially.

But if this is the case, why do small ones actually *prefer* to attack axially? There must be another factor that favours axial attack for those nucleophiles small enough to avoid the bad interactions with the other axial hydrogens. At the transition state, the forming O^- oxygen substituent is moving in either an axial or an equatorial direction. Just as the axial substituent is less favourable than an equatorial one, so is the transition state leading there, and the route leading to the equatorial hydroxyl group is favoured.

When chemists made the drug alphaprodine using the reaction shown below, they found that the combination of the equatorial preference of a methyl group adjacent to $\text{C}=\text{O}$ and an equatorial preference for attack on the $\text{C}=\text{O}$ group were enough to favour the formation of one diastereoisomer. Here is the reaction, with the starting material and product represented as a conformational diagram.



We can also represent the reaction in configurational terms. This is less good for explaining the stereoselectivity, but you should always be prepared to turn conformational diagrams into standard configurational ones.

Other reasons have been proposed for this selectivity, but they are beyond the scope of this book.

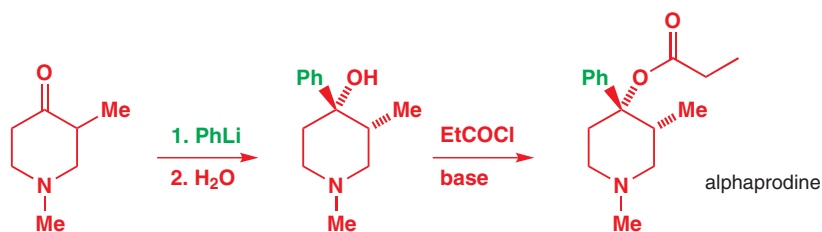

In the next reaction, stereoselectivity is not so good. Zeneca (now AstraZeneca) announced the manufacture of a drug by the addition of a lithiated thiophene to another heterocyclic ketone, which initially gave a mixture of diastereoisomers.

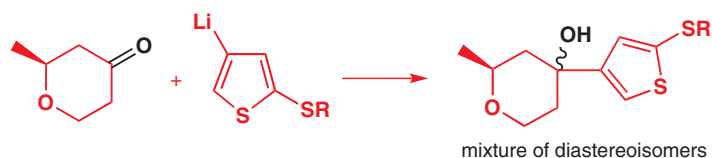

Such a mixture is no good for manufacture of a pure drug, but the compound can be equilibrated in dilute acid by repeated S_N1 formation of a tertiary cation and recapture by water so that the required product (which is more stable as it has both Me and the thiophene equatorial) dominates by 92:8 and can be purified by crystallization. The unwanted isomer can be recycled in the next batch.

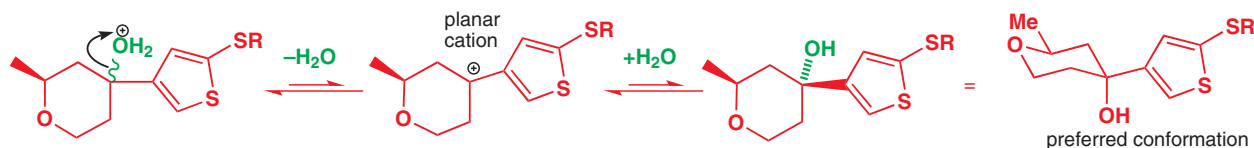

■ Compare this strategy with the equilibration of the perfumery compound via its enolate, described on p. 826.

In these reactions the molecule has a free choice whether to place a substituent in an axial or equatorial position and this is the only consideration because the starting materials in the reactions—ketones or carbocations—have six-membered rings that are already in the chair conformation even though they have one trigonal (sp^2) atom in the ring.

Six-membered rings with two or more sp^2 carbons: cyclohexenes

With more than two trigonal carbon atoms in the ring, a cyclohexene can no longer adopt a chair conformation. At least four of the atoms in the ring must now be in a plane, and the best way to represent this is in the diagrams shown below. The four atoms in the plane are nearest you, with the remaining two placed one above and one below that plane.

cyclohexene adopts a 'flattened chair' or 'half-chair' conformation



Cyclohexene itself flips rapidly between these two conformations, with a barrier of about 22 kJ mol^{-1} , about half that of cyclohexane. As in cyclohexane, hydrogen atoms on the saturated carbons of the cyclohexene structure adopt two types of positions, but as they are not quite orientated in the same way as in cyclohexane, we call the two orientations 'pseudoaxial' and 'pseudoequatorial'.

Only axial attack is possible with cyclohexenes

These conformations of six-membered rings with more than one trigonal carbon are quite plainly not chairs, and are much less stable than chairs. Anything which allows them to become a chair is likely to be highly favoured, and the stereoselectivity of a reaction is likely

to be driven by the need for the transition state and product to have a chair rather than a boat conformation. This can override the preference for substituents to go into equatorial positions. The choice of axial attack controls the stereoselectivity of reactions of cyclohexenes (and, as you will see, their epoxides), six-membered cyclic enolates, and six-membered cyclic enones.

● **The number of trigonal carbon atoms in the ring decides which factors control stereoselectivity**

- Six-membered rings with one trigonal (sp^2) carbon atom are already chairs and can undergo axial or equatorial attack.
- Six-membered rings with two or more trigonal carbon atoms are not chairs and undergo axial attack in order to form chairs rather than boats. The final product may end up with axial or equatorial substitution, but this is not a consideration in the reaction itself.

Interactive mechanism for axial alkylation of cyclohexanone enamine

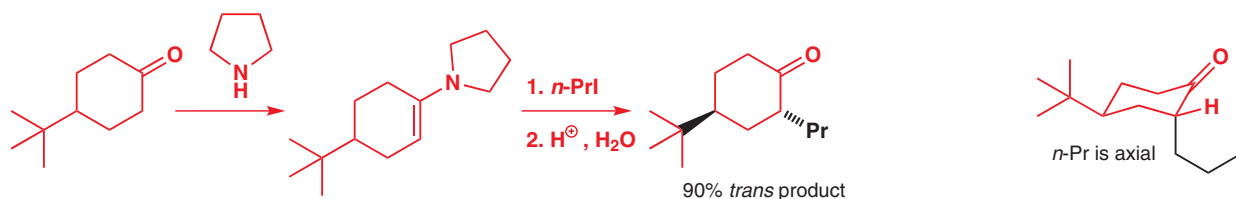

Enolate equivalents were discussed in Chapter 25.



To get at the reason for this result we need to look at the conformation of the enamine intermediate. At this point we shall generalize a bit more and write a structure that represents any enol derivative where X may be OH, O⁻, OSiMe₃, NR₂, and so on. The double bond ($2 \times sp^2$ centres) in the ring means the conformation is a partially flattened chair, as described above. We place the *t*-butyl group in an equatorial position because, as with cyclohexanes, it is so bulky it cannot go axial. This means that there is only one conformation to consider—the one shown in the margin.

Now, the electrophile must attack the π system of this conformation, and to do so it has to attack from more or less directly above or below because only then can it interact with one of the lobes of the p orbital at the enol position shown in orange. The need to interact with the π system is the reason cyclohexenes and related compounds react in an axial direction. The top of the molecule looks to be more open to attack so we shall try that approach first.

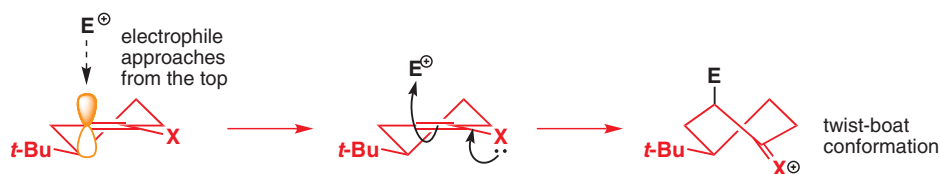

As the electrophile forms a bond to the trigonal carbon atom, that atom must become tetrahedral and it does so by forming a vertical bond upwards. The result is shown in the diagram—the ring turns into a twist-boat conformation. Now, of course, after the reaction is over, the ring can flip into a chair conformation and the new substituent will then be equatorial, but that information is not present in the transition state for the reaction. We could say that, at the time of reaction, the molecule doesn't 'know' it can later be better off and get the substituent equatorial: all it sees is the formation of an unstable twist boat with a high-energy transition state leading to it.

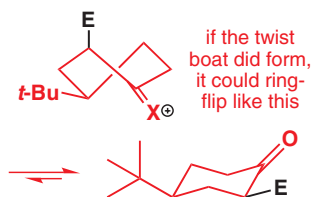

Attack from the apparently more hindered bottom face makes the trigonal carbon atom turn tetrahedral in the opposite sense by forming a vertical bond to the electrophile downwards. The ring goes directly to a chair form with the electrophile in the axial position.

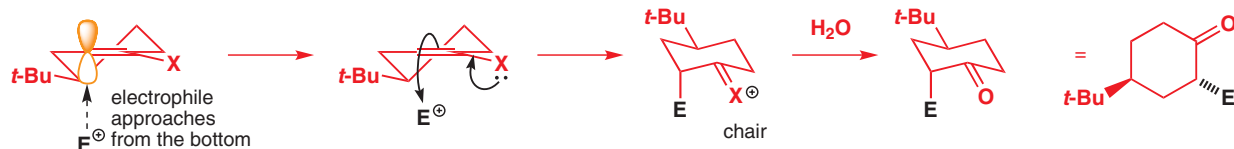

When the carbonyl group is restored by hydrolysis (if necessary—with an enolate X is already O) the ring need not flip: it's already a chair with the *t*-butyl equatorial, and the new substituent is axial on the chair. This is the observed product of the reaction.

It's important that you understand what is going on here. The reagent *has* to attack from an axial direction to interact with the p orbital. If it attacks from above, the new substituent is axial on an unstable twist boat. If it attacks from below, the new substituent is axial on a chair—granted, this is not as good as equatorial on a chair, but that's not an option—it has to be axial on something, and a chair is better than a twist boat. So this is the product that forms. It's just hard luck for the substituent that it can't know that *if it did* weather it out on the twist boat it could later get equatorial—it plumps for life on the chair and so has to be content with ending up axial.

Here is an example with an unsaturated carbonyl compound as an electrophile: the reaction is a Michael addition. The ketone here is slightly different—it has the *t*-butyl group in the 3- rather than the 4-position, and the reacting centre becomes quaternary during the Michael reaction. But the result is still axial attack.

➔ Such reactions were discussed in Chapter 25.

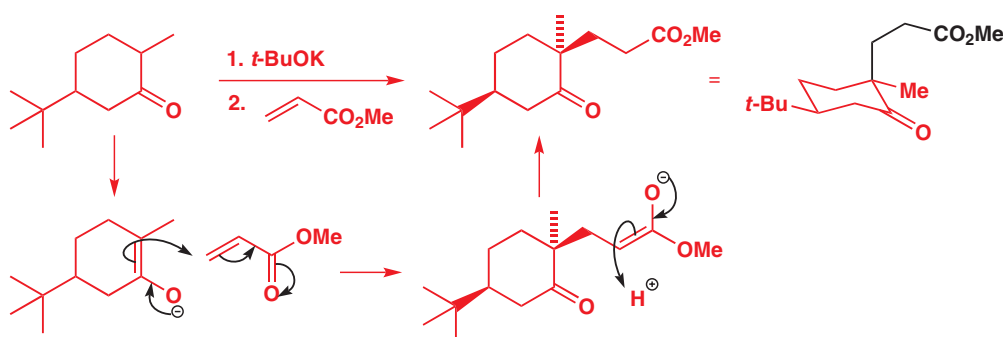

This result is more impressive because the large electrophile ends up on the *same* side of the ring as the *t*-butyl group, so the stereoselectivity cannot be based on any simple idea of reaction on the less hindered side of the ring. It is genuine axial attack, as the conformational diagram of the product confirms.

Cyclohexenones are even flatter than cyclohexenes, but it is convenient to draw them in a similar conformation. Conjugate addition to the substituted cyclohexenone in the margin gives the *trans* product.

This is also axial addition to form a chair directly (rather than a twist boat) with the nucleophile approaching from the bottom. We must draw the ring as a flattened chair.

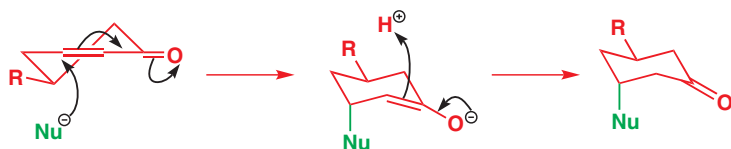
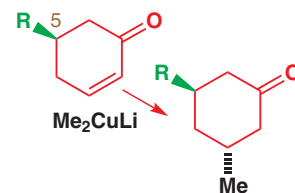

The 5-alkyl cyclohexenone that we have chosen as our example gives the best results. The mechanism suggests that the enolate intermediate is protonated on the top face (axial addition again), although we cannot tell this because the product has no stereogenic centre there. But, if we carry out a tandem reaction with the enolate trapped by a different electrophile, it becomes clear that the product is again that of axial attack.

■ Beware: you also get the same answer but for the wrong reason by saying that the nucleophile approaches from the less hindered side.

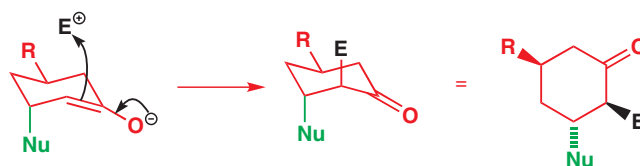

We shall end this section on conformational control in six-membered rings with the preparation of a useful chiral molecule, 8-phenylmenthol, from the natural product (*R*)-(+)-pulegone. The first step is a copper-promoted conjugate addition to an exocyclic alkene. A new stereogenic centre is formed by protonation of the enolate intermediate but with virtually no stereoselectivity.

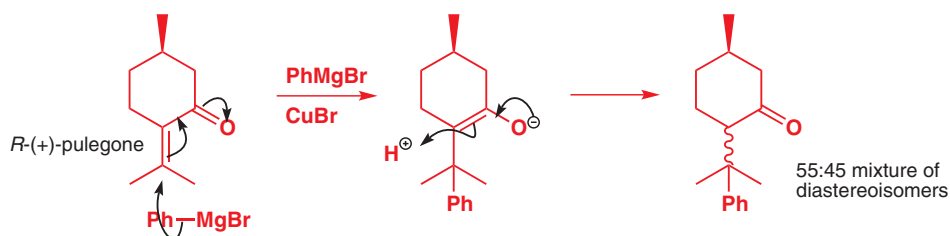

Now thermodynamic control can be brought into play. The position next to the ketone can be epimerized via the enolate to give the more stable isomer with both substituents equatorial. This improves the ratio of diastereoisomers from 55:45 to 87:13.

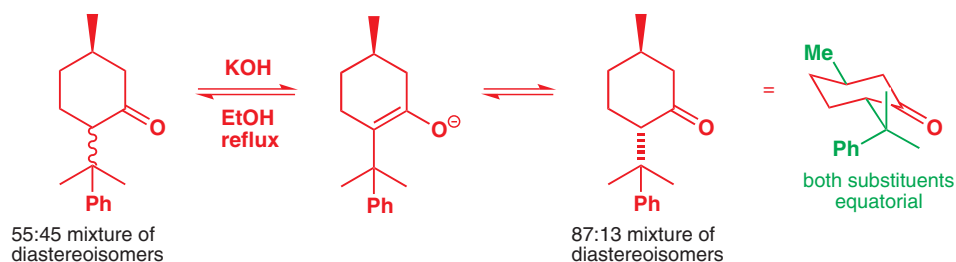

Now the ketone can be reduced with a small reagent (see p. 826)—Na in *i*-PrOH works well—to put the hydroxyl group equatorial. This means that all the product has OH *trans* to the large group next to the ketone, although it is still an 87:13 mixture of diastereoisomers with respect to the relative configuration at the centre bearing Me.

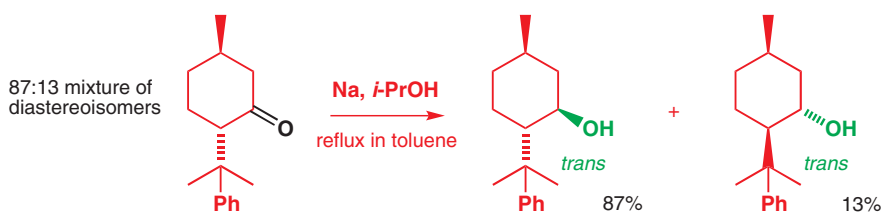

■ Na in *i*-PrOH is a single electron Birch-type reduction (see Chapter 23). You can't get much smaller than an electron!

■ The product, 8-phenylmenthol, can be used as a chiral auxiliary. See Chapter 41, p. 1113.

These alcohols can be separated (they are, of course, diastereoisomers and not enantiomers) and the major, all-equatorial, one is the useful one. This is an impressive example of conformational control by thermodynamic and by kinetic means originating only from a distant methyl group in a six-membered ring.

Reactions on small rings

The conformational principles which apply to rings other than six-membered ones are rather more sketchy because only six-membered rings adopt well-defined chair (or, for cyclohexenes, half-chair) conformations. But we can still give you some general guidelines and principles, and illustrate them with some important examples. We will look in detail at four- and five-membered rings.

➔ We looked at the effect of ring size on NMR spectra and on rates of ring closure in Chapter 31, see pp. 814 and 805.

Four-membered rings can be flat

Saturated four-membered rings have a slightly bent conformation but four-membered lactones are flat. The enolates of these lactones can be made in the usual way with LDA at $-78\text{ }^{\circ}\text{C}$ and are stable at that temperature, and they react with electrophiles just as you saw in Chapter 25. If the β -lactone has a substituent already then there may be a choice as to which face of the enolate is attacked by an electrophile. In the example below, simple alkylation with a variety of alkyl halides gives essentially only one diastereoisomer of the product.

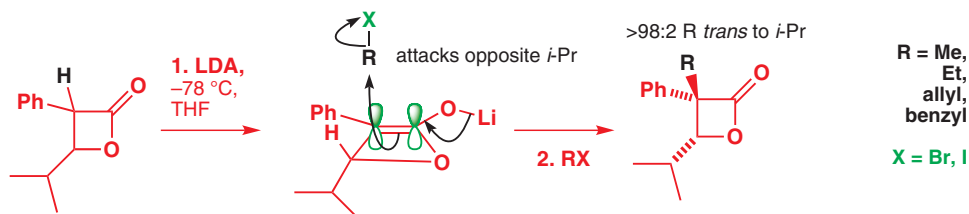

The enolate, as we have seen, is planar, and the phenyl group is in the plane (which is why it doesn't matter which of the two possible diastereoisomers of the starting material is used). The isopropyl group is the only thing out of the plane. The electrophile simply adds to the face of the enolate not blocked by the isopropyl group. This is a very simple case of a diastereoselective reaction.

Lactone enolates

This lithium enolate works well even though it might be expected to be unstable because of a simple elimination reaction. In general, it is not possible to make open-chain lithium enolates with β oxygen substituents like this because they do undergo elimination.

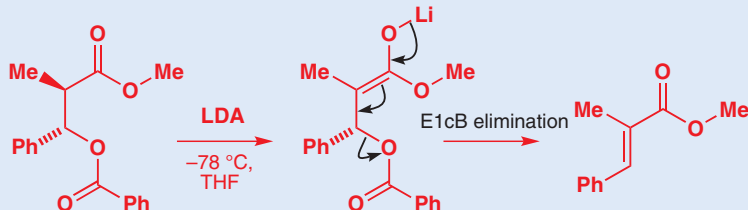

But, in the four-membered ring, the p orbitals of the enolate and the C–O single bond are orthogonal (see diagram below) so that no interaction between them, and no elimination, can occur. In the terminology of Baldwin's rules (Chapter 31, p. 810) it would be a disfavoured 4-*endo-trig* reaction.

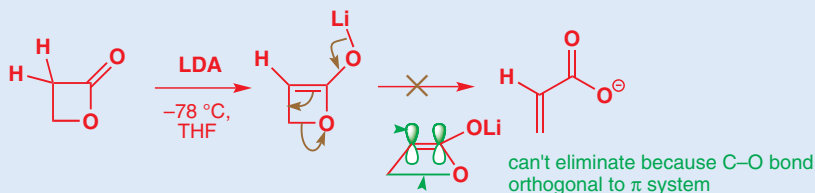

Reduction of substituted four-membered ring ketones is usually reasonably stereoselective. If the substituent is in the 3-position and small reagents like NaBH_4 are used, the *cis* isomer is favoured. Like saturated four-membered rings, cyclobutanones are slightly puckered to reduce eclipsing interactions between hydrogen atoms on adjacent carbon atoms, but attack of the reducing agent still occurs from the direction away from the other substituent to give the *cis* product.

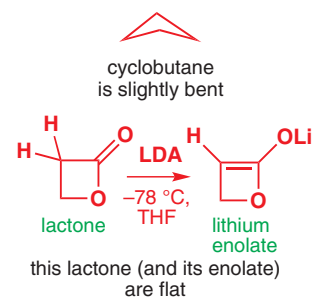

Diastereoselective reactions of racemic compounds

The stereoselectivity we are discussing in this chapter is *diastereoselectivity*; we are not concerned with enantiomers and all of our discussions are equally valid whether the starting materials are racemic or enantiomerically pure. The product here, as in many other examples in the chapter, is racemic so we could write (\pm) underneath the structure. In this particular reaction, the starting material can be either of two diastereoisomers, but one of its chiral centres is lost on formation of the enolate.

➔ We discussed this conformation and the consequences for NMR of its flexibility in Chapter 31, p. 817.

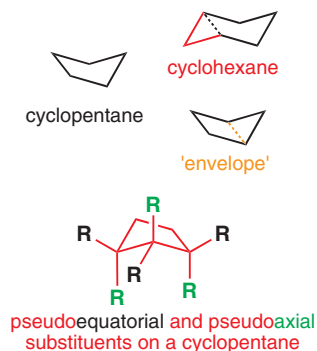

➔ We discussed the direction of attack on cyclohexanones on p. 826.

Five-membered ketones are flexible

A saturated five-membered ring has a conformation often called an 'envelope'. It looks a bit like an opened envelope with one atom at the point of the flap. The arrangement closely matches what you get if you cut one atom out of a cyclohexane ring. At any one moment, one of the carbon atoms is at the point of the envelope but rapid ring flipping equilibrates all these conformers so that all five atoms are, on average, the same.

Substituted cyclopentanes can have substituents in pseudoaxial or pseudoequatorial positions (in other words, they are somewhat like the axial and equatorial positions in a cyclohexane), but rapid equilibration means that overall we have a very flexible and labile system. As a result, reduction of 2-substituted cyclopentanones may not be very stereoselective. What selectivity there is (about 3:1) in the reduction of 2-methylcyclopentanone with LiAlH_4 favours pseudoaxial attack in the conformation drawn, as is reasonable for a small nucleophile.

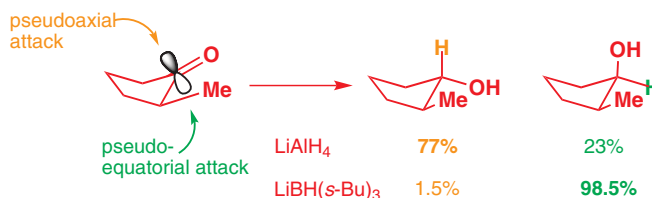

The use of a much more bulky reducing agent such as $\text{LiBH}(\text{s-Bu})_3$ dramatically reverses and increases the stereoselectivity. Essentially only the *cis* compound is formed.

Regard five-membered rings with two or more sp^3 carbons as flat

When there are two or three trigonal carbons in the ring, the ring is flatter and reactions such as enolate alkylation and conjugate addition give excellent stereoselectivity even with a simple cyclopentane ring. Unsaturated five-membered lactones (known as 'butenolides') give a very clear illustration of stereochemically controlled conjugate addition. There is only one possible stereogenic centre and the ring is almost planar so we expect nucleophilic attack to occur from the less hindered face. Cuprates are good nucleophiles for this reaction and here Me_2CuLi adds to the unsaturated lactone.

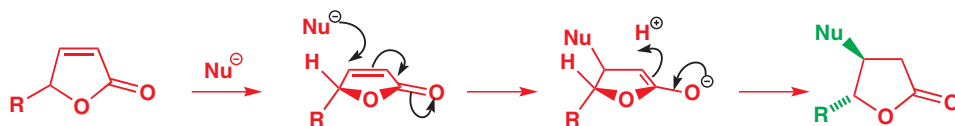

With a single enantiomer of the starting material below, the product is the single enantiomer of an insect pheromone.

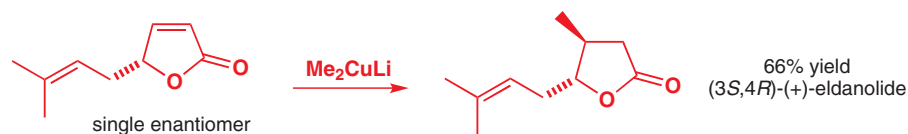

It is not even necessary to have a stereogenic centre in an unsaturated ring if we want to create stereochemistry. A tandem conjugate addition and alkylation creates two new stereogenic centres in one operation. The conjugate addition of a lithium cuprate makes a lithium enolate, which will react in turn with an alkyl halide. The product is usually *trans*.

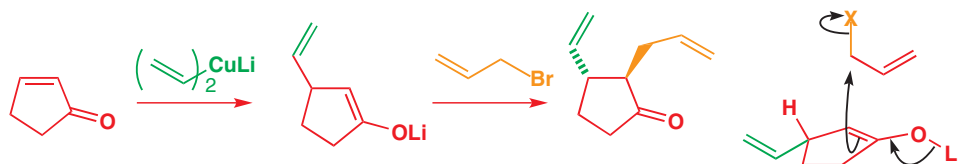

■ This would be a good point at which to remind you of what we stressed in Chapter 14. If all the starting materials and reagents are achiral or racemic the products must be too. That has been the case in many of the reactions so far in this chapter: we haven't put in (\pm) under every compound but we could have done. But here we do have a single enantiomer of starting material so we get a single enantiomer of product. Diastereoselectivity is the same whether the starting material is enantiomerically pure or racemic.

The key step is the alkylation of the enolate intermediate. Enolates in five-membered rings are almost flat and the incoming orange allyl bromide prefers the less hindered face away from the recently added green vinyl group.

Our main example of enolate reactions in five-membered rings is one of some general importance. It illustrates how stereochemical information can be transmitted across a ring even though the original source of that information may be lost during the reaction. That may sound mysterious, but all will become clear. The first reaction is to make a five-membered cyclic acetal from an optically active hydroxy-acid. Our example shows (*S*)-(+)-mandelic acid reacting with *t*-BuCHO.

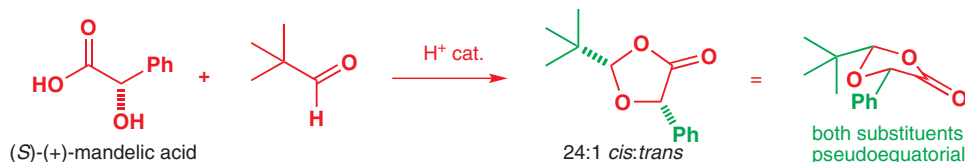

Acetal formation involves nucleophilic attack of the OH group on the aldehyde so there is no change at the stereogenic centre. The stereochemistry of the new (acetal) centre may surprise you—why should the *cis* isomer be so favoured? This is a conformational effect as both substituents can occupy pseudo-equatorial positions.

Now, if we make the lithium enolate with LDA, the original stereogenic centre is destroyed as that carbon becomes trigonal and planar. The only stereogenic centre left is the newly introduced one at the acetal position.



The ring is now essentially flat, owing to the C=C bond within it, and reaction of the enolate with an electrophile is again a simple matter of addition to the face of the enolate opposite to the *t*-butyl group.

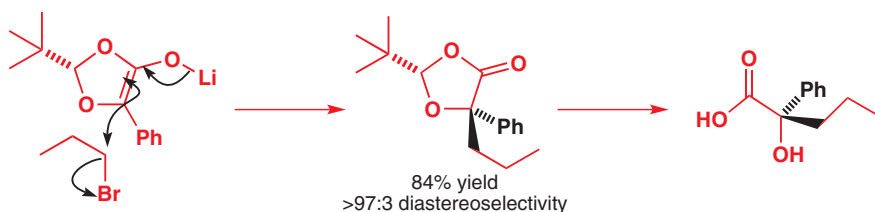

If the acetal is now hydrolysed, the new stereogenic centre is revealed as an alkylated version of the starting material. It may appear that the alkylation has happened stereospecifically with retention, but what has really happened is that the new stereogenic centre in the acetal intermediate has relayed the stereochemical information through the reaction.

Five-membered rings also allow us to explore electrophilic attack on alkenes. A simple 4-substituted cyclopentene has two different faces—one on the same side as the substituent and one on the opposite side. Epoxidation with a peroxy-acid occurs preferentially on the less hindered face.

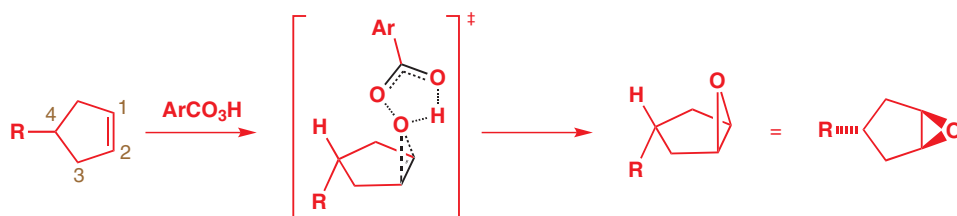

■ The conjugate addition forms a lithium enolate regioselectively, and that was why you met this sequence in Chapter 25. We showed you a dramatic use of the stereoselectivity there as well, in a synthesis of a prostaglandin (p. 604).

■ Check that you can write the mechanisms for acetal formation (Chapter 11). Acetal formation is under thermodynamic control so the product produced is the more stable.

➔ The mechanism of RCO_3H epoxidation was discussed on p. 430.

■ Note that this reaction is diastereoselective—but neither starting material nor products are chiral. Diastereoselectivity need have nothing to do with chirality!

In the transition state (marked ‡) the peroxyacid prefers to be well away from R, even if R is only a methyl group (the selectivity is 76:24 with R=Me).

The opposite stereoselectivity can be achieved by bromination in water. The bromonium ion intermediate is formed stereoselectively on the less hindered side and the water is forced to attack stereospecifically in an S_N2 reaction from the more hindered side.

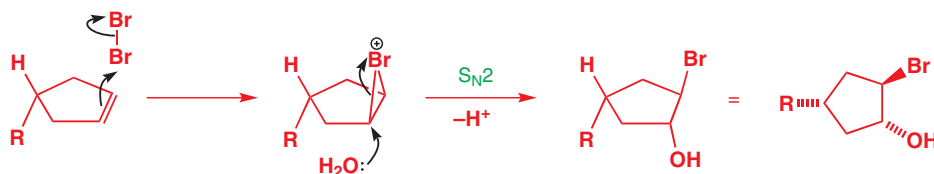

■ You will spot that this reaction is no longer bimolecular because the nucleophile and leaving group are part of the same molecule. We still call it S_N2 because the pathway of the mechanism is identical with a normal S_N2 reaction. Substitution reactions were discussed in detail in Chapter 15.

Treatment of the product with base (NaOH) gives an epoxide by another S_N2 reaction in which oxygen displaces bromide. This is again stereospecific and gives the epoxide on the same side as the R group.

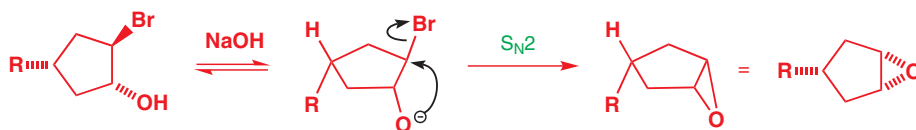

Two substituents on the *same side* of a five-membered ring combine to dictate approach from the other side by any reagent, and the two epoxides can be formed each with essentially 100% selectivity.

➔ *N*-Bromosuccinimide (NBS) acts as a source of electrophilic bromine: see Chapter 19, p. 441.

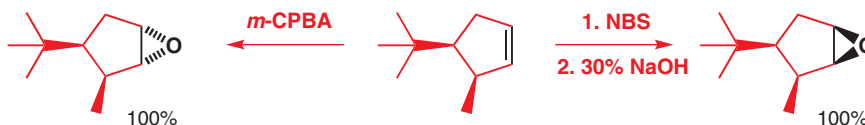

Regiochemical control in cyclohexene epoxides

The two reactions above illustrate two important ways of making an epoxide. We are now going to look in a little more detail at what happens when epoxides are opened—a reaction that is essentially the reverse of the epoxide-closing reaction you have just seen. Here are both reactions with the epoxide fused to a cyclohexane ring:

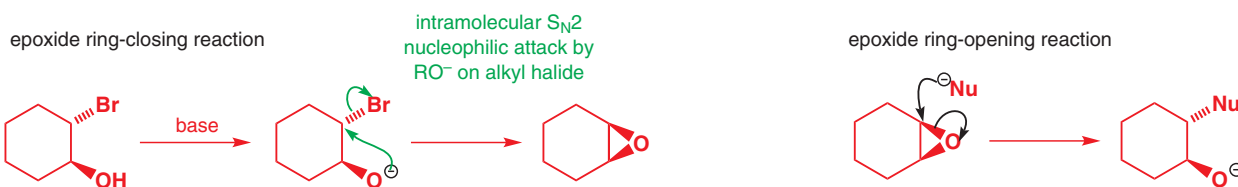

Epoxides can be formed from compounds containing an adjacent hydroxyl group and a leaving group by treatment with base. The epoxide formation is an intramolecular S_N2 reaction, and as with any S_N2 substitution, inter- or intramolecular, the incoming nucleophile must still attack into the σ^* orbital of the leaving group. And the only way that can happen, as you can see from the diagrams below, is (a) if the hydroxyl group and leaving group are *trans* to one another and (b) if the hydroxyl group and leaving group are both orientated axially. For the *trans* diastereoisomer, the groups can of course adopt either a diequatorial or a diaxial arrange-

ment (the diequatorial arrangement is favoured, as you saw in Chapter 16) but only the diaxial can react. The *cis* diastereoisomer cannot form an epoxide.

■ In Chapter 36 you will meet the alternative **rearrangement reactions** that occur if you try to force *cis* substituted compounds like these to react.

trans-2-bromocyclohexanol

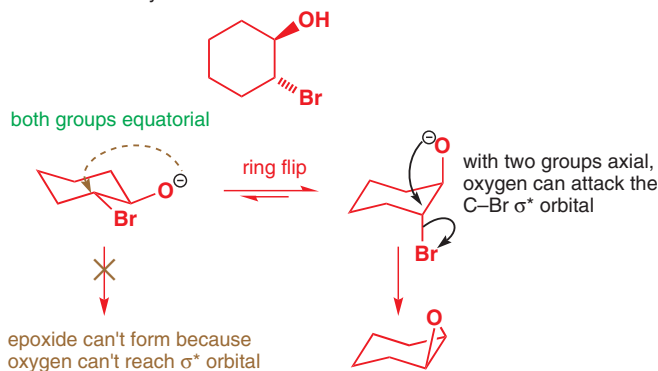

cis-2-bromocyclohexanol

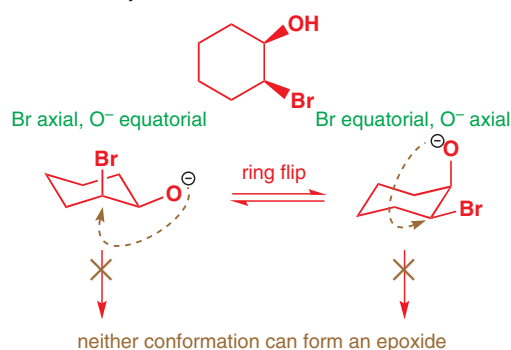

How should we draw this epoxide fused to a six-membered ring? It is impossible for the CO bonds of the product epoxide ring to adopt perfectly axial and equatorial positions. If you make a model of cyclohexene oxide (as we can call this epoxide) you will see that the ring is a slightly deformed chair—in fact it is like the half-chair conformation of cyclohexene, in which four of the carbon atoms are in the same plane (you met this on p. 829).

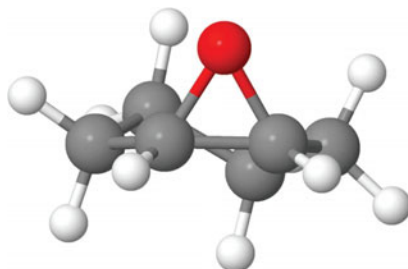

model of cyclohexene oxide

The usual way of drawing cyclohexene oxide is shown below: the distortion due to the three-membered ring changes the orientation of the axial and equatorial hydrogens next to the ring—they are **pseudoaxial** and **pseudoequatorial**. The hydrogens on the back of the ring (this part of the ring remains about the same as in the chair conformation) can be still considered as 'normal' axial and equatorial hydrogens.

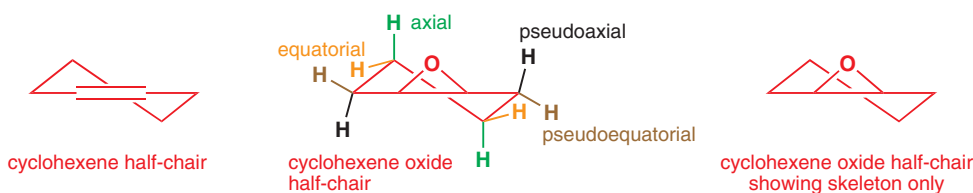

You saw above that the epoxide-forming reaction is essentially the reverse of the epoxide-opening reaction. If we took a snapshot of the transition state for either reaction, we would not be able to tell whether it was the RO⁻ that was attacking the C-X σ^* orbital to form the epoxide with X⁻ as a leaving group, or a nucleophile X⁻ attacking the C-O σ^* orbital of the epoxide to form a ring-opened alcohol. In other words, the transition state is the same for both reactions.

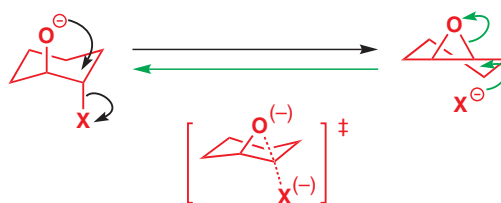

this transition state is the same for both formation and ring opening of the epoxide

Since ring closure is possible only when the starting material is diaxially substituted, this has to mean that ring opening is similarly possible only if the *product* is diaxial. This is a general principle: *ring opening of cyclohexene oxides always leads directly to diaxial products*. The diaxially substituted product may then subsequently flip to the diequatorial one, but it is always the one that is initially formed.

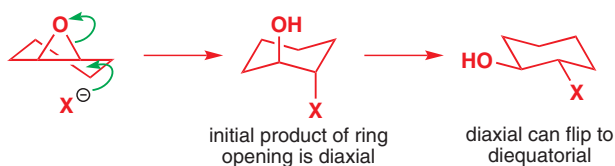

How do we know this to be true? If the ring bears a bulky substituent, ring flipping is impossible and the diaxial product has to stay diaxial. An example is nucleophilic attack of halide on the two epoxides shown below. The fact that the ring is a piperidine, rather than a cyclohexane, does not matter. The equatorial phenyl group fixes the conformation, and the regiochemistry of the epoxide opening with azide depends only on the relative stereochemistry of the starting material.



Points to note:

- The nucleophile must attack from the opposite side of the epoxide, allowing it to put electrons into the C–O σ^* orbital. This means that the nucleophile and hydroxyl group always end up *trans* in the product.
- The phenyl group locks the conformation of the epoxide. It stays equatorial, so we only have one epoxide conformation to consider in each case.
- In each case the epoxide opens only at the end that gives the diaxially substituted chair. Ring opening at the other end would still give a diaxially substituted product, but it is a diaxially substituted high-energy twist-boat conformation. The twist boat can, in fact, flip to give an all-equatorial product, but in a kinetically controlled

process such as this, it is the barrier to reaction that matters, not the stability of the final product.

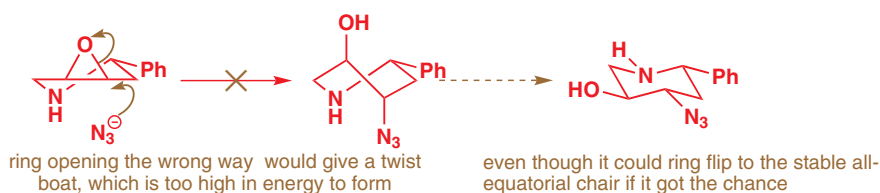

● **Some general observations on stereo- and regioselectivity in six-membered rings:**

- Six-membered rings which are not already a chair (such as cyclohexenes and cyclohexene oxides) react in such a way that they immediately become a chair.
- They do so by reacting from an axial direction: this may also dictate the *regioselectivity* of the reaction.
- Six-membered rings which are chairs already (such as cyclohexanones) remain a chair, and react from either the axial or equatorial direction according to the size of the attacking reagent.

Stereoselectivity in bicyclic compounds

We have just looked at the way the reactivity of an epoxide gains additional subtleties when it is fused into a bicyclic structure with a six-membered ring. We're now going to look more generally at bicyclic compounds and their reactivity, and consider some features of their stereoselective reactions.

Bridged bicyclic rings

There are broadly three kinds of bicyclic compounds. If we imagine adding a second five-membered ring to one already there, we could do this in a bridged, fused, or *spiro* fashion, as you see in the margin. Bridged bicyclic compounds are just what the name implies—a bridge of atom(s) is thrown across from one side of the ring to the other. Fused bicyclic compounds have one *bond* common to both rings, while *spiro* compounds have one *atom* common to both rings.

You will notice that these three types of bicyclic compounds with five-membered rings have different numbers of atoms added to a 'parent' five-membered ring. The bridged compound has two extra atoms, the fused compound three, and the spiro compound four. These are marked in green with the original five-membered ring in red. We shall consider stereoselectivity in each of these types of bicyclic ring systems, starting with bridged structures.

The bridged ring shown in the margin is known as norbornane: it's a simple but very important skeleton on which many other structures are based, and it's worth spending a moment learning how to draw it convincingly. The instructions in the box overleaf tell you how! Another way of looking at norbornane is as a six-membered ring held in a boat conformation by a one-carbon bridge. The bridge has to be axial at both bridgehead positions (or it wouldn't be able to form a ring) so the cyclohexane has no choice but to be a boat.

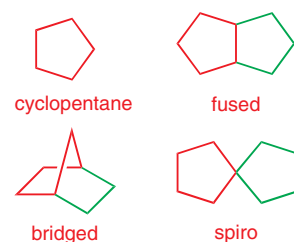
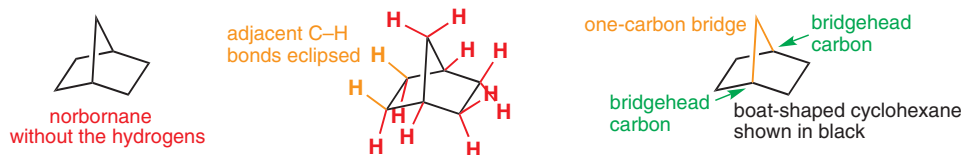

Naming bicyclic compounds

As usual we shall not spend too long on nomenclature, but you may hear norbornane structures referred to as 'bicyclo[2.2.1]heptanes'. The 'bicyclo' and 'heptane' parts are self explanatory. The numbers (always separated by dots) refer to the lengths of the bridges linking the two bridgehead carbons. The other two compounds in the margin above are thus bicyclo[3.3.0]octane and spiro[4.4]nonane.

How to draw norbornane structures

The easiest way to draw a convincing norbornane is to start with the bridge: draw a sort of skewed upwards chevron as shown in **1**. Then join the ends of the chevron with three bonds, as in **2**, making sure to break one of them as it passes behind the chevron, to give an impression of the three-dimensional shape of the molecule. Finally, link the second ring round to the right, **3**.

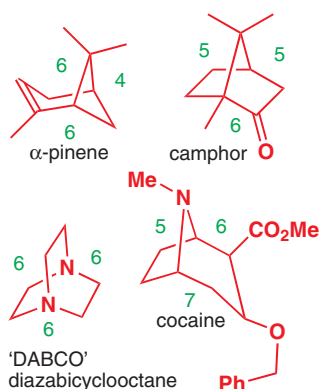
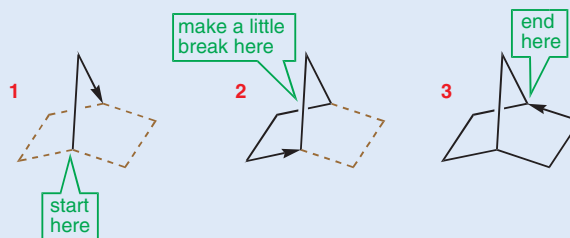

A selection of important bridged bicyclic compounds is shown in the margin. Bridged structures (sometimes called cage structures) are generally very rigid, spending most of their time in a single, well-defined conformation, and this rigidity is reflected in the stereochemistry of their reactions. For example, attack on norbornanone occurs predominantly from the side of the one-atom bridge (the green arrow) rather than the two-atom bridge (the orange arrow).

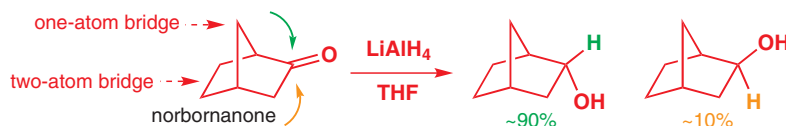

This selectivity is completely reversed in camphor because the one-atom bridge then carries two methyl groups. One of these must project over the line of approach of the hydride reducing agent.

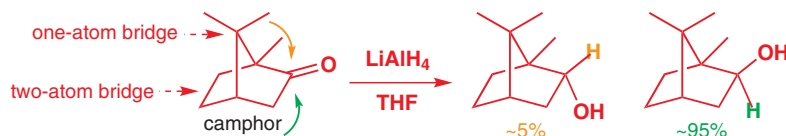

The two methyl groups on the bridge of the camphor molecule are key features in stereoselective reactions—take them away and the result often changes dramatically. This bicyclic system, with and without methyl groups, has been so widely used to establish stereochemical principles that the two faces of, say, the ketone group in camphor, or the C=C double bond in norbornene (the alkene derivative of norbornane) have been given the names *endo* and *exo*. These refer to inside (*endo*) and outside (*exo*) the boat-shaped six-membered ring shown in black. In general, reactions of norbornane-type structures occur from the less hindered *exo* face, but the methyl groups of camphor reverse this selectivity to favour *endo* attack:

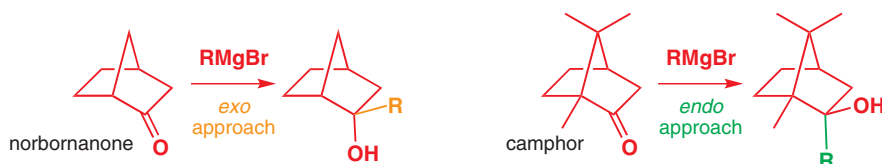
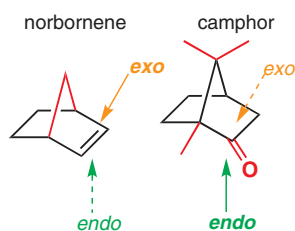

In a similar style, epoxidation of the two alkenes is totally stereoselective, occurring *exo* in norbornene and *endo* when methyl groups are present on the bridge. These stereoselectivities would be remarkable in a simple monocyclic compound, but in a rigid bridged bicyclic structure they are almost to be expected.

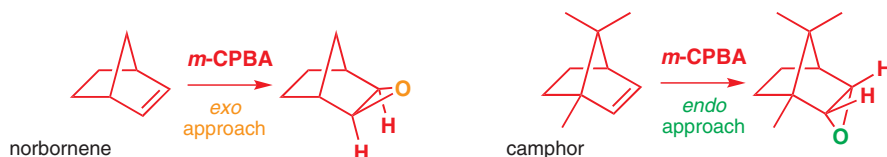

Reactions that break open bridged molecules can preserve stereochemistry

Some powerful oxidizing agents are able to cleave C–C bonds. Oxidation of camphor with concentrated nitric acid cleaves a C–C bond adjacent to the C=O group and produces a diacid known as camphoric acid. The usual reagent is nitric acid (HNO_3) and oxidation goes via camphor's enol.

➔ This is an unusual reaction; more common is cleavage of C=C bonds with ozone, as you saw in Chapter 19.

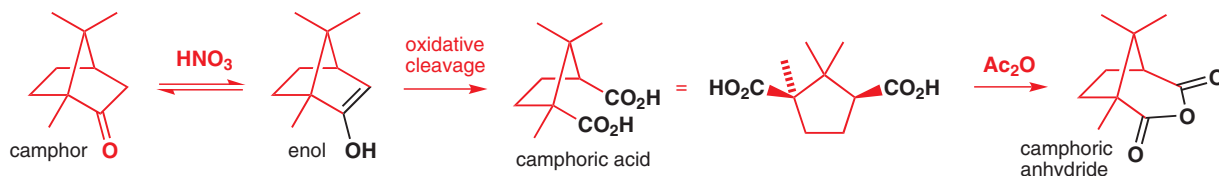

Because the bridge holds the molecule in a fixed conformation, the cleaved diacid has to have a specific stereochemistry. There is no change at the stereogenic centres, so the reaction must give retention of configuration. We can confidently write the structure of camphoric acid with *cis*-CO₂H groups, but any doubt is dispelled by the ability of camphoric acid to form a bridged bicyclic anhydride.

Fused bicyclic compounds

trans-Fused rings

The ring junction of a fused 6,5-membered ring system can have *cis* or *trans* stereochemistry, and so can any pair of larger rings. For smaller rings, *trans* 5,5- and 6,4-ring junctions can be made, with difficulty, but with smaller rings *trans* ring junctions are essentially impossible.

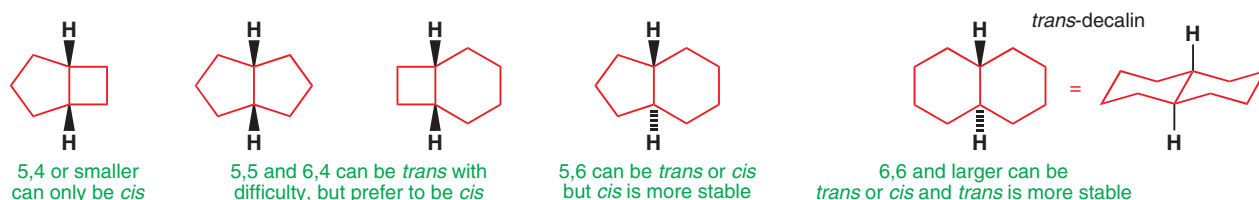

The *trans*-fused 6,6 systems—*trans*-decalins—have been very widely studied because they form an important part of the structure of steroids. Their conformation was discussed in Chapter 16: they prefer a *trans* ring junction as *trans*-decalins have all-chair structures with every bond staggered from every other bond. We can show this by giving a 6,6 system the choice: reducing this enone with lithium metal gives a lithium enolate (Chapter 25). Protonation of this anion with the solvent (liquid ammonia) gives a *trans* ring junction.

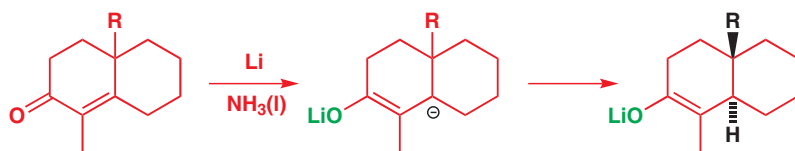

The lithium enolate remains and can be alkylated with an alkyl halide in the usual way. When there are hydrogen atoms at both ring junction positions, axial alkylation occurs just as you should now expect, and a new ketone with three stereogenic centres is formed with >95% stereoselectivity.

■ In this scheme, and the next, the methyl group attached at the yellow p orbital has been omitted for clarity.

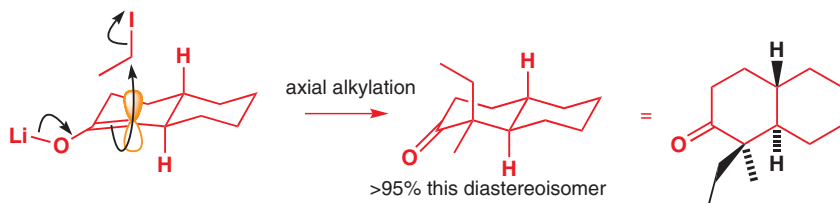

However, if there is anything else—even a methyl group—at the ring junction, so that axial approach would give a bad 1,3-diaxial interaction in the transition state, the usual stereoselectivity is overridden and the reaction switches to alkylation on the other face:

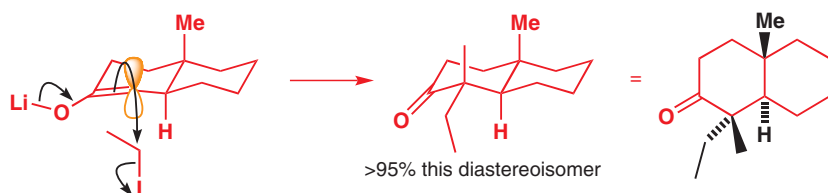

cis-Fused rings

➔ See the box on p. 839 for an explanation of the name bicyclo[1.1.0]butane.

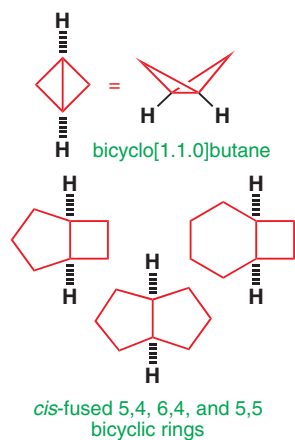

➔ You met catalytic hydrogenation in Chapter 23. For a reminder of what **stereoselective** and **stereospecific** mean, see p. 396.

Almost any *cis*-fused junction from 3,3 upwards can be made. Even bicyclo[1.1.0]butane exists, although it is not very stable. *cis*-Fused 4,5, 4,6, and 5,5 systems are common and are much more stable than their *trans* isomers.

Any method of making such bicyclic compounds will therefore automatically form this stereochemistry. Consider this hydrogenation:

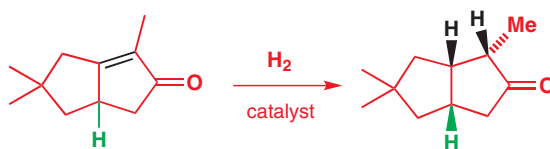

The two new hydrogen atoms (shown in black) must, of course, add *cis* to one another: this is a consequence of the stereospecificity of the reaction. What is interesting is that they have also added *cis* to the green hydrogen atom that was already there. This approach does give the more stable *cis* ring junction but the stereochemistry really arises because the other ring hinders approach to the other face of the alkene. Think of it in the way illustrated below: the alkene has two different faces. On one side there is the green hydrogen atom, and on the other the orange parts of the second ring. To get hydrogenated, the alkene must lie more or less flat on the catalyst surface and that is easier on the top face as drawn.

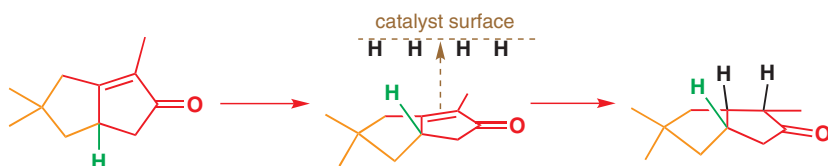

You can think of *cis*-fused rings as looking like a butterfly or an open book. The key to stereoselectivity in their reactions is that everything happens on the outside (on the cover of the book—the *exo* face). Nucleophiles add to carbonyl groups from the outside, enolates react with alkyl halides or Michael acceptors on the outside, and alkenes react with peroxyacids on the

outside. Notice that this means the same side as the substituents at the ring junction. The rings are folded away from these ring-junction substituents, which that are also on the outside.

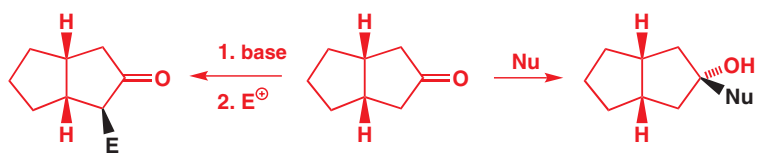

A real example comes in the acylation (Chapter 26) of the enolate from the keto-acetal below. The molecule is folded downwards and the enolate is essentially planar, so the outside face is the top face as drawn. Addition presumably occurs entirely from the outside, although the final stereochemistry of the product is controlled thermodynamically because of reversible enolization of the product, allowing the black ester group to adopt the less hindered outside position.

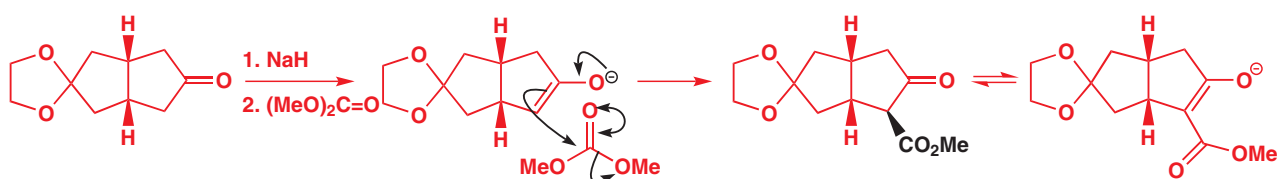

Reduction of the ketone product also occurs exclusively from the outside and this has the surprising effect of pushing the new OH group into the inside position. Attack from the inside is very hindered in this molecule because one of the acetal oxygen atoms is right on the flight path.

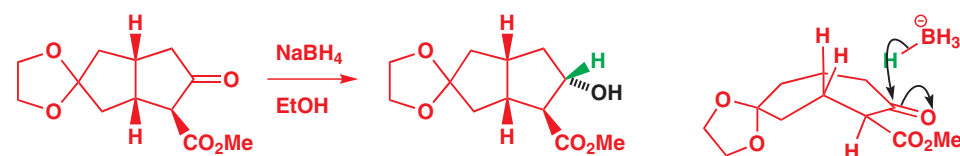

The important metabolite biotin has a *cis* bicyclic structure in which an alkyl chain lies on the more hindered face of the molecule, and any successful synthesis has to address this particular problem. You saw in Chapter 27 that sulfur stabilizes an adjacent anion, but the direct alkylation of the sulfide below is no good because the new alkyl group will go *exo*. Instead, the sulfide was oxidized to a sulfoxide from the *exo* face, giving an 8:1 ratio of *exo:endo* sulfoxides. Alkylation of the cyclic sulfoxide results in *trans* stereochemistry between the new alkyl group and the sulfoxide oxygen atom, forcing formation of the desired (*endo*) product. The synthesis is diastereoselective—but not enantioselective since there is no way of distinguishing the left and right sides of the symmetrical sulfoxide.

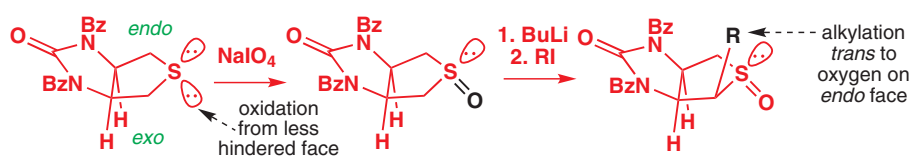

■ You will see in a moment more ways of forcing groups onto the inside face of bicyclic molecules.

A simple example of epoxidation occurs with a cyclobutene fused to a five-membered ring. This is a very rigid system and attack occurs exclusively from the outside to give a single epoxide in good yield.

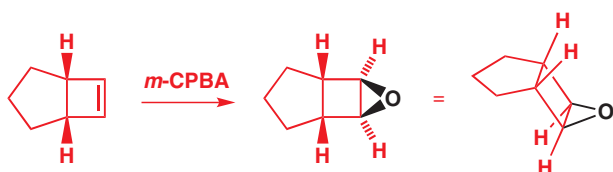

Epoxidation is stereospecific and *cis*—both new C–O bonds have to be on the same face of the old alkene. But Chapter 19 introduced you to several electrophilic additions to alkenes that were stereospecific and *trans*, many of them proceeding through a bromonium ion. If stereospecific *trans* addition occurs on a *cis*-fused bicyclic alkene, the electrophile will first add to the outside of the molecule, meaning the nucleophile will then be forced to add from the inside. A telling example occurs when the 5,4 fused unsaturated ketone below is treated with *N*-bromoacetamide in water.

■ *N*-Bromoacetamide, like NBS (p. 836), simply provides Br₂ in low concentration.

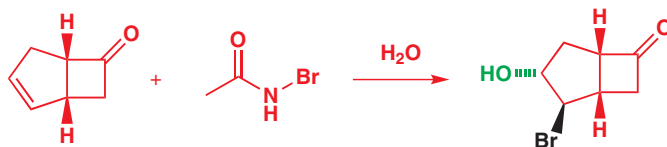

The bromonium ion is formed on the outside of the rigid structure and the water is then forced to add from the inside to get *trans* addition. As well as exhibiting stereospecificity (*trans* addition) and stereoselectivity (bromonium forms on outside), this reaction also exhibits regioselectivity in the attack of water on the bromonium ion. Water must come from inside, and it attacks the less hindered end of the bromonium ion.

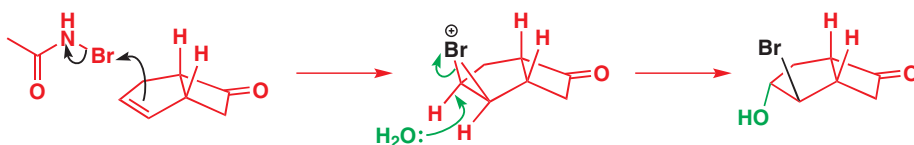

After protection of the OH group, treatment with base closes a three-membered ring to give a remarkably strained molecule. The ketone forms an enolate and the enolate attacks the alkyl bromide intramolecularly to close the third ring. This enolate is in just the right position to attack the C–Br bond from the back, precisely because of the folding of the molecule.

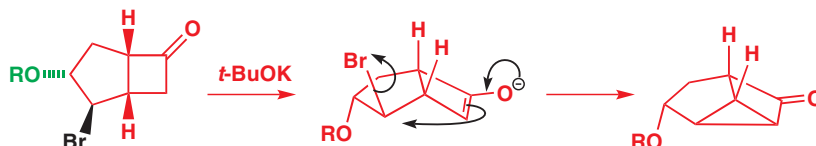

Inside/outside selectivity may allow the distinction between two otherwise similar functional groups. The *cis*-fused bicyclic diester below may look at first rather symmetrical but ester hydrolysis leaves one of the two esters alone while the other is converted to an acid.

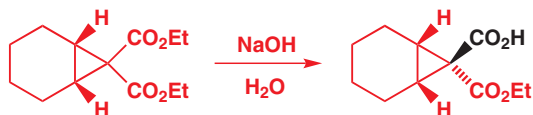

Only the outside ester—on the same side as the ring junction hydrogens—is hydrolysed. In the mechanism for ester hydrolysis, the rate-determining step is the attack by the hydroxide ion so the functional group *increases* in size in the rate-determining step. This will be much easier for the ester in the outside than for the one inside the half-open book.

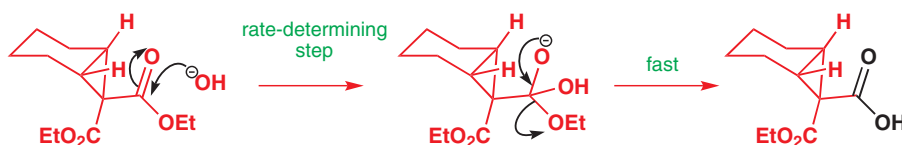

The end result is again that the larger of the two groups is on the inside! There are other ways to do this too. If we alkylate the enolate of a bicyclic lactone, the alkyl group (black) goes on

the outside as expected. But what will happen if we repeat the alkylation with a different alkyl group? The new enolate will be flat and the stereochemistry at the enolate carbon will be lost. When the new alkyl halide comes in, it will approach from the outside (green) and push the alkyl group already there into the inside.

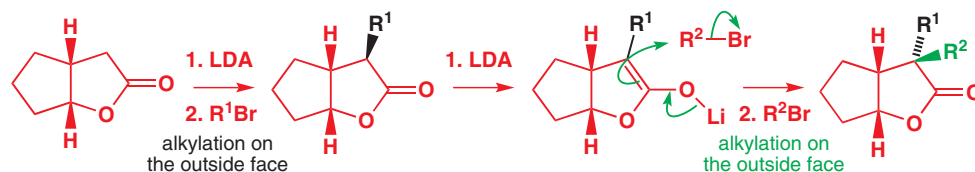

Should you wish to reverse the positions of the two groups, you simply add them in the reverse order. Whichever group is added first finishes on the inside; the other finishes on the outside.

Reactions of *cis*-decalins

You saw in Chapter 16 that while *trans*-decalins are rigid, *cis*-decalins can flip rapidly between two all-chair conformations. During the flip, all substituents change their conformation. The substituent R is axial on ring B in the first conformation of *cis*-decalin shown below but equatorial in the second. The ring junction Hs are always axial on one ring and equatorial on the other. The green hydrogen is equatorial on ring A and axial on ring B in the first conformation and vice versa in the second. Of course, they are *cis* in both. Because R gets equatorial, the second conformation is preferred in this case.

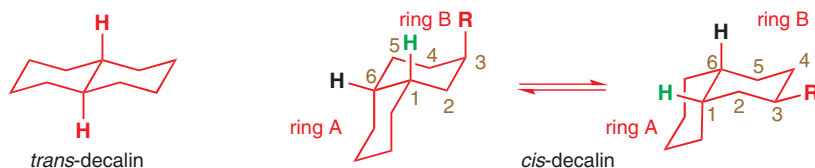

A standard reaction that gives substituted decalins is the Robinson annelation (Chapter 26). A Robinson annelation product available in quantity is the keto-enone known sometimes as the **Wieland–Miescher ketone** and used widely in steroid synthesis. The non-conjugated keto group can be protected or reduced without touching the more stable conjugated enone.

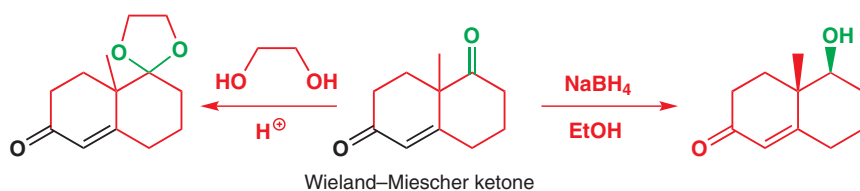

➔ The synthesis of this ketone can be found in Chapter 26, p. 638.

If either of these products is reduced with hydrogen and a Pd catalyst (the alcohol is first made into a tosylate), the *cis*-decalin is formed because the enone, although flattened, is already folded to some extent. A conformational drawing of either molecule shows that the top surface is better able to bind to the flat surface of the catalyst.

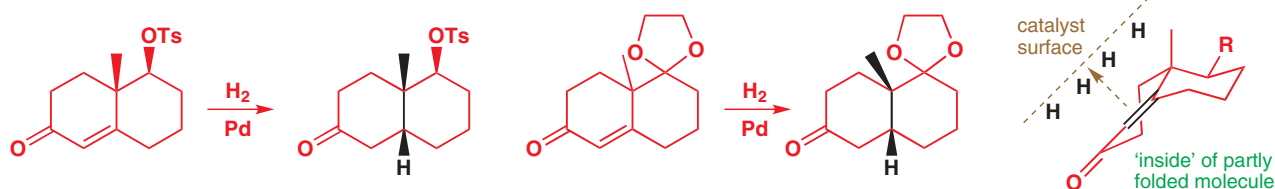

Each of these products shows interesting stereoselective reactions. The ketal can be converted into an alkene by Grignard addition and E1 elimination, and then epoxidized. Everything happens from the outside as expected, with the result that the methyl group is forced inside at the epoxidation stage.

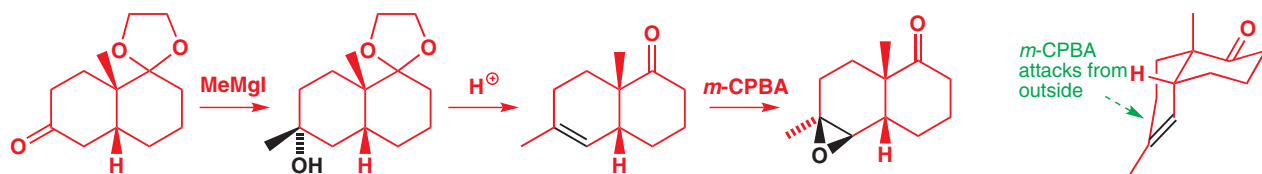

Treatment of the other product, the keto-tosylate, with base leads to an intramolecular enolate alkylation—a cyclization on the inside of the folded molecule that actually closes a four-membered ring. The reaction is easily seen in conformational terms and the product cannot readily be drawn in conventional diagrams.

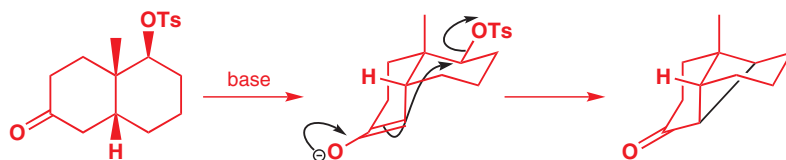

A similar reaction happens on the epoxide to produce a beautiful cage structure. This time it is a five-membered ring that is formed, but the principle is the same—the molecule closes across the fold rather easily. The new stereogenic centres can only be formed with this configuration: no other stereoisomer would be a feasible structure.

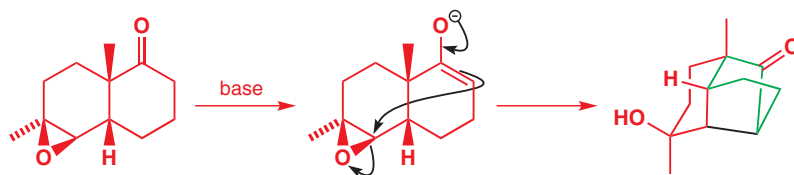

■ Notice how the ring in green has to go into a boat conformation for cyclization to be possible. This is unfavourable but still better than any intermolecular reaction.

● A summary of stereoselective reactions that occur on *cis*-fused rings

1 Reactions on the outside.

- Nucleophilic additions to carbonyl groups in the ring.
- Reactions of enolates of the same ketones with electrophiles: alkyl halides, aldols, Michael additions.
- *cis*-Additions to cyclic alkenes: hydrogenation, hydroboration, epoxidation.

2 Reactions on the outside and then the inside.

- *trans*-Additions to cyclic alkenes: bromination, epoxidation, and epoxide opening.

3 Reactions on the inside.

- Bond formation across the ring(s).

Spirocyclic compounds

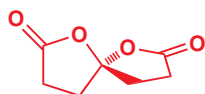

Spirocyclic rings meet at one single atom. This means that the two rings are orthogonal about the tetrahedral atom that is common to both. Even symmetrical-looking versions are unexpectedly chiral. The compound in the margin, for example, is not superimposable on its mirror image, and its symmetry is similar to that of an allene (see Chapter 14).

These sorts of compounds may look rather difficult to come by, but some simple ones are readily made. Cyclization of this keto-acid with polyphosphoric acid leads to a spirocyclic diketone. The *spiro* compound is formed because the more substituted enol is preferred in acid solution.

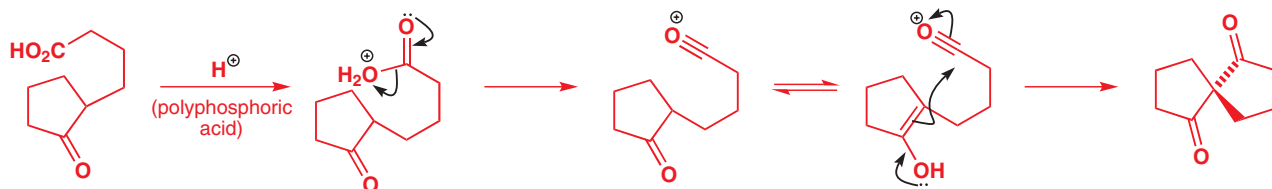

It is much more difficult to pass stereochemical information from one ring to the other in spirocyclic compounds because of the orthogonality of the rings. Still, some reactions are surprisingly stereoselective—one such is the reduction of the spirocyclic diketone that we made a moment ago. Treatment with LiAlH_4 gives one diastereoisomer of the spirocyclic diol.

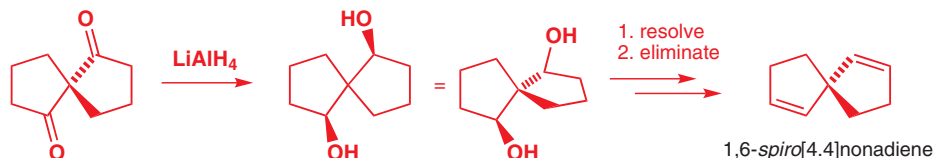

The diol can be resolved and used to make the very simple spiro-diene as a single enantiomer. The diene is chiral even though it has no chiral centre because it does not have a plane of symmetry.

■ In Chapter 14 we explained that planes of symmetry, not chiral centres, are the things to look for when deciding whether or not a compound is chiral.

Reactions with cyclic intermediates or cyclic transition states

Rings are so good at controlling stereochemistry (as you have seen) that it's well worth introducing them where they are not really necessary in the final product, simply in order to enjoy those high levels of stereochemical control. In the rest of this chapter we shall consider the use of temporary rings in stereochemical control: these might be cyclic intermediates in a synthetic pathway, or cyclic reaction intermediates, or even merely cyclic transition states. All aid good stereocontrol. We shall concentrate on examples where the ring reverses the normal stereoselectivity so that some different result is possible.

Tethered functional groups can reach only one side of the molecule

The proverbial donkey starved to death in the field with two heaps of hay because it could not decide which one to go for first. If the donkey had been tethered to a stake near one heap it would have been able to reach that heap alone and it could have feasted happily.

This principle can be applied to molecules. If a nucleophile is joined to the group it is to attack by a short chain of covalent bonds, it may be able to reach only one side. We can illustrate this idea with a reaction you met in Chapter 24: iodolactonization. To remind you, iodolactonization involves treating a non-conjugated unsaturated acid with iodine in aqueous NaHCO_3 . The product is an iodolactone.

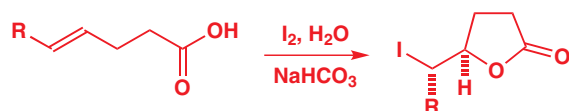

The cyclization reaction is a typical two-stage electrophilic addition to an alkene (Chapter 19) with attack by the nucleophile at the more substituted end of the intermediate iodonium ion. The ring opening is a stereospecific $\text{S}_{\text{N}}2$ and the stereochemistry of the alkene will be reproduced in the product.

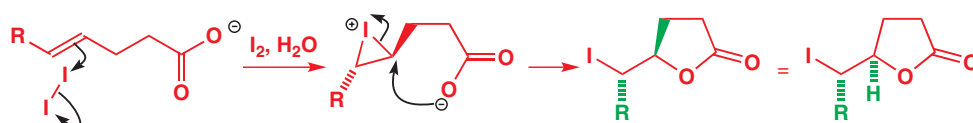

➔ Iodolactonization is described on p. 569.

The starting acid contains an *E* alkene, giving a *trans* iodonium ion. Inversion occurs in the attack of the carboxylate anion on the iodonium ion and we have shown this by bringing the nucleophile in at 180° to the leaving group, with both bonds in the plane of the paper. A single diastereoisomer of the iodolactone results from a stereospecific reaction.

Things get more interesting again when the starting material is cyclic. The iodolactonization below gives only one diastereoisomer.

Chapter 34 describes how to make the unsaturated six-membered starting material.

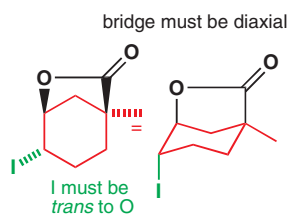
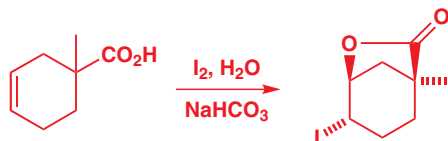

The relationship between the two stereogenic centres on the old alkene is not an issue—inversion during opening of the iodonium ion means that the I and the O must lie *trans*. But during the cyclization the carboxylic acid can attack only the nearer side of what was the double bond—in other words the bridge in black has no choice but to be *cis* across the red six-membered ring. The reason for this is that, while formation of the iodonium ion is reversible, only the iodonium ion with the I and CO₂H groups *trans* to each other can cyclize. Tethering the nucleophilic CO₂H group to the alkene dictates the stereochemistry of the product.

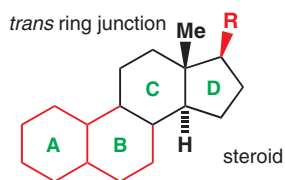
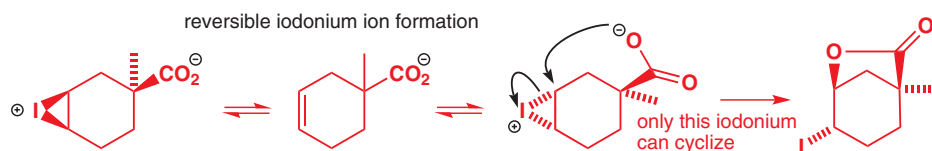

This reaction can be used to solve a general problem in the synthesis of steroids: the construction of a diketone with *trans*-fused 6,5 rings and a quaternary carbon atom at the ring junction. One solution to this problem uses the lactone just made.

The lactone makes a good temporary tether because it can be hydrolysed or reduced to break the ring at the C–O bond and reveal new stereogenic centres on the old structure. In this sequence the lactone ring controls all the subsequent stereochemistry of the molecule in two ways: it fixes the conformation rigidly in one chair form—hence forcing the iodide to be axial—and it blocks one face of the ring. From the lactone above, an alkene is introduced by E2 reaction on the iodide. This stereospecific reaction requires an anti-periplanar H atom so it has to take the only available neighbouring axial hydrogen atom, shown in green. The brown and orange hydrogens are not anti-periplanar and anyway elimination with the brown one would produce a bridgehead alkene.

The impossibility of bridgehead alkenes is mentioned in Chapter 17.

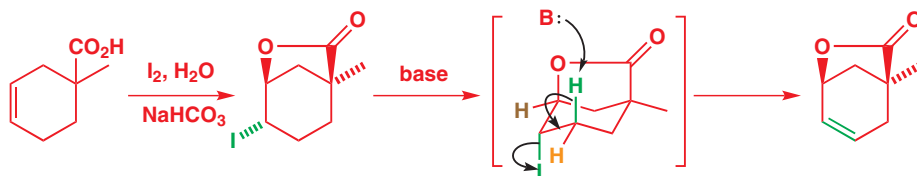

The resulting alkene has its top face blocked by the lactone bridge so epoxidation occurs entirely from the bottom face.

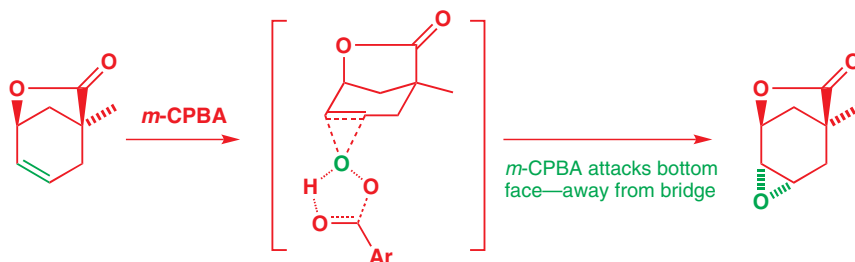

Now the epoxide is opened with HBr. Only the *trans* diaxial opening product is possible, so the bromide ion is forced to attack from the top face.

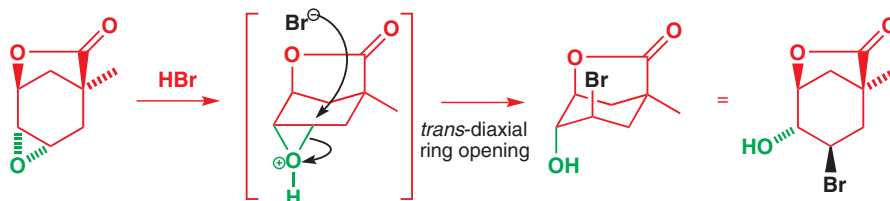

■ This is an epoxide of the type we discussed on p. 836: it has no choice but to open to the *trans* diaxial product.

Do you see how the functional groups are being pushed round the ring? This process is extended further by a second elimination, after protection, which again seeks out the only neighbouring axial hydrogen.

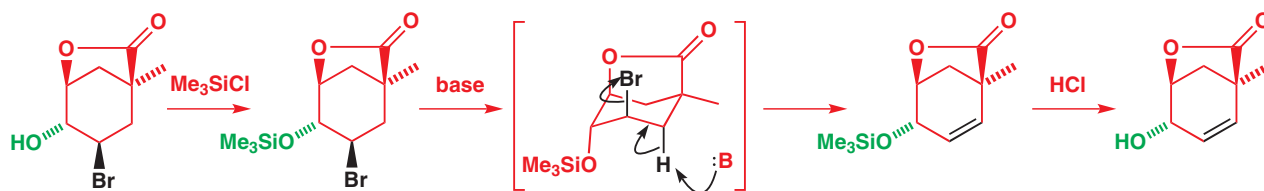

The protecting silyl group is removed in acid, ready for the next important reaction: a Michael addition requiring the alcohol to be oxidized to a ketone. Allylic (or benzylic) alcohols can be oxidized by manganese dioxide, and with three atoms now trigonal the ring becomes even further flattened. But-3-enyl Grignard reagent is added with Cu(I) catalysis to make sure that conjugate addition occurs. Conjugate addition normally gives the axial product, as we saw earlier, and fortunately this is not the direction blocked by the bridge.

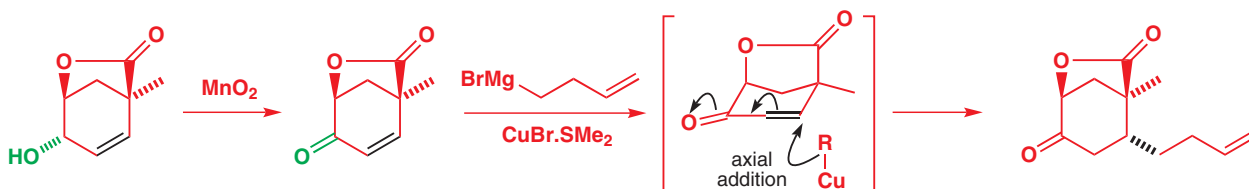

The bridge has now done its work and is removed by zinc metal reduction. This reaction removes leaving groups on the atoms next to carbonyl groups. In this case it is the axial carboxylate that is driven out by the zinc. The released carboxyl group is esterified.

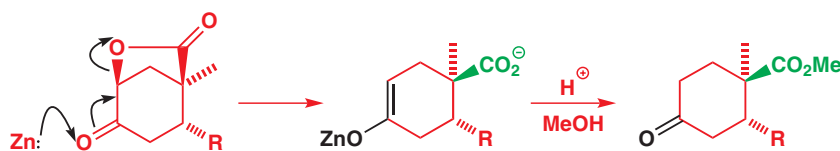

■ This may look like a new reaction but think back to the Reformatsky reaction (Chapter 26, p 631). Both form zinc enolates from carbonyl compounds with adjacent leaving groups.

The last stages are shown below. The ketone is protected, and the alkene oxidized to a carboxyl group by ozonolysis (Chapter 19). The diester can be cyclized by a Claisen ester condensation (Chapter 26). The stereogenic centres in the ring are not affected by any of these reactions so a *trans* ring junction must result from this reaction. After ester hydrolysis, HCl decarboxylates the product and removes the protecting group.

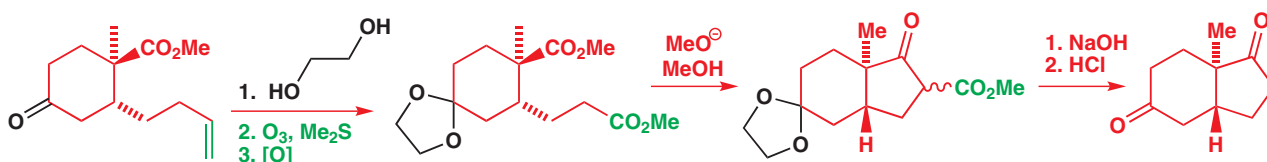

It is not easy to set up a *trans*-fused 5,6 system. In this sequence the molecule is effectively tricked into making the *trans* ring junction by the work done with the lactone tether.

Cyclic transition states can reverse normal stereoselectivity

Formation of a ring in an intermediate is a means of enforcing a certain stereochemistry—the example you have seen made use of a lactone. But even transient formation of a ring in a cyclic transition state can be enough to control stereochemistry highly effectively. You will see further examples in the next chapter, but here we just present one type of reaction with this property: epoxidation.

Of course epoxidation reactions *form* rings, and you have seen examples of epoxidations with *m*-CPBA even in this chapter (p. 848) of alkenes such as cyclohexene. We pointed out in Chapter 19 that epoxidation is stereospecific because both new C–O bonds form to the same face of the alkene.

If we block one face of the ring with a substituent—even quite a small one, such as an acetate group—epoxidation becomes stereoselective for the face *anti* to the substituent already there.

➔ See p. 430 for this discussion.

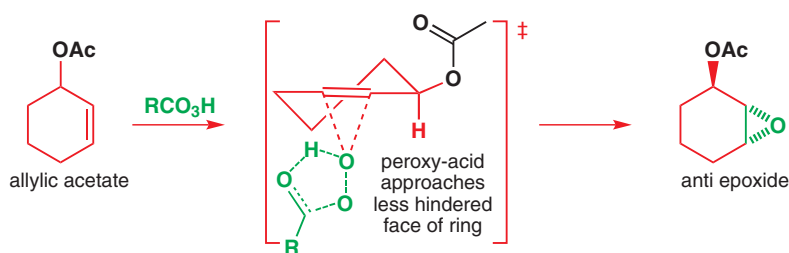

But there is one important exception to this rule, when the substituent is a hydroxyl group. When an allylic alcohol is epoxidized, the peroxy-acid attacks the face of the alkene *syn* to the hydroxyl group, even when that face is more crowded. For cyclohexenol the ratio of *syn* epoxide to *anti* epoxide is 24:1 with *m*-CPBA and it rises to 50:1 with $\text{CF}_3\text{CO}_3\text{H}$.

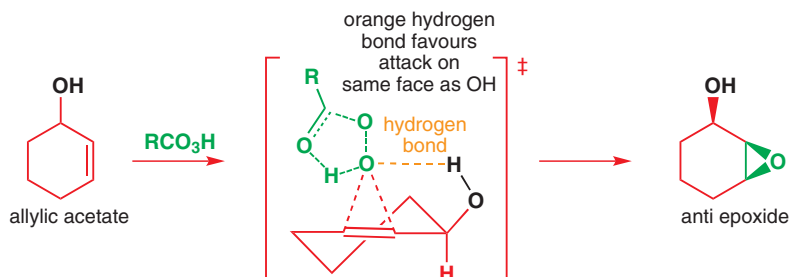

The reason is shown in the transition state: the OH group can hydrogen bond, through the H of the alcohol, to the peroxy-acid, stabilizing the transition state when the epoxidation is occurring *syn*. This hydrogen bond means that peroxy-acid epoxidations of alkenes with adjacent hydroxyl groups are much faster than epoxidations of simple alkenes, even when no stereochemistry is involved.

Peroxy-acids work for epoxidizing allylic alcohols *syn* to the OH group, but another reagent is better when the OH group is further from the alkene. 4-Hydroxycyclopentene, for example, can be converted into either diastereomer of the epoxide. If the alcohol is protected with a large group such as TBDMS (*t*-butyl-dimethylsilyl), it becomes a simple blocking group and the epoxide is formed on the opposite face of the alkene. The selectivity is reasonable (83:17) given that the blocking group is quite distant. But if the OH group is not blocked at all but left free, and the epoxidation reagent is the vanadium complex $\text{VO}(\text{acac})_2$ combined with *t*-BuOOH, the *syn* epoxide is formed instead. The vanadyl group chelates reagent and alcohol, and delivers the reactive oxygen atom to the same face of the alkene as shown.

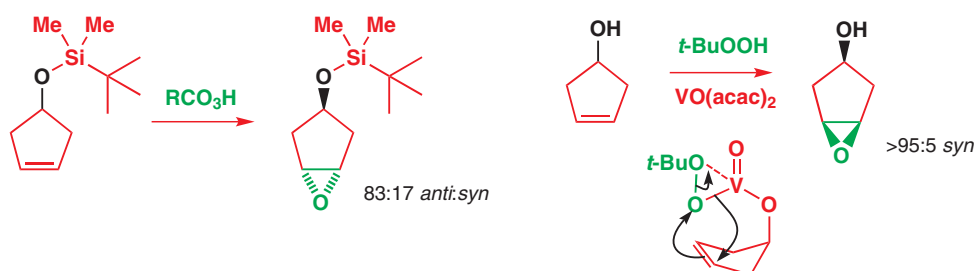

In both epoxidation examples, the stereoselectivity is due to the cyclic nature of the transition state: the fact that there is a hydrogen bond or O–metal bond ‘delivering’ the reagent to one face of the alkene. Effectively we have moved on from the tethered *nucleophiles* of the last section to (transiently) tethered *reagents*. This is a very important concept, and we revisit it in the next chapter: cyclic transition states are the key to getting good stereoselectivity in reactions of acyclic compounds.

To summarize...

Diastereoselectivity in rings generally follows a few simple principles:

- Flattened three-, four-, or five-membered rings, especially ones with two or more trigonal carbons in the ring, are generally attacked from the less hindered face.
- Flattened six-membered rings with two or more trigonal carbons in the ring (that is, which are not already a chair—so six-membered rings with one trigonal C atom don’t count here) react in such a way that the product becomes an axially substituted chair.
- Bicyclic compounds react on the outside face.
- Reaction on the more hindered face can be encouraged by: (1) tethered nucleophiles or (2) cyclic transition states (tethered reagents).

Diastereoselectivity in compounds without rings is different: it is less well controlled because there are many more conformations available to the molecule. But even in acyclic compounds rings can still be important, and some of the best diastereoselectivities arise when there is a ring formed temporarily in the transition state of the reaction. With or without cyclic transition states, in some cases we have good prospects of predicting which diastereoisomer will be the major reaction product, or explaining the diastereoselectivity if we already know this. That is the subject of the next chapter.

Further reading

Oxford Primers by A. J. Kirby, *Stereoelectronic effects*, OUP, Oxford, 1996, and M. Grossel, *Alicyclic Chemistry*, OUP, Oxford, 1997 are relevant. The most comprehensive text is E. L. Eliel and S. H. Wilen, *Stereochemistry of Organic Compounds*, Wiley Interscience, New York, 1994.

The elegant work of Jeffrey Aubé, describing the selective formation of substituted piperidines by control of their conformation, is in *Angew. Chem. Int. Ed.* 2011, **50**, 2734.

VO(acac)₂

Vanadyl (acac)₂ is a square pyramidal complex of two molecules of the enolate of ‘acac’ (acetyl acetone, pentan-2,4-dione) and the vanadyl (V=O) dication. It can easily accept another ligand to form an octahedral complex so there is plenty of room for the alcohol to add and for the *t*-BuOOH to displace one of the ‘acac’ ligands to give some complex with the essential ingredients for the reaction here.

■ Another reaction in which an allylic alcohol is extremely effective at delivering a reagent via a cyclic transition state is the cyclopropanation reaction known as the Simmons–Smith reaction, described on p. 1017.

Check your understanding



To check that you have mastered the concepts presented in this chapter, attempt the problems that are available in the book’s Online Resource Centre at <http://www.oxfordtextbooks.co.uk/orc/clayden2e/>

33

Diastereoselectivity

Connections

➔ Building on

- Nucleophilic attack on the C=O group [ch6](#)
- Stereochemistry [ch14](#)
- Conformation [ch16](#)
- Controlling alkene stereochemistry [ch27](#)
- Stereoelectronics [ch31](#)
- Stereochemistry in rings [ch32](#)

Arriving at

- How to make single diastereoisomers from geometrical isomers
- How to predict and explain reactions of chiral carbonyl compounds
- How chelation to metal ions can alter stereoselectivity
- How to predict and explain the reactions of chiral alkenes
- Stereoselective aldol reactions
- Using naturally derived compounds to make single enantiomers

➔ Looking forward to

- Asymmetric synthesis [ch41](#)
- Organic chemistry of life [ch42](#)
- Organic chemistry today [ch43](#)

Looking back

You have had two chapters in a row about stereochemistry: this is the third, and it is time for us to bring together some ideas from earlier in the book. We aim firstly to help you grasp some important general concepts and secondly to introduce some principles in connection with stereoselective reactions in acyclic systems. But, first, some revision.

We introduced the stereochemistry of structures in Chapter 14. We told you about two types of stereoisomers.

● Enantiomers and diastereoisomers

- **Enantiomers**—stereoisomers that are mirror images of one another.
- **Diastereoisomers**—stereoisomers that are not mirror images of one another.

In this chapter we shall talk about how to make compounds as single *diastereoisomers*. Making single *enantiomers* is treated in Chapter 41. Chapter 32 was also about making single diastereoisomers, and we hope that, having read that chapter, you are used to thinking stereochemically. We shall meet two different ways of making single diastereoisomers.

● Reactions that make single diastereoisomers

- **Stereospecific reactions**—reactions where the mechanism means that the stereochemistry of the starting material determines the stereochemistry of the product and there is no choice involved.
- **Stereoselective reactions**—reactions where one stereoisomer of product is formed predominantly because the reaction has a choice of pathways, and one pathway is more favourable than the other.

Online support. The icon  in the margin indicates that accompanying interactive resources are provided online to help your understanding: just type www.chemtube3d.com/clayden/123 into your browser, replacing **123** with the number of the page where you see the icon. For pages linking to more than one resource, type **123-1, 123-2** etc. (replacing **123** with the page number) for access to successive links.

These terms were introduced in Chapter 17 in connection with elimination reactions, and many of the reactions we mention will be familiar from earlier chapters (particularly Chapters 15–19, 25, and 26). A common misapprehension is that stereospecific means merely very stereoselective. It doesn't—the two terms describe quite different properties of the stereochemistry of a reaction. For the purposes of making a single diastereoisomer, you can think of stereospecific reactions as ones which simply exchange different forms of stereochemical 'currency' (double bond geometry and three-dimensional relative stereochemistry, for example) while stereoselective reactions create additional new stereochemical value.

Making single diastereoisomers using stereospecific reactions of alkenes

The essence of the definition we have just stated is much easier to grasp with some familiar examples. Here are two.

- S_N2 reactions are stereospecific: they proceed with inversion so that the absolute stereochemistry of the starting material determines the absolute stereochemistry of the product.



➔ This is discussed in Chapter 15, p. 344.

- $E2$ reactions are stereospecific: they proceed through an anti-periplanar transition state, with the relative stereochemistry of the starting material determining the geometry of the product.



➔ This is discussed in Chapter 17, p. 395.

Both of these examples are interesting because they show how, once we have some stereochemistry in a molecule, we can change the functional groups but keep the stereochemistry—this is the essence of a stereospecific reaction. In the second example, we change the bromide to a double bond, but we keep the stereochemistry (or 'stereochemical information') because the geometry of the double bond tells us which bromide we started with.

This is a good place to begin if we want to make single diastereoisomers because we can reverse this type of reaction: instead of making a single geometry of alkene from a single diastereoisomer, we make a single diastereoisomer from a single geometry of double bond. Here is an example of this—again, one you have already met (Chapter 19). Electrophilic addition of bromine to alkenes is stereospecific and leads to *anti* addition across a double bond. So if we want the *anti* dibromide we choose to start with the *trans* double bond; if we want the *syn* dibromide we start with the *cis* double bond. The geometry of the starting material determines the relative stereochemistry of the product.

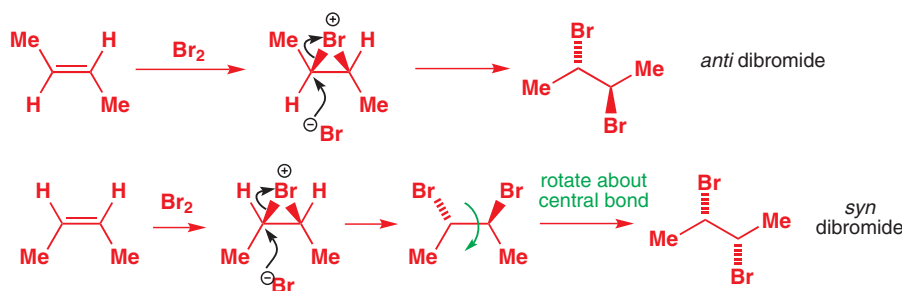

➔ Chapter 27 described the methods available for controlling the geometry of double bonds.

📖 Interactive mechanism for stereospecific *anti* addition to alkenes

Iodolactonization has a similar mechanism; notice how in these two examples the geometry of the double bond in the starting material defines the relative stereochemistry highlighted in black in the product.

There are two more stereogenic centres in the second example here and, although they do not affect the relative stereochemistry shown in black, they do affect how those two new stereogenic centres relate to the two that are already present in the starting material. We discuss how later in the chapter.

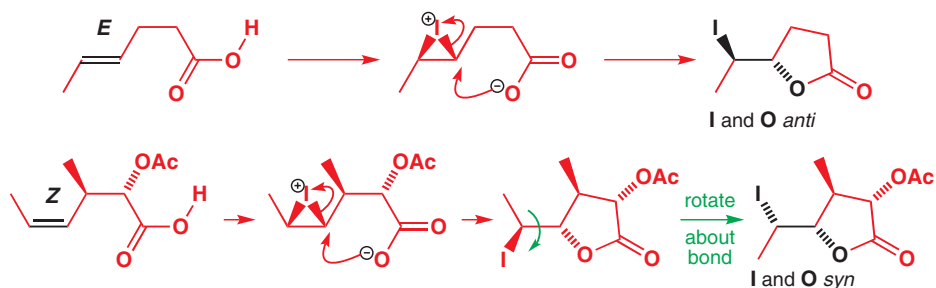

For a stereospecific alkene transformation, choose the right geometry of the starting material to get the right diastereoisomer of the product. Don't try to follow any 'rules' over this—just work through the mechanism.

Now for some examples with epoxides. Epoxides are very important because they can be formed stereospecifically from alkenes: *cis* alkenes give *cis* (or *syn*) epoxides and *trans* alkenes give *trans* (or *anti*) epoxides.

Formation and reaction of epoxides are described in Chapter 19, p. 429 and Chapter 15, p. 351.



Epoxides also react stereospecifically because the ring-opening reaction is an S_N2 reaction. A single diastereoisomer of epoxide gives a single diastereoisomer of product.



Leukotrienes

Leukotrienes are metabolites of arachidonic acid related to prostaglandins and thromboxanes. They are made in nature (and often in the laboratory) by oxidation of alkenes. The letter (e.g. A) gives the general structure and the subscript number the number of alkenes. They are unstable and control localized physiological phenomena such as blood clotting and inflammation.

Leukotrienes are important molecules that regulate cell and tissue biology. Leukotriene C_4 (LTC_4) is a single diastereoisomer with an *anti* 1,2,S,O functional group relationship. In nature, this single diastereoisomer is made by an epoxide opening: since the opening is S_N2 the epoxide must start off *anti* and, indeed, the epoxide precursor is another leukotriene, LTA_4 .



When Corey was making these compounds in the early 1980s he needed to be sure that the relative stereochemistry of LTC_4 would be correctly controlled, and to do this he had to make a *trans* epoxide. Disconnecting LTA_4 led back to a simpler epoxide.

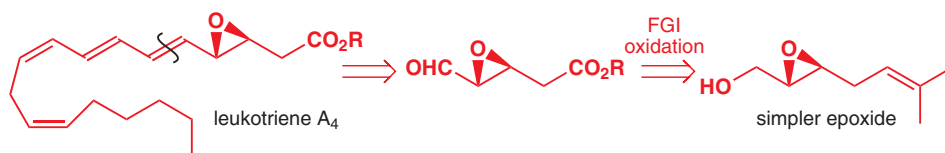

The *trans* allylic alcohol needed to make this compound was made using one of the methods we introduced in Chapter 27: reduction of an alkynyl alcohol with $LiAlH_4$. Here is the full synthesis: alkylation of an ester enolate with prenyl bromide gives a new ester, which itself is turned into an alkylating agent by reduction and tosylation. The alkyne is introduced as its lithium derivative with the alcohol protected as a THP acetal. Hydrolysis of the acetal with

aqueous acid gives the hydroxy-alkyne needed for reduction to the *E* double bond, which is then epoxidized.

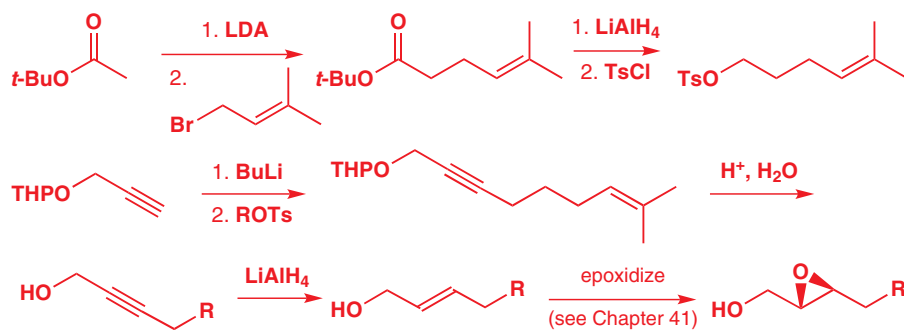

➔ The epoxide was, in fact, made as a single enantiomer using the Sharpless epoxidation, which we will describe in Chapter 41.

Stereoselective reactions

For most of the rest of the chapter we shall discuss stereoselective reactions. You have already met several examples and we start with a summary of the most important methods.

- E1 reactions are stereoselective: they form predominantly the more stable alkene.
- Nucleophilic attack on six-membered ring ketones is stereoselective: small nucleophiles attack axially and large ones equatorially.

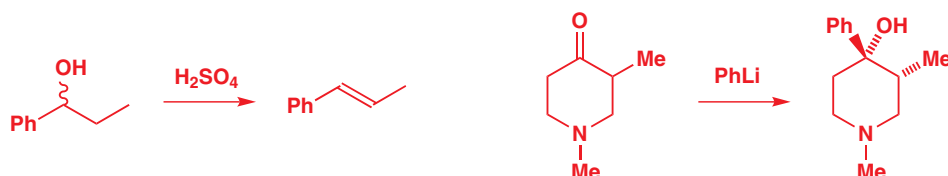

➔ Chapter 17, p. 391 and Chapter 32, p. 829.

- Alkylation of cyclic enolates is stereoselective, with reaction taking place on the less hindered face (four- or five-membered rings) or via axial attack (six-membered rings).

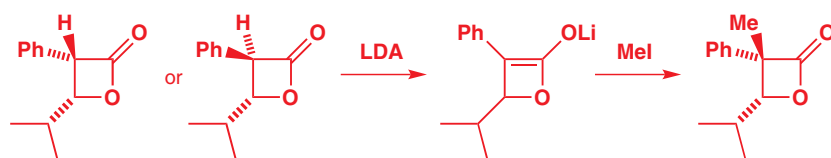

➔ Chapter 32, pp. 833 and 850.

- Epoxidation of cyclic alkenes is stereoselective, with reaction taking place on the less hindered face, or directed by hydrogen bonding to a hydroxyl group.



■ A comment on structural drawings of single diastereoisomers

In the two reactions just above, a racemic starting material gives a racemic product as a single diastereoisomer. It is easy to draw a racemic compound with just one stereogenic centre—we just avoid showing stereochemistry. But in the products we *have* to show relative stereochemistry because we need to indicate which diastereoisomer is formed. There is no way of doing this except by arbitrarily choosing one enantiomer and drawing that. If there is a danger of confusion, we might sometimes write '(±)' under the structure.

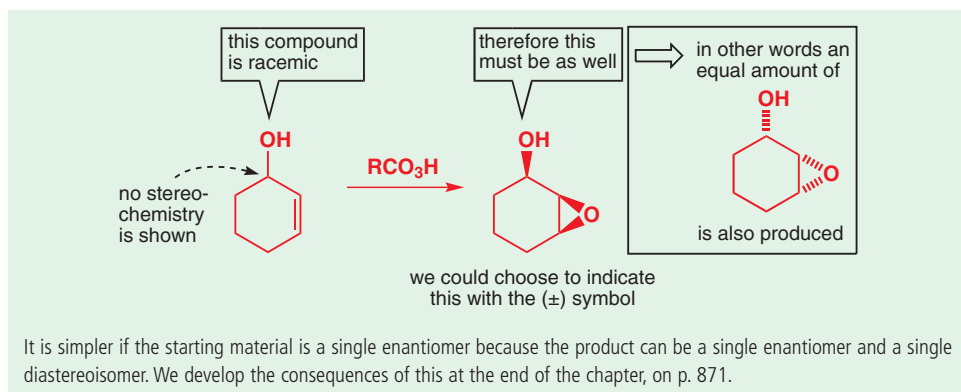

Prochirality

Take another look at the reactions in the chapter so far—in particular those that give single diastereoisomers (rather than single enantiomers or geometrical isomers), in other words, those that are diastereoselective. They all involve the creation of a new, tetrahedral stereogenic centre at a carbon that was planar and trigonal. This leads us to our first new definition. Trigonal carbons that aren't stereogenic (or chiral) centres but can be made into them are called *prochiral*.

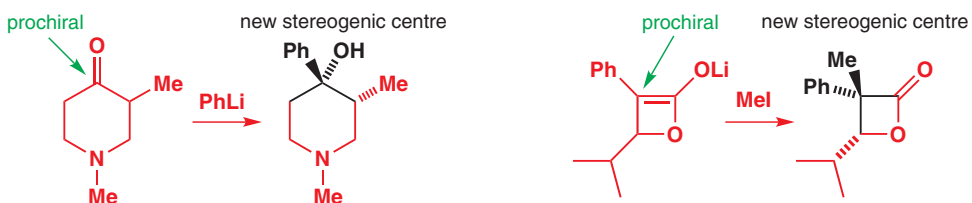

At the very start of Chapter 15 we introduced stereochemistry by thinking about the reactions of two sorts of carbonyl compounds. They are shown again here: the first has a prochiral carbonyl group. The second, on the other hand, is not prochiral because no stereogenic centre is created when the compound reacts.

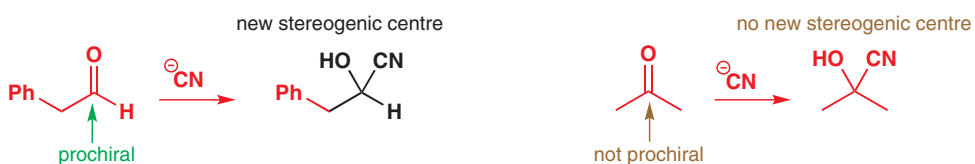

A tetrahedral carbon atom can be prochiral too—if it carries two identical groups (and so is not a chiral centre) but replacement of one of them leads to a new chiral centre, then the carbon is prochiral.

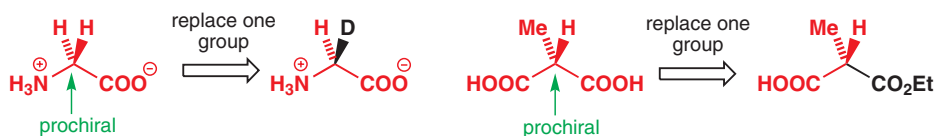

➔ Enantiotopic and diastereotopic protons and groups are discussed in Chapter 31, p. 820.

Glycine is the only common α amino acid without a chiral centre, but replacing one of the two protons on the central carbon with, say, deuterium creates one: the CH_2 carbon is prochiral. Similarly, converting a malonate derivative into its monoester makes a chiral centre where there was none: the central C is prochiral. Now, does this ring any bells? It should remind you very much of the definitions in Chapter 31 of *enantiotopic* and *diastereotopic* in connection with NMR spectra. Replacing one of two enantiotopic groups with another group leads to one of two enantiomers; replacing one of two diastereotopic groups with another group leads to

one of two diastereoisomers. Diastereotopic groups are chemically different; enantiotopic groups are chemically identical.

Exactly the same things are true for the faces of a prochiral carbonyl group or double bond. If reaction on one of two faces of the prochiral group generates one of two enantiomers, the faces are enantiotopic; if the reaction generates one of two diastereoisomers, the faces are diastereotopic. We will now apply this thinking to the first few reactions in this chapter: they are shown again below. The two examples in the top row have prochiral C=C or C=O bonds with diastereotopic faces: choosing which face of the double bond or carbonyl group to react on amounts to choosing which diastereoisomer to form. In the third example, the faces of the prochiral carbonyl group are enantiotopic: choosing which face to attack amounts to choosing which enantiomer to form. In the fourth example, the two faces of C=O are **homotopic**: an identical product is formed whichever face is attacked.

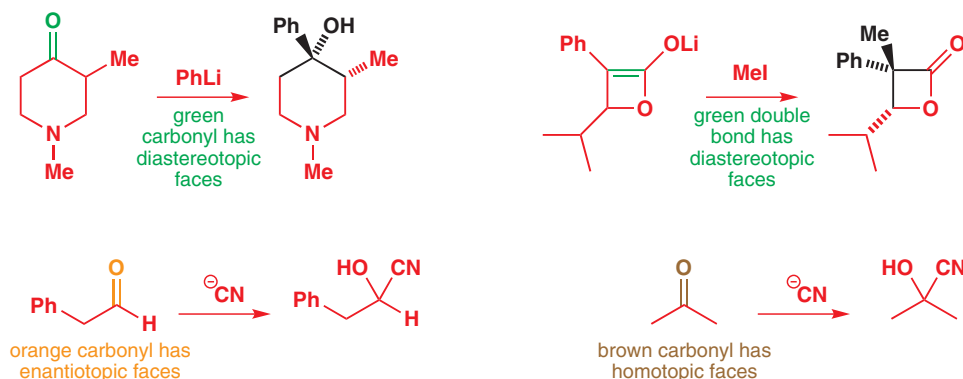

Knowing this throws some new light on the last chapter. Almost without exception, every stereoselective reaction there involved a double bond (usually C=C, sometimes C=O) with diastereotopic faces. The diastereotopic faces were distinguished by steric hindrance, or by a nearby hydrogen-bonding group, and so were able to react differently with an incoming reagent.

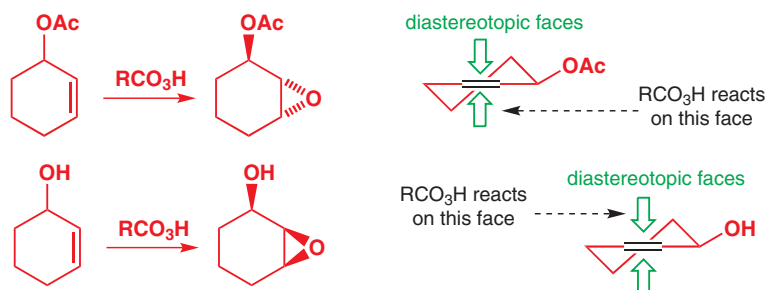

Using an *R/S*-type system to name prochiral faces and groups

Just as stereogenic centres can be described as *R* or *S*, it is possible to assign labels to the enantiotopic groups at prochiral tetrahedral carbon atoms or the enantiotopic faces of prochiral trigonal carbon atoms. The basis of the system is the usual *R, S* system for stereogenic centres, but *pro-R* and *pro-S* are used for groups and *Re* and *Si* for faces.

Pro-R and *pro-S* can be assigned to a pair of enantiotopic groups simply by using the usual rules to assign *R* or *S* to the centre created *if* the group in question is artificially elevated to higher priority than its enantiotopic twin. We'll use G to replace H as we did in Chapter 31: just assume that G has priority immediately higher than H. The method is illustrated for glycine.

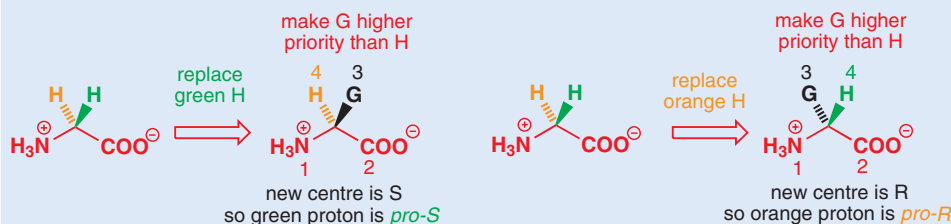

Faces of a prochiral trigonal carbon atom are assigned *Re* and *Si* by viewing the carbon from that side and counting down the groups in priority 1–3. Counting round to the right (clockwise) means the face is *Re*; counting round to the left (anticlockwise) means it's *Si*. Remember our advice from Chapter 14: think of turning a steering wheel in the direction of the numbers: does the car go to the right or the left?

Like *R* and *S*, these stereochemical terms are merely labels: they are of no consequence chemically.

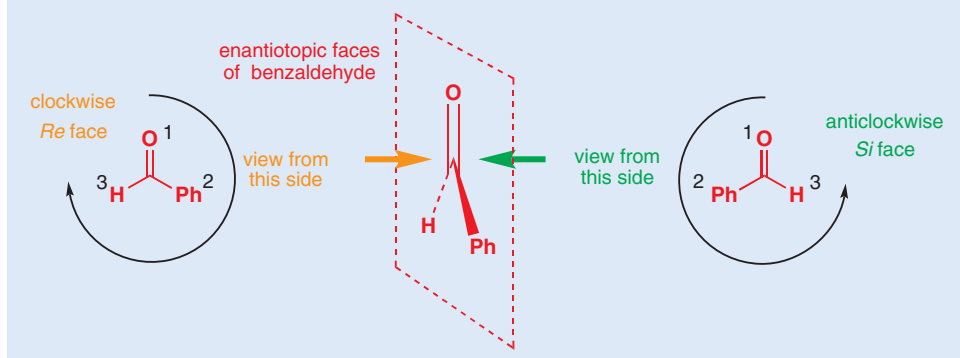

■ In Chapter 32 we showed that homotopic and enantiotopic protons are identical by NMR. Similarly homotopic faces or groups are always chemically identical. Enantiotopic faces are also chemically identical provided that all the reagents in the reaction in question are achiral or racemic. In Chapter 41 we will consider what happens to enantiotopic faces when *enantiomerically pure* reagents are used.

Just like diastereotopic signals in an NMR spectrum, diastereotopic faces are always different in principle, but sometimes not so in practice. The very first reaction of Chapter 32 is a case in point: this C=O group has two diastereotopic faces, which, due to free rotation about single bonds, average out to about the same reactivity, so we cannot expect any reasonable level of diastereoselectivity.

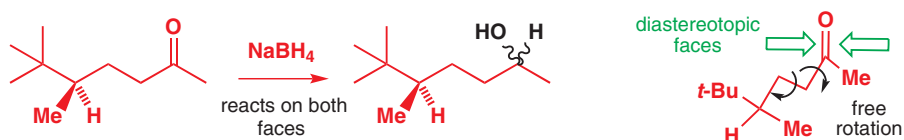

We put Chapter 32 first because in rings conformation is well defined, and this 'averaging' effect is held at bay. We are about to let it out again, but we will show you how it can be tamed to surprisingly good effect.

Additions to carbonyl groups can be diastereoselective even without rings

What happens if we bring the stereogenic centre closer to the carbonyl group than it was in the last example? You might expect it to have a greater influence over the carbonyl group's reactions. And it does. Here is an example.

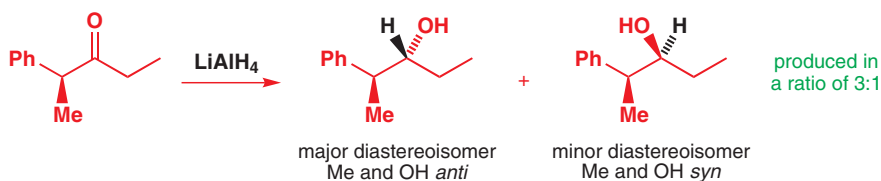

■ We have termed the major diastereoisomer *anti* because the two substituents (Me and OH) are on opposite sides of the chain as drawn. There is no formal definition of *anti* and *syn*: they should be used only in conjunction with a structural drawing.

There is three times as much of one of the two diastereoisomeric products as there is of the other, and the major (*anti*) diastereoisomer is the one in which the nucleophile has added to the front face of the carbonyl group as drawn here. We can make these same two diastereoisomers by addition of an organometallic to an aldehyde. For example, this Grignard reagent gives three times as much of the *syn* diastereoisomer as the *anti* diastereoisomer. The major product was changed, but the product still arises from attack on the front face of the carbonyl as shown.

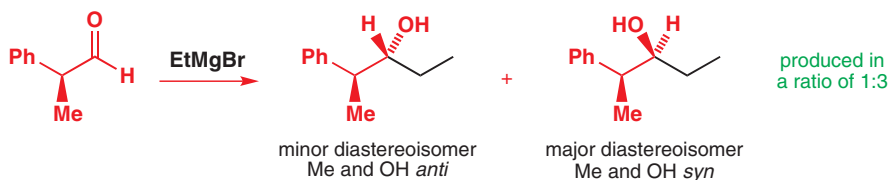

Drawing diastereoisomers of acyclic molecules

The three structures below all show the same diastereoisomer (the major product from the last reaction), but in three different conformations (we are just rotating about a bond to get from one to another).

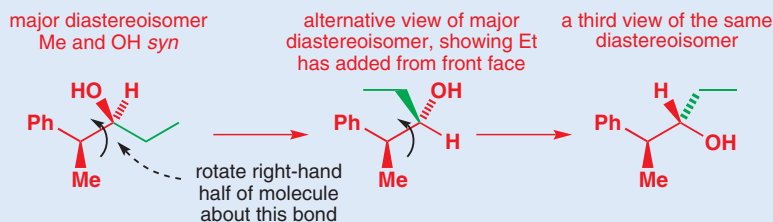

Which is the best? A good guideline, which we suggested in Chapter 14, is to place the longest carbon chain zig-zagging across the page in the plane of the paper, and allow all the smaller substituents to extend above or below that chain. The first structure here is drawn like that. But this is only a guideline, and the second structure here is a bit more informative regarding the reaction because, when it is drawn like this, you can clearly see from which direction the ethyl group has attacked the carbonyl. Our advice would be that you first of all draw the product of any reaction in more or less the same conformation as the starting material to ensure you make no mistakes, and then rotate about a single bond to place the longest chain in the plane of the paper.

If you still have problems manipulating structures mentally—for example, if you find it hard to work out whether the substituents that aren't in the plane should be in front of or behind the page—build some models.

These two reactions are not nearly as diastereoselective as most of the reactions of cyclic compounds you met in the last chapter. But we do now need to explain why they are diastereoselective at all, given the free rotation possible in an acyclic molecule. The key, as much with acyclic as with cyclic molecules, is **conformation**.

The conformation of a chiral aldehyde

What will be the conformation of the aldehyde in the margin? Using the principles we outlined in Chapter 16, we can expect it to be staggered, with no eclipsing interactions, and also with large substituents as far apart from one another as possible. A Newman projection of one of the possible conformers might look like the one shown in the margin. There are no eclipsing interactions, and the large phenyl group is held satisfactorily far away from the O and the H atoms of the aldehyde.

By rotating about the central bond of the aldehyde (the one represented by a circle in the Newman projection) we can suggest a series of possible conformations. Provided we move in 60° steps, none of them will have any eclipsing interactions. The full set of six conformers is shown here. Look at them for a moment and notice how they differ.

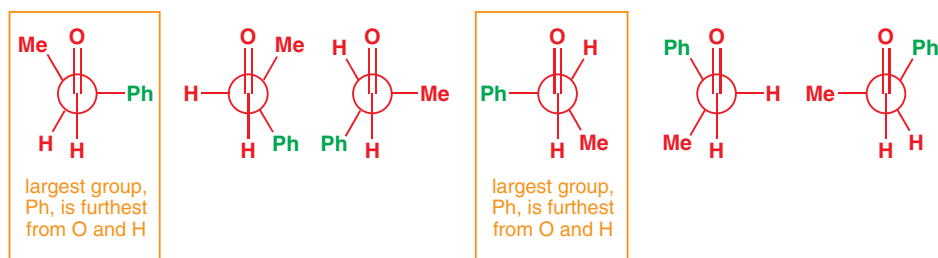

Only two of them, boxed in orange, place the large Ph group perpendicular to the carbonyl group. These yellow-boxed conformations are therefore the lowest-energy conformers and, for the purpose of the discussion that follows, they are the only ones whose reactions we need to consider.

➔ We shall draw heavily on the first part of Chapter 16: if you haven't read it recently, now might be a good time to refresh your memory.

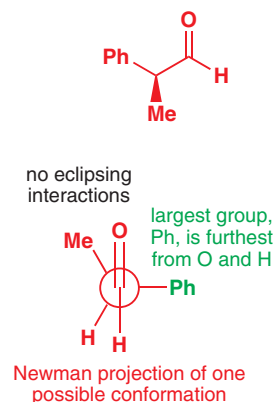

• **Lowest-energy conformations of a carbonyl compound**

The most important conformations of a carbonyl compound with a stereogenic centre adjacent to the carbonyl group are those that place the largest group perpendicular to the carbonyl group.

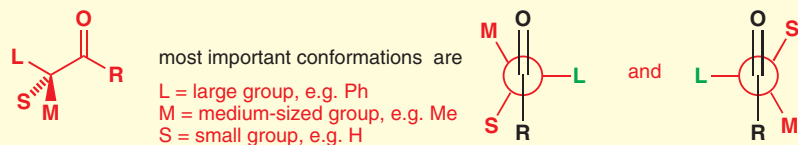

The major product arises from the most reactive conformer

Now that we have decided which are the important conformations, how do we know which gives the product? We need to decide which is the *most reactive*. All we need to do is to remember that any nucleophile attacking the carbonyl group will do so from the Bürgi–Dunitz angle—about 107° from the C=O bond. The attack can be from either side of C=O, and the following diagrams show the possible trajectories superimposed on the two conformations we have selected, which are in equilibrium with one another.

➔ We introduced the idea that attack on a C=O group followed this trajectory in Chapter 6 (p. 127).

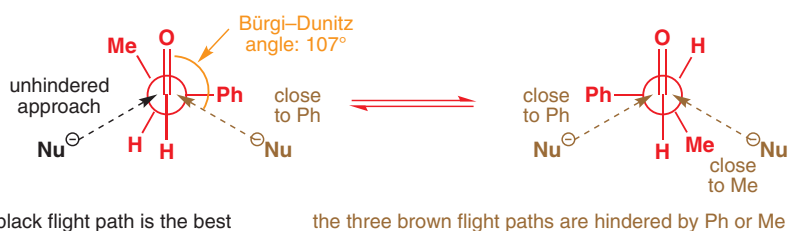

Not all four possible ‘flight paths’ for the nucleophile are equally favourable. For the three shown in brown, the nucleophile passes within 30° or so of another substituent. But, for the one shown in black, there is no substituent nearby except H to hinder attack: the conformation on the left is the most reactive one, and it reacts to give the diastereoisomer shown below.

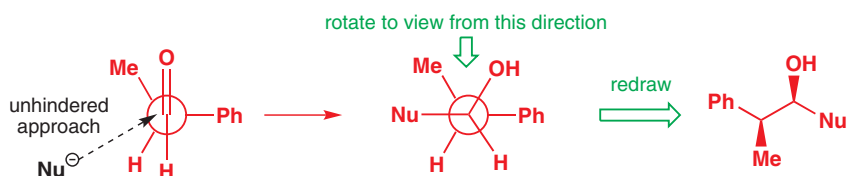

This is an example of the **Curtin–Hammett principle**, which says that it is the relative energies of the transition states that control selectivity, not the relative energies of the starting materials. It’s really more of a reminder not to make a mistake than a principle.

Cram’s rule

You may hear ‘Cram’s rule’ used to explain the outcome of reactions involving attack on chiral carbonyl compounds. Cram was the first to realize that these reactions could be predicted, but we now know why these compounds react in a predictable way. We will not describe Cram’s rule because, although it often does predict the right product, in this case it does so for the wrong reason. Explanations and clear logical thinking are more important than rules, and you must be able to account for and predict the reactions of chiral aldehydes and ketones using the Felkin–Anh model.

• **In order to avoid making mistakes, we suggest you:**

- first draw the product in a conformation similar to that of the starting material
- then redraw to put the longest chain in the plane of the paper.

Here, this just means drawing the view from the top of the Newman projection—there is no need to rotate any bonds in this case.

With Nu=Et we have the right product and, more importantly, we can be pretty sure it is for the right reason: this model of the way a nucleophile attacks a carbonyl compound, called the **Felkin–Anh model**, is supported by theoretical calculations and numerous experimental results. Notice that we don’t have to decide which is the lower energy of the two conformations: this is not necessary because the attack in black will occur even if the conformer on the left is the minor one in the mixture.

The same reasoning accounts for the diastereoselectivity of the reduction on p. 858: first we need to draw the two important conformers of the ketone; the ones that have the large group (Ph) perpendicular to the C=O group.

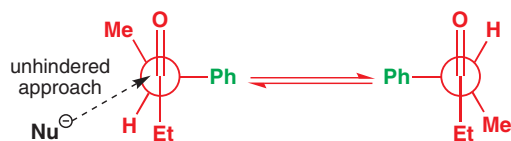

Now choose the angle of attack that is the least hindered and draw a Newman projection of the product. Finally, redraw the Newman projection as a normal structure, preferably with the longest chain in the plane of the paper.

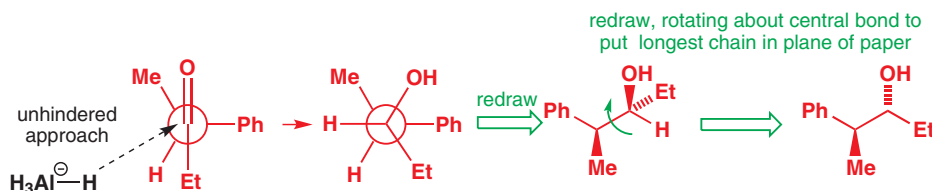

Interactive Felkin–Anh model for ketone reduction

The effect of electronegative atoms

One of the most powerful anticancer agents known is dolastatin, isolated from the sea-hare *Dolabella*. Dolastatin contains an unusual amino acid, with three stereogenic centres, and chemists in Germany managed to exploit Felkin–Anh control very effectively to make it from the much more widespread amino acid isoleucine. This is the sequence of reactions.

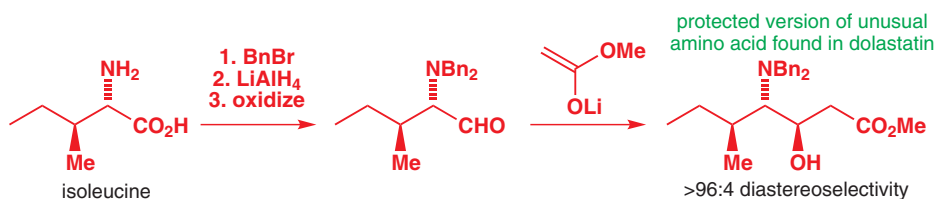

■ When you see a selectivity given as 'greater than' something it means that the other diastereoisomer was undetectable and here 96:4 was the limit of detection by the method used—possibly NMR.

The key step is the aldol reaction of the enolate of methyl acetate with the protected amino aldehyde. To rationalize the stereoselectivity, we first need to draw the two most important conformations of this aldehyde with the large group perpendicular to C=O. The trouble is, which do we choose as 'large': the NBN₂ group or the branched alkyl group? Since we know which diastereoisomer is produced we can work backwards to find that it must be the NBN₂ group that sits perpendicular to C=O in the reactive transition state, and not alkyl. We can draw the best conformation without worrying about alternatives.

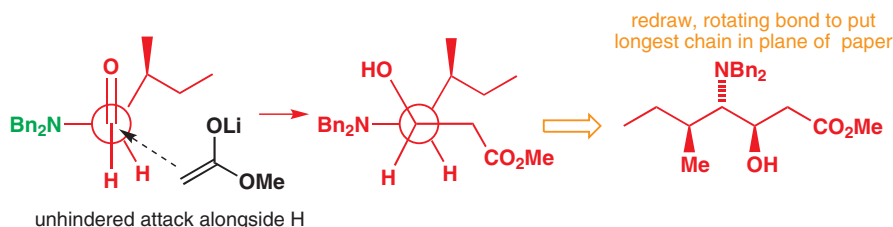

■ Try for yourself putting alkyl perpendicular to C=O: you will get the wrong diastereoisomer.

Now look at the diastereoselectivity of the reaction: it is much greater than the 3:1 we saw before—more like 20:1. This really does suggest that there is a further factor at work here, and that further factor is the electronegative N atom.

Carbonyl groups increase the reactivity of adjacent leaving groups towards nucleophilic substitution by several orders of magnitude. This was an effect that we noted in Chapter 15, where we showed that the ketone below reacts by the S_N2 mechanism 5000 times as fast as methyl chloride itself. We explained this effect by saying that the π* of the C=O and the σ* of C–Cl overlap to form a new, lower-energy (and therefore more reactive) LUMO. What we did not

➔ This is discussed on p. 341 of Chapter 15.

note then, because it was not relevant, is that this overlap can only occur when the C–Cl bond is perpendicular to the C=O bond, because only then are the π^* and σ^* orbitals aligned correctly.

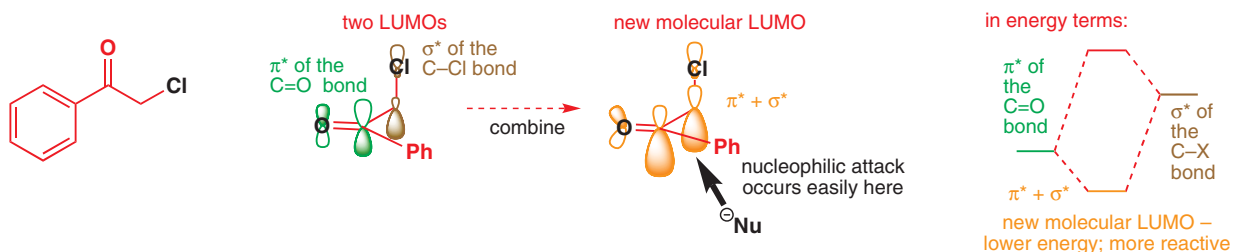

The same thing happens even with electronegative atoms X that are not leaving groups in the S_N2 reaction (for example, X=OR, NR_2 , SR, etc.). The π^* and σ^* orbitals add together to form a new, lower-energy molecular orbital, more susceptible to nucleophilic attack. But, if X is not a leaving group, attack on this orbital will result not in nucleophilic substitution but in addition to the carbonyl group. Again, this effect will operate only when the C–X and C=O bonds are perpendicular so that the orbitals align correctly.

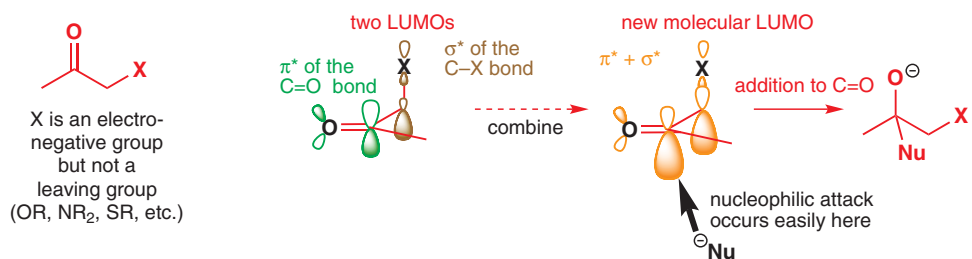

What does this mean for stereoselectivity? Conformations of the chiral carbonyl compound that place an electronegative atom perpendicular to the C=O bond will be more reactive—size doesn't matter. So, in the dolastatin amino acid example, the conformations with NBn_2 perpendicular to C=O are the only conformations we need to consider.

● Using the Felkin–Anh model

To predict or explain the stereoselectivity of reactions of a carbonyl group with an adjacent stereogenic centre, use the Felkin–Anh model. If you look at the next example, just below this box, you can follow exactly the series of steps we suggest you take:

- Draw Newman projections of the conformations of the starting material that place a large group or an electronegative group perpendicular to C=O.
- Allow the nucleophile to attack along the least hindered trajectory, taking into account the Bürgi–Dunitz angle.
- Draw a Newman projection of the product that arises from attack in this way.
- Carefully flatten the Newman projection on to the page to produce a normal structure, preferably with the longest chain of C atoms in the plane of the page. Check that you have done this last step correctly: it is very easy to make mistakes here. Use a model if necessary, or do the 'flattening out' in two stages—first view the Newman projection from above or below and draw that; then rotate some of the molecule about a bond if necessary to get the long chain into the plane of the page.

Chelation can reverse stereoselectivity



You should now be in a position to explain the outcome of this reaction without much difficulty. Sulfur is the electronegative atom, so the conformations we need to consider are the two following. Unhindered attack on the second gives the diastereoisomer shown.

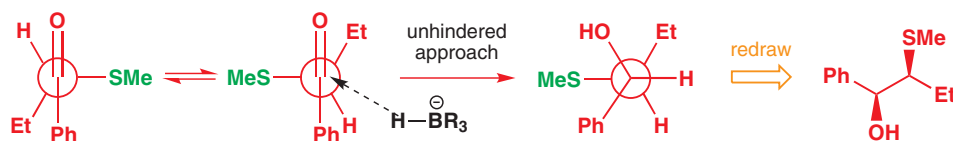

But, from what we have told you so far, the next reaction would present a problem: changing the metal from lithium to zinc has reversed the stereoselectivity. Using the simple Felkin–Anh model no longer works: it gives the wrong answer.

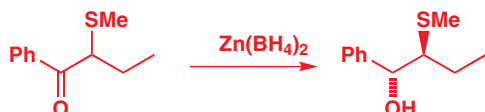

The reason is that zinc can chelate sulfur and the carbonyl group. Chelation is the coordination of two heteroatoms carrying lone pairs to the same metal atom, and here it changes the conformation of the starting material. No longer does the most reactive or most populated conformation place the electronegative S atom perpendicular to C=O; instead it prefers S to lie as close to the carbonyl oxygen as possible so that Zn can bridge between S and O, like this:

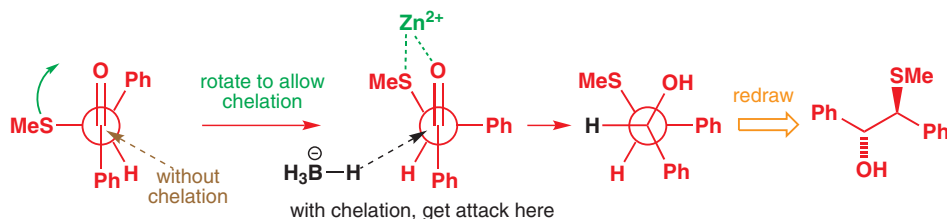

When chelation is possible, this is the conformation to consider—the one with the carbonyl O and the other chelating atom almost eclipsing one another. It is the most populated because it is stabilized by the chelation, and it is also the most reactive, because the Lewis-acidic metal atom increases the reactivity of the carbonyl group. Attack is still along the less hindered pathway, but this now leads to the other face of the carbonyl group, and the stereochemical outcome is reversed.

Two things are needed for chelation to occur:

- a heteroatom with lone pairs available for coordination to a metal
- a metal ion that prefers to coordinate to more than one heteroatom at once—these are mainly more highly charged ions, as shown in the table.

Here is another example of a reversal in selectivity that can be explained using a non-chelated Felkin–Anh model with Na^+ and a chelated model with Mg^{2+} .

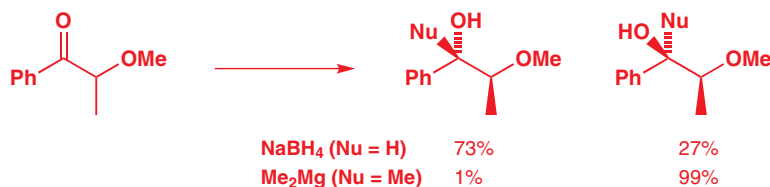

Not only does chelation control reverse the stereoselectivity, it gives a much higher *degree* of stereoselectivity. Stereoselectivities in chelation-controlled additions to C=O groups are typically >95:5. But this fits in nicely with the ideas we presented at the end of the last chapter: stereoselectivity is likely to be high if a cyclic transition state is involved. Chelation involves

A chelate (from the Greek for 'claw') is a coordination compound with a metal atom bonded to an organic molecule at two or more atoms.

Interactive model for chelation-controlled ketone reduction

Metals commonly involved in chelation	Metals not usually involved in chelation
Li^+ often	Na^+
Mg^{2+}	K^+
Zn^{2+}	
Cu^{2+}	
Tl^{4+}	
Ce^{3+}	
Mn^{2+}	

Interactive model for chelation-controlled organo-Mg addition

just such a transition state, so it should be no surprise that it lets us achieve much higher levels of control than the acyclic Felkin–Anh model does.

Chelation, rate, and stereoselectivity

The correlation of rate of addition with diastereoselectivity was demonstrated in a series of experiments that involved reacting Me_2Mg with protected α -hydroxy-ketones. As the protecting group was changed from a methyl ether to a trimethylsilyl ether and then through a series of increasingly bulky silyl ethers, both the rate of the reaction and the diastereoselectivity decreased. With small protecting groups the reaction takes place through the chelated transition state—the selectivity shows this—and the rate is faster because of the activating effect of the Lewis-acidic magnesium ion. But with larger protecting groups chelation of Mg^{2+} between the two oxygen atoms is frustrated: the rate drops off and the selectivity becomes more what would be expected from the Felkin–Anh model.

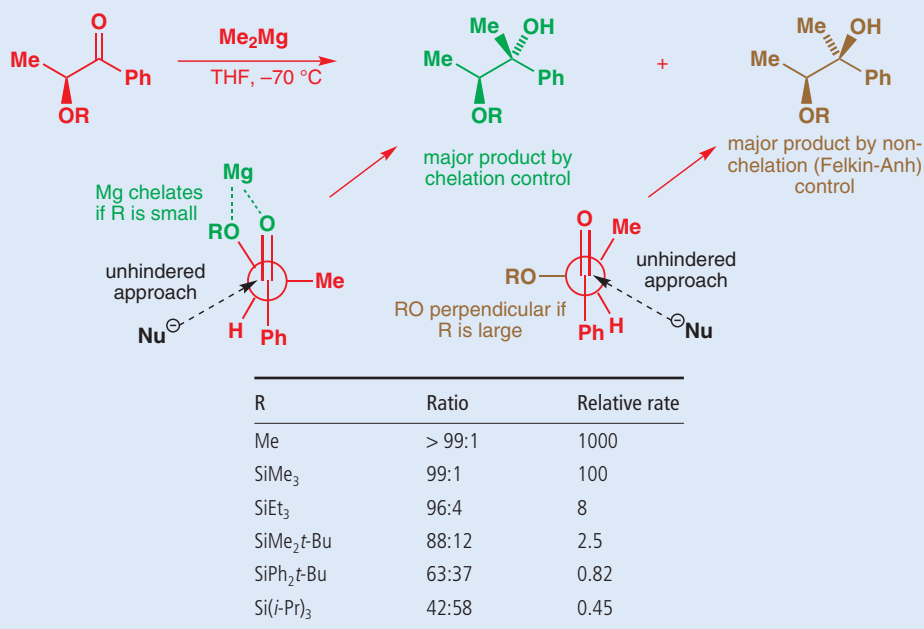

• Chelation:

- may change the direction of diastereoselectivity
- leads to high levels of diastereoselectivity
- increases the rate of the addition reaction.

Chelation is possible through six- as well as five-membered rings and the reduction of the ketone below is a nice example of the reversal of diastereoselectivity observed when chelating Ce^{3+} ions are added to a normal sodium borohydride reduction. The products were important for making single geometrical isomers of alkenes in a modification of the Wittig reaction. Notice too that the rate changes: with Ce^{3+} the reaction can be done at -78°C .

➔ This is Luche reduction, mentioned in Chapter 23, p. 536.

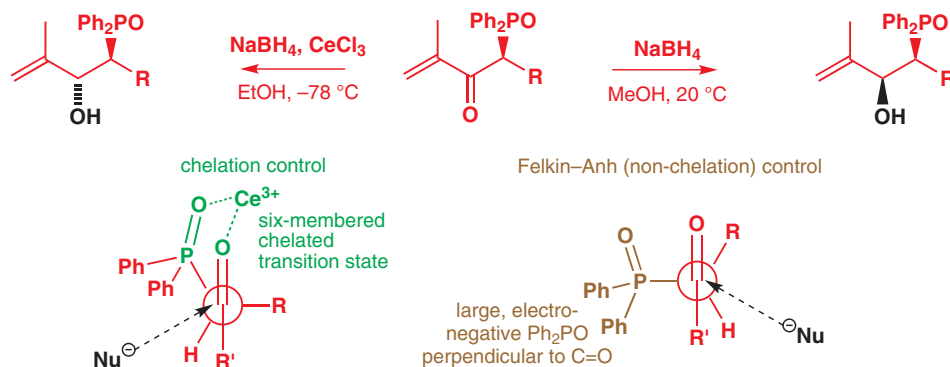

● **Attack on α chiral carbonyl compounds: summary**

The flow chart summarizes what you should consider when you need to predict or explain the stereochemical outcome of nucleophilic attack on a chiral carbonyl compound.

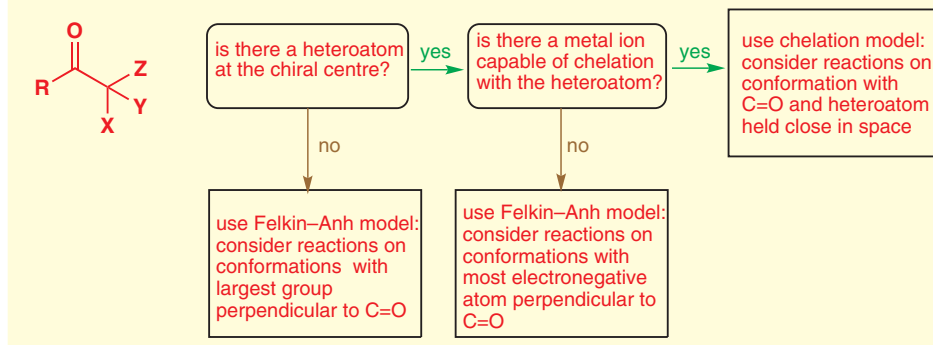

Stereoselective reactions of acyclic alkenes

Earlier in the chapter we discussed how to make single diastereoisomers by stereospecific additions to double bonds of fixed geometry. But if the alkene also contains a chiral centre there will be a stereoselective aspect to its reactions too: its faces will be diastereotopic, and there will be two possible outcomes even if the reaction is fully stereospecific. Here is an example where the reaction is an epoxidation.

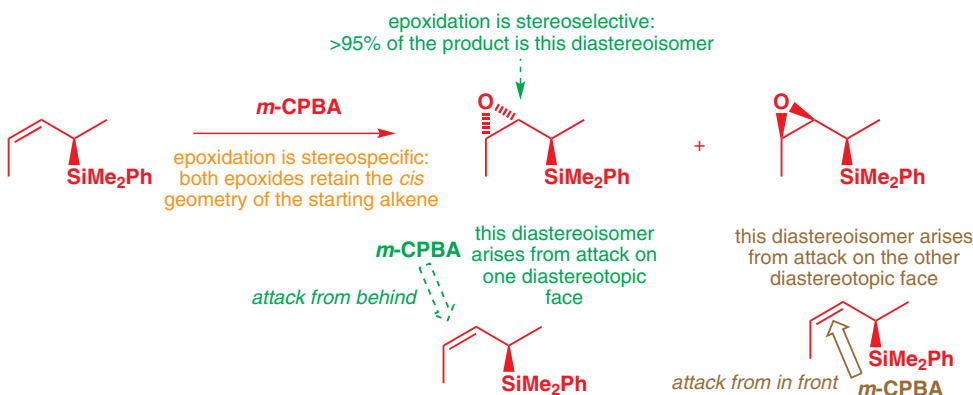

The Houk model

In order to explain reactions of chiral alkenes like this, we need to assess which conformations are important and consider how they will react, just as we have done for chiral carbonyl compounds. Much of the work on alkene conformations was done by K. N. Houk using theoretical computer models, and we will summarize the most important conclusions of these studies. The theoretical studies looked at two model alkenes, shown in the margin.

The calculations found that the low-energy conformations in each case were those in which a substituent eclipses the double bond. For the simple model alkene **1**, the lowest-energy conformation is the one that has the proton in the plane of the alkene. Another low-energy conformation—only 3.1 kJ mol⁻¹ higher—has one of the methyl groups eclipsing the double bond, so that when we start looking at reactions of this type of alkene, we shall have to consider both conformations.

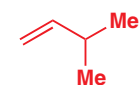

model alkene **1**

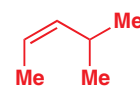

model alkene **2**

K. N. Houk works at the University of California in Los Angeles. He has provided explanations for a number of stereochemical results by using powerful computational methods.

model alkene 1 has two low-energy conformations

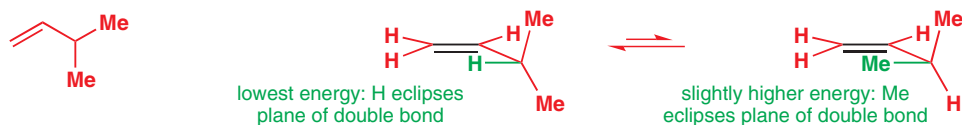

model alkene 2 has only one low-energy conformation

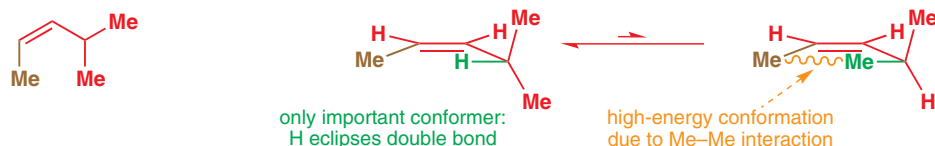

■ This effect—the control of conformation by a *cis* substituent—is known as **allylic strain** or $A^{1,3}$ strain because the groups involved are on carbons 1 and 3 of an allylic system.

For the model alkene 2, with a *cis* substituent, the conformation is more predictable and the only low-energy conformer is the one with the hydrogen eclipsing the double bond. There is no room for a methyl group to eclipse the double bond because if it did it would get too close to the *cis* substituent at the other end of the double bond.

The message from the calculations is this:

- The lowest-energy conformation of a chiral alkene will have H eclipsing the double bond.
- If there is a *cis* substituent on the alkene, this will be the only important conformation; if there is no *cis* substituent, other conformations may be important too.

Now we can apply the theoretical model to some real examples.

Stereoselective epoxidation

We started this section with a diastereoselective epoxidation of an alkene. The alkene was this one, and it has a substituent *cis* to the stereogenic centre. We can therefore expect it to have one important conformation, with H eclipsing the double bond. When a reagent—*m*-CPBA here—attacks this conformation, it will approach the less hindered face, and the outcome is shown.

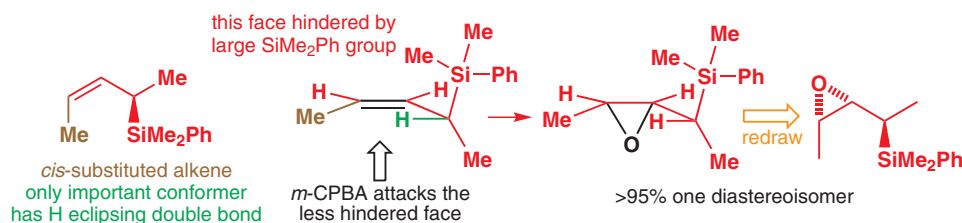

Interactive model for epoxidation controlled by allylic strain

Without the *cis* substituent, selectivity is much lower.

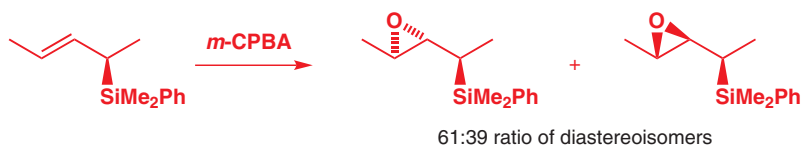

m-CPBA still attacks the less hindered face of the alkene, but with no *cis* substituent there are two low-energy conformations: one with H eclipsing the double bond, and one with Me eclipsing. Each gives a different stereochemical result, explaining the low stereoselectivity of the reaction.

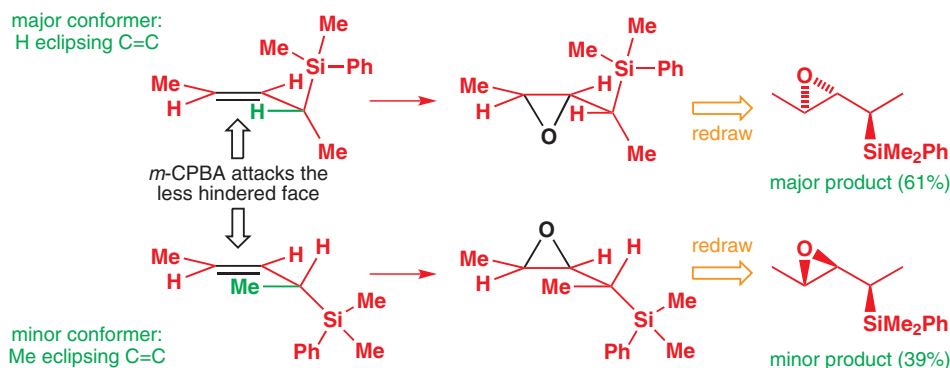

■ Again, draw the product in the same conformation as the starting material then flatten into the plane of the page.

You saw at the end of the last chapter that the reactions of *m*-CPBA can be directed by hydroxyl groups, and the same thing happens in the reactions of acyclic alkenes. This allylic alcohol epoxidizes to give a 95:5 ratio of diastereoisomers.



Drawing the reactive conformation explains the result. The thing that counts is the *cis* methyl group: the fact that there is a *trans* one too is irrelevant as it is just too far away from the stereogenic centre to have an effect on the conformation. The reaction uses a racemic mixture, but to explain the diastereoselectivity we just have to pick one enantiomer and show what happens to that.

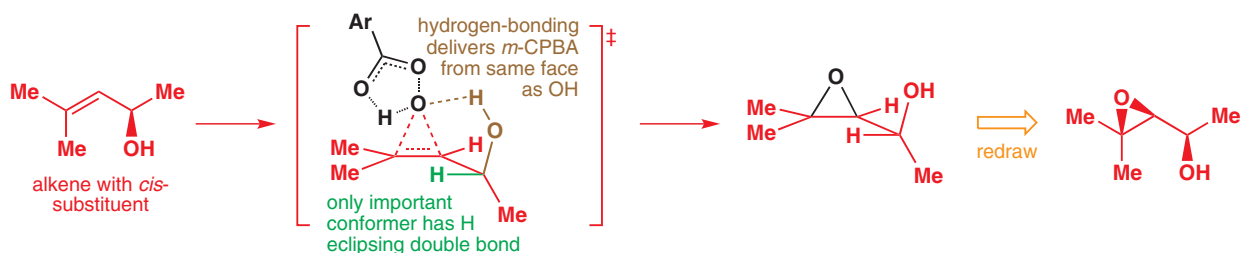

● To explain the stereoselectivity of reactions of chiral alkenes:

- Draw the conformation with H eclipsing the double bond.
- Allow the reagent to attack the less hindered of the two faces or, if coordination is possible, to be delivered to the face *syn* to the coordinating group.
- Draw the product in the same conformation as the starting material.
- Redraw the product as a normal structure with the longest chain in the plane of the paper.

Stereoselective enolate alkylation

Chiral enolates can be made from compounds with a stereogenic centre β to a carbonyl group. Once the carbonyl is deprotonated to form the enolate, the stereogenic centre is next to the double bond and in a position to control the stereoselectivity of its reactions. The scheme below shows stereoselectivity in the reactions of some chiral enolates with methyl iodide.

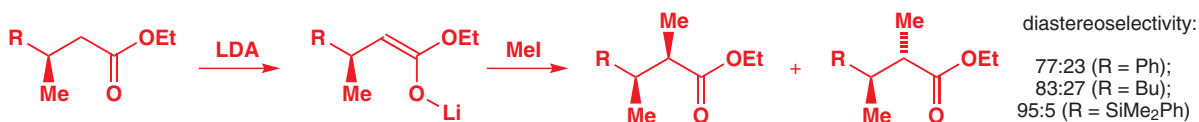

The enolate is a *cis*-substituted alkene because either O or OEt must be *cis* to the stereogenic centre, so that to explain the stereoselectivity we need consider only the conformation with H eclipsing the double bond. Notice how the diastereoselectivity increases as the group R gets bigger because there is then more contrast between the size of Me and R. In each case, the electrophile adds to the less hindered face, opposite R.

Interactive model for enolate alkylation controlled by allylic strain

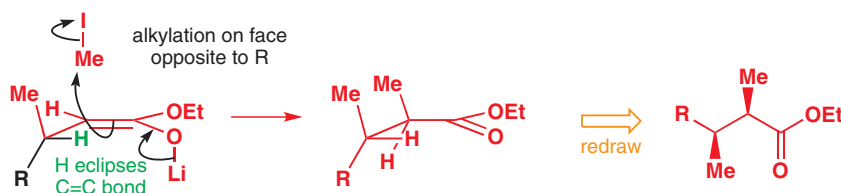

The other diastereoisomer can be made just by having the methyl group in place first and then protonating the enolate. The selectivities are lower (because a proton is small), but this does illustrate the way in which reversing the order of introduction of two groups can reverse the stereochemical outcome of the reaction.

The relative stereochemistry of the starting material is lost in the enolization step so either diastereoisomer or a mixture can be used.

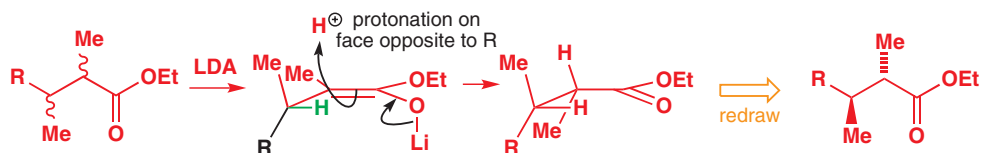

Aldol reactions can be stereoselective

In Chapter 26 you met the **aldol reaction**: reaction of an enolate with an aldehyde or a ketone. Many of the examples you saw approximated to this general pattern.

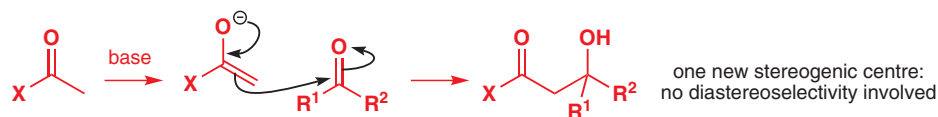

Only one new stereogenic centre is created, so there is no question of diastereoselectivity. But with substituted enolates, two new stereogenic centres are created and we need to be able to predict which diastereoisomer will be formed. Here is an example from p. 626. We did not consider stereochemistry at that stage, but we can now reveal that the *syn* diastereoisomer is the major product of the reaction.

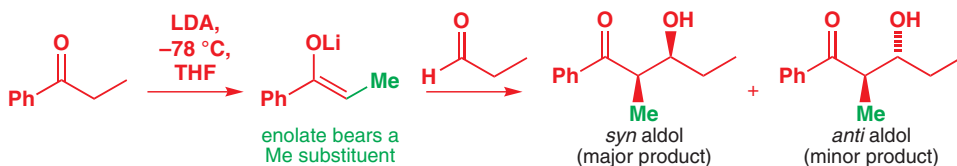

The important point about substituted enolates is that they can exist as two geometrical isomers, *cis* or *trans*. Which enolate is formed is an important factor controlling the diastereoselectivity because it turns out that, in many examples of the aldol reaction, *cis* enolates give *syn* aldols preferentially and *trans* enolates give *anti* aldols preferentially.

● Diastereoselectivity in aldol reactions

Generally (but certainly not always!) in aldol reactions:

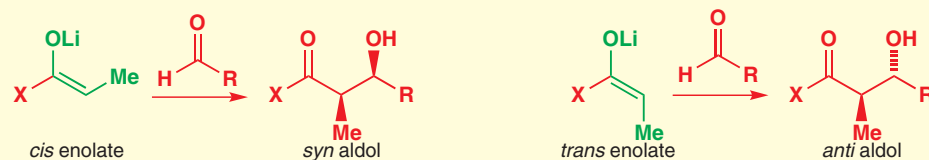

Let's start by showing some examples and demonstrating how we know this to be the case. Some enolates can exist only as *trans* enolates because they are derived from cyclic ketones. This enolate, for example, reacts with aldehydes to give only the *anti* aldol product.

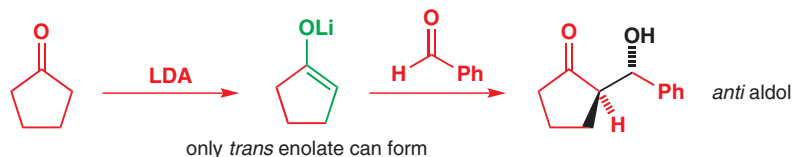

If we choose the group 'X', next to the carbonyl group, to be large, then we can be sure of getting just the *cis* enolate. So, for example, the lithium enolate of this *t*-butyl ketone forms just as one geometrical isomer, and reacts with aldehydes to give only the *syn* aldol product.

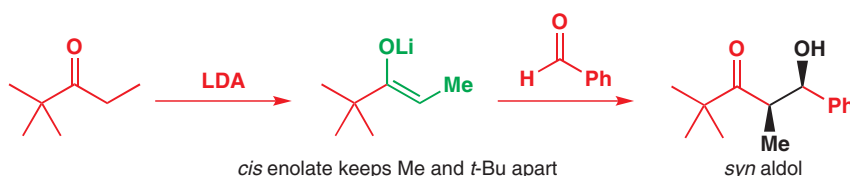

Interactive mechanism for *anti* stereoselective aldol reaction

Interactive mechanism for *syn* stereoselective aldol reaction

cis and *trans*, *E* and *Z*, *syn* and *anti*

Before going further, there are two points we must clarify. The first is a problem of nomenclature, and concerns the enolates of esters. Here are two closely related ester enolate equivalents, drawn with the same double bond geometry. Is it *E* or *Z*?

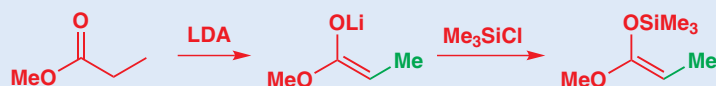

The answer is both! For the Li enolate, the usual rule makes OLi of lower priority than OMe (because Li has a smaller atomic number than C), so it's *E*, while the silyl enol ether (or 'silyl ketene acetal') has OSi of higher priority than OMe (Si has a larger atomic number than C), so it's *Z*. This is merely a nomenclature problem, but it would be irritating to have to reverse all our arguments for lithium and boron enolates (as opposed to, say, tin or silicon ones). So, for the sake of consistency, it is much better to avoid the use of *E* and *Z* with enolates and instead use *cis* and *trans*, which then always refer to the relationship between the substituent and the anionic oxygen (bearing the metal).

The other point concerns *syn* and *anti*. We said earlier that there is no precise definition of these terms: they are a useful way of distinguishing two diastereoisomers provided the structure of at least one of them is presented in diagrammatic form. For aldol products the convention is that *syn* or *anti* refers to the enolate substituent (the green Me in the last example) and the new hydroxyl group, provided the main chain is in the plane of the paper, the way we have encouraged you to draw molecules.

The aldol reaction has a chair-like transition state

These are the experimental facts: how can we explain them? Aldol reactions are another class of stereoselective process with a cyclic transition state. During the reaction, the lithium is transferred from the enolate oxygen to the oxygen of the carbonyl electrophile. This is represented in the margin both in curly arrow terms and as a transition state structure. A six-membered ring is involved, and we can expect this ring to adopt more or less a chair

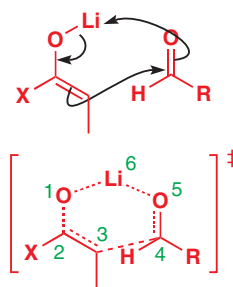

conformation. The easiest way to draw this is first to draw the chair, and then convert atoms to O or Li as necessary. Here it is.

The six-membered ring transition state for the aldol reaction was proposed by Zimmerman and Traxler and is sometimes called the **Zimmerman–Traxler transition state**.

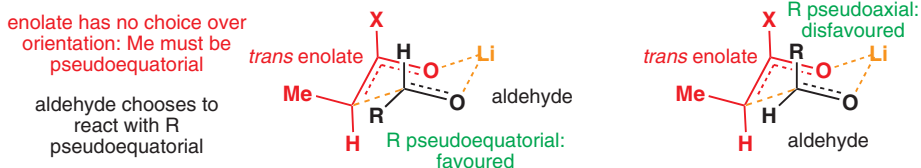

In drawing this chair, we have one choice: do we allow the aldehyde to place R equatorial or axial? Both are possible but, as you should now expect, there are fewer steric interactions if R is equatorial. Note that the enolate doesn't have the luxury of choice. If it is to have three atoms in the six-membered ring, as it must, it can do nothing but place the methyl group pseudoequatorial. The aldol formed from the favoured transition state structure, with R pseudoequatorial, is shown below—first in the conformation of the transition state, and then flattened out on to the page, and it is *anti*.

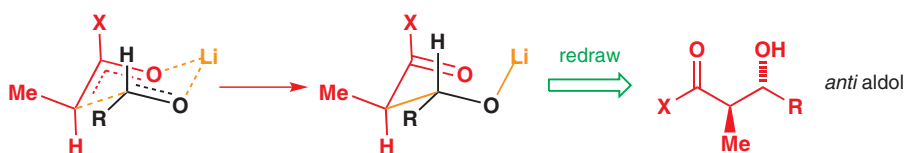

Our advice on p. 860, which we follow again here, was to draw the product first of all in the conformation of the starting material and only then to flatten it out to a 'normal' structure.

Interactive mechanism: *trans* enolate gives *anti* stereoselective aldol reaction

We can do the same for the *cis* enolate. The enolate has no choice but to put its methyl substituent pseudoaxial, but the aldehyde can choose either pseudoequatorial or pseudoaxial. Again, pseudoequatorial is better and the reaction gives the product shown—the *syn* aldol.

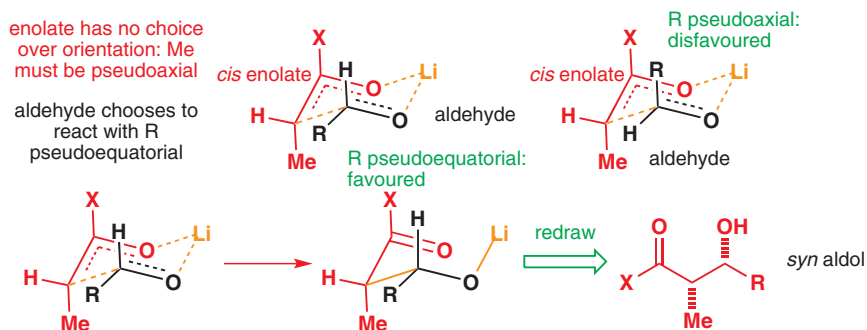

Interactive mechanism: *cis* enolate gives *syn* stereoselective aldol reaction

Stereoselective enolization is needed for stereoselective aldols

The cyclic transition state explains how enolate geometry controls the stereochemical outcome of the aldol reaction. But what controls the geometry of the enolate? For lithium enolates of ketones the most important factor is the size of the group that is not enolized. Large groups force the enolate to adopt the *cis* geometry; small groups allow the *trans* enolate to form. Because we can't separate the lithium enolates, we just have to accept that the reactions of ketones with small R will be less diastereoselective.

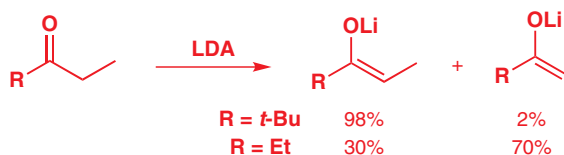

With *boron* enolates, we don't have to rely on the structure of the substrate—we choose the groups on boron—and we can get either *cis* or *trans* depending on which groups these are. Boron enolates are made by treating the ketone with an amine base (often Et_3N or $i\text{-PrNEt}_2$) and $\text{R}_2\text{B-X}$, where X^- is a good leaving group such as chloride or triflate (CF_3SO_3^-). With bulky

groups on boron, such as two cyclohexyl groups, a *trans* enolate forms from most ketones. The boron enolate reacts reliably with aldehydes to give *anti* aldol products through the same six-membered transition state that you saw for lithium enolates.

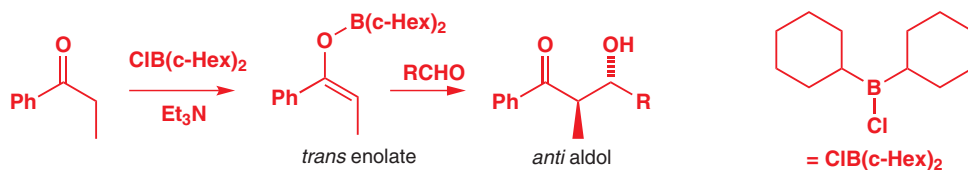

With smaller B substituents, the *cis* enolate forms selectively. Here, the boron is part of a bicyclic structure known as 9-BBN (9-borabicyclononane). The bicyclic part may look large but, as far as the rest of the molecule is concerned, it's 'tied back' behind the boron, and the methyl group can easily lie *cis* to oxygen. The *cis* enolate then gives *syn* aldol products. Di-*n*-butylboron triflate (Bu_2BOTf) also gives *cis* enolates.

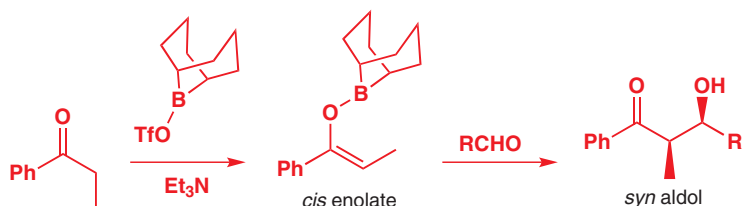

➔ 9-BBN was mentioned in Chapter 19.

● Summary: How to make *syn* and *anti* aldols

To make *syn* aldols of ketones:

- use boron enolate with 9-BBN-OTf or Bu_2BOTf
- from a ketone RCOEt with bulky R, use lithium enolate

To make *anti* aldols of ketones:

- use boron enolate with $(c\text{-Hex})_2\text{BCl}$
- from a cyclic ketone, use lithium enolate

Single enantiomers from diastereoselective reactions

The aldol reactions in the last section made single diastereoisomers from two achiral compounds. No enantiomerically pure reagents were used, so the reaction had no choice but to give the product diastereoisomer as a racemic mixture of its two enantiomers.

In all the other diastereoselective reactions in this chapter, the starting material has been chiral, with the formation of new chiral centres controlled by the configuration of the starting material. Whatever the diastereoselectivity of the reaction, if the starting material is racemic, so will be the product; if the starting material is enantiomerically pure, so will be the product. The epoxidation of the allylic alcohol in the margin illustrates this point.

The reaction starts with racemic material (no stereochemistry is shown at the chiral centre) and makes a racemic product. Of course we have only *drawn* one enantiomer—the only way to draw one diastereoisomer is to choose one enantiomer and draw that—but the indication '±' underneath tells you to expect an equal amount of the other enantiomer as well. Even without this indication, you should be able to work out, in any given case, whether a compound is racemic or not, providing you know where it comes from. Here the starting material is racemic and the reagent is achiral so the product must be racemic.

The example of this reaction earlier in the chapter (p. 856) was this type of reaction. The starting alcohol was racemic and the product was just one racemic diastereoisomer—the all *cis* compound. But if the starting material *had* been enantiomerically pure, so would the product. One enantiomer gives one enantiomer of the product: the other enantiomer of the alcohol

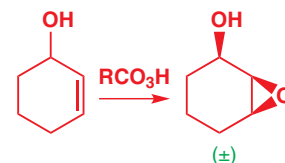

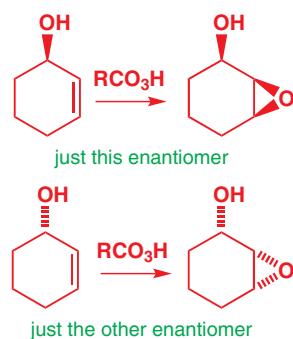

gives the other. Both products are the same diastereoisomer (all *cis*) but they are mirror images of each other. If you start with enantiomerically pure compounds, the products will be enantiomerically pure as well.

We gave an example of this during the discussion of the Felkin–Anh model. The starting material was the natural amino acid isoleucine and was the enantiomer shown. The product of the aldol reaction was therefore also a single enantiomer. The original chiral centre in both these examples is not affected by the reaction and remains unchanged.

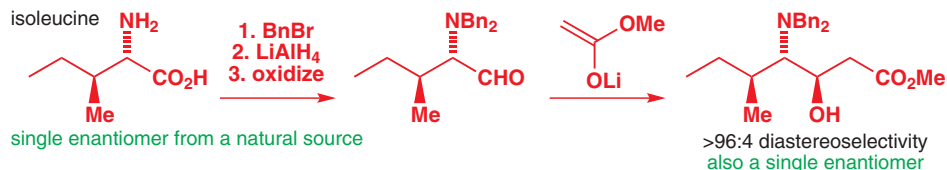

It is much more useful to make enantiomerically pure as well as diastereoisomerically pure compounds, particularly in the synthesis of a drug. The strategy used here is to make the starting material from an enantiomerically pure compound available from nature: in this case an amino acid. These available enantiomerically pure compounds are known collectively as the **chiral pool**. You can read more about this in Chapter 41 on asymmetric synthesis.

If you are making an enantiomerically pure compound with more than one stereogenic centre, only one needs be borrowed from the chiral pool, provided diastereoselective reactions can be used to introduce the others with control over relative stereochemistry. Because the first chiral centre has defined absolute configuration, any diastereoselective reaction that controls the relative stereochemistry of a new chiral centre also defines its absolute configuration.

We'll use as an illustration a synthesis of a rare sugar, methyl mycaminoside, containing five chiral centres. Only one chiral centre comes directly from the chiral pool—the rest are introduced diastereoselectively. The naturally derived, enantiomerically pure compound used as the starting material is (*S*)-lactic acid. The starting chiral centre, preserved right through the sequence, is ringed in green.

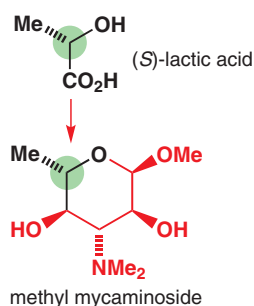

The ring was built up using familiar chemistry from acetylated (*S*)-lactic acid, and a cyclization step introduced the second chiral centre in the final step of the scheme below. The methyl group goes pseudoequatorial on the newly formed ring, while the anomeric effect, which was explained on p. 801 of Chapter 31, induces the methoxy group to prefer the pseudoaxial position.

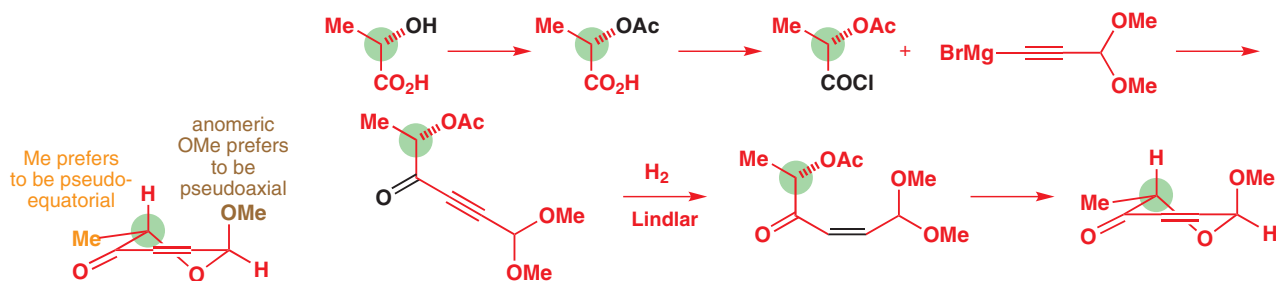

The third stereogenic centre was controlled by reduction of the ketone from the axial direction to give the equatorial alcohol, which then directed introduction of the fourth and fifth stereogenic centres by epoxidation.

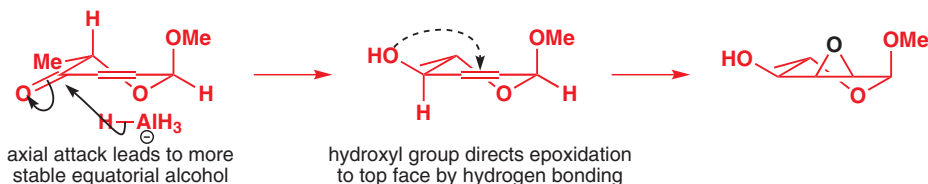

➡ The conformational factors governing reduction of cyclohexanones are discussed in Chapter 16. The directing effects of OH groups in epoxidation are discussed in Chapters 32 and earlier in this chapter.

Finally, the simple nucleophilic amine Me_2NH attacks the epoxide with inversion of configuration to give methyl mycaminoside. The conformational drawing shows that all substituents are equatorial except the MeO group, which prefers to be axial because of the anomeric effect. Starting from an enantiomerically pure compound containing one chiral centre, four new chiral centres are introduced in sequence by diastereoselective reactions of various kinds. The final product is necessarily a single enantiomer.

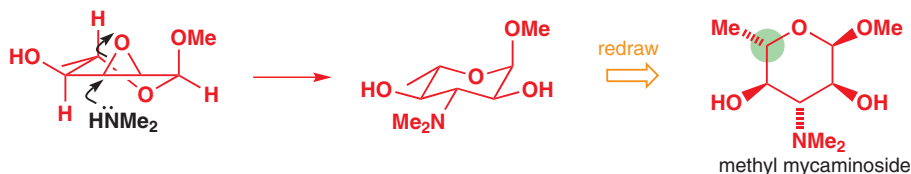

■ Normally, axial attack occurs on cyclohexane epoxides, as explained in Chapter 32, but the rule is not rigid, as you can see here. Equatorial attack occurs because the transition state already has much of the stability of the equatorially substituted product. You should continue to assume that related epoxides will typically undergo axial attack.

The structure and synthesis of penaresidin

Our last example is a natural product called penaresidin A. It was isolated from a Japanese sponge in 1991, and is now known to have the structure shown below. When it was first discovered, it proved difficult to find out the stereochemistry and, in particular, the relative stereochemistry between the two remotely related groups of chiral centres was not initially known.

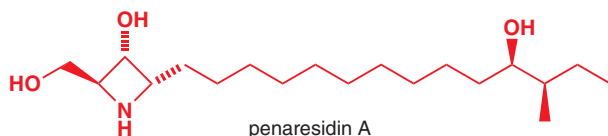

What is sure is the relative stereochemistry around the four-membered azetidine ring: the NMR methods described in Chapter 31 give that. What is also certain is that natural penaresidin A is enantiomerically pure. What Mori and his co-workers set out to do was to make, using unambiguous stereoselective methods, the possible diastereoisomers of penaresidin A to discover which was the same as the natural product.

The challenge of constructing the three chiral centres at the left-hand end of the molecule can be solved by taking just one of them from a natural source—in this case the amino acid L-serine. The amino group of serine was protected as the Boc derivative, and the hydroxyl and amino groups condensed with the dimethoxyacetal of acetone to form a five-membered ring. Now the free ester could be reduced with LiBH_4 and oxidized to the aldehyde by the Swern method (Chapter 27).

➔ The Boc protecting group was introduced on p. 557; the Swern oxidation is on p. 667.

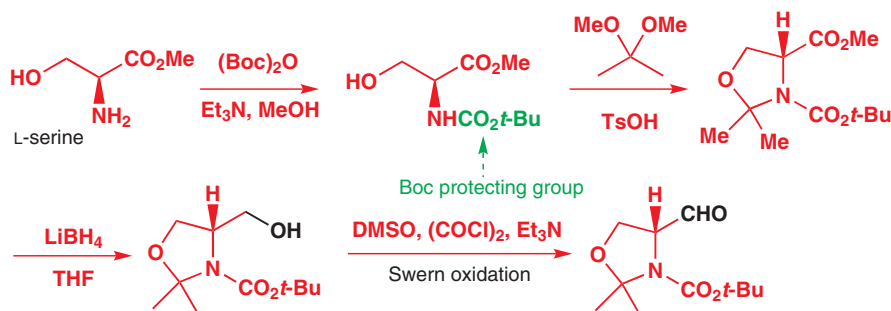

How will this aldehyde react with nucleophiles such as lithiated alkynes? Consider a Felkin–Anh transition state: again, we know that the substituted nitrogen atom, being electronegative and bulky, will lie perpendicular to the carbonyl group in the most reactive conformation. Looking at the two alternatives shown below, it's easy to see that the one on the right allows unhindered attack, and in the synthesis an alkynyl anion was used to make the product shown.

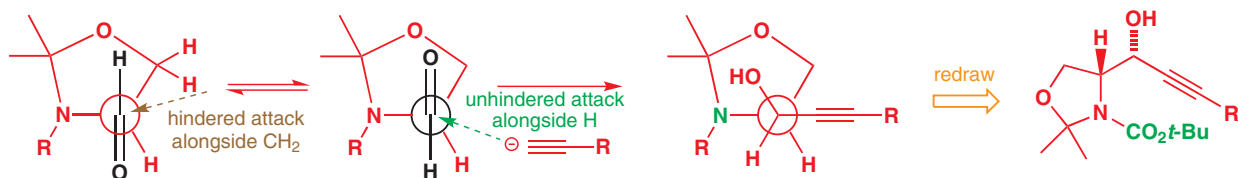

➤ Reduction of alkynes to *E* double bonds is covered in Chapter 27, p. 681.

The alkyne was then reduced to an *E* alkene by a dissolving metal reduction, a step which also hydrolysed the five-membered heterocycle. The next step, an epoxidation, is needed to install the third of the chiral centres at the left-hand end of penarisidine. However, hydrogen-bond directed epoxidation of this allylic alcohol would be expected to give the *syn* product shown, which has the wrong relative stereochemistry between the brown OH group and the epoxide.

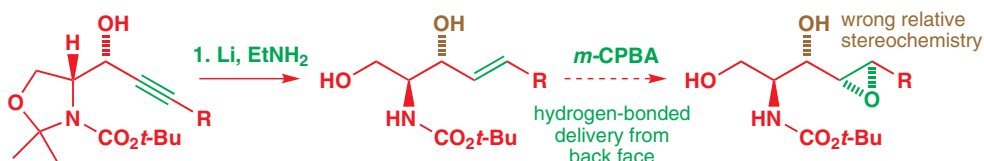

■ The selectivity of the epoxidation of the *E* double bond was still only moderate (about 60:40). From the discussion on p. 866 you should be able to deduce why.

The solution is to use a large blocking group to prevent this brown OH group hydrogen bonding to the *m*-CPBA. The *t*-butyldimethylsilyl group (TBDMS) is the best, and when both OH groups are protected, some of the right diastereoisomer is formed by attack of *m*-CPBA on the top face of the alkene. Reduction of the epoxide with DIBAL (*i*-Bu₂AlH) now gives the correct diastereoisomer.

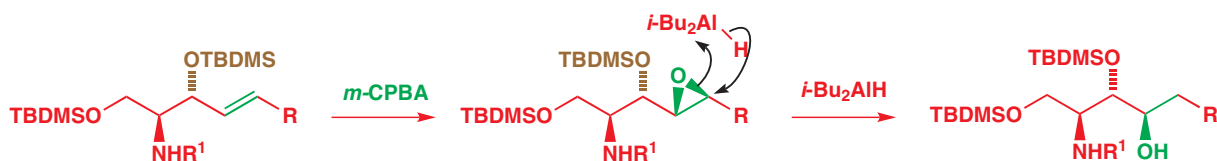

To close the ring, the green hydroxyl group was converted to a good leaving group, mesylate (MeSO₃), ready for an attack by the nitrogen with inversion on treatment with base. Make sure you can see how inversion at this centre gives the stereochemistry shown! The chemists knew at this stage they were on the right track with regard to relative stereochemistry because the NMR spectrum of structures containing any long alkyl chain R were very similar to that of the natural compound.

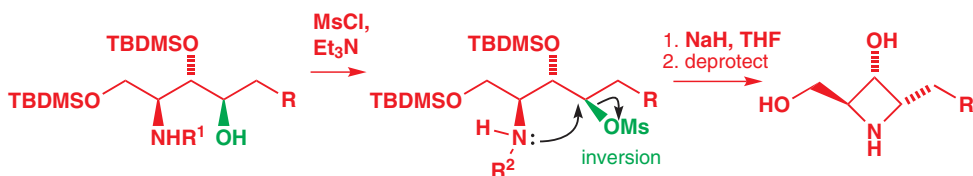

Confirming the stereochemistry by synthesis

The other two chiral centres at the right-hand end of the chain are so far removed from the ring (by 10 CH₂ groups) that there is no simple way to determine their stereochemistry relative to the three at the left-hand end by NMR. The solution to problems of assignment like this is often to make the various isomers by unambiguous synthesis and compare the NMR spectra of the natural and synthetic compounds. This is what Mori did in this case.

The chiral pool can again be called into play by using another amino acid, *L*-isoleucine, as starting material. First the amino group must be converted to a leaving group by diazotization with nitrous acid (sodium nitrite in dilute HCl) and substituted by water to give a hydroxy acid. The acid is esterified and reduced to a diol.

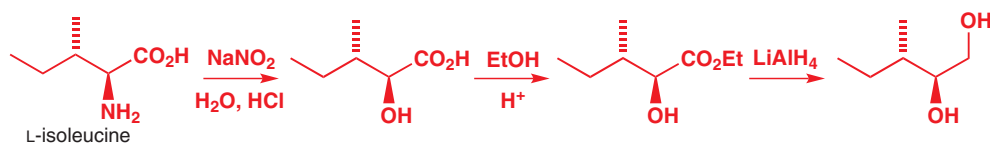

Conversion of the diol's primary hydroxyl group to a leaving group (here a tosylate) allows the epoxide to be formed with retention of the two stereogenic centres of the starting material. Cyclization in base gives an epoxide. Overall, the enantiomerically pure starting material is converted stereospecifically into a single enantiomer of a single diastereoisomer of the epoxide.

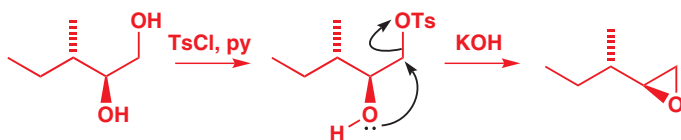

Before we go on, look back at the first reaction of this sequence—the conversion of L-leucine to the hydroxy acid. The stereochemistry may surprise you: look carefully and you will see that the amino group has been displaced with *retention* of stereochemistry. Retentive substitutions usually indicate double inversions, and here the carboxylic acid gets involved in the displacement to give (with inversion) a very unstable compound called an α -lactone whose strained ring is opened by water, also with inversion.

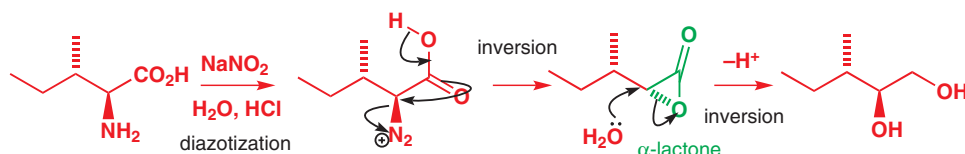

The epoxide may now be opened with a nucleophile to give the right-hand half of the target molecule. The alkyne shown below, which has an *anti* relationship between the hydroxyl and methyl groups, was made and linked to the left-hand half of penaresidin A by using it to attack the aldehyde the method described above. However, the final product was not the same as natural penaresidin A!

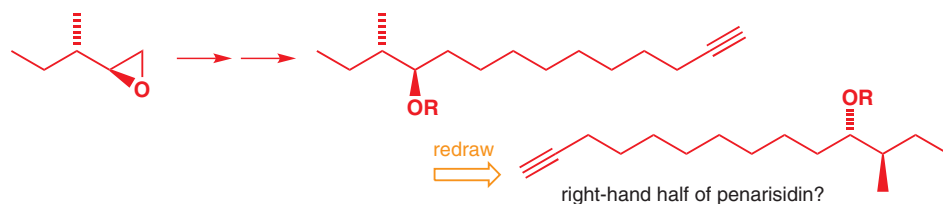

Clearly, some aspect of relative stereochemistry was wrong. So the synthesis was repeated, this time using the *syn* diastereoisomer of the substituted alkyne obtained using one of the methods we will describe in Chapter 41. With this isomer the final compound had spectroscopic data identical with the natural product, and the question of its stereochemistry was solved. It is not uncommon for synthesis to be the only reliable way of proving the detailed structure of a compound.

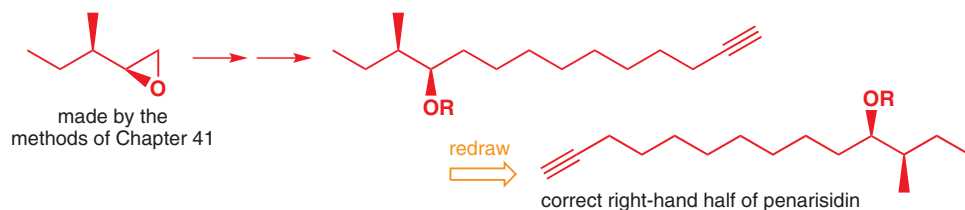

➔ We used NaNO_2 in acid to convert amino groups into diazonium salts containing the excellent leaving group N_2 in Chapter 22, p. 520.

➔ We will address similar examples of 'neighbouring group participation' in Chapter 36. There is more on α -lactones on p. 934. The mechanism for the diazotization step is in Chapter 22, p. 521.

Looking forward

Once you have got hold of a molecule as a single enantiomer, however simple that molecule may be, you can always use reliably diastereoselective reactions of the type described in this chapter and the one before to decorate it with further chiral centres. This is a very important point that underlies the field of asymmetric synthesis, which we will cover in Chapter 41. There you will see developments of the ideas we have just been describing, where chiral centres derived from nature are used to introduce new stereochemistry even though they themselves need not appear in the final product. But before we move on to such reactions, we need to cover a handful of important new reaction mechanisms, many of which provide further ways of introducing new stereochemical features into molecules. The first of these new classes of reactions is *cycloadditions*.

Further reading

For explanations of pericyclic reactions and other reactions, using the full molecular orbital treatment, consult: Ian Fleming, *Molecular Orbitals and Organic Chemical Reactions, Student Edition*, Wiley, Chichester 2009. There is also a more comprehensive edition intended for practicing chemists, called the *Library Edition*.

For a comprehensive treatment of diastereoselectivity and the chiral pool approach to asymmetric synthesis as well as control of double bond geometry see P. Wyatt and S. Warren, *Organic*

Synthesis: Strategy and Control, Wiley, Chichester, 2007 and the accompanying *Workbook*, also Wiley, 2008.

Leading references for the synthesis of penaresidin are K. Mori and group, *J. Chem. Soc., Perkin Trans. 1*, 1997, 97; S. Knapp and Y. Dong, *Tetrahedron Lett.*, 1997, **38**, 3813 and H. Yoda and group, *Tetrahedron Lett.*, 2003, **44**, 977. The synthesis of methyl mycaminoside is from Koga, K., Yamada, S.-I., Yoh, M., Mizoguchi, T. *Carbohydr. Res.* **1974**, **36**, C9–C11.

Check your understanding



To check that you have mastered the concepts presented in this chapter, attempt the problems that are available in the book's Online Resource Centre at <http://www.oxfordtextbooks.co.uk/orc/clayden2e/>

Pericyclic reactions 1: cycloadditions

34

Connections

➔ Building on

- Structure of molecules [ch4](#)
- Reaction mechanisms [ch5](#)
- Conjugation and delocalization [ch7](#)
- Reactions of alkenes [ch19](#) & [ch22](#)
- Aromatic heterocycles [ch29](#) & [ch30](#)

Arriving at

- In cycloadditions electrons move in a ring
- In cycloadditions more than one bond is formed simultaneously
- There are no intermediates in cycloadditions
- Cycloadditions are a type of pericyclic reaction
- The rules that govern cycloadditions: how to predict what will and will not work
- Photochemical reactions: reactions that need light
- Making six-membered rings by the Diels–Alder reaction
- Making four-membered rings by [2 + 2] cycloaddition
- Making five-membered rings by 1,3-dipolar cycloaddition
- Using cycloaddition to functionalize double bonds stereospecifically
- Using ozone to break C=C double bonds

➔ Looking forward to

- Electrocyclic reactions and sigmatropic rearrangements [ch35](#)
- Radical reactions [ch37](#)
- Reactions of carbenes [ch38](#)
- Asymmetric synthesis [ch41](#)

A new sort of reaction

Most organic reactions are ionic. Electrons move from an electron-rich atom towards an electron-poor atom: anions or cations are intermediates. Formation of a cyclic ester (a lactone) is an example. The reaction involves five steps and four intermediates. The reaction is acid-catalysed and each intermediate is a cation. Electrons flow in one direction in each step—towards the positive charge. This is an ionic reaction.

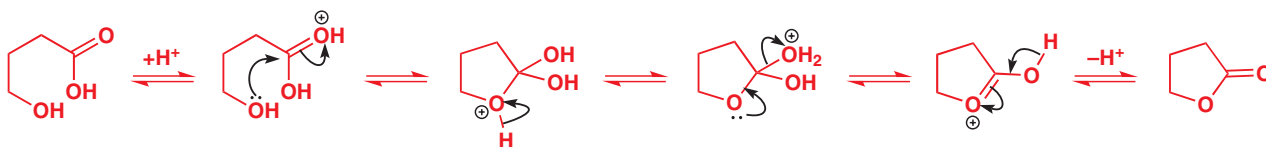

This chapter is about a totally different reaction type. Electrons move round a circle and there are no positive or negative charges on any intermediates—indeed, there are no inter-

■ In Chapter 24 you met a brief introduction to a third category—radical reactions—in which one electron instead of two is on the move. This will be developed in more detail in Chapter 37.

Otto Diels (1876–1954) and his research student Kurt Alder (1902–58) worked at the University of Kiel and discovered this reaction in 1928. They won the Nobel Prize in 1950. Diels also discovered carbon suboxide, C_2O_3 (see p. 420).

■ Cycloadditions are the first of three classes of pericyclic reactions, and the whole of this chapter will be devoted to cycloadditions. The other two—sigmatropic and electrocyclic reactions—are discussed in Chapter 35.

mediates at all. This type of reaction is called **pericyclic**. The most famous example is the **Diels–Alder reaction**. This reaction goes in a single step simply on heating. We can draw the mechanism with the electrons going round a six-membered ring.

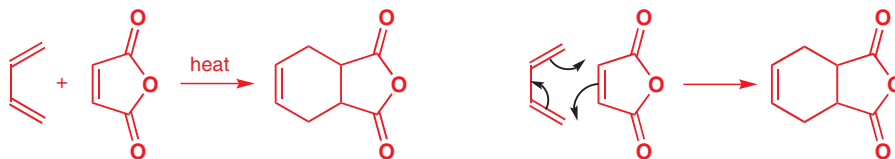

Each arrow leads directly to the next, and the last arrow connects to the first. We have drawn the electrons rotating clockwise, but it would make no difference at all if we drew the electrons rotating anticlockwise.

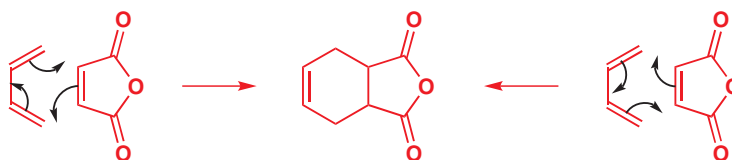

Both mechanisms are equally correct. The electrons do not really rotate at all. In reality two π bonds disappear and two σ bonds take their place by the electrons moving smoothly out of the π orbitals into the σ orbitals. Such a reaction is called a **cycloaddition**. We must spend some time working out how this could happen. First, just consider the orbitals that overlap to form the new bonds. Providing the reagents approach in the right way, nothing could be simpler.

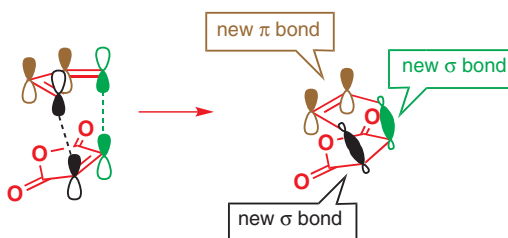

The black p orbitals are perfectly aligned to make a new σ bond, as are the two green orbitals, while the two brown orbitals are exactly right for the new π bond at the back of the ring. As this is a one-step reaction there are no intermediates but there is one transition state looking something like this:

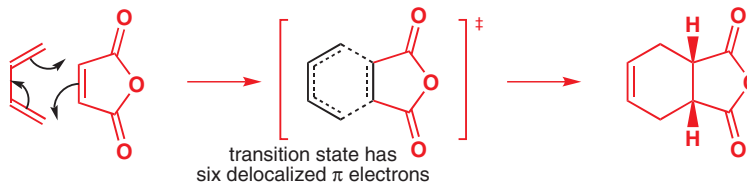

One reason that the Diels–Alder reaction goes so well is that the transition state has six delocalized π electrons and thus is aromatic in character, having some of the special stabilization of benzene. You could look at it as a benzene ring having all its π bonds but missing two σ bonds. This simple picture is fine as far as it goes, but it is incomplete. We shall return to a more detailed orbital analysis when we have described the reaction in more detail.

Captan

One important industrial application of the Diels–Alder reaction we have been discussing is in the synthesis of the agricultural fungicide Captan.

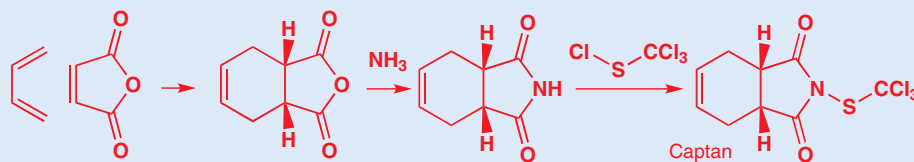
**General description of the Diels–Alder reaction**

Diels–Alder reactions occur between a **conjugated diene** and an alkene, usually called the **dienophile**. Here are some examples: first an open-chain diene with a simple unsaturated aldehyde as the dienophile.

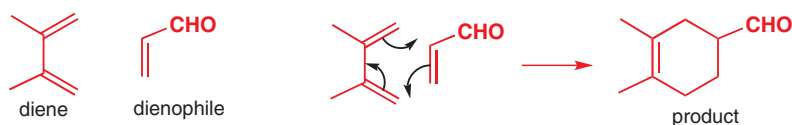

The mechanism is the same and a new six-membered ring is formed having one double bond. Now a reaction between a cyclic diene and a nitroalkene.

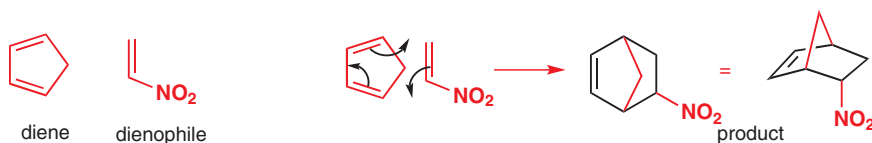

➔ This fused ring system, and how to draw it, was described in more detail in Chapter 32.

The mechanism leads clearly to the first drawing of the product but this is a cage structure and the second drawing is better. The new six-membered ring is outlined in black in both diagrams. A more elaborate example shows that quite complex molecules can be quickly assembled with this wonderful reaction.

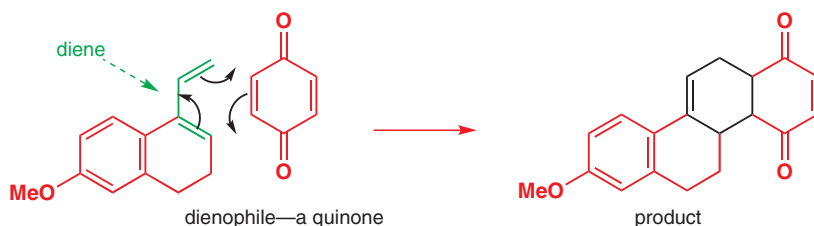
**The diene**

The diene component in the Diels–Alder reaction can be open-chain or cyclic and it can have many different kinds of substituents. There is only one limitation: it must be able to take up the conformation shown in the mechanism. Butadiene normally prefers the *s-trans* conformation with the two double bonds as far away from each other as possible for steric reasons. The barrier to rotation about the central σ bond is small (about 30 kJ mol⁻¹ at room temperature) and rotation to the less favourable but reactive *s-cis* conformation is rapid.

■ The 's' in the terms '*s-cis*' and '*s-trans*' refers to a σ bond and indicates that these are conformations about a single bond and not configurations about a double bond.

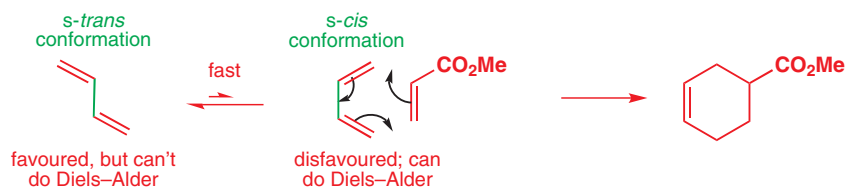
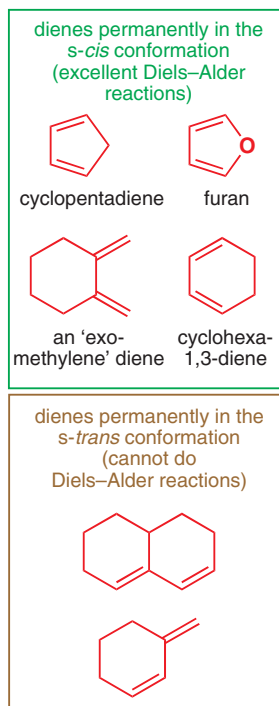

Cyclic dienes that are permanently in the *s-cis* conformation are exceptionally good at Diels–Alder reactions—cyclopentadiene is a classic example—but cyclic dienes that are permanently in the *s-trans* conformation and cannot adopt the *s-cis* conformation will not do the Diels–Alder reaction at all. The two ends of these dienes cannot get close enough to react with an alkene and, in any case, the product would have an impossible *trans* double bond in the new six-membered ring. (In the Diels–Alder reaction, the old σ bond in the centre of the diene becomes a π bond in the product and the conformation of that σ bond becomes the configuration of the new π bond in the product.)

● The diene

The diene must have the *s-cis* conformation.

The dienophile

The dienophiles you have seen in action so far all have one thing in common. They have an electron-withdrawing group conjugated to the alkene. This is a common, although not exclusive, feature of Diels–Alder dienophiles. There must be some extra conjugation—at least a phenyl group or a chlorine atom—or the cycloaddition does not occur. You will often see the reaction between butadiene and a simple alkene (even ethylene) given in books as the basic Diels–Alder reaction. This occurs in only poor yield. Attempts to combine even such a reactive diene as cyclopentadiene with a simple alkene lead instead to the dimerization of the diene. One molecule acts as the diene and the other as the dienophile to give the cage structure shown.

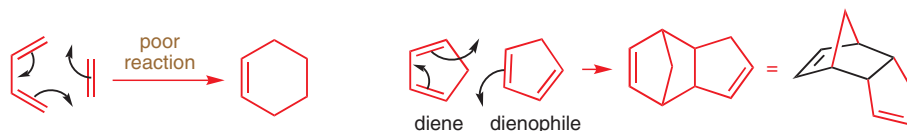

Cyclopentadiene

Cyclopentadiene is formed in considerable amounts during the refining of petroleum. It exists as its dimer at room temperature but can be dissociated into the monomer on heating—the effect of the increased importance of entropy at higher temperatures (Chapter 12). It can be chlorinated to give hexachlorocyclopentadiene, and the Diels–Alder product of this diene with maleic anhydride is a flame retardant.

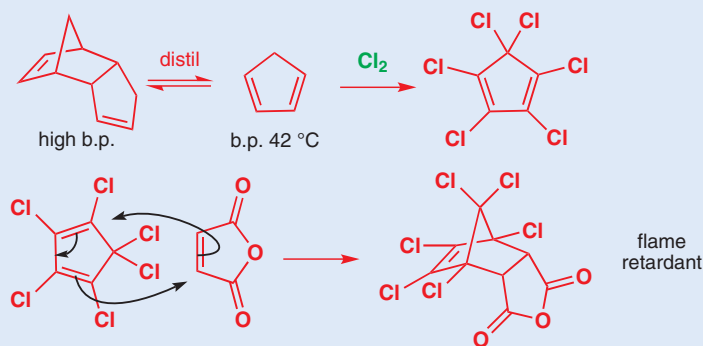

Simple alkenes that do undergo the Diels–Alder reaction include conjugated carbonyl compounds, nitro compounds, nitriles, sulfones, aryl alkenes, vinyl ethers and esters, haloalk-

enes, and dienes. In addition to those you have seen so far, a few examples are shown in the margin. In the last example it is the isolated double bond in the right-hand ring that accepts the diene. Conjugation with the left-hand ring activates this alkene. But what exactly do we mean by ‘activate’ in this sense? We shall return to that question in a minute.

Dieldrin and Aldrin

In the 1950s two very effective pesticides were launched and their names were ‘Dieldrin’ and ‘Aldrin’. As you may guess they were made by the Diels–Alder reaction. Aldrin is derived from two consecutive Diels–Alder reactions. In the first, cyclopentadiene reacts with acetylene to give a simple symmetrical cage molecule ‘norbornadiene’ (bicyclo[2.2.1]heptadiene). Norbornadiene is not conjugated and cannot take part in a Diels–Alder reaction as a *diene*. However, it is quite strained because of the cage and it reacts as a *dienophile* with perchlorocyclopentadiene to give Aldrin.

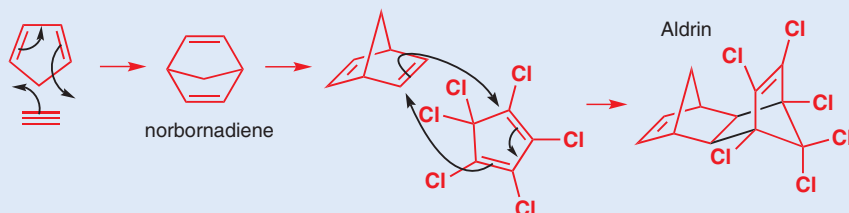

This is quite a complex product but we hope you can see how it is made up by looking at the two new bonds marked in black. Dieldrin is the epoxide of Aldrin. The use of these compounds, like that of many organochlorine compounds, was eventually banned when it was found that chlorine residues were accumulating in the fat of animals high up in the food chain, such as birds of prey and humans.

The product

Recognizing a Diels–Alder product is straightforward. Look for the six-membered ring, the double bond inside the ring, and the conjugating group outside the ring and on the opposite side of the ring from the alkene. These three features mean that the compound is a possible Diels–Alder product.

The simplest way to find the starting materials is to carry out a disconnection that is closer to a real reaction than most. Just draw the reverse Diels–Alder reaction. To do this, draw three arrows going round the cyclohexene ring, starting the first arrow in the middle of the double bond. It doesn't, of course, matter which way round you go.

the disconnection is the imaginary reverse Diels–Alder reaction

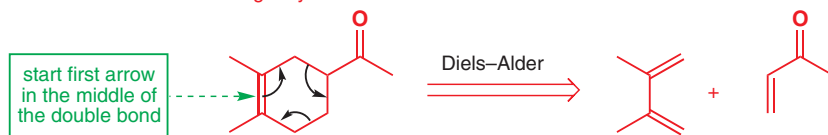

The reaction couldn't be simpler—just heat the components together without solvent or catalyst. Temperatures of around 100–150°C are often needed and this may mean using a sealed tube if the reagents are volatile, as here.

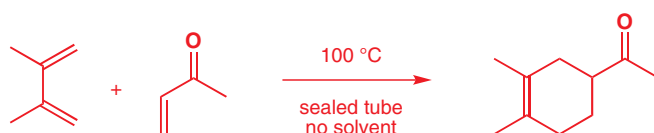

Stereochemistry

The Diels–Alder reaction is stereospecific. If there is stereochemistry in the dienophile, then it is faithfully reproduced in the product. Thus *cis* and *trans* dienophiles give different diastereoisomers of the product. Esters of maleic and fumaric acids provide a simple example.

some dienophiles for the Diels–Alder reaction

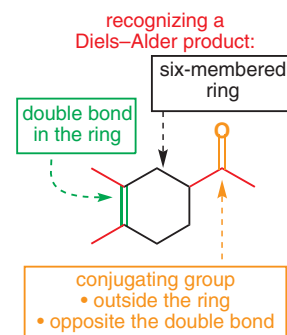
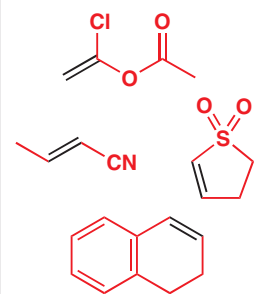

Disconnections and retrosynthetic arrows of the type shown here are ways of thinking about how to make molecules. They appear throughout Chapter 28.

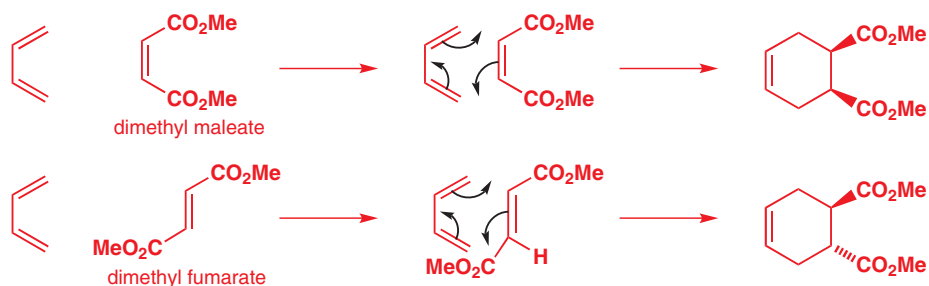

Interactive explanation of the effect of dienophile stereochemistry

In both cases the ester groups simply stay where they are. They are *cis* in the dienophile and remain *cis* in the product. They are *trans* in the dienophile and remain *trans* in the product. The second example may look less convincing—may we remind you that the diene actually comes down on top of the dienophile like this:

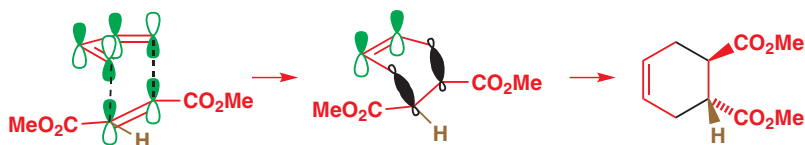

One of the CO₂Me groups is tucked under the diene in the transition state and then, when the product molecule is flattened out in the last drawing, that CO₂Me group appears underneath the ring. The brown hydrogen atom remains *cis* to the other CO₂Me group.

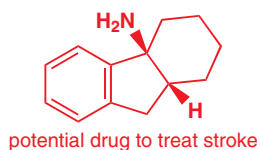

The search by the Parke–Davis company for drugs to treat strokes provided an interesting application of dienophile stereochemistry. The kinds of compound they wanted were tricyclic amines. They don't look like Diels–Alder products at all. But if we insert a double bond in the right place in the six-membered ring, Diels–Alder (D–A) disconnection becomes possible.

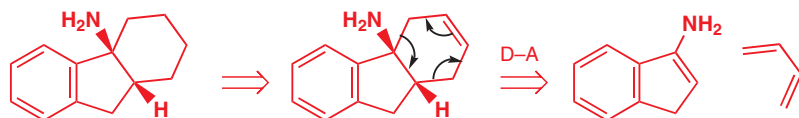

Butadiene is a good diene, but the enamine required is not a good dienophile. An electron-withdrawing group such as a carbonyl or nitro group is preferable: either would do the job. In the event a carboxylic acid that could be converted into the amine by a rearrangement with (PhO)₂PON₃ was used.

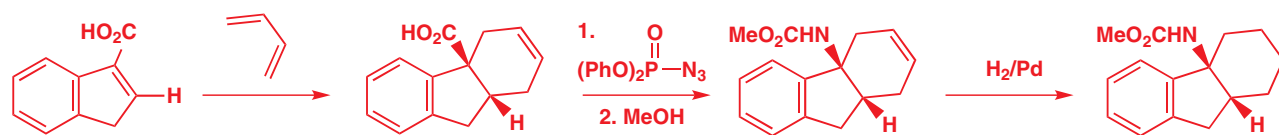

■ The rearrangement with (PhO)₂PON₃ is a Curtius rearrangement: it is described in Chapter 38.

■ You can add the Diels–Alder reaction to your mental list of reactions to consider for making a single diastereoisomer from a single geometrical isomer of an alkene: see Chapter 33.

The stereochemistry at the ring junction must be *cis* because the cyclic dienophile can have only a *cis* double bond. Hydrogenation removes the double bond in the product and shows just how useful the Diels–Alder reaction is for making saturated rings, particularly when there is some stereochemistry to be controlled.

Stereochemistry of the diene

This is slightly more complicated as the diene can be *cis,cis*, or *cis,trans* (there are two of these if the diene is unsymmetrical), or *trans,trans*. We shall look at each case with the same dienophile, an acetylene dicarboxylate, as there is then no stereochemistry in the triple bond! Starting with *cis,cis*-dienes is easy if we make the diene cyclic.

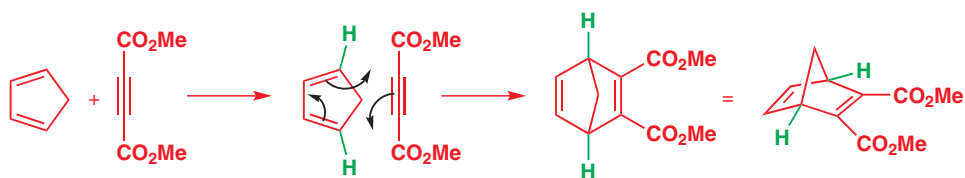

The diene has two sets of substituents—inside and outside. The inside one is the bridging CH_2 group and it has to end up on one side of the molecule (above in the last diagram) while the two green hydrogens are outside and remain so. In the final diagram they are below the new six-membered ring. With a *trans,trans*-diene we simply exchange the two sets of substituents, in this example putting Ph where H was and putting H where the bridging CH_2 group was. This is the reaction:

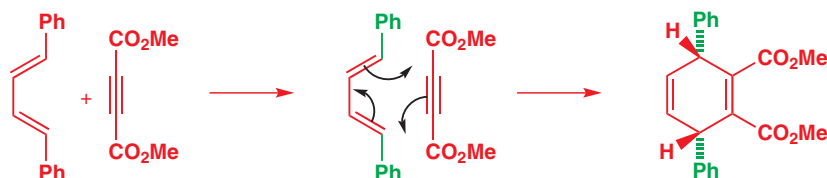

The green Ph groups end up where the hydrogens were in the first example—beneath the new six-membered ring—and the hydrogens end up above. It may seem puzzling at first that a *trans,trans*-diene gives a product with the two phenyls *cis*. Another way to look at these two reactions is to consider their symmetry. Both have a plane of symmetry throughout and the products must have this symmetry too because the reaction is concerted and no significant movement of substituents can occur. The orange dotted line shows the plane of symmetry, which is at right angles to the paper.

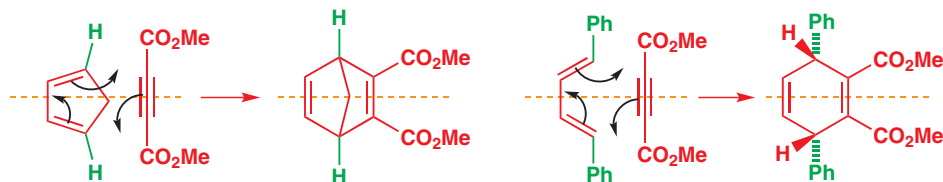

The remaining case—the *cis,trans*-diene—is rarer than the first two, but is met sometimes. This unsymmetrical diene means the two substituents clearly end up on opposite sides of the new six-membered ring.

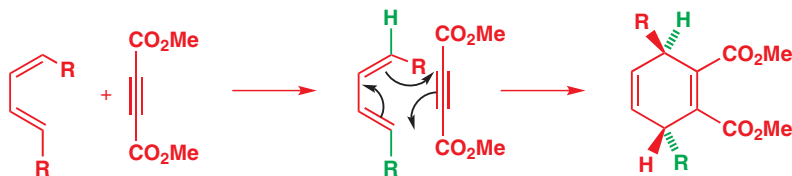

The red R group may seem to get in the way of the reaction but, of course, the dienophile is not approaching in the plane of the diene but from underneath. It is difficult to find a convincing example of this stereochemistry as there are so few known, partly because of the difficulty of making *E,Z* dienes. One good approach uses two reactions you met in Chapter 29 for the control of double-bond geometry. The *cis* double bond is put in first by the addition of methanol to butadiyne and the *trans* double bond then comes from LiAlH_4 reduction of the intermediate acetylenic alcohol.

➡ The mechanism for these reactions is given on pp. 682 and 684.

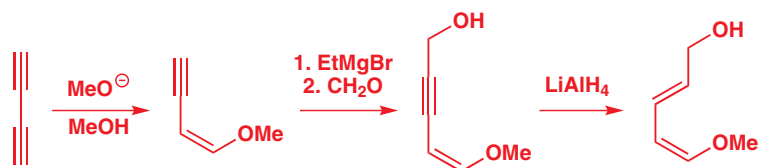

➡ DEAD is a key component of the Mitsunobu reaction: see p. 349.

The acetate of this alcohol is used in a Diels–Alder reaction with the interesting dienophile DEAD (diethyl azodicarboxylate—in orange). The product is formed in excellent yield and has the *trans* stereochemistry that was predicted. The amide nitrogen atoms are planar, so there is no question of stereochemistry there. DEAD itself can equilibrate rapidly between *E* and *Z* isomers, but the *E* predominates.

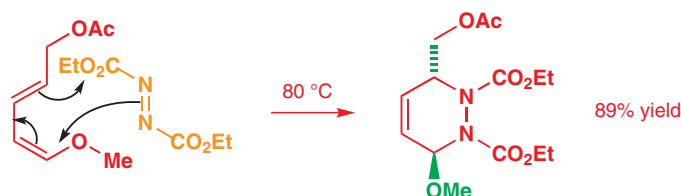

Now to the most interesting cases of all, when both the diene and the dienophile have stereochemistry.

The *endo* rule for the Diels–Alder reaction

It is probably easier to see this when both the diene and the dienophile are cyclic. All the double bonds are *cis* and the stereochemistry is clearer. In the most famous Diels–Alder reaction of all time, that between cyclopentadiene and maleic anhydride, there are two possible products that obey all the rules we have so far described. They are the only possible diastereoisomers of the product—although it has four stereogenic centres, any other diastereoisomers would be impossibly strained.

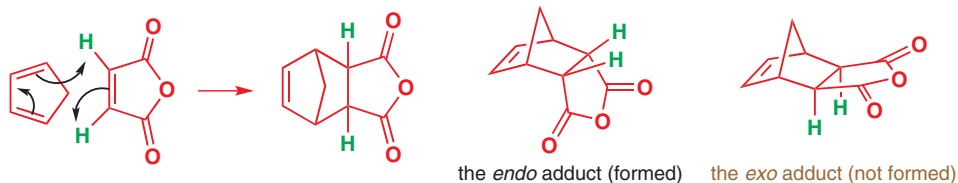

The two green hydrogen atoms must be *cis* in the product, but now there are two such compounds, known as the *exo* and *endo* products. When the reaction is carried out, the product is, in fact, the *endo* compound. Only one diastereoisomer is formed, and it is the less stable one. How do we know this? Well, for cases in which the Diels–Alder reaction is reversible and therefore under thermodynamic control, the *exo* product is formed instead. The best known example results from the replacement of cyclopentadiene with furan in reaction with the same dienophile.

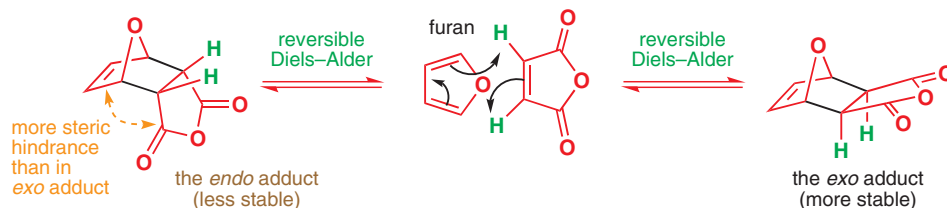

Why is the *exo* product the more stable? Look again at these two structures. On the left-hand side of the molecules, there are two bridges across the ends of the new bonds (highlighted in black): a one-C-atom bridge and a two-C-atom bridge. There is less steric hindrance if the smaller (that is, the one-atom) bridge eclipses the anhydride ring.

The *endo* product is less stable than the *exo* product and yet it is preferred in irreversible Diels–Alder reactions—it must be the kinetic product of the reaction. It forms faster because

■ These names arise from the relationship in space between the carbonyl groups on the dienophile and the newly formed double bond in the middle of the old diene. If these are on the same side they are called *endo* (inside) and if they are on opposite sides they are called *exo* (outside).

➡ Kinetic and thermodynamic control are discussed in Chapter 12, and you met Diels–Alder reactions with heterocycles in Chapter 30, p. 739.

a bonding interaction between the electron-deficient carbonyl groups of the dienophile and the developing π bond at the back of the diene lowers the energy of the transition state, leading to the *endo* product.

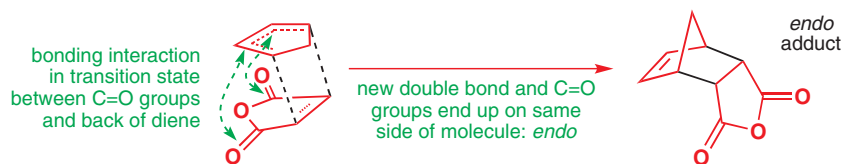

Interactive explanation of *endo* selectivity

The same result is found with acyclic dienes and dienophiles. Normally one diastereoisomer is preferred—the one with the carbonyl groups of the dienophile closest to the developing π bond at the back of the diene. Here is an example.

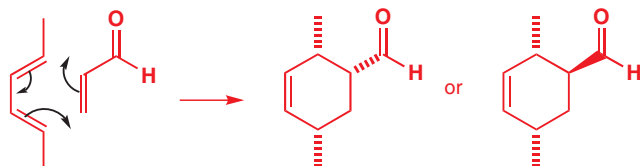

From our previous discussion (it's a *trans,trans* diene) we expect the two methyl groups to be *cis* to each other and the only question remaining is the stereochemistry of the aldehyde group—up or down? The aldehyde will be *endo*—but which compound is that? The easiest way to find the answer is to draw the reagents coming together in three dimensions. Here is one way to do this.

1. Draw the mechanism of the reaction and diagrams of the product to show what you are trying to decide. Put in the known stereochemistry if you wish. This we have just done (see above).
2. Draw both molecules in the plane of the paper with the diene on top and the carbonyl group of the dienophile tucked under the diene so it can be close to the developing π -bond.
3. Now draw in all the hydrogen atoms on the carbon atoms that are going to become stereogenic centres, that is, those shown in green here.
4. Draw a diagram of the product. Unfold the molecule to show the six-membered ring. All the substituents to the right in the previous diagram are on one side of the new molecule. That is, all the green hydrogen atoms are *cis* to each other.
5. Draw a final diagram of the product with the stereochemistry of the other substituents shown too in the usual way. This is the *endo* product of the Diels–Alder reaction.

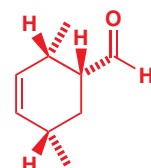
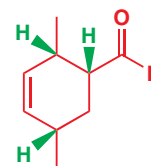
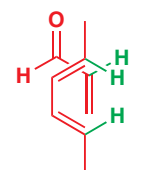
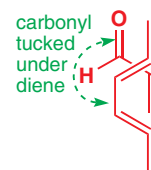

Time for some explanations

We have accumulated rather a lot of unexplained results.

- Why does the Diels–Alder reaction work so well?
- Why must we have a conjugating group on the dienophile?
- Why is the stereochemistry of each component retained so faithfully?
- Why is the *endo* product preferred kinetically?

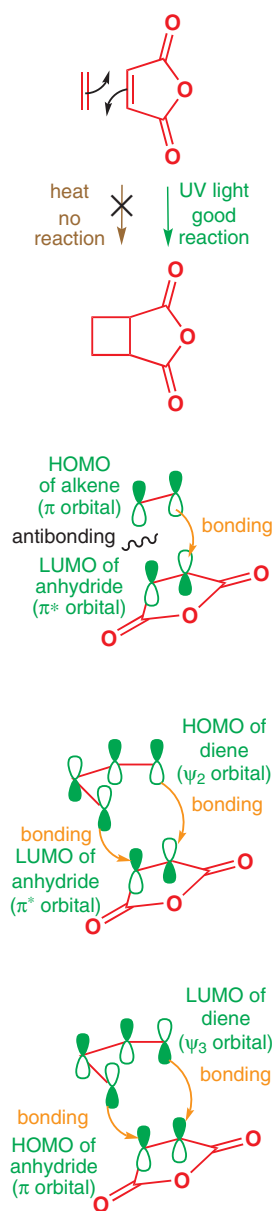

■ You may need to remind yourself about the orbitals of conjugated π systems by re-reading Chapter 7.

There is more. The simpler picture we met earlier in this chapter also fails to explain why the Diels–Alder reaction occurs simply on heating while attempted additions of simple alkenes (rather than dienes) to maleic anhydride fail on heating but succeed under irradiation with UV light.

We shall now explain all this in one section using frontier molecular orbitals. Of all the kinds of organic reactions, pericyclic ones are the most tightly controlled by orbitals, and the development of the ideas we are about to expound is one of the greatest triumphs of modern theoretical chemistry. It is a beautiful and satisfying set of ideas based on very simple principles.

The frontier orbital description of cycloadditions

When an ionic cyclization reaction occurs, such as the lactonization at the head of this chapter, one important new bond is formed. It is enough to combine one full orbital with one empty orbital to make the new bond. But in a cycloaddition two new bonds are formed at the same time. We have to arrange for two filled p orbitals and two empty p orbitals to be available at the right place and with the right symmetry. See what happens if we draw the orbitals for the reaction above. We could try the HOMO (π) of the alkene and the LUMO (π^*) of the double bond in the anhydride (as in the margin). This combination is bonding at one end, but antibonding at the other so that no cycloaddition reaction occurs. It obviously doesn't help to use the other HOMO/LUMO pair, that is the HOMO of the alkene and the LUMO of the alkene, as they will have the same mismatched symmetry.

Now see what happens when we replace the alkene with a diene. We shall again use the LUMO of the electron-poor anhydride. Now the symmetry is right because there is a node in the middle of the HOMO of the diene (the HOMO is ψ_2 of the diene) just as there is in the LUMO of the dienophile.

If we had tried the opposite arrangement, the LUMO of the diene (ψ_3) and the HOMO of the dienophile, the symmetry would again be right. The LUMO of the diene has two nodes and gives the same symmetry as the HOMO of the dienophile, which has no nodes. So either combination is excellent. In fact most Diels–Alder reactions use electron-deficient dienophiles and electron-rich dienes so we prefer the first arrangement. The electron-deficient dienophile has a low-energy LUMO and the electron-rich diene has a high-energy HOMO so this combination gives a better overlap in the transition state. The energy levels will look like this, and the interaction shown in orange is better than the interaction shown in brown because the orbitals are closer in energy.

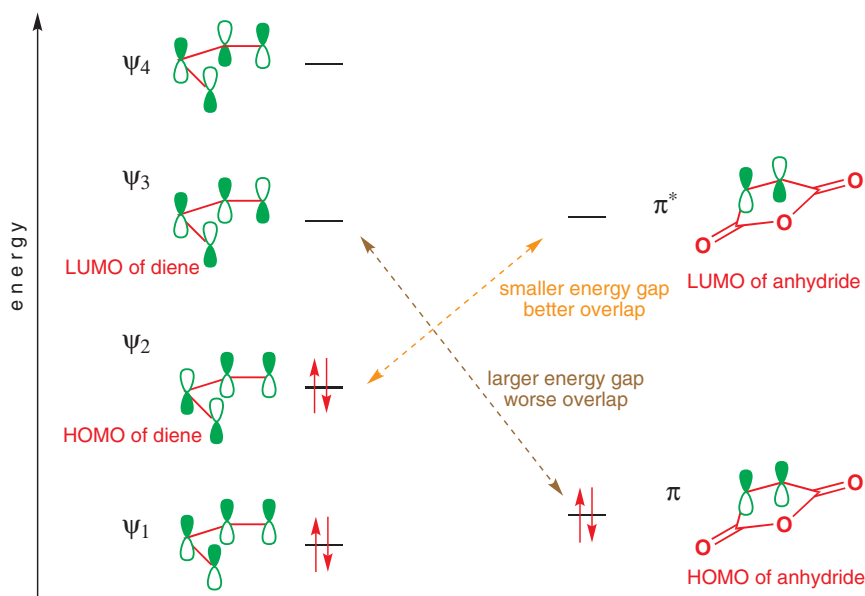

This is why we usually use dienophiles with conjugating groups for good Diels–Alder reactions. Dienes react rapidly with electrophiles because their HOMOs are relatively high in energy, but simple alkenes are not suitable electrophiles because they have relatively high energy LUMOs. The most effective modification we can make is to lower the energy of the alkene's LUMO by conjugating the double bond with an electron-withdrawing group such as carbonyl or nitro. These are the most common type of Diels–Alder reactions—between electron-rich dienes and electron-deficient dienophiles.

Dimerizations of dienes by cycloaddition reactions

Because dienes have relatively high-energy HOMOs and low-energy LUMOs they should be able to take part in cycloadditions with themselves. And indeed, dienes do dimerize, by a Diels–Alder reaction. One molecule of the diene plays the role of the dienophile. The symmetry is correct for the interaction shown, and we call such reactions (like all the Diels–Alder reactions in this chapter) '[4 + 2] cycloadditions'—the numbers referring to the number of atoms of each component taking part in the reaction.

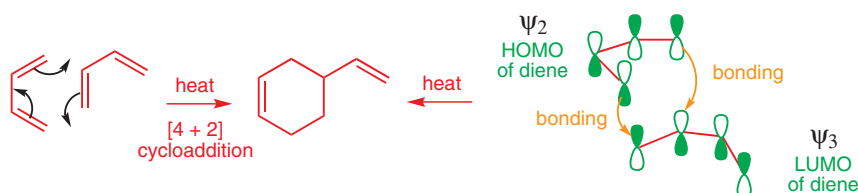

What dienes cannot do is form an eight-membered ring in one step in a [4 + 4] cycloaddition (although this is possible photochemically or with transition metal catalysis, as we shall see later).

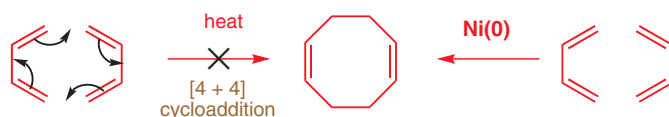

You should have expected this failure because the ends of the required orbitals must again have the wrong symmetry, just as they had when we tried the alkene dimerization.

The orbital explanation for *endo* preference in Diels–Alder reactions

We are going to use a diene dimerization to add more detail to our explanation of the formation of *endo* products. To make matters even easier we shall look at the dimerization of a cyclic diene—we might almost say *the* cyclic diene—cyclopentadiene. We introduced the preference for *endo* products on p. 885 by saying there was a favourable electronic interaction between the conjugating group on the dienophile and the back of the diene.

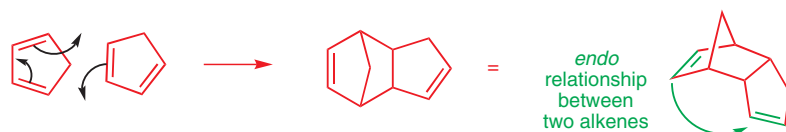

If we now draw the frontier orbitals in the two components as they come together for the reaction, we can see first of all that the symmetry is correct for bond formation (orbitals shown in black). But we can also see what is happening at the back of the diene (orbitals in green). The symmetry of the orbitals is correct for a bonding interaction at the back of the diene too. This interaction does not lead to the formation of any new bonds but it leaves its imprint in the stereochemistry of the product. The *endo* product is favoured because of this bonding interaction across the space between the orbitals.

A rarer type is the **reverse electron demand Diels–Alder reaction** in which the dienophile has electron-donating groups and the diene has a conjugated electron-withdrawing group. These reactions use the HOMO of the dienophile and the LUMO of the diene. This combination still has the right orbital symmetry.

■ The same features of dienes allow them to react with both electrophiles and nucleophiles: see p. 148.

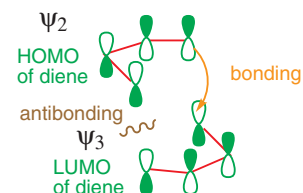

Interactive orbital explanation for *endo* preference in Diels–Alder reactions

orbital interactions leading to new bonds

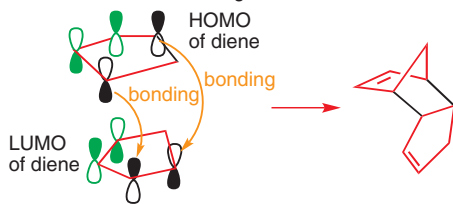

orbital interactions favouring *endo* product

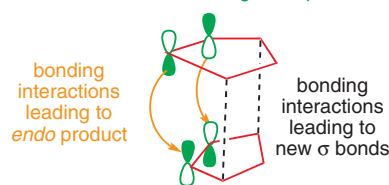

The solvent in the Diels–Alder reaction

We discussed some effects of varying the solvent in Chapter 12, and we shall now introduce a remarkable and useful special solvent effect in the Diels–Alder reaction. The reaction does not *need* a solvent and often the two reagents are just mixed together and heated. Solvents can be used but, because there are no ionic intermediates, it seems obvious that *which* solvent is unimportant—any solvent that simply dissolves both reagents will do. This is, in general, true and hydrocarbon solvents are often the best.

However, in the 1980s an extraordinary discovery was made. Water, a most unlikely solvent for most organic reactions, has a large accelerating effect on the Diels–Alder reaction. Even some water added to an organic solvent accelerates the reaction. And that is not all. The *endo* selectivity of these reactions is often superior to those in no solvent or in a hydrocarbon solvent. Here is a simple example.

Solvent	Relative rate	<i>endo</i> : <i>exo</i> ratio
hydrocarbon (isooctane)	1	80:20
water	700	96:4

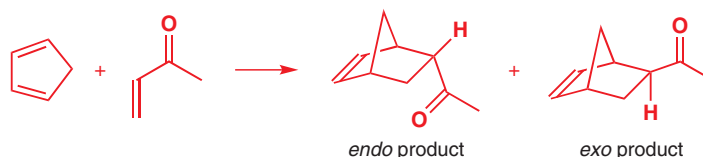

The suggestion is that the reagents, which are not soluble in water, are clumped together in oily drops by the water and forced into close proximity. Water is not exactly a solvent—it is almost an anti-solvent! Reactions like this are sometimes called reactions ‘on water’ rather than reactions ‘in water’.

Intramolecular Diels–Alder reactions

When the diene and the dienophile are already part of the same molecule it is not so important for them to be held together by bonding interactions across space and the *exo* product is often preferred. Indeed, many intramolecular Diels–Alder reactions are governed more by normal steric considerations than by the *endo* rule.

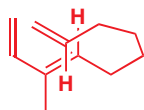
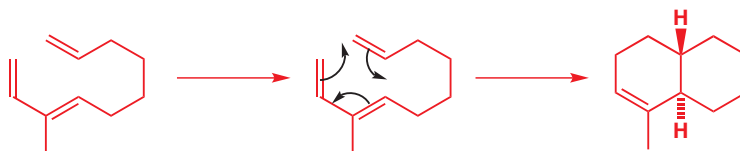

■ If you think about the way a Diels–Alder reaction goes, the forming ring must *always* adopt a boat-like conformation. This is clear if you make a model.

This reaction happens only because it is intramolecular. There is no conjugating group attached to the dienophile and so there are no orbitals to overlap with the back of the diene. The molecule simply folds up in the sterically most favourable way (as shown in the margin, with the linking chain adopting a chair-like conformation) and this leads to the *trans* ring junction. You can see this easily in the arrangement of the hydrogen atoms.

In the next example there is a carbonyl group conjugated with the dienophile. Now the less stable *cis* ring junction is formed because the molecule can fold so that the carbonyl group can enjoy a bonding overlap with the back of the diene. This time the linking chain has to adopt a boat-like conformation.

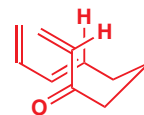
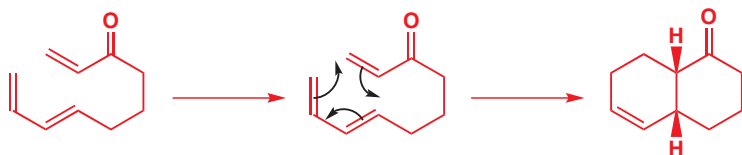

● Intramolecular Diels–Alder

Intramolecular Diels–Alder reactions may give the *endo* product or they may not! Be prepared for either *exo* or *endo* products or a mixture.

Regioselectivity in Diels–Alder reactions

The compounds that we are now calling dienophiles were the stars of Chapters 22 and 25, where we called them **Michael acceptors** as they were the electrophilic partners in conjugate addition reactions. Nucleophiles always add to the β carbon atoms of these alkenes because the product is then a stable enolate. Ordinary alkenes do not react with nucleophiles.

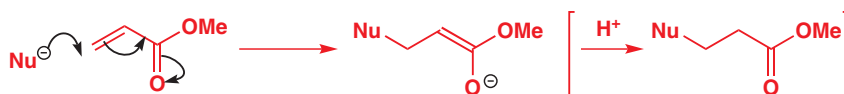

In frontier orbital terms this is because conjugation with a carbonyl group lowers the energy of the LUMO (the π^* orbital of the alkene) and at the same time distorts it so that the coefficient on the β carbon atom is larger than that on the α carbon atom. Nucleophiles approach the conjugated alkene along the axis of the large p orbital of the β carbon atom.

These same features can ensure regioselective Diels–Alder reactions. The same orbital of the dienophile is involved and, if the HOMO of the diene is also unsymmetrical, the regioselectivity of the reaction will be controlled by the two largest coefficients bonding together.

So what about distortion of the HOMO in the diene? If a diene reacts with an electrophile, the largest coefficient in the HOMO will direct the reaction. Consider the attack of HBr on a diene. We should expect attack at the ends of the diene because that gives the most stable cation—an allyl cation as an intermediate.

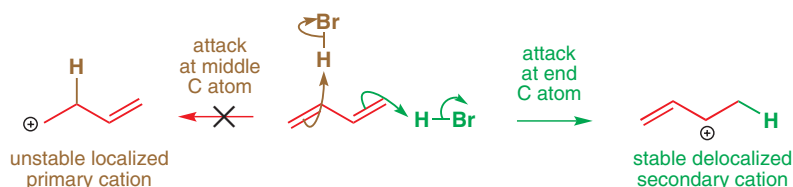

In orbital terms attack occurs at the ends of the diene because the coefficients in the HOMO are larger there. We need simply to look at the HOMO (ψ_2) of butadiene, shown in the margin, to see this. So it is not surprising that the dienes react in the Diels–Alder reaction through their end carbons. But supposing the two ends are different—which reacts now? We can again turn to the reaction with HBr as a guide. Addition of HBr to an unsymmetrical diene will give the more stable of the two possible allyl cations as the intermediate.

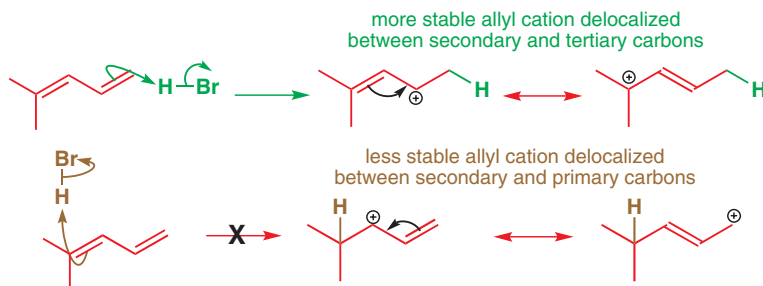

➔ This is discussed in Chapter 22.



- high energy
- coefficients of same size



- lower energy
- unequal coefficients

HOMO of butadiene



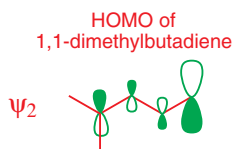

■ It is not 'cheating' to use the regioselectivity of chemical reactions to tell us about the coefficients in orbitals. Chemistry is about using experimental evidence to find out about the theoretical background and not about theory telling us what *ought* to happen. In fact, computational chemists have calculated the HOMO energies and coefficients of unsymmetrical dienes and have reached the same conclusions.

Interactive explanation of regioselectivity in Diels–Alder reactions

In orbital terms, this must mean that the HOMO of the diene is distorted so that the end that reacts has the larger coefficient. When the unsymmetrical diene and the unsymmetrical dienophile combine in a Diels–Alder reaction, the reaction itself becomes unsymmetrical. It remains concerted but, in the transition state, bond formation between the largest coefficients in each partner is more advanced and this determines the regioselectivity of the reaction.

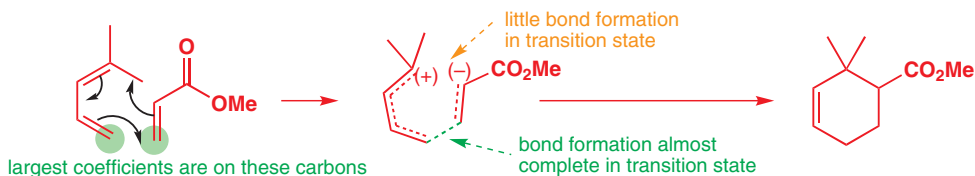

The simplest way to decide which product will be formed is to draw an 'ionic' stepwise mechanism for the reaction to establish which end of the diene will react with which end of the dienophile. Of course this stepwise mechanism is not completely correct but it does lead to the correct orientation of the reagents and you can draw the right mechanism afterwards. As an example, try a diene with a substituent in the middle. This is the reaction:

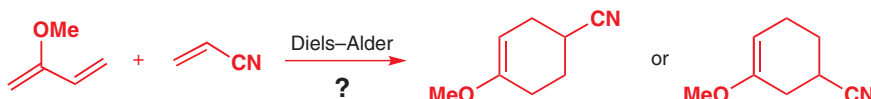

First decide where the diene will act as a nucleophile and where the dienophile will act as an electrophile. This indicates where the largest coefficients of the HOMO and LUMO must lie. The two circles represent those largest coefficients.



Now draw the reagents in the correct orientation for these two ends to combine and draw a concerted Diels–Alder reaction.

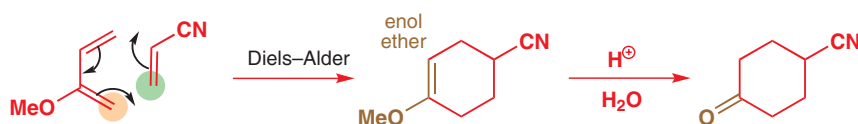

This is an important example because an enol ether functional group is present in the product, which can be hydrolysed to a ketone in aqueous acid (Chapter 20).

Summary of regioselectivity in Diels–Alder reactions

The important substitution patterns are a diene with an electron-donating group (X) at one end or in the middle and a dienophile with an electron-withdrawing group (Z) at one end. These are the products formed.

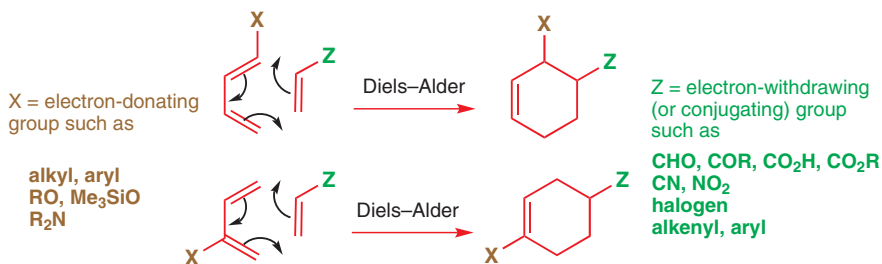

● **A useful mnemonic**

If you prefer a rule to remember, try this one.

- The Diels–Alder reaction is a cycloaddition with an aromatic transition state that is *ortho* and *para* directing.

You can see that this mnemonic works if you look at the two products above: the first has the two substituents X and Z on neighbouring carbon atoms, just like *ortho* substituents on a benzene ring, while the second has 1,4-related X and Z just like *para* substituents. The connection with aromaticity (the ‘aromatic transition state’) simply means that the transition state is cyclic and has six electrons. We have not yet explored the consequences of this, but we will do shortly.

Lewis acid catalysis in Diels–Alder reactions

Where the reagents are unsymmetrical, a Lewis acid that can bind to the electron-withdrawing group of the dienophile often catalyses the reaction by lowering the LUMO of the dienophile still further. It has another important advantage: it increases the difference between the coefficients in the LUMO (a Lewis-acid complexed carbonyl group is a more powerful electron-withdrawing group) and may therefore increase regioselectivity.

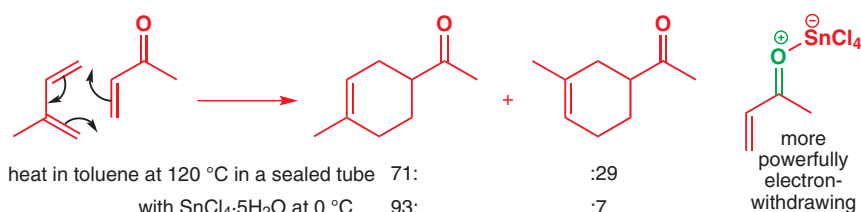

This Diels–Alder reaction is useful because it produces a substitution pattern (*para*) common in natural terpenes (see Chapter 42). But the regioselectivity introduced by one methyl group on the diene is not very great—this reaction gives a 71:29 mixture when the two compounds are heated together at 120°C in a sealed tube. In the presence of the Lewis acid (SnCl₄) the reaction can be carried out at lower temperatures (below 25°C) without a sealed tube and the regioselectivity improves to 93:7.

Regioselectivity in intramolecular Diels–Alder reactions

Just as the stereoselectivity may be compromised in intramolecular reactions, so may the regioselectivity. It may be simply impossible for the reagents to get together in the ‘right’ orientation. The examples below have a very short chain—just three carbon atoms—joining diene to dienophile and so the same regioselectivity is found regardless of the position of the conjugating carbonyl group.

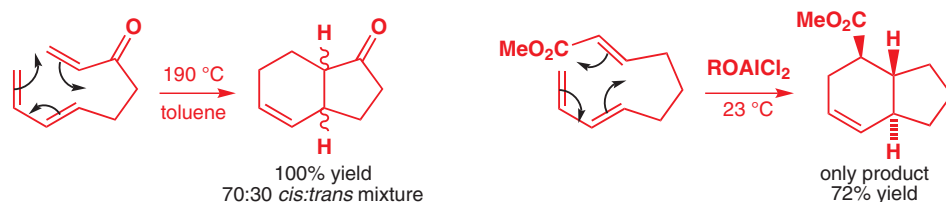

The first example has the ‘right’ orientation (*ortho*) but the second has the ‘wrong’ orientation (*meta*). The short tether entails no prospect of any other orientation and, as the reaction is intramolecular, it goes anyway. Notice the lower temperature required for the Lewis acid (ROAlCl₂) catalysed reaction.

The Woodward–Hoffmann description of the Diels–Alder reaction

Kenichi Fukui and Roald Hoffmann won the Nobel prize in 1981 (Woodward died in 1979 and so couldn't share this prize: he had already won a Nobel prize in 1965 for his work on synthesis) for the application of orbital symmetry to pericyclic reactions. There is an alternative description to the frontier orbital method we have used and you need to know a little about it. They started by considering a more fundamental correlation between the symmetry of all the orbitals in the starting materials and all the orbitals in the products. This is rather too complex for us to cover here, and we shall concentrate only on a summary of the conclusions—the **Woodward–Hoffmann rules**. The most important of these states:

● **Woodward–Hoffmann rules**

In a thermal pericyclic reaction the total number of $(4q + 2)_s$ and $(4r)_a$ components must be odd.

This needs some explanation. A component is a bond or orbital taking part in a pericyclic reaction as a single unit. A double bond is a π_2 component. The number 2 is the most important part of this designation and simply refers to the number of electrons. The prefix π tells us the type of electrons. A component may have any number of electrons (a diene is a π_4 component) but may not have mixtures of π and σ electrons. Now look back at the rule. Those designations $(4q + 2)$ and $(4r)$ simply refer to the number of electrons in the component where q and r are integers. An alkene is a π_2 component and so it is of the $(4q + 2)$ kind while a diene is a π_4 component and so is of the $(4r)$ kind. You have already seen the importance of $4n + 2$ numbers in aromaticity; here the significance is closely related.

Now what about the suffixes 's' and 'a'? The suffix 's' stands for suprafacial and 'a' for antarafacial. A **suprafacial** component forms new bonds on the same face at both ends while an **antarafacial** component forms new bonds on opposite faces at both ends. If you find it easier to understand, you can think of the Woodward–Hoffmann rules like this:

● **Woodward–Hoffmann rules: alternative version**

In an allowed thermal pericyclic reaction this sum:

$$\begin{aligned} & \text{number of suprafacial components with 2, 6, or 10 electrons} \\ + & \text{ number of antarafacial components with 0, 4, or 8 electrons} \\ = & \text{ an odd number} \end{aligned}$$

It's the number of relevant **components** that must be odd, not (obviously) the number of electrons, and you must ignore any components which aren't mentioned in the sum (for example you can have as many suprafacial components with four electrons as you like—they just don't count).

See how this works for the Diels–Alder reaction. Here is the routine.

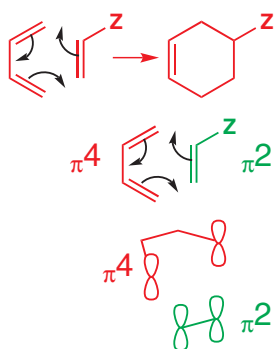

1. Draw the mechanism for the reaction (we shall choose a general one).

2. Choose the components. All the bonds taking part in the mechanism must be included and no others.

3. Make a three-dimensional drawing of the way the components come together for the reaction, putting in orbitals at the ends of the components (only!). The orbitals are just unshaded p orbitals, and do not make up HOMOs or LUMOs nor any particular molecular orbital. Don't attempt to mix frontier orbital and Woodward–Hoffmann descriptions of pericyclic reactions.

- Join up the components where new bonds are to be formed. Coloured dotted lines are often used.
- Label each component 's' or 'a' depending on whether new bonds are formed on the same or on opposite sides. In all of the cycloadditions you have seen so far (and indeed the vast majority of those you will ever see), both components react suprafacially.
- Count the number of $(4q + 2)_s$ and $(4r)_a$ components. If the total count is odd, the reaction is allowed. In this case, **there is one $(4q + 2)_s$ component (the alkene) and no $(4r)_a$ components. Total = 1 so it is an allowed reaction.** Components of the other symmetry, that is $(4q + 2)_a$ and $(4r)_s$ components, do not count. You can have as many of these as you want.

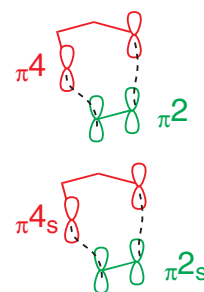

You may well feel that there is very little to be gained from the Woodward–Hoffmann treatment of the Diels–Alder reaction. It does not explain the *endo* selectivity nor the regioselectivity. However, the Woodward–Hoffmann treatment of other pericyclic reactions (particularly electrocyclic reactions, in the next chapter) is very helpful.

Trapping reactive intermediates by cycloadditions

In Chapter 22 you met the remarkable intermediate benzyne. Convincing evidence for the existence of this implausible structure is provided by the fact that it can be trapped in a Diels–Alder reaction. One way of generating benzyne for this purpose is the diazotization of anthranilic acid (2-aminobenzoic acid).

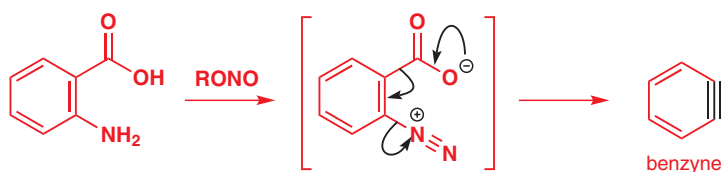

Benzyne may not look like a good dienophile but it is an unstable electrophilic molecule so it must have a low-energy LUMO (π^* of the triple bond). If benzyne is generated in the presence of a diene, efficient Diels–Alder reactions take place. Anthracene gives a specially interesting product with a symmetrical cage structure.

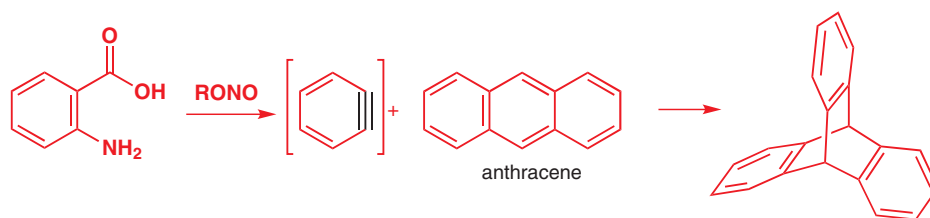

It is difficult to draw this mechanism convincingly. The two flat molecules approach each other in orthogonal planes, so that the (orbitals) of the localized π bond of benzyne interact with the p orbitals on the central ring of anthracene.

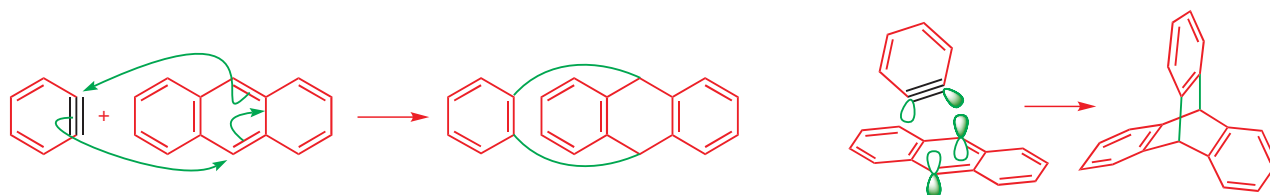

■ It also explains why the $[4 + 4]$ cycloaddition on p. 887 and the $[2 + 2]$ cycloaddition on p. 886 fail: draw out the reactions and you find there are *no* $(4q + 2)_s$ and $(4r)_a$ components—and you must have an *odd* number for a successful reaction.

Another intermediate for which a cycloaddition product provides convincing evidence is the oxyallyl cation. This compound can be made from α,α' -dibromoketones on treatment with zinc metal. The first step is the formation of a zinc enolate (compare the Reformatsky reaction), which can be drawn in terms of the attack of zinc on oxygen or bromine. Now the other bromine can leave as an anion. It could not do so before because it was next to an electron-withdrawing carbonyl group. Now it is next to an electron-rich enolate so the cation is stabilized by conjugation.

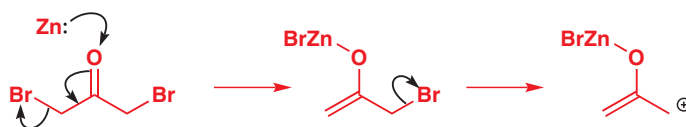

The allyl cation has three atoms but only two electrons so it can take part in cycloadditions with dienes—the total number of electrons is six, just as in the Diels–Alder reaction. This is a [4 + 3] all-suprafacial cycloaddition.

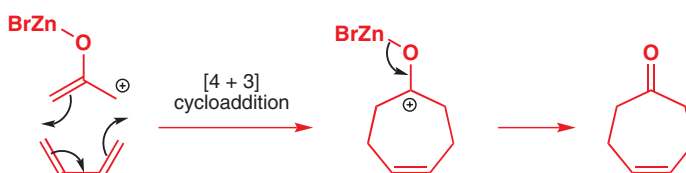

Interactive mechanism for [4 + 3] cycloaddition

Remember, the numbers in the brackets, [4 + 2] etc., refer to number of *atoms*. The numbers $(4q + 2)_s$ and $(4r)_a$ in the Woodward–Hoffmann rules refer to the numbers of *electrons*. The [4 + 3] cycloaddition here still involves a π_4 and a π_2 component (i.e. it has one $(4q + 2)_s$ component and no $(4r)_a$ components, and is allowed).

Other thermal cycloadditions

A simple consequence of the Woodward–Hoffmann rules is that cycloadditions involving a total $(4n + 2)$ electrons, if they are all suprafacial, are always allowed: they must always involve an odd number of $(4q + 2)_s$ components. Such reactions are often referred to as having ‘aromatic transition states’ because of the obvious link with the aromatic requirement for $(4n + 2)$ electrons. Six is the most common $(4n + 2)$ number, but there are also a few cycloadditions involving ten electrons. These are mostly diene + triene, that is, $\pi_4 + \pi_6$ cycloadditions. Here are a couple of examples.

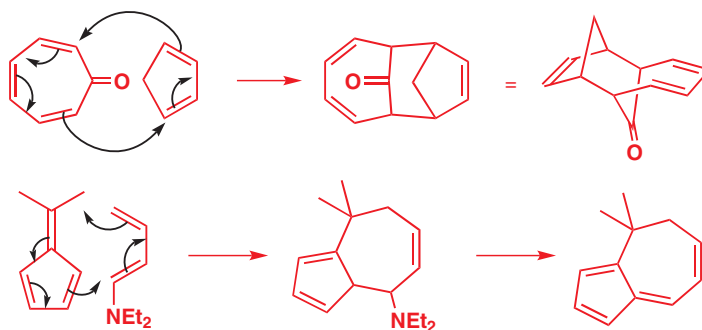

Interactive mechanism for [4 + 6] cycloaddition

In the first case, there is an *endo* relationship between the carbonyl group and the back of the diene—this product is formed in 100% yield. In the second case Et_2NH is lost from the first product under the reaction conditions to give the hydrocarbon shown. This type of reaction is more of an oddity: by far the most important type of cycloaddition is the Diels–Alder reaction.

The Alder ‘ene’ reaction

The Diels–Alder reaction was originally called the ‘diene reaction’ so, when half of the famous team (Kurt Alder) discovered an analogous reaction that requires only one alkene, it was called the **Alder ene reaction** and the name has stuck. Compare here the Diels–Alder and the Alder ene reactions.

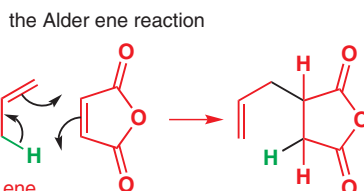
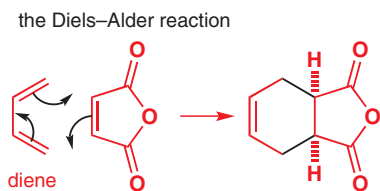

The simplest way to look at the ene reaction is to picture it as a Diels–Alder reaction in which one of the double bonds in the diene has been replaced by a C–H bond (green). The reaction does not form a new ring, the product has only one new C–C bond (shown in black on the product), and a hydrogen atom is transferred across space. Otherwise, the two reactions are remarkably similar.

The ene reaction is rather different in orbital terms. For the Woodward–Hoffmann description of the reaction we must use the two electrons of the C–H bond to replace the two electrons of the double bond in the Diels–Alder reaction, but we must make sure that all the orbitals are parallel, as shown.

The C–H bond is parallel with the p orbitals of the ene so that the orbitals that overlap to form the new π bond are already parallel. The two molecules approach one another in parallel planes so that the orbitals that overlap to form the new σ bonds are already pointing towards each other. Because the electrons are of two types, π and σ , we must divide the ene into two components, one π^2 and one σ^2 . We can then have an all-suprafacial reaction with three components.

All three components are of the $(4q + 2)$, type so all count and the total is three—an odd number—so the reaction is allowed. We have skipped the step-by-step approach we used for the Diels–Alder reaction because the two are so similar, but you should convince yourself that you can apply it here.

Now for some real examples. Most ene reactions with simple alkenes are with maleic anhydride. Other dienophiles—or enophiles as we should call them in this context—do not work very well. However, with one particular alkene, the natural pine tree terpene β -pinene, a reaction does occur with enophiles such as acrylates.

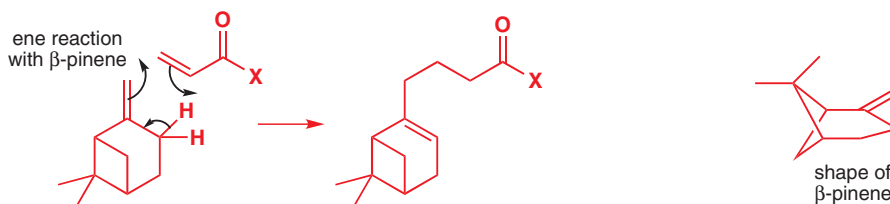

The major interaction between these two molecules is between the nucleophilic end of the exocyclic alkene and the electrophilic end of the acrylate. These atoms have the largest coefficients in the HOMO and LUMO, respectively, and, in the transition state, bond formation between these two will be more advanced than anywhere else. For most ordinary alkenes and enophiles, Lewis acid catalysis to make the enophile more electrophilic, or an intramolecular reaction (or both!), is necessary for an efficient ene reaction.

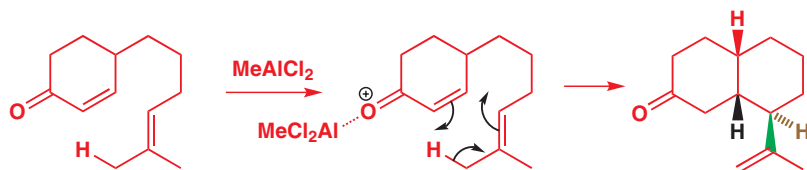

The 'ene' component is delivered to the bottom face of the enone, as its tether is too short for it to reach the top face, and a *cis* ring junction is formed. The stereochemistry of the third centre is most easily seen by a Newman projection (Chapter 16) of the reaction. In the diagram in the margin we are looking straight down the new C–C bond and the colour coding should help you to see how the stereochemistry follows.

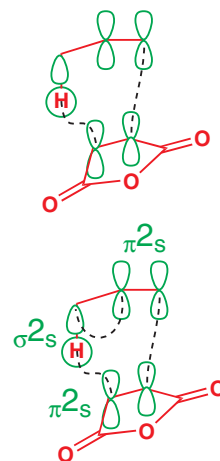

■ We discuss in more detail in Chapter 35 how to assign *s* or a with σ bonds. Here the σ bond reacts suprafacially because the 1s orbital of H has no nodes.

■ We looked at using tethers to constrain the formation of a single diastereoisomer in Chapter 32, p. 847.

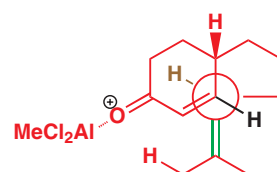

the carbonyl ene reaction

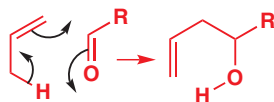

Since the twin roles of the enophile are to be attacked at one end by a C=C double bond and at the other by a proton, a carbonyl group is actually a very good enophile. These reactions are usually called ‘carbonyl ene’ reactions.

The important interaction is between the HOMO of the ene system and the LUMO of the carbonyl group—and a Lewis-acid catalyst can lower the energy of the LUMO still further. If there is a choice, the more electrophilic carbonyl group (the one with the lower LUMO) reacts.

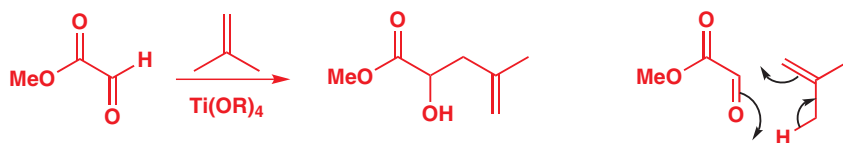

It may not be obvious that an ene reaction has occurred because of the symmetry of the alkene. The double bond in the product is not, in fact, in the same place as it was in the starting material, as the mechanism shows.

One carbonyl ene reaction is of commercial importance as it is part of a process for the production of menthol used to give a peppermint smell and taste to many products. This is an intramolecular ene reaction on another terpene derivative.

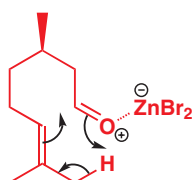
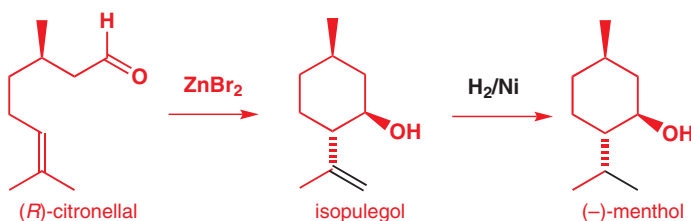

It is not obvious what has happened in the first step, but the movement of the alkene and the closure of the ring with the formation of one (not two) new C–C bonds should give you the clue that this is a Lewis-acid-catalysed carbonyl ene reaction.

The stereochemistry comes from an all-chair arrangement in the conformation of the transition state. The methyl group will adopt an equatorial position in this conformation, fixing the way the other bonds are formed. Again, colour coding should make it clearer what has happened.

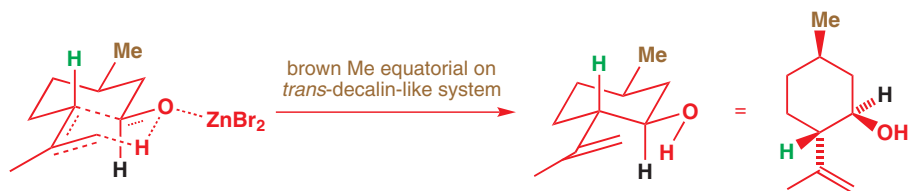

 Interactive mechanism for the intramolecular carbonyl ene reaction

Allowed reactions

Because a reaction is ‘allowed’ doesn’t mean that it will happen. It just means it is theoretically possible. In the same way you might be ‘allowed’ to jump off a three metre wall, but you wouldn’t do it.

Menthol manufacture

It may seem odd to you to have a chemical process to produce menthol, which would be available naturally from mint plants. This process is now responsible for much of the world’s menthol production so it must make some sort of sense! The truth is that menthol *cultivation* is wasteful in good land that could produce food crops such as rice while the starting material for menthol *manufacture* is the same β -pinene we have just met. This is available in large quantities from pine trees grown on poor land for paper and furniture. The earlier stages of the process are discussed in Chapter 41.

Photochemical [2 + 2] cycloadditions

We shall now leave six-electron cycloadditions such as the Diels–Alder and ene reactions and move on to some four-electron cycloadditions. Clearly, four is not a $(4n + 2)$ number, but when we described the Woodward–Hoffman rules on p. 892 we used the term ‘thermally’. All

suprafacial cycloadditions with $4n$ electrons *are* allowed if the reaction is not thermal (that is, driven by heat energy) but **photochemical** (that is, driven by light energy). Under photochemical conditions, the rules switch such that all the cycloadditions that are not allowed thermally are allowed photochemically. This works because the problem of the incompatible symmetry in trying to add two alkenes together is avoided by converting one of them into the excited state photochemically. First, one electron is excited by the light energy from the π to the π^* orbital.

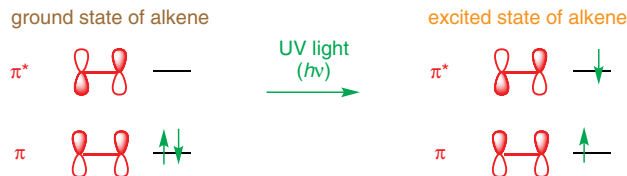

Now, combining the excited state of one alkene with the ground state of another solves the symmetry problem. Mixing the two π orbitals leads to two molecular orbitals, and two electrons go down in energy while only one goes up. Mixing the two π^* orbitals is as good—one electron goes down in energy and none goes up. The result is that three electrons go down in energy and only one goes up. Bonding can occur.

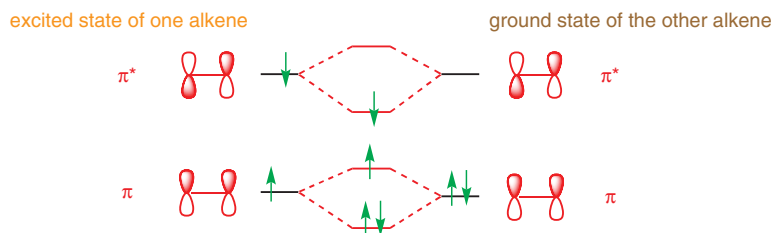

➔ In Chapter 7 we discussed why conjugated systems absorb UV light more readily than do unconjugated ones.

Alkenes can be dimerized photochemically in this way, but reaction between two different alkenes is more interesting. If one alkene is bonded to a conjugating group, it alone will absorb UV light and be excited while the other will remain in the ground state. It is difficult to draw a mechanism for these reactions as we have no simple way to represent the excited alkene. Some people draw it as a diradical (since each electron is in a different orbital); others prefer to write a concerted reaction on an excited alkene marked with an asterisk.

A photochemical [2 + 2] cycloaddition: two ways of writing the mechanism

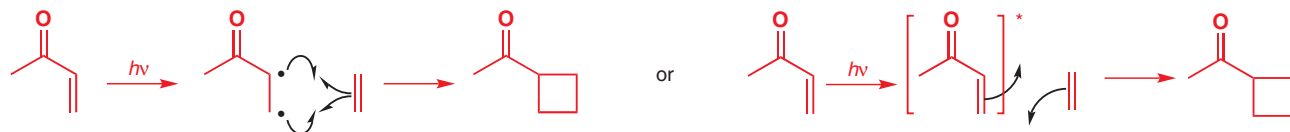

The reaction is stereospecific within each component but there is no *endo* rule—there is a conjugating group but no ‘back of the diene’. The least hindered transition state usually results. The dotted lines on the central diagram simply show the bonds being formed. The two old rings keep out of each other’s way during the reaction and the conformation of the product looks reasonably unhindered.

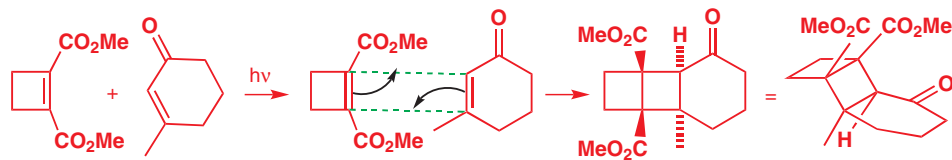

You may be wondering why the reaction works at all, given the strain in a four-membered ring: why doesn’t the product just go back to the two starting materials? This reverse reaction is governed by the Woodward–Hoffmann rules, just like the forward one, and to go back again the four-membered ring products would have to absorb light. But since they have now lost

their π bonds they have no low-lying empty orbitals into which light can promote electrons (see Chapter 7). The reverse photochemical reaction is simply not possible because there is no mechanism for the compounds to absorb light.

Regioselectivity in photochemical [2 + 2] cycloadditions

The observed regioselectivity is shown below. If we had combined the HOMO of the alkene with the LUMO of the enone, as we should in a thermal reaction, we would expect the opposite orientation so as to use the larger coefficients of the frontier orbitals and to maximize cycle stabilization in the transition state.

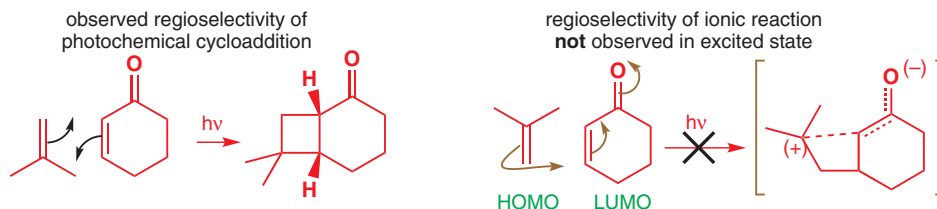

But we are not doing a thermal reaction. If you look back at the orbital diagram on p. 897, you will see that it is the HOMO/HOMO and LUMO/LUMO interactions that now matter in the reactions of the excited state. The sizes of the coefficients in the LUMO of the alkene are the other way round to those in the HOMO. There is one electron in this pair of orbitals—in the LUMO of the enone in fact, as the enone has been excited by the light—so overlap between the two LUMOs (shown in the frame) is bonding and leads to the observed product. The easiest way to work it out quickly is to draw the product you do *not* expect from a normal HOMO/LUMO or curly arrow controlled reaction.

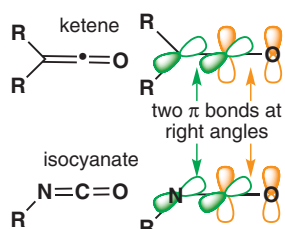
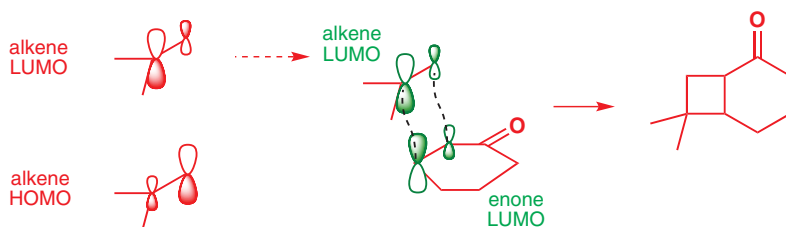

Thermal [2 + 2] cycloadditions

Despite what we have told you about allowed cycloadditions, there *are* some thermal [2 + 2] cycloadditions giving four-membered rings. These feature a simple alkene reacting with an electrophilic alkene of a peculiar type. It must have two double bonds to the *same* carbon atom. The most important examples are ketenes and isocyanates. The structures have two π bonds at right angles.

Here are typical reactions of dimethyl ketene to give a cyclobutanone and chlorosulfonyl isocyanate to give a β -lactam.

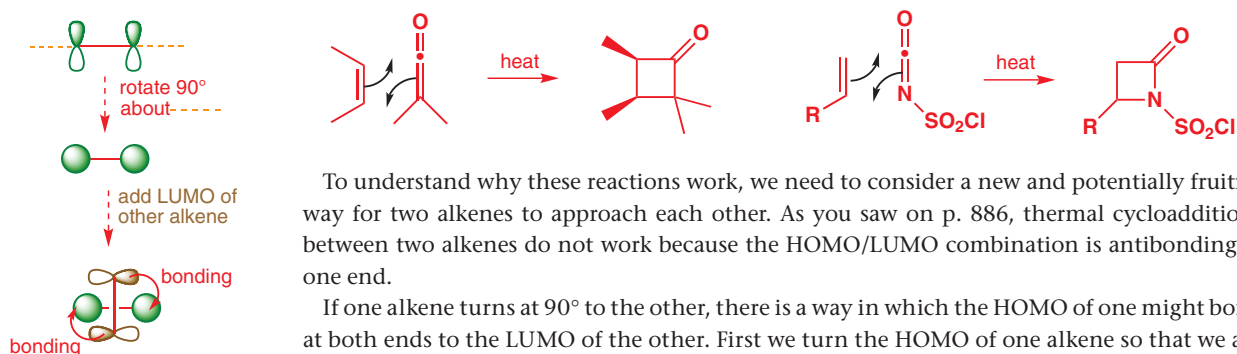

To understand why these reactions work, we need to consider a new and potentially fruitful way for two alkenes to approach each other. As you saw on p. 886, thermal cycloadditions between two alkenes do not work because the HOMO/LUMO combination is antibonding at one end.

If one alkene turns at 90° to the other, there is a way in which the HOMO of one might bond at both ends to the LUMO of the other. First we turn the HOMO of one alkene so that we are

looking down on the p orbitals. Then we add the LUMO of the other alkene on top of this HOMO and at 90° to it so that there is the possibility of bonding overlap at both ends.

This arrangement looks quite promising until we notice that there is antibonding at the other two corners! Overall there is no net bonding. We can tilt the balance in favour of bonding by adding a p orbital to one end of the LUMO and at a right angle to it so that both orbitals of the HOMO can bond to this extra p orbital. There are now four bonding interactions but only two antibonding. The balance is in favour of a reaction. This is also quite difficult to draw!

Ketenes have a central sp carbon atom with an extra π bond (the C=O) at right angles to the first alkene—perfect for thermal [2 + 2] cycloadditions. They are also electrophilic and so have suitable low-energy LUMOs.

Ketene [2 + 2] cycloadditions

Ketene itself is usually made by high-temperature pyrolysis of acetone but some ketenes are easily made in solution. The very acidic proton on dichloroacetyl chloride can be removed even with a tertiary amine and loss of chloride ion then gives dichloroketene in an E1cB elimination reaction. If the elimination is carried out in the presence of cyclopentadiene a very efficient regio- and stereospecific [2 + 2] cycloaddition occurs.

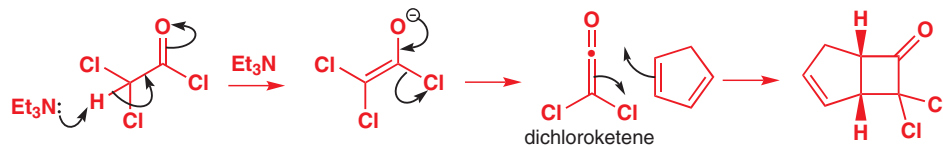

The most nucleophilic atom on the diene adds to the most electrophilic atom on the ketene and the *cis* geometry at the ring junction comes from the *cis* double bond of cyclopentadiene. It is impressive that even this excellent diene undergoes no Diels–Alder reaction with ketene as dienophile. The [2 + 2] cycloaddition must be much faster.

Using the products

Dichloroketene is convenient to use, but the two chlorine atoms are not usually needed in the product. Fortunately, these can be removed by zinc metal in acetic acid solution. Zinc forms a zinc enolate, which is converted into the ketone by the acid. Repetition removes both chlorine atoms. You saw the reductive formation of a zinc enolate earlier in the chapter (p. 894) and in the Reformatsky reaction (Chapter 26, p. 631).

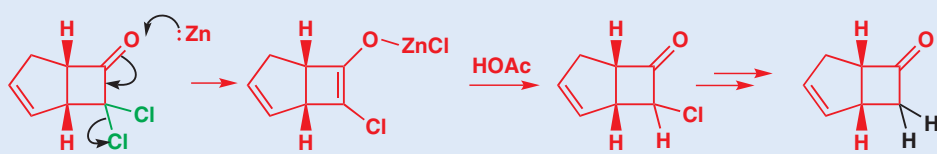

But what do we do if we *want* the product of a ketene [4 + 2] cycloaddition? We must use a compound that is not a ketene but that can be transformed into a ketone afterwards—a **masked ketene** or a **ketene equivalent**. The two most important types are nitroalkenes and compounds such as the ‘cyanohydrin ester’ in the second example.

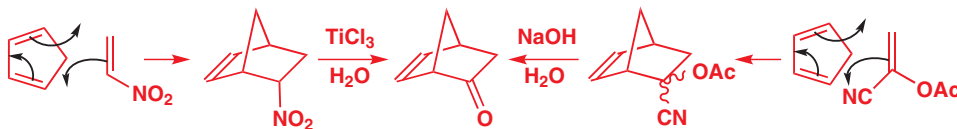

Finding the starting materials for a cyclobutanone synthesis

The disconnection of a four-membered ring is very simple—you just split in half and draw the two alkenes. There may be two ways to do this.

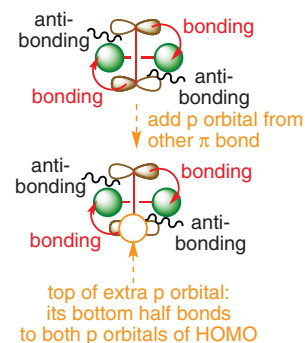

■ If you find the drawing above difficult to understand, try a three-dimensional representation.

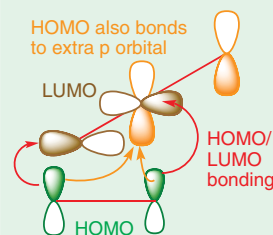

■ The conversion of nitro compounds to ketones by TiCl₃ is an alternative to the Nef reaction that you met in Chapter 26 (p. 631), and you should be able to write a mechanism for the reaction involving NaOH yourself.



Both sets of starting materials look all right—the regiochemistry is correct for the first and doesn't matter for the second. However, we prefer the second because we can control the stereochemistry by using *cis*-butene as the alkene and we can make the reaction work better by using dichloroketene instead of ketene itself, reducing out the chlorine atoms with zinc.

Synthesis of β -lactams by [2 + 2] cycloadditions

Now the disconnections are really different—one requires addition of a ketene to an imine and the other the addition of an isocyanate to an alkene. Isocyanates are like ketenes, but have a nitrogen atom instead of the end carbon atom. Otherwise the orbitals are the same.



And the good news is that both work, providing we have the right substituents on nitrogen. The dichloroacetyl chloride trick works well with imines and, as you ought to expect, the more nucleophilic nitrogen atom attacks the carbonyl group of the ketene so that the regioselectivity is right to make β -lactams.

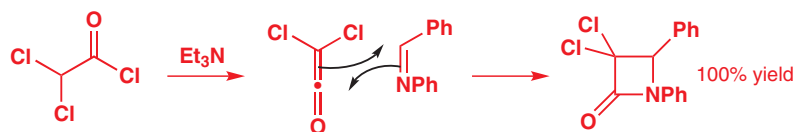

If both components have one substituent, these will end up *trans* on the four-membered ring just to keep out of each other's way. This example has more functionality and the product is used to make β -lactams with antibiotic activity.

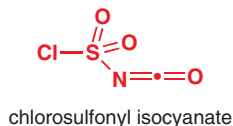
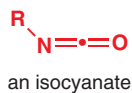
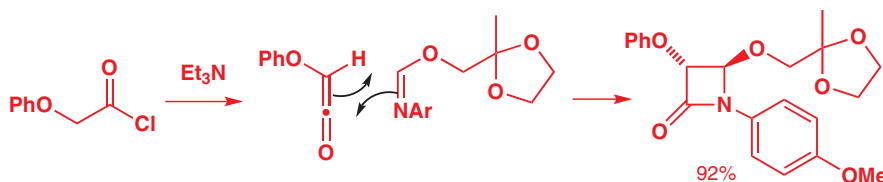

You will notice that in both of these examples there is an aryl substituent on the nitrogen atom of the imine. This is simply because *N*-aryl imines are more stable than their NH analogues (Chapter 11, p. 231).

When we wish to make β -lactams by the alternative addition of an isocyanate to an alkene, a substituent on nitrogen is again required, but for quite a different reason. Because alkenes are only moderately nucleophilic, we need a strongly electron-withdrawing group on the isocyanate that can be removed after the cycloaddition, and the most popular by far is the chlorosulfonyl group. The main reason for its popularity is the commercial availability of chlorosulfonyl isocyanate. It reacts even with simple alkenes.

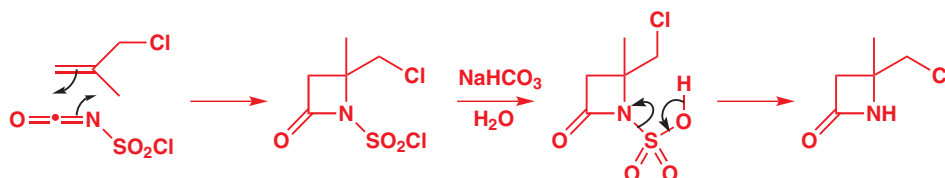

The alkene's HOMO interacts with the isocyanate's LUMO, and the most electrophilic atom is the carbonyl carbon so this is where the terminal carbon atom of the alkene attacks. The chlorosulfonyl group can be removed simply by hydrolysis under mild conditions via the sulfonic acid.

With a more electron-rich alkene—an enol ether, for example, or the following example with its sulfur analogue, a vinyl sulfide—the reaction ceases to be a concerted process and occurs stepwise. We know this must be the case in the next example because, even though the starting material is an *E/Z* mixture, the product has only *trans* stereochemistry: it is stereoselective rather than stereospecific, indicating the presence of an intermediate in which free rotation can take place.

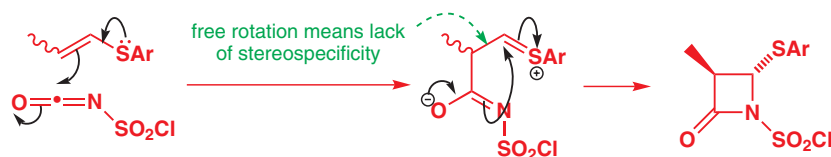

■ The lack of stereospecificity in some non-concerted reactions is discussed in Chapter 38 in relation to carbenes.

Making five-membered rings: 1,3-dipolar cycloadditions

We have seen how to make four-membered rings by [2 + 2] cycloadditions, how to make six-membered rings by [4 + 2] cycloadditions, and an example of making a seven-membered ring by a [4 + 3] cycloaddition. But what about five-membered rings? What we need is a three-atom, four-electron equivalent of a 'diene' and we can do a Diels–Alder reaction. Such molecules exist: they are called 1,3-dipoles and they are good reagents for [3 + 2] cycloadditions. The molecule containing N and O atoms labelled 'four-electron component' is an example. It has a nucleophilic end (O⁻) and an electrophilic end—the end of the double bond next to the central N⁺. These are 1,3-related, so it is indeed a 1,3-dipole.

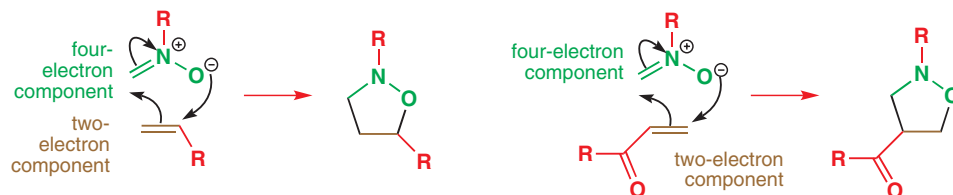

This functional group is known as a nitron. You could think of it as the *N*-oxide of an imine. The nitron gets its four electrons in this way: there are two π electrons in the N=C double bond and the other two come from one of the lone pairs on the oxygen atom. The two-electron component in each of these reactions is an alkene which, in a Diels–Alder reaction, would be called a dienophile. Here it is called a **dipolarophile**. Simple alkenes (which are bad dienophiles) are good dipolarophiles and so are electron-deficient alkenes. The difference between dienes and 1,3-dipoles is that dienes are nucleophilic and prefer to use their HOMO in cycloadditions with electron-deficient dienophiles while 1,3-dipoles, as their name implies, are both electrophilic and nucleophilic. They can use either their HOMO or their LUMO depending on whether the dipolarophile is electron-deficient or electron-rich.

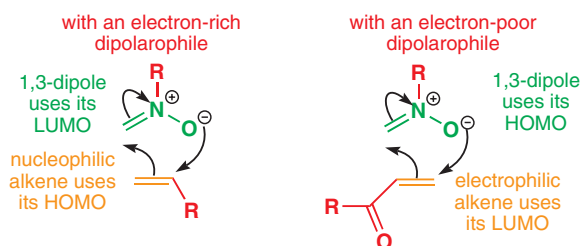

➔ You saw 1,3-dipolar cycloaddition being used to make heterocycles in Chapter 30 (pp. 772–775).

■ The charges make the nitron look like a 1,2-dipole, but nucleophilic attack on N⁺ is impossible.

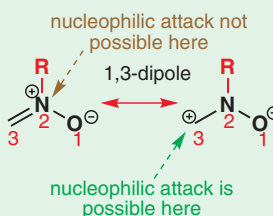

N–O functionality

There are many functional groups containing N–O bonds. Here are a few:

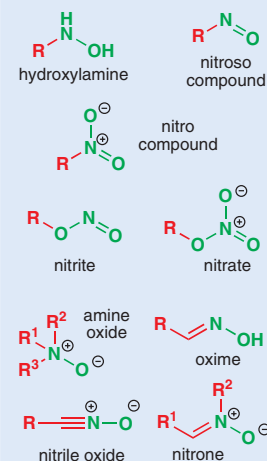

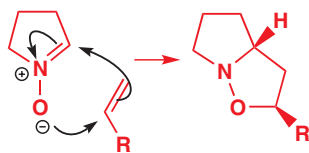

One important nitronium ion is a cyclic compound that has the structure in the margin and adds to dipolarophiles (essentially any alkene) in a [3 + 2] cycloaddition to give two five-membered rings fused together. The stereochemistry comes from the best approach with the least steric hindrance, as shown. There is no *endo* rule in these cycloadditions as there is no conjugating group to interact across space at the back of the dipole or dipolarophile. The product shown here is the more stable *exo* product.

If the alkene is already joined on to the nitronium ion by a covalent bond, the dipolar cycloaddition is an intramolecular reaction, and one particular outcome may be dictated by the impossibility of the alternatives. In the simple case below, the product has a beautifully symmetrical cage structure. The mechanism shows the only way in which the molecule can fold up to allow a 1,3-dipolar cycloaddition to occur.

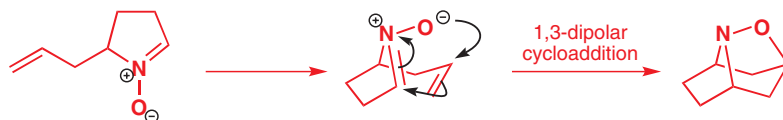

The importance of the Diels–Alder reaction is that it makes six-membered rings with control over stereochemistry. The importance of 1,3-dipolar cycloadditions is not so much in the heterocyclic products but in what can be done with them. Almost always, the first formed heterocyclic ring is broken down in some way by carefully controlled reactions. The nitronium adducts we have just seen contain a weak N–O single bond that can be selectively cleaved by reduction. Reagents such as LiAlH_4 or zinc metal in various solvents (acetic acid is popular) or hydrogenation over catalysts such as nickel reduce the N–O bond to give NH and OH functionality without changing the structure or stereochemistry of the rest of the molecule. From the examples above, we get these products:





In each cycloaddition, one permanent C–C and one C–O bond (shown in brown) were made. These were retained while the N–O bond present in the original dipole was discarded. The final product is an amino-alcohol with a 1,3-relationship between the OH and NH groups.

Linear 1,3-dipoles

In the Diels–Alder reaction, the dienes had to have an *s-cis* conformation about the central single bond so that they were already in the shape of the product. Many useful 1,3-dipoles are actually linear and although their 1,3-dipolar cycloadditions look very awkward they still work well. We shall start with the nitrile oxides, which have a triple bond where the nitronium had a double bond.

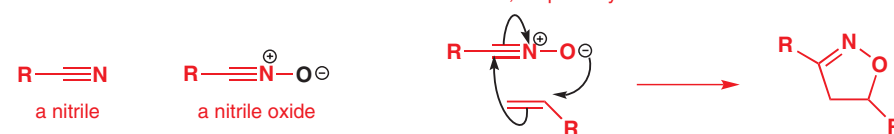
a 1,3-dipolar cycloaddition with a nitrile oxide



 Interactive mechanism for nitrile oxide cycloaddition

Making nitrile oxides

There are two important routes to these compounds, both of which feature interesting chemistry. Oximes, easily made from aldehydes with hydroxylamine ($\text{NH}_2\text{--OH}$), are rather enol-like and can be chlorinated on carbon.

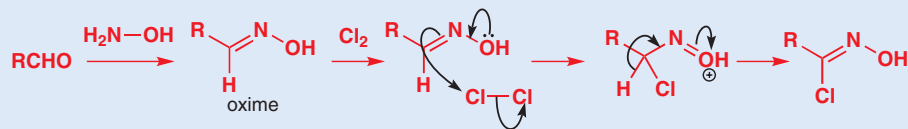

Treatment of the chloro-oxime with base (Et_3N is strong enough) leads directly to the nitrile oxide with the loss of HCl . This is an elimination of a curious kind as we cannot draw a connected chain of arrows for it. We must use two steps—removal of the OH proton and then loss of chloride. It is a γ elimination rather than the more common β elimination.



The other method starts from nitroalkanes and is a dehydration. Inspect the two molecules and you will see that the nitro compound contains one molecule of H_2O more than the nitrile oxide. But how to remove the molecule of water? The reagent usually chosen is phenyl isocyanate ($\text{Ph-N}=\text{C}=\text{O}$), which removes the molecule of water atom-by-atom to give aniline (PhNH_2) and CO_2 . This is probably the mechanism, although the last step might not be concerted, as we have shown.

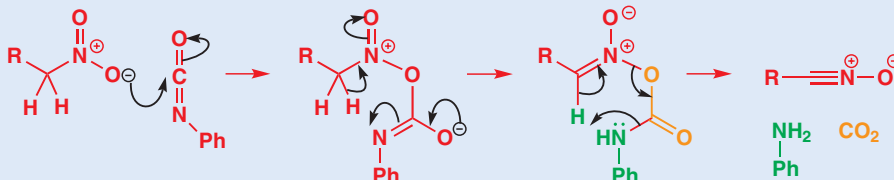

Interactive mechanism for nitrile oxide formation

As you might expect, this $[3+2]$ cycloaddition is a reaction involving the HOMO of the alkene and the LUMO of the nitrile oxide so that the leading interaction that determines the structure of the product is the one in the margin. If there is stereochemistry in the alkene, it is faithfully reproduced in the heterocyclic adduct as is usual for a concerted cycloaddition.



LUMO of nitrile oxide

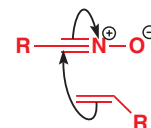

HOMO of alkene

Both partners in nitrile oxide cycloadditions can have triple bonds—the product is then a stable aromatic heterocycle called an isoxazole.

cycloaddition of nitrile oxide and alkyne

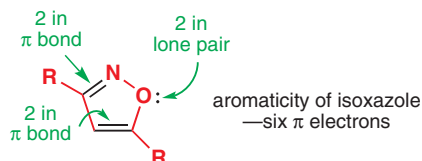
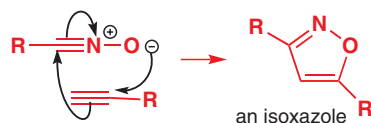

Interactive mechanism for isoxazole formation

Reduction of the $\text{N}-\text{O}$ bond and the $\text{C}=\text{N}$ double bond of the nitrile oxide cycloadducts produces useful amino alcohols with a 1,3-relationship between the two functional groups. As the $\text{N}-\text{O}$ bond is the weaker of the two, it is alternatively possible to reduce just that and leave the $\text{C}=\text{N}$ bond alone. This gives an imine, which usually hydrolyses during work-up.

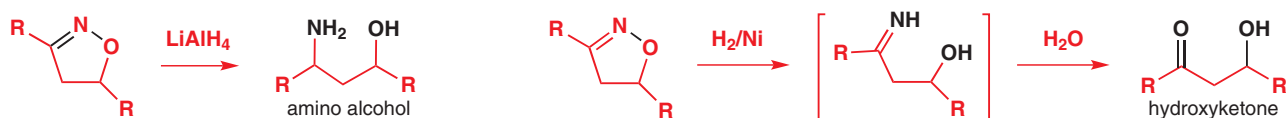

Any stereochemistry in the adduct is preserved right through this reduction and hydrolysis sequence: you might like to compare the products with the products of the stereoselective aldol reactions you saw in Chapter 33.

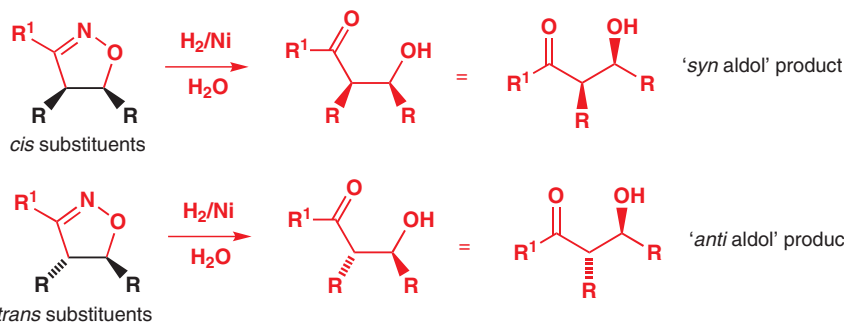

Other heterocycles by 1,3-dipolar cycloaddition

The synthesis of aromatic heterocycles by 1,3-dipolar cycloadditions was also treated in some detail in Chapter 30. There we discussed the important related reaction of azides with alkynes to make triazoles (p. 774).

cycloaddition of azide and alkyne

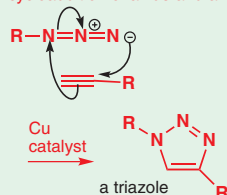

We shall end this section with the illustration of a beautiful intramolecular 1,3-dipolar cycloaddition that was used in the synthesis of the vitamin biotin. Starting at the beginning of the synthesis will allow you to revise some reactions from earlier chapters. The starting material is a simple cyclic allylic bromide that undergoes an efficient S_N2 reaction with a sulfur nucleophile. In fact, we don't know (or care!) whether this is an S_N2 or S_N2' reaction as the product of both reactions is the same. This sort of chemistry was discussed in Chapter 24 if you need to check up on it. Notice that it is the sulfur atom that does the attack—it is the soft end of the nucleophile and better at S_N2 reactions. The next step is the cleavage of the ester group to reveal the thiolate anion.

Biotin

Biotin is an enzyme cofactor that activates and transports CO_2 for use as an electrophile in biochemical reactions.

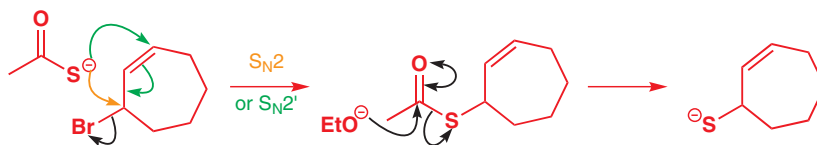
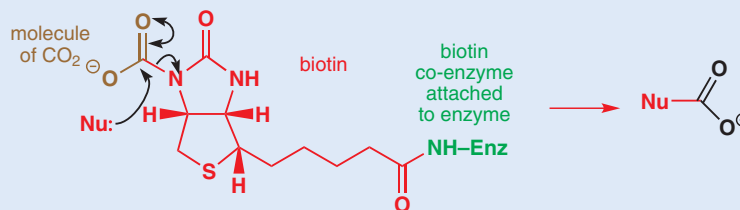

The nucleophilic thiolate anion does a conjugate addition (Chapter 22) on to a nitroalkene.

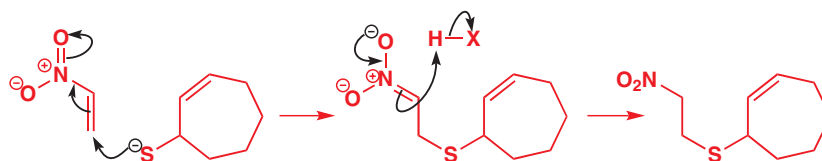

Now comes the exciting moment. The nitroalkene gives the nitrile oxide directly on dehydration with $\text{PhN}=\text{C}=\text{O}$ and the cycloaddition occurs spontaneously in the only way it can, given the intramolecular nature of the reaction.

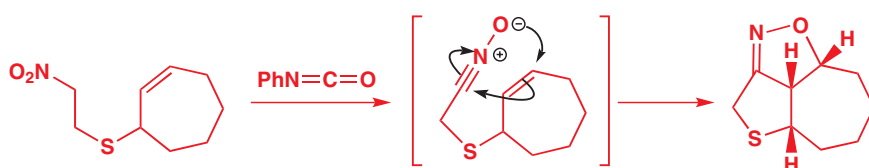

In the margin we show how this reaction works—the nitrile oxide comes up from the underside of the seven-membered ring, pushing the black hydrogen atoms upwards and making all the rings join up in a *cis* fashion. Next the cycloadduct is reduced completely with LiAlH_4 so that both the N–O and C=N bonds are cleaved. This step is very stereoselective so the C=N reduction probably precedes the N–O cleavage and the hydride has to attack from the outside (top) face of the molecule. These considerations are explored more thoroughly in Chapter 32.

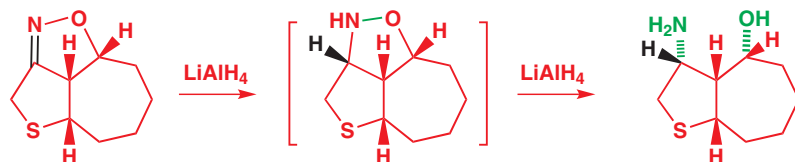
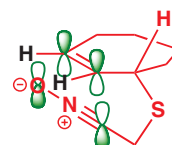

The sulfur-containing ring and the stereochemistry of biotin are already defined. In the seven steps that follow, the rest of the molecule is assembled. The most important is the breaking open of the seven-membered ring by a Beckmann rearrangement (which you will meet in Chapter 36).

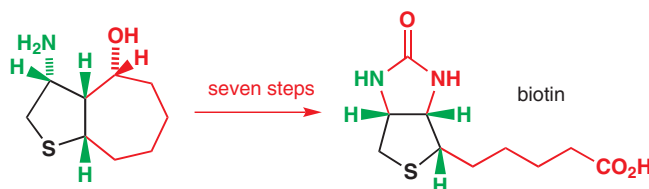

Two very important synthetic reactions: cycloaddition of alkenes with osmium tetroxide and with ozone

We shall end this chapter with two very important reactions, both of which we have alluded to earlier in the book (Chapter 19). These reactions are very important not just because of their mechanisms, which you must be aware of, but even more because of their usefulness in synthetic chemistry, and in that regard they are second only to the Diels–Alder reaction when considering all the reactions in this chapter. They are both oxidations—one involves osmium tetroxide (OsO_4) and one involves ozone (O_3) and they both involve cycloaddition.

OsO_4 adds two hydroxyl groups *syn* to a double bond

In Chapter 19 we emphasized the stereospecificity of this reaction but now we want to consider the nature of the first step (in the green frame). This is a cycloaddition between the osmium tetroxide and the alkene. You can treat the OsO_4 like a dipole, although it isn't drawn as one because osmium has plenty of orbitals to accommodate four double bonds. The reaction is a [3 + 2] cycloaddition or a 1,3-dipolar cycloaddition, whichever you prefer.

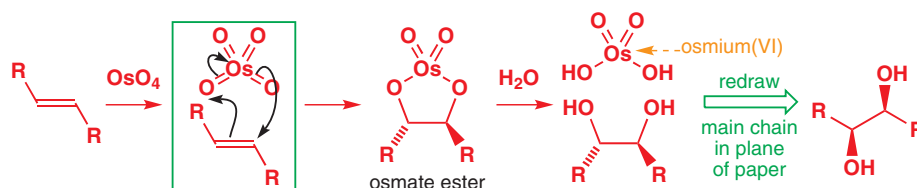

Interactive mechanism for dihydroxylation of alkenes

The osmate ester isn't the required product, and the reaction is usually done in the presence of water (the usual solvent is a *t*-BuOH-water mixture), which hydrolyses the osmate ester to the diol. Because both oxygen atoms were added in one concerted step during the cycloaddition, their relative stereochemistry must remain *syn*.

Note that, in the cycloaddition, one arrow stops on osmium and another starts on the other side. Osmium therefore gains a lone pair of electrons and is reduced from Os(VIII) to Os(VI)—the reaction is therefore an oxidation, and it's one that is very specific to C=C double bonds (as we mentioned in Chapter 23). As written, it would involve a whole equivalent of the expensive, toxic, and heavy metal osmium, but it can be made catalytic by introducing a reagent to oxidize Os(VI) back to Os(VIII). The usual reagent is *N*-methylmorpholine-*N*-oxide (NMO) or Fe(III), and typical conditions for an osmylation, or dihydroxylation, reaction are shown in the scheme below.

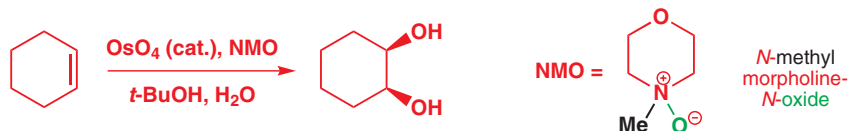

In behaviour that is typical of a 1,3-dipolar cycloaddition reaction, OsO₄ reacts almost as well with electron-poor as with electron-rich alkenes. OsO₄ simply chooses to attack the alkene HOMO or its LUMO, depending on which gives the best interaction. This is quite different from the electrophilic addition of *m*-CPBA or Br₂ to alkenes.



A cycloaddition that destroys bonds: ozonolysis

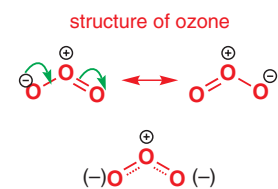

Our last type of cycloaddition is most unusual. It starts as a 1,3-dipolar cycloaddition but eventually becomes a method of cleaving π bonds in an oxidative fashion so that they end up as two carbonyl groups. The reagent is ozone, O₃. Again, you met this reaction in Chapter 19, but we can now show you the full, remarkable details of the reaction mechanism.

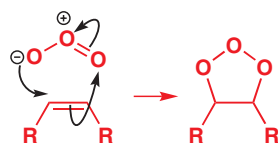

Ozone is a symmetrical bent molecule with a central positively charged oxygen atom and two terminal oxygen atoms that share a negative charge. It is a 1,3-dipole and does typical 1,3-dipolar cycloadditions with alkenes. The product is a very unstable compound. The O–O single bond (bond energy 140 kJ mol⁻¹) is a very weak bond—much weaker than the N–O bond (180 kJ mol⁻¹) we have been describing as weak in previous examples—and this heterocycle has two of them. It immediately decomposes—by a *reverse* 1,3-dipolar cycloaddition.

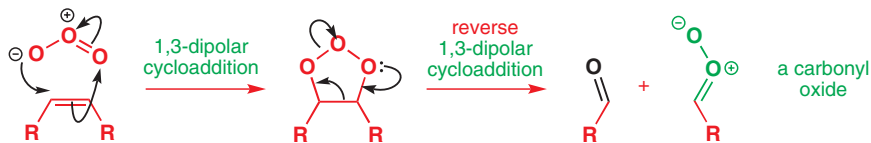

The products are a simple aldehyde on the left and a new, rather unstable looking molecule—a 1,3-dipole known as a carbonyl oxide—on the right. At least it no longer has any true O–O single bonds (the one that looks like a single bond is part of a delocalized system like the one in ozone). Being a 1,3-dipole, it now adds to the aldehyde in a third cycloaddition step. It might just add back the way it came, but it much prefers to add in the other way round, with the nucleophilic oxyanion attacking the carbon atom of the carbonyl group like this.

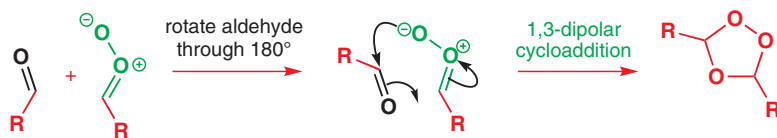

Interactive mechanism of ozonolysis

This compound—known as an ozonide—is the first stable product of the reaction with ozone. It is the culmination of two 1,3-dipolar cycloadditions and one reverse 1,3-dipolar cycloaddition. It is still not that stable and is quite explosive, so for the reaction to be of any use it needs decomposing. The way this is usually done is with dimethylsulfide or Ph_3P , which attacks the ozonide to give DMSO and two molecules of aldehyde.

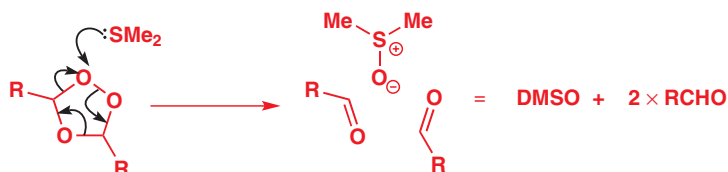

The ozonide will also react with oxidizing agents such as H_2O_2 to give carboxylic acids, or with more powerful reducing agents such as NaBH_4 to give alcohols. Here are the overall transformations—each cleaves a double bond—it is called an ozonolysis.

ozonolysis of alkenes to...

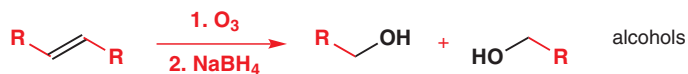
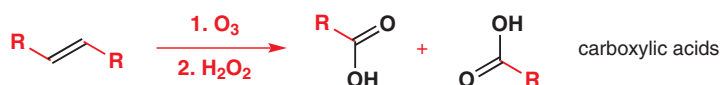
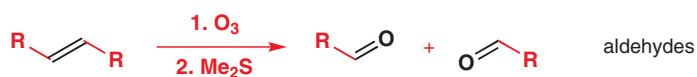

Summary of cycloaddition reactions

- A cycloaddition is a one-step ring-forming reaction between two conjugated π systems in which two new σ bonds are formed, joining the two reagents at each end. The mechanism has one step with no intermediates, and all the arrows start on π bonds and go round in a ring.

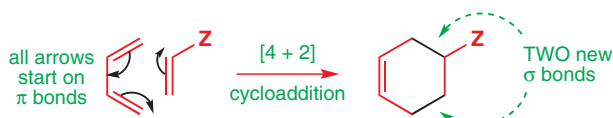

- The cycloadditions are suprafacial—they occur on one face only of each π system—and for a thermally allowed reaction there should be $4n + 2$ electrons in the mechanism, but $4n$ in a photochemical cycloaddition. These rules are dictated by orbital symmetry.
- Cycloaddition equilibria generally lie over on the right-hand side in a thermal reaction because C–C σ bonds are stronger than C–C π bonds. In a photochemical cycloaddition the product loses its π bonds and therefore its means of absorbing energy. It is therefore the kinetic product of the reaction even if it has a strained four-membered ring.

- The stereochemistry of each component is faithfully reproduced in the product—the reactions are stereospecific—and the relationship between their stereochemistries may be governed by orbital overlap to give an *endo* product.

In the next chapter we meet two more classes of pericyclic reactions: electrocyclic reactions and sigmatropic rearrangements.

Further reading

For explanations of pericyclic reactions and other reactions, using the full molecular orbital treatment, consult: Ian Fleming, *Molecular Orbitals and Organic Chemical Reactions, Student Edition*, Wiley, Chichester 2009. There is also a more comprehensive edition intended for practicing chemists, called the *Library Edition*. He has also written an Oxford Primer: *Pericyclic Reactions*, OUP, Oxford, 1999.

For a comprehensive treatment of cycloadditions in the synthesis of nitrogen heterocycles, see P. Wyatt and S. Warren, *Organic Synthesis: Strategy and Control*, Wiley, Chichester, 2007, chapter 34.

The biotin synthesis on p. 904 is described by P. Confolone and his group, *J. Am. Chem. Soc.*, 1980, **102**, 1954.

Check your understanding



To check that you have mastered the concepts presented in this chapter, attempt the problems that are available in the book's Online Resource Centre at <http://www.oxfordtextbooks.co.uk/orc/clayden2e/>

Pericyclic reactions 2: sigmatropic and electrocyclic reactions

35

Connections

➔ Building on

- Cycloadditions and the principles of pericyclic reactions (essential reading!) [ch34](#)
- Acetal formation [ch11](#)
- Conformational analysis [ch16](#)
- Elimination reactions [ch17](#)
- Controlling alkene geometry and main group chemistry [ch27](#)
- The synthesis of aromatic heterocycles [ch30](#)

Arriving at

- The second and third types of pericyclic reaction
- Stereochemistry from chair-like transition states
- What decides whether these pericyclic reactions go 'forwards' or 'backwards'
- Special chemistry of N, S, and P
- Why substituted cyclopentadienes are unstable
- What 'con'- and 'dis'-rotatory means

➔ Looking forward to

- Rearrangements [ch36](#)
- Asymmetric synthesis [ch41](#)
- Natural products [ch42](#)

Cycloadditions, the subject of the last chapter, are just one of the three main classes of pericyclic reaction. In this chapter we consider the other two classes: **sigmatropic rearrangements** and **electrocyclic reactions**. We will analyse them in a way that is similar to our dealings with cycloadditions.

Sigmatropic rearrangements

The Claisen rearrangement was the first to be discovered

The original sigmatropic rearrangement occurred when an aryl allyl ether was heated without solvent and an *ortho*-allyl phenol resulted. This is the Claisen rearrangement. The first step in this reaction is a pericyclic reaction of a type that you will learn to call a [3,3]-sigmatropic rearrangement.

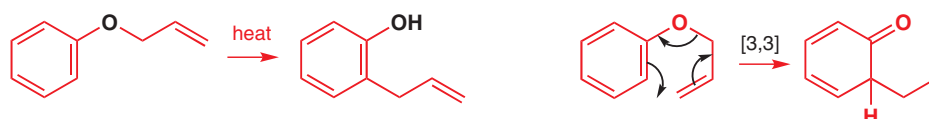

 Interactive mechanism for aromatic Claisen rearrangement

This is a one-step mechanism without ionic intermediates or any charges, just like a cycloaddition. The arrows go round in a ring. The difference between this and a cycloaddition is that one of the arrows starts on a σ bond instead of on a π bond. The second step in the reaction is a simple ionic proton transfer to regenerate aromaticity.

Online support. The icon  in the margin indicates that accompanying interactive resources are provided online to help your understanding: just type www.chemtube3d.com/clayden/123 into your browser, replacing **123** with the number of the page where you see the icon. For pages linking to more than one resource, type **123-1**, **123-2** etc. (replacing **123** with the page number) for access to successive links.

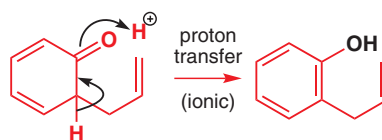

How do we know that this is the mechanism? If the allyl ether is unsymmetrical, it turns ‘inside out’ during Claisen rearrangement, as required by the mechanism. Check for yourself that this is right.

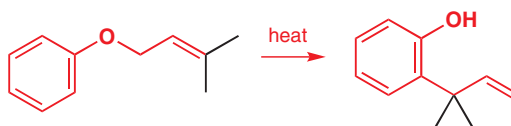

The aliphatic Claisen rearrangement also occurs



It was later found that the same sort of reaction occurs without the aromatic ring. This is called either the aliphatic Claisen rearrangement or the Claisen–Cope rearrangement. Here is the simplest possible example.

All these reactions are called sigmatropic because a σ bond appears to move from one place to another during the reaction. This particular reaction is called a [3,3]-sigmatropic rearrangement because the new σ bond has a 3,3 relationship to the old σ bond. You can see this if you number both ends of the old σ bond ‘1’ and count round in both directions to the ends of the new σ bond in the product. You will find that the ends of the new σ bond both have the number ‘3’.

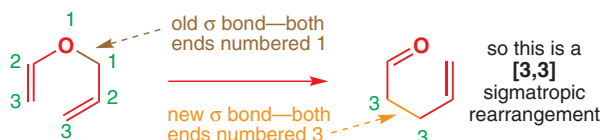

These [3,3]-sigmatropic rearrangements happen through a chair-like transition state, which allows us both to get the orbitals right and to predict the stereochemistry (if any) of the new double bond. The orbitals look something like this.

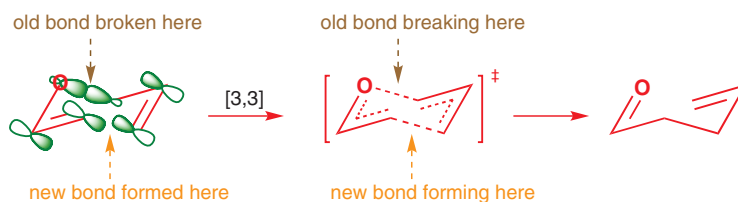

Note that these do not represent any specific frontier orbitals, they simply show that, in this conformation, the new σ bond is formed from two p orbitals that point directly at each other and that the two new σ bonds are formed from orbitals that are already parallel.

Alkene stereochemistry in the Claisen rearrangement comes from a chair-like transition state

Stereochemistry may arise if there is a substituent on the saturated carbon atom next to the oxygen atom. If there is, the resulting double bond strongly favours the *trans* (*E*) geometry. This is because the substituent prefers an equatorial position on the chair transition state.

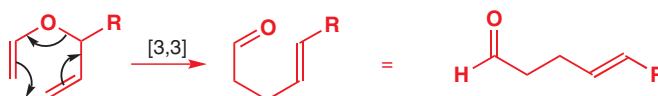

The substituent R prefers an equatorial position as the molecule reacts and R retains this position in the product. The new alkene bond is shown in green. Notice that the *trans* geometry of the alkene in the product is already there in the conformation chosen by the starting material and in the transition state.



The starting material for these aliphatic Claisen rearrangements consists of ethers with one allyl and one vinyl group. We need now to consider how such useful molecules might be made. There is no problem about the allyl half—allylic alcohols are stable, easily made compounds. But what about the vinyl half? 'Vinyl alcohol' is just the enol of acetaldehyde (MeCHO).

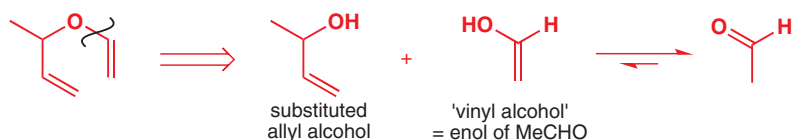

The solution is to use an acetal of the aldehyde in an acid-catalysed exchange process with the allylic alcohol. It is not necessary to isolate the allyl vinyl ether as long as some of it is formed and rearranges into the final product.

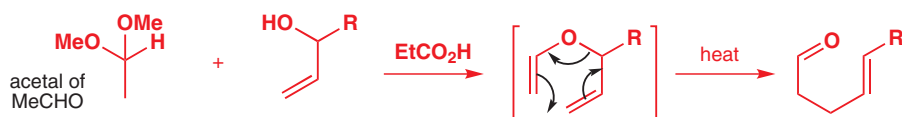

The acid catalyst usually used, propanoic acid, has a conveniently high boiling point so that the whole mixture can be equilibrated at high temperature. The first step is an acetal exchange in which the allylic alcohol displaces methanol.

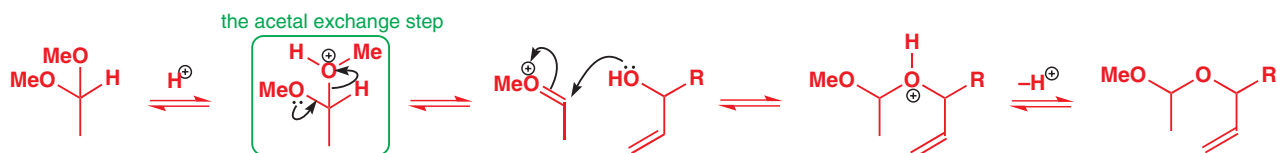

The methanol is distilled off as it is the most volatile of the components in this mixture. A second molecule of methanol is now lost in an acid-catalysed elimination reaction to give the vinyl group.

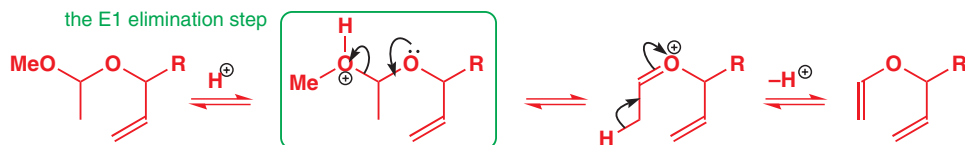

 Interactive aliphatic Claisen rearrangement mechanism

■ Note that the first molecule of methanol was displaced in an S_N1 reaction and the second lost in an E1 reaction. The chemistry of acetals is dominated by the loss of protonated OR or OH groups in the steps with green boxes. Never be tempted to write S_N2 mechanisms with acetals.

The Claisen rearrangement is a general synthesis of γ,δ -unsaturated carbonyl compounds

The [3,3]-sigmatropic rearrangement itself can be carried out by heat as part of the same step or as a separate step depending on the compounds. This is a very flexible reaction sequence and can be used for aldehydes (as shown above), ketones, esters, or amides. In each case acetal-like compounds are used—acetals themselves for aldehydes and ketones; orthoesters and orthoamides for the other two (although the orthoamides are often called 'amide acetals').

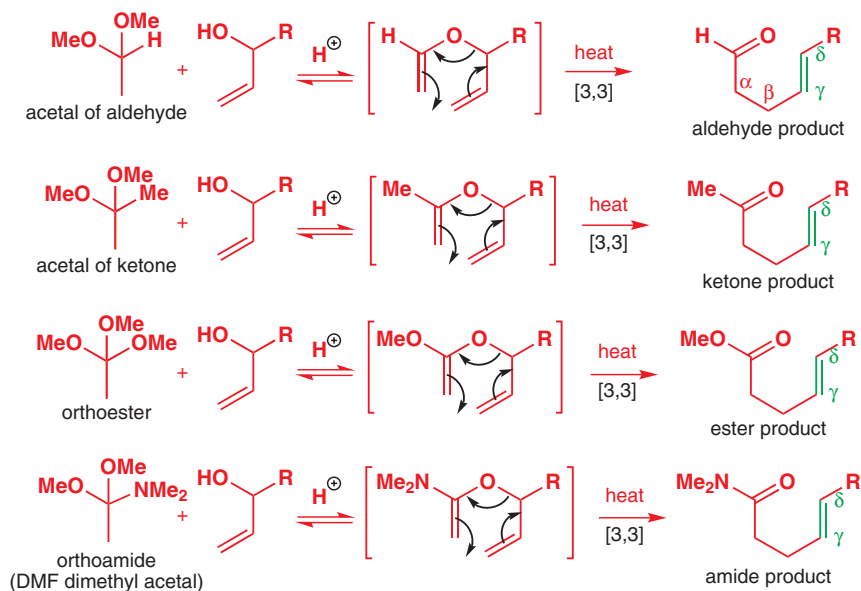

The common feature in the products of these Claisen rearrangements is a γ,δ -unsaturated carbonyl group. If this is what you need in a synthesis, make it by a Claisen rearrangement.

Orbital descriptions of [3,3]-sigmatropic rearrangements

► If you need reminding of the meanings of the terms or symbols in this section please turn back to p. 892 of Chapter 34 now.

It is possible to give a frontier orbital description of a [3,3]-sigmatropic rearrangement but this is not a very satisfactory treatment because we don't have two separate reagents recognizing each other across space as we did in cycloadditions. There are *three* components in these reactions—two non-conjugated π bonds that do have to overlap across space and a σ bond in the chain joining the two π bonds. The Woodward–Hoffmann rules give a more satisfying description and we shall follow the routine outlined on p. 892 for cycloadditions. Note that for stage 3, we can use the three-dimensional diagram we have already made.

First a reminder of the Woodward–Hoffmann rules:

• The Woodward–Hoffmann rules

In a thermal pericyclic reaction the total number of $(4q + 2)_s$ and $(4r)_a$ components must be odd.

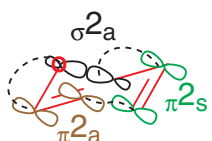
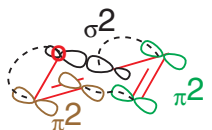
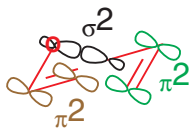
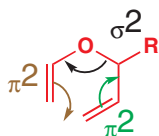
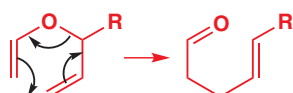

1. Draw the mechanism for the reaction (we shall stay with a familiar one).
2. Choose the components. All the bonds taking part in the mechanism must be included and no others.
3. Make a three-dimensional drawing of the way the components come together for the reaction, putting in orbitals at the ends of the components (only!). Note that we have dropped the shading in the orbital from the previous diagrams earlier in the chapter.
4. Join up the components where new bonds are to be formed. Make sure you join orbitals that are going to form new bonds.
5. Label each component s or a depending whether new bonds are formed on the same or on opposite sides. See below for the σ bond symmetry.

6. Add up the number of $(4q + 2)_s$ and $(4r)_a$ components. If the sum is odd, the reaction is allowed. Here there is:

one $(4q + 2)_s$ component (one alkene) and
no $(4r)_a$ components.

Total=1, so this is an allowed reaction. As you saw in Chapter 34 (p. 893), the $\pi 2_a$ and $\sigma 2_a$ components have irrelevant symmetry and are not counted.

One new aspect of orbital symmetry has appeared in this diagram—how did we deduce a *s* or *a* symmetry in the way the σ bond reacted? For π bonds it is simple—if both bonds are formed on the same side of the old π bond, it has reacted suprafacially; if on opposite sides, antarafacially.

With a σ bond the symmetry is not so obvious. We want to know if it does the *same* thing at each end (*s*) or a *different* thing (*a*). But what is the ‘thing’ it does? It reacts using the large lobe of the sp^3 orbital (retention) or the small lobe (inversion). If it reacts with retention at both ends or inversion at both ends, it reacts suprafacially, while if it reacts with retention at one end and inversion at the other, it reacts antarafacially. There are four possibilities.

σ bond reacting suprafacially

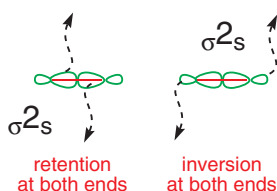

σ bond reacting antarafacially

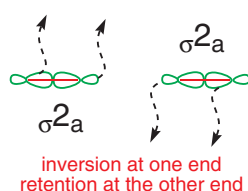

In the routine above, we chose to use our σ bond so that we got inversion at one end and retention at the other. That was why we identified it as an antarafacial component. If we had chosen another style we should have got different descriptions of the components, but the reaction would still have been allowed, for example changing just one connecting line, as in the margin, changes the symmetry of the σ bond so that it becomes a $\sigma 2_s$ component but it also changes the symmetry of one of the π bonds so that it becomes a $\pi 2_a$ component. The net result is still only one component of the Woodward–Hoffmann symmetry, the sum is still 1, and the reaction still allowed.

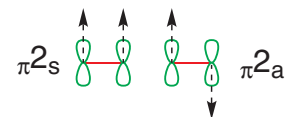

■ If you are interested in the frontier orbital approach to [3,3]-sigmatropic reactions, you could read about it in Ian Fleming (2009) *Frontier orbitals and organic chemical reactions*, 2nd edn, Wiley, Chichester. We shall use this approach when we come to [1,5]-sigmatropic rearrangements.

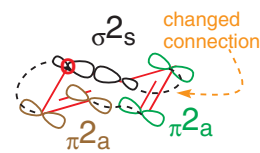

no. of $(4q + 2)_s$ components: 1
no. of $(4r)_a$ components: 0
sum = 1
—reaction is allowed thermally

The direction of [3,3]-sigmatropic rearrangements

Orbital symmetry tells us that [3,3]-sigmatropic rearrangements are allowed but says nothing about which way they will go. They are allowed in either direction. So why does the Claisen–Cope rearrangement always form the carbonyl-containing product? Think back to our discussion on enols (Chapter 20) and you may recall that the combination of a carbonyl group and a C–C σ bond made the keto form more stable than the enol form with its combination of a C=C π bond and a C–O σ bond. The same is true here. It is the stability of the carbonyl group that drives the reaction to the right.

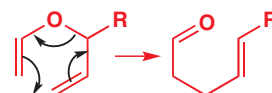

Directing the Cope rearrangement by the formation of a carbonyl group

The Cope rearrangement is a [3,3]-sigmatropic rearrangement with only carbon atoms in the ring. In its simplest version it is not a reaction at all. The starting material and the product are the same.

We can drive this reaction too by the formation of a carbonyl group if we put an OH substituent in the right place.

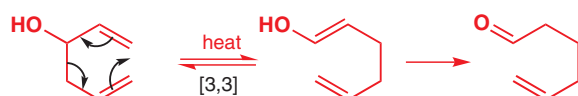

The product of the sigmatropic step is the enol of the final product. It turns out that the reaction is accelerated if the starting alcohol is treated with base (KH is the best) to make the alkoxide. The product is then the potassium enolate, which is more stable than the simple potassium alkoxide starting material. As the reaction proceeds, conjugation is growing between O^- and the new π bond.

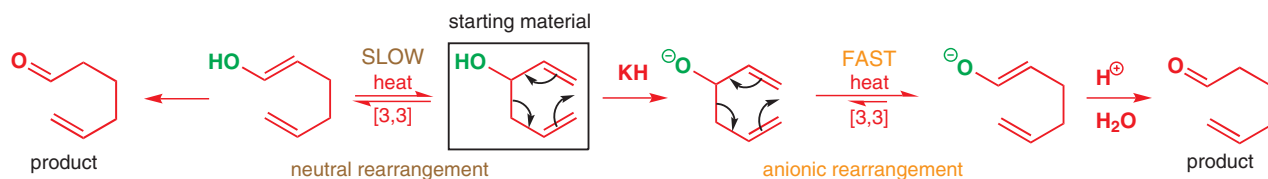

► **Bredt's rule** forbidding bridgehead alkenes and the reasons for it are discussed in Chapter 17.

Some remarkable compounds can be made by this method. One of the strangest—a 'bridge-head' alkene—was made by a potassium alkoxide-accelerated Cope rearrangement in which a four-membered ring was expanded into an eight-membered ring containing a *trans* double bond (shown in green).

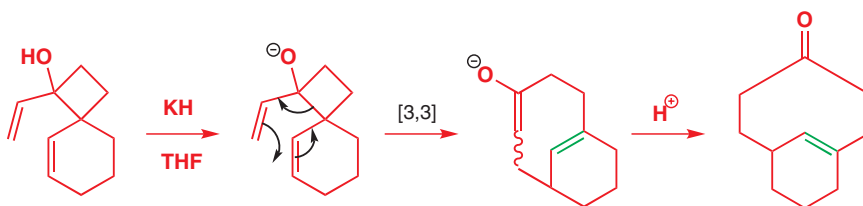

A combination of an oxygen atom in the ring and another one outside the ring is very powerful at promoting [3,3]-sigmatropic rearrangements and easy to arrange by making the lithium enolate of an ester of an allylic alcohol.

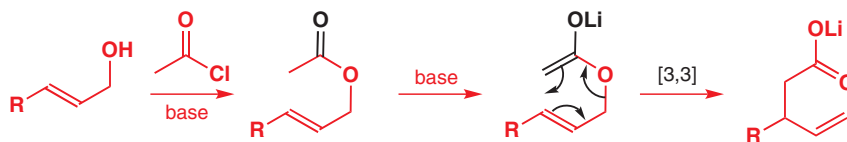

Sometimes it is better to convert the lithium enolate into the silyl enol ether before heating to accomplish the [3,3]-sigmatropic rearrangement. In any case, both products give the unsaturated carboxylic acid on work-up.

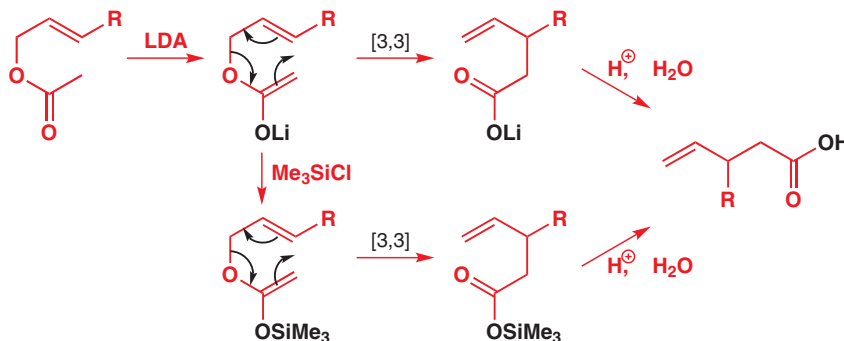

► Interactive mechanism for Ireland–Claisen rearrangement

This reaction is known as the Ireland–Claisen rearrangement as it was a variation of the Claisen rearrangement invented by R. E. Ireland in the 1970s and widely used since. If the substituents are suitably arranged, it shows the same *E* selectivity as the simple Claisen rearrangement and for the same reason.

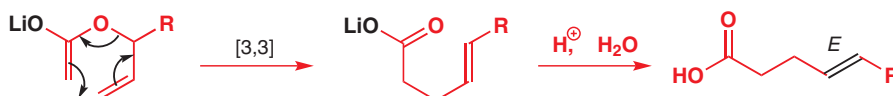

In some cases simple Cope rearrangements without any oxygen atoms at all can be directed by an unstable starting material or a stable product. The instability might be strain and the stability might simply be more substituents on the double bonds. In the next reaction the driving force is the breaking of a weak σ bond in a three-membered ring. This reaction goes in 100% yield at only just above room temperature, so it is very favourable. In the second example, the trisubstituted double bonds inside the five-membered rings of the product are more stable than the exomethylene groups in the starting material.



An industrial synthesis of citral

'Citral' is a key intermediate in the synthesis of vitamin A, and it is manufactured by a remarkable process that involves two successive [3,3]-sigmatropic rearrangements, a Claisen followed by a Cope. The allyl vinyl ether needed for the Claisen rearrangement is an enol ether of an unsaturated aldehyde with an unsaturated alcohol. The two starting materials are themselves derived from a common precursor, making this a most efficient process! Heating the enol ether promotes [3,3]-sigmatropic rearrangement propelled by the formation of a carbonyl group.

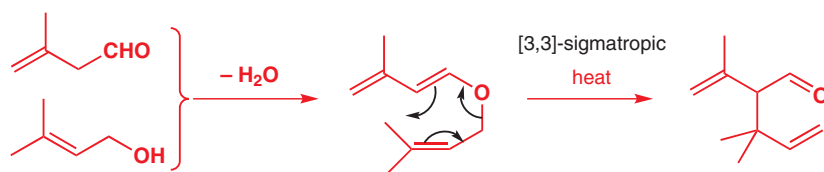
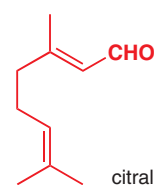

■ Notice that the product is a γ,δ -unsaturated carbonyl compound.

But the product of this rearrangement is now set up for a second [3,3]-sigmatropic rearrangement, this time made favourable by a shift into conjugation and the formation of two trisubstituted double bonds from two terminal ones. Overall, the prenyl group walks from one end of the molecule to the other, inverting twice as it goes.

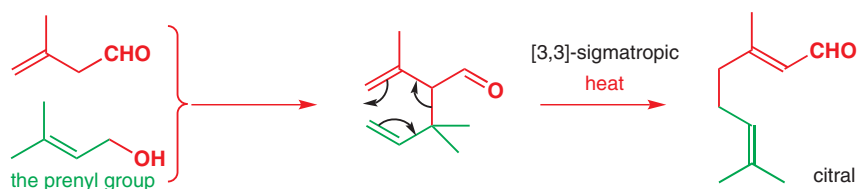

Seaweed sex censored by a sigmatropic shift

In order to reproduce, the female gametes of marine brown algae must attract mobile male gametes. This they do by releasing a pheromone, long thought to be the cycloheptadiene ectocarpene. In 1995 results were published that suggested that, in fact, the pheromone was a cyclopropane, and that ectocarpene was ineffective as a pheromone.

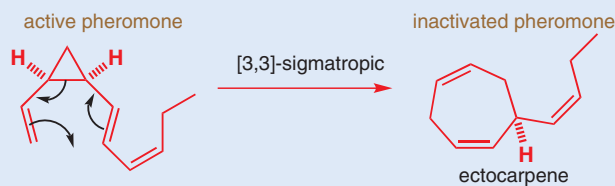

How had the confusion arisen? Well, the remarkable thing is that the cyclopropyl pheromone inactivates itself, with a half-life of several minutes at ambient temperature, by [3,3]-sigmatropic rearrangement to the cycloheptadiene, driven by release of strain from the three-membered ring. This not only confused the earlier pheromone chemists, but it also provides a marvellously precise way for the algae to signal their presence and readiness for reproduction without saturating the sea water with meaningless pheromone.

Applications of [3,3]-sigmatropic rearrangements using other elements

There is no need to restrict our discussion to carbon and oxygen atoms. We shall finish this section with two useful reactions that use other elements. You met the most famous synthesis of indoles in Chapter 30—the Fischer indole synthesis—and we can now look in more detail at the key step of this remarkable reaction. Condensation of phenylhydrazine with a ketone in slightly acidic solution gives a phenylhydrazone.

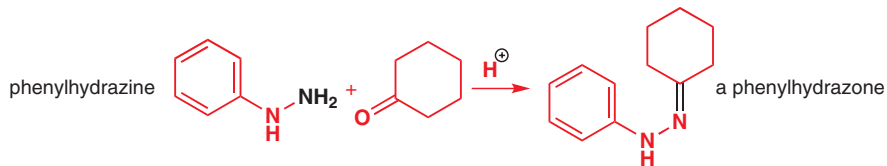

➔ Hydrazones—the imine derivatives of hydrazines—appeared in Chapter 11.

If the ketone is enolizable, this imine is in equilibrium with the corresponding enamine. The important bonds are given in black in the diagram. The enamine is ideally set up for a [3,3]-sigmatropic rearrangement in which the σ bond to be broken is the weak N–N σ bond and one of the π bonds is in the benzene ring.

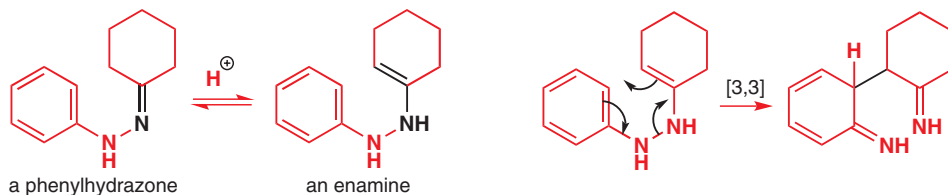

 Interactive mechanism for Fischer indole synthesis

The product is a highly unstable double imine. But aromaticity is immediately restored and a series of proton shifts and C–N bond formation and cleavage reactions give the aromatic indole.

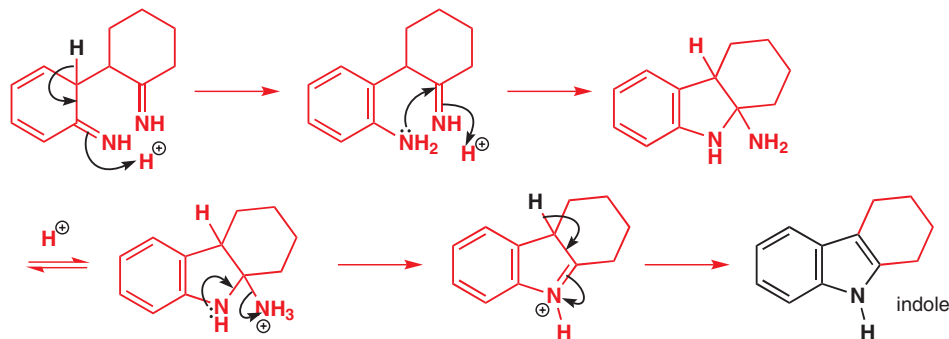

➔ A detailed discussion of this reaction as a synthesis of indoles appears in Chapter 30.

That was a [3,3]-sigmatropic reaction involving two nitrogens. There follows one with two oxygens and a chromium atom. When tertiary allylic alcohols are oxidized with CrO_3 in acid solution, no direct oxidation can take place, but a kind of conjugate oxidation occurs.

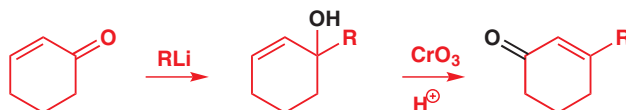

The first step in Cr(VI) oxidations can take place to give a chromate ester but this intermediate has no proton to lose so it transfers the chromate to the other end of the allylic system, where there is a proton. The chromate transfer can be drawn as a [3,3]-sigmatropic rearrangement. The final step is the normal oxidation in which chromium drops down from orange Cr(VI) to Cr(IV) and eventually by disproportionation to green Cr(III).

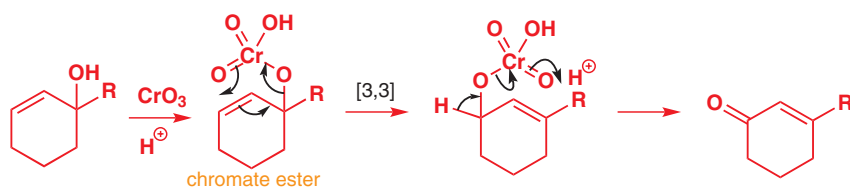

➔ Cr(VI) oxidations are described in Chapters 9 and 23.

[2,3]-Sigmatropic rearrangements

All [3,3]-sigmatropic rearrangements have six-membered cyclic transition states. It is no accident that the size of the ring is given by the sum of the two numbers in the square brackets and this is universally the case for sigmatropic rearrangements. We are now going to look at [2,3]-sigmatropic rearrangements so we will be needing five-membered cyclic transition states. There is a problem here. You cannot draw three arrows going round a five-membered ring without stopping or starting on an atom, not a bond. This can be OK if the atom is a carbanion.

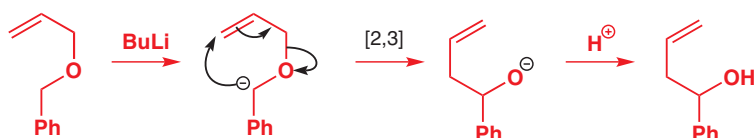

The starting material is a benzyl allyl ether and undergoes [2,3]-sigmatropic rearrangement to make a new C–C σ bond at the expense of a C–O σ bond—a bad bargain this as the C–O bond is stronger. The balance is tilted by the greater stability of the oxyanion in the product than of the carbanion in the starting material. The new bond has a 2,3 relationship to the old and the transition state is a five-membered ring.

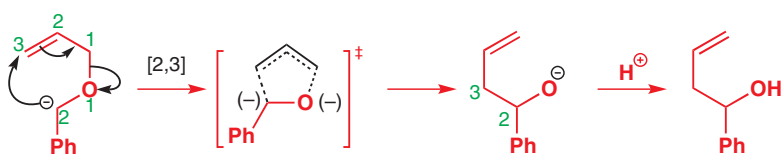

The transition state can be quite chair-like so that the new π bond will be *trans* if it has a choice. There will be a choice if the ether has been made from a substituted allyl alcohol.

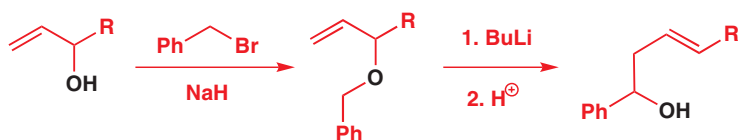

We cannot draw a complete chair as we haven't got a six-membered ring, but the part that is to become the new π bond can be in a chair-like part of the five-membered ring. The substituent R prefers an equatorial position and the resulting *trans* arrangement of the groups is outlined in green.

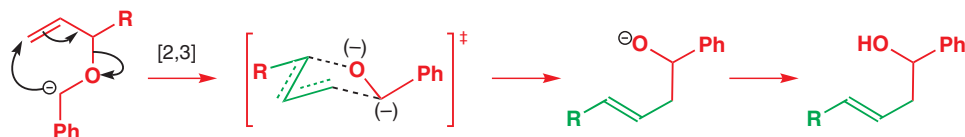

We can use the same conformational diagram to show how the orbitals overlap as the new bond is formed. When we come to use the Woodward–Hoffmann rules on these [2,3]-sigmatropic rearrangements, we find something new. We have a π bond and a σ bond and a carbanion. How are we to represent a carbanion (or a carbocation) that is just a p orbital on an atom? The new symbol we use for a simple p orbital is ω (lower case omega).

■ It can also be OK if the atom is a carbocation, or if it is an element that is happy to change oxidation state.

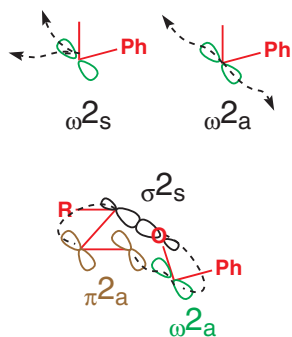

➔ Much more sulfur chemistry is described in Chapter 27.

A carbanion is an ω_2 component and a carbocation is an ω_0 component as it has zero electrons. If the two new bonds are formed to the same lobe of the p orbital of the carbanion, we have an ω_{2s} component, but if they are formed to different lobes we have an ω_{2a} component.

Without going through the whole routine again, the [2,3]-sigmatropic rearrangement we have been discussing can be described as an $\omega_{2a} + \sigma_{2s} + \pi_{2a}$ reaction. There is one $(4q+2)_s$ and no $(4r)_a$ component so the reaction is thermally allowed.

[2,3]-Sigmatropic rearrangements with S and Se

There are many [2,3]-sigmatropic rearrangements involving a variety of heteroatoms as well as carbon. The mechanism is common with elements that are prepared to change their oxidation state by two so that an arrow can both start and finish on that atom. The examples in this section involve sulfur and selenium, which can both form stable compounds at three oxidation states: S or Se(II), S or Se(IV), and S or Se(VI).



Reaction of an allylic alcohol with PhSCl gives an unstable sulfenyl ester that rearranges on heating to an allylic sulfoxide by a [2,3]-sigmatropic rearrangement involving both O and S. Notice that arrows both start and stop on the sulfur atom, which changes from S(II) to S(IV) during the reaction. The new functional group with an S=O bond is a sulfoxide, and this is a good way of making allylic sulfoxides. The product forms an anion stabilized by sulfur, which can be alkylated.

Interactive mechanism for the [2,3]-sigmatropic shift of sulfoxides

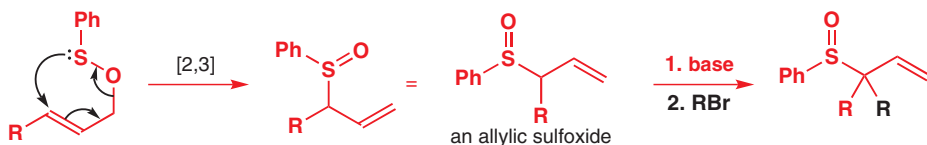

We have said that all these sigmatropic rearrangements are reversible but now we can prove it. If this product is heated in methanol with a nucleophile such as $(\text{MeO})_3\text{P}$ (trimethylphosphite), which has a liking for sulfur, the [2,3]-sigmatropic rearrangement runs backwards and a sulfenyl ester is again formed.

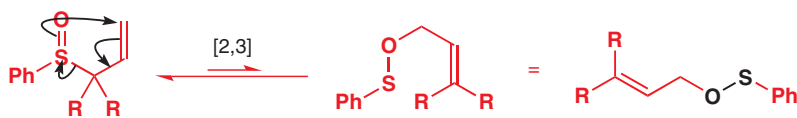

This is an unfavourable reaction because the equilibrium lies over on the sulfoxide side. But the nucleophile traps the sulfenyl ester and the methanol ensures that the alkoxide ion formed is immediately protonated so that we get another allylic alcohol.

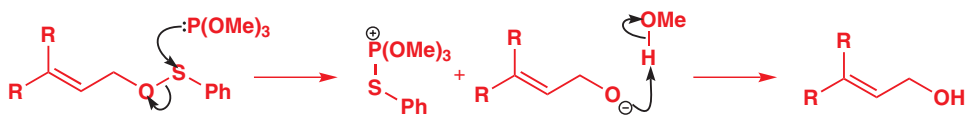

■ The other products are actually PhSMe and $(\text{MeO})_3\text{P}=\text{O}$. You might like to work out a mechanism for these stages of the reaction.

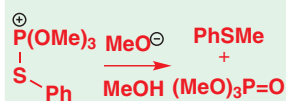

So what is the point of going round in circles like this? The net result is the alkylation of an allylic alcohol in a position where alkylation would not normally be considered possible.

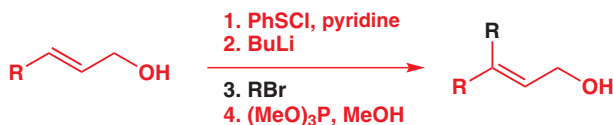

A related reaction of selenium in its +4 oxidation state (as selenium dioxide, SeO_2) allows us to make allylic alcohols and enals from simple alkenes. The overall reaction is the simple oxidation shown in the margin, but the route by which the compound gets there involves two successive pericyclic reactions.

Selenium dioxide will react with alkenes in a [4 + 2] cycloaddition reminiscent of the ene reaction.

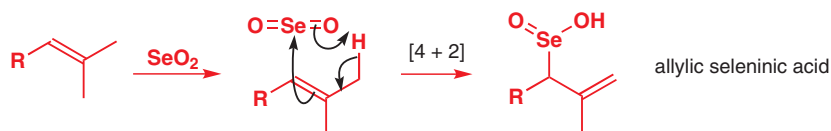

The initial product is an allylic seleninic acid—and just like an allylic sulfoxide (but more so because the C–Se bond is even weaker) it undergoes allylic rearrangement to give an unstable compound that rapidly decomposes to an allylic alcohol. In some cases, particularly this most useful oxidation of methyl groups, the oxidation continues to give an aldehyde or ketone.

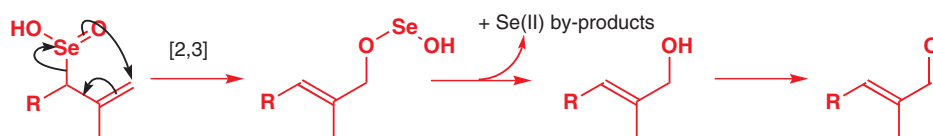

Overall, CH_3 has been replaced by CH_2OH or $\text{CH}=\text{O}$ in an allylic position, a transformation similar to the allylic bromination reaction with NBS that you met in Chapter 24, but with a very different mechanism. The by-product of the oxidation is a selenium(II) compound, and it can be more practical to carry out the reaction with only a catalytic amount of SeO_2 , with a further oxidizing agent, *t*-butyl hydroperoxide, to reoxidize the Se(II) after each cycle of the reaction. This eliminates the need to get rid of large amounts of selenium-containing products, which are toxic and usually smelly.

[1,5]-Sigmatropic hydrogen shifts

When one of the numbers in square brackets is '1', the old and new σ bonds are to the same atom, so we are dealing with the migration of a group around a conjugated system. In the case of a [1,5]-sigmatropic rearrangement the transition state is a six-membered ring (remember—just add together the numbers in square brackets). There is an important example in the margin. Let us first check that this is indeed a [1,5]-sigmatropic rearrangement by numbering the position of the new σ bond with respect to the old. Note that we must go the long way round the five-membered ring because that is the way the mechanism goes.

It is a [1,5]-sigmatropic rearrangement. The figure '1' in the square brackets shows that the same atom is at one end of the new σ bond as was at one end of the old σ bond. One atom has moved in a 1,5 manner and these are often called [1,5]-sigmatropic *shifts*. This is often abbreviated to [1,5]H shift to show which atom is moving. This particular example is important because sadly it prohibits a most attractive idea. The aromatic cyclopentadienyl anion is easily formed, stable, and readily alkylated. This sequence of alkylation and Diels–Alder reaction looks very good.

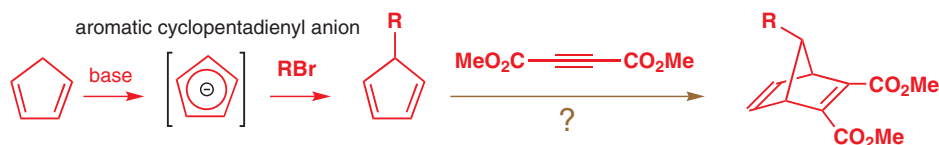

But sadly this sequence is, in fact, not good at all. A mixture of three Diels–Alder adducts is usually obtained resulting from addition to the three cyclopentadienes present in solution as

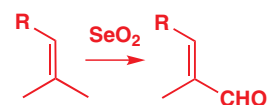

➔ The ene reaction was introduced on p. 894.

■ In a very few special cases, this seleninic acid intermediate has been isolated.

🔗 Interactive mechanism for allylic oxidation

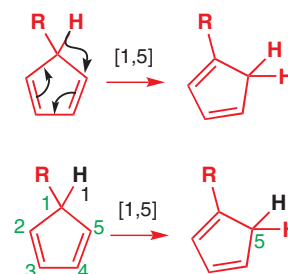

🔗 Interactive mechanism for a [1,5]-sigmatropic shift on cyclopentadiene

the result of rapid [1,5]H shifts. The one drawn above is a minor product because there is more of the other two dienes, which have an extra substituent on the double bonds.

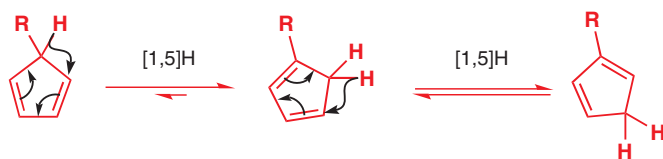

An excellent example comes from the intramolecular Diels–Alder reactions explored by Dreiding in 1983. One particular substituted cyclopentadiene was made by a fragmentation reaction (see Chapter 36). It might have been expected to give a simple Diels–Alder adduct.

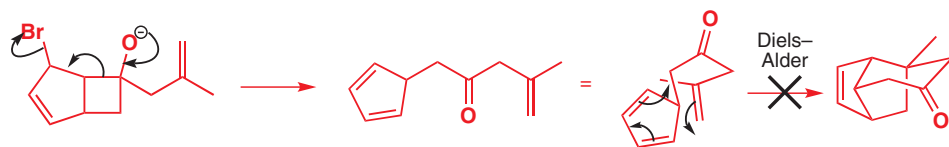

There is nothing wrong with this reaction—indeed, the product looks beautifully stable—but it is not formed because the [1,5]H shift is too quick and gives a more stable cyclopentadiene with more substituents on a double bond. *Then* it does the Diels–Alder reaction.

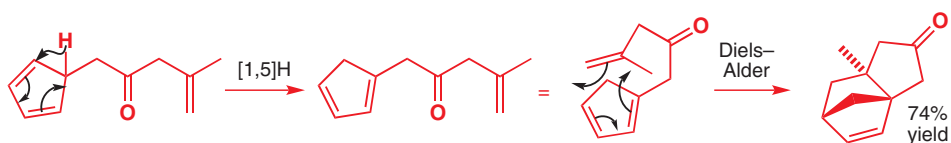

Notice that in these compounds the ketone is not conjugated to any of the alkenes and so does not influence the reaction. If we increase the reactivity of the dienophile by putting an ester group in conjugation with it, most of the compound does the Diels–Alder reaction *before* it does the [1,5]H shift.

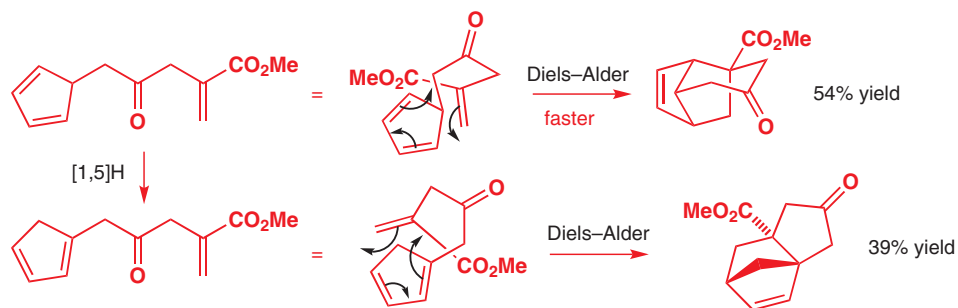

Orbital description for the [1,5]H sigmatropic shift

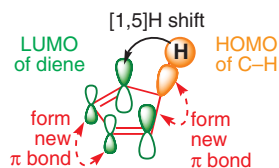

■ You should satisfy yourself that the other frontier orbital combination—HOMO of the diene and LUMO of the C–H bond—works equally well.

It is equally satisfactory to use frontier orbitals or the Woodward–Hoffmann rules for these reactions. We can take the diene as one component (HOMO or LUMO or π_4) and the C–H bond as the other (LUMO or HOMO or σ_2). Let us start by using the LUMO of the diene (ψ_3) and the HOMO of the C–H bond (its filled σ orbital), as shown in the margin. If the circle around the H atom surprised you, perhaps it will also remind you that hydrogen has only a 1s orbital, which is spherical. You can probably see already that all the orbitals are correctly lined up for the reaction.

The hydrogen atom slides across the top face of the planar cyclopentadiene ring. We call this a suprafacial migration, meaning that the migrating group leaves from one face of the π system and rejoins that same face (the top face in this example). Antarafacial migration would mean leaving the top face and rejoining the bottom face—a clear impossibility here.

If you use the Woodward–Hoffmann rules, you need to note that the hydrogen atom must react with retention. The 1s orbital is spherically symmetrical and has no node, so wherever you draw the dotted line from that orbital it always means retention. Choosing the components is easy—the diene is a π_4 and the C–H bond a σ_2 component.

The easiest way to join them up is to link the hydrogen atom's 1s orbital to the top lobe of the p orbital at the back of the diene and the black sp^3 orbital to the top lobe at the front of the diene. This gives us π_4 and σ_2 components and there is one $(4q+2)_s$ and no $(4r)_a$ components so the sum is odd and the reaction is allowed. Both approaches give us the same picture—a suprafacial migration of the hydrogen atom with (inevitably) retention at the migrating group.

These [1,5]-sigmatropic shifts are not restricted to cyclopentadienes. In Chapter 34 we bemoaned the lack of Diels–Alder reactions using *E,Z* dienes. One reason for the shortage of examples is that such dienes undergo [1,5]H shifts rather easily and mixtures of products result.

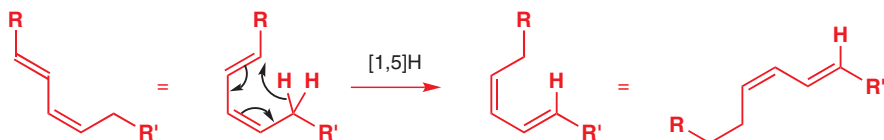

The consequences of orbital symmetry for sigmatropic hydrogen shifts are simple. In thermal reactions, [1,5]H shifts occur suprafacially but [1,3]H and [1,7]H shifts must be antarafacial. Antarafacial [1,3]H shifts are impossible, even though they are allowed, because a rigid three-carbon chain is too short to allow the H atom to transfer from the top to the bottom—the H atom just can't reach. This is just as well, as otherwise double bonds would just wander around molecules by repeated [1,3]H shifts.

When we come to [1,7]H shifts, the situation is different. Now the much longer chain is just flexible enough to allow antarafacial migration. The hydrogen atom leaves the top side of the triene and adds back in on the bottom side. The diagram shows this in orbital terms: the LUMO of hexatriene has three nodes. Antarafacial [1,7]H migration is allowed and possible.

allowed and possible antarafacial [1,7]H shift

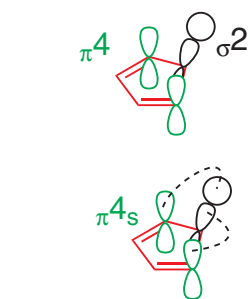
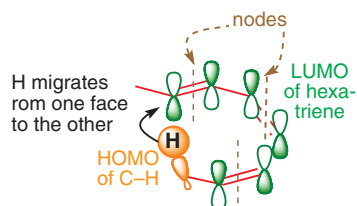
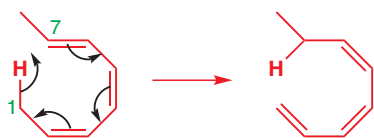

allowed but impossible antarafacial [1,3]H shift

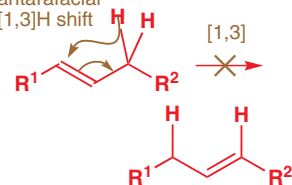

Summary of thermal sigmatropic migrations of hydrogen

	[1,3]H shift	[1,5]H shift	[1,7]H shift
stereochemistry	antarafacial	suprafacial	antarafacial
feasibility	impossible	easy	possible

Photochemical [1,*n*] H sigmatropic shifts follow the opposite rules

As you should by now expect, all this is reversed in photochemical reactions. The margin shows an example of a [1,7]H shift that cannot occur antarafacially because the molecule is a rigid ring, but that can and does occur photochemically in a suprafacial manner.

A [1,7]H shift occurs in the final stages of the human body's synthesis of vitamin D from cholesterol. Here is the last step of the biosynthesis.

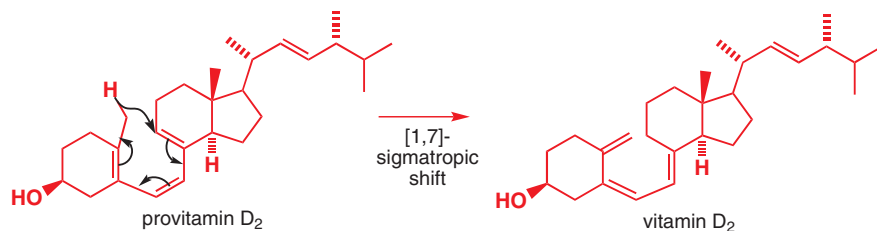

➔ The reversal of the rules of orbital symmetry when you move from thermal to photochemical reactions was described on p. 896.

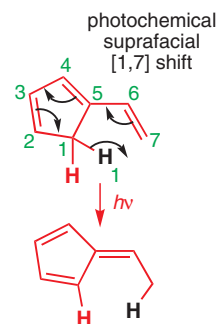

This step happens spontaneously, without the need for light, so the [1,7]H shift must be antarafacial. That's no problem in this triene system—there is enough flexibility for the hydrogen atom to migrate from the top to the bottom face.

Why, then, does the body famously need sunlight to make vitamin D? The reason is the previous step, which can only occur when light shines on the skin.

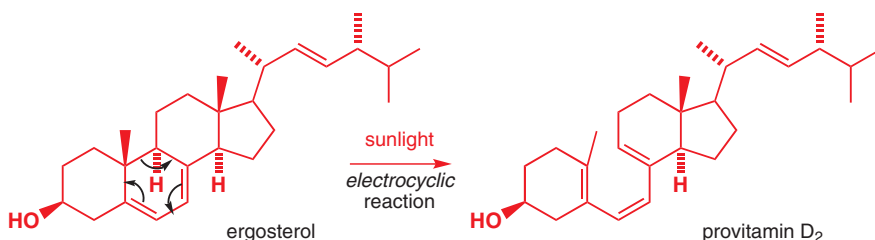

This ring opening is clearly pericyclic—the electrons go round in a ring, and the curly arrows could be drawn either way—but it is neither a cycloaddition (only one π system is involved) nor a sigmatropic rearrangement (a σ bond is broken rather than moved). It is, in fact, a member of the third and last kind of pericyclic reaction, an *electrocyclic reaction*.

Electrocyclic reactions

In an electrocyclic reaction a ring is always broken or formed. Rings may, of course, be formed by cycloadditions as well, but the difference with electrocyclic reactions is that just one new σ bond is formed (or broken) across the ends of a single conjugated π system. In a cycloaddition, two new σ bonds are always formed (or broken), and in a sigmatropic rearrangement one σ bond forms while one breaks.

- The types of pericyclic reactions are distinguished by the number of σ bonds made or broken

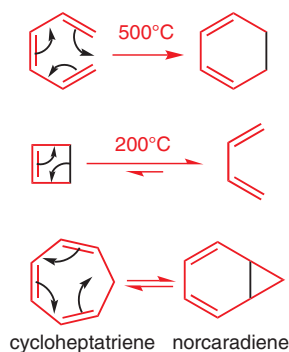
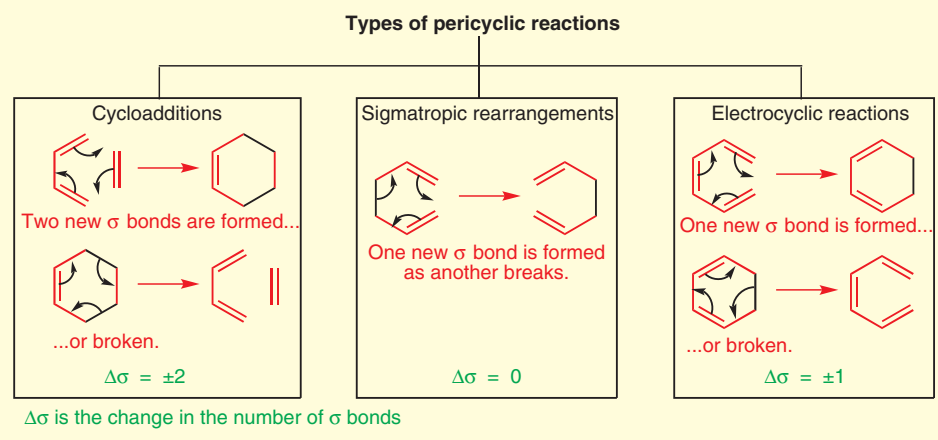

One of the simplest electrocyclic reactions occurs when hexatriene is heated to 500 °C. It is a pericyclic reaction because the electrons go round in a ring (you could equally draw the arrows going the other way); it's electrocyclic because a new σ bond is formed across the ends of a π system. The reaction goes because the σ bond that is formed is stronger than the π bond that is lost.

The opposite is true for the electrocyclic opening of cyclobutene—ring strain in the four-membered ring means that the reverse (ring-opening) reaction is preferred to ring closure.

In one famous case, the release of ring strain is almost exactly counterbalanced by the formation of a σ bond at the expense of a π bond. Cycloheptatriene exists in equilibrium with a bicyclic isomer known as norcaradiene. Usually cycloheptatriene is the major component of the equilibrium, but the norcaradiene structure is favoured with certain substitution patterns.

Rules for electrocyclic reactions

Whether they go in the direction of ring opening or ring closure, electrocyclic reactions are subject to the same rules as all other pericyclic reactions. With most of the pericyclic reactions you have seen so far, we have given you the choice of using either HOMO–LUMO reasoning or the Woodward–Hoffmann rules. With electrocyclic reactions, you really have to use the Woodward–Hoffmann rules because (at least for the ring closures) there is only one molecular orbital involved.

● Electrocyclic reactions

- An electrocyclic reaction is the formation of a new σ bond across the ends of a conjugated polyene or the reverse.

It is important that you do not confuse electrocyclic reactions with pericyclic reactions. Pericyclic is the name for the whole family of reactions involving no charged intermediates in which the electrons go round the outside of the ring. *Electrocyclic* reactions, *cycloadditions*, and *sigmatropic* rearrangements are the three main classes of *pericyclic* reactions.

Let's start with the hexatriene ring closure from the beginning of this section, first looking at the orbitals and then following the same procedure that we taught you for cycloadditions and sigmatropic rearrangements to see what the Woodward–Hoffmann rules have to say about the reaction.

Hexatriene is, of course, a 6π electron (π_6) conjugated system and, on forming cyclohexadiene, the end two orbitals must rotate through 90° to form a σ bond.

So, now for the Woodward–Hoffmann treatment.

1. Draw the mechanism for the reaction.
2. Choose the components. All the bonds taking part in the mechanism must be included and no others.
3. Make a three-dimensional drawing of the way the components come together for the reaction, putting in orbitals at the ends of the components (only!).
4. Join up the components where new bonds are to be formed. Make sure you join orbitals that are going to form new bonds.
5. Label each component s or a depending on whether new bonds are formed on the same or on opposite sides. We called this reaction 's' because the top halves of the two π orbitals join together.
6. Add up the number of $(4q + 2)_s$ and $(4r)_a$ components. If the sum is odd, the reaction is allowed. Here there is one $(4q + 2)_s$ component and no $(4r)_a$ components. Total = 1 so this is an allowed reaction.

We can give the same treatment to the cyclobutene ring-opening reaction—the Woodward–Hoffmann rules tell us nothing about which way the reaction will go, only if the reaction is allowed, and it is usually easier with electrocyclic reactions to consider the ring-closing reaction even if ring opening is favoured thermodynamically. This is the process we need to consider:

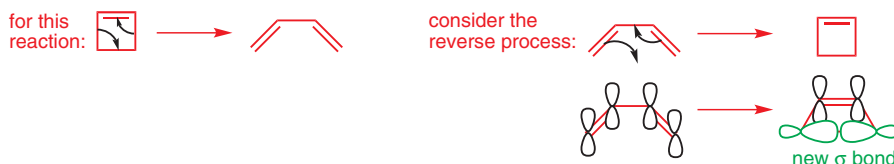

■ In the same way, the Woodward–Hoffmann rules apply both to cycloadditions and to reverse cycloadditions, as you saw in Chapter 34.

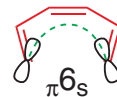
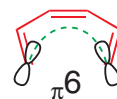
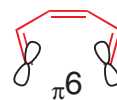
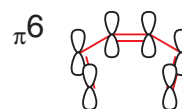
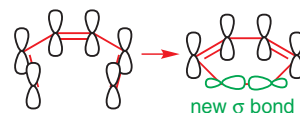

■ *Reminder.* In a thermal pericyclic reaction the total number of $(4q + 2)_s$ and $(4r)_a$ components must be odd.

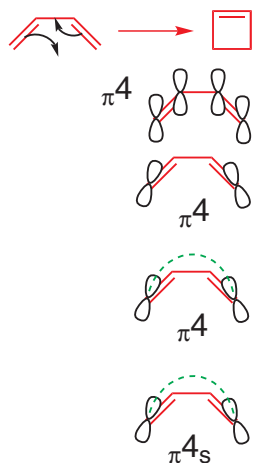

And the Woodward–Hoffmann treatment again.

1. Draw the mechanism for the reaction.
2. Choose the components. All the bonds taking part in the mechanism must be included and no others.
3. Make a three-dimensional drawing of the way the components come together for the reaction, putting in orbitals at the ends of the components (only!).
4. Join up the components where new bonds are to be formed. Make sure you join orbitals that are going to form new bonds.
5. Label each component s or a depending on whether new bonds are formed on the same or on opposite sides.
6. Add up the number of $(4q + 2)_s$ and $(4r)_a$ components. If the sum is odd, the reaction is allowed. There are no $(4q + 2)_s$ components and no $(4r)_a$ components. Total = 0 so this is a disallowed reaction.

Oh dear! We know that the reaction works, so something must be wrong. It certainly isn't Woodward and Hoffmann's Nobel-prize-winning rules—it's our way of drawing the orbital overlap that is at fault. We were fine up to stage 3 (we had no choice till then)—but see what happens if we make the orbitals overlap in a different way.

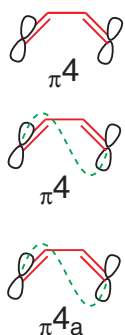

1. As before.
2. As before.
3. Make a three-dimensional drawing of the way in which the components come together for the reaction, putting in orbitals at the ends of the components (only!).
4. Join up the components where new bonds are to be formed. Make sure you join orbitals that are going to form new bonds.
5. Label each component s or a depending on whether new bonds are formed on the same or on opposite sides.
6. Add up the number of $(4q + 2)_s$ and $(4r)_a$ components. If the sum is odd, the reaction is allowed. There are no $(4q + 2)_s$ components and one $(4r)_a$ component. Total = 1 so this is an allowed reaction.

Now it works! In fact, extension of this reasoning to other electrocyclic reactions tells you that they are *all* allowed—provided you choose to make the conjugated system react with itself suprafacially for $(4n + 2) \pi$ systems and antarafacially for $(4n) \pi$ systems. This may not seem particularly informative, since how you draw the dotted line has no effect on the reaction product in these cases. But it can make a difference. Here is the electrocyclic ring closure of an octatriene, showing the product from (a) suprafacial reaction and (b) antarafacial reaction.

■ The green arrows in this and subsequent diagrams are merely mechanical devices to show the way in which the substituents move. They are nothing to do with real mechanistic curly arrows.

 Interactive mechanism for disrotatory ring closure of hexatrienes

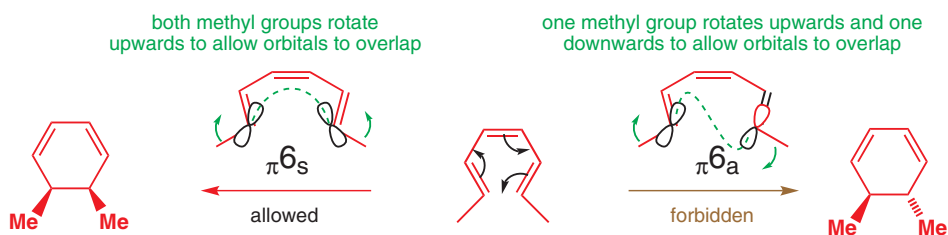

Conrotatory and disrotatory reactions

Whether the reaction is supra- or antarafacial ought to be reflected in the relative stereochemistry of the cyclized products—and indeed it is. The reaction above gives solely the diastereoisomer on the left, with the methyl groups *syn*—clear proof that the reaction is suprafacial. This is a difficult result to explain without the enlightenment provided by the Woodward–Hoffmann rules! This electrocyclic cyclobutene ring opening also gives the product as a single stereoisomer.

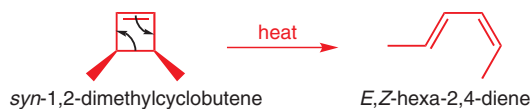

Again, if we draw the reverse reaction, we can see that the reaction required has to be antarafacial for the stereochemistry to be right.

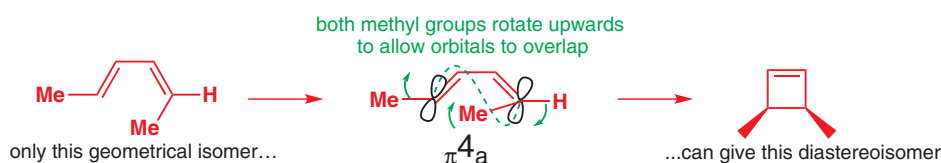

We have drawn little green arrows on the diagrams to show how the methyl groups move as the new σ bonds form. For the allowed suprafacial reaction of the 6π electron system they rotate in opposite directions so the reaction is called **disrotatory** (yes, they both go up, but one has to rotate clockwise and one anticlockwise) while for the allowed antarafacial reaction of the 4π electron system they rotate in the same direction so the reaction is called **conrotatory** (both clockwise as drawn, but they might equally well have both gone anticlockwise). We can sum up the course of all electrocyclic reactions quite simply using these words.

● Rules for electrocyclic reactions

- All electrocyclic reactions are allowed.
- Thermal electrocyclic reactions involving $(4n + 2)$ π electrons are *disrotatory*.
- Thermal electrocyclic reactions involving $(4n)$ π electrons are *conrotatory*.
- In *conrotatory* reactions the two groups rotate in the *same* turning sense: *both* clockwise or *both* anticlockwise.
- In *disrotatory* reactions, *one* group rotates *clockwise* and *one* anticlockwise.

This rotation is the reason why you must carefully distinguish electrocyclic reactions from all other pericyclic reactions. In cycloadditions and sigmatropic rearrangements there are small rotations as bond angles adjust from 109° to 120° and vice versa, but in electrocyclic reactions rotations of nearly 90° are required as a planar polyene becomes a ring or vice versa. These rules follow directly from application of the Woodward–Hoffmann rules—you can check this for yourself.

Electrocyclic reactions in nature: the endiandric acids

A beautiful example of electrocyclic reactions at work is provided by the chemistry of the endiandric acids. This family of natural products, of which endiandric acid D is one of the simplest, is remarkable in being racemic—most chiral natural products are enantiomerically pure (or at least enantiomerically enriched) because they are made by enantiomerically pure enzymes (we discuss all this in Chapter 42). So it seemed that the endiandric acids were formed by non-enzymatic cyclization reactions, and in the early 1980s their Australian discoverer, Black, proposed that their biosynthesis might involve a series of electrocyclic reactions, starting from an acyclic polyene precursor.

Interactive mechanism for conrotatory opening of cyclobutenes

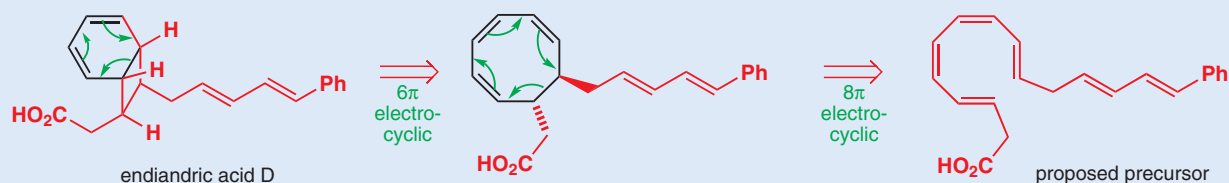

What made his proposal so convincing was that the stereochemistry of the endiandric acid D is just what you would expect from the requirements of the

Woodward–Hoffmann rules. The first step from the precursor is an 8π electrocyclic reaction, and would therefore be conrotatory.

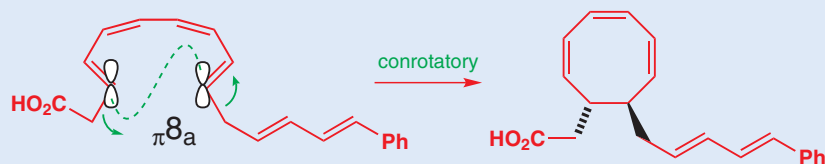

This sets up a new 6π system, which can undergo an electrocyclic reaction in disrotatory fashion. Because there are already chiral centres in the molecule, there are, in fact, two possible diastereoisomeric products from this reaction,

both arising from disrotatory cyclization. One is endiandric acid D; one is endiandric acid E.

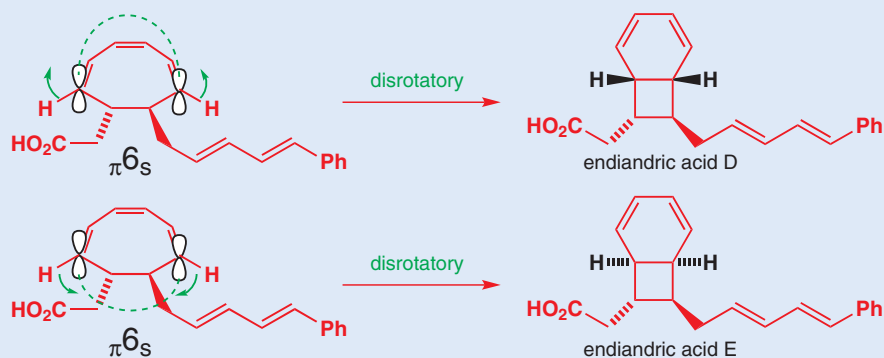

Of course, this was only a hypothesis—until in 1982 K.C. Nicolaou's group synthesized the proposed endiandric acid precursor polyene—and in one step made both endiandric acids D and E, plus endiandric acid A, which arises from a further pericyclic reaction—an intramolecular Diels–Alder cycloaddi-

tion of the acyclic diene on to the cyclohexadiene as dienophile. Endiandric acid A has four rings and eight stereogenic centres, and yet a series of pericyclic reactions produce it in one step from an acyclic polyene!

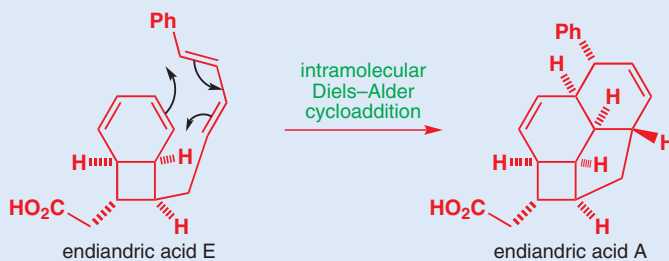

Photochemical electrocyclic reactions

After your experience with cycloadditions and sigmatropic rearrangements, you will not be surprised to learn that, in photochemical electrocyclic reactions, the rules regarding conrotatory and disrotatory cyclizations are reversed.

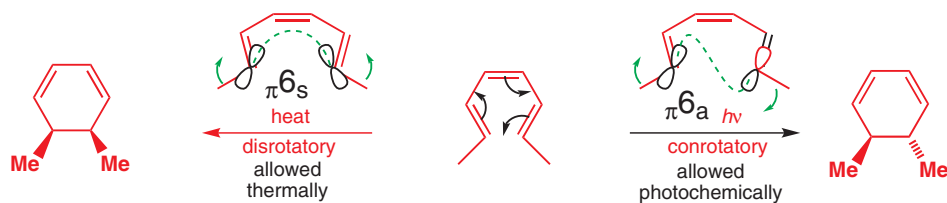

We can now go back to the reaction that introduced this section—the photochemical electrocyclic ring opening of ergosterol to give provitamin D₂. By looking at the starting material and product we can deduce whether the reaction is conrotatory or disrotatory.

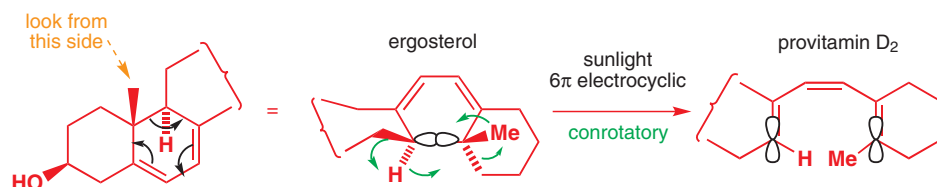

It's clearly conrotatory, and a little more thought will tell you why it has to be—a disrotatory thermal 6 π cyclization would put an impossible *trans* double bond into one of the two six-membered rings. Vitamin D deficiency is endemic in those parts of the world where sunlight is scarce for many months of the year—and all because of orbital symmetry.

Cations and anions

What we have just been telling you should convince you that the two reactions below are electrocyclic reactions, not least because the stereochemistry reverses on going from thermal to photochemical reaction.

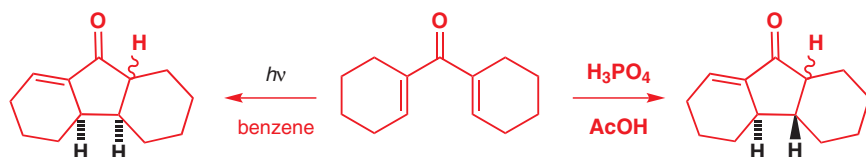

They are examples of what is known, after its Russian discoverer, as the Nazarov cyclization. In its simplest form, the Nazarov cyclization is the ring closure of a doubly α,β -unsaturated ketone to give a cyclopentenone. Nazarov cyclizations require acid, and protonation of the ketone sets up the conjugated π system required for an electrocyclic reaction.

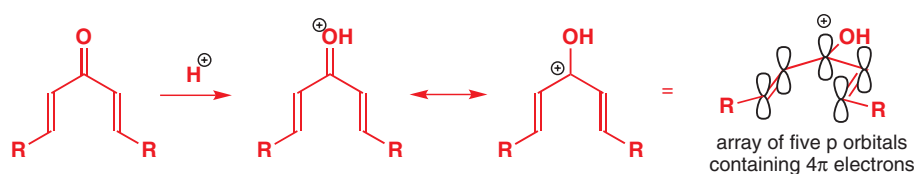

One of the five π orbitals involved is empty—so the cyclization is a 4 π electrocyclic reaction, and the orbitals forming the new σ bond must interact antarafacially. Loss of a proton and tautomerism gives the cyclopentenone.

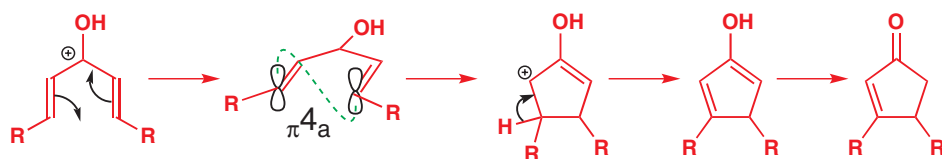

The example below confirms that the reaction is thermally conrotatory and photochemically disrotatory.

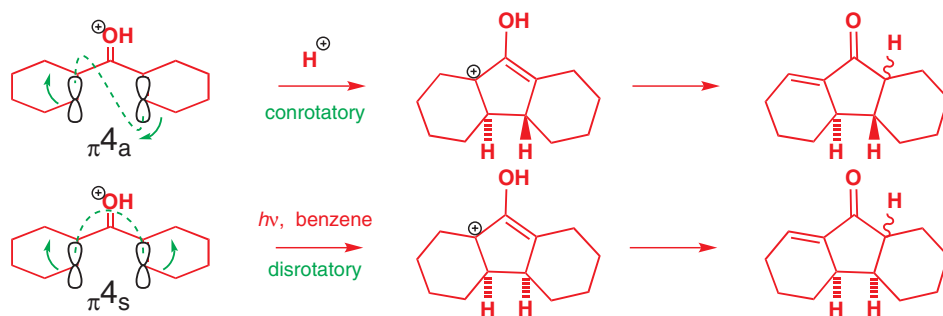

Dienyl cations and dienyl anions both undergo electrocyclic ring closure—a nice example occurs when this cyclooctadiene is deprotonated with butyllithium. There are still five p orbitals involved in the cyclization, but now there are six π electrons, so the reaction is disrotatory.

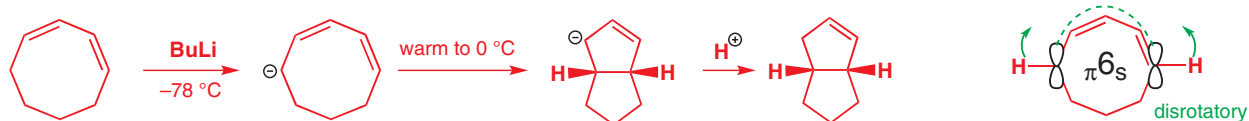

In this case, it is the conrotatory *photochemical* cyclization that is prevented by strain (it was tried—cyclooctadienyl anion is stable for at least a week at $-78\text{ }^\circ\text{C}$ in broad daylight) as the product would be a 5,5-*trans*-fused system. The same strain prevents thermal electrocyclic ring closure of cyclooctadienyl *cations*.

• All electrocyclic reactions are allowed

It would be a good point here to remind you that, although all electrocyclic reactions are allowed both thermally and photochemically providing the rotation is right, the steric requirements for con- or disrotatory cyclization or ring opening may make one or both modes impossible.

Small rings are opened by electrocyclic reactions

➔ You saw allyl cations as intermediates in substitution reactions in Chapters 15 and 24.

Ring strain is important in preventing a reaction that would otherwise change your view of a lot of the chemistry you know. Allyl cations are conjugated systems containing 2π electrons, so if you knew no other chemistry than what is in this chapter you might expect them to cyclize via disrotatory electrocyclic ring closure. The product would be a cyclopropyl cation.



In fact, it is the cyclopropyl cations that undergo this reaction (very readily indeed—cyclopropyl cations are virtually unobservable) because ring strain encourages them to undergo electrocyclic ring opening to give allyl cations. The instability of cyclopropyl cations means that, even as they start to form as intermediates, they spring open to give allyl cation-derived products. Try nucleophilic substitution on a cyclopropane ring and this happens.

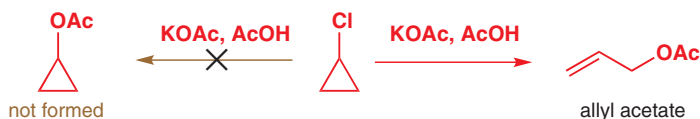

Electrocyclic ring opening of one type of three-membered ring tells us about the stereochemistry of the process. Many aziridines are stable compounds, but those bearing electron-withdrawing groups are unstable with respect to electrocyclic ring opening. The products are azomethine ylids and can be trapped by [3 + 2] cycloaddition reactions with dipolarophiles.

➔ You met 1,3-dipolar cycloadditions in Chapter 34, see p. 901.

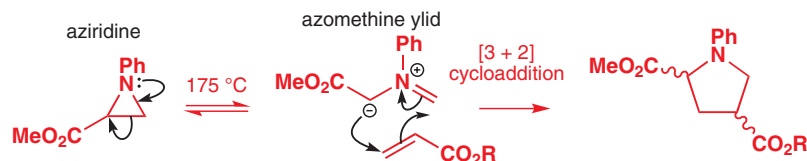

Because the cycloaddition is stereospecific (suprafacial on both components), the stereochemistry of the products can tell us the stereochemistry of the intermediate ylid, and confirms that the ring opening is conrotatory (the ylid is a 4π electron system).

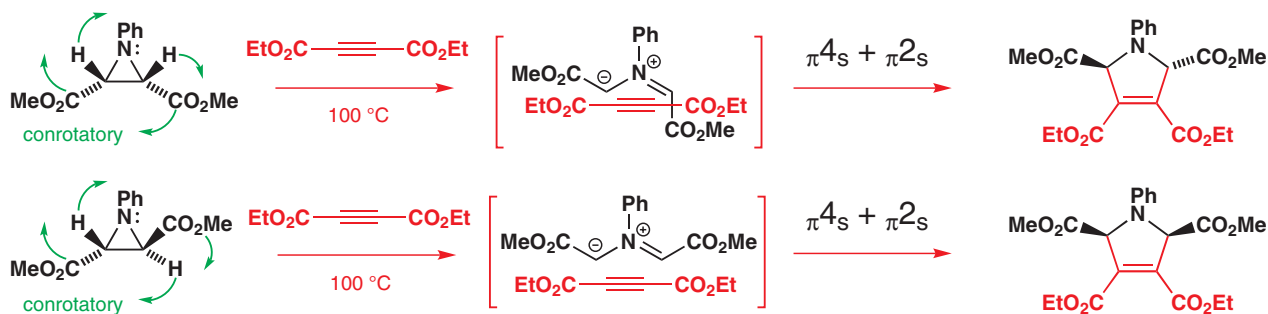

The synthesis of a cockroach pheromone using pericyclic reactions

We finish this pair of chapters about pericyclic reactions with a synthesis whose simplicity is outclassed only by its elegance. Periplanone B is a remarkable bis-epoxide that functions as the sex pheromone of the American cockroach. Insect sex pheromones often have economic importance because they can form the key to remarkably effective traps for insect pests.

In 1984, Schreiber published a synthesis of the pheromone in which the majority of steps involve pericyclic reactions. Make sure you understand each one as it appears—re-read the appropriate part of Chapter 34 or this chapter if you have any problems. The first step is a photochemical [2 + 2] cycloaddition. You could not have predicted the regiochemistry, but it is typical of the cycloaddition of allenes with unsaturated ketones.

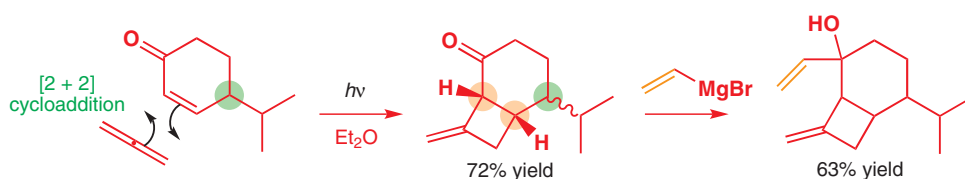
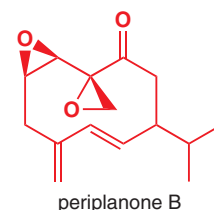

The product is a mixture of diastereoisomers because of the chiral centre already in the molecule (ringed in green), but it is, of course, fully stereospecific for the two new orange chiral centres in the four-membered ring. The next step adds vinylmagnesium bromide to the ketone—again a mixture of diastereoisomers results.

All the carbon atoms in the 12-membered ring are now present, and they are sorted out by the two steps that follow. The first is a Cope rearrangement: a [3,3]-sigmatropic rearrangement, accelerated as we have described (p. 914) by the presence of an alkoxide substituent.

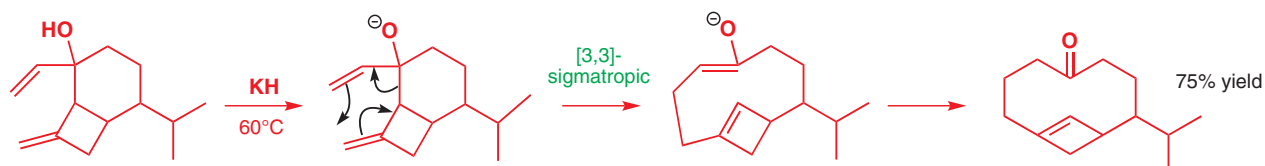

■ There are two things to note here—firstly the geometry of the double bond is nothing to do with whether the reaction is conrotatory or disrotatory. As you know this 4π electron electrocyclic ring opening must be conrotatory but as there is no substituent on the other end of the diene product we can't tell. Secondly notice that in this 12-membered ring a *trans* double bond is not only possible but probably preferred. We introduced irradiation as a means of interconverting double bond isomers in Chapter 27.

The six-membered ring has expanded to a ten-membered ring. Now for a second ring-expansion step—heating the compound to 175 °C makes it undergo electrocyclic ring opening of the four-membered ring, giving the 12-membered ring we want. Or rather not quite—the new double bond in the ring is formed as a mixture of *cis* and *trans* isomers, but irradiation isomerizes the less stable *cis* to the more stable *trans* double bond.

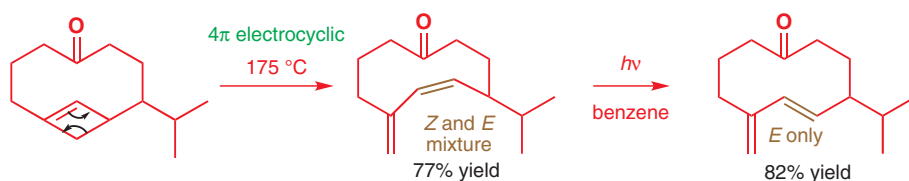

The remaining steps in the synthesis involve the insertion of another *Z* alkene and two epoxides. Pericyclic reactions are particularly valuable in the synthesis and manipulation of rings.

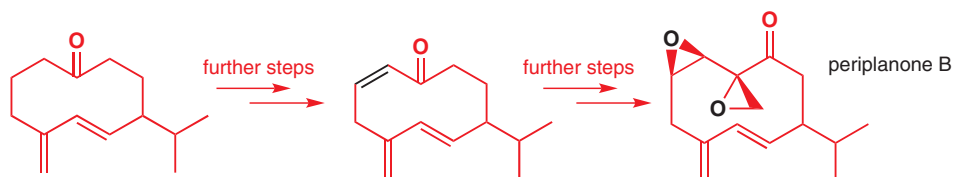

We must now take our leave of this trio of pericyclic reactions and move on to two reaction classes that have appeared frequently in these two chapters, but that also involve mechanisms other than pericyclic ones and deserve a chapter of their own: *rearrangements* and *fragmentations*.

Further reading

For explanations of pericyclic reactions and other reactions, using the full molecular orbital treatment, consult: Ian Fleming, *Molecular Orbitals and Organic Chemical Reactions, Student Edition*, Wiley, Chichester 2009. There is also a more comprehensive edition intended for practicing chemists, called the *Library Edition*. He has also written an Oxford Primer: *Pericyclic Reactions*, OUP, Oxford, 1999.

For a comprehensive treatment of sigmatropic and electrocyclic reactions in the synthesis of nitrogen heterocycles, see P. Wyatt and S. Warren, *Organic Synthesis: Strategy and Control*, Wiley, Chichester, 2007, chapter 34.

The synthesis of periplanone appears in S. L. Schreiber and C. Santini, *J. Am. Chem. Soc.*, 1984, **106**, 4038.

Check your understanding



To check that you have mastered the concepts presented in this chapter, attempt the problems that are available in the book's Online Resource Centre at <http://www.oxfordtextbooks.co.uk/orc/clayden2e/>

Participation, rearrangement, and fragmentation

36

Connections

➔ Building on

- Nucleophilic substitution at saturated carbon [ch15](#)
- Conformational analysis [ch16](#)
- Elimination reactions [ch17](#)
- Electrophilic aromatic substitution [ch21](#)
- Controlling stereochemistry [ch14](#), [ch32](#), & [ch33](#)
- Main group chemistry [ch27](#)
- Stereoelectronics [ch31](#)
- Sigmatropic rearrangements [ch35](#)

Arriving at

- Participation: nucleophiles that are already part of the molecule
- Participation may mean rearrangement
- Participating groups can have lone pairs or π electrons
- Carbocations often rearrange by alkyl migration
- How to work out the mechanism of a rearrangement
- Ring expansion by rearrangement
- Using rearrangements in synthesis
- Insertion of O, N, or C next to a ketone
- How fragmentation splits molecules into three pieces by C–C bond cleavage
- Controlling rearrangements and fragmentations
- Control of fragmentations by stereochemistry

➔ Looking forward to

- Carbene chemistry [ch38](#)
- Determination of mechanism [ch39](#)
- The chemistry of life [ch42](#)

The last two chapters introduced **pericyclic reactions**, and the next one will cover reactions of **radicals**. Together with the **ionic reactions** which have been the subject of most of this book, these three classes cover all organic mechanisms. But before we move on to consider radicals, we need to fill a gap in our coverage of ionic reactions. You have met the most important types of ionic reactions—additions, substitutions, and eliminations. But two remain and they are closely related. In **rearrangements** the molecule changes its carbon skeleton and in **fragmentations** the carbon skeleton splits into pieces. We lead up to these types of reaction by looking at a phenomenon known as **participation**.

Neighbouring groups can accelerate substitution reactions

Compare the rates of the following substitution reactions. Each is a substitution of the leaving group (OTs or Cl) by solvent, known as a solvolysis.

■ A solvolysis was defined in Chapter 15 as 'a reaction in which the solvent is also the nucleophile'.

Online support. The icon  in the margin indicates that accompanying interactive resources are provided online to help your understanding: just type www.chemtube3d.com/clayden/123 into your browser, replacing **123** with the number of the page where you see the icon. For pages linking to more than one resource, type **123-1**, **123-2** etc. (replacing **123** with the page number) for access to successive links.

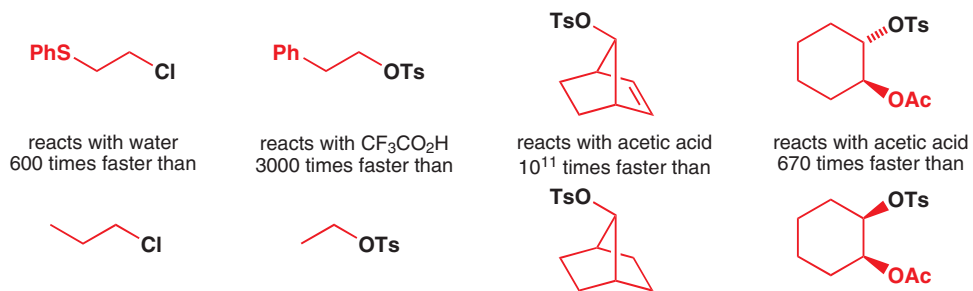

Nearby groups can evidently increase the rate of substitution reactions significantly. Now, you may be thinking back to Chapter 15 and saying ‘yes, yes, we know that’—when we were discussing the mechanisms of substitution reactions we pointed out that a cation-stabilizing group at the reaction centre makes S_N1 reactions very fast, for example:

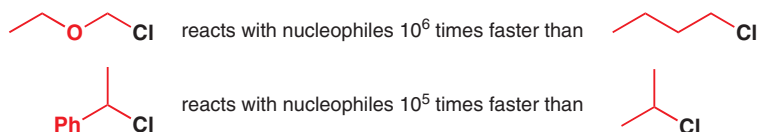

In the four examples above, though, it is not at the reaction centre itself that the functional groups change but at the carbon *next* to the reaction centre, and we call these groups *neighbouring groups*. The mechanism by which they speed up the reactions is known as *neighbouring group participation*. Compare the reaction of this ether and this sulfide with an alcohol.

■ Neighbouring group participation is occasionally called **anchimeric assistance** (Greek *anchi* = neighbouring; *mer* = part).

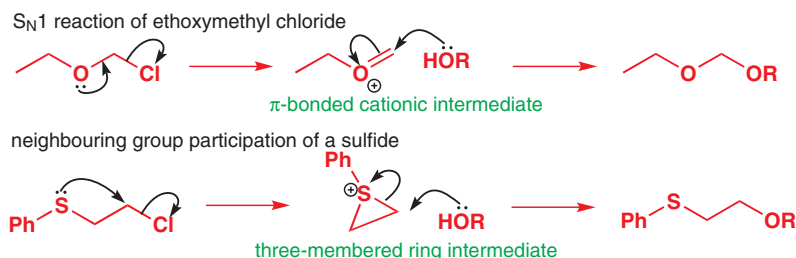

In both cases, ionization of the starting material is assisted by the lone pair of an electron-rich functional group. The ether in the first example assists by forming a π bond, the sulfide assists by forming a σ bond in a three-membered ring, and a common feature of all mechanisms involving neighbouring group participation is the formation of a cyclic intermediate.

Stereochemistry can indicate neighbouring group participation

How do we know that neighbouring group participation is taking place? Well, the first bit of evidence is the *increase in rate*. The neighbouring groups become involved only if they can increase the rate of the substitution reaction—otherwise the mechanism will just follow the ordinary S_N2 pathway. But more important information comes from reactions where stereochemistry is involved, and one of these is the last of the four examples at the start of the chapter. Here it is again in more detail. Not only does the first of these reactions go faster than the second—its stereochemical course is different too.

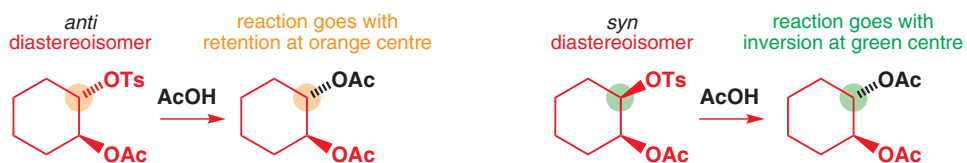

Although one starting material has *syn* and the other *anti* stereochemistry, the products have the same (*anti*) stereochemistry one substitution goes with retention and one goes with

inversion. Again, neighbouring group participation is the reason. To explain this, we should first draw the six-membered rings in their real conformation. For the *anti* compound, both substituents can be equatorial. However, not much can happen in this conformation—but, if we allow the ring to flip, you can see immediately that the acetate substituent is ideally placed to participate in the departure of the tosylate group.

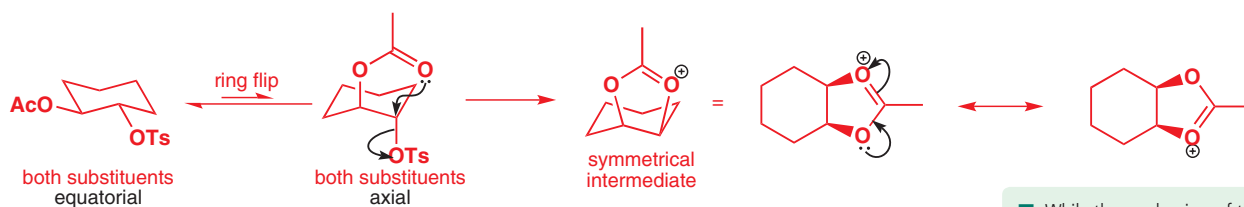

What results is an entirely symmetrical intermediate—the positive charge on one of the oxygens is, of course, delocalized over both of them. The intramolecular S_N2 reaction takes place with inversion, as required by the orbitals, so now the junction of the two rings is *cis*.

The next step is attack of acetic acid on the intermediate. This is another S_N2 reaction, which also proceeds with inversion and gives back a *trans* product.

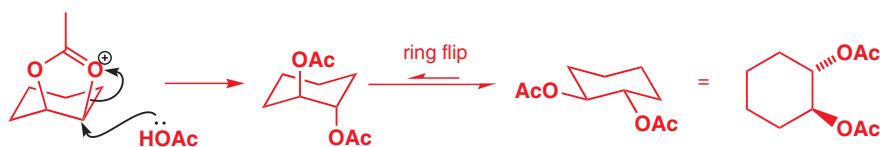

Overall, we have *retention* of stereochemistry. As you know, S_N2 reactions go with inversion and S_N1 reactions with loss of stereochemical information, so this result is possible only if we have two sequential S_N2 reactions taking place—in other words neighbouring group participation.

Why, then, does the other diastereoisomer react with inversion of stereochemistry? Well, try drawing the mechanism for intramolecular displacement of the tosyl group. Whether you put the tosylate or the acetate group equatorial doesn't matter; there is no way in which the acetate oxygen's lone pair can reach the σ^* orbital of the tosylate C–O bond.

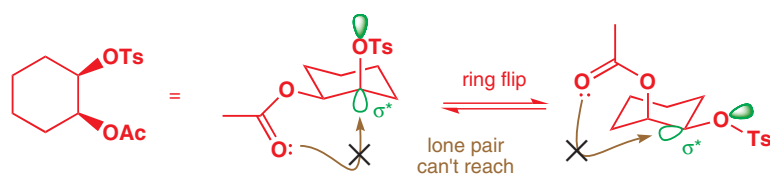

Neighbouring group participation is impossible, and substitution goes simply by intermolecular displacement of OTs by AcOH. Just one S_N2 step means overall inversion of configuration, and no participation means a slower reaction.

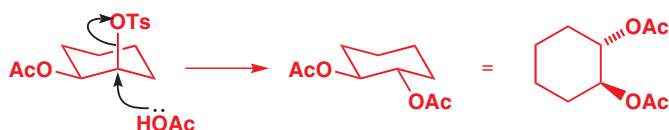

Retention of configuration is an indication of neighbouring group participation

Enantiomerically pure (*R*)-2-bromopropanoic acid reacts with concentrated sodium hydroxide to give (*S*)-lactic acid. The reaction goes with inversion and is a typical S_N2 reaction—and a good one too, since the reaction centre is adjacent to a carbonyl group (see Chapter 15). If, on the other hand, the reaction is run using Ag_2O and a low concentration of sodium hydroxide, (*R*)-lactic acid is obtained—there is overall *retention* of stereochemistry.

➔ If you are unsure what we are talking about, go back and read Chapter 16 now!

■ While the mechanism of this first step of the substitution reaction is S_N2 in appearance—a nucleophile (the acetate group) arrives just as a leaving group (the tosylate group) departs—it is also, of course, only unimolecular.

🔗 Interactive mechanism for unexpected retention of stereochemistry

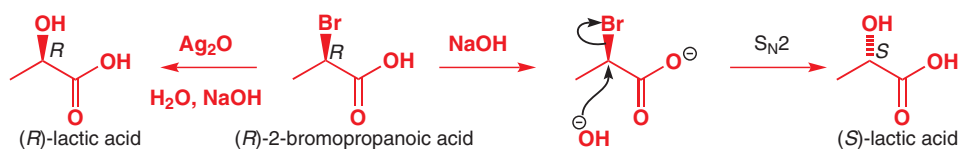

■ Lactones (that is, cyclic esters) don't usually react with hydroxide by this mechanism, and you might expect this intermediate (which is a cyclic ester) to hydrolyse by attack of hydroxide at the C=O group. You might like to think about why this doesn't happen in this case.

Nucleophilic substitution reactions that go with retention of stereochemistry are rather rare and mostly go through two successive inversions with neighbouring group participation, like the example you saw in the last section. This time the neighbouring group is carboxylate: the silver oxide is important because it encourages the ionization of the starting material by acting as a halogen-selective Lewis acid. A three-membered ring intermediate forms, which then gets opened by hydroxide in a second S_N2 step.

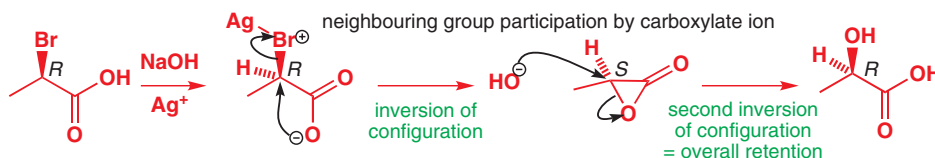

Interactive mechanism for α -lactone formation

● Retention suggests participation

If you see a substitution reaction at a stereogenic saturated carbon atom that goes with retention of stereochemistry, look for neighbouring group participation!

Why does the carboxylate group participate only at low HO⁻ concentration and in the presence of Ag⁺? You can think of the situation in these two reactions in terms of the factors that favour S_N1 and S_N2 reactions. In the first, we have conditions suited to an S_N2 reaction: a very good nucleophile (HO⁻) and a good leaving group (Br⁻). Improve the leaving group by adding Ag⁺ (Ag⁺ assists Br⁻'s departure much as H⁺ assists the departure of OH⁻ by allowing it to leave as H₂O) and worsen the nucleophile (H₂O instead of HO⁻, of which there is now only a low concentration), and we have the sorts of conditions that *would* favour an S_N1 reaction. The trouble is, without neighbouring group participation, the cation here would be rather unstable—right next to a carbonyl group. The carboxylate saves the day by participating in the departure of the Br⁻ and forming the lactone. The key thing to remember is that a reaction always goes by the mechanism with the fastest rate.

● Neighbouring groups participate only if they speed up the reaction.

What sorts of groups can participate?

You've already met the most important ones—sulfides, esters, carboxylates. Ethers and amines (you will see some of these shortly) can also assist substitution reactions through neighbouring group participation. The important thing that they have in common is an electron-rich heteroatom with a lone pair that can be used to form the cyclic intermediate. Sulfides are rather better than ethers—this sulfide reacts with water much faster than *n*-PrCl but the ether reacts with acetic acid four times more slowly than *n*-PrOSO₂Ar.

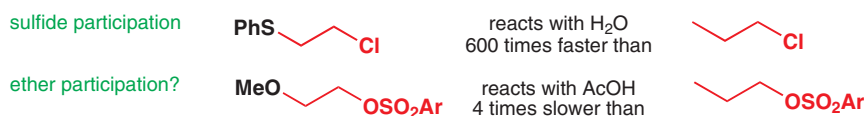

The OMe group slows the reaction down just because it is electronegative more than it accelerates it by participation. A more distant OMe group can participate: this 4-MeO alkyl sulfonate reacts with alcohols 4000 times faster than the *n*-Bu sulfonate.

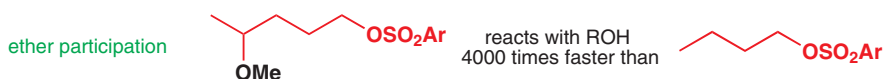

Again neighbouring group participation is involved, but this time through a five- rather than a three-membered ring. Participation is most commonly through three- and five-membered rings, less often six-membered ones, and very rarely four- or more than seven-membered ones.

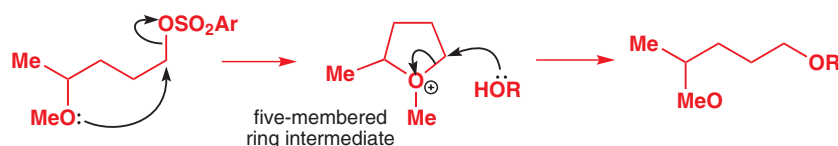

■ Why these ring sizes? Well, the underlying reasons are the same as those we discussed in Chapter 31 when we talked about the kinetics (rates) of formation and thermodynamics (stability) of different ring sizes: three- and five-membered rings form particularly rapidly in any reaction.

Mustard gas

Participation of sulfides through three-membered rings was used to gruesome effect in the development of mustard gas during the Second World War. Mustard gas itself owes its toxicity to the neighbouring group participation of sulfur, which accelerates its alkylation reactions.

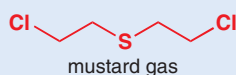

Not all participating groups have lone pairs

Another of the four examples we started with shows that even the π electrons of a $C=C$ double bond can participate. Retention of stereochemistry in the product (the starting tosylate and product acetate are both *anti* to the double bond) and the extremely fast reaction (10^{11} times that of the saturated analogue) are tell-tale signs of neighbouring group participation.

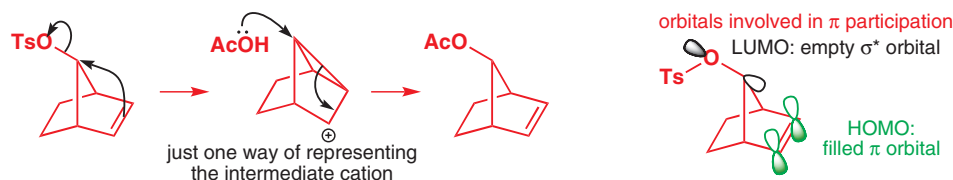

What is the structure of the intermediate?

During the 1950s and 1960s, this sort of question provoked a prolonged and acrimonious debate, which we have no intention of stirring up, and all we will do is point out that the intermediate in this reaction is not fully represented by the structure we have here: it is symmetrical and could be represented by two structures with three-membered rings or by a delocalized structure in which two electrons are shared between three atoms. The difference need not concern us.



Finally, an example with a neighbouring phenyl group. Participation is suggested by the retention of relative stereochemistry.

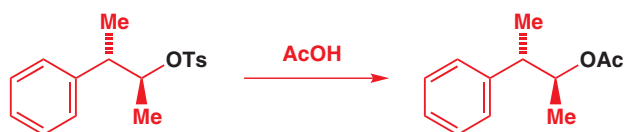

Again, π electrons are involved, but the reaction is now electrophilic aromatic substitution (Chapter 21) rather like an intramolecular Friedel–Crafts alkylation with a delocalized intermediate often termed a phenonium ion.

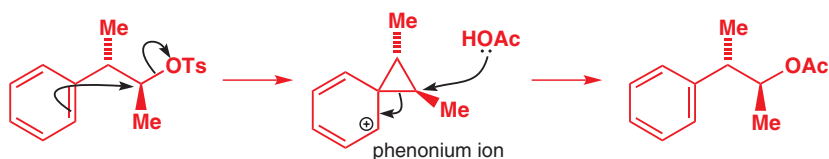
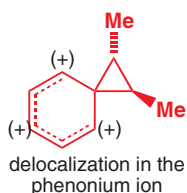

More stereochemical consequences of neighbouring group participation

The phenonium ion is symmetrical. The acetic acid can attack either atom in the three-membered ring to give the same product.

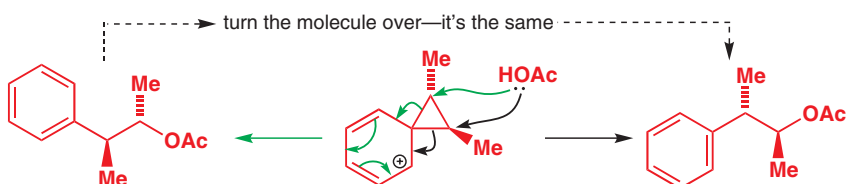

The phenonium ion is nonetheless still chiral, since it has an axis (and not a plane or centre) of symmetry, so if we use an enantiomerically pure starting material we get an enantiomerically pure product.

from this enantiomer of tosylate . . . we get this phenonium ion . . . and this enantiomer of product
whichever end the acid attacks

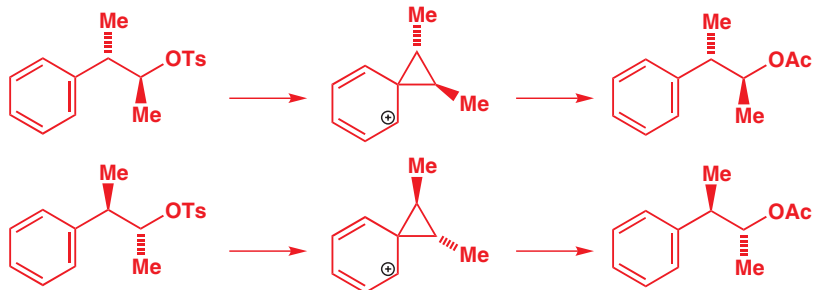

Not so with the other diastereoisomer of this compound! Now, the phenonium ion is symmetrical with a plane of symmetry—it is therefore achiral, and the same whichever enantiomer we start from. Attack on each end of the phenonium ion gives a different enantiomer, so whichever enantiomer of starting material we use we get the same racemic mixture of products. You can compare this reaction with the loss of stereochemical information that occurs during an S_N1 reaction of enantiomerically pure compounds. Both reactions pass through an achiral intermediate.

from either enantiomer . . . we get the same achiral phenonium ion . . . and therefore racemic product

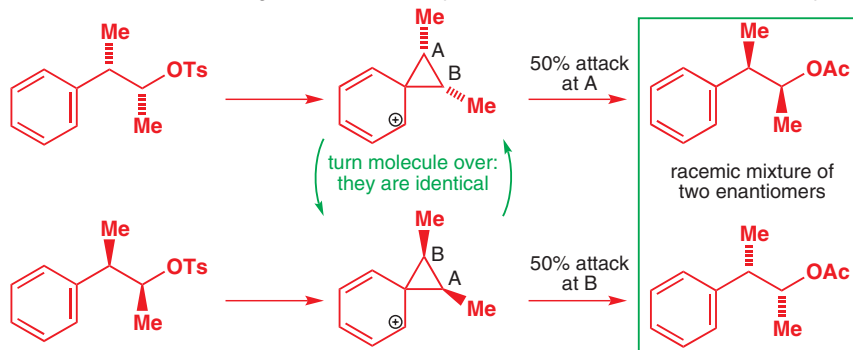

There is a subtlety here that you should not overlook and that makes this study, which was carried out by Cram in 1949, exceedingly elegant. Reactions of both of these diastereoisomers are stereospecific: the *relative* stereochemistry of the products depends on the *relative* stereochemistry of the starting materials. Yet, while the absolute stereochemistry of the starting materials is retained in one case (we get a single enantiomer of a single diastereoisomer), it is lost in the other (we get a racemic mixture of both enantiomers of a single diastereoisomer). These are important distinctions, and if you are in any doubt about these terms, re-read Chapters 14 and 33. Donald Cram (1919–2001) of UCLA was awarded the Nobel prize in 1987 jointly with Jean-Marie Lehn (1939–) of Strasbourg and Paris, and Charles Pedersen (a Norwegian born in Korea in 1904) of DuPont for 'their development and use of molecules with structure-specific interactions of high selectivity'.

The same loss of absolute stereochemical information (but retention of relative stereochemistry) occurs in another reaction that you met at the start of this chapter. We then emphasized two features: the acceleration in rate and the retention of stereochemistry.

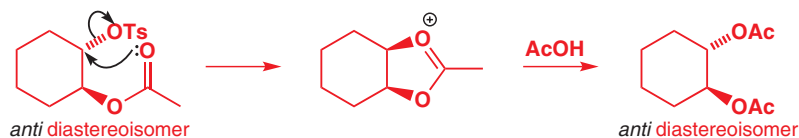

The intermediate oxonium ion is delocalized and achiral. If a single enantiomer of the starting material is used, racemic product is formed through this achiral intermediate. Attack at one carbon atom gives one enantiomer; attack at the other gives the mirror image.

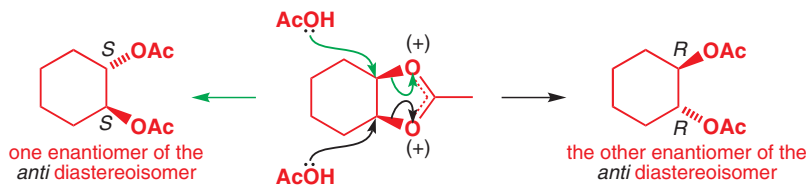

In this case the neighbouring group can be caught in the act—when the rearrangement is carried out in ethanol, the intermediate is trapped by attack at the central carbon atom. It is as though someone switched the light on while the acetate's fingers were in the biscuit tin. The product is an orthoester and is achiral too. This chemistry should remind you of the formation of acetals, as described in Chapter 11.

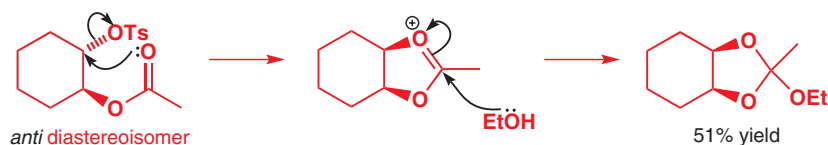

Rearrangements occur when a participating group ends up bonded to a different atom

Because the intermediates in these examples are symmetrical, 50% of the time one substituent ends up moving from one carbon atom to another during the reaction. This is clearer in the following example: the starting material is prepared such that the carbon atom carrying the phenyl group is an unusual isotope—carbon-14. This doesn't affect the chemistry, but means that the two carbon atoms are easily distinguishable. Reacting the compound with trifluoroacetic acid scrambles the label between the two positions: the intermediate is symmetrical and, in the 50% of reactions with the nucleophile that take place at the labelled carbon atom, the phenyl ends up migrating to the unlabelled carbon atom in a rearrangement reaction.

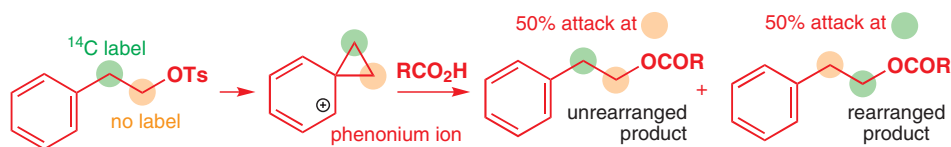

Now, consider this substitution reaction, in which OH replaces Cl but with a change in the molecular structure. The substitution goes with complete rearrangement—the amine ends up attached to a different carbon atom. We can easily see why if we look at the mechanism. The reaction starts off looking like a neighbouring group participation of the sort you are now familiar with (the carbon atoms are numbered for identification).

■ Labelling an atom with an unusual isotope is a standard way to probe the details of a reaction. Radioactive ^3H (tritium) or ^{14}C used to be used but, with the advent of high-field NMR, non-radioactive ^2H (deuterium) and ^{13}C are more versatile and less hazardous. These methods are examined more thoroughly in Chapter 39.



The intermediate is an aziridinium ion (aziridines are three-membered rings containing nitrogen—the nitrogen analogues of epoxides). The hydroxide ion chooses to attack only the less hindered terminal carbon 1, and a rearrangement results—the amine has migrated from carbon 1 to carbon 2.

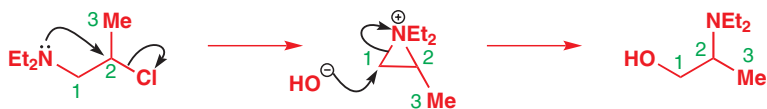

Interactive mechanism for migration of participating group

We should just pause here for a moment to consider why this rearrangement works. We start with a secondary alkyl chloride that contains a very bad leaving group (Et_2N) and a good one (Cl^-)—but the good one is hard for HO^- to displace because it is at a secondary centre (remember—secondary alkyl halides are slow to react by $\text{S}_{\text{N}}1$ or $\text{S}_{\text{N}}2$). But the NEt_2 can participate to make an aziridinium intermediate—now there is a good leaving group (RNEt_2 without the negative charge) at the primary as well as the secondary carbon, so HO^- does a fast $\text{S}_{\text{N}}2$ reaction at the primary carbon.

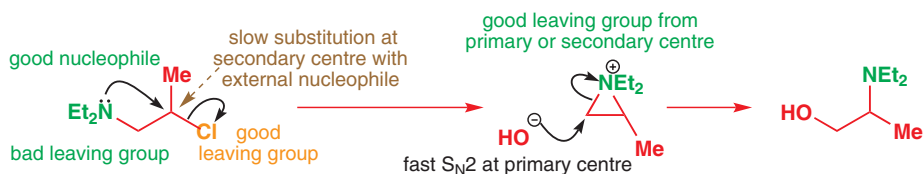

Another way to look at this reaction is to see that the good internal nucleophile Et_2N will compete successfully for the electrophile with the external nucleophile HO^- . Intramolecular reactions are usually faster than bimolecular reactions.

- Intramolecular reactions (including participation of a neighbouring group) that give three-, five-, or six-membered rings are usually faster than intermolecular reactions.

The Payne rearrangement

The reaction of an epoxy alcohol in base does not always give the expected product.

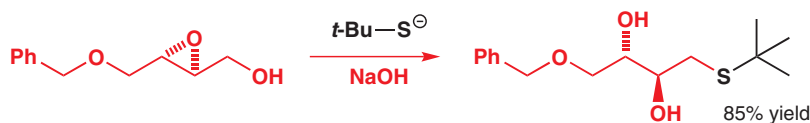

The thiolate nucleophile has not opened the epoxide directly, but instead *appears* to have displaced HO^- —a very bad leaving group. Almost no nucleophile will displace OH^- , so we need an alternative explanation. This comes in the form of another rearrangement, this time involving oxygen, but otherwise rather similar to the ones you have just met. Again, our epoxide, although reactive as an electrophile, suffers from being secondary at both electrophilic centres. $t\text{-BuS}^-$ is a bulky nucleophile, so direct attack on the epoxide is slow. Instead, under the basic conditions of the reaction, the neighbouring alkoxide group attacks intramolecularly to make a new, rearranged epoxy alcohol. This is called the Payne rearrangement.

Interactive mechanism for Payne rearrangement

the Payne rearrangement

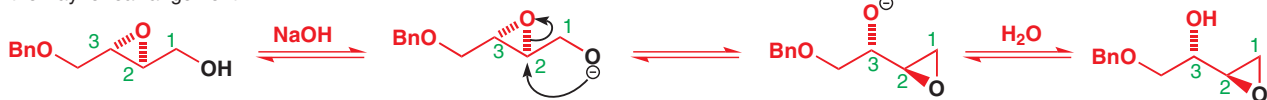

Now we do have a reactive, primary electrophilic site, which undergoes an S_N2 reaction with the $t\text{-BuS}^-$ under the conditions of the rearrangement. Notice how the black OH, which started on the carbon labelled 1, has ended up on carbon 2.

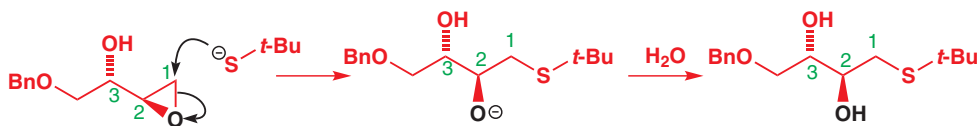

The direction of rearrangement can depend on the nucleophile

Compare these reactions: you saw the first on p. 938 but the second is new.



In the first reaction, the amine migrates from the primary to the secondary position; in the other from secondary to primary. Both go through very similar aziridinium intermediates, so the difference must be due to the regioselectivity with which this aziridinium ion opens in each case.

The only important difference is the nucleophile used in the reaction. Hydroxide opens the aziridinium at the less hindered end; water opens the aziridinium ion at the more hindered (more substituted) end. Why?

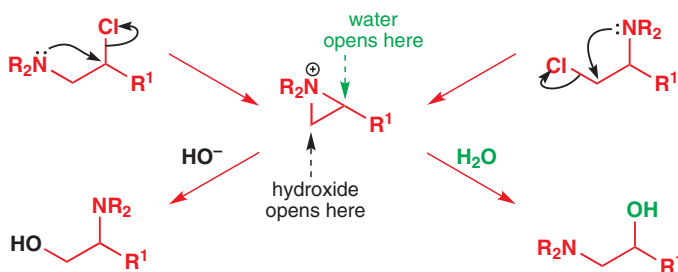

We can think of the aziridinium ion as a compound containing two alternative leaving groups—one from a primary centre and one from a secondary one. Primary centres can take part in fast S_N2 reactions, but cannot undergo S_N1 . Secondary centres can undergo either S_N1 or S_N2 reactions, but, in general, do neither very well. Now, the rate of an S_N2 reaction depends on the nucleophile, so a good nucleophile (like HO^-) can do fast S_N2 reactions, while a bad one (like H_2O) cannot. The fastest reaction HO^- can do then is S_N2 at the primary centre (remember: you see only the reaction that goes by the fastest mechanism). Water, on the other hand, takes part only reluctantly in substitution reactions—but this does not matter if they are S_N1 reactions because their rates are independent of nucleophile. H_2O waits until the leaving group has left of its own accord to give a cation, which rapidly grabs *any* nucleophile—water will do just as well as HO^- . This can happen *only* at the secondary centre because the primary cation is too unstable to form.

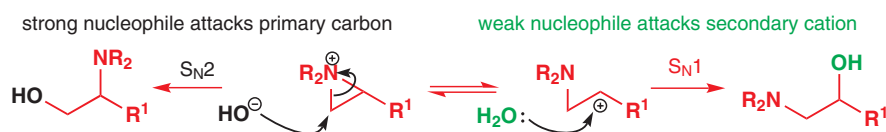

All the rearrangements you have met so far occurred during substitution reactions. All happened because reaction *with* rearrangement is faster than reaction *without* rearrangement—in other words, rearrangement occurs because of a kinetic preference for the rearrangement pathway. You could see these reactions as ‘special case’ examples of neighbouring group participation—in both participation and rearrangement the neighbouring group speeds up the

■ When a group migrates from a primary to a secondary carbon, we say the rearrangement has a primary **migration origin** and a secondary **migration terminus**. The migrating group moves from the migration origin to the migration terminus.

Interactive mechanism showing the effect of different nucleophiles

reaction, but in rearrangement reactions the neighbouring group gets rather more than it bargained for, and ends up elsewhere in the molecule. Both proceed through a cyclic transition state or intermediate, and it is simply the way in which that transition state or intermediate collapses that determines whether rearrangement occurs.

Rearrangement can involve migration of alkyl groups

This example is a nucleophilic substitution under conditions (Ag^+ , H_2O) designed to encourage $\text{S}_{\text{N}}1$ reactions (excellent leaving group, poor nucleophile). First of all, this is what does not happen (and indeed without Ag^+ *nothing happens at all*).

Neopentyl

The *t*-butylmethyl group is also called 'neopentyl'.



t-butylmethyl iodide
2,2-dimethyliodopropane
'neopentyl iodide'



the neopentyl group

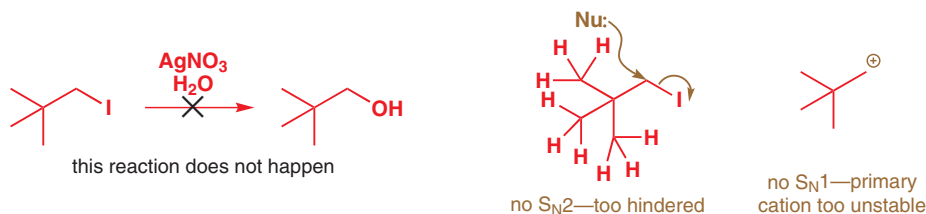

Compounds like this, with a *t*-butyl group next to the electrophilic centre, are notoriously slow to undergo substitution reactions. They can't do $\text{S}_{\text{N}}2$, they are too hindered; they can't do $\text{S}_{\text{N}}1$, the cation you would get is primary. In fact, a rearrangement occurs. One of the methyl groups moves ('migrates') from carbon 2 to carbon 1, the new OH group taking its place at carbon 2.

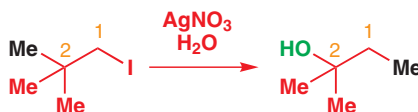

How has this happened? Well, firstly, our principle (p. 934) tells us that it has happened because $\text{S}_{\text{N}}1$ and $\text{S}_{\text{N}}2$ are both so slow that this new rearrangement mechanism is faster than either. Adding Ag^+ makes I^- desperate to leave, but unassisted this would mean the formation of a primary carbocation. The molecule does the only thing it can to stop this happening and uses the electrons in an adjacent C–C bond to assist the departure of I^- . Having participated, the methyl group continues to migrate to carbon 1 because by doing so it allows the formation of a stable tertiary carbocation, which then captures water in a step reminiscent of the second half of an $\text{S}_{\text{N}}1$ reaction. Note the cyclic transition state where the migrating group is partially bonded to two carbon atoms.

Some of the cyclic species you have seen so far (aziridinium ions, epoxides) are intermediates; the intermediate cyclic cation here is probably only a transition state.

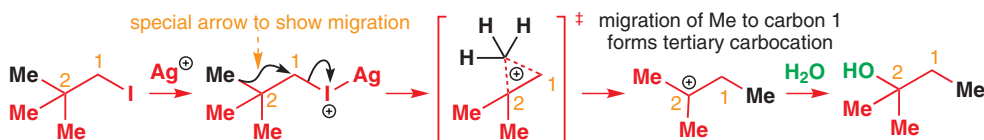

In the migration step we used a slightly unusually S-shaped curly arrow to represent the movement of a group (Me) along a bond taking its bonding electrons with it. We shall use this type of arrow when a group migrates from one atom to another during a rearrangement.

Carbocations readily rearrange

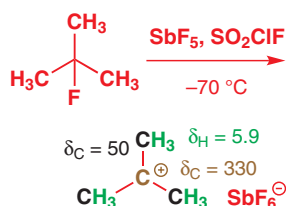

In Chapter 15 we showed you that it is possible to run the NMR spectra of carbocations by using a polar but non-nucleophilic solvent such as liquid SO_2 or SOClF . Treating an alkyl halide RX with the powerful Lewis acid SbF_5 under these conditions gives a solution of carbocation: the carbocation reacts neither with solvent nor the SbF_5X^- counterion because neither is nucleophilic. We know, for example, that the chemical shifts in both the ^{13}C and ^1H NMR spectra of the *t*-butyl cation are very large, particularly the ^{13}C shift at the positively charged centre.

NMR can be used to follow the course of rearrangement reactions involving carbocations too. We can illustrate this with an experiment that tries to make the neopentyl cation by the substitution reaction you have just seen. This time the starting material and solvent are slightly different, but the outcome is nonetheless most revealing. Dissolving neopentyl tosylate in fluorosulfonic acid (a strong, non-nucleophilic acid) at -77°C gives a 77% yield of a cation whose spectrum is shown below. Assigning the peaks is not hard once you know that the same spectrum is obtained when 2,2-dimethyl-2-butanol is dissolved in fluorosulfonic acid with SbF_5 added.

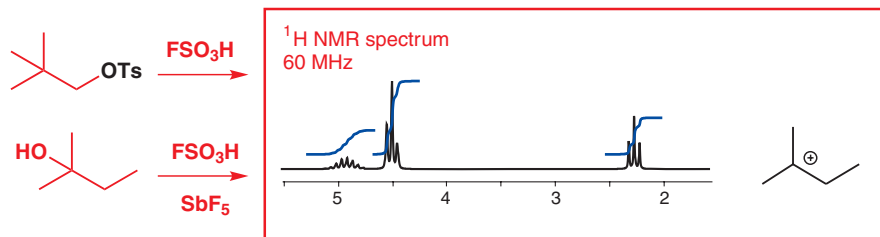

Clearly, the spectrum is the tertiary 2-methylbutyl cation and the neopentyl cation never saw the light of day. The reaction is the same rearrangement that you saw in the substitution reaction of neopentyl iodide, but here the rate of rearrangement can be measured and it is extremely fast. Neopentyl tosylate reacts to form a cation under these conditions about 10^4 times as fast as ethyl tosylate, even though both tosylates are primary. This massive rate difference shows that if migration of an alkyl group can allow rearrangement to a more stable carbocation, it will happen, and happen rapidly.

Primary cations can never be observed by NMR—they are too unstable. But secondary cations can, provided the temperature is kept low enough. *sec*-Butyl chloride in SO_2ClF at -78°C gives a stable, observable cation. But, as the cation is warmed up, it rearranges to the *t*-butyl cation. Now this rearrangement truly is a carbocation rearrangement: the starting material is an observable carbocation and so is the product, and we should just look at the mechanism in a little more detail.

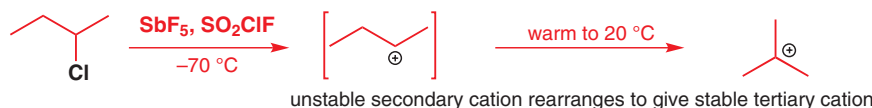

With rearrangements like this it is best to number the C atoms so you can see clearly what moves where. If we do this, we see that the methyl group we have labelled 4 and the H on C3 have changed places. (Note that C3 starts off as a CH_2 group and ends up as CH_3 .)

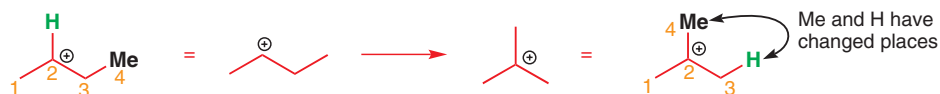

● Top tip for rearrangements

Number the carbon atoms in the starting material and product before you try to work out the mechanism.

Using the sort of arrows we introduced on p. 940, we can draw a mechanism for this in which first the Me migrates, and then the hydride. We say hydride migration rather than *hydrogen* (or *proton*) because the H atom migrates *with* its pair of electrons.

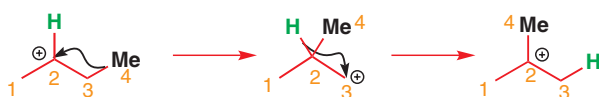

As these rearrangements are a new type of reaction, we should just spend a moment looking at the molecular orbitals that are involved. For the first step, migration of the methyl group,

■ Notice how the methyl groups appear as triplets due to coupling to CH_2 through the empty p orbital.

■ In fact, all seven possible isomers of pentyl alcohol ($\text{C}_5\text{H}_{11}\text{OH}$) give this same spectrum under these conditions at temperatures greater than -30°C .

■ The reason we say 'truly is a carbocation rearrangement' here is quite subtle and need not detain us long. We know that a secondary cation is formed in this case because we can see it by NMR; it subsequently rearranges to a tertiary cation. As we can never see primary cations, we don't know that they are ever formed, and the most reasonable explanation for rearrangements of the type you saw on p. 937 is that migration of the alkyl group begins *before* the leaving group is fully gone. This has been proved in a few cases, but we will from now on not distinguish between the two alternatives.

■ You will see why Me has to migrate first if you try drawing the mechanism out with H migrating first instead.

the LUMO must clearly be the empty p orbital of the cation, and the HOMO is the C–C σ bond, which is about to break.

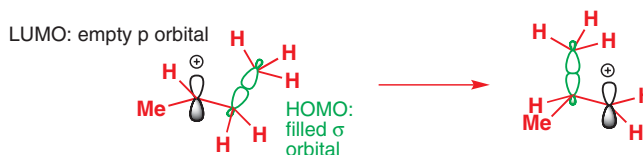

The methyl group can slide smoothly from one orbital to another—there are bonding interactions all the way. The next step, migration of H, is just the same—except that the HOMO is now a C–H σ bond. The methyl migration is thermodynamically unfavourable as it transforms a secondary cation into an unstable primary cation but the hydride migration puts that right as it gives a stable tertiary cation. The whole reaction is under thermodynamic control.

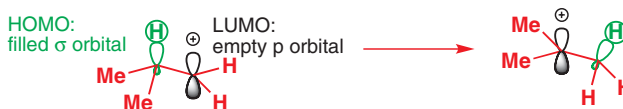

Wagner–Meerwein rearrangements

Carbocation rearrangements involving migration of H or alkyl groups don't just happen in NMR machines. They happen during normal reactions too. For example, acid-catalysed dehydration of the natural product camphenilol gives the alkene santene (a key component of the fragrance of sandalwood oil) in a reaction involving migration of a methyl group.

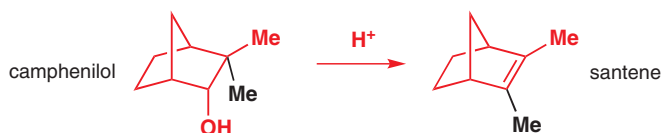

The mechanism shows why the rearrangement happens: the first-formed cation cannot eliminate H^+ in an E1 reaction because loss of the only available proton would give a very strained bridgehead alkene (make a model and see!).



However, migration of a methyl group both stabilizes the cation—it becomes tertiary instead of secondary—and allows E1 elimination of H^+ to take place to give a stable alkene.

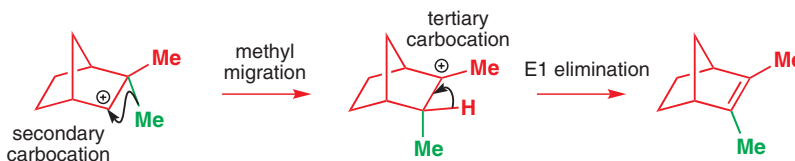

The migration of an alkyl group to a cationic centre is known as a Wagner–Meerwein rearrangement or Wagner–Meerwein shift, and this migration is, of course, a synthetic manifestation of the rearrangement we have just been looking at in NMR spectra. Wagner–Meerwein shifts have been studied extensively in the class of natural products to which both of these natural products belong—terpenes. For the moment, though, we will just illustrate this type of reaction with one more example—another acid-catalysed dehydration, of isborneol to give camphene.

➡ The impossibility of bridgehead alkenes (Bredt's rule) was discussed in Chapter 17, p. 389.

🖱 Interactive mechanism for Wagner–Meerwein rearrangements

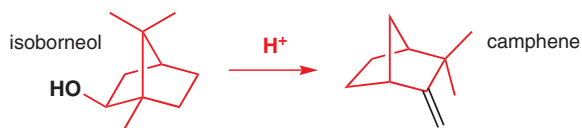

This one *seems* much more complicated—but, in fact, only one alkyl migration is involved. To see what has happened, remember the ‘top tip’—number the carbons. You can number the starting material any way you choose—we’ve started with the gem-dimethyl group because it will be easy to spot in the product. The numbers just follow round the ring, with C8 being the methyl group attached to C5.

Now for the hard bit—we need to work out which carbon in the starting material becomes which carbon in the product. The best thing is just to have a go—mistakes will soon become obvious and you can always try again.

- Use the substituents to help you—some will have changed, but most will be the same or similar, for example C1 is still easy to spot as the carbon carrying the dimethyl group.
- Use connectivity to help you—again, a C–C bond or two may have broken or formed, but most of the C–C bonds in the starting material will be there in the product. C1 and C2 will probably still be next door to one another—C2 was a bridgehead carbon in the starting material, and there is a bridgehead C attached to C1 in the product; assume that’s C2.
- C3 and C4 were unsubstituted carbons in the starting material, and are identifiable in the product too. The other easily spotted atom is C7—an unsubstituted C attached to C2.
- C5, C6, and C8 are harder. We can assume that C8 is the =CH₂ carbon—it was a methyl group but perhaps has become involved in an elimination. C5 was attached to C1, C4, C6, and C8: one of the remaining carbons is attached to C1 and C8, so that seems more likely to be C5, which leaves C6 as the bridgehead, attached as before to C7 and C5.

Now we have the whole picture and we can assess what has happened in the reaction—which old bonds have broken and which new bonds have formed.

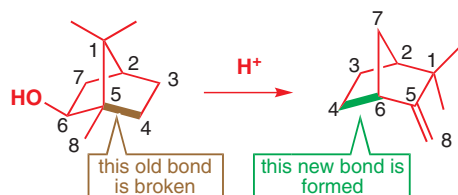

Numbering the atoms this way identifies the likely point of rearrangement—the only bond broken is between C4 and C5. Instead we have a new one between C4 and C6: C4 appears to have migrated from C5 to C6.

Now for the mechanism. The first step will, of course, be loss of water to generate a secondary cation at C6. The cation is next to a quaternary centre, and migration of any of three bonds could generate a more stable tertiary carbocation. But we know that the new bond in the product is between C4 and C6, so let’s migrate carbon 4. Manipulating the diagrams a bit turns up a structure remarkably similar to our product, and all we need to do is lose a proton from C8.

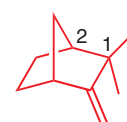
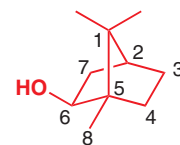
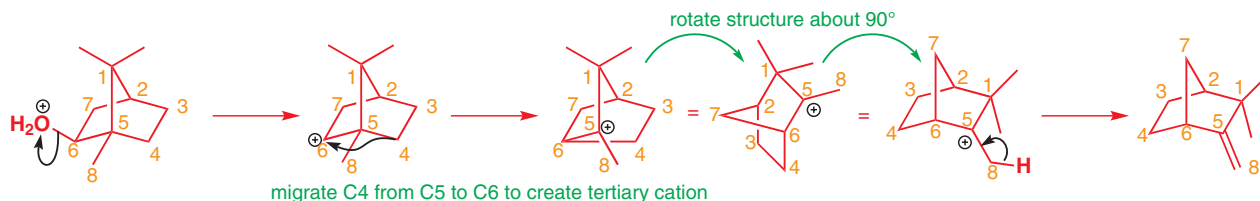

■ If you are observant, you may ask why the alkyl group migrated in this example and not the methyl group, or the other alkyl group—all three possibilities give similar tertiary carbocations. The reason involves the *alignment* of the orbitals involved, which we will discuss at the end of the chapter.

Although migration of an alkyl group that forms part of a ring leads to much more significant changes in structure than simple migration of a methyl group, the reason why it happens is still just the same.

- Alkyl migrations occur in order to make a carbocation more stable.

Ring expansion means rearrangement

‘More stable’ usually means ‘more substituted’, but cations can also be made *more stable* if they become *less strained*. So, for example, four-membered rings adjacent to cations readily rearrange to five-membered rings in order to relieve ring strain.

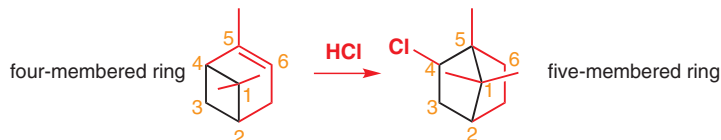

This time the cation is formed by protonation of an alkene, not departure of a leaving group, but writing a mechanism should now be a straightforward matter to you.

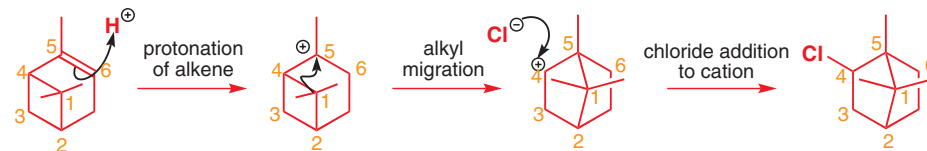

Interactive mechanism for cation-mediated ring expansion

Although the rearrangement step transforms a stable tertiary cation into a less stable secondary cation, relief of strain in expansion from a four- to a five-membered ring makes the alkyl migration favourable. A synthesis of the natural product α -caryophyllene alcohol makes use of a similar ring expansion. Notice the photochemical [2 + 2] cycloaddition (Chapter 34) in the synthesis of the starting material.

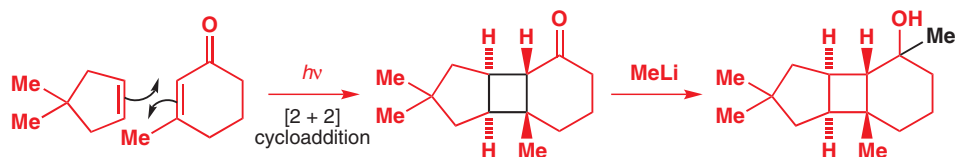

Rearrangement of this tertiary alcohol in acid gives the target natural product. The four-membered ring has certainly disappeared but it may not be obvious at first what has taken its place.

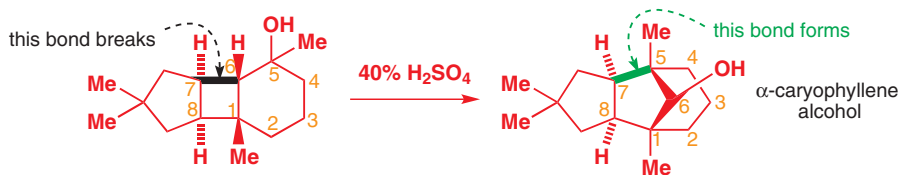

As usual, numbering the atoms makes clear what has happened: carbon 7 has migrated from carbon 6 to carbon 5. Loss of water gives a tertiary carbocation that undergoes rearrangement to a secondary carbocation with expansion of a four- to a five-membered ring.

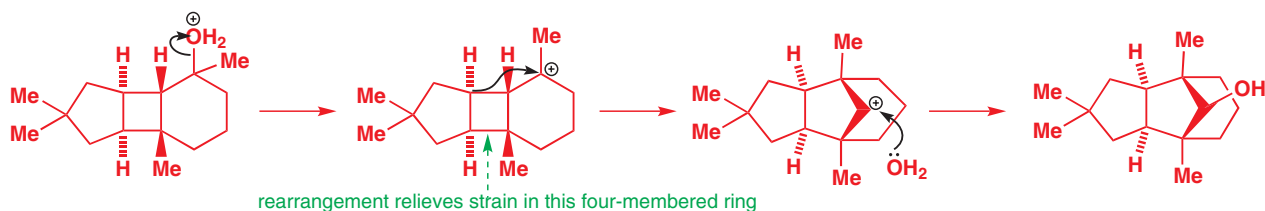

Carbocation rearrangements: blessing or curse?

Well, that depends. You have now seen a few useful carbocation rearrangements that give single products in high yield. But you have also met at least one reaction that *cannot* be done because of carbocation rearrangements: as we mentioned in Chapter 15, Friedel–Crafts alkylation using primary alkyl halides leads to products derived from rearranged cations. The alkylation in the margin illustrates the problems of trying to use carbocation rearrangements to make single products in high yield. We can give three guidelines to spotting this type of reaction.

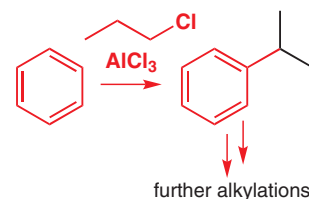

1. The rearrangement must be fast so that other reactions do not compete.
2. The product cation must be sufficiently more stable than the starting one so that the rearrangement happens in high yield.
3. Subsequent trapping of the product cation must be reliable: cations are high-energy intermediates, and are therefore unselective about how they react.

A reaction is no good if the cation reacts in more than one way—it may react with a nucleophile, eliminate, or undergo further rearrangement—but it must do only one of these! For the rest of the chapter, we will address only reactions that, unlike this Friedel–Crafts reaction, follow these guidelines. The reactions we will talk about all happen in good yield.

The pinacol rearrangement

When the 1,2-diol pinacol is treated with acid, a rearrangement takes place.

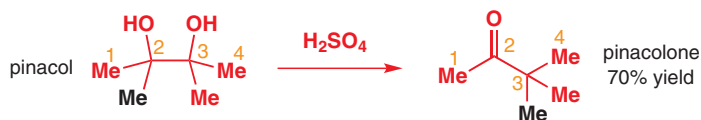

Whenever you see a rearrangement, especially in acid, you should now think ‘carbocation’. Here, protonation of one of the hydroxyl groups allows it to leave as water, giving the carbocation.

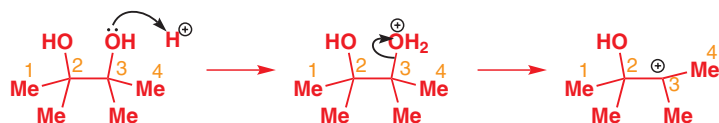

You now know that carbocations rearrange by alkyl shifts to get as stable as they can be—but this carbocation is already tertiary, and there is no ring strain, so why should it rearrange? Well, here we have another source of electrons to stabilize the carbocation: lone pairs on an oxygen atom. We pointed out early in the chapter that oxygen is very good at stabilizing a positive charge on an adjacent atom, and somewhat less good at stabilizing a positive charge two atoms away. By rearranging, the first-formed carbocation gets the positive charge into a position where the oxygen can stabilize it, and loss of a proton from oxygen then gives a stable ketone.

■ Pinacol, the trivial name for the starting material, which is made from acetone by a reaction you will meet in Chapter 37, gives its name to this class of rearrangements, and to the product, ‘pinacolone’.

Interactive mechanism for pinacol rearrangement

■ Spirocycles are pairs of rings joined at a single carbon atom (Chapter 32).

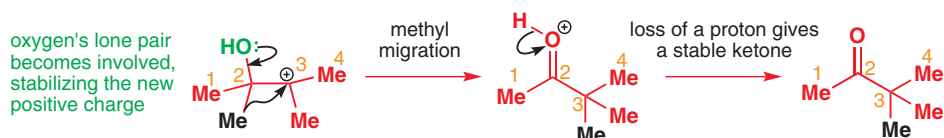

You can view the pinacol as a rearrangement with a 'push' and a 'pull'. The carbocation left by the departure of water 'pulls' the migrating group across at the same time as the oxygen's lone pair 'pushes' it. A particularly valuable type of pinacol rearrangement forms spirocyclic ring systems. You may find this one harder to follow, although the mechanism is identical with that of the last example. Our 'top tip' of numbering the atoms should help you to see what has happened: atom 2 has migrated from atom 1 to atom 6.

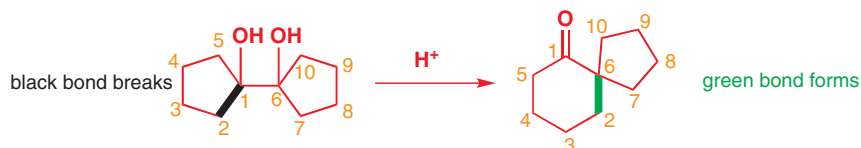

■ Of course, it doesn't matter how you number the atoms, but the numbering must be consistent. Usually, your initial impression of a greatly changed molecule will come down to just one or two atoms changing their substitution pattern, and numbering will help you to work out which ones they are.

When drawing the mechanism it doesn't matter which hydroxyl group you protonate or which adjacent C–C bond migrates—they are all the same. One five-membered ring expands to a six-membered ring but the reason this reaction happens is the formation of a carbonyl group, as in all pinacol rearrangements.

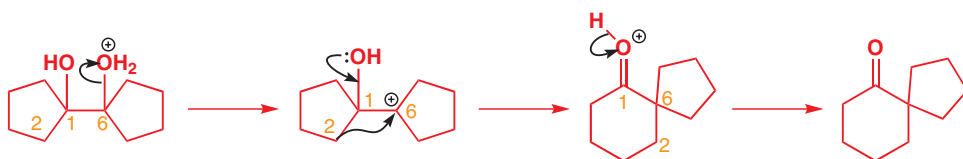

Epoxides rearrange with Lewis acids in a pinacol fashion

The intermediate cation in a pinacol rearrangement can equally well be formed from an epoxide, and treating epoxides with acid, including Lewis acids such as $MgBr_2$, promotes the same type of reaction.

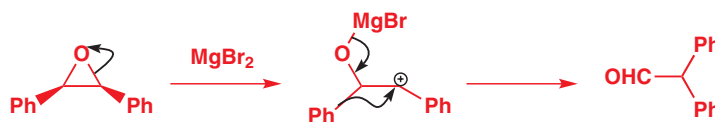

Rearrangement of epoxides with magnesium salts means that opening epoxides with Grignard reagents can give surprising results.

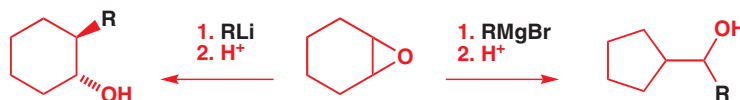

The alkyllithium reaction is quite straightforward as long as the alkyllithium is free of lithium salts. A clue to what has happened with the Grignard reagents comes from the fact that treating this epoxide with just $MgBr_2$ (not $RMgBr$) gives an aldehyde.



With a Grignard reagent, rearrangement occurs faster than addition to the epoxide, and then the Grignard reagent adds to the aldehyde.

Some pinacol rearrangements have a choice of migrating group

With these symmetrical diols and epoxides, it does not matter which hydroxyl group is protonated and leaves, nor which end the epoxide opens, nor which group migrates. When an unsymmetrical diol or epoxide rearranges, it *is* important which way the reaction goes. Usually, the reaction leaves behind the more stable cation. So, for example, this unsymmetrical diol gives the ring-expanded ketone, a starting material for the synthesis of analogues of the drug methadone.

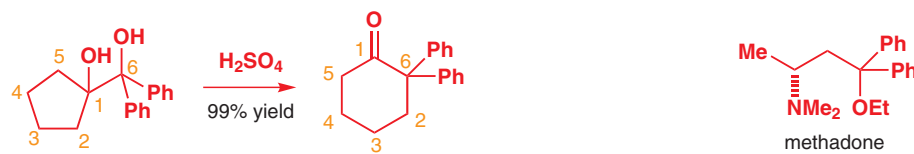

This product is formed because the green OH group leaves more readily than the black as the carbocation stabilized by two phenyl groups forms more readily than the carbocation stabilized by two alkyl groups. The migration step which follows has no choice: both alkyl groups on the black alcohol are the same.

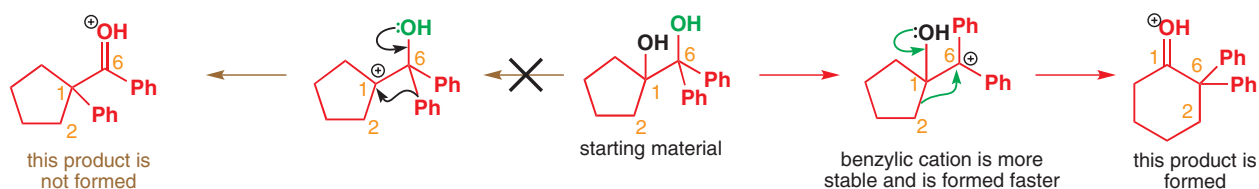

Most unsymmetrical diols or epoxides give mixtures of products on rearrangement. The problem is that there is a choice of two leaving groups and two alternative rearrangement directions, and only for certain substitution patterns is the choice clear-cut.

Semipinacol rearrangements are pinacol reactions with no choice about which way to go

For some work on perfumery compounds, this seven-membered cyclic ketone was needed. A reasonable starting material to use is the diol shown because it can be made in two steps from the natural product isonopinone.

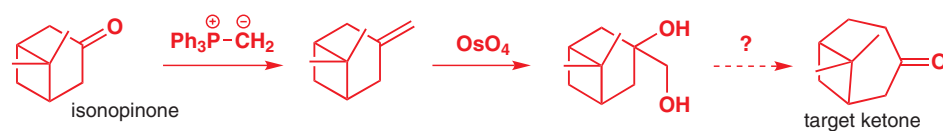

The reaction needed for the last stage is a pinacol rearrangement—the *primary* hydroxyl group needs persuading to leave as the ring expands. The problem is, of course, that the tertiary hydroxyl group is much more likely to leave since it leaves behind a more stable carbocation.

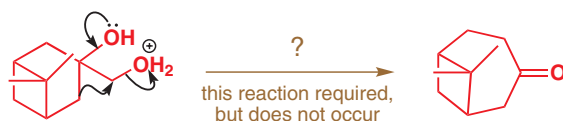

The solution to this problem is to force the primary hydroxyl group to be the leaving group by making it into a tosylate. The primary hydroxyl group reacts more rapidly with TsCl than the tertiary one because it is less hindered. A weak base is now all that is needed to make the compound rearrange in what is known as a semipinacol rearrangement.

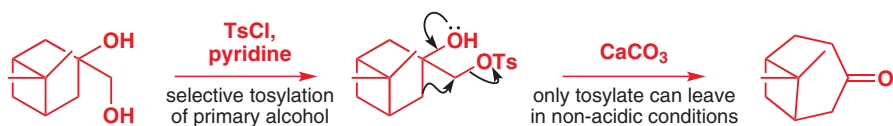

Semipinacol rearrangements are rearrangements in which a hydroxyl group provides the electrons to 'push' the migrating group across, but the 'pull' comes from the departure of leaving groups other than water—tosylate in this example, but typically also halide or nitrogen (N_2). Since tosylation occurs at the *less* hindered hydroxyl group of a diol, not only can semipinacol rearrangements be more regioselective than pinacol rearrangements, but their regioselectivity may be in the opposite direction.

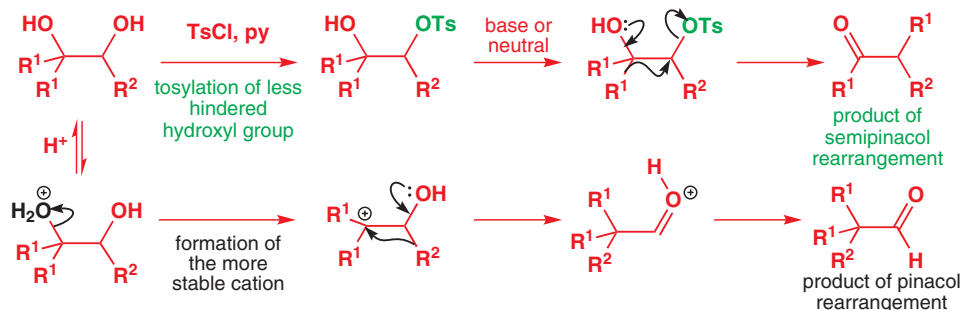

Corey exploited this in a synthesis of the natural product longifolene. He needed to persuade an easily made 6,6-fused ring system to undergo rearrangement to a ring-expanded ketone. Again, a normal acid-catalysed pinacol rearrangement is no good—the tertiary, allylic hydroxyl group is much more likely to ionize, and the acid-sensitive protecting group would be hydrolysed too. Tosylation of the secondary alcohol in the presence of the tertiary is possible, and semipinacol rearrangement gives the required ketone.

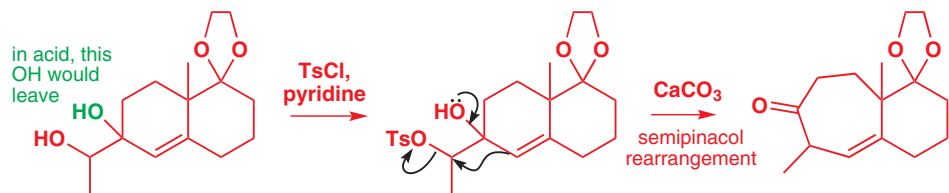

■ Treating 2-halo alcohols with base is, of course, a good way to make epoxides. Using AgNO_3 to improve iodide's leaving ability without increasing the nucleophilicity of the hydroxyl group favours rearrangement at the expense of epoxide formation. There would certainly be a danger of epoxide formation in strong base.

The leaving group need not be tosylate: in the following example, part of a synthesis of bergamotene (a component of valerian root oil and the aroma of Earl Grey tea), a 2-iodo alcohol rearranges.

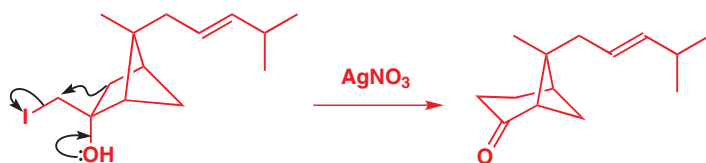

Semipinacol rearrangements of diazonium salts

You saw in Chapter 21 how aromatic amines can be converted to diazonium salts by treatment with acidic sodium nitrite.

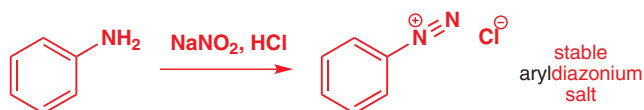

■ It might be an idea to review pp. 520–523 of Chapter 22 to be sure you understand the mechanism of this reaction.

Aryldiazonium salts are stable but alkyldiazonium salts are not: nitrogen gas is the world's best leaving group, and, when it goes it leaves behind a carbocation.

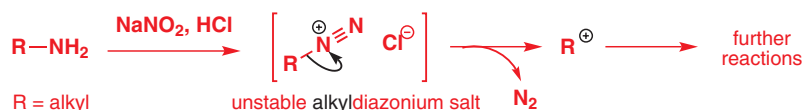

One of the 'further reactions' this carbocation can undergo is rearrangement. If the starting amine is a 2-amino alcohol, the cation can be stabilized by a semipinacol rearrangement.

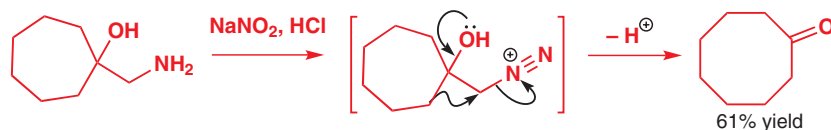

While alkyldiazonium salts are unstable, their conjugate bases, diazoalkanes, are stable enough to be prepared and are nucleophilic towards carbonyl compounds. Diazoalkanes are neutral compounds having one fewer proton than diazonium salts, and are delocalized structures with a central sp nitrogen atom.

When diazomethane (a compound we will investigate in more detail in Chapter 38) adds to a ketone, the product undergoes a ring expansion by rearrangement of the same type of intermediate.

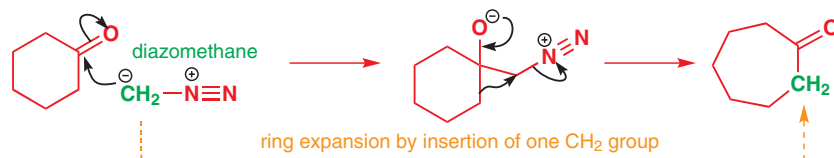

The problem with reactions like this is that both the starting material and product are ketones, so they work cleanly only if the starting material is more reactive than the product. Cyclohexanone is more reactive as an electrophile than either cyclopentanone or cycloheptanone, so it ring expands cleanly to cycloheptanone. But expansion of cyclopentanone to cyclohexanone is messy and gives a mixture of products.

The dienone-phenol rearrangement

The female sex hormone oestrone is the metabolic product of another hormone, progesterone, itself made in the body from cholesterol.

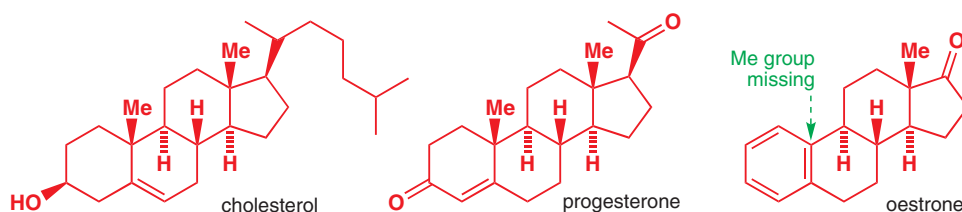

Oestrone lacks one of progesterone's methyl groups, probably removed in the body as CO₂ after oxidation. In 1946, Carl Djerassi, a man whose work led directly to the invention of the contraceptive pill, showed that another derivative of cholesterol could be rearranged to the oestrone analogue 1-methyloestradiol—notice how the methyl group has this time migrated to an adjacent carbon atom. At the same time, the dienone has become a phenol.

Semipinacol rearrangements of diazonium salts derived from 2-amino alcohols are sometimes called **Tiffeneau–Demjanov rearrangements**.

Interactive mechanism for Tiffeneau–Demjanov rearrangement

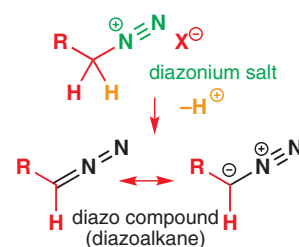

Interactive mechanism for semipinacol rearrangements of diazonium salts

Carl Djerassi, an American born in Vienna in 1923, worked chiefly at Ciba, at Syntex in Mexico, and at Stanford. He developed syntheses of human steroids from compounds in plants, was a pioneer of mass spectrometry, and is a colourful campaigner for peace and disarmament, along with being a playwright and novelist.

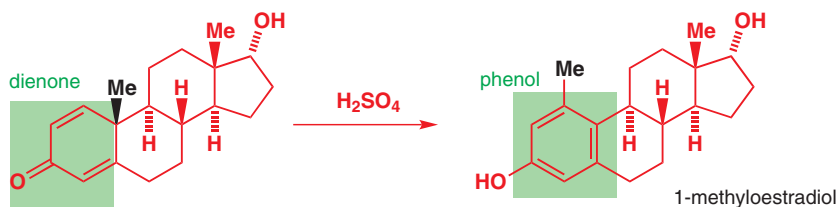

This type of rearrangement is known helpfully as a dienone-phenol rearrangement, and we can consider it quite simply as a type of *reverse* pinacol rearrangement. Pinacol and semipinacol rearrangements are driven by the formation of a carbonyl group. The rearranged cation is stabilized by being next to oxygen and it can rapidly lose H^+ to give a carbonyl compound. In the key step of a dienone-phenol rearrangement, a protonated carbonyl compound rearranges to a tertiary carbocation. The reaction is driven from dienone to phenol because the product cation can rapidly undergo elimination of H^+ to become aromatic.

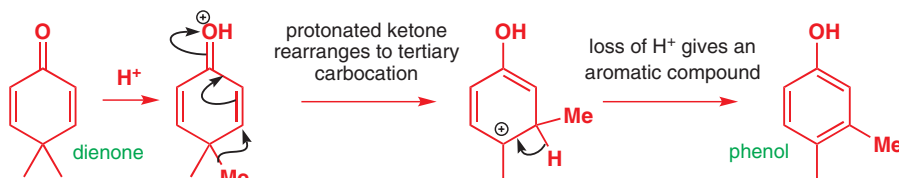

The benzilic acid rearrangement

You have seen rearrangements in which carbonyl groups form at the migration origin: the migrating group in the pinacol and semipinacol rearrangements is 'pushed' by the oxygen's lone pair as it forms the new carbonyl group. You have also seen carbonyl groups being destroyed at the migration terminus: the migrating group in the dienone-phenol rearrangement is 'pulled' towards the protonated carbonyl group. The first rearrangement reaction ever to be described has both of these at once.

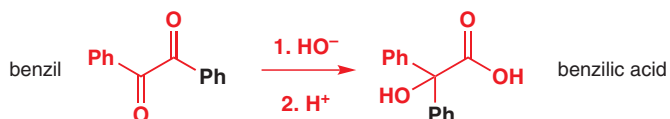

■ You may find it helpful to think of the benzilic acid rearrangement as a semipinacol rearrangement in which we have a breaking $C=O$ π bond instead of a leaving group.

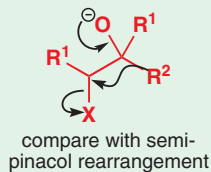

In 1838, Justus von Liebig found that treating 'benzil' (1,2-diphenylethane-1,2-dione) with hydroxide gave, after acid quench, 2-hydroxy-2,2-diphenylacetic acid, which he called 'benzilic acid'. The mechanism of this benzilic acid rearrangement starts with attack of hydroxide on one of the carbonyl groups. The tetrahedral intermediate can collapse in a reaction reminiscent of a semipinacol rearrangement.

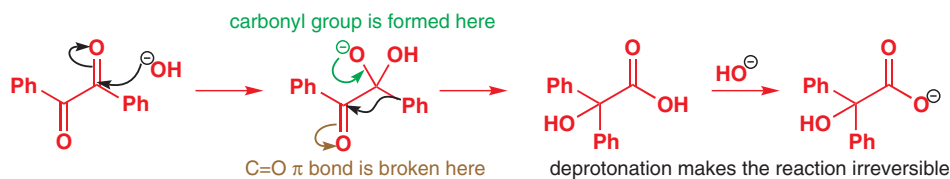

Interactive mechanism for benzilic acid rearrangement

The Favorskii rearrangement

We hope you have appreciated the smooth mechanistic progression so far in this chapter, from Wagner–Meerwein to pinacol and semipinacol through dienone-phenol to benzilic acid.

Our aim is to help you gain an overall view of the types of rearrangements that take place (and why) and not to present you with lots of disconnected facts. It is at this point, however, that our mechanistic journey takes a hairpin bend. The bend comes as a surprise because when we show you the next rearrangement, the Favorskii, you would be forgiven for thinking that surely it's just a variant of the benzilic acid rearrangement?

the benzilic acid rearrangement

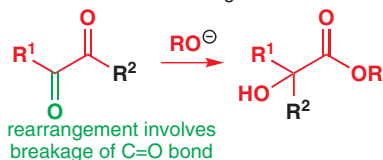

the Favorskii rearrangement

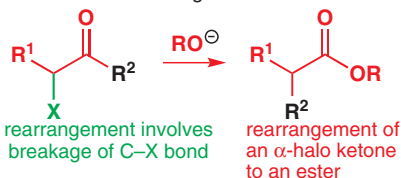

Well, this is what chemists thought until 1944, when some American chemists found that two isomeric α -chloro ketones gave exactly the same product on treatment with methoxide. They suggested that both reactions went through the same intermediate.

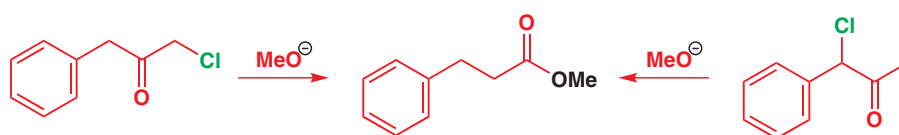

That intermediate is a three-membered cyclic ketone, a cyclopropanone: the alkoxide acts not as a nucleophile (its role in the benzilic acid rearrangement) but as a base, enolizing the ketone. The enolate can alkylate itself intramolecularly in a reaction that looks bizarre but that many chemists think is not unreasonable. The intermediate is the same cyclopropanone in each case.

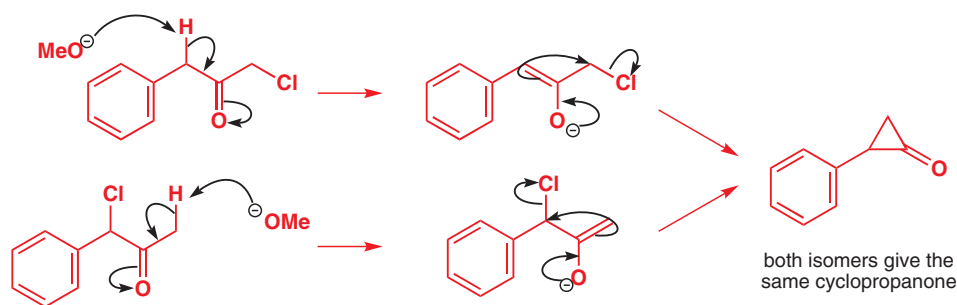

There is also a pericyclic mechanism for the ring-closure step. The enolate simply loses chloride to give an 'oxyallyl cation'—a dipolar species with an oxyanion and a delocalized allylic cation. This species can cyclize in a two-electron disrotatory electrocyclic reaction (Chapter 35) to give the same cyclopropanone.

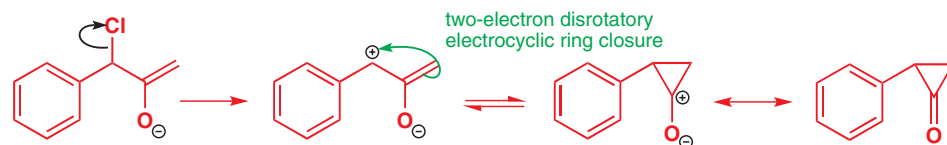

Cyclopropanones are very reactive towards nucleophiles, and the tetrahedral intermediate arising from the attack of methoxide springs open to give the ester product. The more stable carbanion leaves: although the carbanion is not actually formed as a free species, there must be considerable negative charge at the carbon atom as the three-membered ring opens. Here the benzyl group is the better leaving group.

Cyclopropanones and cyclobutanones are very reactive, rather like epoxides, because, while the 60° or 90° angle in the ring is nowhere near the tetrahedral angle (108°), it is nearer 108° than the 120° preferred by the sp^2 C of the C=O group. Conversely, the small ring ketones are resistant to enolization because that would place two sp^2 carbon atoms in the ring.

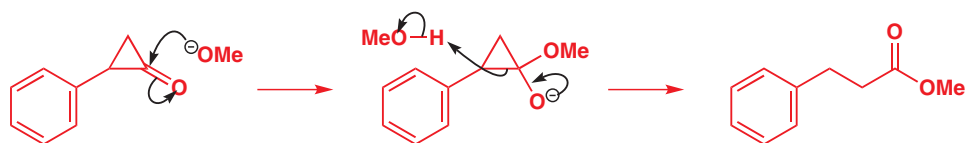

Favorskii rearrangement of cyclic 2-bromoketones leads to ring contraction and this has become one of the most fruitful uses of the rearrangement in synthesis. Bromination of cyclohexanone (Chapter 20) and treatment with methoxide gives the methyl ester of cyclopentane carboxylic acid in good yield.

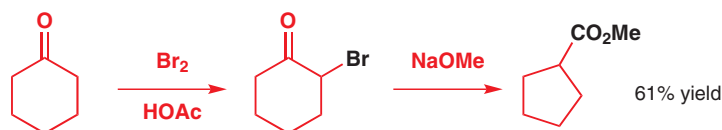

Enolization occurs on the side of the ketone away from the bromine atom and the enolate cyclizes as before but the cyclopropanone intermediate is symmetrical so that the product is the same whichever C–C bond breaks after nucleophilic attack by the methoxide ion.

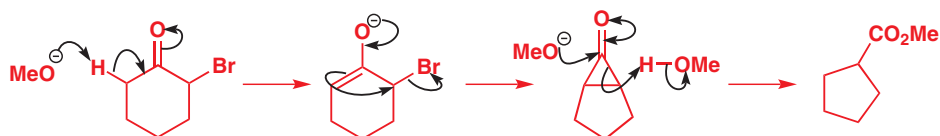

 Interactive mechanism for the Favorskii rearrangement

Cubane from a Favorskii rearrangement

In 1964, two American chemists synthesized for the first time a remarkable molecule, cubane. Two of the key steps were Favorskii rearrangements, which allowed the chemists to contract five-membered rings to four-membered rings. Here is one of them. Two more steps decarboxylate the product to give cubane itself.

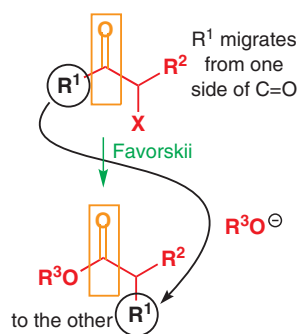
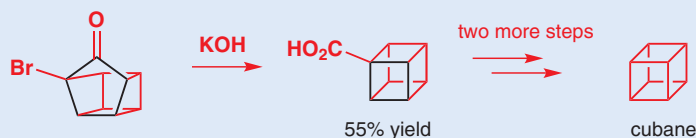

The overall consequence of the Favorskii rearrangement is that an alkyl group is transferred from one side of a carbonyl group to the other. This means that it can be used to build up heavily branched esters and carboxylic acids—the sort that are hard to make by alkylation (Chapter 25) because of the problems of hindered enolates and unreactive secondary alkyl halides. Heavily substituted acids, where CO₂H is attached to a tertiary carbon atom, would be hard to make by any other method.



The Favorskii rearrangement is also a key step in the synthesis of the powerful obstetric painkiller pethidine. But try writing a mechanism for this last reaction and you run into a problem—there are no acidic protons so the ketone cannot be enolized! Yet the Favorskii rearrangement still works. Despite our warnings against confusing the mechanisms of the Favorskii and benzilic acid rearrangements, the Favorskii rearrangement may, in fact, follow a benzilic-type rearrangement mechanism, *if* there are no acidic hydrogens available.

benzilic-type Favorskii rearrangement of an un-enolizable ketone

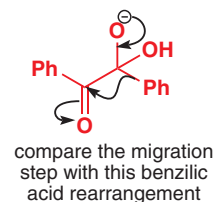
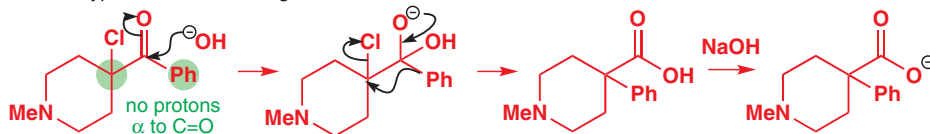

Migration to oxygen: the Baeyer–Villiger reaction

In 1899, two Germans, A. Baeyer and V. Villiger, found that treating a ketone with a peracid (RCO_3H) can produce an ester. An oxygen atom is 'inserted' next to the carbonyl group. You saw a similar 'insertion' reaction earlier in the chapter, and the mechanism here is not dissimilar.

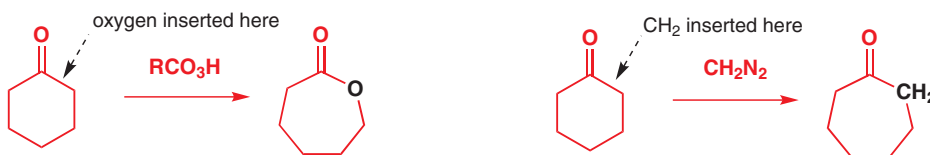

Both peracids and diazomethane contain a nucleophilic centre that carries a good leaving group, and addition of peracid to the carbonyl group gives a structure that should remind you of a semipinacol intermediate with one of the carbon atoms replaced by oxygen.

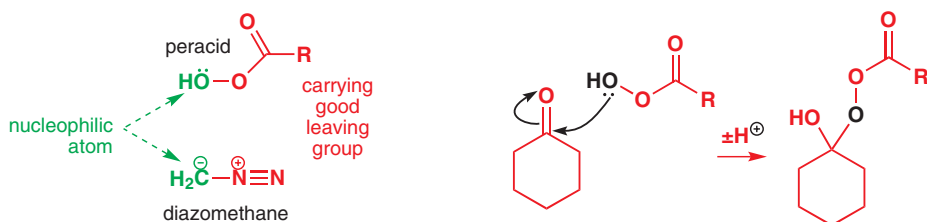

Carboxylates are not such good leaving groups as nitrogen, but the oxygen–oxygen single bond is very weak. Once the peracid has added, loss of carboxylate is concerted with a rearrangement driven by formation of a carbonyl group.

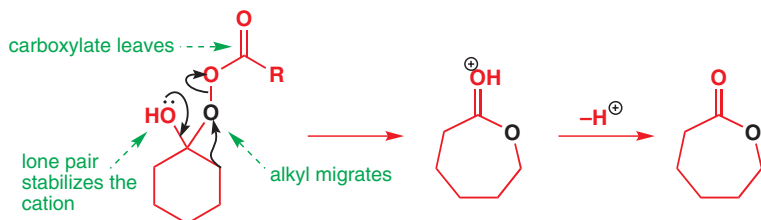

Baeyer–Villiger reactions are among the most useful of all rearrangement reactions, and the most common reagent is *m*-CPBA (*meta*-chloroperbenzoic acid) because it is commercially available.

Which group migrates? (I): the facts

A question we have deliberately avoided up to this point is this: when there is a competition between two migrating groups, *which group migrates*? This question arises in pinacol, semipinacol, and dienone–phenol rearrangements and in Baeyer–Villiger reactions (in the benzilic acid and Favorskii rearrangements, there is no choice) and the awkward fact is that the answer is different in each case! However, let's start with the Baeyer–Villiger reaction because here the question is always valid except when the ketone being oxidized is symmetrical. Here are some examples; you can probably begin to draw up guidelines for yourself.

Interactive mechanism for the Baeyer–Villiger rearrangement

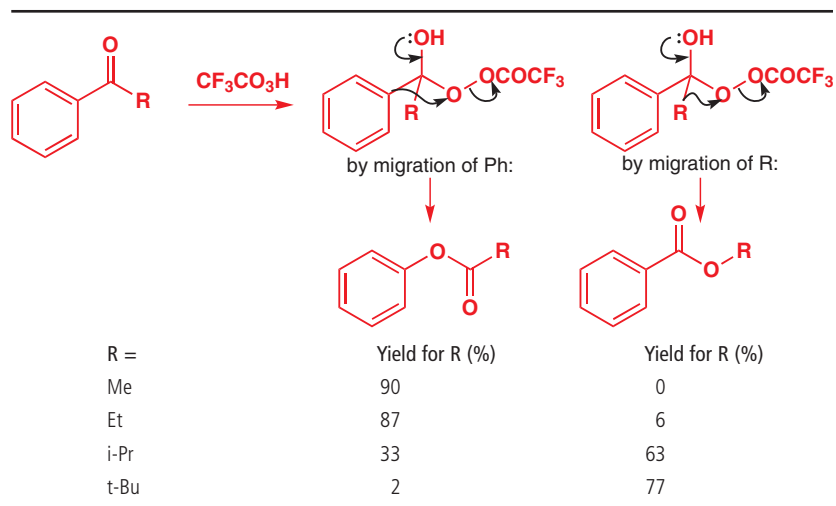

The order, with *tert*-alkyl the best at migrating, then *sec*-alkyl closely followed by Ph, then Et, then Me, *very roughly* follows the order in which the groups are able to stabilize a positive charge. Primary groups are much more reluctant to undergo migration than secondary ones or aryl groups, and this makes regioselective Baeyer–Villiger reactions possible.

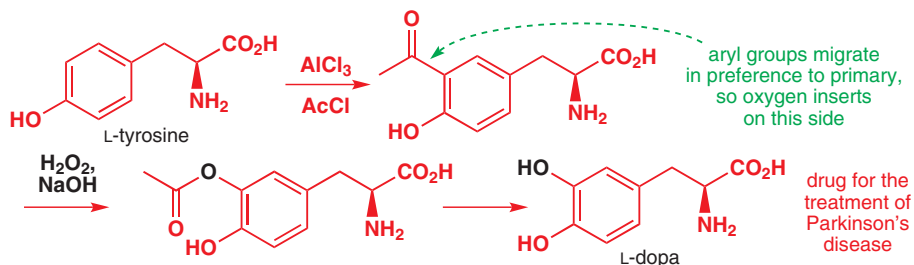

The Baeyer–Villiger reaction has solved a regioselectivity problem here. L-tyrosine, a relatively cheap amino acid, can be converted to the important drug L-dopa provided it can be hydroxylated *ortho* to the OH group. This is where electrophilic substitutions of the phenol take place, but electrophilic substitutions with ‘HO⁺’ are not possible. However, after a Friedel–Crafts acylation, the acyl group can be converted to hydroxyl by the Baeyer–Villiger reaction and hydrolysis. The Baeyer–Villiger reaction means that MeCO⁺ can be used as a synthetic equivalent for ‘HO⁺’. Note the unusual use of the less reactive H₂O₂ as oxidizing agent in this reaction. This is possible only when the migrating group is an electron-rich aromatic ring; these reactions are sometimes called Dakin reactions.

Unsaturated ketones may epoxidize or undergo Baeyer–Villiger rearrangement

Peracids may epoxidize alkenes faster than ketones take part in Baeyer–Villiger reactions, so unsaturated ketones are not often good substrates for Baeyer–Villiger reactions. The balance is rather delicate. The two factors that matter are: how *electrophilic* is the ketone and how *nucleophilic* is the alkene? You might like to consider why this reaction *does* work, and why the C=C double bond here is particularly unreactive.

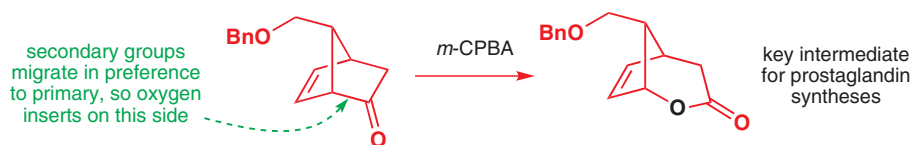

Small-ring ketones can relieve ring strain by undergoing Baeyer–Villiger reactions—this cyclobutanone (an intermediate in a synthesis of the perfumery compound *cis*-jasmone) is

made by a ketene [2 + 2] cycloaddition, and is so reactive that it needs only H_2O_2 to rearrange. Unlike $\text{CF}_3\text{CO}_3\text{H}$ or *m*-CPBA, H_2O_2 will not epoxidize double bonds unless they are electron-deficient (see Chapter 22).

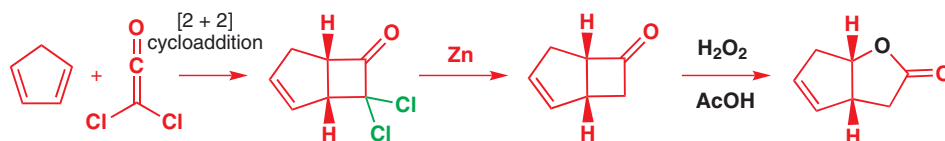

One point to note about both of the last two reactions is that the insertion of oxygen goes with retention of stereochemistry. You may think this is unsurprising in a cyclic system like this and, indeed, the first of the two cannot possibly go with inversion. However, this is a general feature of Baeyer–Villiger reactions, even when inversion would give a more stable product.

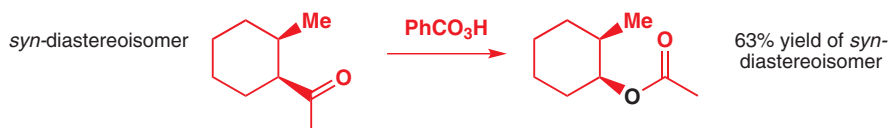

Even when you might imagine that racemization would occur, as in this benzylic ketone, retention is the rule.

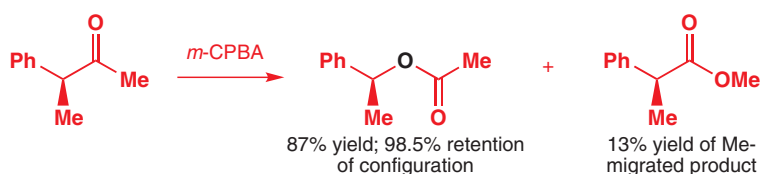

By looking at the orbitals involved, you can see why this must be so. The sp^3 orbital of the migrating carbon just slips from one orbital to the next with the minimum amount of structural reorganization. The large lobe of the sp^3 orbital is used so the new bond forms to the same face of the migrating group as the old one, and stereochemistry is retained.

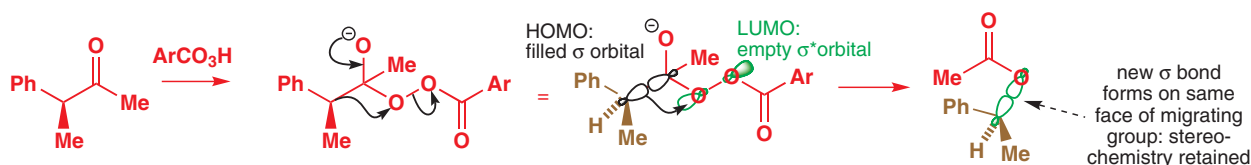

The orbital interactions in all 1,2-migrations are similar, and the migrating group retains its stereochemistry in these too. In the more familiar $\text{S}_{\text{N}}2$ reaction, inversion occurs because the antibonding σ^* orbital rather than the bonding σ orbital is used. In the $\text{S}_{\text{N}}2$ reaction, carbon undergoes *nucleophilic* attack with *inversion*; in rearrangements the migrating carbon atom undergoes *electrophilic* attack with *retention* of configuration.

- In 1,2-migrations, the migrating group retains its stereochemistry.

Which group migrates? (II): the reasons

Why does the more substituted group migrate in the Baeyer–Villiger reaction? The transition state has a positive charge spread out over the molecule as the carboxylate leaves as an anion. If the migrating group can take some responsibility for the positive charge the transition state will be more stable. The more stable the charge, the faster the rearrangement.

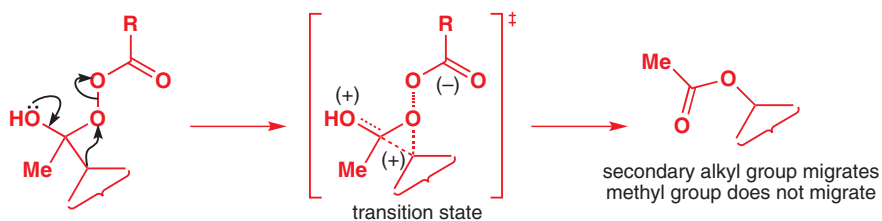

When a benzene ring migrates, π participation is involved as the benzene ring acts as a nucleophile and the positive charge can be spread out even further. Note that the Ph is stabilizing the charge here in the way that it stabilizes the intermediate in an electrophilic aromatic substitution reaction—like a pentadienyl cation rather than like a benzylic cation. What was a transition state in alkyl migration becomes an intermediate in phenyl migration.

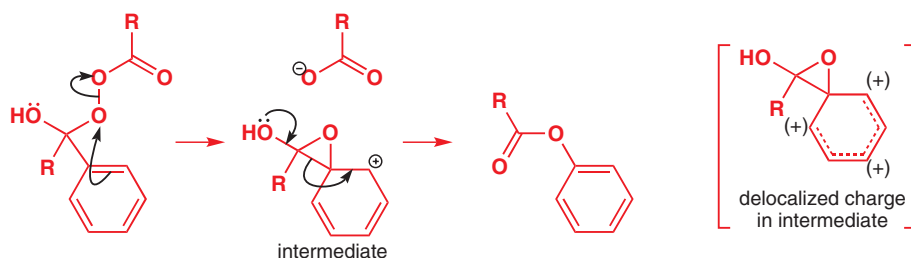

The situation in other rearrangements is much more complicated—and indeed more complicated than many textbooks would have you believe. We shall look just briefly at the dienone-phenol rearrangement again, this time considering reactions in which there is competition between two different migrating groups. As in the Baeyer–Villiger reaction, the transition state is cationic, so you would expect cation-stabilizing groups to migrate more readily. This appears to be true for Ph versus Me, but is most definitely not true for Ph versus CO_2Et . The cation *destabilizing* group CO_2Et migrates even though Ph is much better at stabilizing a positive charge!



The reason is that CO_2Et is so cation *destabilizing* that it prefers to migrate rather than be left behind next door to a cation. In this case, then, it is the cation-stabilizing ability of the group that *does not* migrate that matters most.

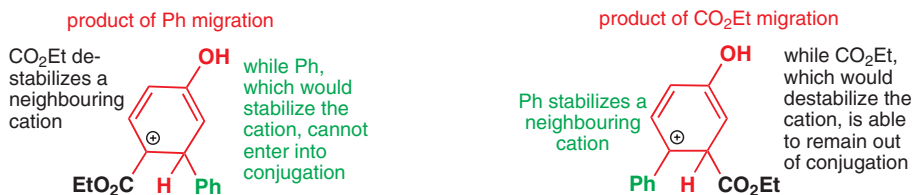

Which group migrates? (III): stereochemistry matters too

Selectivity in rearrangement reactions is affected by the electronic nature of *both* the group that migrates *and* the group that is left behind. But there is more! *Stereochemistry* is important too. The outcome of diazotization and semipinacol rearrangement (Tiffeneau–Demjanov

rearrangement, p. 949) of this amino-alcohol depends entirely on the diastereoisomer you start with. There are four diastereoisomers, and we have drawn each one in the only conformation it can reasonably adopt, with the *t*-butyl group equatorial.

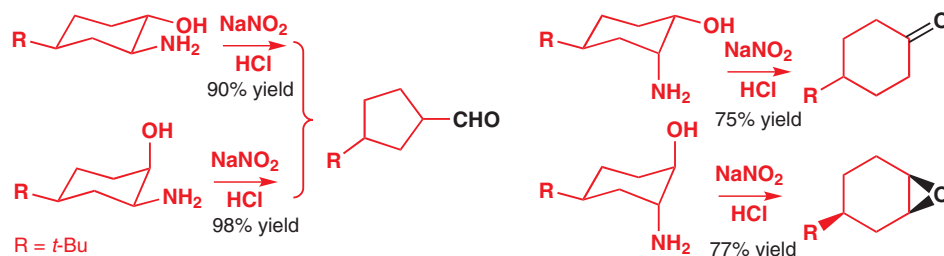

In all of these reactions, the OH group provides the electronic ‘push’. In the first two reactions, the ring contracts by an alkyl migration from the secondary alcohol, while in the third it is H that migrates from the same position.

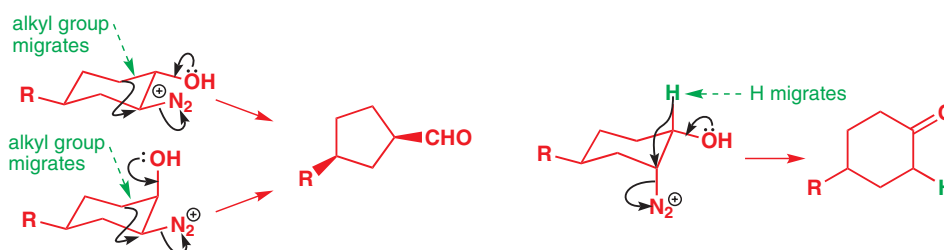

The only difference between the compounds is stereochemistry and, if we look at the orbitals involved in the reactions, we can see why this is so important. As the N_2 leaving group departs, electrons in the bond to the migrating group have to flow into the C–N σ^* orbital—we discussed this on p. 949. But what we didn’t talk about then was the fact that best overlap between these two orbitals (σ and σ^*) occurs if they are anti-periplanar to one another—just as in an E2 elimination reaction.

Interactive explanation of the stereochemistry of rearrangements

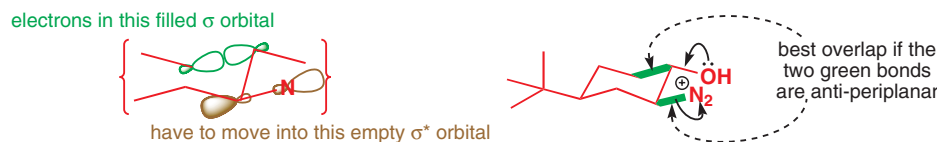

For the first two compounds, with the $-\text{N}_2^+$ group equatorial, the group best placed to migrate is the alkyl group that forms the ring; for the third reaction, there is a hydrogen atom anti-periplanar to the leaving group, so H migrates.

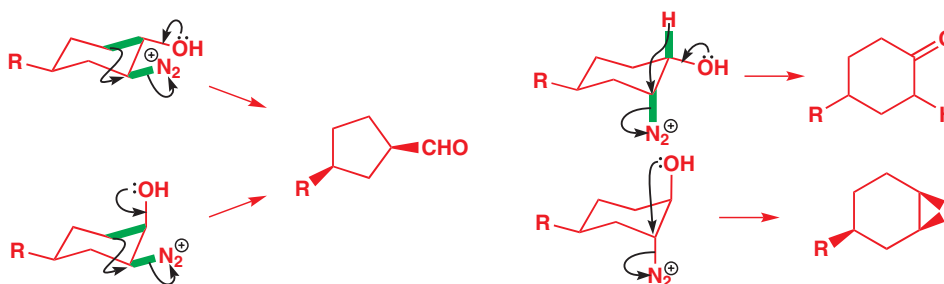

The fourth reaction has, rather than a group that might migrate, the hydroxyl group ideally placed to displace N_2 and form an epoxide.

The requirement for the migrating group to be anti-periplanar to the leaving group is quite general in rearrangement reactions. The reason we haven't noticed its effect before is that most of the compounds we have considered have not been conformationally constrained in the way that these are. Free rotation means that the right geometry for rearrangement is always obtainable—stereochemistry is not a factor in the Baeyer–Villiger reaction, for example. We will come back to some more aspects of stereochemical control later in the chapter, when we deal with fragmentation reactions. Before then, we will consider one last rearrangement reaction, in which stereochemistry again plays an important controlling role.

The Beckmann rearrangement

The industrial manufacture of nylon relies on the alkaline polymerization of a cyclic amide known trivially as caprolactam. Caprolactam can be produced by the action of sulfuric acid on the oxime of cyclohexanone in a rearrangement known as the **Beckmann rearrangement**.

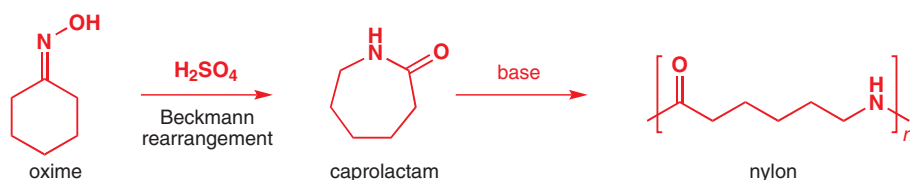

The mechanism of the Beckmann rearrangement follows the same pattern as a pinacol or Baeyer–Villiger reaction: acid converts the oxime OH into a leaving group, and an alkyl group migrates to nitrogen as water departs. The product cation is then trapped by water to give an amide.

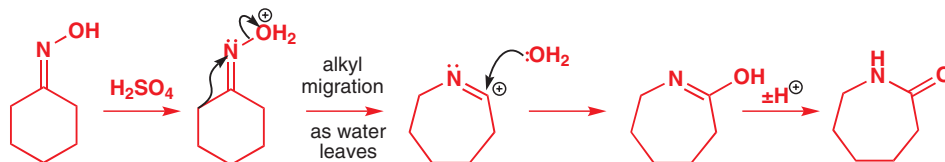

Interactive mechanism for the Beckmann rearrangement

This rearrangement is not confined to cyclic oximes, and other ways of converting OH to a leaving group also work, such as PCl_5 , SOCl_2 , and other acyl or sulfonyl chlorides. In an acyclic Beckmann rearrangement, the product cation is better represented as this nitrilium ion. When we write the mechanism we can then involve the nitrogen's lone pair to 'push' the migrating group back on to N.

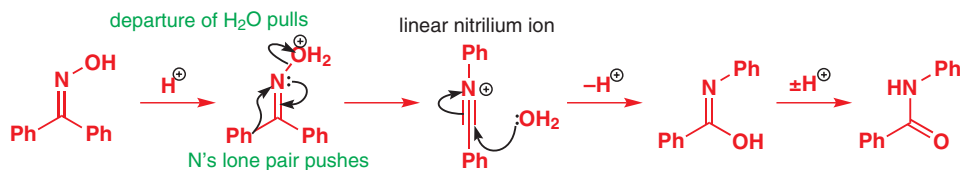

■ A linear nitrilium ion like this is impossible in a seven-membered ring of the last example.

Which group migrates in the Beckmann rearrangement?

In the Beckmann rearrangement of unsymmetrical ketones there are two groups that could migrate. There are also two possible geometrical isomers of an unsymmetrical oxime: $\text{C}=\text{N}$ double bonds can exhibit *cis/trans* isomerism just as $\text{C}=\text{C}$ double bonds can. When mixtures of geometrical isomers of oximes are rearranged, mixtures of products result, but the ratio of products mirrors exactly the ratio of geometrical isomers in the starting materials—the group that has migrated is in each case the group *trans* to the OH in the starting material.

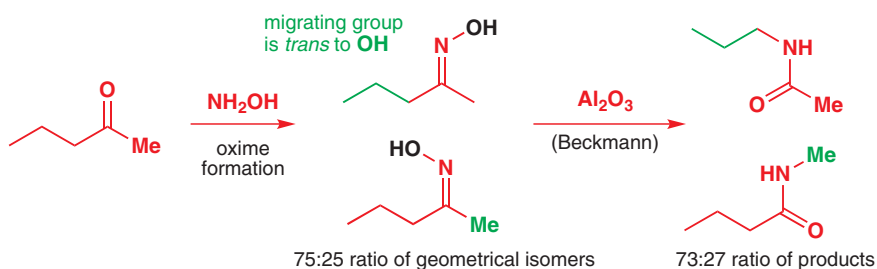

We have already touched on the idea that, for migration to occur, a migrating group has to be able to interact with the σ^* of the bond to the leaving group, and this is the reason for the specificity here. In the example a couple of pages back the stereospecificity of the reaction was due to the starting material being constrained in a conformationally rigid ring. Here it is the C=N double bond that provides the constraint. If one of the alkyl chains is branched, more of the oxime with the OH group *anti* to that chain will be formed and correspondingly more of the branched group will migrate.

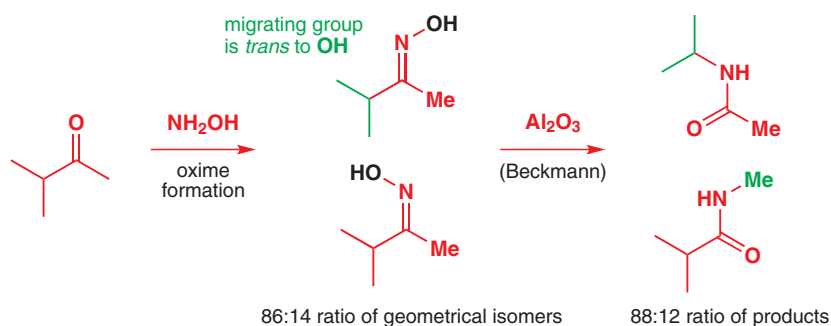

Conditions that allow those double bond isomers to interconvert can allow either group to migrate—which one does so will then be decided, as in the Baeyer–Villiger reaction, by electronic factors. Most protic acids allow the oxime isomers to equilibrate, so, for example, this tosylated oxime rearranges with full stereospecificity in Al_2O_3 (the *anti* methyl group migrates), but with TsOH , equilibration of the oxime geometrical isomers means that either group could migrate—in the event, the propyl group (which is more able to support a positive charge) migrates faster.

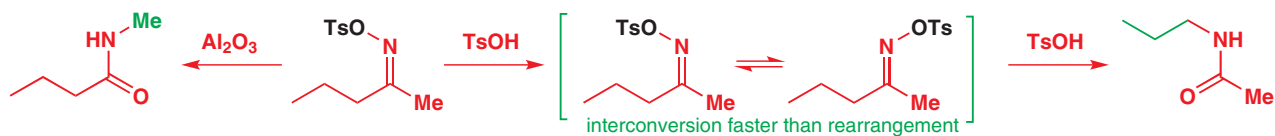

Notice that the effect of the Beckmann rearrangement is to insert a *nitrogen* atom next to the carbonyl group. It forms a useful trio with the Baeyer–Villiger *oxygen* insertion and the diazoalkane *carbon* insertion.

The Beckmann fragmentation

To introduce the theme of the last section of this chapter, a Beckmann rearrangement that is not all that it seems. *t*-Butyl groups migrate well in the Baeyer–Villiger reaction and, indeed, Beckmann rearrangement of the compound in the margin appears to be quite normal too. But, when this compound and another compound with a tertiary centre next to the oxime are mixed together and treated with acid, it becomes apparent that what is happening is not an intramolecular reaction.

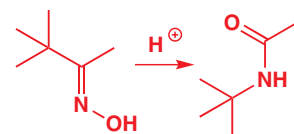

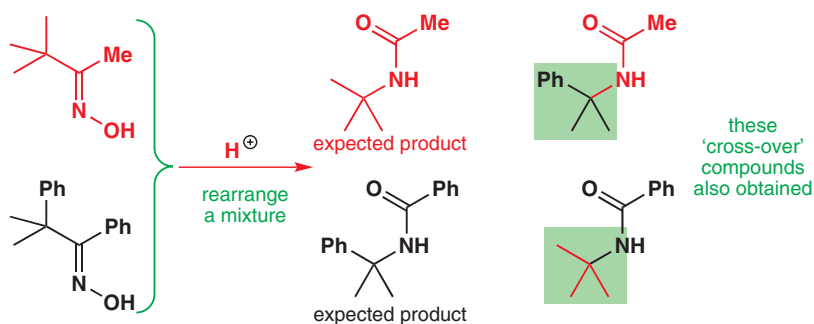

Each migrating tertiary group must have lost contact with the amide fragment it started out with. The molecule must fall apart to give a *t*-alkyl cation and a nitrile: the Beckmann rearrangement now goes via a fragmentation mechanism.

■ The recombination step of this reaction is really just a Ritter reaction: reaction of a nitrile with a carbocation. You came across the Ritter reaction on p. 353.

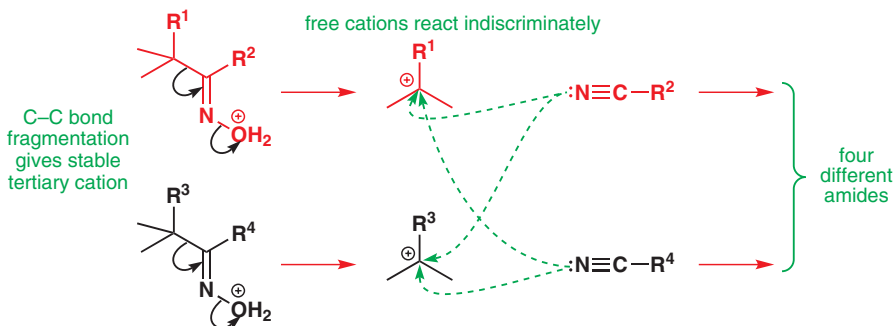

Migrating groups have to provide some degree of cation stabilization. But if they stabilize a cation *too well* there is a good chance that fragmentation will occur and the 'migrating group' will be lost as a carbocation.

Here is a more convincing example of the same fragmentation reaction: the conditions, but not the results, are those of a Beckmann rearrangement. In this reaction, the ring structure means the cation cannot be trapped by the nitrile, and a fragmentation product is isolated.

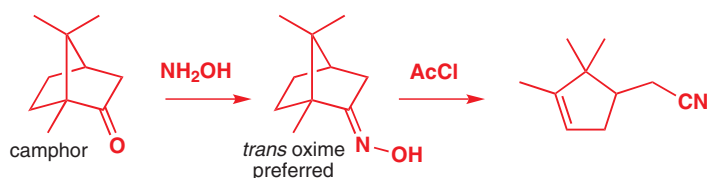

Beckmann rearrangements that go with fragmentation are sometimes called 'anomalous' or 'second-order' Beckmann rearrangements. You should not use the second of these names and, in any case, **Beckmann fragmentation** is much better than either.

The mechanism is straightforward once you know what happens to Beckmann rearrangements when the migrating group is tertiary—but hard to follow unless you number the atoms!

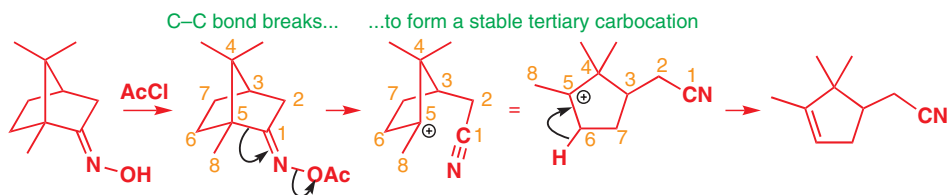

Interactive mechanism for Beckmann fragmentation

Polarization of C–C bonds helps fragmentation

Up to now, you have met few fragmentation reactions—reactions in which C–C bonds are broken—largely because the C–C bond is so strong. Why then does the Beckmann

fragmentation work? Well, the reason C–C bonds are hard to break is not just because of their strength, as the table of bond energies indicates.

For both carbon and hydrogen, a bond to oxygen is *stronger* than a bond to carbon. Yet we have no hesitation in breaking O–H bonds (of, say, carboxylic acids) with even the weakest of bases and we have spent much of this chapter showing C–O bonds of protonated alcohols rupturing spontaneously! What is going on?

The answer is **polarization**. Oxygen's electronegativity means that C–O and O–H bonds are polarized and are easy to break with hard nucleophiles and bases; C–C and C–H bonds are (usually) not polarized and, although weaker, are harder to break. It follows that to break a C–C bond it helps a lot if it is polarized—there needs to be a source of electrons at one end and an electron 'sink' (into which they can flow) at the other.

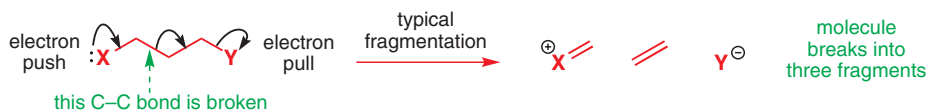

Fragmentations require electron push and electron pull

Fragmentations are reactions in which the molecule breaks open by the cleavage of a C–C single bond, and we start this section with some examples. Both diastereoisomers of this cyclic diol fragment in acid to give an aldehyde.

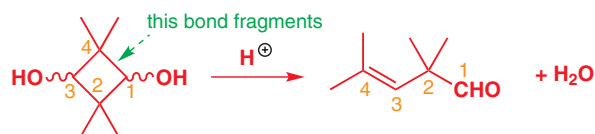

Numbering the atoms shows which bond fragments—now we need to provide a source and a sink for the electrons to polarize the bond. Protonation of a hydroxyl group provides the sink—it can now leave as water. And the lone pair of the other oxygen provides the source. You can think of the electrons in the C–C bond being 'pushed' by the oxygen's lone pair and 'pulled' by the departing water—until the bond breaks. A bit of extra impetus comes from release of ring strain: C–C bonds in three- and four-membered rings are weaker than usual (by about 120 kJ mol⁻¹).

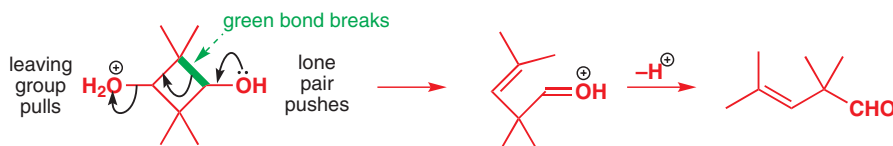

We talked about 'pushing' and 'pulling' electrons when we introduced the pinacol rearrangement, and a very similar thing is happening here *but* the electron source and sink are *separated by one atom* instead of being *adjacent*.

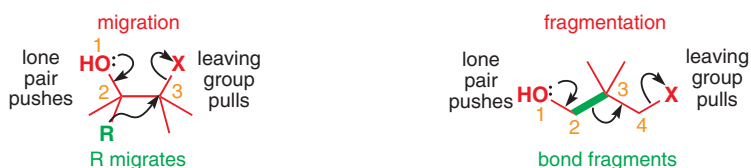

Protonated carbonyl compounds can be electron sinks too (remember the dienone-phenol rearrangement?) and this bicyclic methoxy ketone fragments to a seven-membered ring in acid. Note the same 1, 2, 3, 4 arrangement, with the bond between carbon atoms 2 and 3 fragmenting.

Bond	Typical bond energy, kJ mol ⁻¹
C–C	339
C–O	351
C–H	418
O–H	460

The bond energies listed in the table are the energies required to break the bonds **homolytically** to give two radicals, not **heterolytically** to give two ions. We will look at homolytic fragmentation in much more detail in the next chapter.

Interactive fragmentation mechanisms relying on bond polarization

Note the numbering in these diagrams: 1, 2, 3, 4 from electron source to electron sink. We shall make use of it in many more fragmentation mechanisms.

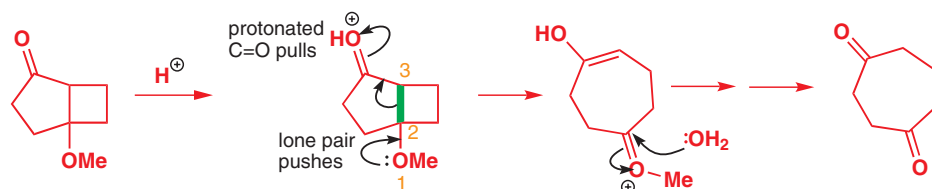

A leaving group such as mesylate can exercise the ‘pull’ and in the next example a carbonyl group provides the ‘push’ after it has been attacked by a nucleophile. This five-membered cyclic ketone fragments on treatment with base—can you detect hints of the benzylic acid rearrangement?

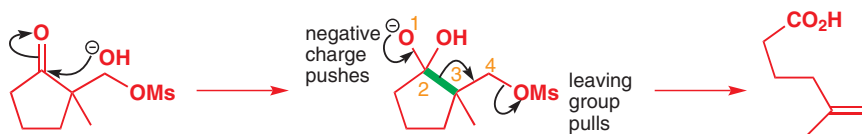

Analysing the Beckmann fragmentation on p. 960 in the same way, we can identify the electron sink (the departing acetate group), although the source in this case is a little more obscure. Saying that the tertiary cation is stable is really saying that the neighbouring C–C and C–H bonds provide electrons (through σ conjugation, see p. 334) to stabilize it, so these are the electron sources (the ‘push’). A good alternative is to write loss of a proton concerted with fragmentation, which gives one particular C–H bond as the source of electrons.

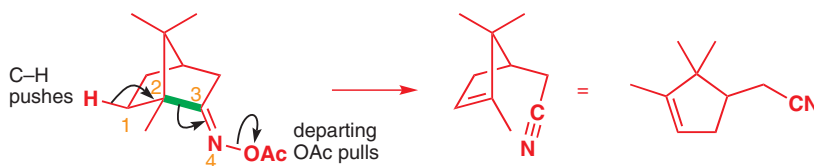

The retro-aldol is a fragmentation reaction

We should perhaps remind you here of the reversibility of the aldol reaction (Chapter 26): a retro-aldol is a fragmentation reaction with a carbonyl group as electron sink and OH as electron source. The aldol reaction usually goes in the other direction of course, but where steric or ring-strain factors are involved, this may not be the case.

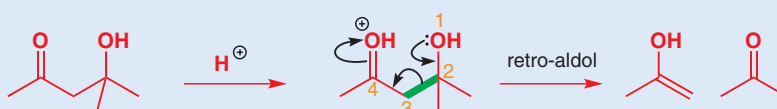

Fragmentations are controlled by stereochemistry

The control of rearrangements can be stereoelectronic in origin—if a molecule is to rearrange, orbitals have to be able to overlap. This means that, for a Beckmann *rearrangement*, the migrating group has to be *trans* to the leaving group. Not surprisingly, the same is true for Beckmann fragmentations like the one at the end of the last section, where the green fragmenting bond is *trans* to the leaving group. Before we extend these ideas any further, consider these two quite different reactions of quite similar compounds.

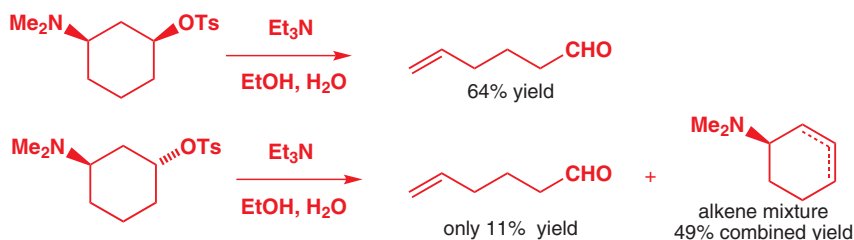

Just as with the rearrangements we looked at on p. 933, we need to draw these compounds in reasonable chair conformations in order to understand what is going on. In the *cis* isomer, both substituents can be equatorial; in the *trans* isomer one has to be axial, and this will be mainly the OTs group, since the two methyl groups of NMe₂ suffer greater 1,3-diaxial interactions.

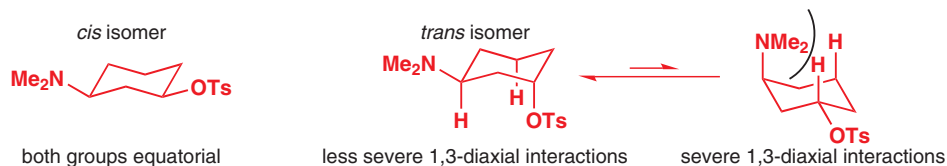

Now, the *cis* isomer has clearly undergone a fragmentation reaction and, as usual, numbering the atoms can help to identify the bond that breaks. The nitrogen lone pair pushes, the departing tosylate pulls, and the resulting iminium ion hydrolyses to the product aldehyde.



Yet the *trans* isomer does this only in very low yield. Mostly it eliminates TsOH to give a mixture of alkenes. Why? Well, notice that, in the *cis* isomer, the fragmenting bond is *trans* to the leaving group—indeed, it is both parallel and *trans* (in other words anti-periplanar) to the leaving group. Electrons can flow smoothly from the breaking σ bond into the σ^* of the C–OTs bond, forming as they do so a new π bond.

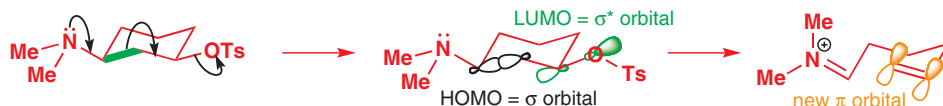

For the *trans* isomer, fragmentation of the most populated conformation is impossible because the leaving group is not anti-periplanar to any C–C bond. The only bonds anti-periplanar to OTs are C–H bonds, making this compound ideally set up for another reaction whose requirement for anti-periplanarity you have already met—E2 elimination.

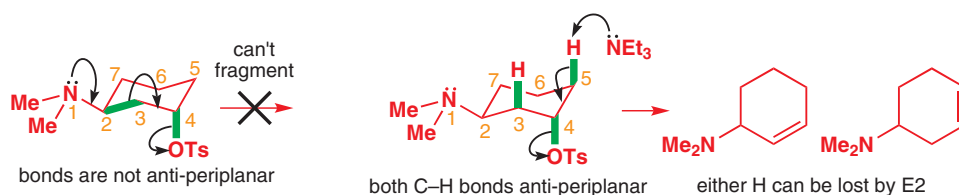

The other conformation can fragment because now the OTs is anti-periplanar to the right C–C bond, and this is probably where the 11% fragmentation product comes from.

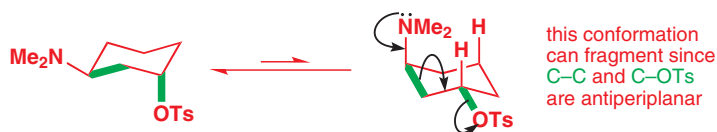

Ring expansion by fragmentation

Ring sizes greater than eight are hard to make. Yet five- and six-membered rings are easy to make. Once you realize that a fused pair of six-membered rings is really a ten-membered ring with a bond across the middle, the potential for making medium rings by fragmentation becomes apparent.

6,6-fused decalin

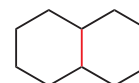

outer ten-membered ring

Interactive explanation of the stereochemistry of fragmentations

All you need to do is to make the bond to be broken the 2–3 bond in a 1, 2, 3, 4 electron source-sink arrangement and the ten-membered ring should appear out of the wreckage of the fragmentation. Here is an example:

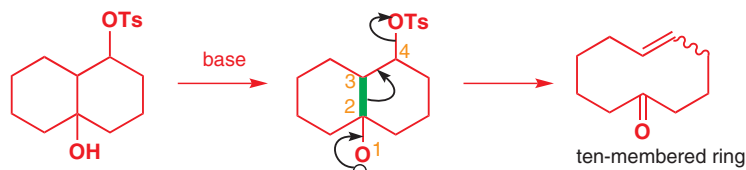

Interactive mechanism for ring expansion by fragmentation

This is the simple overall result, but there is more to explore. The starting hydroxytosylate can exist as four diastereoisomers: two *trans*-decalins and two *cis*-decalins. What is more, the product has a double bond in a ten-membered ring: will it be *cis* or *trans*? (Both are possible in a ring with more than eight members: see Chapter 29.) One of the four diastereoisomers of the starting material cannot place the tosylate anti-periplanar to the ring-fusion bond, so it can't fragment. The other three diastereoisomers all can, but two of them give a *trans* double bond while the third gives *cis*.

➔ We discussed the conformations of decalins in Chapter 16.

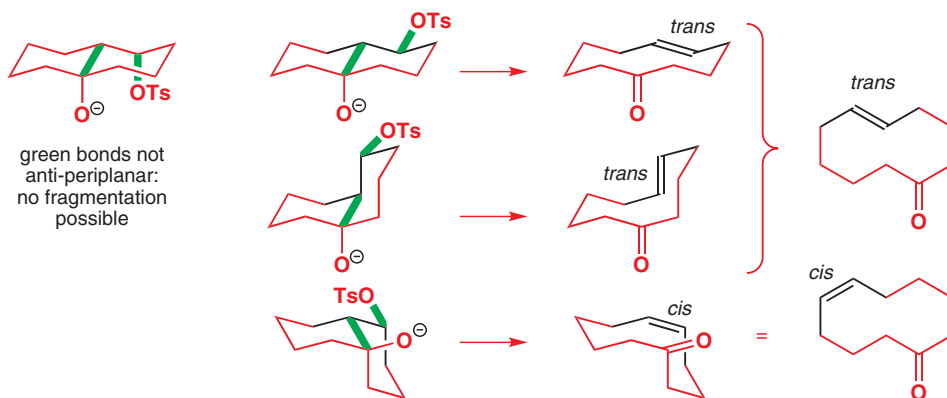

Interactive explanation of the importance of stereochemistry in ring expansions

Looking at the alignment of the bonds that end up flanking the double bond in the product shows you where the geometrical isomers come from: these are the black bonds in the starting material, and are *trans* across the forming π system in the first two isomers and *cis* in the third. Fragmentations are stereospecific with regard to double-bond geometry, much as E2 elimination reactions are.

Caryophyllene by fragmentation

Corey applied this stereospecificity in conjunction with a ring expansion reaction to make the natural product caryophyllene. Caryophyllene is a bicyclic molecule with a nine-membered ring containing an *E* trisubstituted double bond. The right relative stereochemistry in the starting material leads both to fragmentation of the right bond and to formation of the alkene with the right stereochemistry.

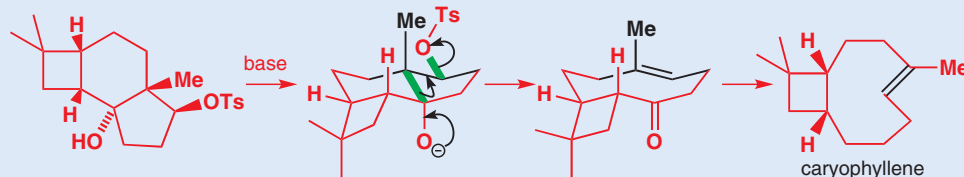
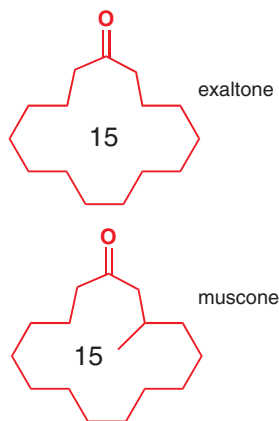

Muscone and exaltone are important perfumery compounds with even-harder-to-make 15-membered ring structures. Cyclododecanone is commercially available: addition of a fused five-membered ring and fragmentation of the 12,5-ring system is a useful route to these 15-membered ring compounds.

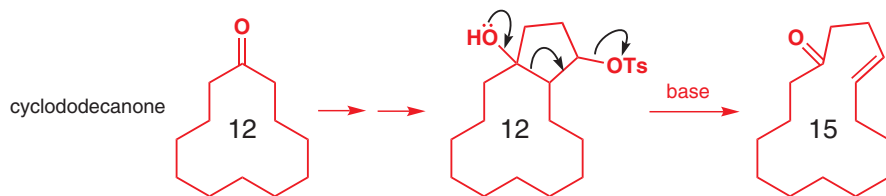

The Eschenmoser fragmentation

In the late 1960s, the Swiss chemist Albert Eschenmoser discovered an important reaction that can be used to achieve similar ring expansions and that now bears his name, the Eschenmoser fragmentation. The starting material for an Eschenmoser fragmentation is the epoxide of an α,β -unsaturated ketone. The fragmentation happens when this epoxyketone is treated with tosylhydrazine, and one of the remarkable things about the product is that it is an alkyne. The fragmentation happens across the epoxide (shown in black), and the product contains both a ketone (in a different place from the ketone in the starting material) and an alkyne. You can see how in this case hydrogenation of the triple bond can give muscone ($R=Me$) or exaltone ($R=H$).

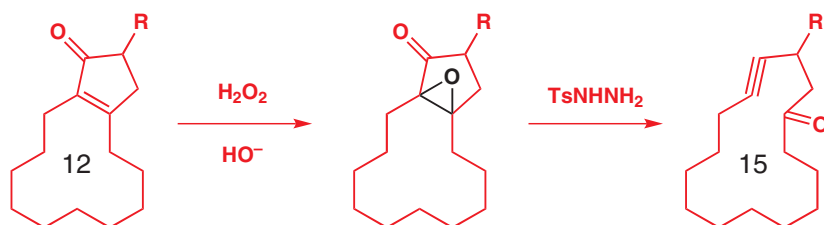

The Eschenmoser fragmentation does not have to be a ring expansion, and it is a useful synthetic method for making keto-alkynes. The following reaction, which we will use to discuss the fragmentation's mechanism, was used to make an intermediate in the synthesis of an insect pheromone, *exo*-brevicomin.



The reaction starts with formation of the tosylhydrazone from the epoxyketone. The tosylhydrazone is unstable with respect to opening of the epoxide in an elimination reaction, and it is this elimination that sets up the familiar 1, 2, 3, 4 system ready for fragmentation. The 'push' comes from the newly created hydroxyl group, and the 'pull' from the irresistible concerted loss of a good leaving group (Ts^-) and an even better one (N_2). Notice how all the (green) bonds that break are parallel to one another, held anti-periplanar by two double bonds. Perfect!

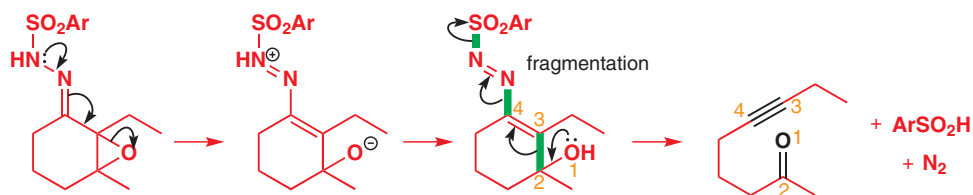

Controlling double bonds using fragmentation

Juvenile hormone (a compound you met in Chapter 27, p. 677) is a compound whose synthesis presents a major challenge: it requires the control of three trisubstituted double bonds (one of which ends up as an epoxide). The key intermediate shown contains two of them.

Albert Eschenmoser (1925–), working at the ETH in Zurich, synthesized vitamin B₁₂, at the time (1973) the most complicated molecule yet made, in what was for that era an unusual international collaboration with Woodward at Harvard.

■ The epoxyketones are made by epoxidizing the electron-poor enones with basic hydrogen peroxide, see Chapter 22.

■ The sulfur-containing leaving group here is not toluenesulfonate (tosylate, or TsO^-) but toluenesulfinate ($ArSO_2^-$ or Ts^-), giving toluenesulfonic acid (TsH or $ArSO_2H$), not toluenesulfonic acid ($TsOH$ or $ArSO_3H$) as a by-product.

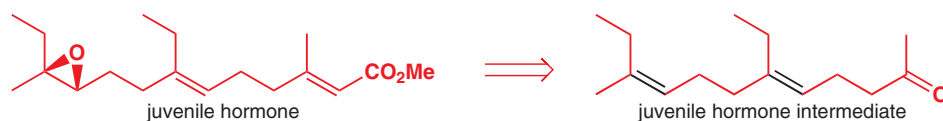

The chemists who succeeded in making this compound reasoned that, if this intermediate could be made stereospecifically by fragmenting a cyclic starting material, the (hard-to-control) double-bond stereochemistry would derive directly from the (easier-to-control) relative stereochemistry of the cyclic compound. The starting material they chose was a 5,6-fused system, which fragments to give one of the double bonds.

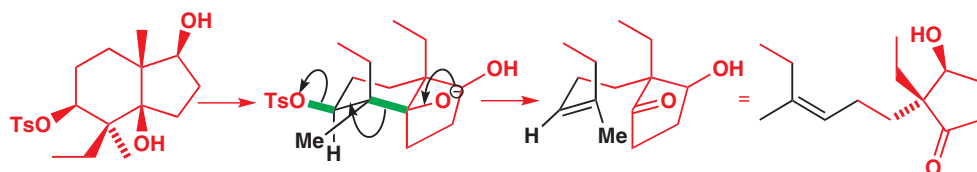

Interactive synthesis of juvenile hormone by fragmentations

The product of this reaction is prepared for another fragmentation by addition of methyl-lithium (you might like to consider why you get this diastereoisomer) and tosylation of the less hindered secondary alcohol. Base promotes the second fragmentation and gives the ketone with the two double bonds in place.

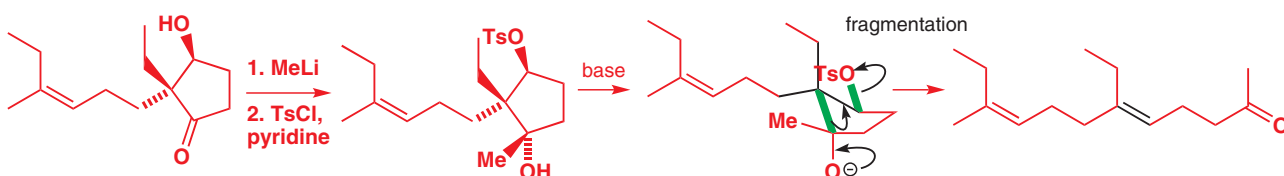

In the next chapter you will meet, among many other reactions, more fragmentations, but they will be radical fragmentations rather than ionic fragmentations, and involve homolytic cleavage of C–C bonds.

The synthesis of nootkatone: fragmentation showcase

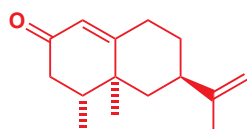

nootkatone
supposed flavour
principle of grapefruit

To finish this chapter, we will present three different synthetic routes to the same compound, all of which illustrate the power of fragmentation in the synthesis of cyclic compounds. The story starts with grapefruit, which contains a simple bicyclic enone called nootkatone. It was assumed, wrongly as it happens, that the scent of grapefruit came from this compound, and in the 1970s there was quite a rush to synthesize this compound in various laboratories. A remarkable feature of many successful syntheses was the use of fragmentation reactions. We shall describe parts of three syntheses involving the fragmentation of a six-, a four-, and a three-membered ring.

Most syntheses make the side-chain alkene by an elimination reaction so the first 'disconnection' is an FGI adding HX back into the alkene. The last C–C bond-forming operation in most syntheses is an intramolecular aldol reaction to make the enone so that can be disconnected next. It is the starting material for the aldol, a simple monocyclic diketone, which is usually made by a fragmentation reaction because this is a good way to set up the stereochemistry.

The terminology ('disconnection', 'FGI') in this paragraph derives from Chapter 28.

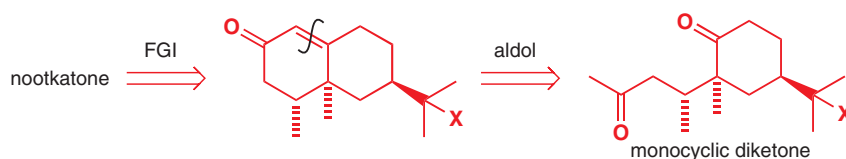

Fragmentation of a three-membered ring

This synthesis does not look as though it will lead to nootkatone because the fragmentation product still requires a great deal of modification. It has the advantage that the stereochemistry is correct at one centre at least. The sequence starts from natural (–)-carone: conjugate addition of the enolate to butenone without control leads to a bicyclic diketone with one extra stereogenic centre. The enone adds to the bottom face of the enolate opposite the dimethylcyclopropane ring so the methyl group is forced upwards.

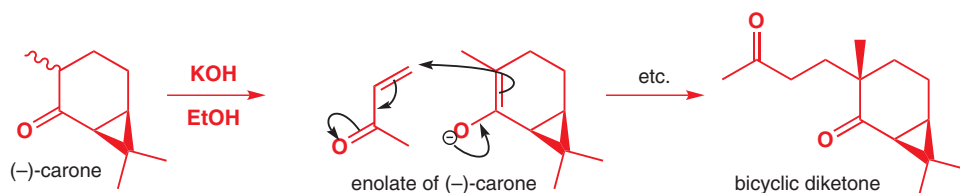

Now the diketone is cyclized by a Robinson-style aldol condensation in HCl to give a bicyclic enone. But during the reaction, a new six-membered ring has been formed while the old three-membered ring has disappeared, evidently by fragmentation.

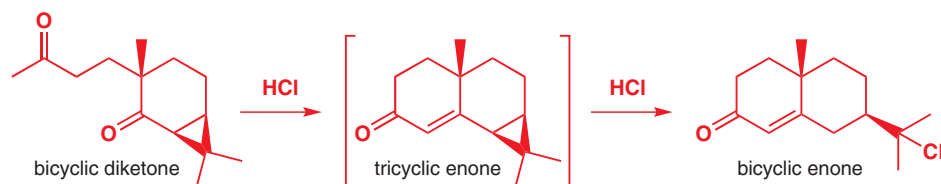

The fragmentation is pulled by the enone (with some help from the acid) and pushed by the stability of a tertiary carbocation as well as the release of strain as the single bond that is fragmented is in a three-membered ring.

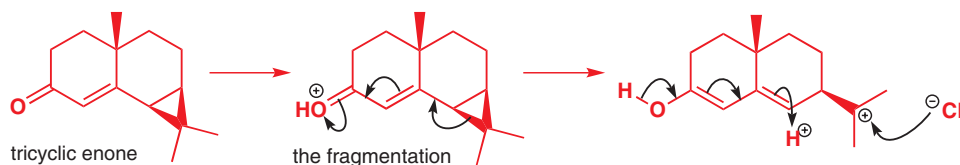

Addition of a proton to the end of the enol and a chloride ion to the cation gives the product. The further development of this compound into nootkatone is beyond the scope of this book.

Fragmentation of a four-membered ring

This approach leads directly to the enone needed for nootkatone. A diketone prepared from a natural terpene is also treated with HCl and much the same reactions ensue except that the fragmentation now breaks open a four-membered ring. First, the intramolecular aldol reaction to make the second six-membered ring.

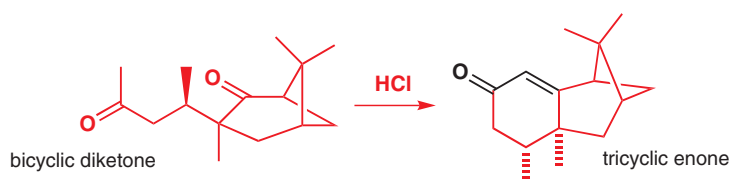

Now the fragmentation, which follows much the same course as the last one: the enone again provides the electron pull while the cleavage of a strained C–C single bond in a four-membered ring to give a tertiary carbocation provides the electron push. A simple elimination is all that is needed to make nootkatone from this bicyclic chloroenone.

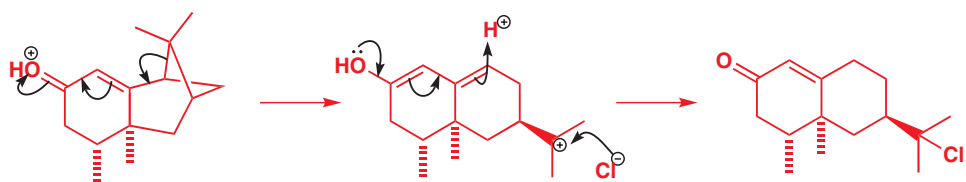

Fragmentation of a six-membered ring

This chemistry is quite different from the examples we have just seen. The starting material has a bridged bicyclic structure and was made by a Diels–Alder reaction. Fragmentation is initiated by formic acid (HCO_2H), which protonates the tertiary alcohol and creates a tertiary carbocation. The ether provides the push. More serious electronic interactions are needed in this fragmentation as the C–C bond being broken is not in a strained ring.

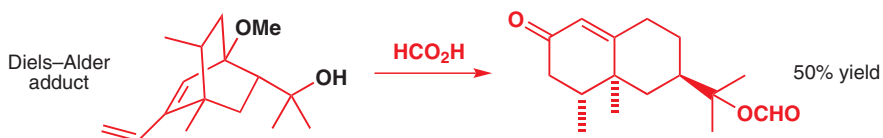

The yield of 50% may not seem wonderful, but there is obviously a lot of chemistry going on here so it is perfectly acceptable when so much is being achieved. The first stage is the fragmentation itself. Drawing the product first of all in the same shape as the starting material and then redrawing, to ensure that we don't make a mistake, we discover that we are well on the way to nootkatone. Note that the stereochemistry of the two methyl groups comes directly from the stereochemistry of the starting materials and no new stereogenic centres are created in the fragmentation. Although one six-membered ring is fragmented, another remains.

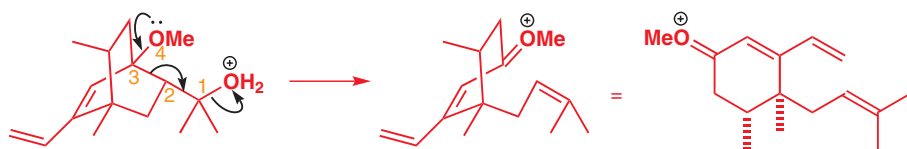

The first-formed product now cyclizes to form the second six-membered ring. This recreates a carbocation at the tertiary centre like the one that set off the fragmentation as the more nucleophilic end of the isolated alkene attacks the end of the conjugate electrophile. This is a thermodynamically controlled reaction with the new stereogenic centre choosing to have an equatorial substituent.

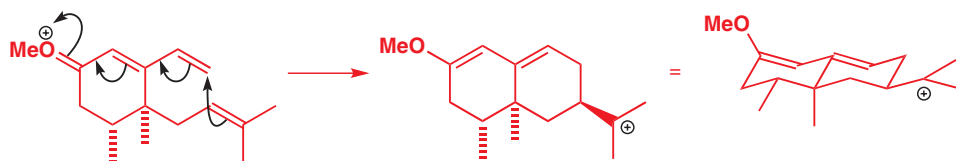

The cation picks up the only nucleophile available—formic acid. This gives the product of the fragmentation, which contains two unstable functional groups—a tertiary formate ester and an enol ether—and this product is not isolated from the reaction mixture. In water it hydrolyses to the enone, which undergoes elimination of formate to give nootkatone on heating.

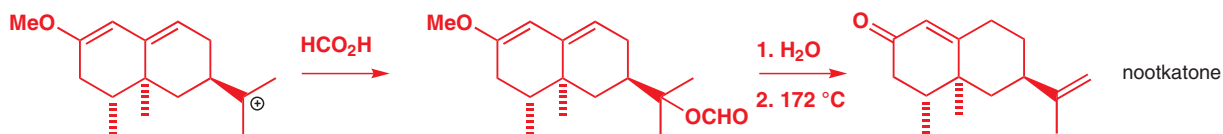

Yet after all this effort, none of the synthetic samples of nootkatone delivered that intense grapefruit smell—for the simple reason that nootkatone is not the flavour principle of grapefruit! The samples of nootkatone that had been isolated from grapefruit contained minute traces of the true flavour principle—a simple thiol. Humans can detect 2×10^{-5} ppb (parts per billion) of this compound, so even the tiniest trace is very powerful. Nonetheless, the syntheses allowed chemists to correct a misconception.

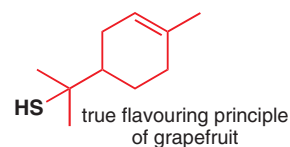

Looking forward

Fragmentation reactions cleave C–C single bonds by a combination of electron push and electron pull so that both electrons in the bond move in the same direction as the bond breaks. In the next chapter we shall see reactions that break C–C bonds in a quite different way. No electron push or pull is required because one electron goes one way and one the other. These are radical reactions.

Further reading

F. A. Carey and R. J. Sundberg, *Advanced Organic Chemistry, Part A, Structure and Mechanisms*, Springer, 5th edn, 2007, part A. *Polar Rearrangements*, L. M. Harwood, Oxford Primer, OUP, 1992.

S. Warren and P. Wyatt, *Organic Synthesis: the Disconnection Approach*, 2nd edition, Wiley, Chichester, 2008, chapter 31.
T.-L. Ho, *Heterolytic Fragmentation of Organic Molecules*, Wiley, 1993.

Check your understanding



To check that you have mastered the concepts presented in this chapter, attempt the problems that are available in the book's Online Resource Centre at <http://www.oxfordtextbooks.co.uk/orc/clayden2e/>

37

Radical reactions

Connections

➔ Building on

- Energy profile diagrams [ch12](#)
- Nucleophilic substitution [ch15](#)
- Conformational analysis [ch16](#)
- Elimination reactions [ch17](#)
- Conjugate addition [ch22](#)
- Regioselectivity [ch24](#)
- Retrosynthetic analysis [ch28](#)
- Diastereoselectivity [ch32 & ch33](#)
- Main group chemistry [ch27](#)

Arriving at

- Radicals are species with unpaired electrons
- Radical reactions follow different rules to those of ionic reactions
- Bond strength is very important
- Radicals can be formed with I, Br, Cl, Sn, and B
- Efficient radical reactions are chain reactions
- There are electrophilic and nucleophilic radicals
- Radicals favour conjugate addition
- Cyclization is easy with radical reactions

➔ Looking forward to

- Carbene chemistry [ch38](#)
- Determination of mechanism [ch39](#)
- Natural products [ch42](#)
- Polymerization [web](#)

Radicals contain unpaired electrons

You may remember that at the beginning of Chapter 8 we said that the cleavage of H–Cl into H^+ and Cl^- is possible in solution only because the ions that are formed are solvated: in the gas phase, the reaction is endothermic with $\Delta G = +1347 \text{ kJ mol}^{-1}$, a value so vast that even if the whole universe were made of gaseous HCl at 273 K, not a single molecule would be dissociated into H^+ and Cl^- ions. At temperatures above about 200 °C, however, HCl does begin to dissociate, but not into ions. Instead of the chlorine atom taking both bonding electrons with it, leaving a naked proton, the electron pair forming the H–Cl bond is shared out between the two atoms. ΔG for this reaction is a much more reasonable $+431 \text{ kJ mol}^{-1}$ and, at high temperatures (above about 200 °C, that is), HCl gas can be dissociated into H and Cl atoms.

■ The single, unpaired electron possessed by each atom is represented by a dot. The Cl atom, of course, has another three pairs of electrons that are not shown.

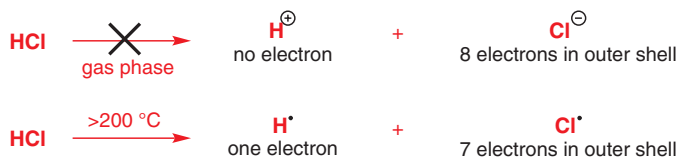

● Heterolysis and homolysis

- When bonds break and one atom gets both bonding electrons, the process is called **heterolysis**. The products of heterolysis are, of course, **ions**.
- When bonds break and the atoms get one bonding electron each, the process is called **homolysis**. The products of homolysis are **radicals**, which may be atoms or molecules, but must contain an unpaired electron.

Online support. The icon  in the margin indicates that accompanying interactive resources are provided online to help your understanding: just type www.chemtube3d.com/clayden/123 into your browser, replacing **123** with the number of the page where you see the icon. For pages linking to more than one resource, type **123-1, 123-2** etc. (replacing **123** with the page number) for access to successive links.

In Chapter 24 we introduced the fact that bromine radicals react regioselectively with alkenes. Let us remind you of one reaction you met then: radical addition to an alkene. The product is an alkyl bromide, and is a different alkyl bromide from the one formed when HBr adds to an alkene in an ionic manner.

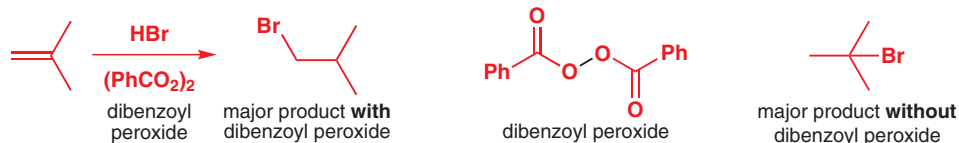

What does the peroxide do to change the mechanism of the reaction? Peroxides undergo homolysis of the weak O–O bond extremely easily to form two radicals. We said that HCl in the gas phase undergoes homolysis in preference to heterolysis: other types of bond are even more susceptible to homolysis. You can see this for yourself by looking at this table of bond dissociation energies (ΔG for $\text{X}-\text{Y} \rightarrow \text{X}^\bullet + \text{Y}^\bullet$).

Bond X–Y	ΔG for $\text{X}-\text{Y} \rightarrow \text{X}^\bullet + \text{Y}^\bullet$, kJ mol ⁻¹	Bond X–Y	ΔG for $\text{X}-\text{Y} \rightarrow \text{X}^\bullet + \text{Y}^\bullet$, kJ mol ⁻¹
H–OH	498	CH ₃ –Br	293
H ₃ C–H	435	CH ₃ –I	234
H ₃ C–OH	383	Cl–Cl	243
H ₃ C–CH ₃	368	Br–Br	192
H–Cl	431	I–I	151
H–Br	366	HO–OH	213
H–I	298	MeO–OMe	151
CH ₃ –Cl	349		

Dialkyl peroxides (dimethyl peroxide is shown in the table) contain the very weak O–O bond. The radicals formed by homolytic cleavage of these bonds, stimulated by a little heat or light, initiate what we call a **radical chain reaction**, which results in the formation of the Br[•] radicals, which add to the alkene's C=C double bond (see Chapter 24).

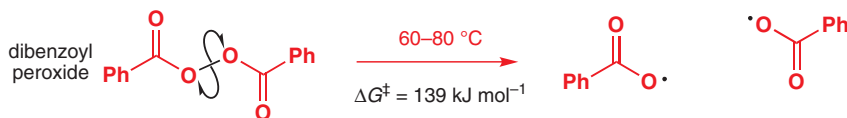

Radicals form by homolysis of weak bonds

This is the most important way of making radicals: unpairing a pair of electrons by homolysis, making two new radicals. Temperatures of over $200\text{ }^\circ\text{C}$ will homolyse most bonds; on the other hand, some weak bonds will undergo homolysis at temperatures little above room temperature. Light is a possible energy source for the homolysis of bonds too. Red light has associated with it 167 kJ mol^{-1} ; blue light has about 293 kJ mol^{-1} . Ultraviolet (200 nm), with an associated energy of 586 kJ mol^{-1} , will decompose many organic compounds (including the DNA in skin cells: sunbathers beware!).

There are a number of compounds whose homolysis is particularly important to chemists, and the most important ones are discussed in turn below. They all have weak σ bonds, and generate radicals that can be put to some chemical use. The halogens are quite readily homolysed by light, as you can see from the bond strengths in the table above, a fact that drives the radical halogenation reactions that we shall discuss later.

As you saw in Chapter 24, dibenzoyl peroxide is an important compound because it can act as another initiator of radical reactions. It undergoes homolysis simply on heating.

➔ Now would be a good time to revisit the section on radicals in Chapter 24 and to re-read pp. 571–574. Ionic additions to alkenes are covered in Chapter 19.

■ Try to get a feel for bond strengths: we shall refer to them a lot in this chapter as they're very important to radical reactions. Compare this with the situation for ionic reactions, in which the strengths of the bonds involved are often much less important than polar effects (see the example on p. 207).

It is not sufficient for light to be energetic enough to promote homolysis; the molecule must have a mechanism for absorbing that energy, and the energy must end up concentrated in the vibrational mode that leads to bond breakage. We shall not consider these points further: if you are interested, you will find detailed explanations in specialized books on photochemistry.

Another compound that is often used in synthetic reactions for the same reason (although it reacts with a different set of compounds) is AIBN (azobisisobutyronitrile).

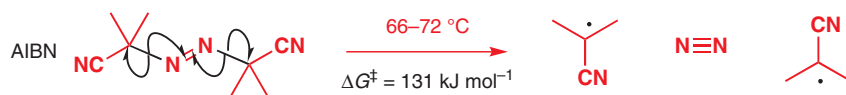

■ ΔG^\ddagger is the activation energy for the reaction.

This decomposition mechanism accounts for the separate movements of all the electrons, but we can also draw the mechanism in a slightly different way: we show two radical ('fish hook') arrows forming the molecule of nitrogen but only one arrow to break each of the C–N bonds. It can be assumed that the electrons 'left behind' form radicals as well.

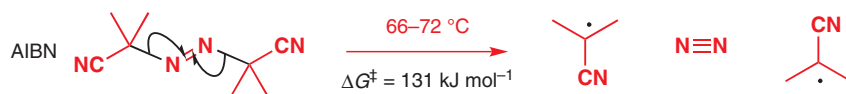

Another way of cutting back on the number of arrows without losing precision in the mechanism is to draw one arrow for each step all in the same (which can be either) direction. The first mechanism has the advantage of complete clarity; the other two make for neater diagrams. Choose which suits you best.

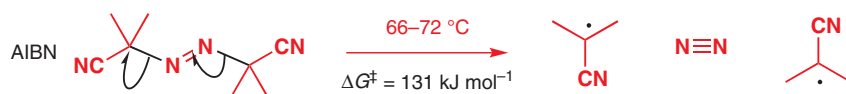

The important thing is to use the right type of arrow and to make it clear whether you are moving one, and not two, electrons. A simpler example is the abstraction of a hydrogen atom by an oxygen-centred radical: any of the mechanisms below is fine.

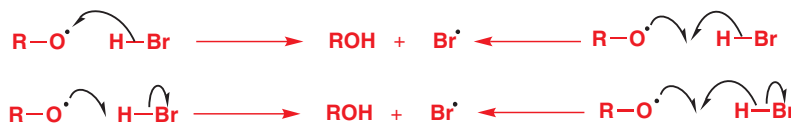

Radicals form by abstraction

Notice that we didn't put HBr on the list of molecules that form radicals by homolysis: relative to the weak bonds we have been talking about, the H–Br bond is quite strong (just about as strong as a C–C bond). We described in Chapter 24 how oxygen radicals abstract hydrogen atoms from HBr. You might now like to compare this mechanism with similar ionic reactions.



Hydrogen abstraction is the removal of a hydrogen atom **with its one electron**. It is not the removal of a proton: that would be the removal of a hydrogen atom **with no electrons**, which happens in ionic reactions.

The ability of radicals to propagate by abstraction is a key feature of radical chain reactions, which we shall come to later. There is an important difference between homolysis and abstraction as a way of making radicals: homolysis is a reaction of a spin-paired molecule that produces *two* radicals; abstraction is a reaction of a radical with a spin-paired molecule that produces *one* new radical and a new spin-paired molecule.

■ We use the term 'spin-paired molecule' to mean a 'normal' molecule, in which all the electrons are paired, in contrast with a radical, which has an unpaired electron.

As the comparison above shows, radical abstractions are in fact substitution reactions (at H in this case). However, radical substitutions differ considerably from S_N1 or S_N2 reactions: importantly, *radical substitutions almost never occur at carbon atoms*. We shall come back to radical substitutions, or abstractions (depending on whether you take the point of view of the H atom or the Br atom), and explain why this should be, later in the chapter.

First radical detected

The very first radical to be detected, the triphenylmethyl radical, was made in 1900 by abstraction of Cl^\bullet from Ph_3CCl by Ag metal. Many metal atoms such as Ag^\bullet and Li^\bullet have single unpaired electrons.

This radical is relatively stable (we shall see why shortly), but reacts with itself reversibly in solution. The product of the dimerization of triphenylmethyl was for 70 years believed to be hexaphenyl ethane but, in 1970, NMR showed that it was, in fact, an unsymmetrical dimer.

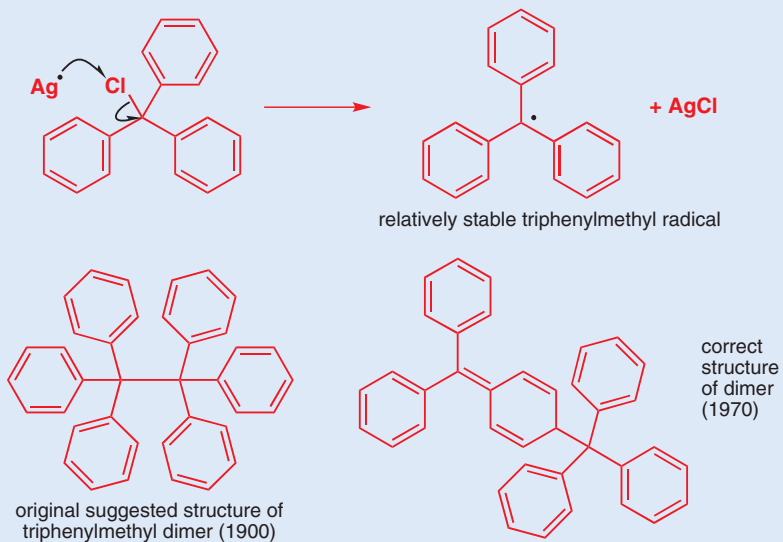

Radicals form by addition

The key step in the radical addition of HBr to an alkyne in Chapter 24 was the formation of a radical by radical addition. The Br^\bullet radical (which, you will remember, was formed by abstraction of H^\bullet from HBr by RO^\bullet) adds to the alkene to give a new, carbon-centred radical. This is the radical addition mechanism:



Just as charge must be conserved through a chemical reaction, so must the spin of the electrons involved. If a reactant carries an unpaired electron, then so must a product. Addition of a radical to a spin-paired molecule always generates a new radical. Radical addition is therefore a second type of radical-forming reaction.

The simplest radical addition reactions occur when a single electron is added to a spin-paired molecule. This process is a reduction. You have already met some examples of single-electron reductions: Birch reductions (Chapter 23) use the single electron formed when a group I metal (sodium, usually) is dissolved in liquid ammonia to reduce organic compounds. Group I metals are common sources of single electrons: by giving up their odd s electron they form a stable M^+ ion. They will donate this electron to several classes of molecules, for example ketones can react with sodium to form ketyl radicals.

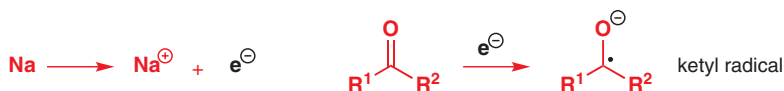

➔ We shall discuss ketyl radicals and their reactions on p. 980.

Radicals form by elimination

A fourth class of radical-forming reaction is **elimination**. For an example, we can go back to dibenzoyl peroxide, the unstable compound we considered earlier in the chapter. The radicals formed from dibenzoyl peroxide by homolysis are themselves unstable and each can break down by cleavage of a C–C bond, generating CO₂ and a phenyl radical. This is a radical elimination reaction, and is the reverse of a radical addition reaction.

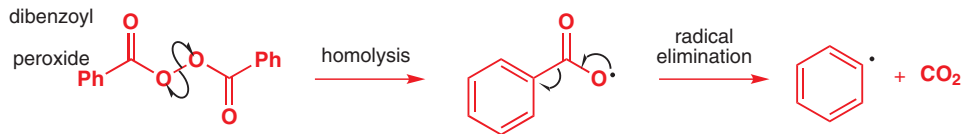

• To summarize methods of radical formation

Radicals form from spin-paired molecules by:

- homolysis of weak σ bonds, e.g.

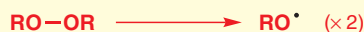

- electron transfer, that is, reduction (addition of an electron), e.g.

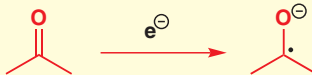

Radicals form from other radicals by:

- substitution (abstraction)

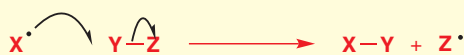

- addition



- elimination (homolysis)

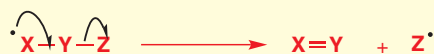

■ *Electron célibataire* is the French term for these bachelor electrons searching earnestly for a partner.

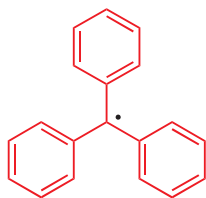

triphenylmethyl radical—
stable in solution
in equilibrium with its dimer

Most radicals are extremely reactive...

Unpaired electrons are desperate to be paired up again. This means that radicals usually have a very short lifetime; they don't survive long before undergoing a chemical reaction. Chemists are more interested in radicals that are reactive because they can be persuaded to do interesting and useful things. However, before we look at their reactions, we shall consider some radicals that are *unreactive* so that we can analyse the factors that contribute to radical reactivity.

... but a few radicals are very unreactive

Whilst simple alkyl radicals are extremely short-lived, some other radicals survive almost indefinitely. Such radicals are known as *persistent radicals*. We mentioned the triphenylmethyl

radical on p. 973: this yellow substance exists in solution in equilibrium with its dimer, but it is persistent enough to account for 2–10% of the equilibrium mixture.

Persistent radicals with the single electron carried by an oxygen or a nitrogen atom are also known: these four radicals can all be handled as stable compounds. The first, known as TEMPO, is a commercial product and can even be sublimed.

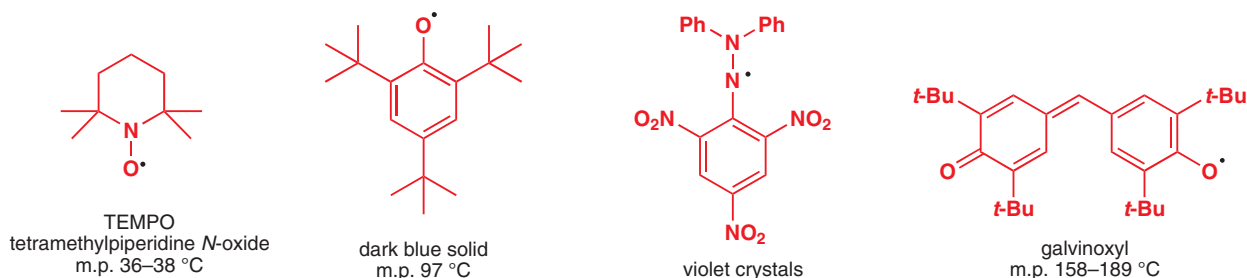

Vitamin E tames radicals

Many of the molecules that make up the structure of human tissue are susceptible to homolysis in intense light, and the body makes use of sophisticated chemistry to protect itself from the action of the reactive radical products. Vitamin E plays an important role in the 'taming' of these radicals: abstraction of H from the phenolic hydroxyl group produces a relatively stable radical that does no further damage.

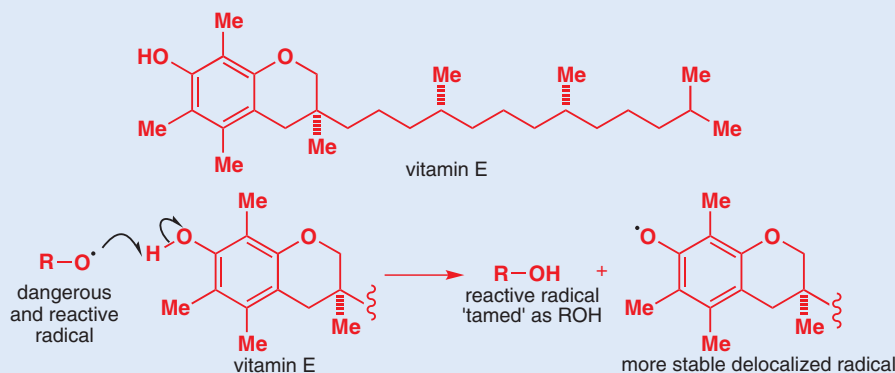

There are two reasons why some radicals are more persistent than others: (1) steric hindrance and (2) electronic stabilization. In the four extreme cases above, their exceptional stability is conferred by a mixture of these two effects. Before we can analyse the stability of other radicals, however, we need to look at what is known about the shape and electronic structure of radicals.

How to analyse the structure of radicals: electron spin resonance

For the last few pages we have been discussing the species we call radicals without offering any evidence that they actually exist. Well, there is evidence, and it comes from a spectroscopic technique known as electron spin resonance, or ESR (also known as EPR, electron paramagnetic resonance). ESR not only confirms that radicals do exist, but it can also tell us quite a lot about their structure.

Unpaired electrons, like the nuclei of certain atoms, have a magnetic moment associated with them. Proton NMR probes the environment of hydrogen atoms by examining the energy difference between the two possible orientations of their magnetic moments in a magnetic field; ESR works in a similar way for unpaired electrons. The magnetic moment of an electron is much bigger than that of a proton, so the difference in energy between the possible quantum

states in an electron field is also much bigger. This means that the magnets used in ESR spectrometers can be weaker than those in NMR spectrometers, usually about 0.3 tesla; even at this low field strength, the resonant frequency of an electron is about 9000 MHz (for comparison, the resonant frequency of a proton at 9.5 tesla is 400 MHz; in other words, a 400 MHz NMR machine has a magnetic field strength of 9.5 tesla).

But there are strong similarities between the techniques. ESR shows us, for example, that unpaired electrons couple with protons in the radical. The spectrum below is that of the methyl radical, $\text{CH}_3\cdot$. The 1:3:3:1 quartet pattern is just what you would expect for coupling to three equivalent protons; coupling in ESR is measured in millitesla (or gauss; 1 gauss = 0.1 mT), and for the methyl radical the coupling constant (called a_{H}) is 2.3 mT.

■ Notice that, for historical reasons, ESR spectra are recorded in a different way from NMR spectra: the diagram shows the first derivative of the absorption spectrum (the sort of spectrum you would get from a proton NMR machine).

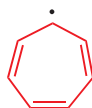
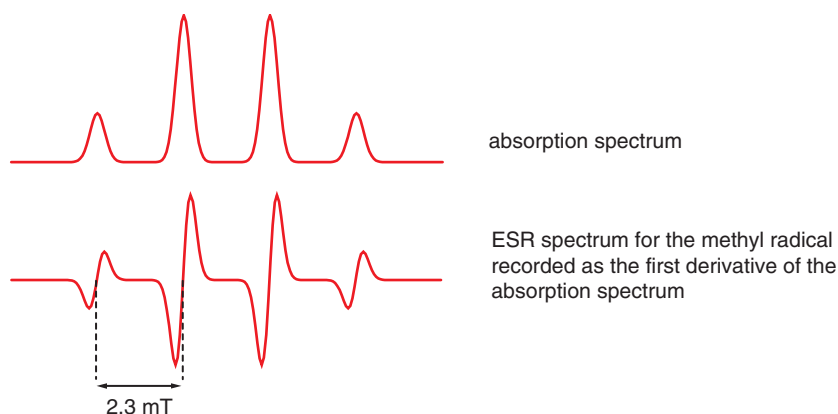

cycloheptatrienyl radical

ESR hyperfine splittings (as the coupling patterns are known) can give quite a lot of information about a radical. For example, here is the hyperfine splitting pattern of the cycloheptatrienyl radical. The electron evidently sees all seven protons around the ring as equivalent, and must therefore be fully delocalized. A localized radical would see several different types of proton, resulting in a much more complex splitting pattern.

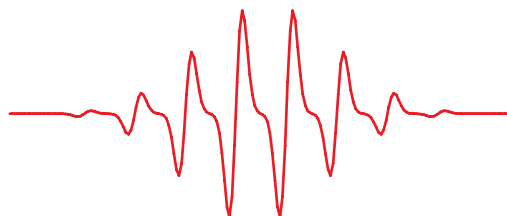

ESR spectrum of cycloheptatrienyl radical

Even the relatively simple spectrum of the methyl radical tells us quite a lot about its structure. For example, the size of the coupling constant a_{H} indicates that the methyl radical is planar; the trifluoromethyl radical is, on the other hand, pyramidal. The oxygenated radicals $\cdot\text{CH}_2\text{OH}$ and $\cdot\text{CMe}_2\text{OH}$ lie somewhere in between. The calculations that show this lie outside the scope of this book.

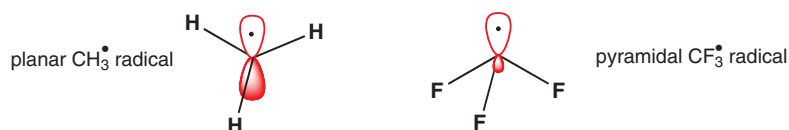

Radicals have singly occupied molecular orbitals

ESR tells us that the methyl radical is planar: the carbon atom must therefore be sp^2 hybridized, with the unpaired electron in a p orbital. We can represent this in an energy level diagram.

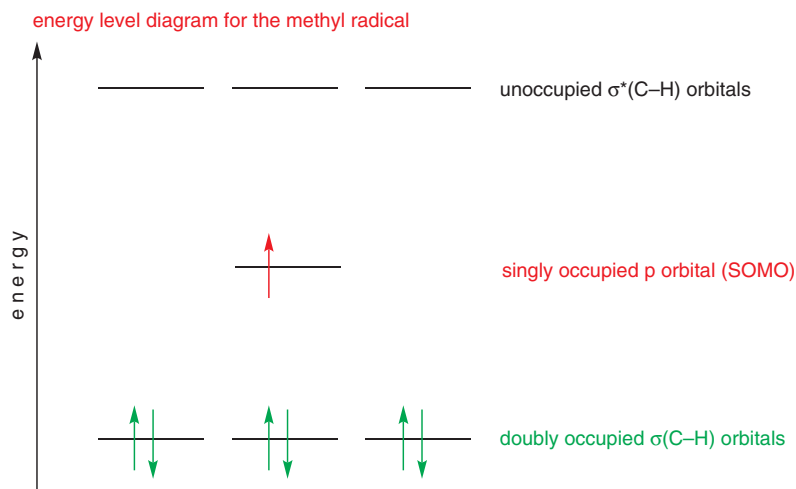

In Chapter 4 we talked about the HOMO (highest occupied molecular orbital) and LUMO (lowest unoccupied molecular orbital) of organic molecules. CH_3 (like all radicals) has an orbital containing one electron, which we call a **singly occupied molecular orbital (SOMO)**.

As with all molecules, it is the energy of the electrons in the molecular orbitals of the radical that dictate its stability. Any interaction that can decrease the energy levels of the filled molecular orbitals increases the stability of the radical (in other words, decreases its reactivity). Before we use this energy level diagram of the methyl radical to explain the stability of radicals, we need to look at some experimental data that allow us to judge just how stable different radicals are.

Radical stability

On p. 971 we used bond strength as a guide to the likelihood that bonds will be homolysed by heat or light. Since bond energies give us an idea of the ease with which radicals can form, they can also give us an idea of the stability of those radicals once they have formed.

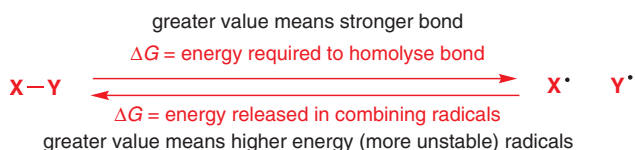

This is particularly true if we compare the strengths of bonds between the same atoms, for example carbon and hydrogen, in different molecules; this table does this.

A few simple trends are apparent. For example, C–H bonds decrease in strength in R–H when R goes from primary to secondary to tertiary. Tertiary alkyl radicals are therefore the most stable; methyl radicals the least stable.

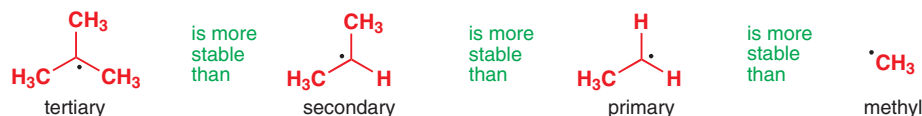

C–H bonds next to conjugating groups such as allyl or benzyl are particularly weak, so allyl and benzyl radicals are more stable. But C–H bonds to alkynyl, alkenyl, or aryl groups are strong. We saw the effects of this in Chapter 24.

C–H bond	Dissociation energy, kJ mol^{-1}
$\text{CH}_3\text{--H}$ (methyl)	439
$\text{MeCH}_2\text{--H}$ (primary)	423
$\text{Me}_2\text{CH--H}$ (secondary)	410
$\text{Me}_3\text{C--H}$ (tertiary)	397
$\text{HC}\equiv\text{C--H}$ (alkynyl)	544
$\text{H}_2\text{C}=\text{CH--H}$ (vinyl)	431
Ph--H (phenyl)	464
$\text{H}_2\text{C}=\text{CHCH}_2\text{--H}$ (allyl)	364
$\text{PhCH}_2\text{--H}$ (benzyl)	372
RC(=O)--H (acyl)	364
EtOCHMe--H	385
$\text{N}\equiv\text{CCH}_2\text{--H}$	360
$\text{MeCOCH}_2\text{--H}$	385

■ The absolute values in this table were determined in the gas phase, but the relative stabilities of the different radicals mirror their relative stabilities in solution.



Adjacent functional groups appear to weaken C–H bonds: radicals next to carbonyl, nitrile, or ether functional groups, or centred on a carbonyl carbon atom, are more stable than even tertiary alkyl radicals.

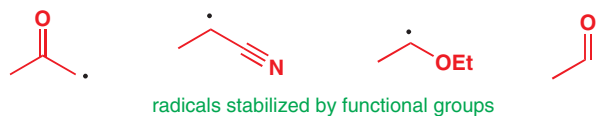

Whether the functional group is electron withdrawing or electron donating is clearly irrelevant here: both types seem to stabilize radicals. We can explain all of this if we look at how the different groups next to the radical centre interact electronically with the radical.

Radicals are stabilized by conjugating, electron-withdrawing, and electron-donating groups

Let's consider first what happens when a radical centre finds itself next to an electron-withdrawing group. Groups like C=O and C≡N are electron withdrawing because they have a low-lying empty π^* orbital. By overlapping with the (usually p) orbital containing the radical (the SOMO), two new molecular orbitals are generated. One electron (the one in the old SOMO) is available to fill the two new orbitals. It enters the new SOMO, which is of lower energy than the old one, and the radical experiences stabilization because this electron drops in energy.

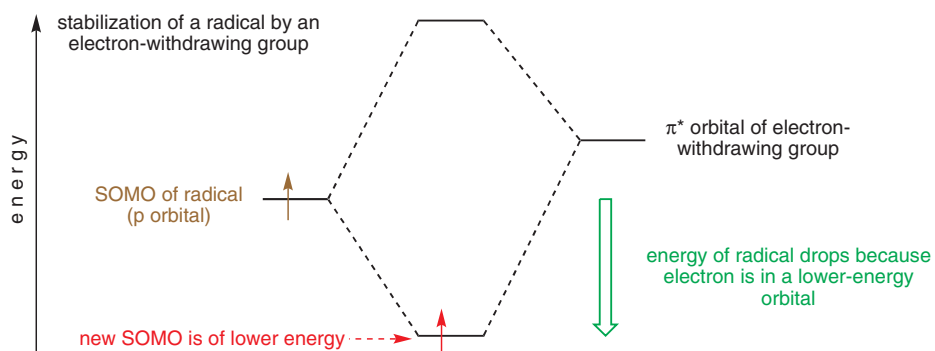

Radicals that are stabilized by an electron-withdrawing group and an electron-donating group at the same time are sometimes known as **captodative radicals**.

We can analyse what happens with electron-rich groups, such as RO groups, in a similar way. Ether oxygen atoms have relatively high-energy filled n orbitals, their lone pairs. Interacting this with the SOMO again gives two new molecular orbitals. Three electrons are available to fill them. The SOMO is now higher in energy than it was to start with, but the lone pair is lower. Because two electrons have dropped in energy and only one has risen, there is an overall stabilization of the system, even though the new SOMO is of higher energy than the old one. We shall see later what effect the energy of the SOMO, rather than the overall energy of the radical, has on its reactivity.

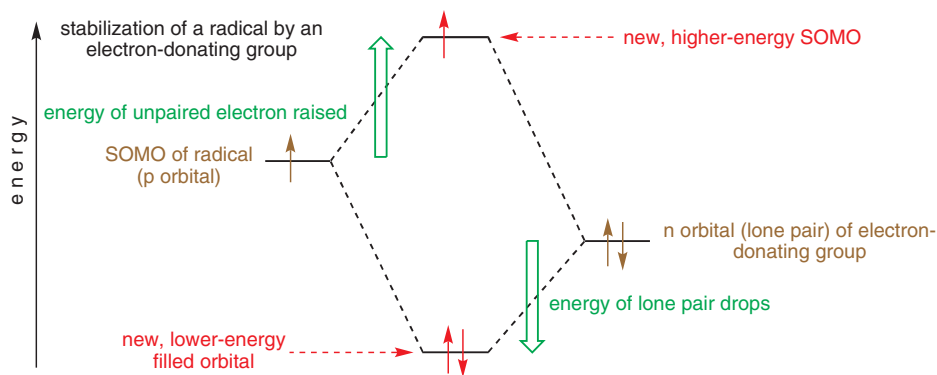

In Chapter 15 you saw how the electrons in C–H σ bonds stabilize cations: they stabilize radicals in the same way, which is why tertiary radicals are more stable than primary ones. Conjugation, too, is effective at stabilizing radicals. We know from their ESR spectra (p. 976) that radicals next to double bonds are delocalized; that they are more stable is evident from the bond dissociation energies of allylic and benzylic C–H bonds.

● **Anything that would stabilize an anion or a cation will stabilize a radical:**

- electron-withdrawing groups
- electron-donating groups (including alkyl groups with C–H σ bonds)
- conjugating groups.

Steric hindrance makes radicals less reactive

On p. 975 we showed you some radicals that are remarkably stable (persistent): some can even be isolated and purified. You should now be able to see at least part of the reason for their exceptional stability: two of them have adjacent powerful electron-donating groups, one has a powerful electron-withdrawing group as well, and three of the four are conjugated.

these radicals are persistent...

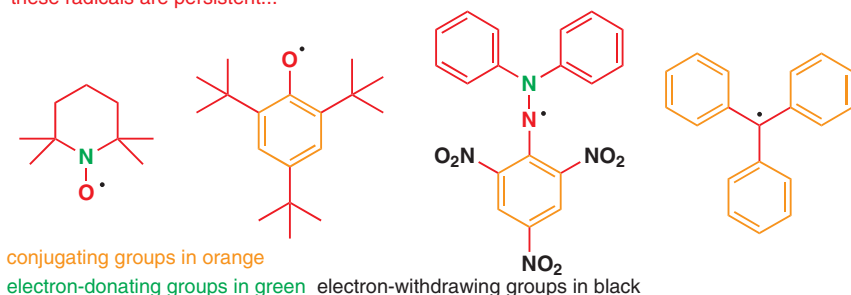

...while these radicals are reactive



But electronic factors alone are not sufficient to explain the exceptional stability of all four radicals, since the two radicals on the right receive just about the same electronic stabilization as the first two above, but are much more reactive.

In fact, the stability of the triphenylmethyl radical we know to be due mainly to steric, rather than electronic, factors. X-ray crystallography shows that the three phenyl rings in this compound are not coplanar but are twisted out of a plane by about 30° , like a propeller. This means that the delocalization in this radical is less than ideal (we know that there is some delocalization from the ESR spectrum) and, in fact, it is little more delocalized than the diphenylmethyl or even the benzyl radical, even though it is much more stable than either. This must be because the central carbon, which bears most of the radical character, is sterically shielded by the twisted phenyl groups, making it very hard for the molecule to react.

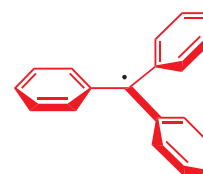

■ When it does react, as you saw in the box on p. 973, it does so through one of the less hindered *para* positions.

The rest of this chapter is devoted to the reactions of radicals, and you will see that the two effects we have talked about—electronic stabilization and steric hindrance—are key factors that control these reactions.

How do radicals react?

A reactive radical has a choice: it can either find another radical and combine to form a spin-paired molecule (or more than one spin-paired molecule), or it can react with a spin-paired molecule to form a new radical. Both are possible, and we shall see examples of each. A third alternative is for a radical to decompose in a unimolecular reaction, giving rise to a new radical and a spin-paired molecule.

• Three possibilities:

- radical + radical \rightarrow spin-paired molecule

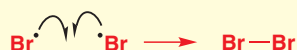

- radical + spin-paired molecule \rightarrow new radical + new spin-paired molecule



- radical \rightarrow new radical + spin-paired molecule



Radical–radical reactions

In view of the energy released when unpaired electrons pair up, you might expect this type of radical reaction to be more common than reaction with a spin-paired molecule, in which no net pairing of electrons takes place. Radical–radical reactions certainly do take place, but they are not the most important type of reaction involving radicals. We shall see why they are not as common as you might expect shortly, but first we can look at the few examples of radical–radical reactions which do work well.

The pinacol reaction is a radical dimerization

We outlined on p. 973 a way of making radicals by single electron transfer: effectively, the addition reaction of a single electron to a spin-paired molecule. The types of molecules that undergo this reaction are those with low-lying antibonding orbitals for the electron to go into, in particular aromatic systems and carbonyl compounds. The radical anion formed by addition of an electron to a ketone is known as a **ketyl**. The single electron is in the π^* orbital, so we can represent a ketyl with the radical on oxygen or on carbon and the anion on the other atom.

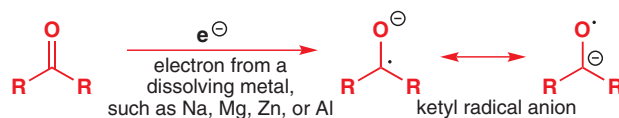
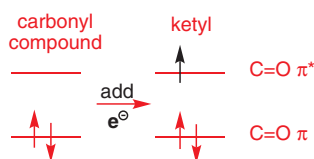

Ketyls behave in a manner that depends on the solvent that they are in. In protic solvents (ethanol, for example), the ketyl becomes protonated and then accepts a second electron from the metal (sodium is usually used in these cases). An alkoxide anion results, which, on addi-

tion of acid at the end of the reaction, gives an alcohol. Notice that this is a reaction using sodium metal in ethanol, and not sodium ethoxide, which is the basic product that forms once sodium has dissolved in ethanol. It is important that the sodium is *dissolving* as the reaction takes place, since only then are the free electrons available.

reaction of the ketyl radical anion in protic solvents

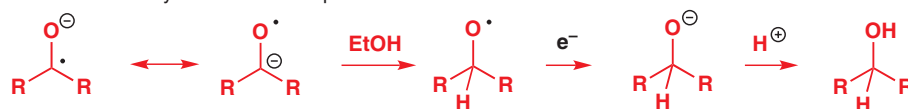

In aprotic solvents, such as benzene or ether, no protons are available so the concentration of ketyl radical builds up significantly and the ketyl radical anions start to dimerize. As well as being a radical–radical process, this dimerization process is an anion–anion reaction, so why doesn't electrostatic repulsion between the anions prevent them from approaching one another? The key to success is to use a metal such as magnesium or aluminium, which forms strong, covalent metal–oxygen bonds and can coordinate to more than one ketyl at once. Once two ketals are coordinated to the same metal atom, they react rapidly.

pinacol dimerization of acetone (ketyl radical reaction in hydrocarbon solvent)

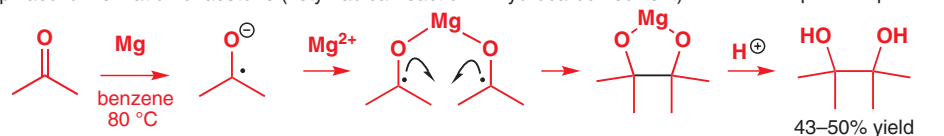

The example shows the dimerization of acetone to give a diol (2,3-dimethylbutane-2,3-diol) whose trivial name, pinacol, is used as a name for this type of reaction using any ketone. Sometimes pinacol reactions create new chiral centres: in this example, the two diastereoisomeric diols are formed in a 60:40 mixture. If you want to make a single diastereoisomer of a diol, a pinacol reaction is not a good choice!

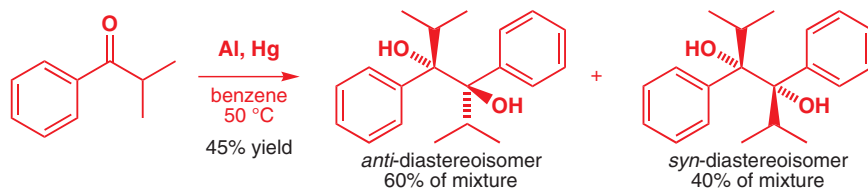

Benzophenone as an indicator in THF stills

As you should have gathered by now, THF is an important organic solvent in which many low-temperature, inert atmosphere reactions are conducted. It has a drawback, however: it is quite hygroscopic, and often the reactions for which it is used as a solvent must be kept absolutely free of water. It is therefore always distilled immediately before use from sodium metal, which reacts with any traces of water in the THF. However, it is necessary to have an indicator to show that the THF is dry and that the sodium has done its job. The indicator used is a ketone, benzophenone.

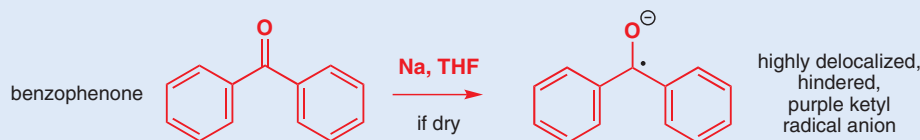

When the THF is dry, the distilling liquid containing the benzophenone becomes bright purple. This colour is due to the ketyl of benzophenone, the formation of which under these conditions should not surprise you. It should also come as no surprise that this ketyl, being stabilized by conjugation and quite hindered, is persistent (long-lived)—it does not undergo pinacol dimerization (as we explained above, you would not normally choose sodium to promote pinacols anyway). However, if water is present, the ketyl is rapidly quenched in the manner of the reduction described above to give the (colourless) alkoxide anion: only when all the water is consumed does the colour return.

This reaction, known as the **Bouveault–Blanc reduction**, was used to reduce carbonyl compounds to alcohols, but now aluminium hydrides and borohydrides are usually more convenient. You met an example of the Bouveault–Blanc reduction in Chapter 32 (p. 832).

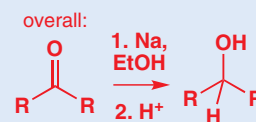

Interactive mechanism for pinacol reaction

■ You would be better off using one of the methods described in Chapter 33 on diastereoselectivity.

Pinacol reactions can be carried out intramolecularly, from compounds containing two carbonyl groups. In fact, the key step of one of the very first syntheses of the important anti-cancer compound Taxol was an intramolecular pinacol reaction using titanium as the source of electrons.

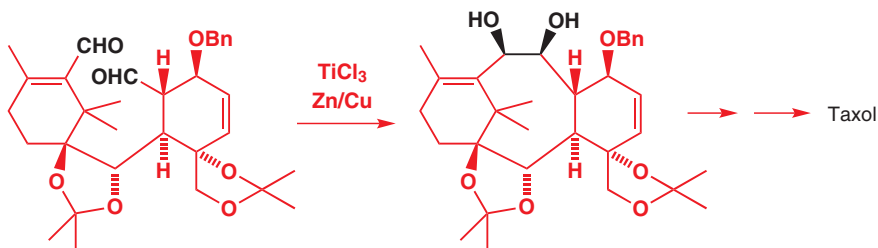

The titanium metal that is the source of electrons is produced during the reaction by reduction of TiCl_3 using a zinc–copper mixture. This reaction is, in fact, unusual because, as we shall see below, pinacol reactions using titanium do not normally stop at the diol, but give alkenes.

Titanium promotes the pinacol coupling and then deoxygenates the products: the McMurry reaction

Titanium can be used as the metal source of electrons in the pinacol reaction and, provided the reaction is kept cold and not left for too long, diols can be isolated from the reaction, as in the example above. However, unlike magnesium or aluminium, titanium reacts further with these diol products to give alkenes in a reaction known as the McMurry reaction, after its inventor.

McMurry reaction of cyclohexanone

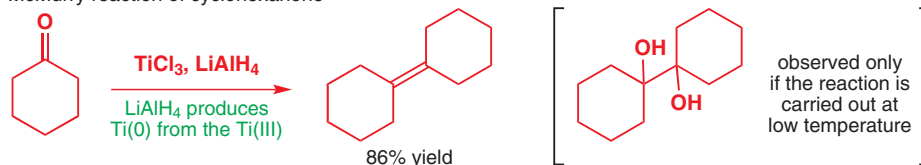

Notice that the titanium(0), which is the source of electrons in the reaction, is produced during the reaction by reacting a Ti(III) salt, usually TiCl_3 , with a reducing agent such as LiAlH_4 or Zn/Cu . The reaction does not work with, say, powdered titanium metal. The McMurry reaction is believed to be a two-stage process involving firstly a pinacol radical–radical coupling.

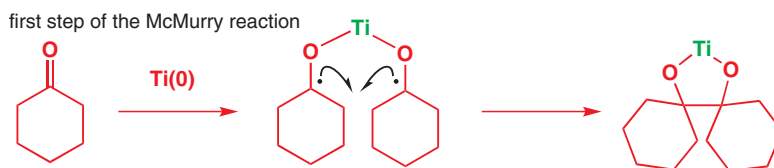

The Ti(0) then proceeds to deoxygenate the diol by a mechanism not fully understood, but thought to involve binding of the diol to the surface of the Ti(0) particles produced in the reduction of TiCl_3 .

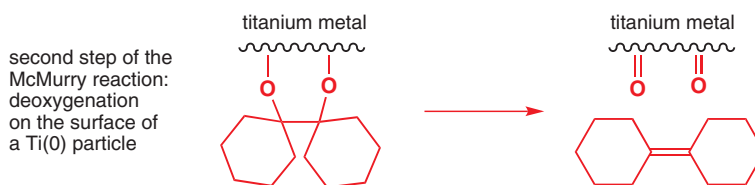

We expect you to be mildly horrified by the inadequacy of the mechanism above. But, unfortunately, we can't do much better because no-one really knows quite what is happening. The McMurry reaction is very useful for making tetrasubstituted double bonds—there are few other really effective ways of doing this. However, the double bonds really need to be symmetrical (in other words, have the same substituents at each end) because McMurry reactions between two different ketones are rarely successful.

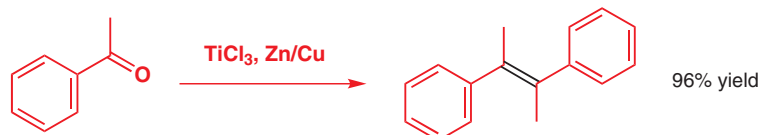

McMurry reactions also work very well intramolecularly, and turn out to be quite a good way of making cyclic alkenes, especially when the ring involved is medium or large (over about eight members). For example, the natural product flexibilene, with a 15-membered ring, can be made by cyclizing a 15-keto-aldehyde.

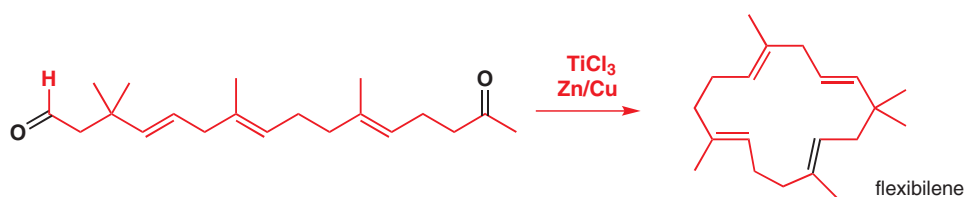

Esters undergo pinacol-type coupling: the acyloin reaction

You've seen examples of pinacol and McMurry reactions of ketones and aldehydes. What about esters? You would expect the ketyl radical anion to form from an ester in the same way, and then to undergo radical dimerization, and this is indeed what happens.

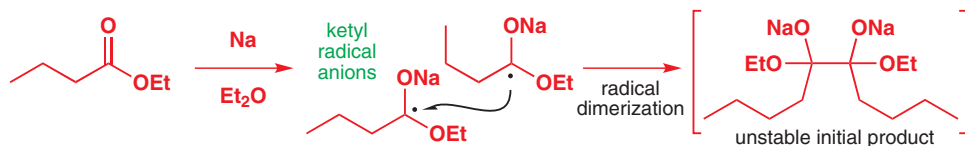

The product of the dimerization looks very much like a tetrahedral intermediate in a carbonyl addition–elimination reaction, and it collapses to give a 1,2-diketone.

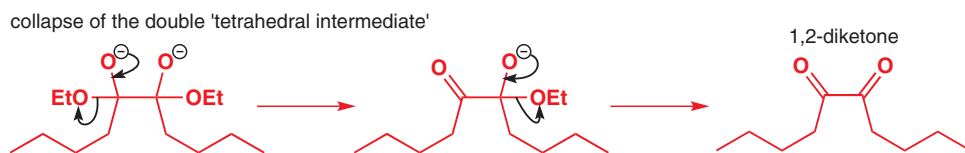

The diketone is, however, still reducible—in fact, 1,2-diketones are more reactive towards electrophiles and reducing agents than ketones because their π^* is lower in energy and straight away two electron transfers take place to form a molecule, which we could term an **enediolate**. On quenching the reaction with acid, this dianion is protonated twice to give the enol of an α -hydroxy-ketone, and it is this α -hydroxy-ketone that is the final product of the acyloin reaction. The yield in this example is a quite respectable 70%. However, in many other cases, this usefulness of the acyloin reaction is hampered by the formation of by-products that arise because of the reactivity of the enediolate dianion. It is, of course, quite nucleophilic, and is likely to be formed in the presence of the highly electrophilic diketone. It is also basic, and often catalyses a competing Claisen condensation of the esters being reduced.

first electron transfer to the diketone:

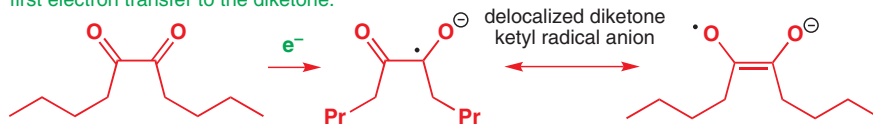

second electron transfer:

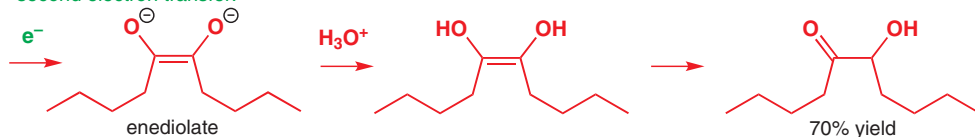

■ In the absence of the Me_3SiCl , the main product from this reaction becomes the cyclic ketoester below, which arises from base-catalysed Dieckmann cyclization (see Chapter 26) of the diester.

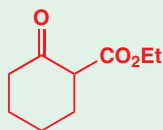

The solution to these problems is to add trimethylsilyl chloride to the reaction mixture. The silyl chloride silylates the enediolate as it is formed, and the product of the acyloin reaction becomes a bis-silyl ether.

an improved version of the acyloin reaction

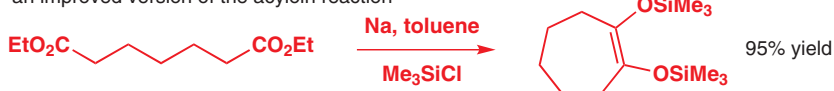

These silyl ethers are rarely wanted as final products, and they can easily be hydrolysed to α -hydroxyketones with aqueous acid. This improved version makes four-membered rings efficiently.

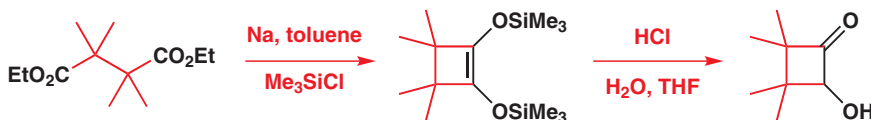

It's not by accident that these two examples of the acyloin reaction show the formation of cyclic compounds. It is a particularly powerful method of making carbocyclic rings from four-membered upwards: the energy to be gained by pairing up the two electrons in the radical-radical reaction step more than compensates for the strain that may be generated in forming the ring.

The pinacol, McMurry, and acyloin reactions are exceptional

■ Think of radicals as smash-and-grab raiders. They pick the first shop that catches their eye, smash the window, and run off with a handful of cheap jewellery from the front of the display. Ions in solution are stealthy burglars. They scan all the houses on the street, choose the most vulnerable, and then carefully gain entry to the room that they know contains the priceless oil painting.

We've already said that this type of reaction, in which two radicals dimerize, is relatively uncommon. Most radicals are simply too reactive to react with one another! This may sound nonsensical, but the reason is simply that highly reactive species are unselective about what they react with. Although it might be energetically favourable for them to find another radical and dimerize, they are much more likely to collide with a solvent molecule, or a molecule of some other compound present in the mixture, than another radical. Reactive radicals are only ever present in solution in very low concentrations, so the chances of a radical-radical collision are very low. Radical attack on spin-paired molecules is much more common and, because the product of such reaction is also a radical, they give rise to the possibility of radical chain reactions.

Radical chain reactions

In looking at how radicals form, you've already seen examples of how radicals react. In fact, we've already dealt (if only very briefly) with every step of the sequence of reactions that makes up the mechanism of the radical reaction you met at the beginning of the chapter, and shown below.



Let's now consider each step in turn and in more detail.

1. The dialkyl peroxide is homolysed (by heat or light) to give two alkoxy radicals.



2. RO^\bullet abstracts H from HBr (radical substitution) to give Br^\bullet .



3. Br^\bullet adds to isobutene to give a carbon-centred radical.

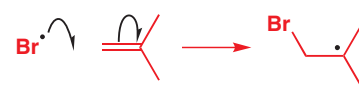

4. The carbon-centred radical abstracts a hydrogen atom from H-Br to form the final addition product and regenerate Br^\bullet , which can react with another molecule of alkene.

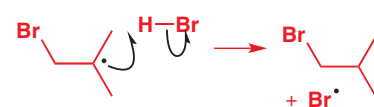

So the whole process is a cycle with the bromine radical regenerated in the last step, the one in which the product is formed.

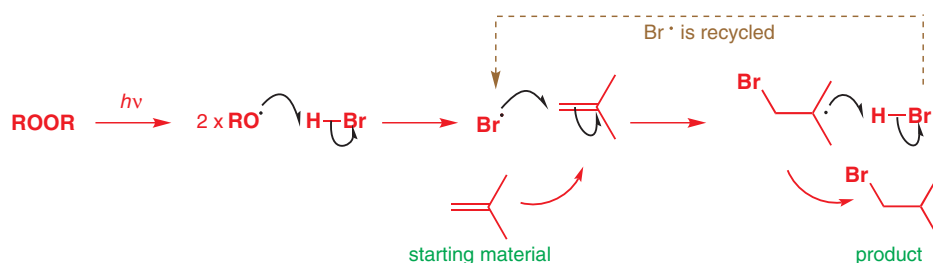

 Interactive mechanism for radical addition of HBr to isobutene

In each step in the cycle a radical is consumed and a new radical is formed. This type of reaction is therefore known as a **radical chain reaction**, and the two steps that form the cyclic process that keeps the chain running are known as the **chain propagation steps**. Only one molecule of peroxide **initiator** is necessary for a large number of product molecules to be formed and, indeed, the peroxide needs to be added in only catalytic quantities (about 10 mol%) for this reaction to proceed in good yield.

Any less than 10 mol%, however, and the yield drops. The problem is that the chain reaction is not 100% efficient. Because the concentration of radicals in the reaction mixture is low, radical-radical reactions are rare, but nonetheless they happen often enough that more peroxide keeps being needed to start the chain off again.

possible radical-radical chain termination steps



Reactions like this are known as **termination steps** and are actually an important part of any chain reaction; without termination steps the reaction would be uncontrollable.

● **Radical chain reactions consist of:**

• **initiation steps**

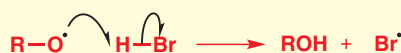

• **propagation steps**

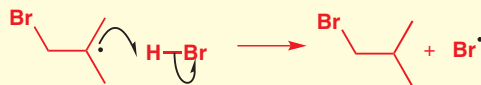
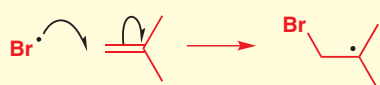

 Interactive mechanism for radical termination steps

• termination steps



■ We have already suggested two reasons why the Br^\bullet radical adds to the alkene with this characteristic regioselectivity, giving a primary alkyl bromide when the polar addition of HBr to an alkene would give a tertiary alkyl bromide: (1) attack at the unsubstituted end of the alkene is less sterically hindered and (2) the tertiary radical thus formed is more stable than a primary radical. In fact, of all the hydrogen halides, only HBr will add to alkenes in this fashion: HCl and HI will undergo only polar addition to give the tertiary alkyl halide. Why? We need to be able to answer this type of question too.

Selectivity in radical chain reactions

In the radical–radical reactions we looked at earlier, there was never any question of what would react with what: only one type of radical was formed and the radicals dimerized in identical pairs. Look at the chain reaction above though—there are three types of radical present, Br^\bullet , $\text{BrCH}_2\text{Me}_2\text{CH}^\bullet$, and RO^\bullet , and they all react specifically with a chosen spin-paired partner: Br^\bullet with the alkene, and $\text{BrCH}_2\text{Me}_2\text{CH}^\bullet$ and RO^\bullet with HBr . We need to understand the factors that govern this chemoselectivity. In order to do so we shall look at another radical reaction with chemoselectivity and regioselectivity that is *measurable*.

Chlorination of alkanes

Alkanes will react with chlorine radicals to give alkyl chlorides. For example, cyclohexane plus chlorine gas, in the presence of light, gives cyclohexyl chloride and hydrogen chloride.



The Toray process

A variant of this reaction, known as the Toray process, is used on an industrial scale to produce caprolactam, a precursor to nylon. Instead of chlorine, nitrosyl chloride is used to form a nitroso compound that rapidly tautomerizes to an oxime. As you saw in Chapter 36, this oxime undergoes a Beckmann rearrangement under acid conditions to form caprolactam.

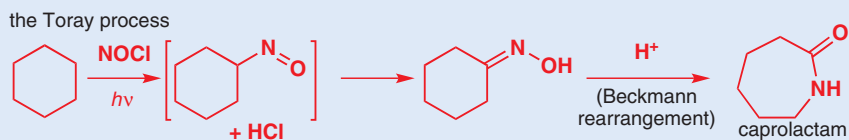

This type of reaction is important industrially since it is one of the few that allows compounds containing functional groups to be made from alkanes. As you might guess, since it needs light for initiation, the process is another example of a radical chain reaction. As with the radical addition of HBr to alkenes, we can identify initiation, propagation, and termination steps in the mechanism.

initiation

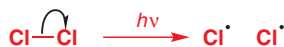

propagation

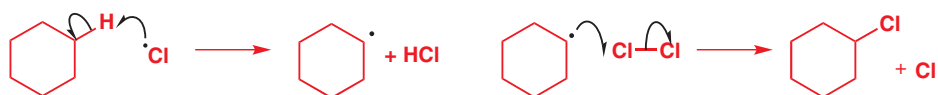

termination



 Interactive mechanism for radical addition of Cl_2 to cyclohexane

In this case, the termination steps are much less important than in the last case we looked at, and typically the chain reaction can continue for 10^6 steps for each initiation

event (photolysis of chlorine). Be warned: reactions like this can be explosive in sunlight and are carried out in specialized facilities, not in the open laboratory.

When the chlorine radical abstracts a hydrogen atom from the cyclohexane, only one product can be formed because all 12 hydrogen atoms are equivalent. For other alkanes this may not be the case, and mixtures of alkyl chlorides can result. For example, propane is chlorinated to give a mixture of alkyl chlorides containing 45% 1-chloropropane and 55% 2-chloropropane, and isobutane is chlorinated to give 63% iso-butyl chloride and 37% *tert*-butyl chloride.



How can we explain the ratios of products that are formed? The key is to look at the relative stabilities of the radicals involved in the reaction and the strengths of the bonds that are formed and broken. First, the chlorination of propane. A chlorine radical, produced by photolysis, can abstract either a primary hydrogen atom, from the end of the molecule, or a secondary hydrogen atom, from the middle. For the two processes, we have these energy gains and losses:

➔ These bond energies were given in the tables on p. 971.

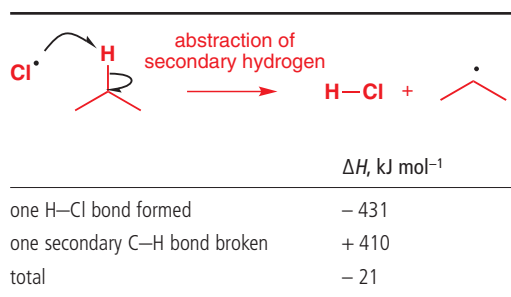
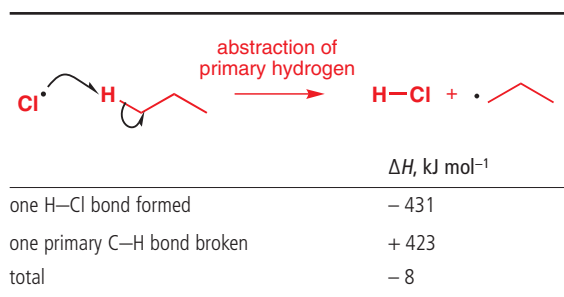

Abstraction of the secondary hydrogen atom is more exothermic than abstraction of the primary hydrogen atom for the related reasons that: (1) secondary C-H bonds are weaker than primary ones and (2) secondary radicals are more stable than primary ones. So, we get more 2-chloropropane than 1-chloropropane. But in this case, that isn't the only factor involved: remember that there are six primary hydrogen atoms and only two secondary ones, so the relative reactivity of the primary and secondary positions is even more different than the simple ratio of products from the reaction suggests. This statistical factor is more evident in the second example we gave above, the chlorination of isobutane. Now the choice is between formation of a tertiary radical and formation of a primary one.

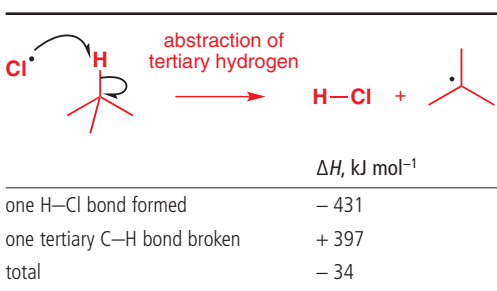
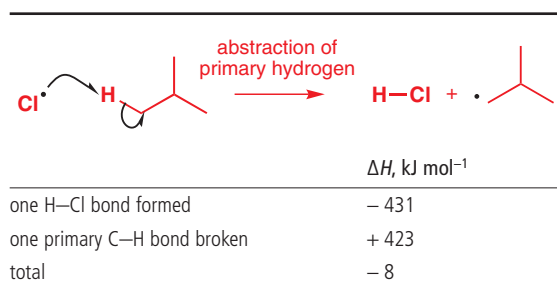

Tertiary radical formation is more exothermic, yet more primary alkyl chloride is formed than tertiary alkyl chloride. However, once the 9:1 ratio of primary to tertiary hydrogen atoms is taken into account, the relative reactivities, as determined experimentally, turn out to be as shown in the table below.

ratio of products formed (tertiary:primary)	37:63
number of hydrogen atoms (tertiary:primary)	1:9
relative reactivity of each C–H bond (tertiary:primary)	$37/1:63/9 = 37:7 = \text{ca. } 5:1$

● Bond strength is important in radical reactions

These reactions illustrate a key point about radical reactions—an important factor affecting selectivity is the strength of the bonds being formed and broken.

■ Bond strength is only a *guide* to selectivity in radical reactions. As we shall see shortly, it's not the only factor involved. Indeed, you've already seen *steric effects* in action when the Br^\bullet radical is added to the less hindered end of the alkene in the first radical reaction of this chapter, and you will later see how *frontier orbital effects* can operate too.

■ We use the symbol (\bullet) to mean a partial radical; a radical that is partially centred on this atom. The symbols (–) and (+) are used to mean a similar thing when a charge is shared by more than one atom.

■ Of course our calculations involving bond energies only gave us values for ΔH , not ΔG , which is what this diagram represents. However, we can assume that the $T\Delta S$ term in the relationship $\Delta G = \Delta H - T\Delta S$ is relatively insignificant.

The rate of attack by Cl^\bullet on a tertiary C–H bond, then, is about five times the rate of attack by Cl^\bullet on a primary C–H bond. We said that this is because the formation of the tertiary radical is more exothermic than the formation of the primary radical. But the rate of a reaction depends not on ΔH for that reaction but on the activation energy of the reaction; in other words, the energy needed to reach the transition state for the reaction. But we can still use the stability of the product radicals as a guide to the stability of the transition state because the transition state must have significant radical character.

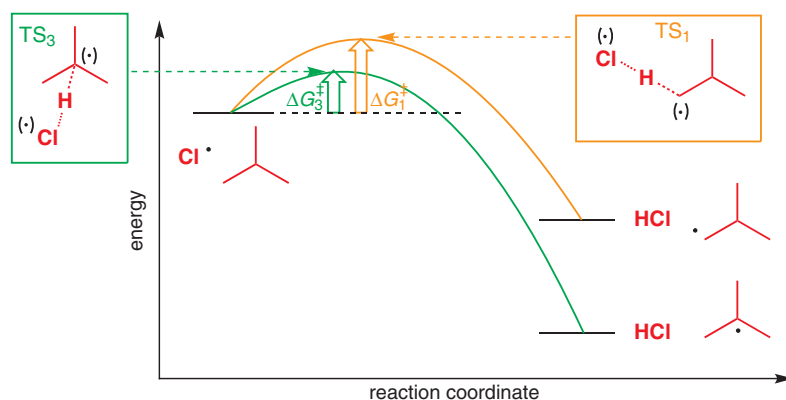

The energy diagram above illustrates this point. As the reactants (Cl^\bullet plus isobutane) move towards the products, they pass through a transition state (TS_1 for formation of the primary radical, TS_3 for formation of the tertiary) in which the radical character of the Cl^\bullet starting material is spread over both the Cl and the C centres. The greater stability of a tertiary radical compared with a primary one must be reflected to a lesser degree in these transition states: a radical shared between Cl and a tertiary centre will be more stable than a radical shared between Cl and a primary centre. The transition state TS_3 for the reaction at the tertiary C–H bond is therefore of lower energy than the transition state TS_1 for reaction at the primary C–H bond. In other words, the activation energy ΔG_3^\ddagger is smaller than ΔG_1^\ddagger , so reaction at the tertiary C–H bond is faster.

Bromination of alkanes is more selective

Bromine will also halogenate alkanes, and it does so much more selectively than chlorine. For example, the following reaction yields *tert*-butyl bromide with less than 1% of the primary isomer.

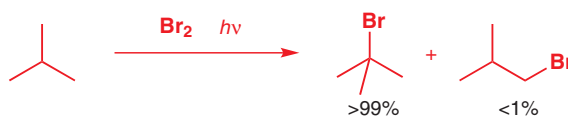

In this case, the first step of the radical chain reaction, the abstraction of H by Br^\bullet , is endothermic for both the primary and tertiary hydrogen atoms, but more so for primary radical formation, so the tertiary radical is preferred.

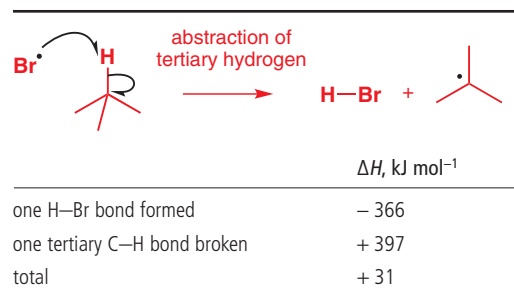
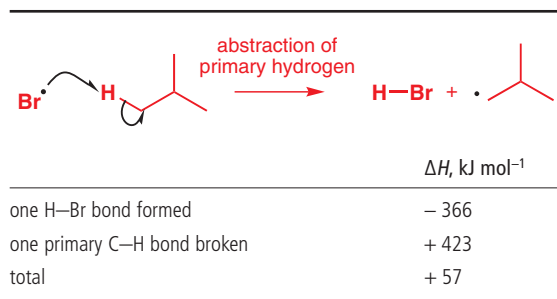

Of course, in both brominations and chlorinations the *overall* reaction is favourable because the second step—the halogenation of the alkyl radical—is significantly exothermic, by about 106 kJ mol⁻¹ for chlorination and about 83 kJ mol⁻¹ for bromination. The same is true for fluorination, but with fluorine this step is so exothermic that fluorination becomes dangerously explosive. Conversely, radical iodination is impossible because the final step is insufficiently exothermic to make up for the endothermic formation of an alkyl radical.

Why is bromination so much more selective than the chlorination of alkanes? This is a good example of the **Hammond postulate**, applied to real chemistry. Because the products of the first step of the bromination (R^\cdot plus HBr) are higher in energy than the starting materials, the transition state must be similar in structure and energy to the radical being formed; the difference in energies of the primary and tertiary product radicals should therefore be markedly reflected in the different energies of the transition states TS_1 and TS_3 , and ΔG_1^\ddagger will be significantly larger than ΔG_3^\ddagger . For the chlorination reaction, the products were just slightly lower in energy than the starting materials, so the transition states for the two possible reactions both resembled the starting materials rather more and the products rather less. These are the same for both tertiary and primary hydrogen abstractions, of course, so the difference in energy of the product radicals exerts a less pronounced effect on the difference in energy of the transition states.

second step of a halogenation: always exothermic



The **Hammond postulate** gives information about the structure of transition states. It says that two states that interconvert directly (are directly linked in a reaction profile diagram) and that are close in energy are also similar in structure. So a transition state will be most like the starting material, an intermediate, or the product if it is close in energy to one of these observable structures.

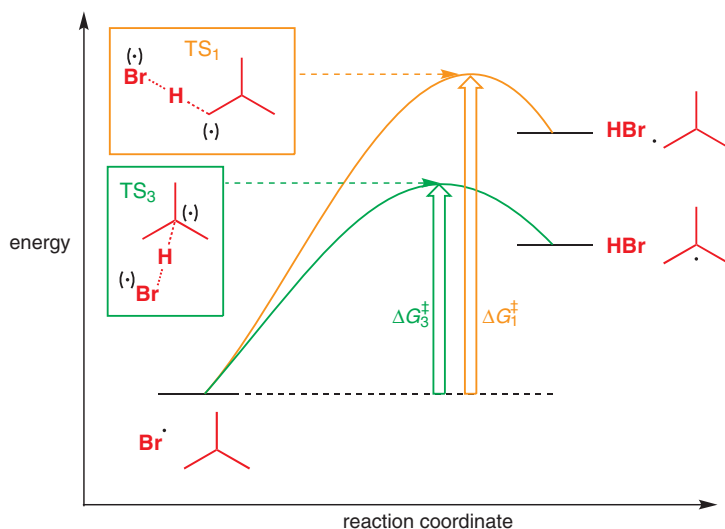

Allylic bromination

Because radical brominations are so selective, they can be used successfully in the laboratory to make alkyl bromides. There are relatively few ways of functionalizing an unfunctionalized centre, and radical allylic bromination is one of the most effective. We introduced this reaction in Chapter 24, where we contrasted the radical reactivity of Br_2 towards alkenes (leading to an allyl bromide by hydrogen abstraction) with its ionic reactivity (leading to addition of bromine across the alkene). We can now look in a little more detail at the selectivities involved.

➔ We introduced radical bromination on p. 571.

➔ The way that NBS does this is explained on p. 573.

🖱 Interactive mechanism for allylic bromination

Here is a typical allylic bromination. NBS (*N*-bromosuccinimide) is used to form a small amount of Br_2 and to keep the Br_2 concentration low.



■ These figures were determined in the gas phase, and here our reactions are in solution. Nonetheless, because solvation effects are more or less the same for all radicals, we expect the order of the bond strengths to remain the same in both phases.

Photolysis of Br_2 initiates the reaction, which then propagates as shown below. The mechanism also illustrates the first aspect of selectivity: only a (green) allylic H atom is abstracted because an allylic C–H bond is considerably weaker than a secondary C–H bond (364 vs. 410 kJ mol^{-1} from the table on p. 977).

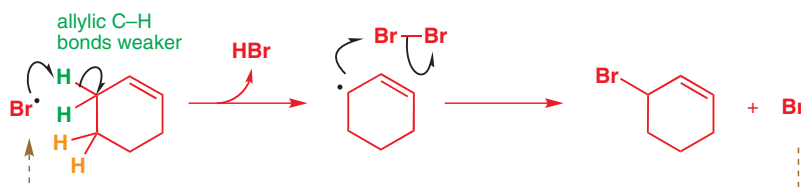

There is a problem with this reaction if bromine itself is used because an alternative radical addition reaction can compete with radical abstraction.

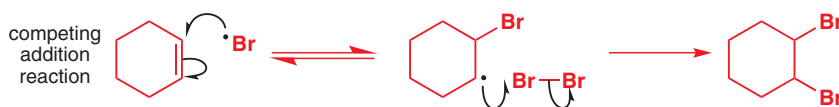

cationic intermediate destabilized by non-polar solvent

The first step of this competing addition reaction is reversible; the reaction is driven forward by the participation of a second molecule of bromine that traps the product alkyl radical. This side reaction can be prevented if the concentration of Br_2 in the reaction is kept very low, which is the role of NBS. The alternative competing polar addition of Br_2 to the alkene is likewise prevented with the low bromine concentration provided by NBS, although the non-polar solvent CCl_4 also disfavours the formation of the cationic bromonium ion intermediate.

While radical halogenation of alkanes is used only rarely in the laboratory, radical allylic bromination of alkenes is a versatile and commonly used way of making allylic bromides. Nucleophilic substitution reactions can then be used to convert the bromide to other functional groups. For example, some chemists in Manchester needed to make the two diastereoisomers of 5-*tert*-butyl-cyclohex-2-en-1-ol to study their reactions with osmium tetroxide. *tert*-Butyl cyclohexene is readily available, so they used a radical allylic bromination to introduce the functional group in the allylic position, which they converted to a hydroxyl group using aqueous base. Steric effects also play a role here in the regioselectivity of the reaction: only the less hindered allylic hydrogen atoms further from the *t*-butyl group are removed.

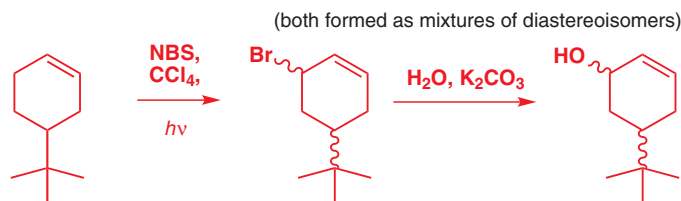

Reversing the selectivity: radical substitution of Br by H

Radical substitution reactions can also be used to *remove* functional groups from molecules. A useful reagent for this (and, as you will see, for other radical reactions too) is tributyltin

hydride, Bu_3SnH . The Sn–H bond is weak and Bu_3SnH will react with alkyl halides to replace the halogen atom with H, producing Bu_3SnHal as a by-product.

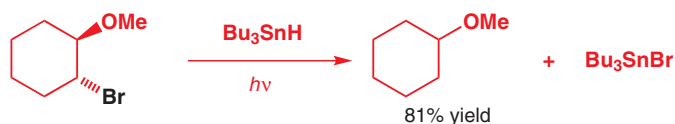

Clearly, for this reaction to be energetically favourable, the new bonds formed (Sn–Br and C–H) must be stronger than the old bonds broken (Sn–H and C–halogen). Look at this table of average bond energies and you will see that this is indeed so. The use of a tin hydride is crucial to this reaction: Sn–H bonds are weaker than Sn–Br bonds, while, for carbon, C–H bonds are stronger. Bu_3SnH is therefore an effective source of $\text{Bu}_3\text{Sn}^\bullet$ radicals, and the $\text{Bu}_3\text{Sn}^\bullet$ radical will abstract halogens, particularly I or Br, but also Cl, from organic halides, breaking a weak C–halogen (C–Hal) bond and forming a strong Sn–Hal bond. The complete mechanism of the reaction reveals a chain reaction.

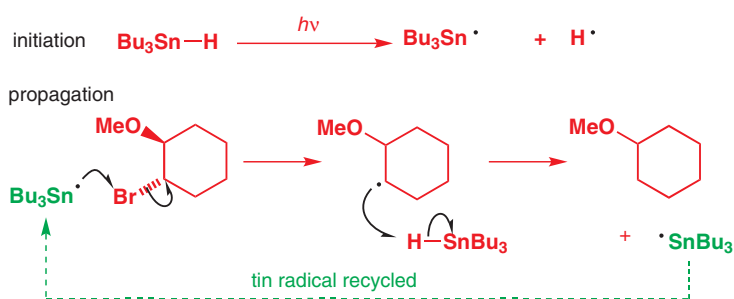

➔ We discussed the removal of functional groups, and why you might want to do it, in Chapter 23.

Bond	Representative bond energy, kJ mol^{-1}
C–Br	280
Sn–H	308
C–H	418
Sn–Br	552

Interactive mechanism for tin hydride reduction of alkyl halides

Homolysis of Bu_3SnH is promoted by the initiator AIBN

As you would imagine, the weakest C–Hal bonds are the easiest to cleave, so alkyl bromides are reduced more rapidly than alkyl chlorides, and alkyl fluorides are unreactive. With alkyl iodides and bromides, daylight can be sufficient to initiate the reaction, but with alkyl chlorides, and often with alkyl bromides as well, it is generally necessary to produce a higher concentration of $\text{Bu}_3\text{Sn}^\bullet$ radicals by adding an initiator to the reaction. The best choice is usually AIBN, which you met earlier in the chapter (p. 972). This compound undergoes thermal homolysis above 60°C to give nitrile-stabilized radicals that abstract the hydrogen atom from Bu_3SnH .

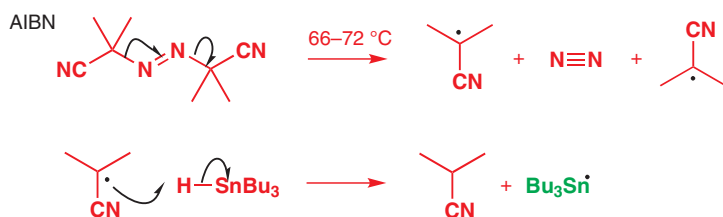

Why use AIBN as an initiator; why not a peroxide? Since we want to cleave only a weak Sn–H bond, we can get away with using a relatively unreactive nitrile-stabilized radical. Peroxides, on the other hand, generate RO^\bullet radicals. These are highly reactive and will abstract hydrogen from almost any organic molecule, not just the weakly bonded hydrogen atom of Bu_3SnH , and this would lead to side reactions and lack of selectivity. AIBN is needed only in sufficient quantities to be an initiator of the reaction; it is the Bu_3SnH that provides the hydrogen atoms that end up in the product, so usually you need only 0.02 to 0.05 equivalents of AIBN and a slight excess (1.2 equivalents) of Bu_3SnH .

➔ We used peroxides as initiators of the addition of H–Br to alkenes on p. 971.

■ The bond energy of $\text{H–CH}_2\text{CN}$ is only 360 kJ mol^{-1} ; a tertiary C–H bond next to a CN group should be even weaker.

Bond energy of O–H = 460 kJ mol^{-1} ; few C–H bonds are stronger than 440 kJ mol^{-1} .

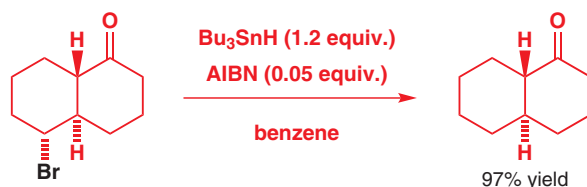

Carbon–carbon bond formation with radicals

You have now met these examples of radical chain reactions:

1. radical addition of halogens to double bonds
2. radical substitution of hydrogen by halogens, or of halogens by hydrogen.

You have seen how the selectivity of these reactions depends upon the bond strengths of the bond being formed or broken. Until about 1975, these reactions, with a few exceptions, were all that were expected of radicals. Since that date, however, the use of radicals in synthetic chemistry has increased tremendously, to the point where complex ring structures such as those of the natural product hirsutene or the steroids can be made from simple acyclic precursors in one radical-promoted step.

What has made this all possible is that chemists have learned how to understand the selectivity of radical reactions to such a degree that they can design starting materials and reagents to define precisely the bonds that will break and form during the reactions. We shall now go on to look at the most important consequence of this ability to control radical reactions: they can be used to make carbon–carbon bonds.

The radical reaction in the margin forms a new carbon–carbon bond. The mechanism is quite similar to that of the very first radical reaction we showed you, right at the beginning of the chapter. Now, with your additional appreciation of the role of bond strength in the selectivity of radical reactions, you should be able to understand why each step proceeds in the way that it does.

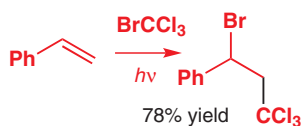

First the weakest bond, C–Br, is broken by the light being shone on to the reaction. Two radicals form, CCl_3^\bullet and Br^\bullet , and it is the CCl_3^\bullet that adds to the (less hindered) unsubstituted end of the alkene to produce a (more stable) secondary benzylic radical.

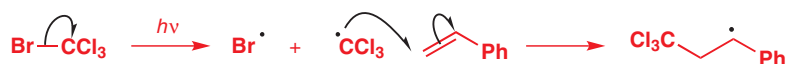

This radical abstracts a Br atom from the BrCCl_3 , breaking the (weakest) C–Br bond, forming the product, and regenerating $\bullet\text{CCl}_3$, which adds to another molecule of alkene. Notice that the carbon-centred radical abstracts Br^\bullet and not $\bullet\text{CCl}_3$ from BrCCl_3 —to abstract $\bullet\text{CCl}_3$ would require a radical substitution at carbon—remember, radicals want the easy pickings from the front of the display; they don't go nosing round the back to see if there's anything better to be had.



This reaction works quite well, giving 78% of the product, but it relies on the fact that the starting material, BrCCl_3 , has an unusually weak C–Br bond (the $\bullet\text{CCl}_3$ radical is highly stabilized by those three chlorine atoms). You can't use most other alkyl bromides for a number of reasons, not least of them being that the product is also an alkyl bromide and, without the selectivity provided by the CCl_3 group, the result would be a mixture of polymers. The problem is that we want the product radical to abstract Br from the starting alkyl bromide to make

■ It is mainly this step that produces the $\bullet\text{CCl}_3$ that undergoes addition to the alkene—the initial photolysis, of course, produces both Br^\bullet and $\bullet\text{CCl}_3$, either of which could add, but, once the radical chain has been initiated, only $\bullet\text{CCl}_3$ is reproduced.

a new alkyl bromide and a new starting radical, and there is no energetic driving force behind this transformation.

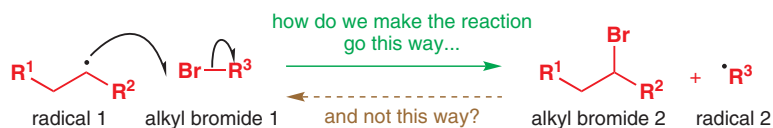

For a way of overcoming this problem, let's go back to the reaction we looked at a few pages ago, the dehalogenation of alkyl halides by Bu_3SnH . The mechanism involves formation of an alkyl (carbon-centred) radical by abstraction of Br by $\text{Bu}_3\text{Sn}^\bullet$. This alkyl radical then just abstracted H^\bullet from Bu_3SnH .

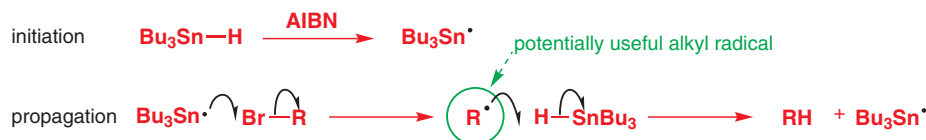

Is it not possible to use this alkyl radical more constructively, and encourage it to react with another molecule (an alkene, say, as CCl_3^\bullet did)? The answer is a qualified yes: look at this reaction:

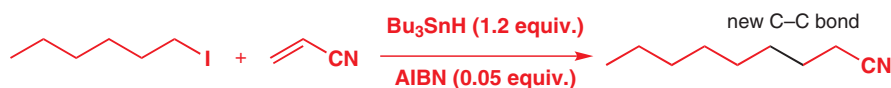

We have added a carbon-centred radical to an alkene in a radical chain reaction! Here is the mechanism:

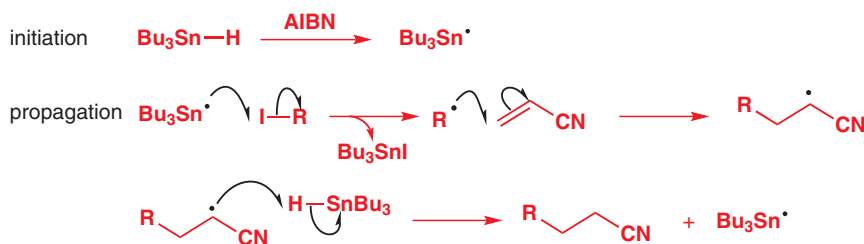

Something important has happened here: the product radical no longer has to abstract the halogen from the starting material, but instead has to abstract H from Bu_3SnH ; it is the $\text{Bu}_3\text{Sn}^\bullet$ thus formed that then regenerates the starting radical. The driving force is provided by formation of C-H at the expense of Sn-H and then Sn-Br at the expense of C-Br.

The use of tin hydrides increases the power of radical reactions in organic synthesis tremendously, and all of the steps in these radical chain processes have been studied in great detail because of the importance of the reactions. We won't dwell excessively on these details, but we need to go back and re-examine some points about this reaction because there are some further subtleties that you need to understand. Bear in mind that we have four radicals all in the reaction mixture at the same time. Yet each reacts with its chosen partner, forsaking all others.

Let's take each type of radical in turn, and look at its selectivity. Clearly bond strength has something to do with this, but how do you explain the opposing selectivities of R^\bullet and the nitrile-stabilized radicals? We shall see that the origins of the selectivities impose some restrictions on the type of starting material that can be used for these C-C bond-forming reactions.

Interactive mechanism for radical addition of an alkyl group to acrylonitrile

We explained on p. 991 how these same favourable thermodynamics drove the Bu_3SnH -promoted reduction of alkyl halides.

four radicals in the mixture:

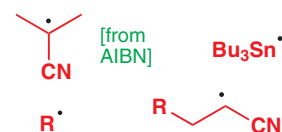

Radical	Reacts like this	Does not react like this
$\text{Bu}_3\text{Sn}^\bullet$		
R^\bullet		
$\text{R}-\text{CH}_2-\dot{\text{C}}\text{H}-\text{CN}$		
$\text{NC}-\dot{\text{C}}(\text{R})_2$		

For the **tin radical**, $\text{Bu}_3\text{Sn}^\bullet$, there is a choice of reaction partners: we need it to abstract the halide from the starting material, but it could alternatively add to the alkene. The Sn–C bond is relatively weak, so addition to the alkene becomes a significant reaction only if:

- there is a large excess of alkene present, and
- the starting alkyl halide is relatively unreactive. This means that only alkyl bromides and iodides can be used effectively to form carbon–carbon bonds; alkyl chlorides are just too unreactive.

The contrasting reactivity of the **alkyl radical** R^\bullet and the **nitrile-containing radicals** needs a little more analysis, and we will look at how both concentration and electronics affect their selectivities.

Concentration effects

You know that R^\bullet is perfectly capable of abstracting H from Bu_3SnH because that is what happened in the dehalogenation reaction on p. 991, but here a different reaction happens: addition to the alkene. In fact, the rate *constant* for reaction of R^\bullet with Bu_3SnH is about the same as that for reaction with acrylonitrile ($\text{CH}_2=\text{CHCN}$), so the only way in which good yields can be obtained is by ensuring that the concentration of acrylonitrile is always at least 10 times that of the tin hydride. The difference in rates will then be sufficient to give 10 times as much addition to the alkene as reduction by the tin hydride. Too much acrylonitrile in the reaction mixture causes problems with side reactions, so a good way of achieving this is to add the tin hydride very slowly during the reaction—often a device known as a syringe pump is used for this. Of course, for complete reaction, a whole equivalent of hydride is necessary, but this can be added over a period of hours.

An elegant alternative is to use a technique conceptually similar to the use of NBS to provide a low concentration of Br_2 for radical allylic substitution. Instead of adding one equivalent of Bu_3SnH , a catalytic amount (usually 0.1–0.2 equivalents) of Bu_3SnCl is added at the beginning of the reaction, with 1 equivalent of NaBH_4 . NaBH_4 will reduce Bu_3SnHal to Bu_3SnH , so about 0.1 equivalent of Bu_3SnH is formed immediately. With each cycle of the chain reaction, a molecule of this Bu_3SnH is converted to Bu_3SnBr , which NaBH_4 can reduce back to Bu_3SnH . Only as much Bu_3SnH is produced as is needed because the rate of production is limited by the rate of reaction.

■ A useful alternative to NaBH_4 as a reducing agent, particularly when there are reactive carbonyl groups in the molecule, is NaCNBH_3 , which still reduces Bu_3SnHal but will not touch aldehydes or ketones (see Chapter 23).

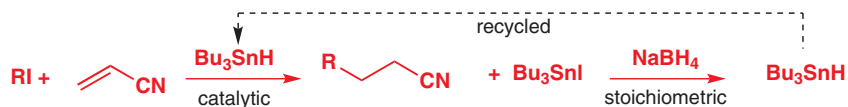

This method was used in the following example, in which an enantiomerically pure lactone, a useful synthetic building block, was made from naturally occurring glyceraldehyde.

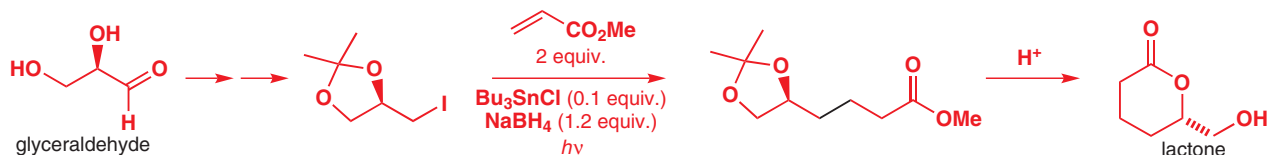

Frontier orbital effects

The second key to success in making sure that the alkyl radical behaves well is to use a reactive radical trap. In fact, this is a major limitation of intermolecular radical carbon-carbon bond-forming reactions: for the trapping of alkyl radicals only electrophilic alkenes (attached to electron-withdrawing groups such as $-\text{CN}$, $-\text{CO}_2\text{Me}$, and $-\text{COMe}$) will do. This is a limitation, but nonetheless cyclohexyl iodide adds to all these alkenes with the yields shown and the rate of addition to most of these alkenes is 10^3 to 10^4 times that of addition to 1-hexene.

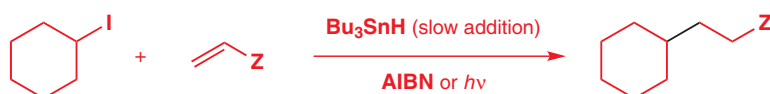

Alkene	% yield	Alkene	% yield
	95		85
	86		85
	72		83
	90		87

To explain why, we have to go back to our analysis (on p. 978) of the electronic structure of radicals and the energy of SOMOs. We said there that, while both electron-withdrawing groups and electron-donating groups will stabilize radicals, electron-withdrawing groups tend to lower the energy of the SOMO, while electron-donating groups tend to raise the energy of the SOMO.

● Electrophilic and nucleophilic radicals

- **Low-energy SOMOs** are more willing to accept an electron than to give one up; radicals adjacent to electron-withdrawing groups are therefore *electrophilic*.
- **High-energy SOMOs** are more willing to give up an electron than to accept an electron; radicals adjacent to electron-donating groups are therefore *nucleophilic*.

Hence the preferred reactivity of these alkyl radicals: they are relatively nucleophilic and therefore prefer to react with electrophilic alkenes. Reaction between a nucleophilic alkyl radical and an unfunctionalized (and therefore nucleophilic) alkene is much slower. Similarly, radicals adjacent to electron-withdrawing groups do not react well with electrophilic alkenes. We can represent all this on an energy level diagram.

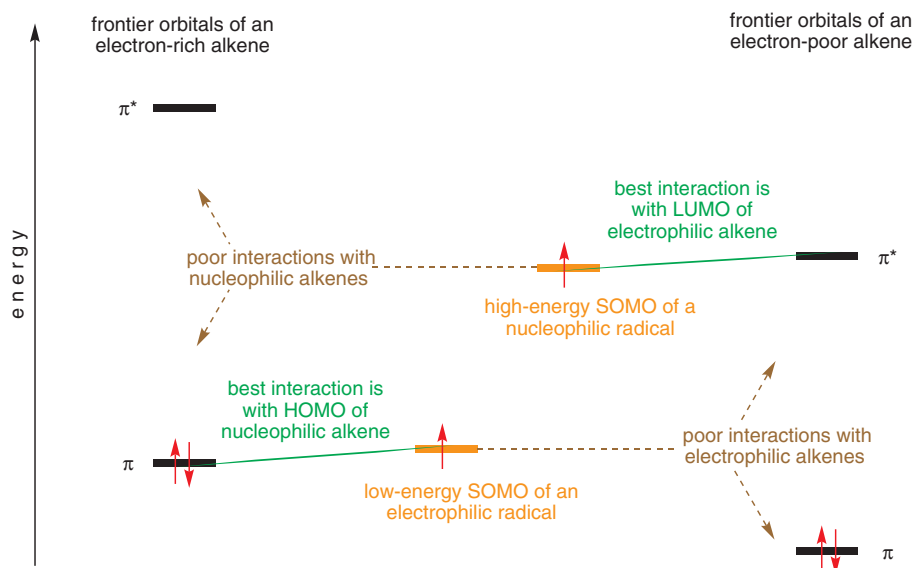

We can now consider the third type of radical in the reaction mixture highlighted on p. 993—the **nitrile-stabilized alkyl radicals**. The diagram above explains the third aspect of radical chemoselectivity in the reaction: why both the product radical and the radicals produced by AIBN choose to react with Bu_3SnH and not with acrylonitrile. These radicals are electrophilic—they have an electron-withdrawing nitrile group attached to the radical centre, so reaction with an electron-poor alkene is slow.

Radical	Reacts with	Does not react with

● Summary of requirements for the successful use of the tin method

Bu_3SnH	must be added or generated slowly
R-X starting material	must contain a weak C-X bond (C-I or C-Br)
radical trap	must be an electrophilic alkene must be present in a concentration at least 10 times that of Bu_3SnH

Electrophilic radicals

■ Notice that this reaction works even though a C-Cl bond needs to be broken to generate the radical. Usually only C-I and C-Br bonds can be used. However, this is a very weak C-Cl bond because the radical produced is so stable. This electrophilic radical can also be formed by H abstraction and by oxidation.

Having seen the energy diagram above, you will not be surprised to learn that the malonate radical adds readily not to electrophilic alkenes, but to nucleophilic alkenes, such as this vinyl ether, which carries an electron-donating oxygen substituent. The malonate radical is electron deficient; it has a low-energy SOMO which interacts best with the relatively high-energy HOMO of the electron-rich, nucleophilic alkene.

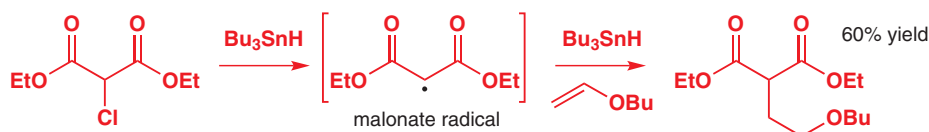

This difference in reactivity applies to non-carbon-centred radicals too. For example, the methyl radical $\cdot\text{CH}_3$ and the chlorine radical $\text{Cl}\cdot$ will both abstract a hydrogen atom from propionic acid. As you would expect, the methyl radical abstracts the hydrogen atom from next to the carbonyl group to form a carbonyl-stabilized radical. Perhaps surprisingly (in view of what we said earlier about the selectivity of radical chlorinations), the chlorine radical abstracts a hydrogen atom from the terminal methyl group of the acid, despite the fact that this C–H bond is stronger. The reason has to be to do with HOMO–LUMO interactions. The methyl radical is nucleophilic, with a high-energy SOMO. It therefore attacks the C–H bond with the lowest LUMO, in other words, α to the carbonyl group. The chlorine atom, on the other hand, is electrophilic: it has a low-energy SOMO (because it is an electronegative element) and attacks the C–H bonds of the terminal methyl group because they have the highest-energy HOMO. Chlorination of functionalized compounds is not as straightforward as that of simple alkanes!

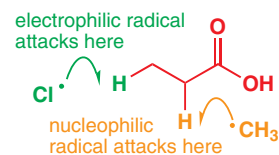

Interactive displays of common polymer structures

There is more on polymerization in the online chapter of that name

Copolymerization

Radical chain reactions are particularly suited to the synthesis of polymers, and there is one example of a polymerization that is worth including here since it demonstrates very nicely the effect of electron-withdrawing or -donating substituents on radical reactivity. When a mixture of vinyl acetate and methyl acrylate is treated with a radical initiator, a rather remarkable polymerization takes place. The polymer produced contains *alternating* vinyl acetate and methyl acrylate monomers along the length of its chain.

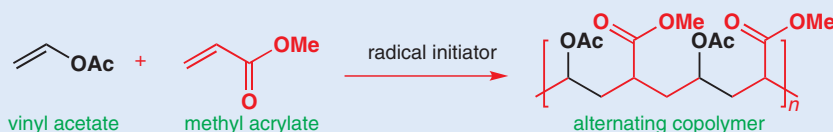

The mechanism of the reaction shows you why. The nucleophilic radical from vinyl acetate (adjacent to filled n orbital of OAc; high-energy SOMO) prefers to add to the electrophilic alkene (the acrylate). The new radical (adjacent to the empty π^* orbital of CO_2Me ; low-energy SOMO) is electrophilic and prefers to add to nucleophilic alkene (the vinyl acetate). This produces a new nucleophilic radical, which again prefers to add to the electrophilic alkene, and the whole cycle occurs repeatedly.

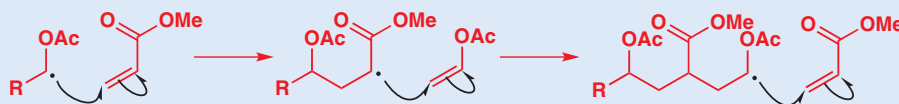

The radical produced by addition to vinyl acetate is nucleophilic, so it adds to methyl acrylate; the radical produced by addition to methyl acrylate is electrophilic, so it adds to vinyl acetate. This reaction is a clear demonstration of the power of frontier orbital theory to explain the reactivity of organic molecules—it would be hard to come up with any other convincing explanation.

The reactivity pattern of radicals is quite different from that of polar reagents

The first reaction that you met in this book, in Chapter 6, was nucleophilic addition to a carbonyl group. Yet we have shown you no examples of radicals adding to carbonyl groups. This typical reaction of polar reagents is really quite rare with radicals.

In Chapter 8 we introduced the concept of $\text{p}K_{\text{a}}$ in which we saw acids and bases exchanging protons. Among the strongest organic acids are those containing O–H bonds. Yet you have seen no radical reactions in which an O–H bond is broken. Carbon acids tend to be much weaker—yet you've seen plenty of examples of C–H bonds being broken by radical attack.

In Chapter 15 we introduced nucleophilic substitution at saturated carbon, using as an example some alkyl bromides. Now, radicals do react with alkyl halides—but not at carbon! Instead they abstract the halogen, leaving an alkyl radical.

The difference in reactivity between, say, organolithiums and radicals, both of them highly reactive, is nicely illustrated by the way in which they react with enones.



➔ For the earlier discussions on hard and soft see p. 357 and 506.

➔ There is a striking illustration of the mismatch between the reactivity of bonds in a simple molecule and the strength of those bonds on p. 207.

We used the terms *hard* and *soft* in Chapters 15 and 22. From all these reactions it's evident that radicals are very soft species: their reactions are driven not at all by the charge density on an atom but by the strength of the bonds being attacked and by the coefficients and energies of the frontier orbitals. O–H bonds are easily broken by strong bases and C=O bonds attacked by strong nucleophiles because of the polarization in the O–H and C=O bond. O–H and C=O bonds are strong, and radicals care nothing for polarization, so radicals prefer to attack the much weaker C–H bonds which (because they are unpolarized) are often inert towards ionic reagents.

● Summary of typical reactivity patterns

With	Polar nucleophiles typically react like this	Radicals typically react like this
unsaturated C=O compounds		
X–H bonds		
alkyl halides		

Alkyl radicals from boranes and oxygen

Although the tin hydride + alkyl halide method is very efficient, tin compounds are falling out of favour because of their toxicity. The reaction between boranes and oxygen provides a simple alternative, and many of the reactions carried out formerly using the tin hydride radical chemistry of pp. 993–997 can now be done using the method we are about to describe.

Mixing trialkylboranes with α,β -unsaturated carbonyl compounds in the presence of water gives conjugate addition of one of the alkyl groups from the boron. The carbonyl compound can be an aldehyde ($R^2 = H$) or a ketone ($R^2 = \text{alkyl}$).

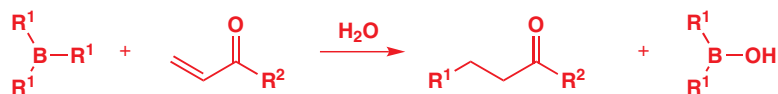

There was a dispute at first as to whether this was a radical reaction or an ionic reaction. The ionic reaction might have been a kind of pericyclic reaction with the intermediate boron enolate being hydrolysed by the water.

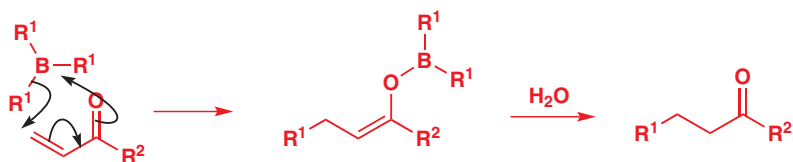

However, H. C. Brown discovered that the reaction was completely inhibited by just 5% of the stable radical galvinoxyl (shown on p. 975), known to be an efficient scavenger for radicals. But where were the radicals coming from? Further experiments showed that small amounts of oxygen were needed to make the reaction work. As you saw in Chapter 3, oxygen is a triplet diradical and displaces alkyl radicals from the trialkyl borane. This reaction looks at first like an S_N2 and is called an S_H2 (second order homolytic displacement), but in reality the oxygen adds to the empty p orbital of planar trigonal boron to release an alkyl radical and start the chain reaction.

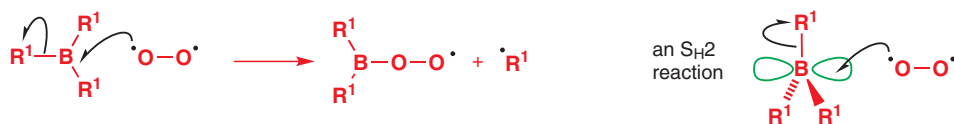

The alkyl radical now adds to the enone to give a delocalized intermediate that can be represented as a carbon- or oxygen-centred radical.

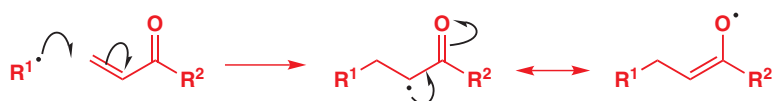

The chain is completed by displacement of another alkyl radical from a trialkylborane at oxygen by the delocalized radical and the formation of the same boron enolate proposed in the ionic reaction. This alkyl radical adds in its turn to the enone, and the boron enolate which forms is hydrolysed to the ketone product. Only small amounts of oxygen are needed to initiate the chain and it is not surprising that the air around the reaction mixture is enough to start a typical reaction. The water (which is inert to radicals, so can be present in the reaction mixture) again hydrolyses the boron enolate.

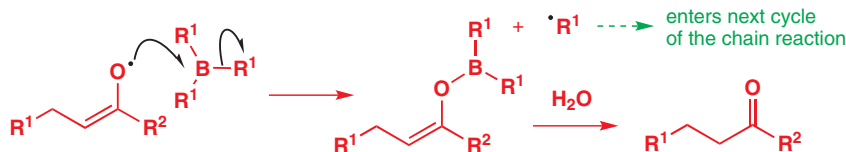

By combining a hydroboration step, which forms the borane, with the radical addition it is possible to carry out transformations such as the one below.

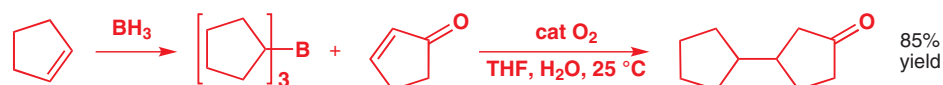

Intramolecular radical reactions are more efficient than intermolecular ones

All of the reactions you have met so far involve radical attack of one molecule on another. We've pointed out some of the drawbacks when C–C bonds are made in this way: the radical trap has to be activated (that is, electrophilic to capture nucleophilic radicals) and must often be present in excess, and the radical starting material must contain very weak C–X bonds (such as C–Br, C–I). The requirements are much less stringent, however, if the radical reaction is intramolecular. For example, this reaction works:

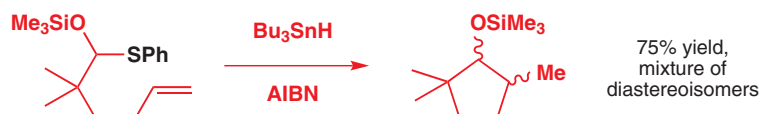

➔ Explanation of the term 'triplet' in this context will be found in Chapter 38, p. 1010.

Notice that the double bond is not activated: in fact, it is nucleophilic, and the reaction still works even though the radical is also substituted with an electron-donating group. The C–S bond that is broken is also relatively strong, yet nonetheless a high yield of product is obtained. Why should this be so? What difference does it make that the reactions are intramolecular?

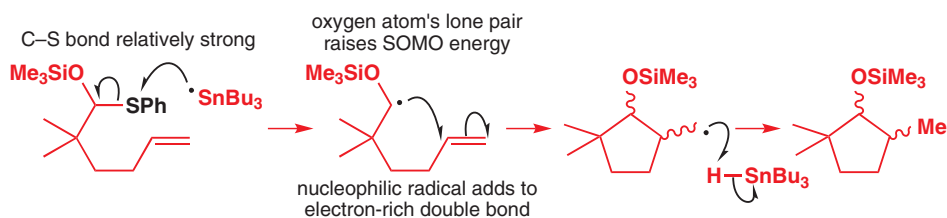

Interactive mechanism for intramolecular radical cyclization

The key is that the intramolecular cyclization of the radical is now enormously favoured over other possible courses of action for the radical. Remember that when we were carrying out radical reactions *intermolecularly*, addition to the radical trap was encouraged by increasing the concentration of radical trap and decreasing the concentration of Bu_3SnH to avoid radical reduction. For *intramolecular* reactions, the double bond that acts as the radical trap is always held close to the radical, and cyclization takes place extremely rapidly, even on to unactivated double bonds. The hydride donor (Bu_3SnH) doesn't get a look in, and can be present in higher concentrations than would otherwise be possible. Moreover, as there is only one equivalent of radical trap, and the trap need not be highly reactive, there is little danger of high concentrations of Bu_3Sn^* reacting with it, so the concentration of Bu_3Sn^* can build up to levels where the rate of abstraction of groups like Cl, SPh, and SePh is acceptable, despite their stronger C–X bonds.

● Why are intramolecular radical reactions so good?

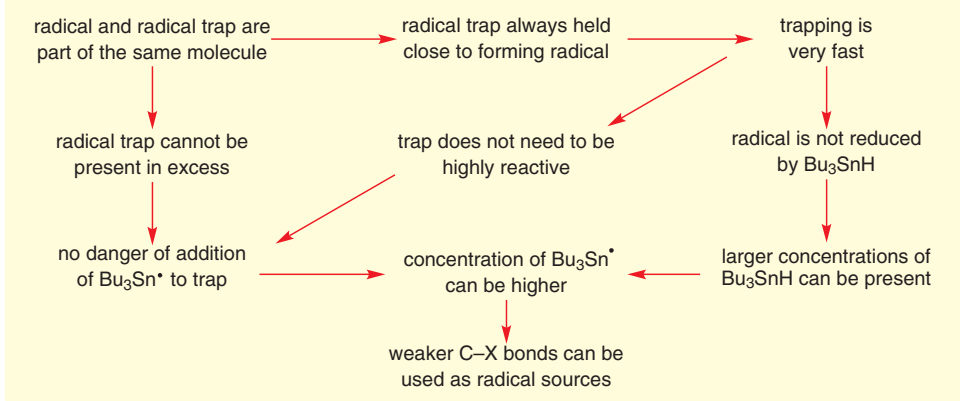

For all these reasons, intramolecular radical reactions are very powerful, and are often used to make five-membered rings.

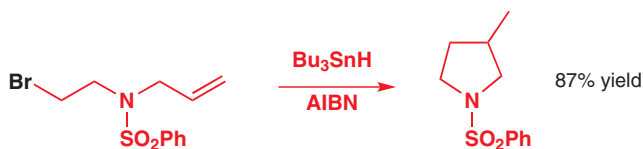

It is possible to make other ring sizes also, but the range is rather limited. Because of ring strain, three- and four-membered rings cannot be formed by radical reactions. Otherwise, smaller rings form faster than larger ones: look at these selectivities.

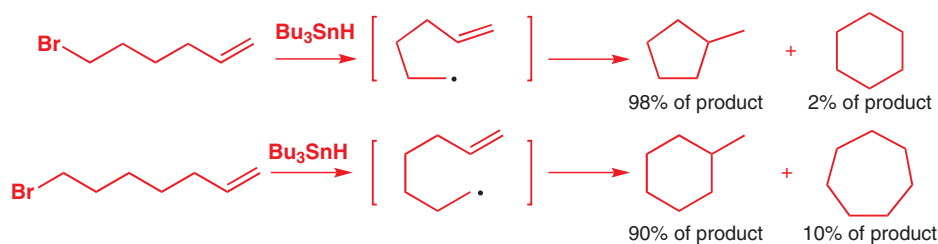

Interactive mechanism for radical ring closures

The preference for formation of a smaller ring is a very powerful one: in this reaction, the five-membered ring forms and not the six-membered one, even though cyclization to give a six-membered ring would also give a more stabilized radical.

Baldwin's rules, describing the formation of different ring sizes, were described in Chapter 31, p. 810. They apply to radical reactions and ionic reactions equally well.



We said earlier that the toxicity of tin poses some problems, so it is useful that the borane-oxygen method (p. 998) works well for initiating radical cyclizations too. It is not necessary to incorporate boron into the starting material, since a combination of Et_3B , O_2 , and hypophosphorous acid, H_3PO_2 , can generate a radical from a halide which will cyclize in the same way as the tin-promoted examples you have just seen. Once again, a five-membered ring is preferred to the alternative six-membered ring.

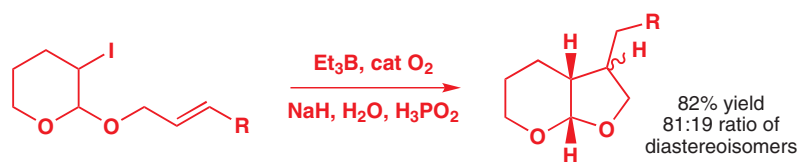

Notice that the ethyl groups from Et_3B are not incorporated into the product. The displacement of Et^\bullet from Et_3B initiates the chain reaction by abstracting the iodine atom from the starting material. The radical cyclizes to give a five-membered ring, as expected. A *cis* ring junction is inevitable because of the acetal 'tether'.

This type of stereochemical control is discussed in Chapter 32.

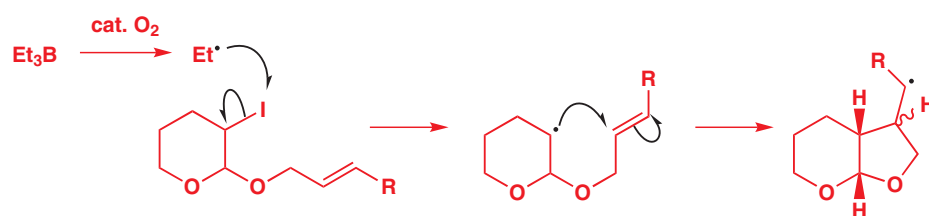

The product radical has to collect a hydrogen from somewhere, and this is the role of the hypophosphorous acid. Abstraction of H gives a radical that can be drawn either as P-centred or O-centred.

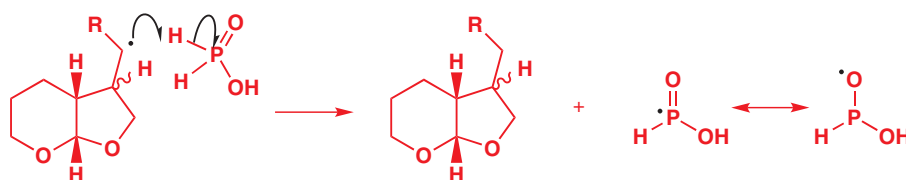

The chain is finally completed by a hydrogen abstraction from H_3PO_2 , which gives a radical that attacks the borane, just like oxygen did in the initiation step. A new ethyl radical is generated, which starts the cycle again.

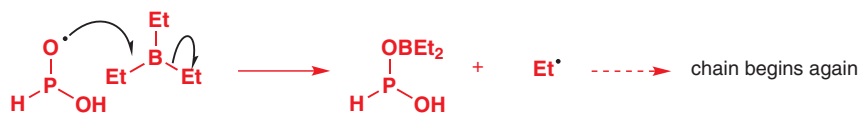

Looking forward

Radicals are important because they react in ways difficult to achieve with anions and cations, and show usefully different selectivity. Although radical reactions are generally less important than ionic reactions, environmental and biological radical reactions are remarkably common in an atmosphere that is 20% oxygen diradical. Diradicals will feature to a greater extent in the next chapter, in which we move on from carbon atoms carrying seven valence electrons to carbon atoms carrying only six valence electrons, called *carbenes*.

Further reading

A basic introduction is *Radical Chemistry: The Fundamentals*, J. Perkins, Oxford Primer, OUP, Oxford, 2000. *Reactive Intermediates*, C. J. Moody and G. H. Whitham, Oxford Primer, OUP, Oxford, 2001, has a section on radicals.

The evidence that the McMurry reaction happens on a metal surface is quite nice, though, and if you're interested you can read McMurry's own account of it in *Accounts of Chemical Research*, 1983, **16**, 405 and J. E. McMurry, *Chem. Rev.*, 1989, **89**, 1513.

There are a couple of recipes in B. S. Furniss, A. J. Hannaford, P. W. G. Smith, and A. T. Tatchell, *Vogel's Textbook of Practical*

Organic Chemistry, Longman, 5th edn, 1989, pp. 576–579 that give examples of the use of NBS and dibenzoyl peroxide.

The borane-oxygen method of making radicals is reviewed by C. Ollivier and P. Renaud in *Chemical Reviews*, 2001, **101**, 3415. In common with most *Chemical Reviews*, this is a long scholarly article but reviews like this are essential to chemists wanting to know about a new reagent, method, or synthesis.

Check your understanding



To check that you have mastered the concepts presented in this chapter, attempt the problems that are available in the book's Online Resource Centre at <http://www.oxfordtextbooks.co.uk/orc/clayden2e/>

Connections

➔ Building on

- Energy profile diagrams [ch12](#)
- Elimination reactions [ch17](#)
- Main group chemistry [ch27](#)
- Controlling stereochemistry [ch14 & ch31–ch33](#)
- Diastereoselectivity [ch33](#)
- Heterocycles [ch29 & ch30](#)
- Pericyclic reactions [ch34 & ch35](#)
- Rearrangements [ch36](#)
- Radicals [ch37](#)

Arriving at

- Carbenes are neutral species with only six electrons
- Carbenes can have paired or unpaired electrons
- Carbenes are normally electrophilic
- Typical reactions include insertion into C=C bonds
- Insertion into C–H and O–H bonds is possible
- Intramolecular insertion is stereospecific
- Carbenes rearrange easily
- Carbenes are useful in synthesis
- Ruthenium–carbene complexes undergo metathesis reactions

➔ Looking forward to

- Determination of mechanism [ch39](#)
- Organometallic chemistry [ch40](#)

Diazomethane makes methyl esters from carboxylic acids

In 1981, some chemists in Pennsylvania needed to convert this carboxylic acid into its methyl ester as part of the synthesis of an antibiotic compound. What reagent did they choose to do the reaction?

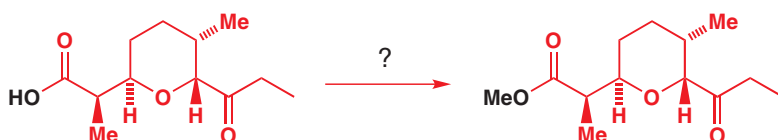

You remember, of course, that esters can be made from carboxylic acids and alcohols under acid catalysis, so you might expect them to use this type of method. On a small scale, it's usually better to convert the acid to an acyl chloride before coupling with an alcohol, using pyridine (or DMAP) as a base; this type of reaction might have been a reasonable choice too.



But, in fact, they chose neither of these methods. Instead, they simply treated the carboxylic acid with a compound called diazomethane, CH_2N_2 , and isolated the methyl ester.

➔ Acyl chlorides are made from carboxylic acids with either thionyl chloride or oxalyl chloride. Look back at Chapter 10 if you need reminding of any of these reactions.

■ You might like to think about why the alternatives would not be so suitable in this case.

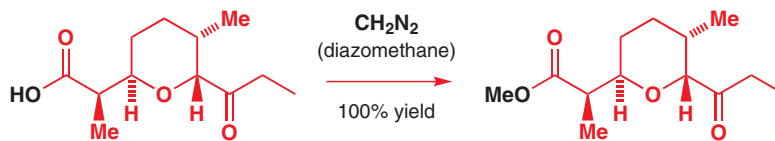

Diazomethane, CH_2N_2 , is a rather curious compound that has to be drawn as a dipole. There are several different ways of expressing its structure.

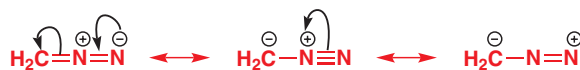

■ You've met other molecules like this—neutral compounds where we have to write charges to account for electrons correctly: carbon monoxide is one, and so are nitro compounds and the 1,3-dipoles you met in Chapter 34.

Diazomethane methylates carboxylic acids because carboxylic acids readily protonate it, giving an extremely unstable diazonium cation. This compound is desperate to lose N_2 , the world's best leaving group, and so it does, with the N_2 being substituted by the carboxylate anion. The carboxylate anion is in exactly the right position to carry out the $\text{S}_{\text{N}}2$ reaction shown below.

 Interactive mechanism for methylation of carboxylic acid with diazomethane



Conveniently, solutions containing diazomethane are yellow, so the reaction is **self-titrating**—as the carboxylic acid reacts, the yellow diazomethane is removed, but as long as excess diazomethane remains the yellow colour persists.

Diazomethane methylation is a good way of making methyl esters from carboxylic acids on a small scale because yields are excellent and the only by-product is nitrogen. However, there is a drawback: diazomethane has a boiling point of -24°C , and it is a toxic and highly explosive gas. It therefore has to be used in solution, usually in ether; the solution must be dilute, because concentrated solutions of diazomethane are also explosive. It is usually produced by reaction of *N*-methyl-*N*-nitrosourea or *N*-methyl-*N*-nitrosotoluenesulfonamide with base, and distilled out of that reaction mixture as an azeotrope with ether, straight into a solution of the carboxylic acid.

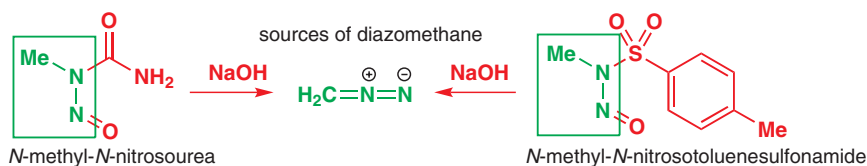

The mechanism of the reaction that forms diazomethane is shown below. The key step is base-catalysed elimination, although the curly arrows we have to draw to represent this are rather tortuous!

formation of diazomethane

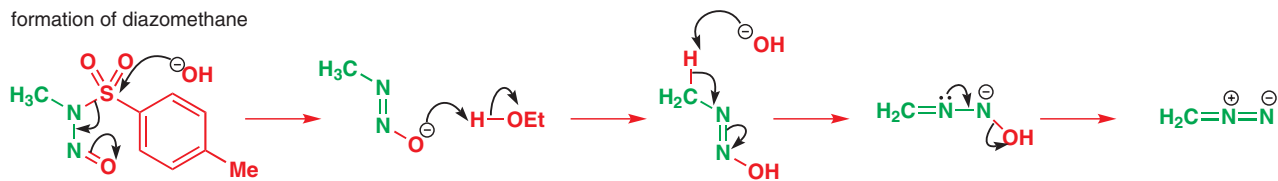

Diazomethane will also methylate phenols because they too are acidic enough to protonate it. Ordinary alcohols, though, are not methylated because they are not strong enough acids to protonate diazomethane.



Selective methylation

Chemists studying the hormone degradation products present in the urine of pregnant women needed to methylate the phenolic hydroxyl group of the steroid oestriol. By using diazomethane, they avoided reaction at the two other

hydroxyl groups. When, subsequently, they did want to methylate the other two hydroxyl groups, they had to add acid (HBF_4) to the reaction to protonate the diazomethane.

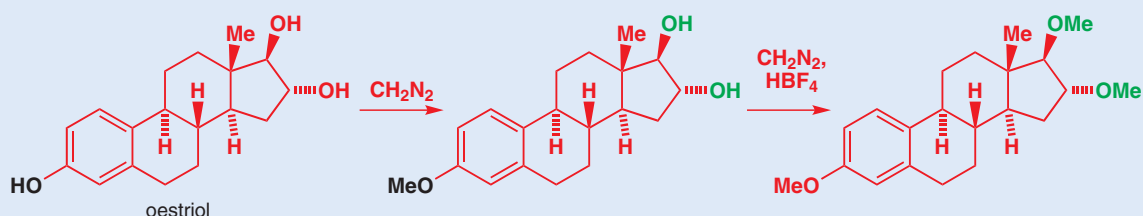

Photolysis of diazomethane produces a carbene

Alcohols *can* be methylated by diazomethane if the mixture is irradiated with light.

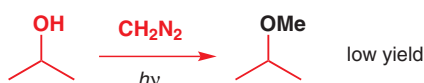

The mechanism is now totally different because the light energy promotes loss of nitrogen (N_2) from the molecule *without protonation*. This means that what is left behind is a carbon atom carrying just two hydrogen atoms (CH_2), and having only six electrons. Species like this are called *carbenes*, and they are the subject of this chapter.



■ Although this reaction illustrates an important point, the yield is too low, there are too many by-products, and the potential for serious explosions is too great for it ever to be useful as a way of making methyl ethers.

■ Carbenium ions such as $^+\text{CH}_3$ also have only six valence electrons, but, of course, unlike carbenes they are charged.

- Carbenes are neutral species containing a carbon atom with only six valence electrons.

The six electrons of a carbene are located two in each bond, plus two non-bonding electrons often represented as $:\text{CR}_2$ (as though they were a lone pair). As you will see later, this can be misleading, but $:\text{CR}_2$ is a widely used symbol for a carbene. In the case of $:\text{CH}_2$ generated from diazomethane, the carbene is trapped by the alcohol to make an ether.

Like the radicals in Chapter 37, carbenes are extremely reactive species. More important than their reaction with alcohols to make ethers are their reactions with alkenes to make cyclopropanes and their insertion into C–H bonds.

● Typical carbene reactions

The carbene inserts itself into a σ bond or a π bond.

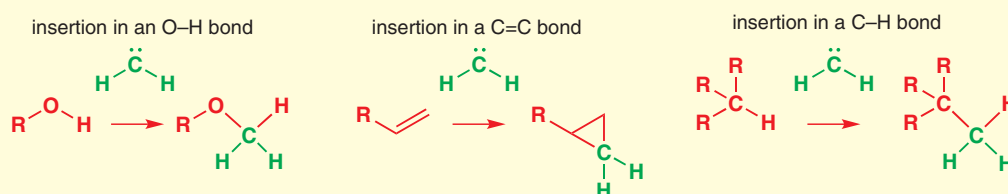

We will discuss the mechanisms of these three important reactions shortly, but we have introduced them to you now because they demonstrate that the reactions of carbenes are dominated by *insertion* (here, insertion into O–H, C=C, and C–H) driven by their extreme

Interactive mechanism for carbene formation by photolysis

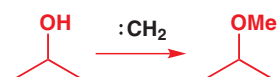

electrophilicity. A carbon atom with only six electrons will do almost anything to get another two!

How do we know that carbenes exist?

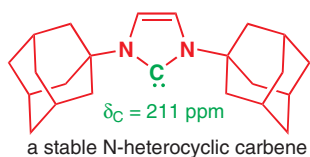

■ You may be somewhat surprised that the structure of carbenes can be investigated by ESR—after all, we explained in Chapter 37 that ESR observes unpaired electrons, and you might expect the six valence electrons of a carbene all to be paired. Indeed, in some carbenes they are, but in many they are not. This is an important point, and we will discuss it further later in the chapter.

Naming azo compounds

Don't confuse *diazo* compounds with *azo* compounds. Diazomethane has twice as many nitrogen atoms per carbon atom as azomethane.

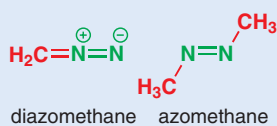

You met *diazonium* salts in Chapter 22. Arene diazonium salts are stable compounds, but alkyl diazonium salts, which are formed by protonation of diazo compounds, are not. They decompose rapidly with loss of N_2 —this was how the carboxylic acid got methylated at the beginning of the chapter. Other relatives of the azo and diazo compounds are alkyl azides. Alkyl azides have three nitrogen atoms and are usually stable but azides of low molecular weight may explode on impact or heating.

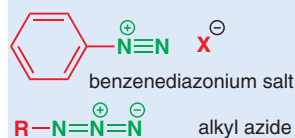

The best evidence for the existence of carbenes comes from a group of structures which contain a carbene but are stable compounds. The most important of these are known as the 'N-heterocyclic carbenes'—the carbene is incorporated into a five-membered ring and stabilized by the presence of two adjacent electron-donating nitrogen atoms and the bulky N-substituents. The example below was first made in 1991: it is crystalline, and its X-ray crystal shows the bond angle at the carbene carbon to be 102° , and ^{13}C NMR confirms that the carbene C atom is electron deficient. We will come back to the significance of this later.

These stable carbenes are very much the exception: most carbenes are too reactive to be isolated. Reactive carbenes can, however, be observed by irradiating precursors (often diazo compounds like diazomethane, which we have just been discussing) trapped in frozen argon at very low temperatures (less than 77 K). IR and ESR spectroscopy (see p. 975) can then be used to determine their structure.

Ways to make carbenes

Carbenes are usually formed from precursors by the loss of small, stable molecules. We will discuss some of the most important methods in turn, but you have already seen one in action: the loss of nitrogen from a diazo compound.

Carbenes from diazo compounds

We showed you the formation of a carbene from diazomethane to illustrate how this reaction was different from the (ionic) methylation of carboxylic acids. But this is not a very practical way of generating carbenes, not least because of the explosive nature of diazoalkanes. However, diazocarbonyl compounds are a different matter.

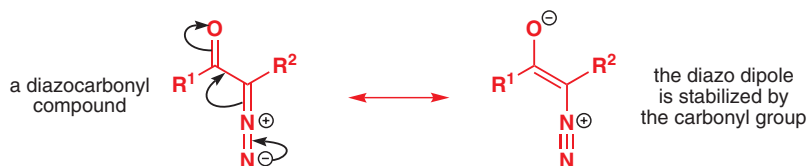

They are much more stable, because the electron-withdrawing carbonyl group stabilizes the diazo dipole, and are very useful sources of carbenes carrying a carbonyl substituent. There are two main ways of making diazocarbonyl compounds:

1. by reacting an acyl chloride with diazomethane

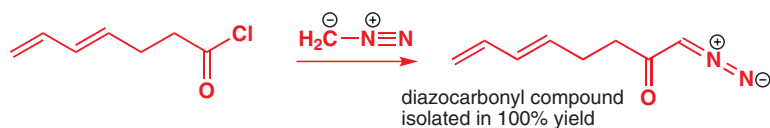

2. by reacting the parent carbonyl compound with tosyl azide, TsN_3 , in the presence of base.

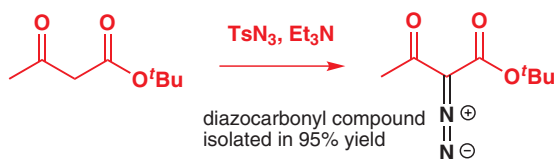

The reaction of diazomethane with acyl chlorides starts as a simple acylation to give a diazonium compound. If there is an excess of diazomethane, a second molecule acts as a base to remove a rather acidic proton between the carbonyl and the diazonium groups to give the diazocarbonyl compound.

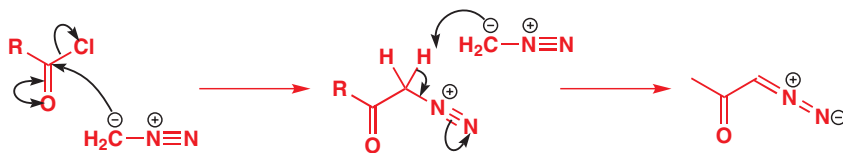

 Interactive mechanism for carbene formation from acyl chlorides with diazomethane

What happens to that second molecule of diazomethane? By collecting a proton it turns into the very reactive diazonium salt, which collects a chloride ion, and MeCl is given off as a gas. The second method uses tosyl azide, which is just N₂ attached to a good leaving group.

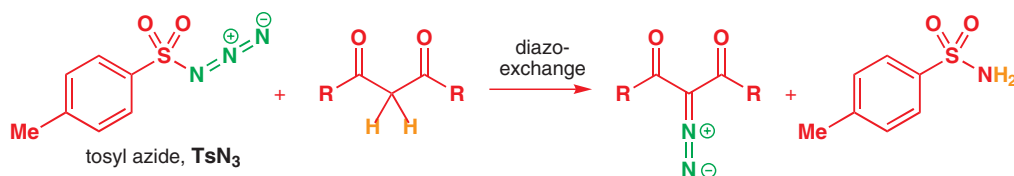

Diazocarbonyl compounds can be decomposed to carbenes by heat or light. The loss of gaseous nitrogen compensates energetically for the formation of the unstable carbene.

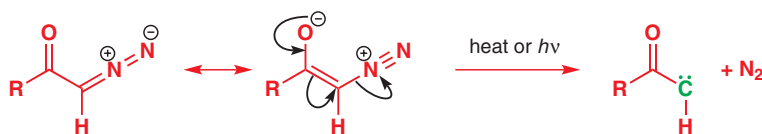

It is much more common in modern chemistry to use a transition metal, such as copper or rhodium, to promote formation of the carbene.

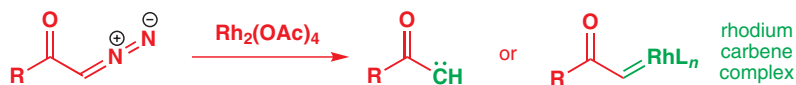

■ RhL_n means rhodium with an unspecified number of unspecified ligands. This notation is common in organometallic chemistry when the nature of the carbon–metal bonding is important, but the precise structure of the metal complex is not.

Carbenes formed in this way are, in fact, not true carbenes because they remain complexed with the metal used to form them. They are known as *carbenoids*, and their reactions are discussed later in the chapter.

Fischer carbenes

While these rhodium and copper carbenoids are unstable, some transition metals such as tungsten and chromium form stable, isolable carbenoids, called **metallocarbenes** or **Fischer carbenes**.

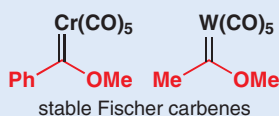

Carbenes from tosylhydrazones

Many more carbenes can be made safely from diazoalkanes if the diazoalkane is just an intermediate in the reaction and not the starting material. Good starting materials for these reactions are tosylhydrazones, which produce transient diazo compounds by base-catalysed elimination of toluenesulfinate. The diazo compound is not normally isolated, and decomposes to the carbene on heating.

■ This reaction is sometimes called the **Bamford–Stevens reaction**. Notice that the leaving group from nitrogen is not the familiar tosylate (toluene-*p*-sulfonate TsO⁻ or ToISO₃) but the less familiar toluene-*p*-sulfinate (Ts⁻ or ToISO₂).

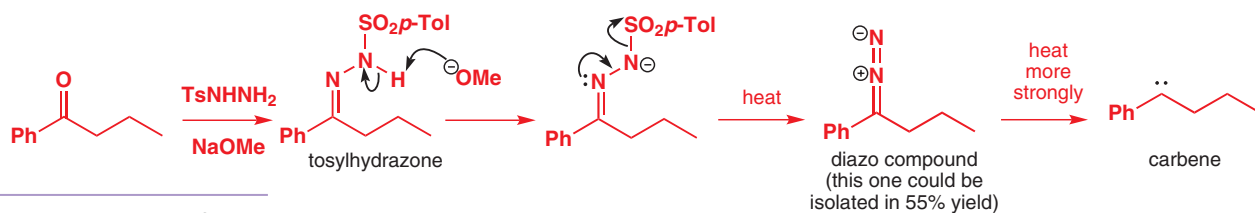

Interactive mechanism for carbene formation from tosylhydrazones

Carbenes are formed in a number of other similar reactions—for example, loss of carbon monoxide from ketenes or elimination of nitrogen from azirines—but these are rarely used as a way of deliberately making carbenes.

Carbene formation by α elimination

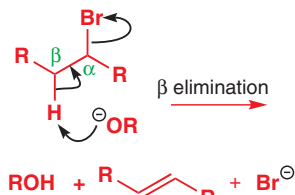

In Chapter 17 we discussed β elimination in detail—reactions in which a hydrogen atom is removed from the carbon atom β to the leaving group. α Eliminations (eliminations in which both the proton and the leaving group are located on the same atom) are also possible—in fact, the reaction we've just been talking about (elimination of toluenesulfonate from tosylhydrazones) is an α elimination. α Eliminations follow a mechanism akin to an E1cB β elimination—a strong base removes an acidic proton adjacent to an electron-withdrawing group to give a carbanion. Loss of a leaving group from the carbanion creates a carbene.

base-catalysed α elimination of HCl from chloroform

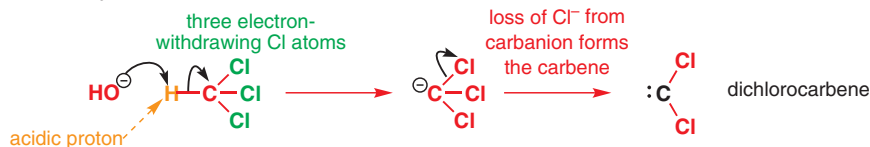

Interactive mechanism for carbene formation by α elimination

One of the best known α elimination reactions occurs when chloroform is treated with base. This is the most important way of making dichlorocarbene, :CCl_2 , and other dihalocarbenes too, although it must be said that the widespread use of dichlorocarbene in chemistry is due mainly to the ease with which it can be made using this method!

Hydroxide and alkoxide anions are strong enough bases to promote α elimination from chloroform, and from other trihalomethanes. Carbenes can be formed from dihaloalkanes by deprotonation with stronger bases such as LDA, and even from primary alkyl chlorides using the extremely powerful bases phenylsodium or *t*-BuLi/*t*-BuOK (weaker bases just cause β elimination).



The mixture *t*-BuLi/*t*-BuOK is known as **Schlosser's base**, and is one of the most powerful bases known. It will abstract protons from allylic or benzylic positions, and will even deprotonate benzene. Similar, very powerful, bases can be made from other combinations of alkyllithiums and group I metal alkoxides.

It is unfortunate that the term carbenoid is used for two distinct classes of molecule—usually it refers to the transition-metal bound carbene formed by metal-catalysed decomposition of diazo compounds (see p. 1018)—and for this reason the carbenoids that we are discussing here are best referred to as 'lithium carbenoids', with the metal specified.

When geminal dibromoalkanes are treated with BuLi, a halogen–metal exchange reaction produces a lithium carbenoid, with a metal atom and a halogen attached to the same carbon atom. Lithium carbenoids are stable at very low temperatures—they can be observed by NMR, but they decompose to carbenes at about -100°C .

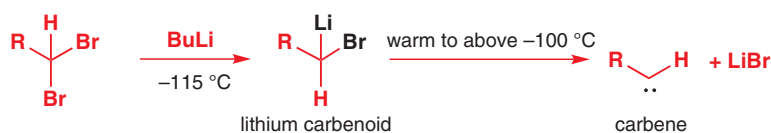

The essence of this type of carbenoid is that it should have a leaving group, such as a halogen, that can accept a pair of electrons and another, usually a metal, that can donate a pair of electrons. If the metal leaves first, a carbanion is created that can lose the halogen to make a carbene. They might also leave together. Both mechanisms are α eliminations.

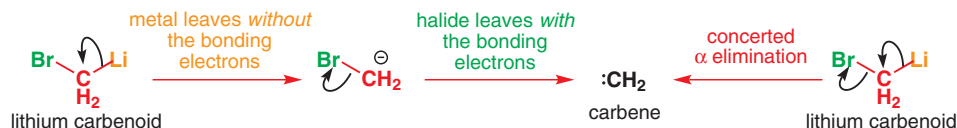

While lithium carbenoids have limited applicability, an analogous zinc carbenoid, which can be formed by insertion of zinc into diiodomethane, is a reagent in one of the most widely used carbenoid reactions in chemistry—the Simmons–Smith reaction.

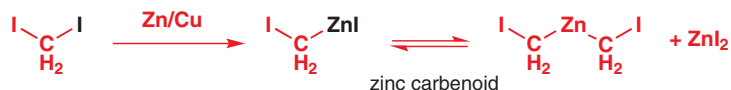

The problem with many of these reactions is that they require strong bases—either the organometallic compound itself is basic or a base must be used to create the carbanion. Carbenes are so unstable that they must be formed in the presence of the compound they are intended to react with, and this can be a problem if that compound is base-sensitive. For dichlorocarbene, a way round the problem is to make the carbanion by losing CO_2 instead of a metal or a proton. Decarboxylation of sodium trichloroacetate is ideal as it happens at about 80°C in solution.

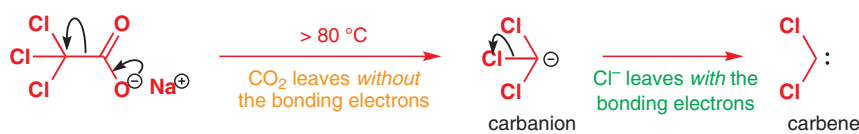

Carbene formation by deprotonation of a cation

Our final method is in some ways the most straightforward in terms of mechanism: simple removal of a proton from a stable cation. This is the method used to make very stable carbenes, and it works because both the cation used as the starting material and the carbene product are stabilized by one or more adjacent lone pairs. Here is an example. Imidazoles are nucleophilic, and can be alkylated to give relatively stable imidazolium cations, which we can represent with the charge delocalized between the two nitrogen atoms, although there is another possible representation with the charge on carbon.

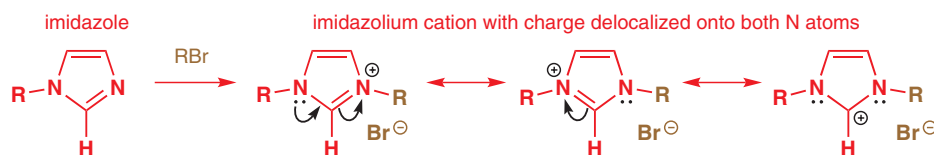

When the imidazolium cation is treated with a strong base, for example sodium hydride, the proton of this central, partially positively charged carbon is removed, to give a compound which initially looks like a carbanion.

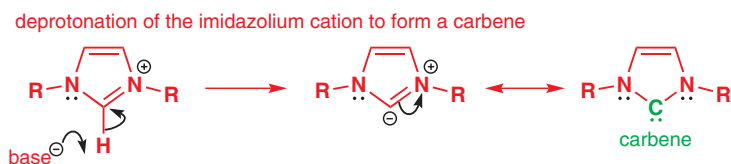

➔ The Simmons–Smith reaction, one of the best ways of making cyclopropanes, is discussed later in the chapter.

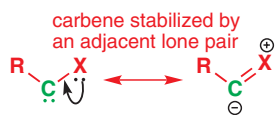

But we can use a curly arrow to move the negative charge towards the positively charged nitrogen, leaving a neutral species with a lone pair at carbon. A close look at the central carbon shows, however, that it has only two substituents—it is a carbene. Carbenes with adjacent lone pairs can often be thought of in this way, the lone pair partially delocalized onto the C atom to help stabilize the electron-deficient carbene.

● **Summary: the most important ways of making carbenes**

Carbenes are neutral species containing a carbon atom with only six valence electrons.

Type of carbene	Method of formation
	metal (rhodium or copper)-catalysed decomposition of diazocarbonyl compound
	thermal decomposition of diazo compound, often derived from tosylhydrazones
	α elimination of chloroform with base or decarboxylation of trichloroacetate
	Deprotonation of $\text{RCH}=\text{X}^+$ cation

Carbenes can be divided into two types

We made two important observations in the box on p. 1016 regarding the structure of carbenes that we will now return to and seek an explanation for. Firstly, we said that the X-ray crystal structure of the stable, crystalline carbene on the left shows that the bond angle at the carbene C is 102° and, secondly, we said that many carbenes can be observed by ESR—in other words, they have unpaired electrons.

Spectroscopic investigations of a number of carbenes of differing structures have shown that they fall broadly into two groups: (1) those (which you will learn to call ‘triplets’) that ESR spectroscopy demonstrates have unpaired electrons and whose bond angles are $130\text{--}150^\circ$ and (2) those (like the stable crystalline carbene above, and which you will learn to call ‘singlets’) that have bond angles of $100\text{--}110^\circ$ but cannot be observed by ESR. Many carbenes, like CH_2 itself, can be found in either group, although one may be more common.

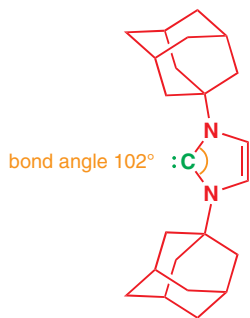

➔ ESR (electron spin resonance), also known as EPR (electron paramagnetic resonance), was discussed in the context of radicals on p. 975.

Type 1: triplet carbenes	Type 2: singlet carbenes
bond angle $130\text{--}150^\circ$	bond angle $100\text{--}110^\circ$
observable by ESR	all electrons paired
$:\text{CH}_2$	$:\text{CCl}_2$
$:\text{CHPh}$	$:\text{CHCl}$
$:\text{CHR}$	$:\text{C(OMe)}_2$
$:\text{CPh}_2$	

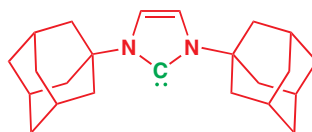

proposed, but incorrect, linear structure for carbene
two p orbitals, each containing one electron

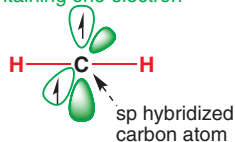

All these observations can be accounted for by considering the electronic structure of a carbene. Carbenes have two-coordinate carbon atoms: you might therefore expect them to have a linear (diagonal) structure—like that of an alkyne—with an sp hybridized carbon atom.

Such a linear carbene would have six electrons to distribute amongst two σ orbitals and two (higher-energy) p orbitals. The two electrons in the degenerate p orbitals would remain unpaired because of electron repulsion in the same way as in molecular oxygen $\bullet\text{O}-\text{O}\bullet$.

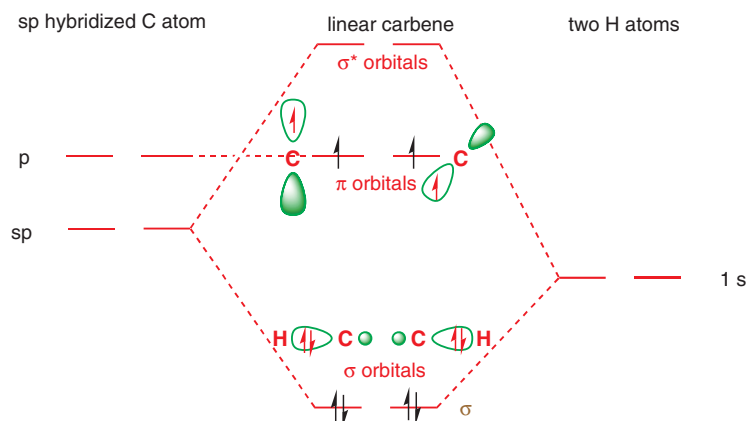

Yet few carbenes are linear: most are bent, with bond angles between 100° and 150° , suggesting a trigonal (sp^2) hybridization state. An sp^2 hybridized carbene would have three (lower-energy) sp^2 orbitals and one (high-energy) p orbital in which to distribute its six electrons. There are two ways of doing this. Either all of the electrons can be paired, with each pair occupying one of the sp^2 orbitals, or two of the electrons can remain unpaired, with one electron in each of the p orbitals and one of the sp^2 orbitals.

two ways of arranging the electrons in a bent (sp^2) carbene:

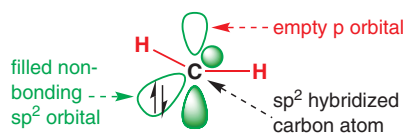
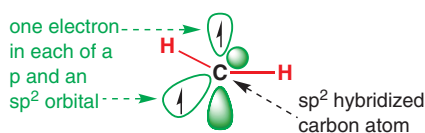

These two possibilities explain our two observed classes of carbene, and the two possible arrangements of electrons (spin states) are termed triplet and singlet. The orbitals are the same in both cases but in triplet carbenes we have one electron in each of two molecular orbitals and in singlet carbenes both electrons go into the sp^2 orbital.

electronic structure of a bent (sp^2) triplet carbene with two unpaired electrons

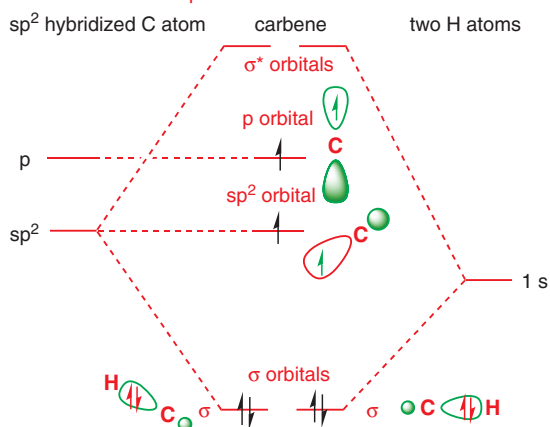

electronic structure of a bent (sp^2) singlet carbene with two paired electrons

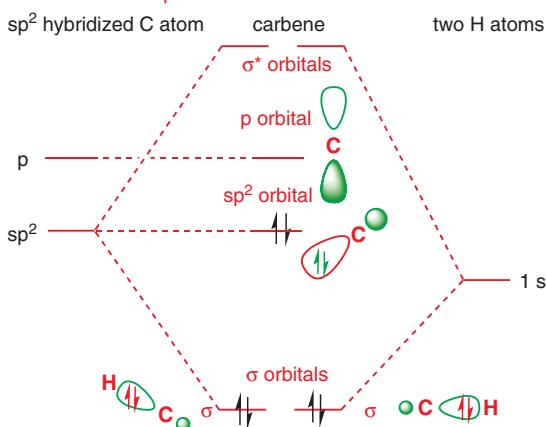

● Singlet and triplet carbenes

Triplet carbenes have two unpaired electrons, one in each of an sp and a p orbital, while **singlet carbenes** have a pair of electrons in a non-bonding sp^2 orbital and have an empty p orbital.

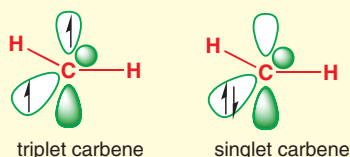

The existence of the two spin states explains the different behaviour of triplet and singlet carbenes towards ESR spectroscopy; the orbital occupancy also explains the smaller bond angle in singlet carbenes, which have an electron-repelling lone pair in an sp^2 orbital.

Triplet carbenes

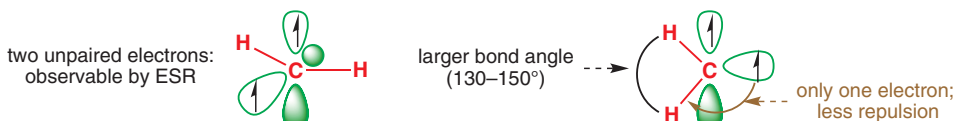

Singlet carbenes

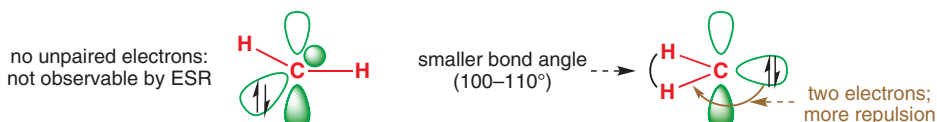

In the table on p. 1010 we saw that the substituents on the carbene affect which of the two classes (which we now call singlet and triplet) it falls into. Why? All carbenes have the potential to exist in either the singlet or the triplet state, so what we mean when we say that a carbene such as $:\text{CH}_2$ is a 'triplet carbene' is that the triplet state for this carbene is lower in energy than the singlet state. The opposite is true for $:\text{CCl}_2$. Most types of carbenes are more stable as triplets because the energy to be gained by bringing the electron in the p orbital down into the sp^2 orbital is insufficient to overcome the repulsion that exists between two electrons in a single orbital.

For most triplet carbenes the singlet spin state that would arise by pairing up the two electrons lies only about 40 kJ mol^{-1} above the ground (triplet) state: in other words, 40 kJ mol^{-1} is required to pair up the two electrons.

Carbenes that have singlet ground states (such as $:\text{CCl}_2$) all have electron-rich substituents carrying lone pairs adjacent to the carbene centre. These lone pairs can interact with the p orbital of the carbene to produce a new, lower-energy orbital which the two electrons occupy. This stabilization of the lone pair provides the incentive that the electron in the p orbital needs to pair up in the sp^2 orbital.

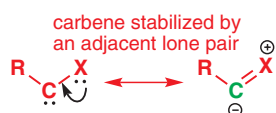
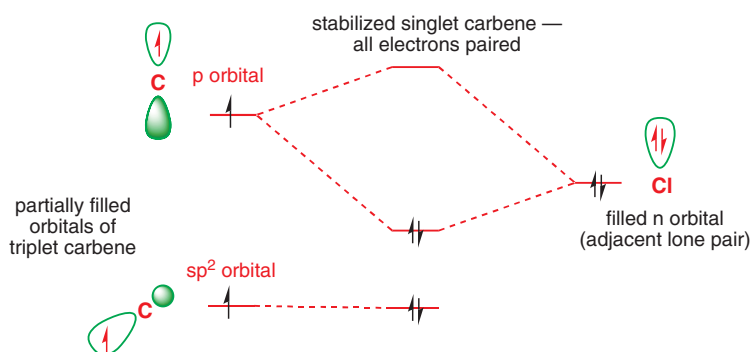

This interaction corresponds to the point we made above about adjacent lone pairs stabilizing carbenes via the delocalization shown in the margin. As these arrows suggest, carbenes that have heavily electron-donating substituents are less electrophilic than other carbenes: indeed, diamino carbenes can be quite nucleophilic. The division of carbenes into two types explains

➔ This is a manifestation of Hund's rule—see Chapter 4.

■ When a carbene is actually formed in a chemical reaction, it may not be formed in its most stable state, as we shall see.

their structure. It also helps to explain some of their reactions, especially those that have a stereochemical implication. We will spend the rest of this chapter discussing how carbenes react.

The structure of carbenes depends on how they are made

So far we have considered only the most stable possible structure, singlet or triplet, of a given carbene. In reality, a carbene will be formed in a chemical reaction and may well be formed as the less stable of the alternatives. If a reaction occurs by an ionic mechanism on a molecule with all electrons paired (as most molecules are!) then it must be formed as a singlet. Follow the α elimination mechanism, for example.

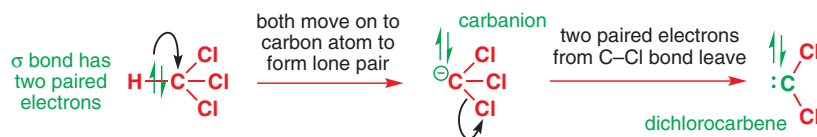

The starting material, a molecule of chloroform CHCl_3 , has all paired electrons. The C-H σ bond breaks and the two paired electrons from it form the lone pair of the carbanion. The carbanion also has all paired electrons. The two paired electrons of one of the C-Cl bonds leaves the carbanion and the carbene is formed. It has two paired electrons in each of the two remaining C-Cl bonds and the lone pair, also paired. It is formed as a singlet. As it happens, the singlet version of CCl_2 is also the more stable. But if the carbene were instead CH_2 and if it reacted rapidly, it might not have a chance to change into the more stable triplet state. Since carbenes are very reactive, this question can be important. In explaining their reactions in the next section we shall need to consider:

- how the carbene was formed
- how rapidly it reacts
- whether it can change into the other state (singlet or triplet).

How do carbenes react?

Carbenes are desperate to find another pair of electrons with which to complete their valence shell of electrons. In this respect they are like carbocations. Like carbocations, they are electrophilic but, unlike carbocations, they are uncharged. This has consequences for the type of nucleophiles carbenes choose to react with. Carbocations attack nucleophiles with high charge density—those carrying a negative or partial negative charge (think of the type of nucleophiles that will take part in $\text{S}_{\text{N}}1$ or Friedel–Crafts reactions). Carbenes, on the other hand, attack compounds we'd normally never consider as nucleophiles—even simple alkanes—by taking electrons from their HOMO. Of course, a carbocation will usually react with the HOMO of a molecule, but it will be much more selective about which HOMOs will do—usually these have to be lone pairs or electron-rich alkenes. For carbenes, any HOMO will do—a lone pair, a C=C double bond (electron-rich or -poor), or even a C-H bond.

As you will see (and as we generalized at the beginning of the chapter), many of these reactions can be considered as insertion reactions—overall the carbene appears to have found a bond and inserted itself in the middle of it. It's important to remember that the term 'insertion' describes the overall consequence of the reaction, but isn't always an accurate description of the reaction's mechanism.

Carbenes react with alkenes to give cyclopropanes

This reaction is the most important way of making cyclopropanes, and is probably the most important reaction of carbenes. The mechanism of this type of reaction (an example is shown in the margin) depends on whether the carbene is a singlet or a triplet, and the outcome of the reaction can provide our first chemical test of the conclusions we came to in the

■ In this respect, a carbene is like an electrophilic radical—very reactive and very soft.

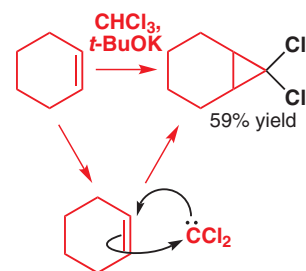

previous section. Singlet carbenes, like this one here (remember that substituents with lone pairs stabilize the singlet spin state) can add to alkenes in an entirely concerted manner: the curly arrows for the process can be written as shown in the margin.

Because the process is concerted, we expect that the geometry of the alkene should be preserved in the product—the reaction ought to be *stereospecific*. The two examples below show that this is indeed the case. It is more impressive that the *Z* alkene gives the *cis*-cyclopropane as this is less stable than the *trans*-cyclopropane and would change to *E* if it could.

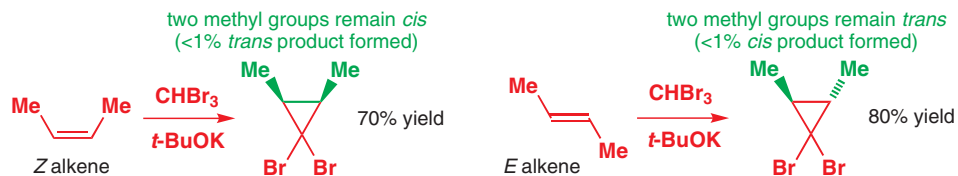

The alkene insertion reaction is stereospecific only for singlet carbenes. For triplet carbenes, the reaction is non-stereospecific. In the example below, a triplet carbene gives a mixture of cyclopropane diastereoisomers from a pure *Z* alkene.

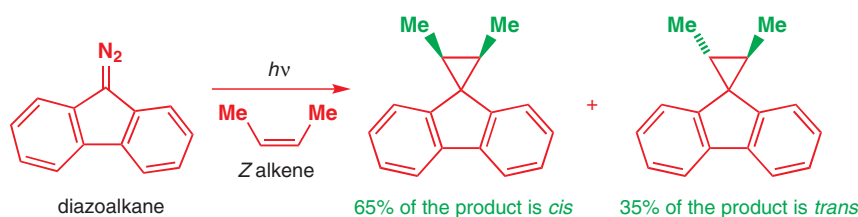

The mechanism of the reaction must be different with a triplet carbene. In fact, a concerted reaction is impossible for triplet carbenes because of the spins of the electrons involved. The spins of a triplet carbene aren't paired, so once the carbene has added to the alkene in a radical reaction, the diradical (triplet) intermediate must wait until one of the spins inverts ('flips') before the second C–C bond can be formed with paired electrons.

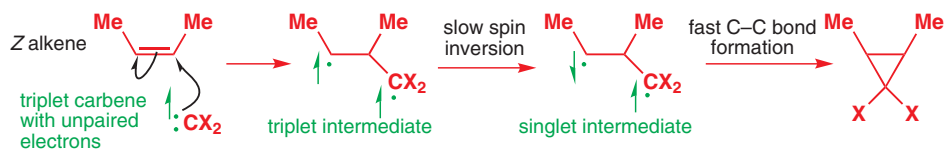

Interactive mechanism for triplet carbenes in cyclopropane formation

Spin-flipping, which can occur only through collision with another molecule (of solvent usually), is relatively slow on the time-scale of molecular rotations and, by the time the electrons are in a fit state to pair up, the stereochemistry of the starting material has been scrambled by free rotation in the intermediate.

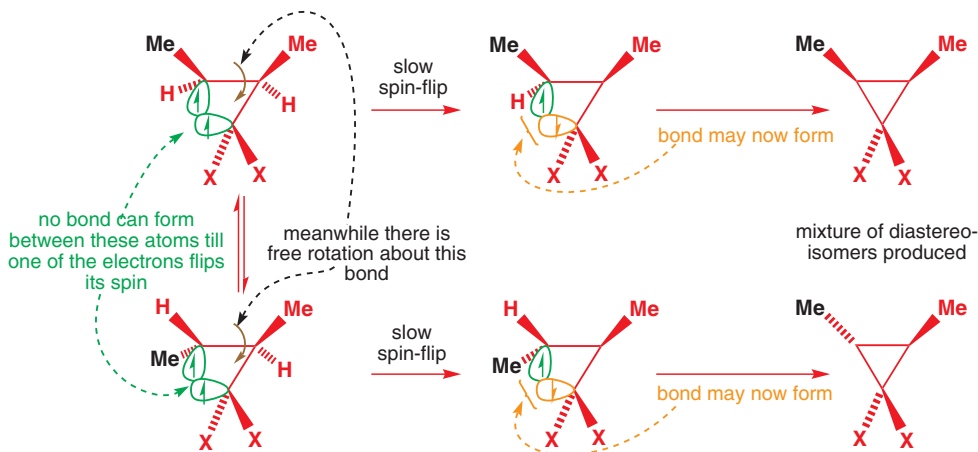

The same constraints arising from the need for conservation of electron spin apply to the *formation* as well as to the *reaction* of carbenes. When a carbene forms by α elimination, say, from a molecule with all electrons paired, it must be formed as the singlet, whether or not the triplet state is lower in energy. Only later may the carbene undergo spin-flipping to the triplet state. Since most carbene reactions are very rapid, this means that carbenes that are known to have triplet ground states may, in fact, react in their first-formed singlet state because they don't have time to spin-flip to the triplet. This is true for $:\text{CH}_2$ produced from CH_2N_2 , which adds stereospecifically to double bonds because it is formed as a singlet and because the singlet state is more reactive than the triplet.

Some evidence for triplet carbenes in cyclopropane formation

If the reaction is diluted with a large amount of an inert solvent such as C_3F_8 (perfluoropropane) then $:\text{CH}_2$ undergoes more collisions before it reacts and so the chances of spin-flipping of singlet $:\text{CH}_2$ to triplet $:\text{CH}_2$ is increased. Addition to alkenes is then less stereospecific.

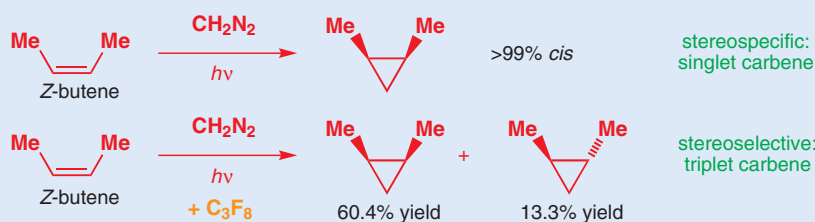

Stereospecificity (or lack of it) in the addition of a carbene to an alkene *can* be a good test of whether the carbene reacts as a singlet or triplet: lack of stereospecificity in a carbene addition almost certainly indicates that a triplet carbene is involved, but the fact that an addition *is* stereospecific doesn't mean that the carbene must be a singlet. In some cases, bond rotation may be quite slow, and spin-flipping rapid, leading to stereospecific addition. Notice that in this example the less stable *cis* (*Z*) alkene was used: the reaction will give the less encumbered *trans*-cyclopropane if it can.

The addition of a triplet carbene to an alkene can be considered to be rather like a radical addition to a double bond. The concerted addition of a singlet carbene, on the other hand, is a pericyclic reaction, and from Chapter 34 you should be able to classify it as a [1 + 2] cycloaddition.

addition of triplet carbenes is a radical reaction

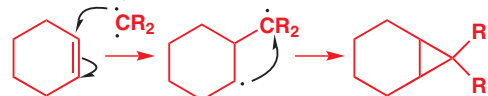

addition of singlet carbenes is a [1+2] cycloaddition

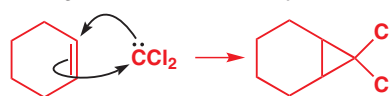

As a cycloaddition, singlet carbene addition to an alkene must obey the rules of orbital symmetry discussed in Chapters 34 and 35. We might consider the empty p orbital of the carbene (LUMO) interacting with the π bond (HOMO) of the alkene or the lone pair of the carbene in its filled sp^2 orbital (HOMO) interacting with the π^* antibonding orbital of the alkene (LUMO).

direct approach of carbene

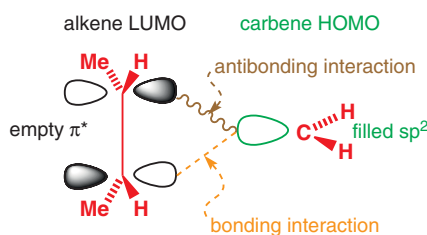
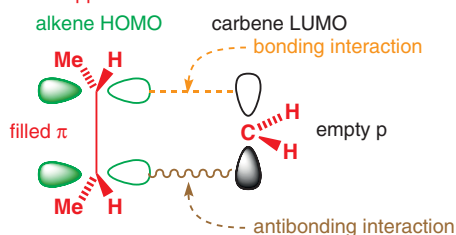

You can immediately see that there is a problem when we try to interact these orbitals constructively to build two new bonds—direct approach of the carbene to the alkene is impossible because there is always an antibonding interaction. Two new bonds can be formed, however, if the carbene approaches the alkene in a 'sideways-on' manner.

Interactive comparison of singlet and triplet carbenes in cyclopropane formation

■ Cycloadditions in which one of the components is a single atom (in other words, [1 + *n*] cycloadditions) are sometimes called **cheletropic reactions**.

Interactive examples of other cheletropic reactions with SO_2

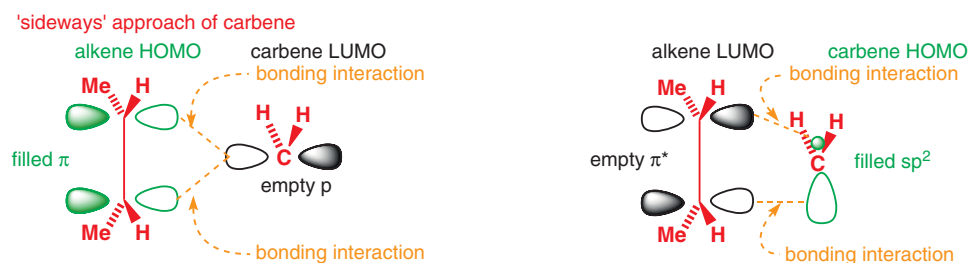

The cyclopropane product must, of course, have a more or less tetrahedral arrangement about the carbon atom that was the carbene so that, even if the carbene approaches in a sideways-on manner, it must then swing round through 90° as the bonds form.

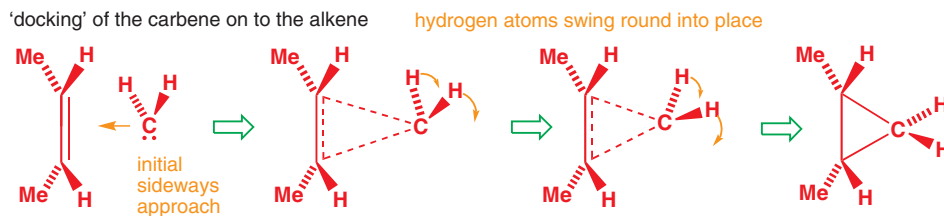

Interactive mechanism for singlet carbenes in cyclopropane formation

Making cyclopropanes

Many natural products and biologically active compounds contain cyclopropane rings: we shall feature just a few. First, a most important natural insecticide, a pyrethrin from the East African pyrethrum daisy, and its synthetic analogue decamethrin, one of the most important insecticides in agriculture. Very low doses of this highly active and non-persistent insecticide are needed.

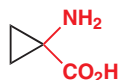
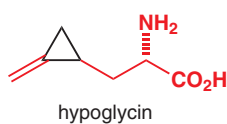
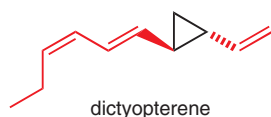
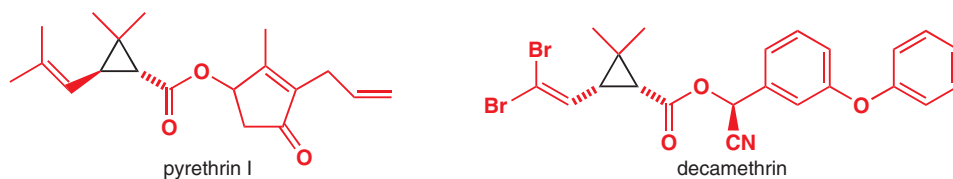

The 'ozone' or 'iodine' smell of the sea has nothing to do with O_3 or I_2 . It's more likely a dictyopterene, a family of volatile cyclopropanes used by female brown algae to attract male gametes.

Other cyclopropanes include two natural but highly unusual amino acids. Hypoglycin is a blood sugar level lowering agent from the unripe fruit of the ackee tree. It's the causative agent of Jamaican vomiting sickness. Don't eat the green ackee.

The second and simpler amino acid is found in apples, pears, and grapefruit, and encourages fruit ripening by degradation to ethylene.

Our last and most extraordinary example is an antifungal antibiotic first synthesized in 1996 and containing no fewer than five cyclopropanes. It has the prosaic name FR-900848 but is known unofficially as 'jawsamycin'.

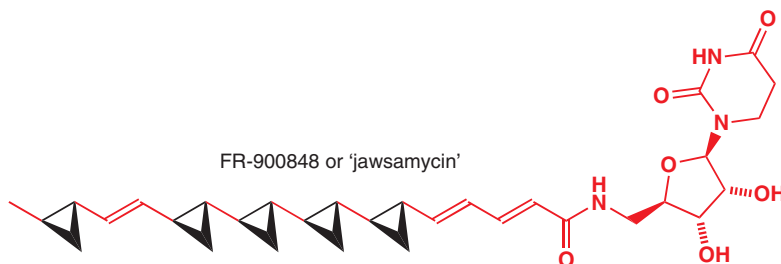

Most chemical syntheses of compounds containing cyclopropyl groups make use of the addition of a carbene, or carbene equivalent, to an alkene. What do we mean by carbene equivalent? Usually, this is a molecule that has the potential to form a carbene, although it may not actually react via a carbene intermediate. One such example is the zinc carbenoid formed when diiodomethane reacts with zinc metal (most conveniently as a mixture with copper—a 'zinc–copper couple'). It reacts with alkenes just as a carbene would—it undergoes addition to the π bond and produces a cyclopropane.

the Simmons–Smith reaction

formation of the zinc carbenoid

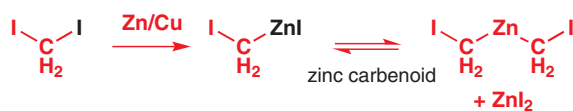

reaction of the zinc carbenoid

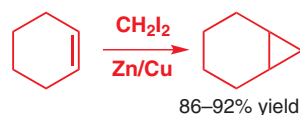

The reaction is known as the Simmons–Smith reaction, after the two chemists at the DuPont chemical factory who discovered it in 1958. Even after several decades, it is the most important way of making cyclopropane compounds, although nowadays a variant that uses more easily handled starting materials is often used. Diethyl zinc replaces the Zn/Cu couple of the traditional Simmons–Smith reaction. In this example, a double cyclopropanation on a C_2 symmetric diene derived from tartaric acid gives very good stereoselectivity for reasons we will soon discuss.

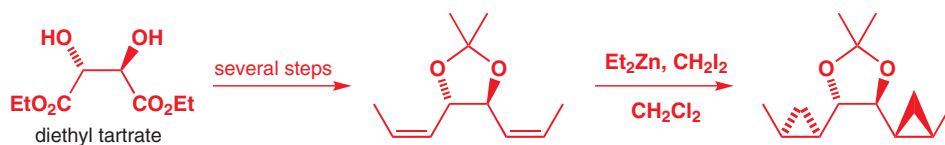

The mechanism of the Simmons–Smith reaction appears to be a carbene transfer from the metal to the alkene without any free carbene being released. It may look something like this.

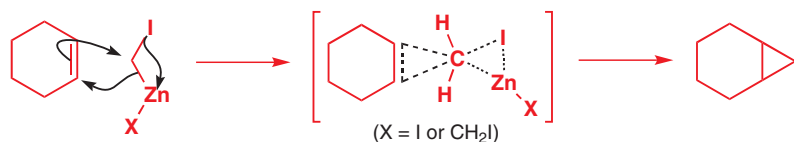

Some of the evidence for this comes from a reaction that not only throws light on to the mechanism of Simmons–Smith cyclopropanations, but makes them of even greater value in synthesis. When an allylic alcohol is cyclopropanated, the new methylene group adds stereoselectively to the same face of the double bond as the hydroxyl group.

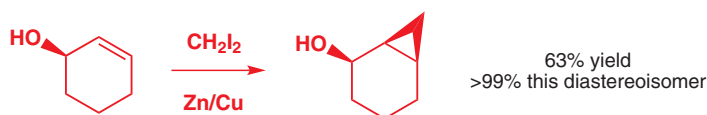

Allylic alcohols are also cyclopropanated over 100 times faster than their unfunctionalized alkene equivalents. Coordination between the zinc atom and the hydroxyl group in the transition state explains both the stereoselectivity and the rate increase. Unfortunately, while the Simmons–Smith reaction works well when a methylene (CH₂) group is being transferred, it is less good with substituted methylene groups (RCH: or R₂C:).

The carbene derived by metal-catalysed decomposition of ethyl diazoacetate attacks alkenes to introduce a two-carbon fragment into a cyclopropane—an industrial synthesis of ethyl chrysanthemate, a precursor to the pyrethrin insecticides (see p. 1016), uses this reaction. The diene in the starting material is more nucleophilic (has a higher energy HOMO; see Chapter 19) than the single alkene in the product, so the reaction can be stopped after one carbene addition.

■ You met this zinc carbenoid on p. 1009. Zn/Cu couple is a type of alloy but without a precise composition or structure; typically it contains >90% zinc.

➡ You might notice the similarity to the epoxidation of allylic alcohols with *m*-CPBA mentioned in Chapter 32.

🔗 Interactive mechanism for chelation-directed cyclopropanation

■ On the subject of stereochemistry, note that the Simmons–Smith zinc carbenoid behaves like a singlet carbene—its additions to alkenes are stereospecific (the product cyclopropane retains the geometry of the alkene) as well as stereoselective (the carbenoid adds to the same face as the hydroxyl group).

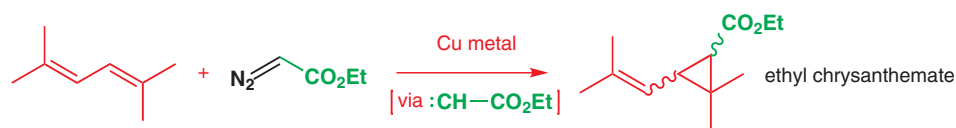

The intramolecular version of this reaction is more reliable, and has often been used to make compounds containing multiply substituted cyclopropanes. Corey made use of it in a synthesis of sirenin, the sperm-attractant of a female water mould.

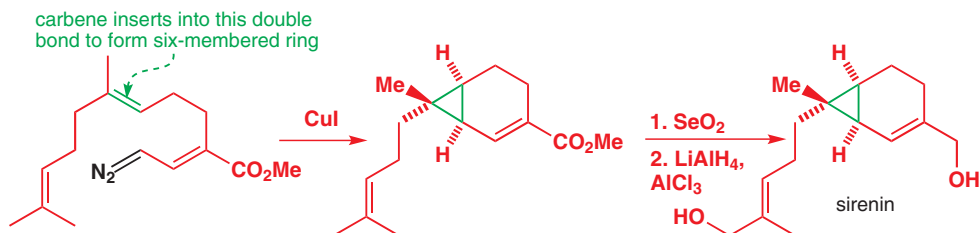

➔ The selenium dioxide oxidation is discussed in Chapter 35, p. 919.

➔ You met electrocyclic reactions like this in Chapter 35.

As you might imagine, carbenes like this, substituted with electron-withdrawing carbonyl groups, are even more powerful electrophiles than carbenes like $:\text{CCl}_2$, and will even add to the double bonds of benzene. The product is not stable, but immediately undergoes electrocyclic ring opening.

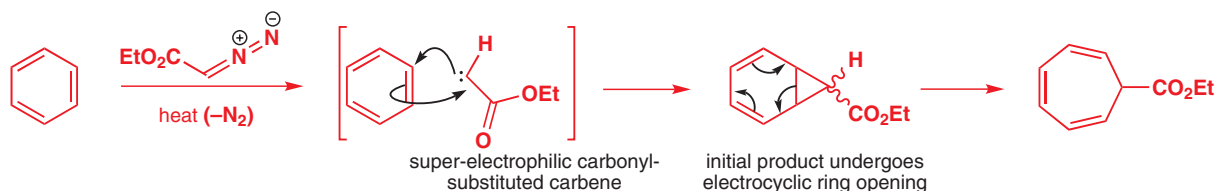

Comparison of '-enoid' reagents

Before we leave this section on cyclopropanes, we want you to take a step back from simply thinking about carbenes, and consider the types of reagents that form three-membered rings generally. They all have something in common, which we could call '-enoid' character. Cyclopropanes form when a carbene (which, in the singlet state, has an empty, electrophilic p orbital and a full, nominally nucleophilic sp^2 orbital) attacks alkenes. The Simmons–Smith carbenoid is not a carbene, but nonetheless has a carbon atom with joint nucleophilic (alkyl zinc) and electrophilic (alkyl iodide) character. When you think about it, the same is true for peracid epoxidation, which forms the oxygen analogue of a cyclopropane by attacking an alkene using an oxygen atom bearing both a lone pair (nucleophilic) and a carboxylate leaving group (electrophilic). It's an 'oxenoid'. In Chapter 27 you met other reagents that form cyclopropanes and epoxides by transferring CH_2 —sulfonium ylids. These yet again have a carbon atom carrying both a negative charge and a leaving group. You can consider them to be particularly stable carbenoids.

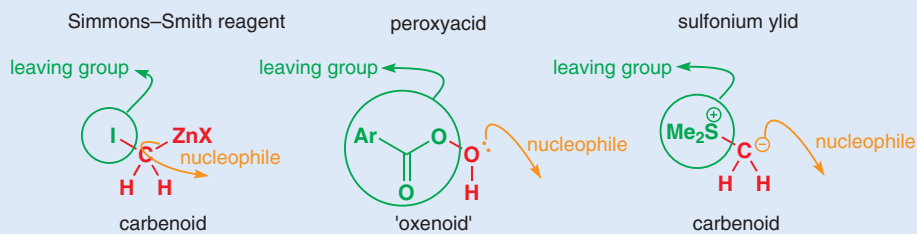

Insertion into C–H bonds

We said that the formation of cyclopropanes by addition of substituted carbenes to alkenes was rare—in fact, alkyl-substituted carbenes undergo very few intermolecular reactions at all because they decompose very rapidly. When primary alkyl halides are treated with base, alkenes are formed by elimination. Having read Chapter 17, you should expect

the mechanism of this elimination to be E2 and, if you started with a deuterated compound like this, the alkene product would be labelled with two deuterium atoms at its terminus.

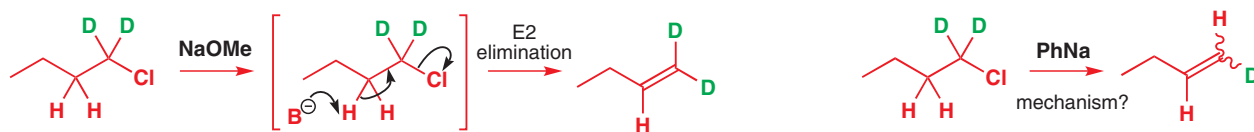

This is indeed what happens if the base is sodium methoxide ($pK_a[\text{MeOH}]$ about 16). If, however, it is phenylsodium ($pK_a[\text{benzene}]$ about 50), only 6% of the product is labelled in this way while 94% of the product has only one deuterium atom.

Evidently a hydrogen atom has ‘migrated’ from the 2-position to the 1-position. The overall mechanism of the elimination with very strong bases like phenylsodium is thought to be: (1) formation of a carbene by α elimination and then (2) 1,2-migration of a hydrogen atom on to the carbene centre. Carbenes with β hydrogens undergo extremely rapid 1,2-migration of hydrogen to the carbene centre, giving alkenes.

➔ Migrations were covered in detail in Chapter 36. You met examples there of migrations on to electrophilic *carbocationic* centres, but the reactions are in essence very similar to these migrations to carbenes.

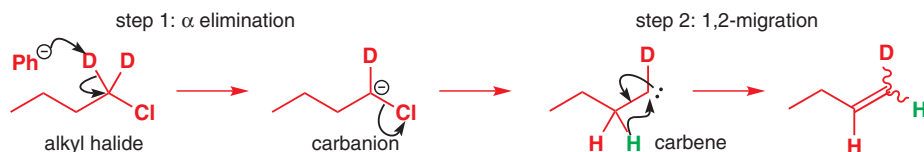

The reason for the rapid migration is that the electrophilic carbene has found a nearby source of electrons—the HOMO of the C–H bond—and it has grabbed the electrons for itself, ‘inserting’ into the C–H bond, as shown in the margin.

This type of reaction is better demonstrated by two examples in which the ‘insertion reaction’ is a bit more obvious: when there are no β hydrogens, the carbene inserts into C–H bonds a little further away in the same molecule or even in the solvent (cyclohexane in the second example). In the first case, the carbene is formed by α elimination (using one of the ‘Schlosser bases’, see p. 1008) and, in the second case, by photolysis of a diazoketone.

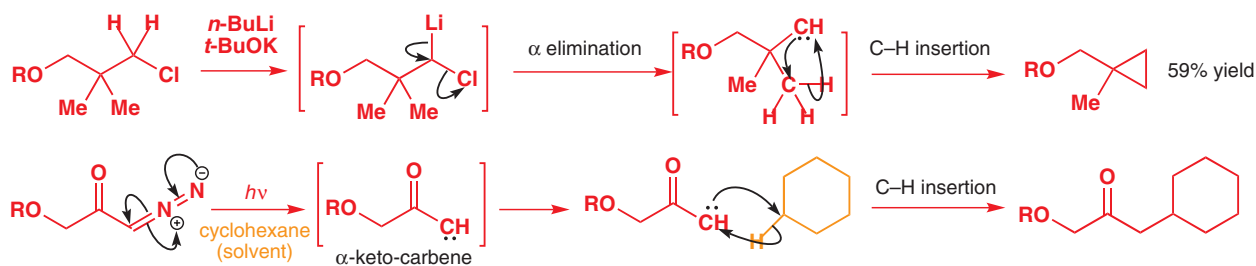
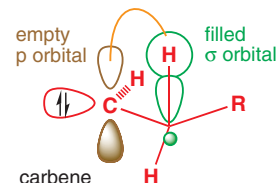

Because these insertion reactions create new bonds at completely unfunctionalized centres, they can be very useful in synthesis. This next carbene is created between two carbonyl groups from a diazocompound with rhodium catalysis and selectively inserts into a C–H bond five atoms away to form a substituted cyclopentanone.

🖱 Interactive mechanism for carbene insertion into C–H bonds

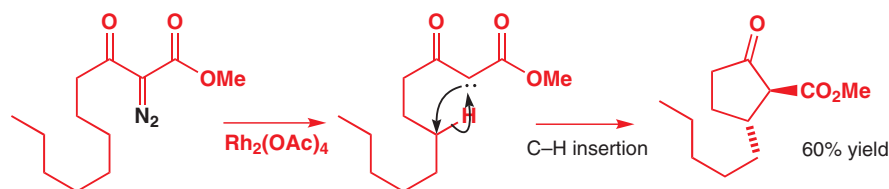

Pentalenolactone synthesis using carbenes

Pentalenolactone is the name given to an antibiotic extracted from *Streptomyces* fungi with an interesting tricyclic structure.

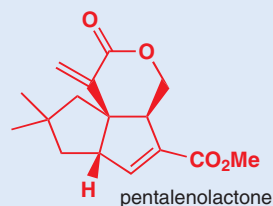

Two groups of chemists, within one year of each other, published syntheses of this compound using rhodium-promoted carbene insertions into C–H bonds. Cane's insertion reaction (route 1) proceeds stereospecifically with *retention* of

stereochemistry. This is excellent evidence for a concerted singlet carbene reaction. In Taber's synthesis, the carbene inserts into the six-membered tetrahydropyran ring selectively to give the less strained 5,5-*trans* ring junction.

route 1: Cane's synthesis of pentalenolactone

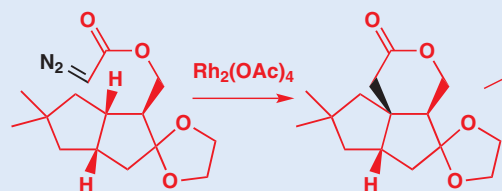

route 2: Taber's synthesis of pentalenolactone

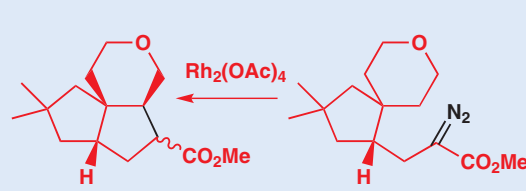

In these C–H insertion reactions, the similarity with cyclopropane formation by insertion into alkenes is clear, and the mechanisms mirror one another quite closely. As with the cyclopropanation reactions, the mechanism depends on whether the carbene is a singlet or triplet. Singlet carbenes can insert in a concerted manner, with the orbitals overlapping constructively provided the carbene approaches side-on.

orbital interactions during the insertion of a singlet carbene into a C–H bond

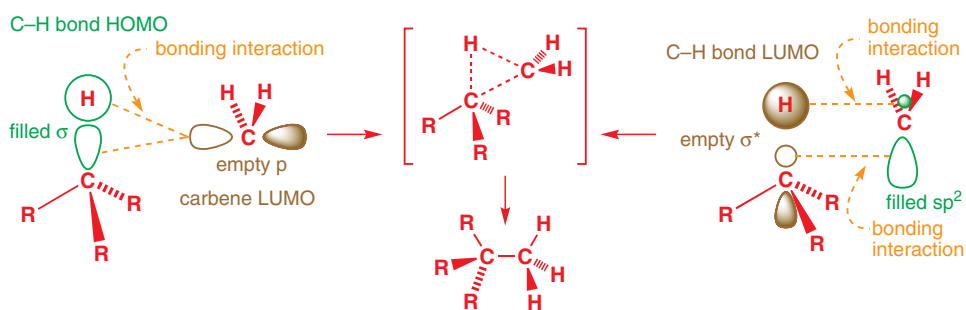

This mechanism implies that, if the C–H bond is at a stereogenic centre, the stereochemistry at that centre will be retained through the reaction, as in Cane's synthesis of pentalenolactone (see box above). A nice example of this result is this ingenious synthesis of α -cuparenone using a stereospecific carbene insertion.

■ In principle, triplet carbene insertions should follow a two-step radical pathway analogous to their insertion into alkenes. However, very few triplet carbene insertions into C–H bonds have been observed, and the stereochemical consequence of the two-step mechanism (which should result in mixtures of stereoisomers on insertion into a C–H bond at a stereogenic centre) has never been verified.

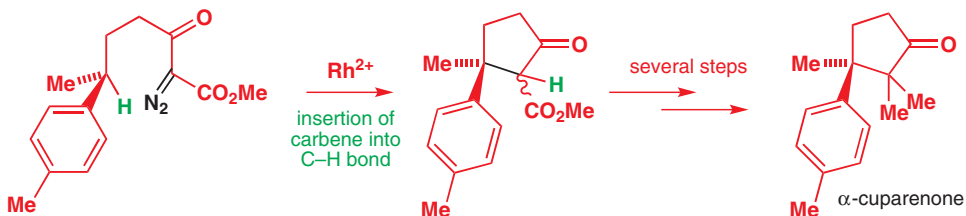

Rearrangement reactions

We talked just at the beginning of this section about migration reactions of hydrogen on to carbenes to give alkenes, and said that these reactions can be viewed as insertion reactions of

carbenes into adjacent C–H bonds. Carbenes with no β hydrogens often insert into other C–H bonds in the molecule. However, carbenes with no β -hydrogen atoms can also undergo rearrangement reactions with alkyl or aryl groups migrating.

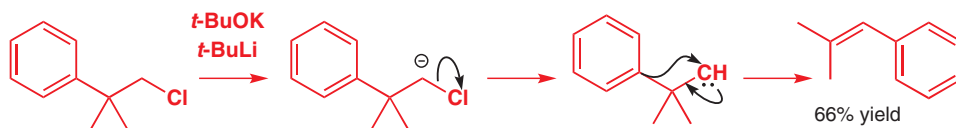

The most common example of this type of migration is that in which the carbene is adjacent to a carbonyl group. The initial product of what is known as the Wolff rearrangement is a ketene, which cannot be isolated but is hydrolysed to the acid in the work-up. Wolff rearrangement is a typical result of heating diazoketones, although as you saw above (p. 1019) these species also undergo intramolecular C–H insertion reactions.

the Wolff rearrangement



One important application of this reaction is the chain extension of acyl chlorides to their homologous esters, known as the Arndt–Eistert reaction. Notice that the starting material for the Wolff rearrangement is easily made from RCO_2H by reaction of the acyl chloride with diazomethane; the product is $\text{RCH}_2\text{CO}_2\text{H}$ —the carboxylic acid with one more carbon atom in the chain. A CH_2 group, marked in green, comes from diazomethane and is inserted into the C–C bond between R and the carbonyl group.

the Arndt–Eistert homologation

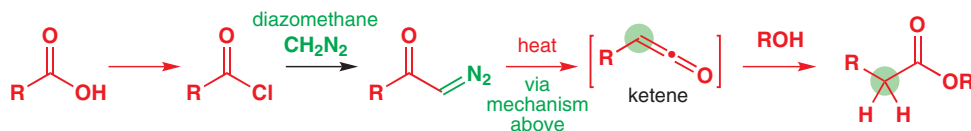

A synthesis of grandisol using the Arndt–Eistert chain extension

The boll weevil is a serious pest of cotton bushes, and it produces a sex pheromone known as grandisol. A common strategy for preventing insect damage in agriculture is to lure the weevils into a trap using synthetic versions of their own sex pheromones, and chemists soon showed that it was an easy matter to synthesize a related ester by a conjugate addition of an organocopper derivative (Chapter 22) and then alkylation of an ester enolate (Chapter 25). The enolate reacts with MeI on the face opposite the propenyl side chain—a good example of stereochemical control with cyclic compounds (Chapter 32).

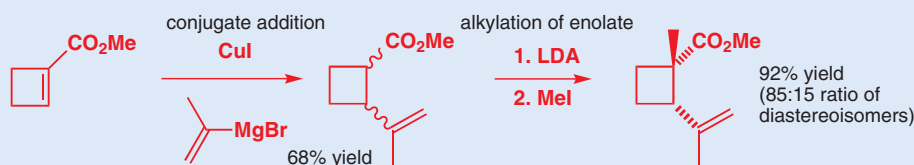
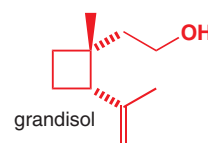

This ester is one carbon atom short of the full side chain of grandisol, so an Arndt–Eistert reaction was used to lengthen the chain by one atom. First, the ester was converted into the diazoketone with diazomethane and then the Wolff rearrangement was initiated by formation of the carbene with a silver(II) salt.

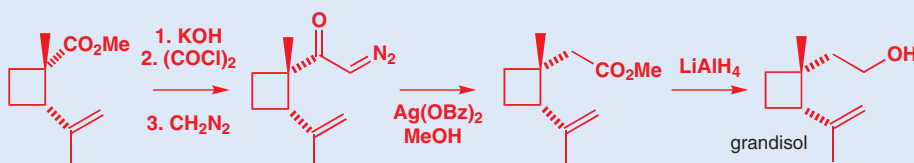

■ The migration of alkyl groups to carbene centres has much in common with the migration of alkyl groups to cationic centres discussed in Chapter 36—after all, both carbenes and carbocations are electron-deficient species with a carbon atom carrying only six electrons in its outer shell.

➔ You met ketenes in Chapter 34.

■ We discussed the structure and decomposition of diazoketones on p. 1001.

Nitrenes are the nitrogen analogues of carbenes

The Wolff rearrangement has some important cousins that we must now introduce to you—they deserve a mention because they bear a family likeness even though they do not, in fact, involve carbenes. They are a group of reactions that proceed through an intermediate *nitrene*—the nitrogen analogue of a carbene. The simplest to understand, because it is the direct nitrogen analogue of the Wolff rearrangement, is the Curtius rearrangement. It starts with an acyl azide, which can be made by nucleophilic substitution on an acyl chloride by sodium azide. The acyl azide is what you would get if you just replaced the $-\text{CH}=\text{N}_2$ of a diazoketone with $-\text{N}=\text{N}_2$. And, if you heat it, it is not surprising that it decomposes to release nitrogen (N_2), forming the nitrene. The nitrene N has only one bond and has two lone pairs, making six electrons in all, like a carbene.

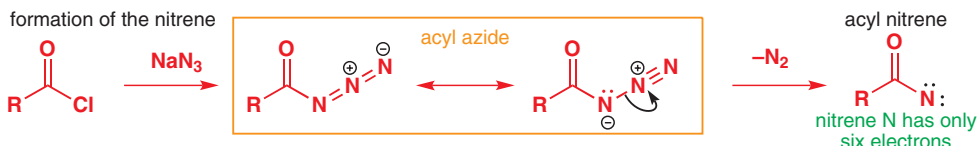

Nitrenes, like carbenes, are immensely reactive and electrophilic, and the same Wolff-style migration (insertion into an adjacent C–C bond) takes place in which the substituent R migrates from carbon to the electron-deficient nitrogen atom of the nitrene. The product is an *isocyanate*. Isocyanates are unstable to hydrolysis: attack by water on the carbonyl group gives a carbamic acid, which decomposes to an amine. Alternatively, reaction with an alcohol gives a carbamate. If the alcohol is BnOH , the product is a Cbz-protected amine.

➔ See pp. 556–557 for a discussion of the Cbz group.

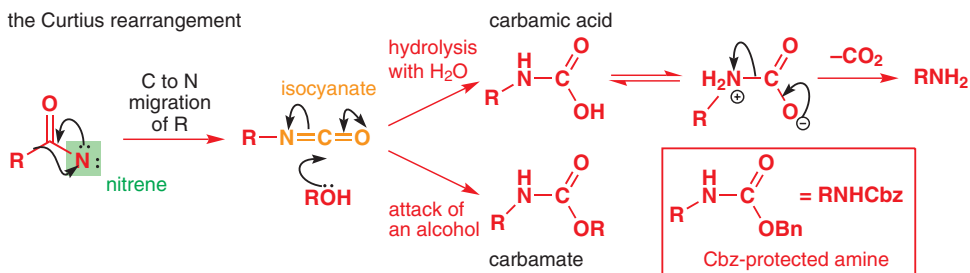

■ The Curtius rearrangement can be initiated directly from the carboxylic acid using diphenylphosphoryl azide (DPPA), $(\text{PhO})_2\text{PON}_3$.

Overall, then, the Curtius rearrangement converts an acid chloride (or an acid) to an amine with loss of a carbon atom—very useful. Also useful is the related Hofmann rearrangement, which turns an amide into an amine with loss of a carbon atom. This time we start with a primary amide and make a nitrene by treatment with base and bromine. Notice how close this nitrene-forming reaction is to the carbene-forming reactions we talked about on p. 1008. The nitrene rearranges just as in the Curtius reaction, giving an isocyanate that can be hydrolysed to the amine.

Yet another related reaction is known as the Lossen rearrangement, which starts with the tosylation of a hydroxamic acid (that is, the amide of a hydroxylamine). You should be able to work out what happens next by analogy with the Hofmann rearrangement.

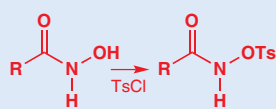

the Hofmann rearrangement

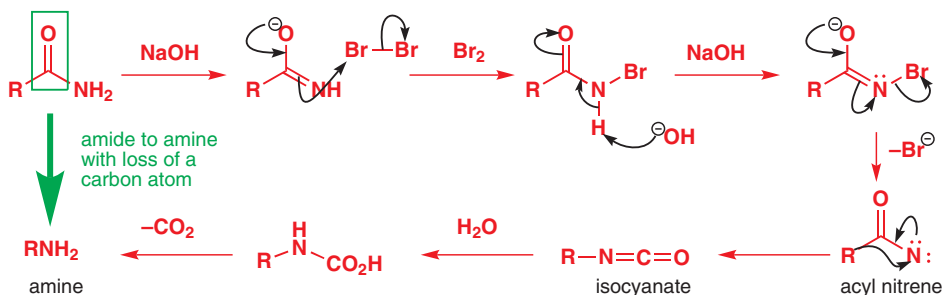

Attack of carbenes on lone pairs

Wolff rearrangements, involving shifts of alkyl groups, are effectively intramolecular insertions into C–C bonds. Carbenes will also insert into other bonds, especially O–H and N–H bonds, although the mechanism in these cases involves initial attack on the lone pair of the heteroatom.

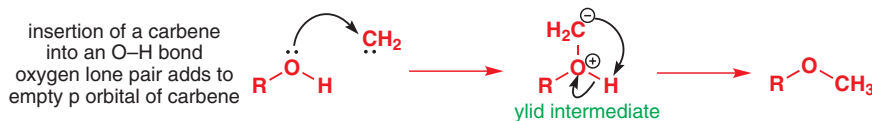

Carbene attack is followed by proton transfer to generate a neutral molecule from the first formed zwitterion (or 'ylid'). However, if the heteroatom does not carry a hydrogen, the ylid cannot rearrange in this way and this type of reaction is a very useful way of making reactive ylids that are inaccessible by other means.

As carbonyl-substituted carbenes (like carbonyl-substituted radicals) are electrophilic, their insertion into O–H and N–H bonds can be a useful way of making bonds in an umpolung (polarity-reversed, see Chapter 28) sense. Because of the difficulties in forming β -lactams (the four-membered rings found in the penicillin classes of antibiotics), the pharmaceutical company Merck decided to design a synthesis of the class of compounds known as carbapenems around a rhodium-catalysed carbene insertion into an N–H bond, building the five-membered ring on to the side of the four-membered ring.

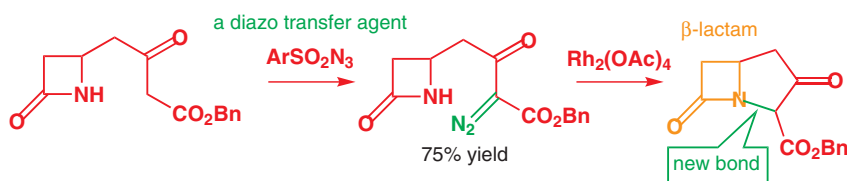

Alkene metathesis

In this example, and in many before it, the formation of the carbene is initiated by a metal—often copper, rhodium, or silver. The carbene intermediates in these reactions are formed as reactive complexes with those metals, but in other cases the complexes are extremely stable. For example, decomposition of phenyldiazomethane in the presence of a ruthenium(II) complex gives a carbene complex stable enough to be isolated and stored for months. This complex, and a family of related Ru complexes, are among the most important of carbene-derived reagents because of a remarkable reaction known as **alkene** (or **olefin**) **metathesis**.

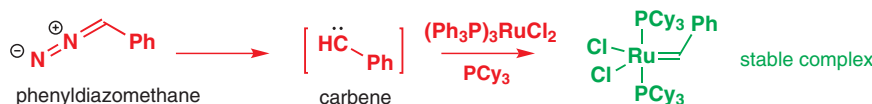

The reaction is most easily understood when a simple diene reacts with a very small amount (in this case 2 mol%) of the catalyst. A cyclization reaction occurs and the product is also an alkene. It contains no atoms from the catalyst: indeed, it has lost two carbon atoms, which are given off as ethylene.

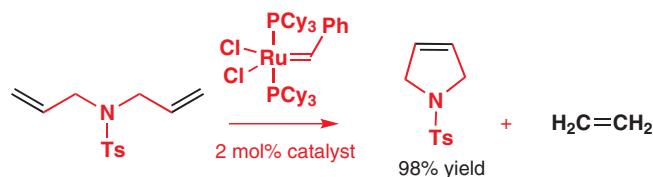

➔ Ylids (or ylides) are zwitterions in which the charges are on adjacent atoms—you met phosphorus and sulfur ylids in Chapter 27.

🔗 Interactive mechanism for carbene insertion into O–H bonds

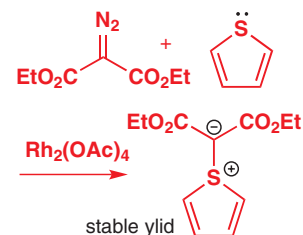

■ The Cy in these complexes represents the cyclohexyl group: PCy₃ is tricyclohexylphosphine, the saturated analogue of triphenylphosphine.

■ The same four carbon atoms in the starting material and in the product are highlighted in black.

What happens is a *metathesis*—an exchange of groups between the two arms of the molecule. But how? The mechanism is not difficult, but is unlike any other you have met before, except, perhaps, the Wittig reaction, which also forms alkenes. First, the carbene complex adds to one of the alkenes in what can be drawn as a [2 + 2] cycloaddition (Chapter 34) to give a four-membered ring with the metal atom in the ring (a ‘metallacyclobutane’).

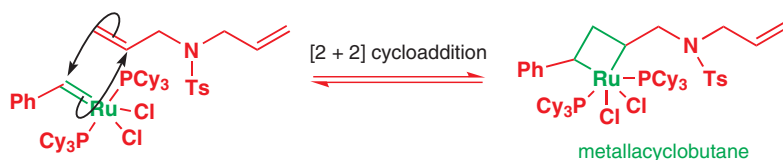

Now the same reaction happens in reverse, either unproductively to give back the starting materials or, by cleavage of the other two bonds, a new carbene complex and styrene.

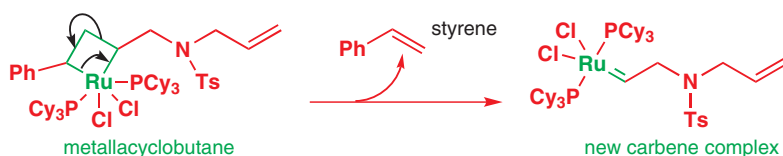

This new complex has the same reactivity as the catalyst we started with, so it will quickly find another alkene to undergo [2 + 2] cycloaddition with. There is now one in the same molecule, so a fast intramolecular reaction joins up the five-membered ring and produces a second metallacyclobutane. As before, there are two alternative ways for this metallacyclobutane to break down, and the productive one gives a third carbene complex and the cyclic product.

Interactive mechanism for alkene metathesis

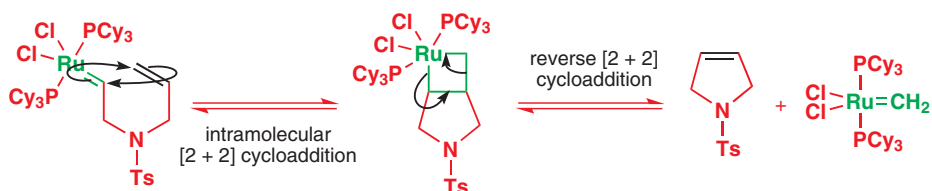

This new carbene complex is then ready to attack another molecule of starting material and the cycle is repeated, with the minor difference that ethylene (ethene) is now lost instead of styrene in the first step.

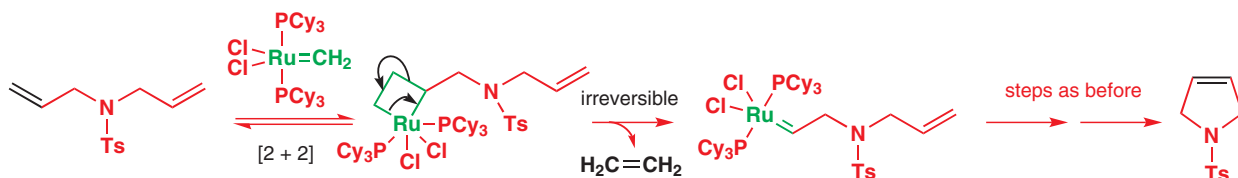

Not a lot can go wrong in this sequence, which is one reason why the yield is so high. Most of the steps are reversible, and the overall reaction is driven by the only irreversible step—the loss of ethylene as a gas. Even if the carbene complex adds the wrong way round to the alkene, nothing is lost because the only thing the resulting metallacycle can do is revert back to starting materials.

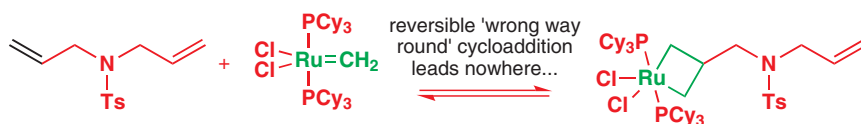

Metathesis catalysts

As you might imagine, the discovery of such a simple and efficient way of making new C=C bonds was a revolutionary point in organic chemistry, and earned a Nobel Prize in 2005 for the three chemists instrumental in its development—Yves Chauvin, Richard Schrock, and Robert Grubbs. The catalyst we have just been working with was developed by Grubbs and is often known by his name. The early years of the 21st century also saw a rapid improvement in the effectiveness of the catalysts used for metathesis. The most important development was the discovery of alternatives to the phosphine ligands, a change which increases the activity of the catalyst. The most important alternative ligands are themselves carbenes of the stable 'N-heterocyclic' type we introduced on p. 1006. Here is an important example, made by deprotonation of a heterocyclic cation:

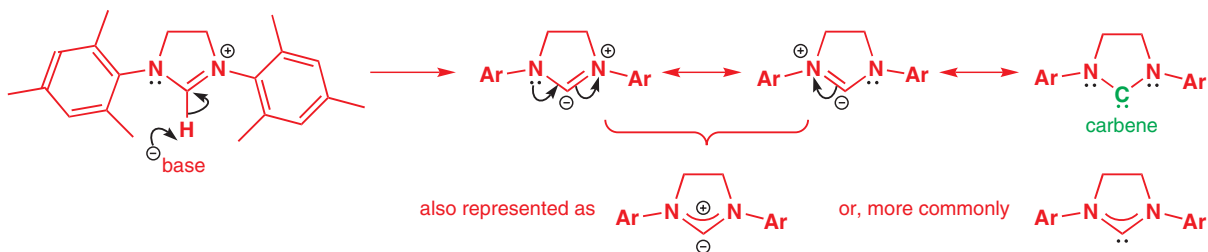

There is a lot of delocalization in this structure, and usually these ligands are represented with a curved line to show the donation of both nitrogen lone pairs to the carbene C atom. You might prefer to include the formal + and – charges, but these compounds really do stretch the classical valence bond representation almost to breaking point, and conventionally the charges are not shown as they cancel out.

The remaining lone pair on carbon (which is not delocalized) can coordinate to Ru, just like the phosphine lone pair, giving a catalyst known as 'Grubbs II' (the 'second generation' of the 'Grubbs I' we made use of in the metathesis described above). In another widely used catalyst (known as the 'Hoveyda–Grubbs catalyst') the second phosphine is also replaced by intramolecular coordination.

common catalysts for metathesis

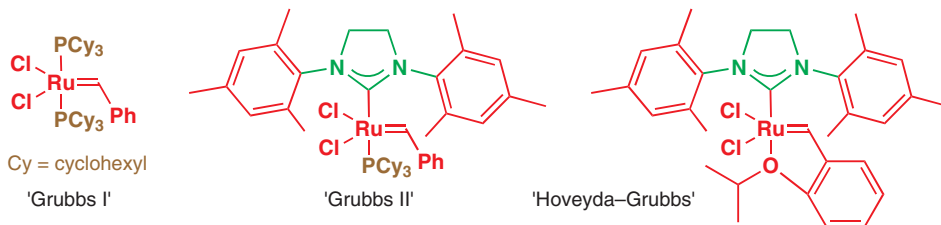

Cross metathesis

The first metathesis we introduced you to is known, for obvious reasons, as a *ring closing metathesis* reaction, and the formation of rings—even of difficult ring sizes (see Chapters 16 and 31) is one of the supreme applications of metathesis chemistry. However, intermolecular metathesis reactions can also work under certain circumstances, especially when the coupling partners have very different electronic or steric properties. The challenge is of course avoiding each alkene coupling with itself. When one of the two partners is hindered and the other isn't, the cross metathesis reaction works well: the four carbons of the two alkenes swap partners and a new alkene is produced (as its *E* isomer), along with ethylene as a by-product.

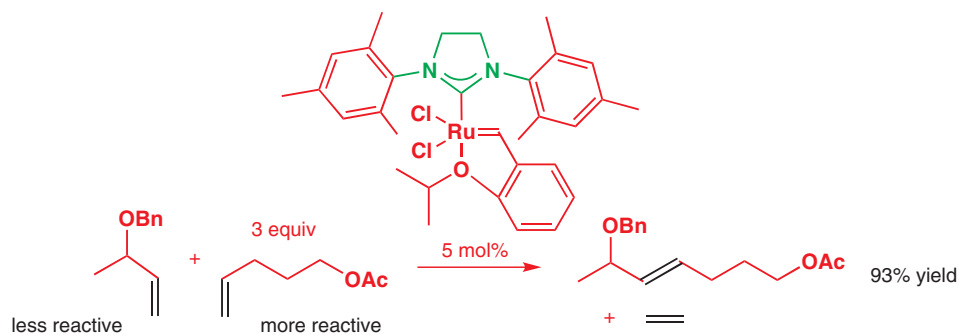

It's not difficult to understand why the less reactive and more hindered alkene doesn't react with itself, but why doesn't the more reactive alkene just dimerize? The point is... it does! But it doesn't matter because even the dimer is reactive as a metathesis substrate, and can still go on to form the product. All the metathesis steps proceed through the reversible [2 + 2] cycloaddition mechanisms you saw earlier.

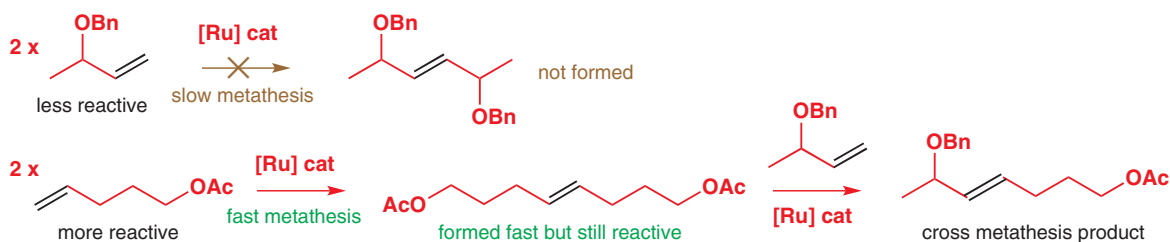

Ene-yne metathesis

Before we leave metathesis, and carbenes, we need to introduce one final reaction where metathesis leads to a remarkable transformation. Metathesis works on any C=C π bond, but the π bonds need not be an alkene—it can be an *alkyne*. The scheme below shows what happens: the two C=C double bonds change places. When an alkene reacts with an alkene, the result is two new alkenes, but when an alkene reacts with an alkyne, there is still a single bond remaining from the original alkyne, which ends up linking the two products together as a diene.

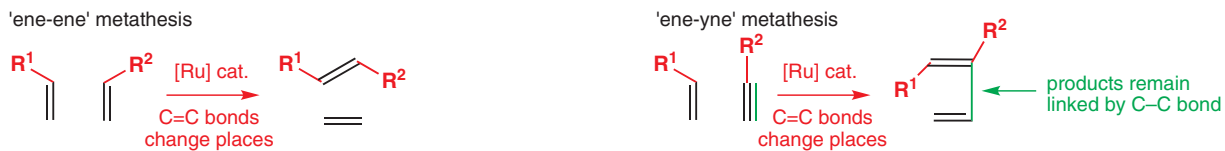

The mechanism follows exactly the same sequence of events as before. First the ruthenium carbene catalyst undergoes [2 + 2] cycloaddition with the alkyne. The intermediate is now a metallacyclobutene, and when the reverse [2 + 2] takes place the Ru carbene is still connected to the alkene product.

■ Notice that this time we have started with the $[\text{Ru}]=\text{CH}_2$ complex rather than $[\text{Ru}]=\text{CHPh}$ —in reality, as shown on p. 1024, the very first time the cycle goes round, the catalyst will transfer styrene, but from then on the mechanism we show will operate.

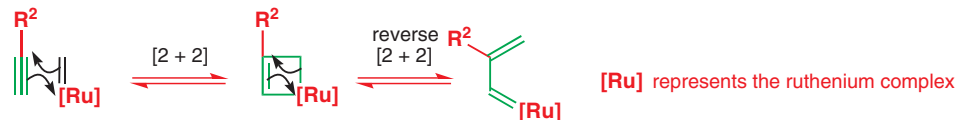

Now the new carbene can undergo [2 + 2] cycloaddition and reverse [2 + 2] cycloaddition again, this time with the alkene component, and out comes the diene, plus a Ru carbene ready to start the cycle again.

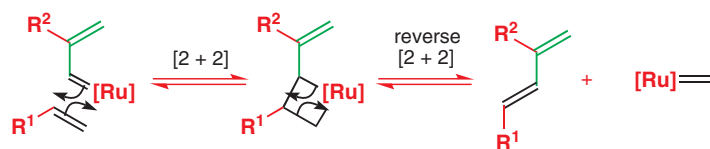

Ene-yne metathesis is therefore a valuable way of constructing dienes—of the type you might require for a Diels–Alder reaction, for example. Unlike more reactive organometallics such as organolithiums and Grignard reagents, the Ru carbenes are fully compatible with acidic NH and OH bonds and with electrophilic carbonyl groups. You will meet more of the mild chemistry possible with organometallics in Chapter 40.

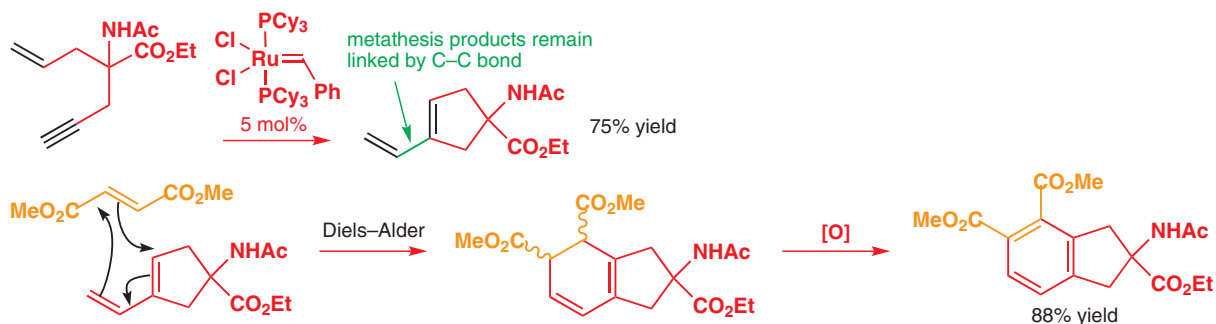

Summary

We have seen in this chapter how carbenes can be formed from many other reactive intermediates, such as carbocations, carbanions, and diazoalkanes, and how they can react to give yet further reactive intermediates such as ylids. Here is a summary of the main relationships between a carbene :CR_2 and these other compounds.

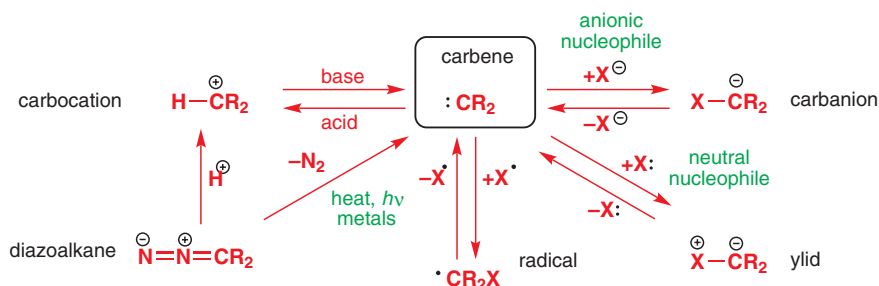

In the last few chapters we have concentrated a lot on what we call reactive intermediates, species like radicals, carbenes, or carbocations that are hard to observe but that definitely exist. Much of the evidence for their existence derives from the study of the mechanisms of reactions. We have discussed some aspects of this as we have met the species concerned, but in the next chapter we will look in detail at how mechanisms are elucidated and the methods used to determine more precisely the structure of reactive intermediates.

Further reading

Reactive Intermediates, C. J. Moody and G. H. Whitham, Oxford Primer, OUP, Oxford, 2001, has a section on carbenes. A more advanced book is G. Bertrand, *Carbene Chemistry*, Fontis Media and Marcel Dekker, 2002. Rules for cross-metathesis are in R. H. Grubbs, *J. Am. Chem. Soc.*, 2003, **125**, 11360.

Reviews on metathesis by the chief stars are R. H. Grubbs, *Tetrahedron*, 2004, **60**, 7117 and R. R. Schrock and A. H. Hoveyda, *Angew. Chem. Int. Ed.*, 2003, **42**, 4592.

Check your understanding



To check that you have mastered the concepts presented in this chapter, attempt the problems that are available in the book's Online Resource Centre at <http://www.oxfordtextbooks.co.uk/orc/clayden2e/>

Connections

➔ Building on

- Mainly builds on [ch12](#)
- Acidity and basicity [ch8](#)
- Carbonyl reactions [ch6](#), [ch10](#), & [ch11](#)
- Nucleophilic substitution at saturated carbon [ch15](#)
- Controlling stereochemistry [ch14](#), [ch32](#), & [ch33](#)
- Eliminations [ch17](#)
- Electrophilic and nucleophilic aromatic substitution [ch21](#) & [ch22](#)
- Cycloadditions [ch34](#)
- Rearrangements [ch35](#) & [ch36](#)
- Fragmentations [ch36](#)
- Saturated heterocycles and stereoelectronics [ch31](#)
- Chemistry of S, B, Si, and Sn [ch27](#)

Arriving at

- Classes and types of mechanisms
- Importance of proposing a mechanism
- Structure of the product is all-important
- Labelling and double labelling
- Systematic structure variation and electronic demand
- The Hammett relationship explained
- Deuterium isotope effect (kinetic and solvent)
- Specific acid and specific base catalysis
- General acid and general base catalysis
- Detecting and trapping intermediates
- Why stereochemistry matters

➔ Looking forward to

- Asymmetric synthesis [ch41](#)
- The chemistry of life [ch42](#)

There are mechanisms and there are mechanisms

There are two types of answer to the question ‘What is the mechanism of this reaction?’. If you were asked to draw the mechanism of an ester hydrolysis in basic solution you should have no trouble in giving a good answer of the first type. It wouldn’t matter if you had never seen this particular ester before or even if you knew that it had never actually been made, because you would recognize that the reaction belonged to a class of well-known reactions (carbonyl substitution reactions, Chapter 10) and you would assume that the mechanism was the same as that for other ester hydrolyses. And you would be right—nucleophilic attack on the carbonyl group to form a tetrahedral intermediate is followed by loss of the alkoxide leaving group and formation of the anion of the carboxylic acid.

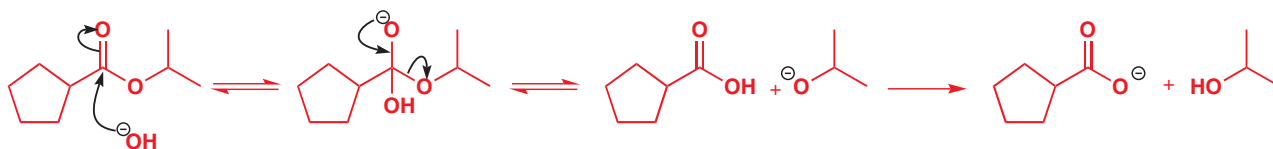

Yet someone at some time had to determine this mechanism in full detail. That work was done in the 1940s to 1960s and it was done so well that nobody seriously challenges it.

➡ This mechanism is described on p. 259.

You might also recall from Chapter 12 that, if we change the carbonyl compound to an acid chloride, the mechanism may change to an S_N1 reaction with an acylium ion intermediate because the leaving group is now much better: Cl^- is more stable (less basic) than RO^- . It would not be worth using hydroxide for this reaction: as the first step is the slow step, water will do just as well. Again someone had to determine this mechanism, had to show which was the slow step, and had to show that leaving group ability depended on the pK_a of its conjugate base.

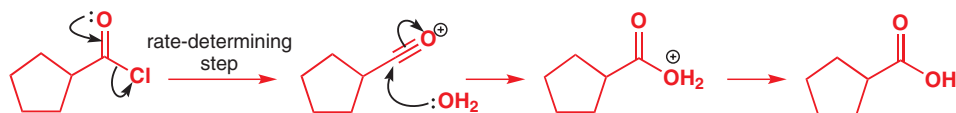

➡ Third-order kinetics, and this amide hydrolysis mechanism, were discussed on p. 260.

If the reaction were the hydrolysis of an amide, you might remember from Chapter 12 that third-order kinetics are often observed for the expulsion of such bad leaving groups and that this extra catalysis makes it worthwhile using concentrated base. Again, someone had to find out that: (1) the slow step is now the decomposition of the tetrahedral intermediate, (2) there are third-order kinetics involving two molecules of hydroxide, and (3) the first molecule acts as a nucleophile and the second as a base.

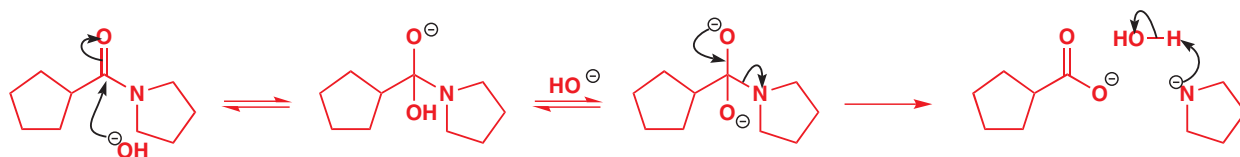

These three mechanisms are all versions of the same reaction. For you, writing these mechanisms chiefly means recognizing the type of reaction (nucleophilic substitution at the carbonyl group) and evaluating how good the leaving group is. For the original chemists, determining these reaction mechanisms meant: (1) determining exactly what the product is (that may sound silly, but it is a serious point), (2) discovering how many steps there are and the structures of the intermediates, (3) finding out which is the slow (rate-determining) step, and (4) finding any catalysis. This chapter describes the methods used in this kind of work—the detailed, second type of answer to ‘What is the mechanism of this reaction?’.

Now, suppose you were asked what the mechanisms of the next two reactions might be. This is a rather different sort of problem as you may well not recognize any of these reagents and you probably cannot fit any of the reactions into one of the classes you have seen so far. You may not even see at once which of the three main classes of mechanism you should use: ionic, pericyclic, or radical.

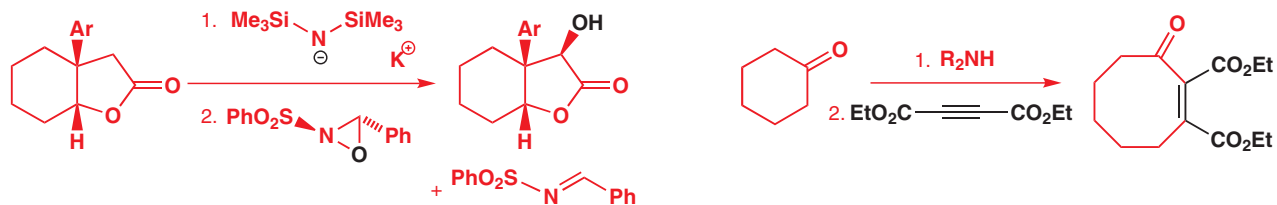

You may do your best to write a mechanism based on your understanding of organic chemistry, moving the electrons from nucleophiles to electrophiles, choosing sensible intermediates, and arriving at the right products. You would not claim any authority for the result, but you would hope, as an organic chemist, to propose one or more reasonable possibilities.

This process of proposing reasonable mechanisms is actually an essential preliminary to answering the question in the second way—finding the real, experimentally verified, mechanism for the reaction. We will now look at some of the techniques used to find such answers with an old curiosity of a reaction, the Cannizzaro reaction, as an example.

Determining reaction mechanisms: the Cannizzaro reaction

So how do we know the mechanism of a reaction? The simple answer is that we don't for certain. Organic chemists have to face situations where the structure of a compound is initially thought to be one thing but later corrected to be something different. The same is true of mechanisms. It is the nature of science that all we can do is try to account for observations by proposing a hypothesis. We then test the hypothesis by experiment and, when the experiment does not fit the hypothesis, we must start again with a new hypothesis. This is exactly the case with mechanisms. When a new reaction is discovered, one or more mechanisms are proposed; evidence is then sought for and against these mechanisms until one emerges as the best choice. That one then remains the accepted mechanism for the reaction until fresh evidence comes along that does not fit the mechanism.

We are going to look at one reaction, the Cannizzaro reaction, and use this to introduce the different techniques used in elucidating mechanisms so that you will be able to appreciate the different information each experiment brings to light and how all the pieces fit together to leave us with a probable mechanism. Under strongly basic conditions, an aldehyde with no α hydrogens undergoes disproportionation to give half alcohol and half carboxylate. Disproportionation means one half of the sample is oxidized by the other half, which is itself reduced. In this case, half the aldehyde reduces the other half to the primary alcohol and in the process is oxidized to the carboxylic acid. Before the discovery of LiAlH_4 in 1946, this was one of the few reliable ways to reduce aldehydes and so was of some use in synthesis.

Here is a simple mechanistic scheme of what happens—the sort of thing you might reasonably propose if you had not seen the reaction before.

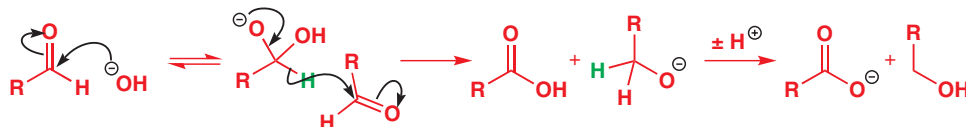

It's not the only possible mechanism by any means—and you may spot that it is slightly different from the one in Chapter 26, where we showed a dianion as an intermediate. We'll now work through some of the alternative mechanisms that have been proposed for the Cannizzaro reaction, along with the evidence for or against them. Most of these alternatives have been eliminated, leaving just the ones you have already met. Finally, we will see that even these mechanisms do not explain everything absolutely.

Proposed mechanism A: a radical mechanism

Early on it was thought that the hydrogen transfer might be taking place via a radical chain reaction. If this were the case, then the reaction should go faster if radical initiators are added and it should slow down when radical inhibitors are added. When this was tried, there was no change in the rate, so this proposed mechanism was ruled out.

Kinetic evidence for an ionic mechanism

The first piece of evidence that must be accounted for is the rate law. For the reaction of benzaldehyde with hydroxide, the reaction is first order with respect to hydroxide ions and second order with respect to benzaldehyde (third order overall).

$$\text{rate} = k_4[\text{PhCHO}]^2[\text{HO}^-]$$

For some aldehydes, such as formaldehyde and furfural, the order with respect to the concentration of hydroxide varies between one and two depending on the exact conditions. In high concentrations of base it is fourth order.

$$\text{rate} = k_4[\text{RCHO}]^2[\text{HO}^-]^2$$

➔ The Cannizzaro reaction first appeared in Chapter 26.

➔ For some examples of radical initiators and inhibitors, see Chapter 37. Radical inhibitors are usually stable radicals, such as those on p. 975.

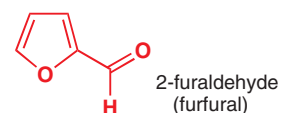

At lower concentrations of base the rate law is a mixture of both third- and fourth-order terms.

$$\text{rate} = k_3[\text{RCHO}]^2[\text{HO}^-] + k_4[\text{RCHO}]^2[\text{HO}^-]^2$$

➔ See p. 261 for an explanation of this important point.

Just because the overall order of reaction is third or fourth order, it does not mean that all the species must simultaneously collide in the rate-determining step. You saw in Chapter 12 that the rate law actually reveals all the species that are involved *up to and including* the rate-determining step.

Isotopic labelling

When the reaction is carried out in D_2O instead of in H_2O it is found that there are no C–D bonds in the products. This tells us that the hydrogen must come from the aldehyde and not from the solvent.



Proposed mechanism B: formation of an intermediate dimeric adduct

A possible mechanism that fits all the experimental evidence so far involves nucleophilic attack of the usual tetrahedral intermediate on another aldehyde to give an intermediate adduct. This adduct could then form the products directly by hydride transfer. You may not like the look of this last step, but the mechanism was proposed and evidence is needed to disprove it.

proposed mechanism B

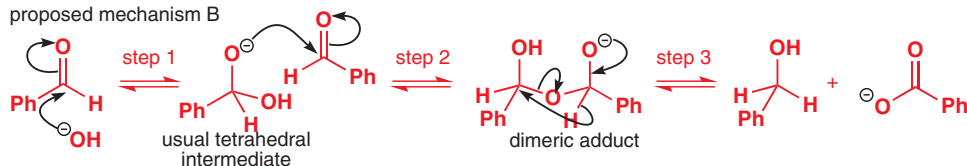

Which step would be rate determining for this mechanism? It could not be step 1 since, if this were the case, the rate law would be first order with respect to the aldehyde rather than the observed second-order relationship. Also, if the reaction is carried out in water labelled with oxygen-18, the oxygen in the benzaldehyde exchanges with the ^{18}O from the solvent much faster than the Cannizzaro reaction takes place. This can only be because of a *rapid* equilibrium in step 1 and so step 1 cannot be rate determining.

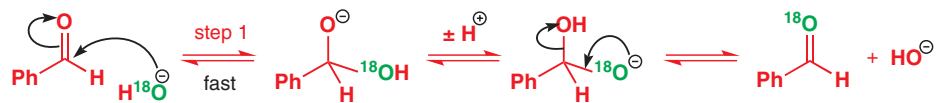

So, for mechanism B, either step 2 or step 3 could be rate determining—either case would fit the observed rate law. Step 2 is similar to step 1: in both cases an oxyanion nucleophile attacks the aldehyde. Since the equilibrium in step 1 is very rapid, it is reasonable to suggest that the equilibrium in step 2 should also be rapid and thus that the hydride transfer in step 3 must be rate determining. So mechanism B can fit the rate equation.

How can mechanism B be ruled out? One way is to change the attacking nucleophile. The Cannizzaro reaction works equally well if methoxide is used in a mixture of methanol and water. If mechanism B were correct, the reaction with methoxide would be as follows.

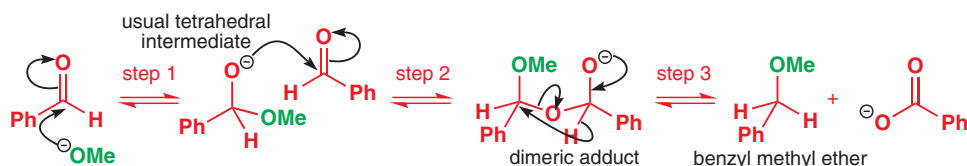

One of the products would be different by this mechanism: benzyl methyl ether would be formed instead of benzyl alcohol. None is observed experimentally. Moreover, under the conditions of the experiment, benzyl methyl ether does not react to form benzyl alcohol, so it cannot be the case that the ether is formed but then reacts to form the products. Mechanism B can therefore be ruled out.

➔ We shall discuss this kind of technique as well as other evidence used to evaluate an intermediate towards the end of this chapter.

Proposed mechanism C: formation of an ester intermediate

This mechanism is like mechanism B but the hydride transfer in the adduct formed in step 2 displaces OH^- to form an ester (benzyl benzoate) that is then hydrolysed to the products. This was at one time held to be the correct mechanism for the Cannizzaro reaction. One piece of evidence for this, and at first glance a very good one, is that by cooling the reaction mixture and avoiding excess alkali, some benzyl benzoate could be isolated during the reaction. An important point is that this does not mean that the ester must be an *intermediate* in the reaction—it might be formed at the end of the reaction, for example. However, it does mean that any mechanism we propose must be able to account for its formation. For now though we want to try to establish whether the ester is an intermediate rather than a by-product in the Cannizzaro reaction.

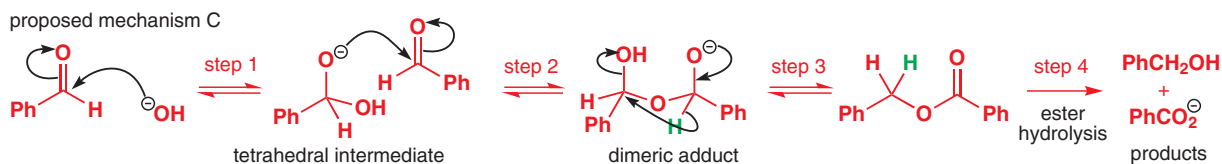

An early objection to mechanism C was that the ester would not be hydrolysed fast enough. When someone actually tried it under the conditions of the experiment, they found that benzyl benzoate is very rapidly hydrolysed (the moral here is 'don't just think about it, try it!'). However, just because the ester *could be* hydrolysed, it still did not show that it actually was an intermediate in the reaction. How this was eventually shown was rather clever. The argument goes like this. We can measure the rate constant for step 4 by seeing how quickly pure benzyl benzoate is hydrolysed to benzyl alcohol and benzoate under the same conditions as those of the Cannizzaro reaction. We also know how quickly these products are formed during the Cannizzaro reaction itself. Since, if this mechanism is correct, the only way the products are formed is from this intermediate, it is possible to work out how much of the intermediate ester must be present at any time to give the observed rate of formation of the products. If we can measure the amount of ester that is actually present and it is significantly less than that which we predict, then this cannot be the correct mechanism. It turned out that there was never enough ester present to account for the formation of the products in the Cannizzaro reaction and mechanism C could be ruled out.

The correct mechanism for the Cannizzaro reaction

The only mechanism that has not been ruled out and that appears to fit all the evidence is the one we have already given (p. 1031). The fact that the rate law for this mechanism is overall third and sometimes fourth order depending on the aldehyde and the conditions can be explained by the involvement of a second hydroxide ion deprotonating the tetrahedral intermediate to give a dianion. When methoxide is used in a methanol/water mix, some methyl ester is formed. This does not stay around for long—under the conditions of the experiment it is quickly hydrolysed to the carboxylate.

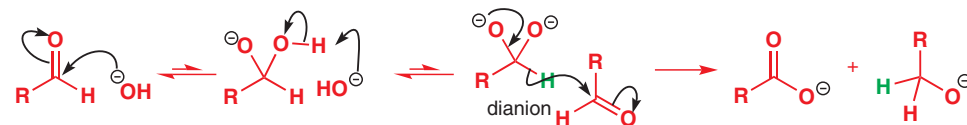

Even this mechanism does not quite fit all the evidence

We said earlier that we can never prove a mechanism—only disprove it. Unfortunately, just as the ‘correct’ mechanism seems to be found, there are some observations that make us doubt this mechanism. In Chapter 37 you saw how a technique called **electron spin resonance (ESR)** (or electron paramagnetic resonance, EPR) detects radicals and gives some information about their structure. When the Cannizzaro reaction was carried out with benzaldehyde and a number of substituted benzaldehydes in an ESR spectrometer, a radical was detected. For each aldehyde used, the ESR spectrum proved to be identical to that formed when the aldehyde was reduced using sodium metal. The radical formed was the radical anion of the aldehyde.

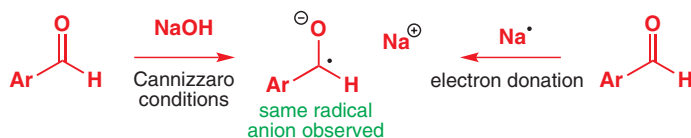

Our mechanism does not explain this result, but small amounts of radicals are formed in many reactions in which the products are actually formed by simple ionic processes. Detection of a species in a reaction mixture does not prove that it is an intermediate. Few chemists think that radicals are involved in the Cannizzaro reaction. Most think the mechanism we have given is correct.

Variation in the structure of the aldehyde

Before leaving the Cannizzaro reaction, look at these rates of reactions for aromatic aldehydes with different substituents in the *para* position. These aldehydes may be divided into two classes: those that react faster than unsubstituted benzaldehyde and those that react more slowly. Those that go slower all have something in common—they all have substituents on the ring that donate electrons.

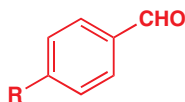

Rate of Cannizzaro reaction with aromatic aldehydes

R =	Rate relative to benzaldehyde at 25°C	Rate relative to benzaldehyde at 100°C
H	1	1
Me	0.2	0.2
MeO	0.05	0.1
Me ₂ N	very slow	0.0004
NO ₂	210	2200

We have already seen how substituents on a benzene ring affect the rate of electrophilic substitution (Chapter 21). Electron-donating groups such as MeO and Me₂N dramatically speed up the rate at which an aromatic ring is attacked by an electrophile, whereas electron-withdrawing groups, particularly nitro groups, slow the reaction down. The Cannizzaro reaction is not taking place on the benzene ring itself, but substituents on the ring still make their presence known. The fact that the Cannizzaro reaction goes much *slower* with electron-donating groups and faster with electron-withdrawing groups tells us that, for this reaction, rather than a positive charge developing, as in the case of electrophilic substitution on an aromatic ring, there must be negative charge accumulating somewhere near the ring. The accumulation of more negative charge is disfavoured by the presence of a group that is already offloading electron density into the ring. In agreement with this, our mechanism has mono- and dianion intermediates, which are stabilized by electron-withdrawing groups and destabilized by electron-donating groups.

➡ Later in the chapter you will see a more quantitative treatment of this variation of structure.

The rest of the chapter is devoted to discussions of methods similar to those we have briefly surveyed for the Cannizzaro reaction, with examples of the use of each method. You can assume that the mechanisms we have discussed in this book have been verified (not, of course, proved) by these sorts of methods.

Be sure of the structure of the product

This seems a rather obvious point. However, there is a lot to be learned from the detailed structure of the product: its connectivity (which atom goes where) as well as its stereochemistry. You will see that it may be necessary to alter the structure of the starting material in subtle ways to make sure that we know exactly what happens to all its atoms by the time it reaches the product.

Suppose you are studying the addition of HCl to this alkene. You find that you get a good yield of a single adduct and you might be a bit surprised that you do not get a mixture of the two obvious adducts. You may wonder if there is some participation of the ether oxygen or whether perhaps the ketone enolizes during the reaction and controls the outcome.

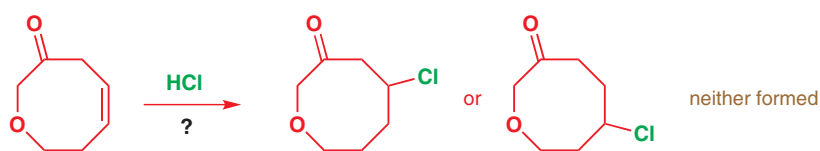

^1H NMR spectrum of product
200 MHz

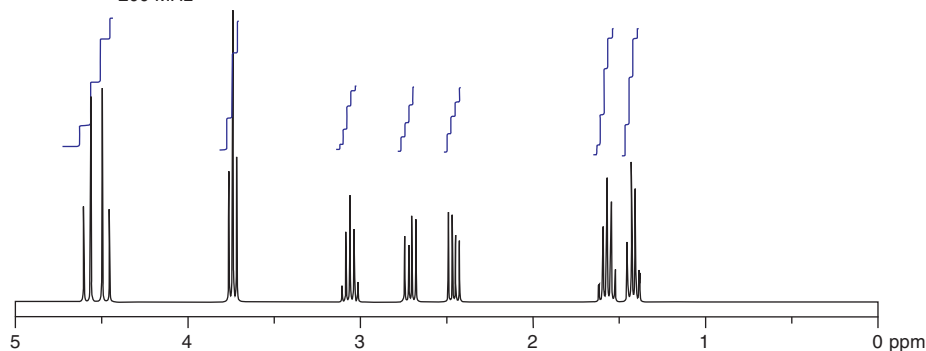

If you are cautious you might check on the structure of the product before you start a mechanistic investigation. The NMR spectrum (above) tells you at once that the product is neither of these suggestions. It contains a $(\text{CH}_2)_3\text{Cl}$ unit and can no longer have an eight-membered ring. A ring contraction has given a five-membered ring and a mechanistic investigation is hardly needed. Simply knowing what the product is allows us to propose a mechanism. A rearrangement has occurred and we could use the method suggested in Chapter 36: number the atoms in the starting material and find them in the product. This is quite easy as only one numbering system makes any sense.

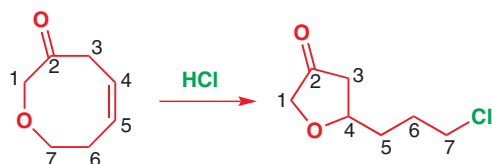
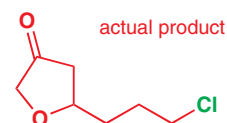

This numbering suggests that the carbon skeleton is unaffected by the reaction, that protonation has occurred at C5, that the ether oxygen has acted as an internal nucleophile across the ring at C4, and that the chloride ion has attacked C7. The mechanism is straightforward.

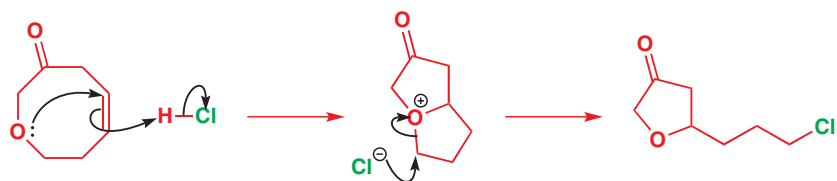

It may be disappointing to find that every step in this mechanism is well known and that the reaction is exactly what we ought to have expected with an eight-membered ring as these rings are famous for their transannular (across-ring) reactions to form 5/5 fused systems. However, it is good that a prolonged investigation is not necessary.

- Find out for sure what the structure of the product is before you start a mechanistic investigation.

A more subtle distinction occurred in a study of the bromination of alkynes. Bromination of benzyl alkynes in acetic acid gave the products of addition of one molecule of bromine—the 1,2-dibromoalkenes. The reaction was successful with a variety of *para* substituents and there seems at first to be no special interest in the structure of the products.

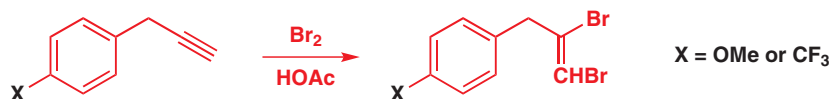

Closer investigation revealed an extraordinary difference between them, not at all obvious from their NMR spectra: the compound from X=OMe was the *Z*-dibromoalkene from *cis* addition of bromine while the product from X=CF₃ was the *E* alkene from *trans* addition. What mechanism could explain this difference?

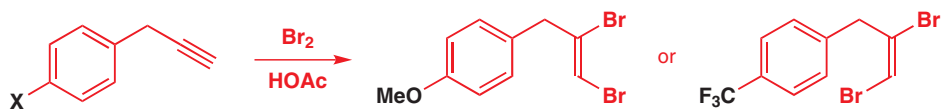

The *anti* addition is more easily explained: it is the result of formation of a bromonium ion, similar, in fact, to the normal mechanism for the bromination of alkenes. Bromine adds from one side of the alkene and the bromide ion must necessarily form the *E*-dibromo product regardless of which atom it attacks.

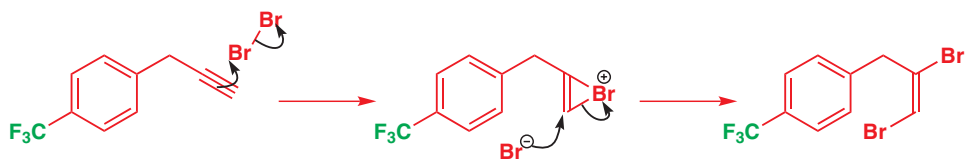

So why does the *p*-methoxy-substituted compound behave differently? It cannot react by the same mechanism and a reasonable explanation is that the much more electron-donating ring participates in the reaction to give a carbocyclic three-membered ring intermediate that is attacked in an *anti* fashion to give the *Z* alkene. Both intermediates are three-membered ring cations and both are attacked with inversion but the *p*-MeO compound undergoes double inversion by participation of the ring.

➡ A similar aryl participation in saturated compounds, giving a 'phenonium ion' intermediate, appears in Chapter 36, p. 936.

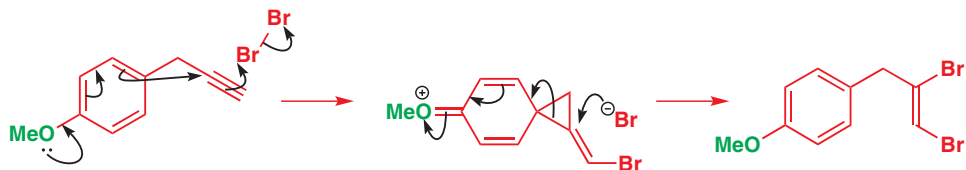

Labelling experiments reveal the fate of individual atoms

It often happens that the atoms in starting material and product cannot be correlated without at least one of them being labelled. The fact that many elements exist as different isotopes provides us with a perfect way of doing this: a neutron more or less in the nucleus affects the physics (and hence the spectroscopic features) of an atom, but not its chemistry.

The isomerization of *Z*-1-phenylbutadiene to the *E* diene in acid looks like a simple reaction. Protonation of the *Z* alkene would give a stabilized secondary benzylic cation that should last long enough to rotate. Loss of the proton would then give the more stable *E* diene.

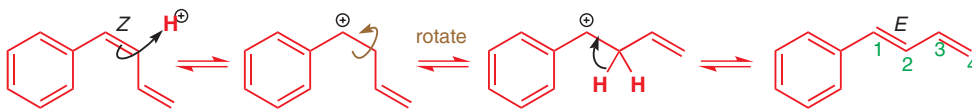

However, reaction with D^+ in D_2O reveals that this mechanism is incorrect. The product contains substantial amounts of deuterium at C4, not at C2 as predicted by the proposed mechanism. Protonation must occur at the end of the conjugated system to produce the more stable conjugated cation, which rotates about the same bond and loses H or D from C4 to give the product. More H than D will be lost, partly because there are two Hs and only one D, but also because of the kinetic isotope effect, of which more later.

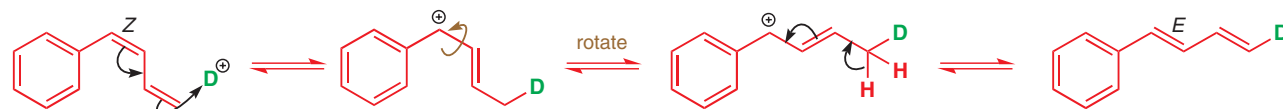

The easiest labels to use for this job are D for H, ^{13}C , and ^{18}O . None of these is radioactive; all can be found by mass spectrometry, while D and ^{13}C can be found by NMR. Older work on mechanisms used radioactive tracers such as T (tritium, 3H) for H and ^{14}C .

The first evidence for benzyne as the intermediate in the reaction of chlorobenzene with NH_2 came from radioactive labelling. If benzyne is an intermediate, the product should have 50% label at C1 and 50% at the two identical *ortho* carbons, as the scheme below shows.

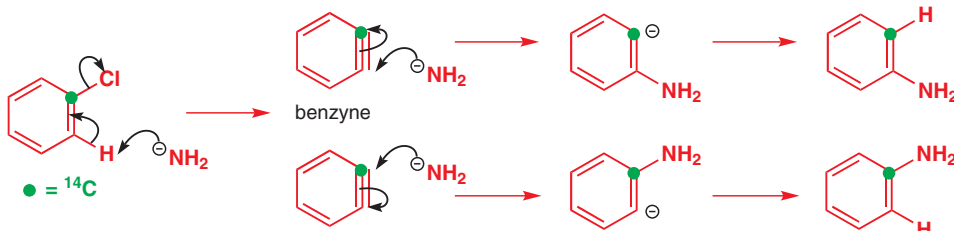

The labelled aniline was degraded by the reactions shown here, which you must agree was a lot of work for the chemists concerned. Each potentially labelled carbon atom had to be isolated from any other labelled atom and the radioactivity measured. We shall follow the fate of the two labelled atoms with black and green spots. Since the two *ortho* positions are identical, we must put a black spot on both of them.

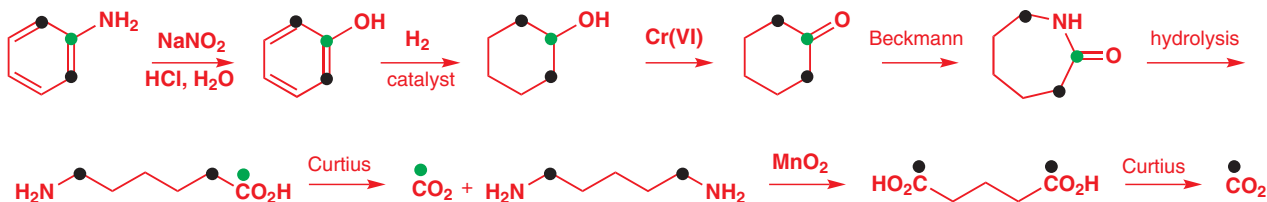

Most of these reactions are well known—the Beckmann rearrangement is described in Chapter 36 and the Curtius reaction in Chapter 38—but the oxidation of the diamine to the

■ In fact a feature known as the *kinetic isotope effect* means that isotopes of an element can have subtly different chemistry, as we will explain on p. 1050.

■ Radioactive isotopes are, of course, more dangerous to use but they can at least always be found. The real disadvantage is that, to discover exactly where they are in the product, the molecule must be degraded in a known fashion. Radioactive isotopes are rarely used now except in determining biological mechanisms, as you will see in Chapter 42. Tritium and ^{14}C are β emitters—they give off electrons—having half-lives of 12 and over 5000 years, respectively. Tritium is made on a large scale by neutron irradiation of 6Li in a nuclear reactor.

Interactive mechanism showing benzyne intermediate

Benzyne is discussed in Chapter 22 as an intermediate in nucleophilic aromatic substitution.

Other symmetrical intermediates originally identified by radioactive labelling include the cyclopropanone in the Favorskii rearrangement in Chapter 36, p. 950, and a spirocyclic intermediate in electrophilic substitution on an indole in Chapter 29, p. 746.

dicarboxylic acid is not a standard procedure and is not recommended. All the label came out in the CO_2 and almost exactly half of it was from the black and half from the green labelled carbons. This was the original evidence that convinced organic chemists in 1953 that benzyne was involved in the reaction. The evidence presented in Chapter 22 is much more modern.

The value of double labelling experiments

An altogether more modern approach to a labelling study was used in the surprising rearrangement of a hydroxy-acid in acidic solution. The structure of the product suggests a CO_2H migration as the most likely mechanism. This mechanism resembles closely the cationic rearrangements of Chapter 36.

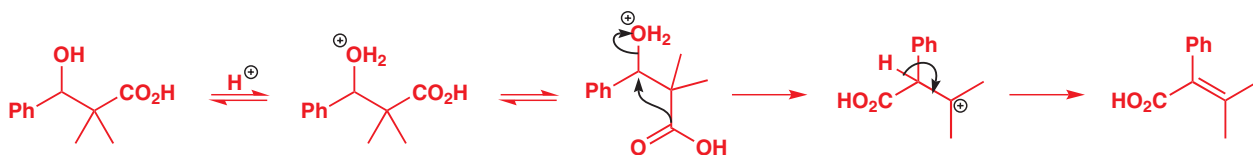

But there are other possibilities: received wisdom (Chapter 36) suggests that the best migrating group in cationic rearrangements is the one best able to bear a positive charge, by which logic the more familiar Ph and Me migrations ought to be preferred. A more elaborate mechanism can be written: it involves two methyl migrations and one phenyl migration and it also needs consideration.

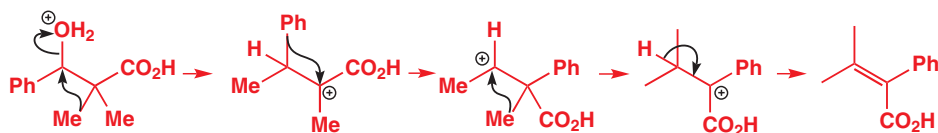

We don't normally see ^{13}C - ^{13}C coupling because in most molecules only 1.1% of the C atoms are ^{13}C , so there's little chance of two of them finding themselves adjacent to one another. But when both C atoms are always ^{13}C , the coupling becomes evident.

These mechanisms can be tested by finding out whether the CO_2H group remains attached to its original position or becomes attached to the other carbon in the skeleton of the molecule. This can be done by double labelling. If a compound is prepared with two ^{13}C labels, one on the CO_2H group itself and one on the benzylic carbon, the NMR spectrum of the product will show what has happened. In fact, the two ^{13}C labels end up next to each other with a coupling constant $^1J_{\text{CC}} = 71$ Hz. It is the CO_2H group that has migrated.

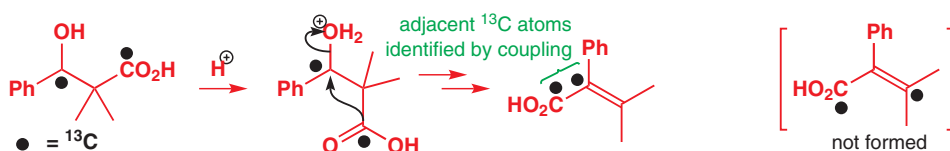

So why does the CO_2H group migrate? It does so not because it is a good migrating group, but because it cannot bear to be left behind. The rearranged cation from CO_2H migration is a stable tertiary alkyl cation. The cation from Me migration is a very unstable cation, with the positive charge next to the CO_2H group. Such cations are unknown as the carbonyl group is very electron withdrawing.

'Crossover' experiments

There is still one tiny doubt. Supposing the reaction is not intramolecular at all, but *intermolecular*. The CO_2H group might be lost from one molecule as protonated CO_2 and be picked up by another molecule of alkene. No migration would be involved at all.

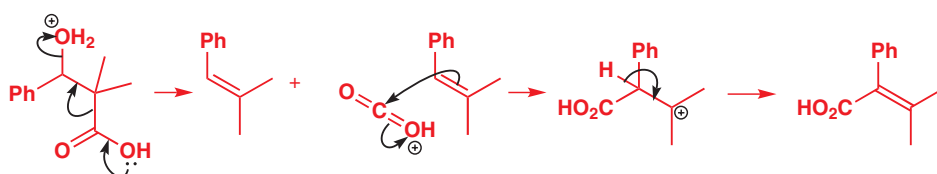

This mechanism can be checked by using a 50:50 mixture of doubly labelled and unlabelled starting material. The molecule of alkene that captures the roving protonated labelled CO_2 might happen to be labelled too but equally well it might be unlabelled. If this last mechanism is correct, we should get a mixture of unlabelled, singly labelled, and doubly labelled product in the ratio 1:2:1 as there are two types of singly labelled product. The two singly labelled compounds are called the crossover products and the experiment is called a crossover experiment as it discovers whether any parts of one molecule cross over to another.

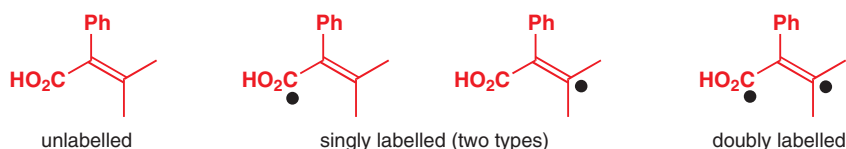

In fact, no singly labelled compounds were found: NMR analysis showed that the product consisted entirely of unlabelled or doubly labelled molecules. The CO_2H group remains attached to the same molecule (though not to the same atom) and the first mechanism is correct.

Crossover experiments demand some sort of double labelling, which does not have to be isotopic. An example where crossover products are observed is the light-initiated isomerization of allylic sulfides.

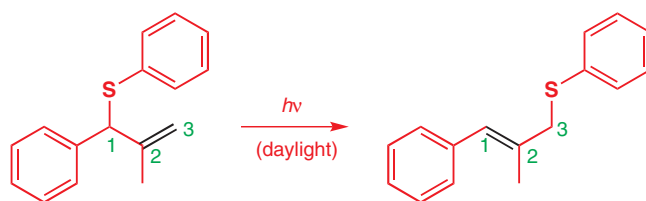

This is formally a [1,3] sigmatropic shift of sulfur (Chapter 35) but that is an unlikely mechanism (and you should be able to suggest why). A crossover experiment was carried out in which the two molecules had either two phenyl groups or two *para*-tolyl groups. The mixture was allowed to rearrange in daylight and the products were examined by mass spectroscopy. There was a roughly 1:2:1 mixture of products having two phenyl groups, one phenyl and one *para*-tolyl group, and two *para*-tolyl groups. The diagram shows the starting materials and the two crossover products only.

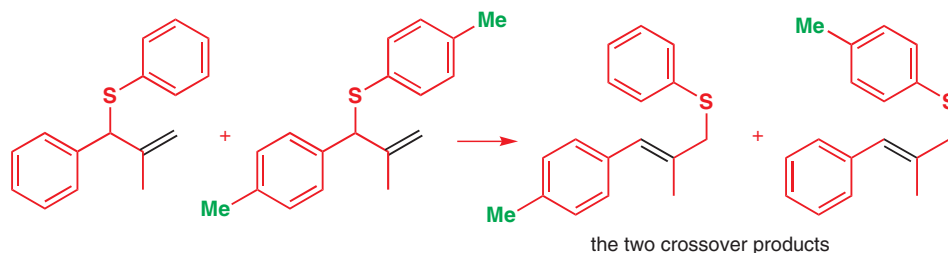

Clearly, the ArS group had become separated from the rest of the molecule and the most likely explanation was a radical chain reaction (Chapter 37) with the light producing a small amount of ArS^\bullet to initiate the chain. The *para*-methyl group acts as a label. The whole system is in equilibrium and the more highly substituted alkene is the product.

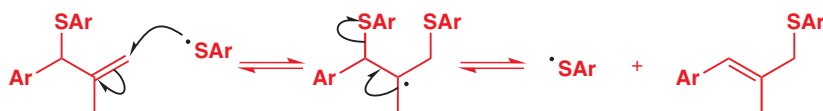

➔ There is an example of a crossover experiment proving that an $\text{S}_{\text{N}}2$ reaction is intermolecular in Chapter 31, p. 811 and one proving the mechanism of a rearrangement on pp. 959–960.

Systematic structural variation

In this last example, the hope is that the *para*-methyl group will have too weak an electronic or steric effect and in any case will be too far away to affect the outcome. It is intended to make nearly as slight a change in the structure as an isotopic label. Many structural investigations have exactly the opposite hope. Some systematic change is made in the structure of the molecule in the expectation of a predictable change in rate. A faster or slower reaction will lead to some definite conclusion about the charge distribution in the transition state.

Allylic compounds can react efficiently with nucleophiles by either the S_N1 or S_N2 mechanisms (Chapter 15). Here are two examples.

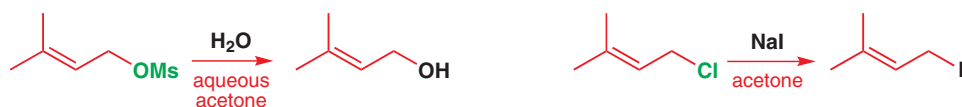

The carbon skeleton is the same in both reactions but the leaving groups and the nucleophiles are different. These reactions might both go by S_N1 or S_N2 or one might go by S_N1 and the other by S_N2 . One way to find out is to make a large change in the electronic nature of the carbon skeleton and see what happens to the rate of each reaction. In these experiments one of the methyl groups was changed for a CF_3 group—exchanging a weakly electron-donating group for a strongly electron-withdrawing group. If a cation is an intermediate, as in the S_N1 reaction, the fluorinated compound will react much more slowly. Here is the result in the first case.

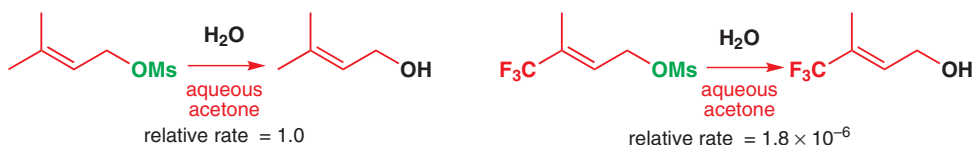

The fluorinated compound reacts half a million times more slowly so this looks very much like an S_N1 mechanism. The slow step in an S_N1 mechanism is the formation of a carbocation so any group that destabilizes the positive charge would have (and evidently does have) a large effect on the rate. Rate ratios of several powers of ten often are worth noticing and a rate ratio of nearly 10^6 is considerable. In the second case the rate difference is much less.



A rate ratio of 11 is not worth noticing. The point is not that the fluorinated compound reacts faster but that the two compounds react at about the same rate. This strongly suggests that no charge is generated in the transition state and an S_N1 mechanism is not happening. The S_N2 mechanism makes good sense with its concerted bond formation and bond breaking requiring no charge on the carbon skeleton.

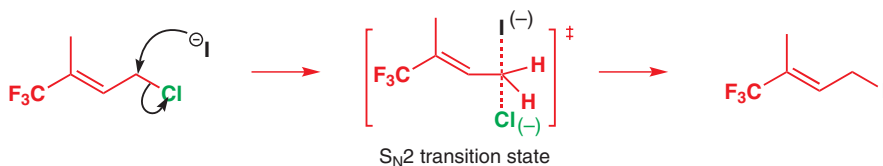

The CF_3 group works well here as a mechanistic probe because it is held well out of the way of the reaction site by a rigid π system but is connected electronically by that same allylic system. Steric effects should be minimized and electronic effects clearly seen. This approach is clearly limited by the small number of groups having properties like those of the CF_3 group and the small number of reactions having such favourable carbon skeletons. We will now present the most important serious correlation between structure and reactivity.

The Hammett relationship

What we would ideally like to do is find a way to quantify the effects that electron-donating or -withdrawing groups have on the transition state or intermediate during the course of a reaction. This will then give us an idea of what the transition state is really like. The first question is: can we define exactly how efficient a given group is at donating or withdrawing electrons? Hammett took the arbitrary decision to use the pK_a of an acid as a guide. For example, the rate of hydrolysis of esters might well correlate with the pK_a of the corresponding acid.

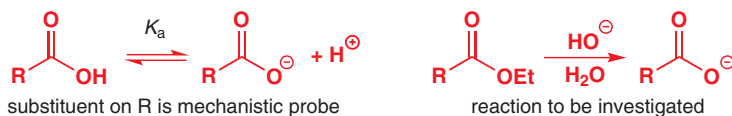

When Hammett plotted the rates of ethyl ester hydrolyses (as $\log k$ since pK_a has a log scale) against the pK_a s of the corresponding acids, the initial results were not very encouraging as there was a random scatter of points over the whole graph.

Hammett had used some aliphatic acids (substituted acetic acids) and some aromatic acids (substituted benzoic acids) and he noticed that many of the points towards the top of the graph belonged to the substituted acetic acids. Removing them (brown points) made the graph a lot better. He then noticed that the remaining aromatic compounds were in two classes: the *ortho*-substituted esters reacted more slowly than their *meta*- and *para*-isomers and came towards the bottom of the graph (orange points). Removing them made the graph quite good (remaining green points).

It was not a perfect correlation but Hammett had removed the examples where steric hindrance was important. Aliphatic compounds can adopt a variety of conformations (Chapter 16) and the substituent in some of them will interfere with the reaction. Similarly, in *ortho*-substituted aromatic compounds the nearby substituent might exert steric hindrance on the reaction. Only with *meta*- and *para*-substituted compounds was the substituent held out of the way, on a rigid framework, and in electronic communication with the reaction site through the flat but conjugated benzene ring.

Notice that the straight line is not perfect. This graph is an invention of the human mind. It is a correlation between things that are not directly related. If you determine a rate constant by plotting the right function of concentration against time and get an imperfect straight line, that is your fault because you haven't done your measurements carefully enough. If you make a Hammett plot and the points are not on a straight line (and they won't be) then that is *not* your fault. The points really don't fit on a perfectly straight line. As you will see soon, this doesn't actually matter.

Louis P. Hammett (1894–1987) invented 'physical organic chemistry' and at Columbia University in 1935 derived the Hammett σ/ρ relationship. The impact was enormous and in the 1960s chemists were still working out more such correlations.

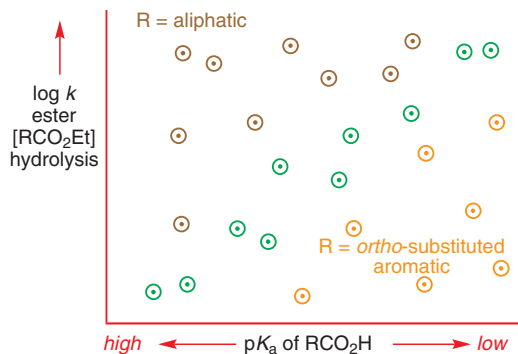
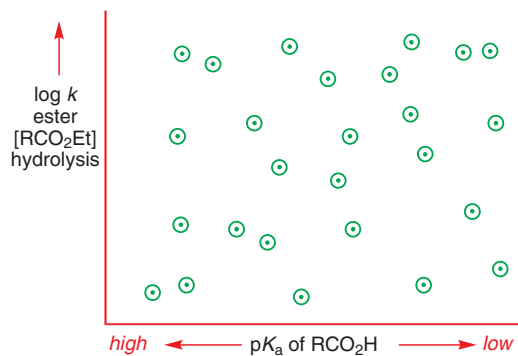

reaction to be investigated

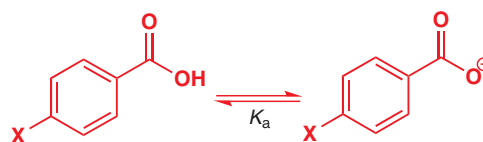
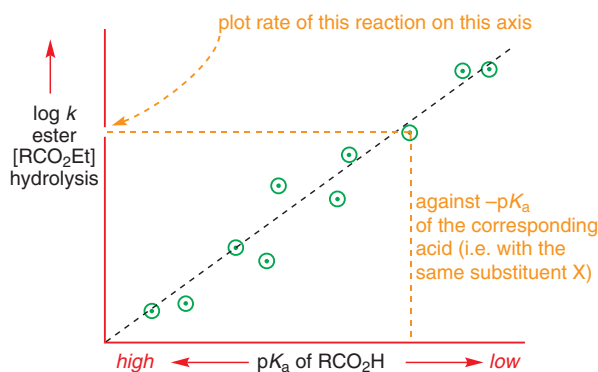
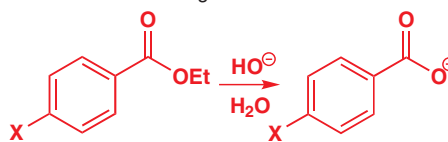

The Hammett substituent constant σ

■ You cannot push arrows from the negative charge of the carboxylate anion into the ring. Try it.

A quick glance at the pK_a s of some substituted benzoic acids in the table below will show how well they correlate electron donation with pK_a . The substituents at the top of the table are electron donating and the anions of the benzoic acids are correspondingly less stable so these are the weakest acids. At the bottom of the table we have the electron-withdrawing groups, which stabilize the anion and make the acid stronger. The whole range is not that great, only one pH unit or so, because the carboxylate anion is not conjugated with the ring.

Hammett decided not to use the pK_a s themselves for his correlation but defined a new parameter, which he called σ . This σ shows how electron donating or withdrawing a group is relative to H as a difference between the pK_a s of a benzoic acid derivative with the substituent and benzoic acid itself. If the acid required to determine σ for a new substituent was not available, σ could be determined by correlation with other reactions. Here are the equations and the table of σ values for the most important substituents. A different value of σ for any given substituent was needed for the *meta* and the *para* positions and these are called σ_m and σ_p , respectively.

$$\sigma_x = \log \left(\frac{K_a(\text{XC}_6\text{H}_4\text{COOH})}{K_a(\text{C}_6\text{H}_5\text{COOH})} \right) = pK_a(\text{C}_6\text{H}_5\text{COOH}) - pK_a(\text{XC}_6\text{H}_4\text{COOH})$$

Substituent X	pK_a of $p\text{-XC}_6\text{H}_4\text{COOH}$	pK_a of $m\text{-XC}_6\text{H}_4\text{COOH}$	σ_p	σ_m	Comments
NH ₂	4.82	4.20	-0.62	0.00	groups that donate electrons have negative σ
OCH ₃	4.49	4.09	-0.29	0.11	
CH ₃	4.37	4.26	-0.17	-0.06	there are no values for <i>ortho</i> substituents
H	4.20	4.20	0.00	0.00	
F	4.15	3.86	0.05	0.34	$\sigma_p < \sigma_m$ for inductive withdrawal
I	3.97	3.85	0.23	0.35	
Cl	3.98	3.83	0.22	0.37	$\sigma_p > \sigma_m$ for conjugating substituents
Br	3.97	3.80	0.23	0.40	
CO ₂ CH ₃	3.75	3.87	0.45	0.33	groups that withdraw electrons have positive σ
COCH ₃	3.71	3.83	0.49	0.37	
CN	3.53	3.58	0.67	0.62	
NO ₂	3.43	3.47	0.77	0.73	

There is no point learning the precise figures in this table, but it will help if you form a general idea of what a σ value means. If $\sigma = 0$ the substituent has no effect: it is electronically the same as H. If σ is positive, the substituent is electron withdrawing. This is unfortunate perhaps, but just remember that the comparison is with acid strength, and acids with electron-withdrawing substituents are stronger. Positive σ means a stronger acid so the substituent is electron withdrawing. The more positive the charge induced on the ring by a substituent, the larger its σ value. Negative σ means weaker acid and electron donation. Inductive effects from polarization of σ bonds are greater for σ_m than for σ_p because the substituent is nearer.

Conjugation is generally more effective in the *para* position (see Chapter 21) so $\sigma_p > \sigma_m$ for conjugating substituents. Indeed, the NH_2 group has a large negative σ_p and a zero σ_m . The NH_2 group donates electrons strongly to the carbonyl group of benzoic acid from the *para* position but does not conjugate in the *meta* position where its donation happens just to balance the effect of electronegative nitrogen.

The OMe group has a negative σ_p but a positive σ_m because a weaker electron donation from the lone pairs is more important in the *para* position but the effect of very electronegative oxygen on the σ framework of the ring in the *meta* position is more important than lone pair donation that doesn't reach the carbonyl group. You do not need to learn any σ values but you should be able to work out the sign of σ for well-known substituents and estimate a rough value.

The Hammett reaction constant ρ

Now we can return to our reaction: the alkaline hydrolysis of various *meta*- and *para*-substituted ethyl benzoates. We sketched the graph earlier (p. 1041) but now we can add some more quantitative detail. The rate constants for this second-order reaction have been measured and shown here is a graph of $\log(k_x/k_H)$ versus σ , where k_x is the rate constant for the reaction with the substituted benzoate and k_H is that for the unsubstituted reaction ($X=\text{H}$).

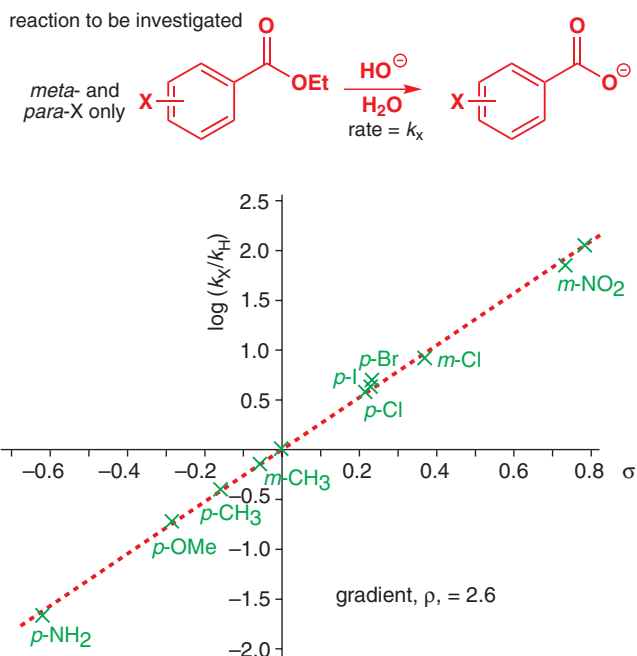

We can see straight away that there is a good correlation between how fast the reaction goes and the value of σ ; in other words, the points lie more or less on a straight line. The gradient of this best-fit line, given the symbol ρ (rho), tells us how sensitive the reaction is to substituent effects in comparison with the ionization of benzoic acids. The gradient is $\rho = +2.6$. This tells us that the reaction responds to substituent effects in the same way (because it is +) as the ionization of benzoic acids but by much more ($10^{1.6}$ times more) because it is 2.6 instead of 1.0. We already know what the mechanism of this reaction is:

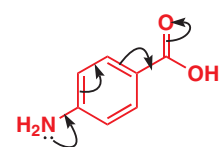
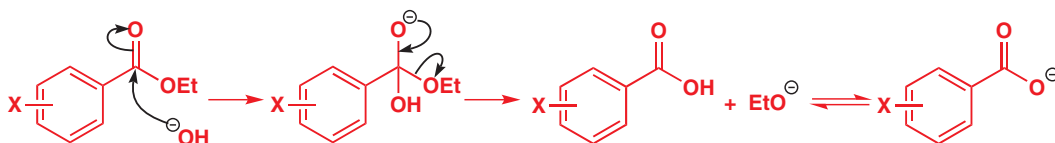

strong conjugation into carbonyl group: large negative σ_p

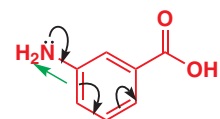

conjugation into ring not carbonyl group balances weak effect of electronegative N: zero σ_m

Getting to grips with logs

A difference between two values of x log units means the values actually differ by a factor of 10^x . From the graph for the hydrolysis of ethyl benzoates you can see that the *p*- NO_2 benzoate hydrolyses some 10^2 times faster than the unsubstituted benzoate, while the *p*- NH_2 benzoate hydrolyses some 10^2 times slower.

Hammett chose σ (Greek s) for *substituent* and ρ (Greek r) for *reaction*.

The first step is quite like the ionization of benzoic acid. A negative charge is appearing on the carbonyl oxygen atom and that negative charge will be stabilized by electron-withdrawing X groups. If the first step is rate determining, a positive ρ makes sense.

We need now to look at some other reactions to get a grasp of the meaning of the value of the Hammett ρ .

● **The Hammett reaction constant ρ measures the sensitivity of the reaction to electronic effects.**

- A **positive ρ value means more electrons in the transition state than in the starting material.**
- A **negative ρ value means fewer electrons in the transition state than in the starting material.**

typical Hammett plots

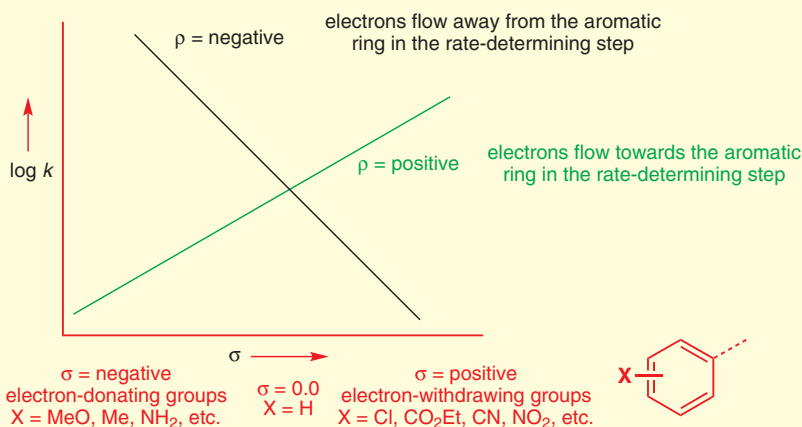

Equilibria with positive Hammett ρ values

To take a simple example, let's just see what happens to ρ if we simply move the carboxylic acid away from the ring. The ρ value for ionization gets less. This is just what you would expect—the further it is from the aromatic ring, the less the acid cares about how electron rich or poor the ring is. With two saturated carbons between the benzene ring and the carboxylic acid, there is almost no effect on pK_a . But restore electronic communications with a double bond, and ρ goes back up again.

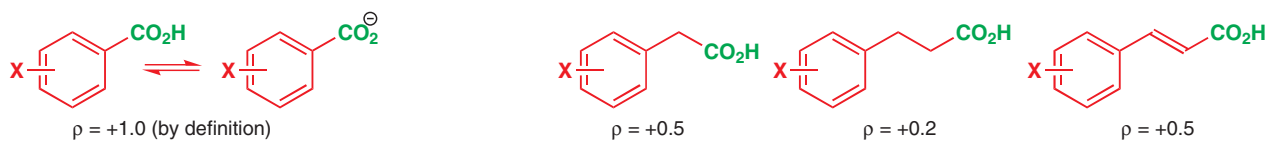

If the negative charge on the anion can actually be delocalized round the ring, as it can in substituted phenols, we should expect the size of ρ to increase. Both the phenol and the anion are delocalized but delocalization is more important for the anion. The effect is even more significant for the ionization of anilinium salts as the acid ArNH_3^+ does not have a delocalized lone pair but the conjugate base (ArNH_2) does.

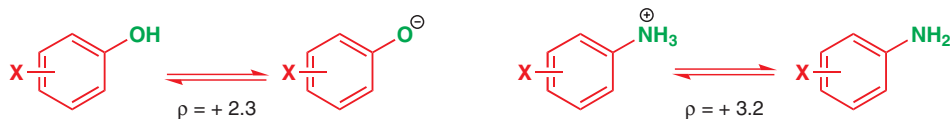

Reactions with positive Hammett ρ values

The size and sign of the value of ρ tell us about what is happening in the rate-determining step of a reaction. Any reaction that involves nucleophilic attack on a carbonyl group as the rate-

determining step is going to have a ρ value of about 2–3, the same as for the hydrolysis of esters, as we have already seen. Large positive ρ values usually indicate extra electrons in the transition state delocalized into the ring itself. A classic example is nucleophilic aromatic substitution by the addition–elimination mechanism (Chapter 22). The ρ value is +4.9, but even this large value does not mean a complete anion on the benzene ring as the nitro group, present in all cases, takes most of the negative charge. The substituent X merely helps.

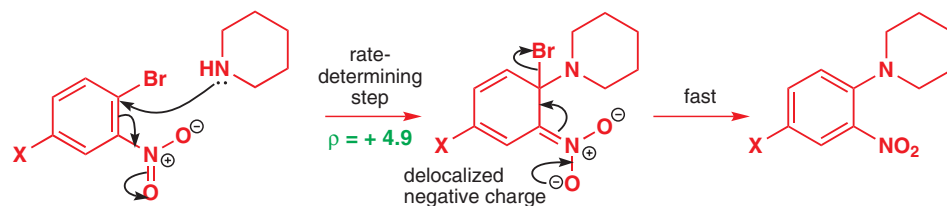

We get the full value when there are no nitro groups to take the brunt of the negative charge. This vinylic substitution has a ρ value of +9.0. It cannot be an S_N2 reaction or it would have a small ρ value and it cannot be an S_N1 reaction or it would have a negative ρ value (fewer electrons in the transition state). It must be an addition–elimination mechanism through a benzylic anion delocalized round both benzene rings.

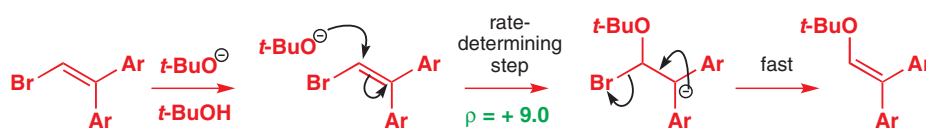

Reactions with negative Hammett ρ values

Negative ρ values mean electrons flowing away from the ring. A representative example is the S_N2 displacement of iodide from EtI by phenoxide anions. This has a ρ value of exactly -1.0 . Although the transition state has a negative charge, that charge is decreasing on the aromatic ring as the starting material approaches the transition state.

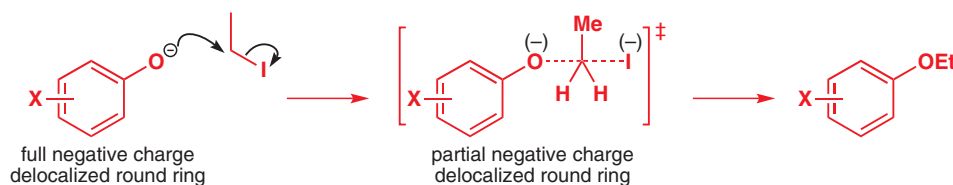

An S_N1 reaction on the carbon atom next to the ring has a large negative ρ value. In this example, a tertiary benzylic cation is the intermediate and the rate-determining step is, of course, the formation of the cation. The cation is next to the ring but delocalized round it and the ρ value is -4.5 , about the same value, though negative, as that for the nucleophilic substitution on nitrobenzenes by the addition–elimination mechanism that we saw in the last section.

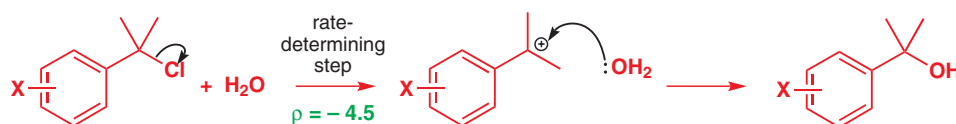

The largest negative ρ values come from electrophilic aromatic substitution (Chapter 21), where the electrons of the ring are used in the reaction, leaving a positive charge on the ring itself in the intermediate. Some of this charge is already there in the transition state. This simple nitration has $\rho = -6.4$ and ρ values for electrophilic aromatic substitution are usually in the range -5 to -9 . Negative ρ values mean electrons flowing out of the ring.

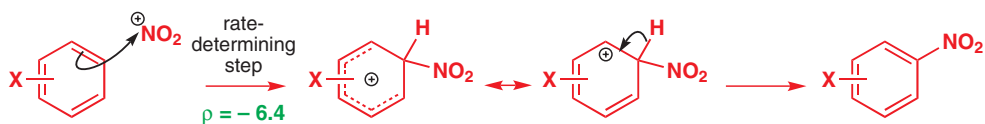

Reactions with small Hammett ρ values

Small Hammett ρ values arise in three ways. The aromatic ring being used as a probe for the mechanism may simply be too far away for the result to be significant. This trivial case of the alkaline hydrolysis of the 3-aryl propanoate ester has a ρ value of +0.5 and it is surprising that it is even that large.

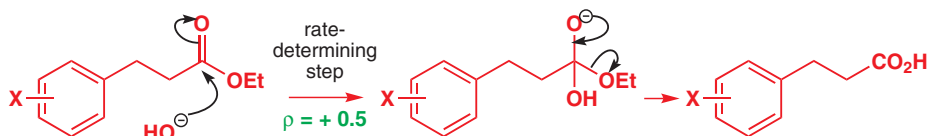

The second case is the informative one where the reaction is not dependent on electrons flowing into or out of the ring. Pericyclic reactions are important examples and the Diels–Alder reaction of arylbutadienes with maleic anhydride shows a small negative ρ value of -0.6 . The small value is consistent with a mechanism not involving charge accumulation or dispersal, but the sign is interesting. We explained this type of Diels–Alder reaction in Chapter 34 by using the HOMO of the diene and the LUMO of the dienophile. The negative sign of ρ , small though it is, supports this view because the reaction is somewhat faster with electron-donating groups on Ar, which raise the energy of the HOMO of the diene.

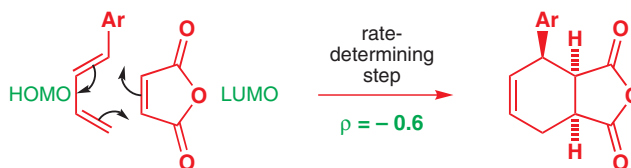

The third case is in many ways the most interesting. We have seen that the alkaline hydrolysis of ethyl esters of benzoic acids (ArCO_2Et) has a ρ value of +2.6 and that this is a reasonable value for a reaction involving nucleophilic attack on a carbonyl group conjugated with the aromatic ring. The hydrolysis of the same esters in acid solution, which also involves nucleophilic attack on the same carbonyl group, has a ρ value of +0.1. In other words, substituted benzoic esters hydrolyse at more or less the same rate in acid solution, irrespective of their substituents. We need to look at the full mechanism to explain this remarkable result.

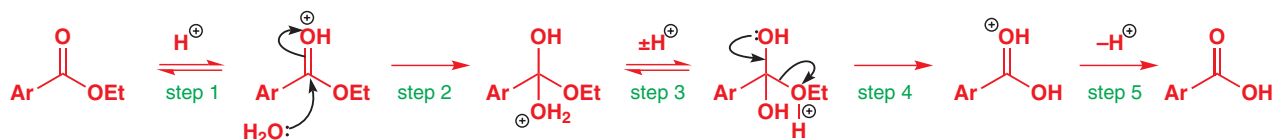

➔ We made this point in Chapter 12, p. 258.

Steps 1, 3, and 5 cannot be slow as they are just proton transfers between oxygen atoms, and proton transfer between electronegative atoms is always fast. That leaves only steps 2 and 4 as possible rate-determining steps. The bimolecular addition of the weak nucleophile water to the low concentration of protonated ester (step 2) is the most attractive candidate, as step 4—the unimolecular loss of ethanol and re-formation of the carbonyl group—should be fast. What ρ value would be expected for the reaction if step 2 were the rate-determining step? It would be made up of two parts. There would be an equilibrium ρ value for the protonation step and a reaction ρ value for the addition of water. Step 1 involves electrons flowing out of the molecule and step 2 involves electrons flowing in so the ρ values for these two steps would

have opposite charges. We know that the ρ value for step 2 would be about +2.5 (it's just like the step in the ester hydrolysis) and a value of about -2.5 for the equilibrium protonation is reasonable. This is indeed the explanation: step 2 is the rate-determining step and the ρ values for steps 1 and 2 almost cancel each other out. All steps before the rate-determining step are present in the rate equation and also affect the Hammett ρ value.

● **Summary: interpreting Hammett ρ values**

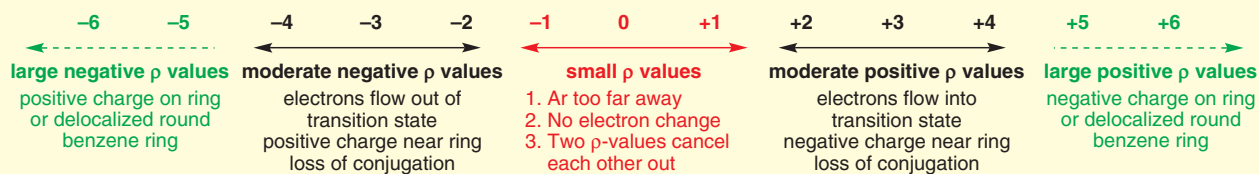

You should not, of course, learn the numbers in this scheme, but you need an idea of roughly what each group of values means. You should see now why it is unimportant whether the Hammett correlation gives a good straight line or not. We just want to know whether ρ is + or - and whether it is, say, 3 or 6. It is meaningless to debate the significance of a ρ value of 3.4 as distinct from one of 3.8.

Using the Hammett ρ values to uncover mechanisms

Electrophilic attack on alkenes by bromine often goes through three-membered ring cyclic bromonium ions and we can sometimes tell that this is so by studying the stereochemistry. Here are two reactions of styrenes that look very similar—a reaction with bromine and another with PhSCl. With no further information, we might be tempted to assume that they both go by the same mechanism. However, the Hammett ρ values for the two reactions are rather different.

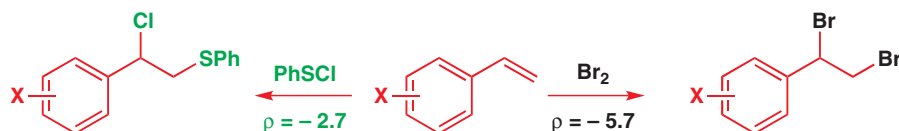

The ρ value for bromination is definitely in the 'large' range and can only mean that a positive charge is formed that is delocalized round the benzene ring. Bromine evidently does not form a bromonium ion with these alkenes but prefers to form a secondary benzylic cation instead, which can be stabilized more effectively by delocalization.

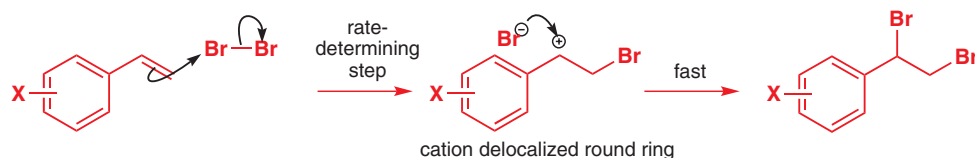

The sulfenylation, on the other hand, has a moderate negative ρ value. No cation is formed that is delocalized round the ring, but electrons flow out of the ring and we suspect some loss of conjugation. All this fits well with the formation of a three-membered ring intermediate. From experiments like this we learn that PhSCl is much more likely than bromine to react stereospecifically with alkenes through cyclic cation intermediates.

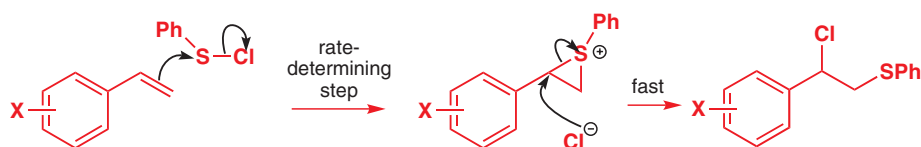

➔ Chapter 19 gives a full description of these mechanisms. There is more about these sulfonyl chlorides in Chapter 27, p. 658.

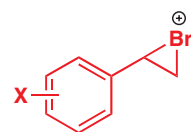

not formed in this case

A complete picture of the transition state from Hammett plots

More information can be gained on the mechanism of the reaction if two separate experiments can be carried out with the mechanistic probe inserted at two different sites on the reagents. If we are studying a reaction between a nucleophile and an electrophile, it may be possible to make Hammett plots from the variation of substituents on both reagents. The acylation of amines with acid chlorides is an example.

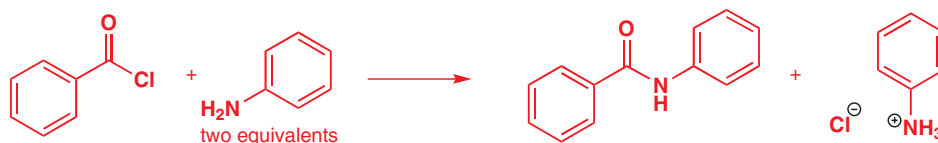

If we vary the structure of the acid chloride we get a ρ value of +1.2, typical of nucleophilic attack on the carbonyl group. If we vary the amine we get a ρ value of -3.2 , typical of a reaction in which electrons that were conjugated round the ring move away to form a new bond. Comparing the numbers tells us the rate depends on the nucleophilicity of the amine 100 times more than on the electrophilicity of the acid chloride.

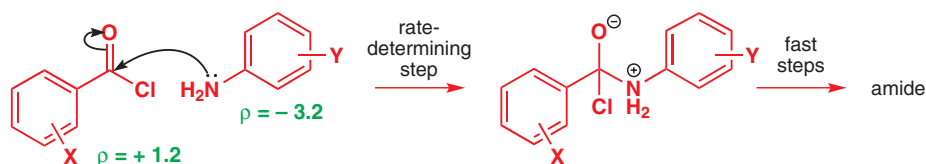

Non-linear Hammett plots

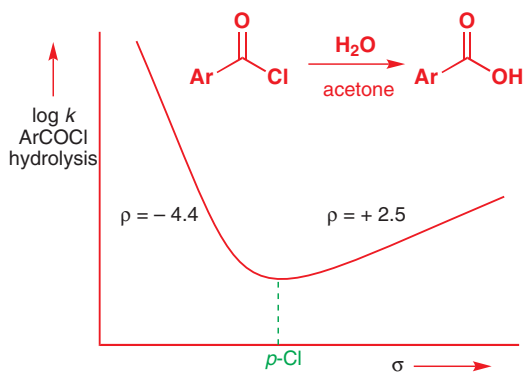

The Hammett plot for hydrolysis of the acid chlorides of benzoic acids in aqueous acetone is very odd indeed. Hammett plots need not be perfectly linear to give useful information, but this one is clearly made up of two intersecting straight lines. This might look like disaster at first but, in fact, it tells us something rather important. The right-hand part of the curve, where the more electron-withdrawing substituents lie, has a slope of +2.5: just what we should expect for rate-determining attack of water on the carbonyl group. As we go to less electron-withdrawing substituents, the rate of the reaction suddenly starts to increase as we pass the *para*-chloro compound and the left-hand part of the curve has a slope of -4.4 .

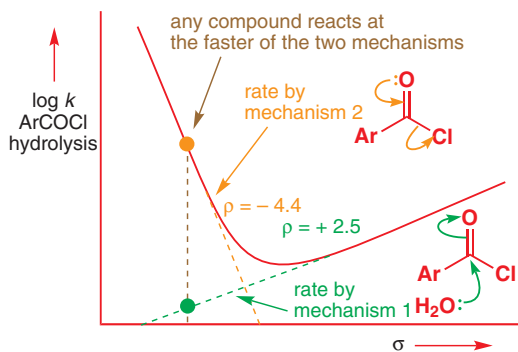

What can this mean? If the reaction becomes faster as we pass the discontinuity in the curve—and it gets faster whether we go from right to left or left to right—there must be a change in mechanism. If there is a choice between two mechanisms, the faster of the two will operate. Mechanism 1 is the rate-determining nucleophilic attack by water on the carbonyl group.

The new mechanism goes faster for more electron-donating substituents and has quite a large negative ρ value, suggesting the formation of a cation in the rate-determining step. This mechanism (mechanism 2) must surely be the S_N1 -like preliminary formation of an acylium ion by loss of chloride ion.

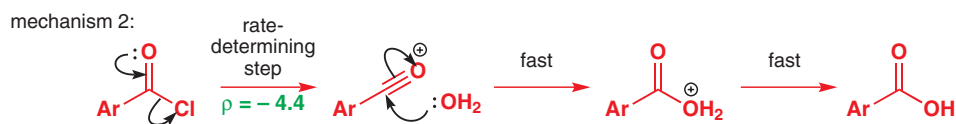

When the Hammett plot bends the other way, so that the rate of the reaction decreases as it passes the discontinuity, we have a single mechanism with a change in rate-determining step. A reaction goes by the fastest possible mechanism but its rate is limited by the slowest of the steps in that mechanism. An example is the intramolecular Friedel–Crafts alkylation of a diphenyl derivative where the alkylating agent is a diarylmethanol attached to one of the benzene rings in the *ortho* position.

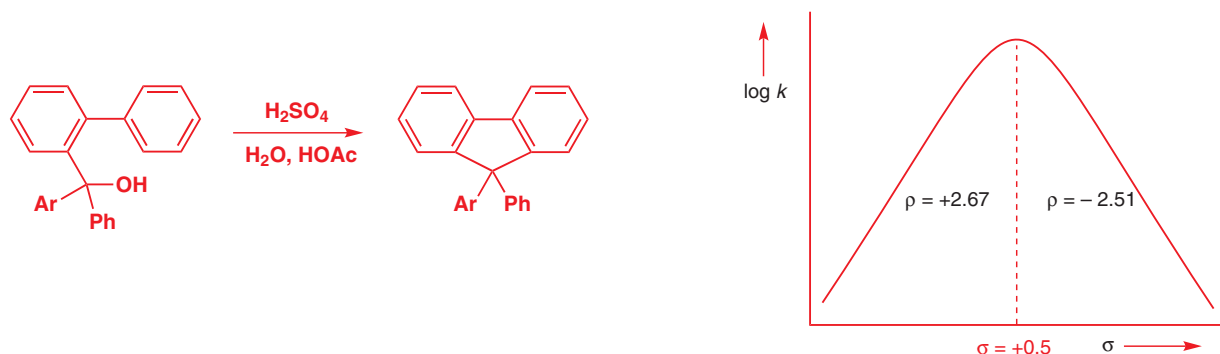

The carbocation intermediate in the Friedel–Crafts reaction (Chapter 21) is rather stable, being tertiary and benzylic, and the formation of the cation, normally the rate-determining step, with inevitably a negative ρ value, goes faster and faster as the electron-donating power of the substituents increases until it is faster than the cyclization, which becomes the rate-determining step. The cyclization puts electrons back into the carbocation and has a positive ρ value. As the two steps have more or less the reverse electron flow to and from the same carbon atom, it is reasonable for the size of ρ to be about the same but of opposite sign.

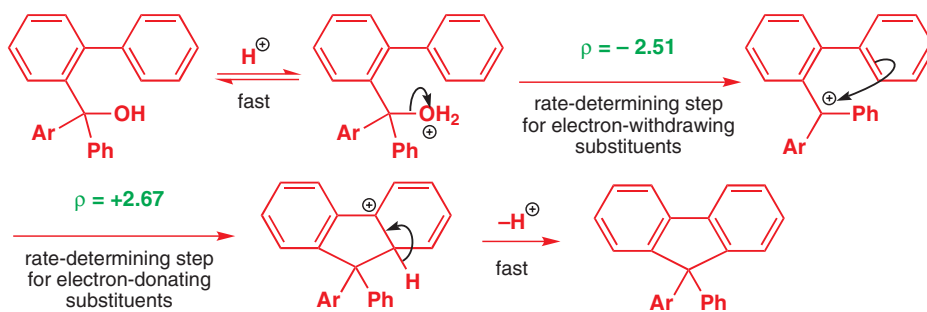

- A reaction occurs by the faster of two possible mechanisms but by the slower of two possible rate-determining steps.

We shall see more examples of Hammett ρ values used in conjunction with other evidence as the chapter develops but now it is time to look at what other evidence is available.

Other kinetic evidence for reaction mechanisms

The kinetic isotope effect

■ You have seen how isotopes have different *physical* properties—their nuclear spin, for example, which affects how they behave in an NMR machine. We also showed you in Chapter 3 how IR stretching frequencies depend on mass, and there you saw that C–D bonds have lower stretching frequencies than C–H bonds. That fact is highly relevant to the explanation we are about to give you for the origin of kinetic isotope effects.

■ The full explanation of the theory of kinetic isotope effects is beyond the scope of this book but you can read about it in any book on physical organic chemistry.

Up to now you have probably (and rightly) assumed that isotopes of an element are chemically identical. They differ only in the number of neutrons in their nuclei: chemistry generally depends on charge, orbitals, and electrons. It may come as a surprise to find that this is not quite true. Isotopes may differ chemically, because some chemical properties do depend on atomic mass. However, this difference is only significant for hydrogen—no other element has one isotope twice as massive as another! *Kinetic isotope effects* are the changes in rate observed when a (^1H) hydrogen atom is replaced by a (^2H) deuterium atom in the same reaction. For any reaction, the kinetic isotope effect (KIE) is defined as

$$\text{KIE} = k_{\text{H}}/k_{\text{D}}$$

where k_{H} is the rate with a ^1H atom in the molecule and k_{D} is the rate with a ^2H (deuterium, D) atom in the molecule.

How do kinetic isotope effects come about? Even in its lowest energy state a covalent bond never stops vibrating. If it did it would violate a fundamental physical principle, Heisenberg's uncertainty principle, which states that position and momentum cannot be known exactly at the same time: a non-vibrating pair of atoms have precisely zero momentum and precisely fixed locations. The minimum vibrational energy a bond can have is called the zero point energy, and the zero point energy depends on the mass of the atoms attached to the bond—heavier atoms have a lower zero point energy than lighter ones.

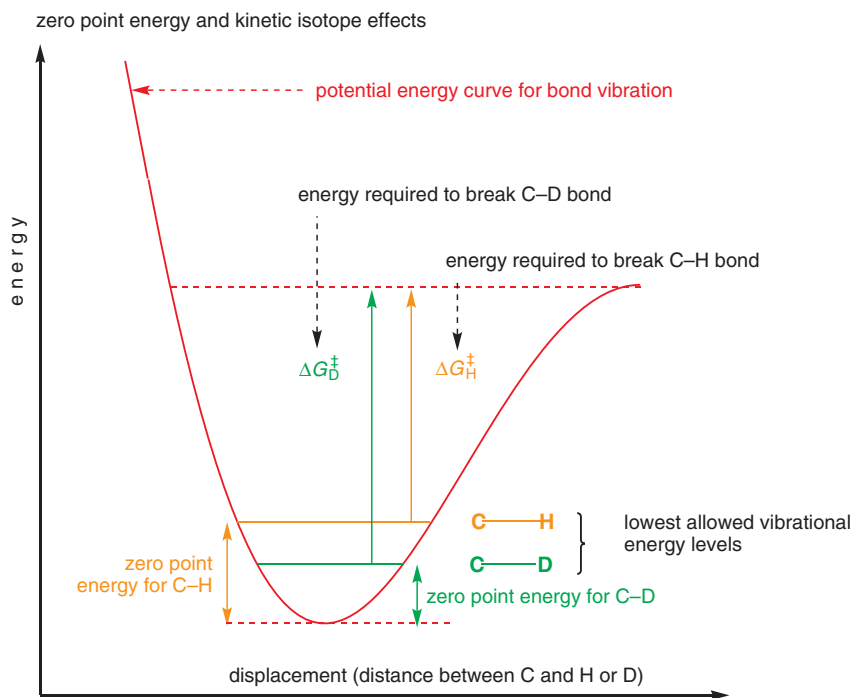

In order to break a covalent bond, a certain amount of energy is required to separate the nuclei from their starting position. This energy has to raise the vibrational state of the bond to the point where it breaks. For the sake of argument, imagine taking a C–H bond in its lowest energy state and breaking it—the diagram shows the amount of energy required, which we can call $\Delta G_{\text{H}}^{\ddagger}$. Now do the same for a C–D bond: because the zero point energy of a C–D bond is smaller than that for a C–H bond, the C–D bond needs that little bit more energy $\Delta G_{\text{D}}^{\ddagger}$ to break: in other words a C–D bond is marginally stronger than a C–H bond. This means reactions in which C–H bonds break go faster than reactions in which C–D bonds break, *providing the bond to H (or D) is involved in the rate-determining step*. The theoretical maximum value of

the KIE is about 7 for reactions at room temperature in which a bond to H or D is being broken. For example, the rates of these two eliminations can be compared, and $k_{\text{H}}/k_{\text{D}}$ turns out to be 7.1 at 25 °C.

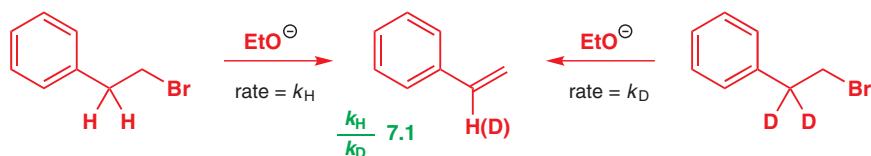

In this case the fact that the KIE is non-zero tells us that the C–H (or C–D) bond is being broken during the rate-determining step, and so the reaction must be an E2 elimination. In E1 eliminations, the rate-determining step does not involve a breaking C–H bond.

In Chapter 21 we told you that the rate-determining step in the nitration of benzene was the attack of the electrophile on the benzene ring. This is easily verified by replacing the hydrogen atoms round the benzene ring with deuteriums. The rate of the reaction stays the same, so the C–H (or C–D) bonds cannot be involved in the rate-determining step. If the second step, which does involve the breaking of a C–H bond, were the rate-determining step it would go more slowly if the H were replaced by D.

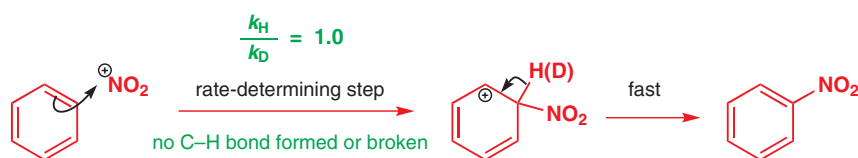

By contrast, for the iodination of phenol in basic solution there is a deuterium isotope effect of $k_{\text{H}}/k_{\text{D}} = 4.1$. Clearly, the loss of the proton from the intermediate must now be the rate-determining step—the phenolate ion reacts so rapidly that the first step is faster than the second.

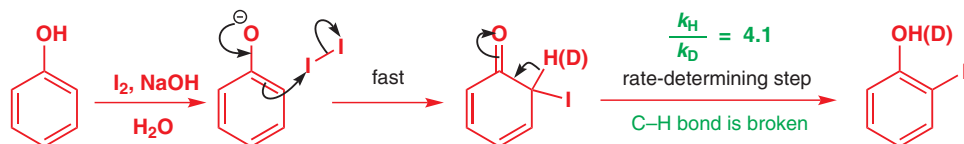

The deuterium isotope effect can add to the information from Hammett plots in building up a picture of a transition state. Three separate Hammett ρ values can be measured for the elimination reaction and this information is very valuable. In addition, a large KIE $k_{\text{H}}/k_{\text{D}} = 7.1$ is observed for the hydrogen atom under attack.

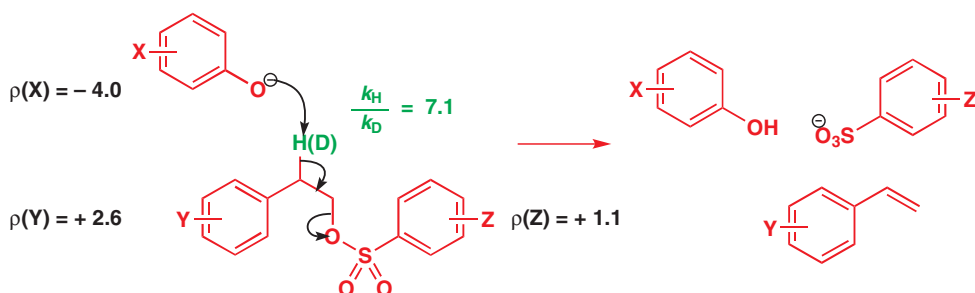

It is no surprise that the base (ArO^-) donates electrons and the leaving group (ArSO_3^-) accepts them, as the ρ values indicate. The large deuterium isotope effect tells us that the reaction is E2, but additional information comes from the moderate positive $\rho(\text{Y})$ value for the aromatic ring adjacent to the proton being lost. It might have been expected that this ring is merely a spectator, but in fact the reaction must involve a build-up of negative charge, which can be stabilized by an electron-donating substituent Y. This can be explained if we assume

➔ E1 and E2 mechanisms were covered in Chapter 17.

that the removal of the proton is slightly more advanced at the transition state than loss of the leaving group.

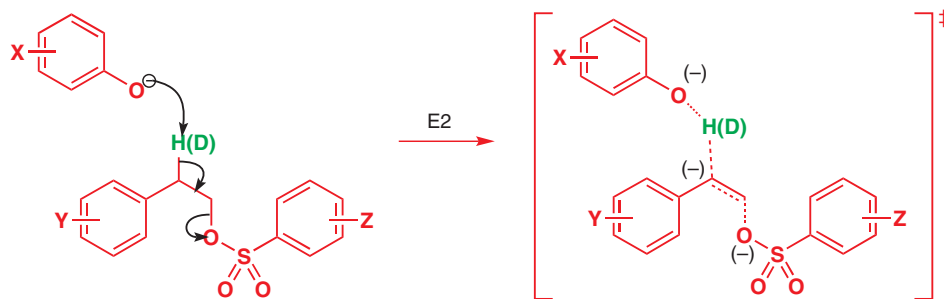

Entropy of activation

The entropy of activation, ΔS^\ddagger , of a reaction tells us about the increase or decrease in order in a reaction as the starting material goes to the transition state. A positive ΔS^\ddagger means an increase in entropy or a decrease in order, and a negative ΔS^\ddagger means an increase in order. Normally, unimolecular reactions in which one molecule gives two products have a positive ΔS^\ddagger and bimolecular reactions have a negative ΔS^\ddagger . Fragmentations (Chapter 36), such as this decarboxylation in which one molecule fragments to three, have positive values of ΔS^\ddagger , in this case $\Delta S^\ddagger = +36.8 \text{ J mol}^{-1} \text{ K}^{-1}$.

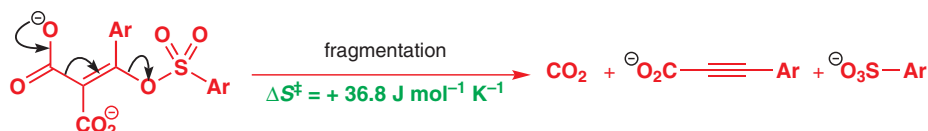

Entropies of activation are measured in units of $\text{J mol}^{-1} \text{ K}^{-1}$. All the values in this book are in $\text{J mol}^{-1} \text{ K}^{-1}$ but in older books you will see 'entropy units' (e.u.), which are $\text{cal mol}^{-1} \text{ K}^{-1}$. Values in e.u. should be multiplied by 4.18 to get values in $\text{J mol}^{-1} \text{ K}^{-1}$.

At the other extreme are cycloadditions (Chapter 34) such as the Diels–Alder reaction we examined a few pages back. Not only do two reagents become one product but a very precise orientation is required in the transition state, usually meaning a large negative ΔS^\ddagger . Diels–Alder reactions usually have ΔS^\ddagger of about -120 to $-160 \text{ J mol}^{-1} \text{ K}^{-1}$. The classic cyclopentadiene addition to maleic anhydride has $\Delta S^\ddagger = -144 \text{ J mol}^{-1} \text{ K}^{-1}$.

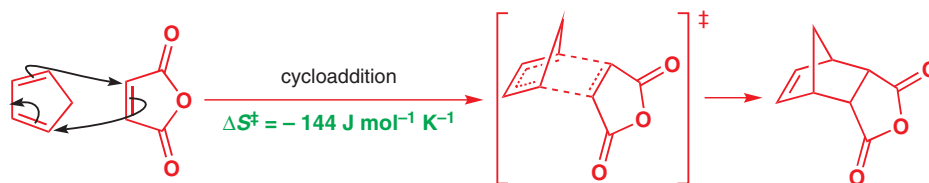

Interactive mechanism for the Diels–Alder reaction

These numbers give you the range of entropies of activation you may expect to find. Large negative numbers are common but only small positive numbers are found. The largest negative numbers apply to bimolecular reactions where neither reagent is in great excess. Smaller negative numbers may mean a bimolecular reaction with solvent or some other reagent in large excess. The acid-catalysed opening of styrene oxides in methanol is a good example.

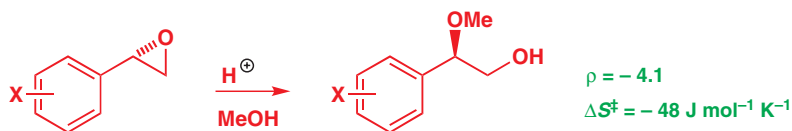

The Hammett ρ value of -4.1 suggests a carbocation intermediate, as does the regioselectivity of the reaction (MeOH attacks the benzylic position) but the stereochemistry (the reaction occurs with inversion) and a modest negative entropy of activation ($\Delta S^\ddagger = -48 \text{ J mol}^{-1} \text{ K}^{-1}$)

suggest rather an S_N2 reaction with a loose transition state having substantial positive charge at the benzylic carbon. Neither piece of evidence alone would be enough to define the mechanism.

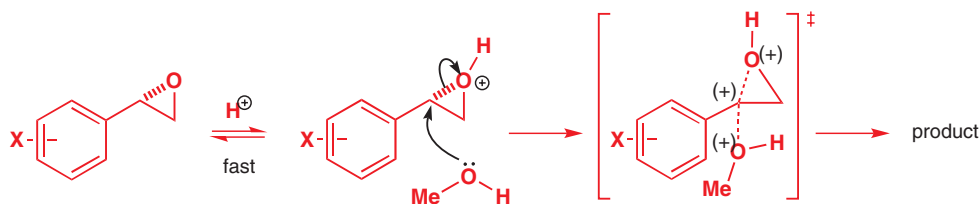

Acid and base catalysis

As you have seen throughout this book, acids and bases provide the most widely used ways of speeding up reactions. If you want to make an ester—add some acid. If you want to hydrolyse an ester—add some base. We explained in Chapter 12 the ways in which acid and base catalysts help reactions along, and we introduced you to the terms **specific acid** and **specific base**, **general acid** and **general base**. We will now look in a little more detail at these types of catalysis and give some pointers as to how to establish which of them, if any, is operative in any given reaction.

As a preliminary, let's look at an example of **specific acid catalysis**. This is the kind operating in the reaction just above—epoxides don't react with methanol but, if we protonate the epoxide first, then the reaction works. Specific acid catalysis protonates electrophiles and makes them more electrophilic.

➔ For the earlier discussion of acid and base catalysis, and an outline of what the terms **specific** and **general** acid/base catalysis mean, see Chapter 12, pp. 262–264.

specific acid catalysis



We could, on the other hand, have reasoned that although methanol is not a good enough nucleophile, deprotonating with a base will make it into the much more nucleophilic methoxide, and the reaction will also work. This sort of base catalysis—deprotonating nucleophiles to make them more nucleophilic—is **specific base catalysis**.

specific base catalysis



Specific acid catalysis

Specific acid catalysis (SAC) involves a rapid protonation of the compound followed by the slow step, which is accelerated in comparison with the uncatalysed reaction because of the greater reactivity of the protonated compound. You have just seen an example with an epoxide; ester hydrolysis (or formation) is another, as you saw in Chapter 12.

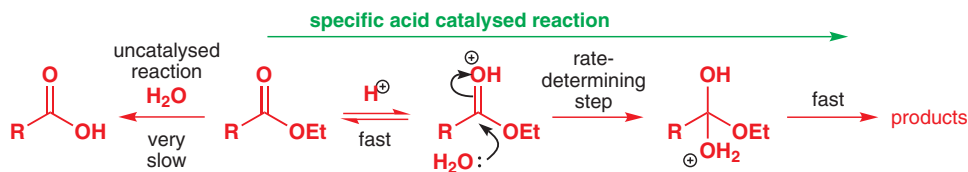

A more interesting reaction is the dienone–phenol rearrangement. Rearrangement in the absence of acid is very slow but once the ketone oxygen is protonated, it occurs very rapidly.

➔ You met this rearrangement in Chapter 36.

Again we have fast equilibrium protonation, followed by a rate-determining step involving a reaction of the protonated species: this is SAC.

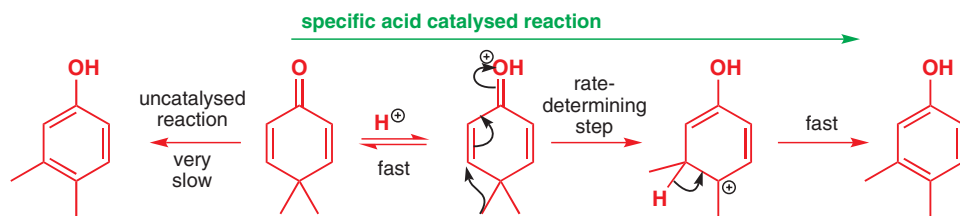

This catalysis depends only on the protonating power of the solution. The compound must be protonated to react, so the catalyst must be a strong enough acid to do the job. It is not necessary that every molecule is protonated—just enough to set the reaction going because the catalytic acid is regenerated at the end. In a specific acid catalysed reaction, the rate of the reaction depends on the pH of the reaction mixture. SAC works only if the pH is similar to, or below, the pK_a of the conjugate acid of the substrate, and the log of the rate of the reaction is proportional to the pH of the solution.

There is one rather remarkable experimental indication of this mechanism. If the reaction is carried out in a deuterated solvent (D_2O instead of H_2O) the rate of the reaction increases. This is a *solvent isotope effect* rather than a kinetic isotope effect and needs some explanation. If you examine the three examples of SAC in the previous pages you will see that they share these characteristics: a fast proton exchange is followed by a rate-determining step that does *not* involve the making or breaking of any bonds to hydrogen. In general terms:

■ As you saw on p. 1050, the usual kinetic isotope effect has $k_H/k_D > 1$. Reactions with $k_H/k_D < 1$ exhibit an *inverse kinetic isotope effect*. We don't need to go into details of how this might come about, but this is the reason a reaction that goes faster in D_2O than in H_2O (even when that is expected) is said to have an *inverse solvent kinetic isotope effect*.

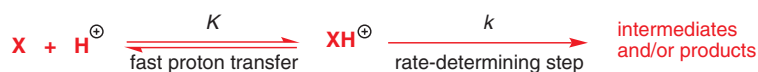

The rate of the reaction is the rate of the rate-determining step:

$$\text{rate} = k[XH^{\oplus}]$$

The concentration of the intermediate $[XH^{\oplus}]$ is related to the pH and to the concentration of the substrate by the equilibrium constant, K , of the protonation. This gives us:

$$\text{rate} = kK[H^{\oplus}][X]$$

In the acid-catalysed reaction, the bond to H (or D) is not broken in the rate-determining step, so k cannot change when hydrogen is replaced by deuterium. That means that if a reaction goes faster in D_2O than in H_2O then it must be K that is different (i.e. larger) in D_2O . SAC is more effective with D_3O^+ in D_2O than with H_3O^+ in H_2O because more of the substrate is protonated at any one time.

● An inverse solvent isotope effect ($k[D_2O] > k[H_2O]$) is indicative of specific acid catalysis.

■ It is not, of course, possible to use D_3O^+ in H_2O as H and D exchange very quickly. The solvent determines which acid is present.

This is sometimes explained by saying that D_3O^+ is a stronger acid than H_3O^+ . This is partly true. The full truth is that D_3O^+ in D_2O is a stronger acid than H_3O^+ in H_2O . Water (H_2O) is a better solvating agent for H_3O^+ than D_2O is for D_3O^+ because O–H bonds are longer than O–D bonds. Look again at the potential energy curve we showed you on p. 1050 and reproduced below, this time representing the energies of O–H and O–D bonds. The average length of a bond is the mid-point of the line in the potential energy well representing its energy level. You can easily see that the mid-point for the O–H is further out than the mid-point for the O–D bond because of the asymmetry of the well. O–H bonds are longer than O–D bonds, and can therefore make *stronger hydrogen bonds*. These hydrogen bonds are better at allowing solvation of H_3O^+ , making H_3O^+ in H_2O less willing to protonate a substrate than D_3O^+ in D_2O .

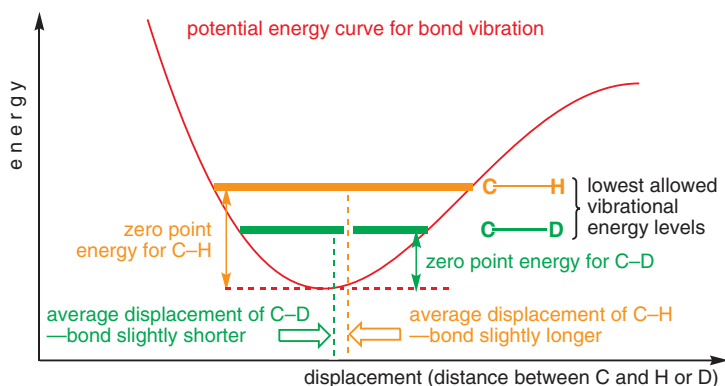

Let's illustrate all this with an example. The *Z* allylic alcohol below dehydrates in acid solution to the *E* diene. We have lots of data on this mechanism, all summarized in the diagrams. You may like to note as well that the product contains no deuterium after dehydration in D_2O .

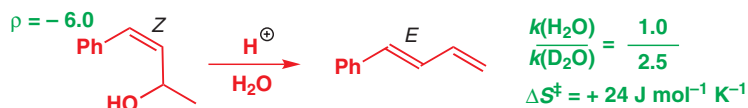

The Hammett ρ value of -6.0 suggests a carbocation intermediate and the positive entropy suggests a rate-determining step in which disorder increases, perhaps one molecule breaking into two. The inverse solvent deuterium isotope effect (faster reaction in D_2O than in H_2O) strongly suggests SAC. Putting all this together we have a mechanism—a simple example of SAC. There is no protonation at carbon.

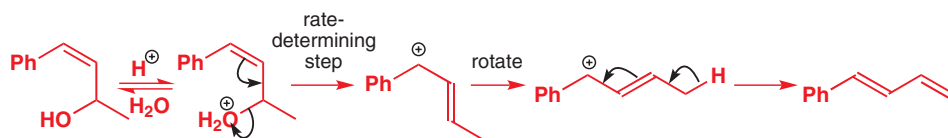

■ You can compare this mechanism with the isomerization of the same diene described earlier in this chapter.

• Summary of features of specific acid catalysis

- 1 Only H_3O^+ is an effective catalyst; pH alone matters.
- 2 Usually means rate-determining reaction of protonated species.
- 3 Effective only at pHs near or below the pK_a of the substrate's conjugate acid.
- 4 Proton transfer is not involved in the rate-determining step.
- 5 Only simple unimolecular and bimolecular steps—moderate + or $-\Delta S^\ddagger$.
- 6 Inverse solvent isotope effect $k(H_2O) < k(D_2O)$.

Specific base catalysis

The other side of the coin is *specific base catalysis* (SBC). SBC usually involves the removal of a proton from the substrate in a fast pre-equilibrium step followed by a rate-determining reaction of the anion. Most of the base-catalysed reactions you are familiar with work by SBC. Examples include opening of epoxides with thiols.



As with SAC, the rate of the reaction depends on the pH of the solution. If it is around or higher than the pK_a of the thiol, thiolate anion will be formed and this opens the epoxide much faster than does the unionized thiol. The nucleophile is then regenerated by the oxyanion produced in the rate-determining step.

It is quite common for specific acid and specific base catalysis to operate on the same reaction, depending on the pH at which the reaction is carried out. In fact, you have already seen this for ester hydrolysis in Chapter 12. The pH–rate profile (Chapter 12) for the hydrolysis of a simple ester such as ethyl acetate shows just two straight lines meeting each other (and zero rate) at about neutrality. Ethyl acetate hydrolysis occurs by SAC or SBC only.

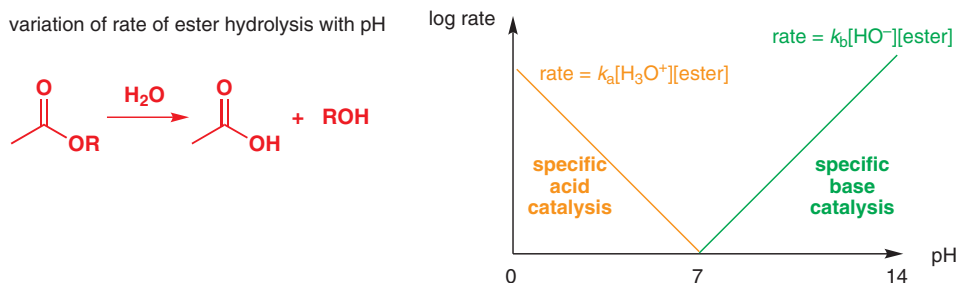

Removal of a proton from heteroatoms by heteroatom bases is never rate determining because it is always fast, but removal of a proton from carbon *can* be the rate-determining step. A remarkably large inverse solvent deuterium isotope effect was found with this elimination of a tertiary amine in basic solution.

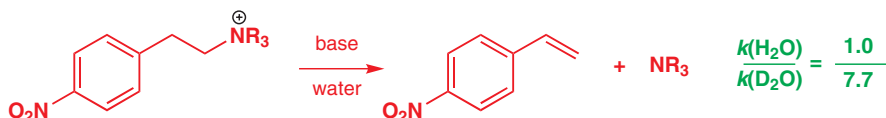

➔ E1, E2, and E1cB mechanisms are described in Chapter 17.

The detailed mechanism cannot be E2 or the isotope effect, if any, would be the other way round. With SBC, however, the mechanism can be E1cB having a carbanion as an intermediate.

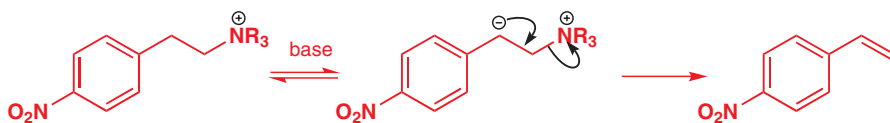

The isotope effect observed is certainly inverse (the reaction is faster with H_2O than D_2O) but the magnitude of the effect is too large to be a *solvent* isotope effect and looks much more like an inverse *kinetic* isotope effect. And so it is. The tertiary amine is not a very good leaving group in spite of its positive charge (pK_a of R_3NH^+ is about 10) so the carbanion mostly reverts to starting materials. The isotope effect is a kinetic isotope effect on this reverse step—the protonation of the carbanion. This reaction involves a proton transfer from H_2O or D_2O and will be much faster (7.7 times in fact) in H_2O due to an ordinary kinetic isotope effect. The *elimination* reaction goes faster in D_2O because the back reaction goes more slowly and more of the carbanion goes on to product.

Microscopic reversibility

There is only one least-energy pathway between two interconverting compounds such as the starting material and the intermediate here. Every microscopic detail of the back reaction is exactly the same as that for the forward reaction. This is the principle of microscopic reversibility. Here we use evidence from the back reaction (slow proton transfer from water to the carbanion) to tell us about the forward reaction.

• Summary of features of specific base catalysis

- 1 Only HO^- is an effective catalyst; pH alone matters.
- 2 Usually means rate-determining reaction of deprotonated species.
- 3 Effective only at pHs near or above the pK_a of the substrate.
- 4 Proton transfer is not involved in the rate-determining step, unless C–H bonds are involved.
- 5 Only simple unimolecular and bimolecular steps—moderate + or $-\Delta S^\ddagger$.
- 6 Inverse solvent isotope effect $k(\text{H}_2\text{O}) < k(\text{D}_2\text{O})$.

General base catalysis

In Chapter 12 (p. 263) we pointed out that even weak bases—too weak to deprotonate a nucleophile by the mechanism we have just described for SBC—can still act as catalysts. Such catalysts are known as **general base catalysts**, and are the promoters of a parallel kind of acid–base catalysis called ‘general’ rather than ‘specific’. General base catalysis, abbreviated GBC, depends not only on pH (i.e. the concentration of hydroxide ion) but also on the concentration of other bases too. General acid catalysis, abbreviated GAC, likewise depends not only on pH (i.e. the concentration of H_3O^+) but also on the concentration of other undissociated acids HA. General acid–base catalysis is a milder kind of catalysis and is characteristic of reactions catalysed by enzymes in the metabolism of living things.

In a general base-catalysed reaction, proton transfer is not complete before the rate-determining step (as it was in SBC) but occurs *during* the rate-determining step. A simple example is the catalysis by acetate ion of the formation of esters from alcohols and acetic anhydride.

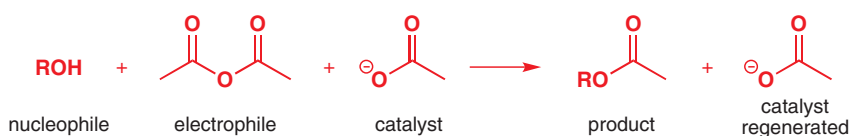

How can this catalysis work? At first sight there seems to be no mechanism available. Acetate cannot act as a specific base—it is far too weak ($\text{p}K_{\text{a}} \text{AcOH } 4.7$) to remove a proton from an alcohol ($\text{p}K_{\text{a}}$ about 15). It can't operate as a nucleophile, as pyridine does (p. 200), as nucleophilic attack on acetic anhydride would be a non-reaction, simply regenerating starting materials. The only thing it can do is to remove the proton from the alcohol *as the reaction occurs*.

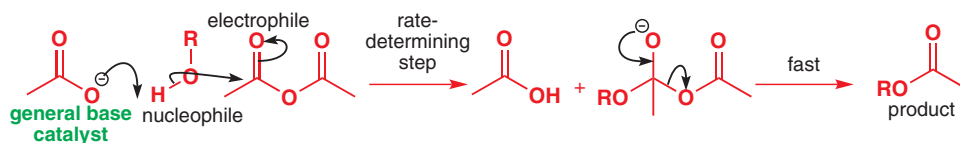

You will see at once that there is a great disadvantage in this mechanism: the rate-determining step is termolecular—three molecules have to collide. This comes out most clearly in the entropy of activation, which has an enormous negative value—around $\Delta S^\ddagger = -168 \text{ J mol}^{-1} \text{ K}^{-1}$ for this reaction. For this reason, GBC or GAC reactions are normally effective only if one of the three molecules is present in large excess—this reaction might be done in ROH as a solvent, for example, so that ROH is always present. We would also expect a normal kinetic isotope effect for ROD compared with ROH as a bond to hydrogen is being formed and broken in the rate-determining step: it is $k_{\text{H}}/k_{\text{D}} = 2.4$ here.

In understanding how this GBC works it is helpful to look at the mechanism without catalysis.

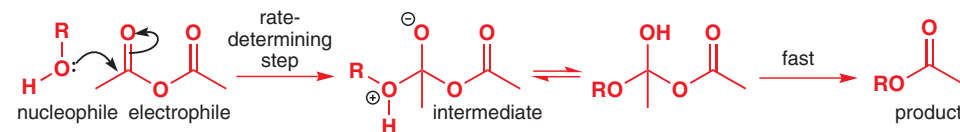

The acetate catalyst cannot remove a proton from the starting material but it can easily remove a proton from the intermediate, which has a complete positive charge on the alcohol oxygen atom. The starting material has a $\text{p}K_{\text{a}}$ above the $\text{p}K_{\text{a}}$ of HOAc but the product has a $\text{p}K_{\text{a}}$ well below it. Somewhere in the middle of the rate-determining step, the $\text{p}K_{\text{a}}$ of the ROH proton passes through the $\text{p}K_{\text{a}}$ of acetic acid and then acetate is a strong enough base to remove it. The GBC is effectively deprotonating the transition state.

➔ There was some discussion of this reaction in Chapter 12. Chapter 10 refers to the difficulty of pinpointing proton transfers in mechanisms involving the carbonyl group.

➔ The first time you met third-order kinetics (where it arose from a combination of more than one step, see p. 261) we pointed out how unlikely real termolecular steps are.

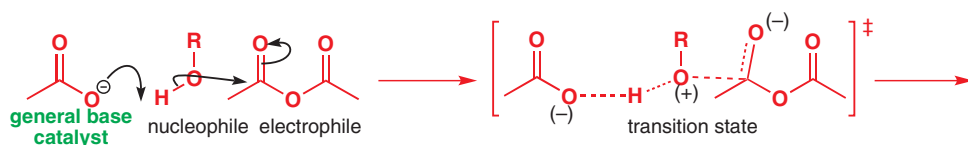

So how do we find GAC or GBC? Well, first we must remove the more powerful ‘specific’ style of catalysis by working at constant pH because SAC or SBC depends on pH alone. If we find that the rate of the reaction changes with the concentration of a weak base at constant pH, we have GBC. The formation of three- and five-membered cyclic ethers shows the contrast between GBC and SBC. The formation of epoxides is straightforward SBC with a simple linear dependence on pH between pH 8 and 12, and no acceleration at constant pH by carbonate (CO_3^{2-}) ions. There is an inverse solvent isotope effect and an aryl substituent at the electrophilic carbon atom gives the small positive ρ value expected for $\text{S}_{\text{N}}2$ with an anion.

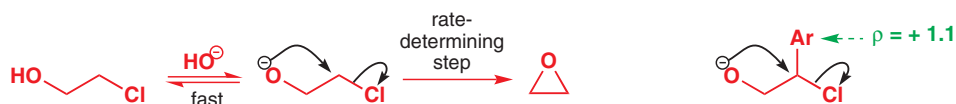

Formation of tetrahydrofuran (THF) is also faster at higher pH but, by contrast, is additionally accelerated by various bases at constant pH. If anions of phenols (ArO^-) are used as catalysts, a Hammett ρ value of +0.8 shows that electrons are flowing away from the aromatic ring. There is a small normal kinetic isotope effect $k_{\text{H}}/k_{\text{D}} = 1.4$. Both SBC and GBC are therefore operating in this reaction. Here is the mechanism with ArO^- as GBC.

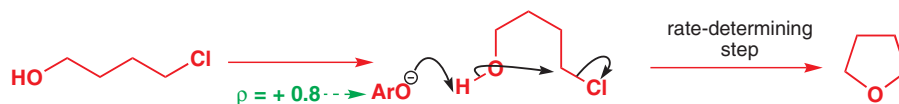

Why are the two different? The THF is easy to form, the transition state is unstrained, and only a little help is needed to make the reaction go—GBC will do. The epoxide is very strained indeed and the starting material needs to be raised in energy before cyclization will occur. Only the most powerful form of catalysis—SBC—is good enough.

● Summary of features of general base catalysis

- 1 Any base is an effective catalyst; pH also matters.
- 2 Proton transfer is involved in the rate-determining step.
- 3 Effective at neutral pHs even if below the $\text{p}K_{\text{a}}$ of the substrate.
- 4 Catalyst often much too weak a base to deprotonate the reagent.
- 5 Catalyst removes a proton, which is becoming more acidic in the rate-determining step.
- 6 Some other bond making or bond breaking also involved unless proton is on carbon.
- 7 Often termolecular rate-determining step: large $-\Delta S^\ddagger$.
- 8 Normal kinetic isotope effect $k(\text{H}) > k(\text{D})$.

General acid catalysis

GAC involves transfer of a proton from a weak acid (too weak to protonate the substrate completely) *during* the rate-determining step. A few examples will demonstrate to you how this works. They are all examples where GAC occurs because of a modification to a familiar reaction involving SAC.

In the first one, the termolecular problem (i.e. the fact that in GAC and GBC three molecules have to come together in the transition state) is avoided by making a reaction intramolecular. Normally, ester formation and hydrolysis are specific-acid-catalysed only, but here there is catalysis by a weak acid: acetic acid. A normal kinetic isotope effect $k(\text{HOAc})/k(\text{DOAc}) = 2.3$ shows that proton transfer occurs in the rate-determining step and there is a large negative $\Delta S^\ddagger = -156 \text{ J mol}^{-1} \text{ K}^{-1}$. This is GAC of nucleophilic attack on a carbonyl group, admittedly in a rather special molecule.

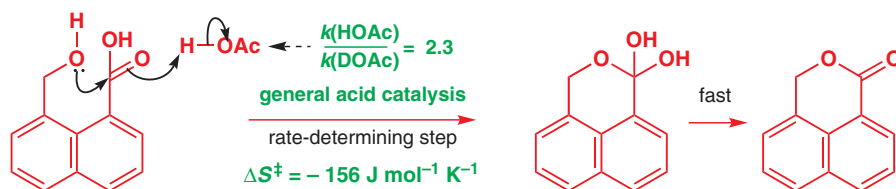

In Chapter 11 we emphasized the importance of the mechanism for the formation and hydrolysis of acetals. These are SAC reactions: alcohols are bad leaving groups and usually need to be fully protonated by strong acids before they will go, even with the help of the lone pair of another oxygen atom.

specific acid-catalysed acetal hydrolysis

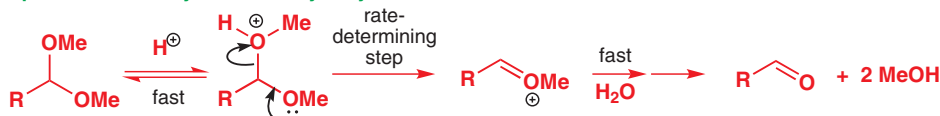

If we speed up the slow step by adding to the molecule some feature that stabilizes the cation intermediate, GAC may be found. One example is the aromatic cation formed in the hydrolysis of cycloheptatrienone acetals. The normal kinetic isotope effect announces the appearance of GAC.

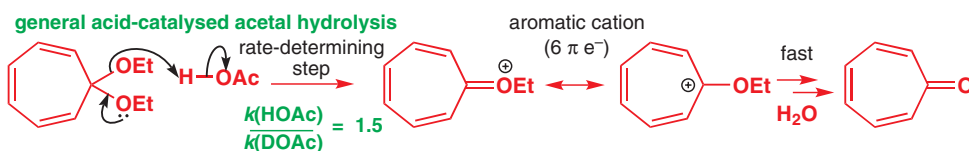

Even adding one extra alkoxy group so that we have an orthoester instead of an acetal is enough. These compounds show catalysis with a variety of weak acids at not very acidic pH (5–6). As one OMe group is protonated, two others help in pushing it out, and they both help to stabilize the intermediate cation. Nature prefers these milder methods of catalysis, as we will see in Chapter 42.

general acid-catalysed orthoester hydrolysis

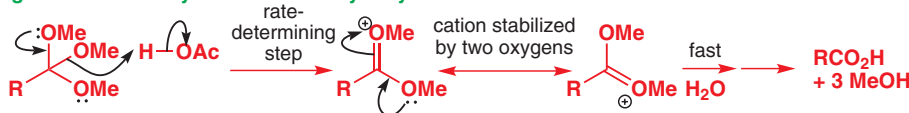

For another contrast between SAC and GAC we need only refer you back to the two *Z/E* isomerizations earlier in the chapter. Isomerization of the diene is GAC—protonation at carbon is the slow step—and isomerization of the allylic alcohol is SAC. What we didn't tell you earlier was that the GAC reaction has a normal kinetic isotope effect of $k(\text{H})/k(\text{D}) = 2.5$ and a negative entropy of activation $\Delta S^\ddagger = -36 \text{ J mol}^{-1} \text{ K}^{-1}$ —just what we should expect for a bimolecular reaction involving rate-determining proton transfer from oxygen to carbon. Notice that the intermediate cation is the same whichever the route; only the ways of getting there, including the rate-determining steps, are different.

specific acid catalysis

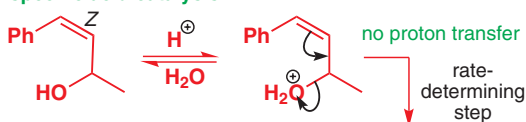

general acid catalysis



Nature often makes use of GAC and GBC since the catalysts required are compatible with the need to work at pH close to neutral. As in this example, enzymes manage to reduce the number of molecules required for GAC and GBC to operate by building the catalytic functional groups into their active sites.

➔ In these examples the steps after the rate-determining step are omitted and you should look at Chapter 11 for the full details.

These examples show you that GAC is possible with strong acids, especially when protonation is at carbon and that in such cases no other bond-making or -breaking steps need be involved.

● **Summary of features of general acid catalysis**

- 1 Any acid is an effective catalyst; pH also matters.
- 2 Proton transfer is involved in the rate-determining step.
- 3 Effective at neutral pHs even if above the pK_a of the conjugate acid of the substrate.
- 4 Catalyst often much too weak an acid to protonate reagent.
- 5 Catalyst adds proton to a site that is becoming more basic in the rate-determining step.
- 6 Some other bond-making or bond-breaking also involved unless proton is on carbon.
- 7 Often termolecular rate-determining step: large $-\Delta S^\ddagger$.
- 8 Normal kinetic isotope effect $k(H) > k(D)$.

The detection of intermediates

In earlier chapters we revealed how some reactive intermediates can be prepared, usually under special conditions rather different from those of the reaction under study, as a reassurance that some of these unlikely looking species can have real existence. Intermediates of this kind include the carbocation in the S_N1 reaction (Chapter 15), the cations and anions in electrophilic (Chapter 21) and nucleophilic (Chapter 22) aromatic substitutions, and the enols and enolates in various reactions of carbonyl compounds (Chapters 20, 25, and 26). We have also used labelling in this chapter to show that symmetrical intermediates are probably involved in, for example, nucleophilic aromatic substitution with a benzyne intermediate (Chapter 22).

intermediate in S_N1 reactions

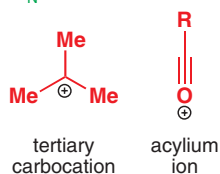

intermediates in aromatic substitution reactions

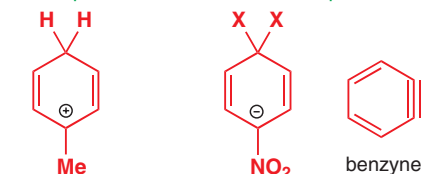

intermediate in carbonyl reactions

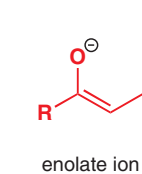

We have hedged this evidence around with caution since the fact that an intermediate can be prepared does not by any means prove that it is involved in a reaction mechanism. In this section we are going to consider other and better evidence for intermediates and at the same time revise some of the earlier material.

Trapping reactions

A more impressive piece of evidence is the design of a molecule that has built into it a functional group that could react with the intermediate in a predictable way but could not reasonably react with other species that might be present. For example, aromatic ethers react with nitrating agents in the *ortho* or *para* positions (Chapter 21). The intermediate has a positive charge delocalized over three of the carbon atoms in the benzene ring. If a nucleophilic group is built into the structure in the right way, it might trap this intermediate and stop it reacting further.

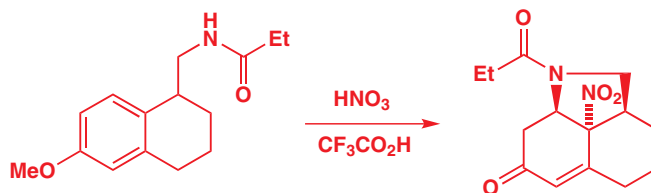

If we try drawing a mechanism for the formation of this remarkable compound, we discover that a necessary intermediate is also an intermediate in our preferred mechanism for aromatic nitration. The amide has trapped the cation we would propose as an intermediate in aromatic

nitration, so we feel more confident about that mechanism. The product is an enol ether that will hydrolyse to the observed enone.

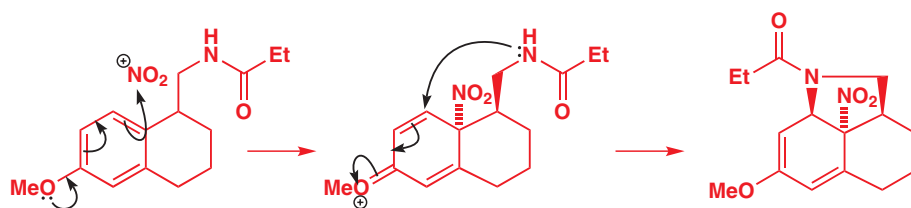

This mechanism explains everything, including the stereochemistry. The NO_2^+ attacks the aromatic ring *para* to the OMe group and on the opposite side to the amide. The amide is now in the perfect position to capture the cation at the *meta* position and, because the tether is short, it must form a *cis* bridge.

To be convincing, evidence for an intermediate should include:

- detection of the intermediate in the reaction mixture, perhaps by a trapping reaction
- a demonstration that the intermediate gives the product when added to the reaction mixture (this also means that it must be prepared as an at least reasonably stable compound)
- kinetic evidence that the rate of formation and rate of disappearance are adequate
- other suitable evidence of the kind that we have been discussing in this chapter.

A neat intramolecular trap for a benzyne works in this way. A standard benzyne-generating reaction, the diazotization of an *ortho*-amino benzoic acid (Chapter 22), gives a zwitterion that loses nitrogen and CO_2 to release the benzyne. A furan tethered to the next *ortho* position traps the benzyne in an intramolecular Diels–Alder reaction. The yield is impressive and the trap is very efficient.

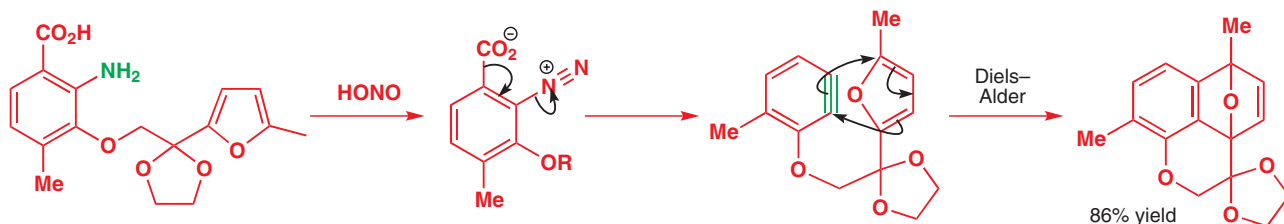

➔ Why the cyclic acetal? It makes the cyclization more efficient by the Thorpe–Ingold effect (see Chapter 31).

This reaction cannot really be explained without a benzyne intermediate. This same method of making benzyne is used on other *o*-amino benzoic acids and so we deduce that they presumably create benzyne too.

A collection of reactions linked by a common intermediate

Particularly convincing evidence can develop when a number of chemists suggest the same intermediate for a number of different reactions and show that it is possible to trap the intermediate from one reaction, put it into the others, and get the normal products. We are going to describe one such set of related reactions. In Chapter 36 we suggested a mechanism for the Favorskii rearrangement involving a series of remarkable intermediates. Here is an example.

➔ The Favorskii rearrangement is on p. 950.

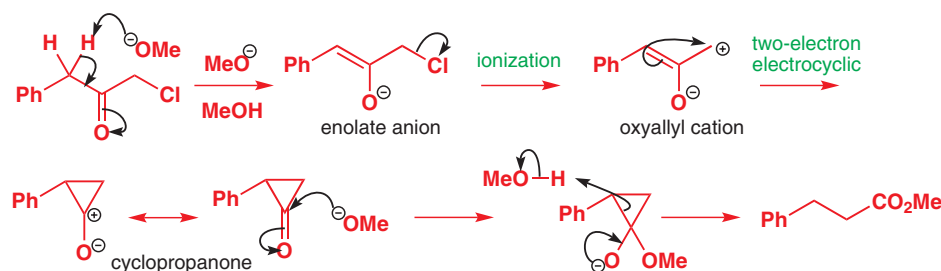

🖱 Interactive mechanism for the Favorskii rearrangement

We'll summarize the evidence on this particular example. If the reaction is run in MeOD instead of MeOH, the starting material becomes deuterated at the site of enolate formation, suggesting that this is a fast and reversible step. The entropy of activation for the reaction is $\Delta S^\ddagger = +64 \text{ J mol}^{-1} \text{ K}^{-1}$, suggesting that the slow step is one molecule breaking into two. There is only one such step—the second, ionization step. If various substituted phenyl groups are used, the Hammett ρ value is -5 . This large negative value also suggests that the ionization is the slow step as the cation is delocalized into the benzene ring.

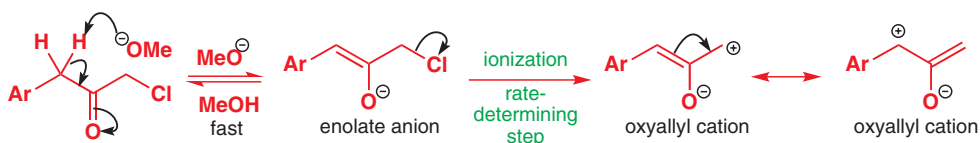

There is evidence for the first intermediate—the exchange of deuterium from the solvent. In fact formation of the enolate can even become the rate-determining step. If we merely add an extra methyl group to the chloroketone the reaction becomes 220 times faster and the rate-determining step changes. There is no longer any exchange of deuterium from the solvent and the Hammett ρ value changes from -5 to $+1.4$. This small positive value, showing some modest increase in electron density near the ring, matches typical known ρ values for enolate formation.

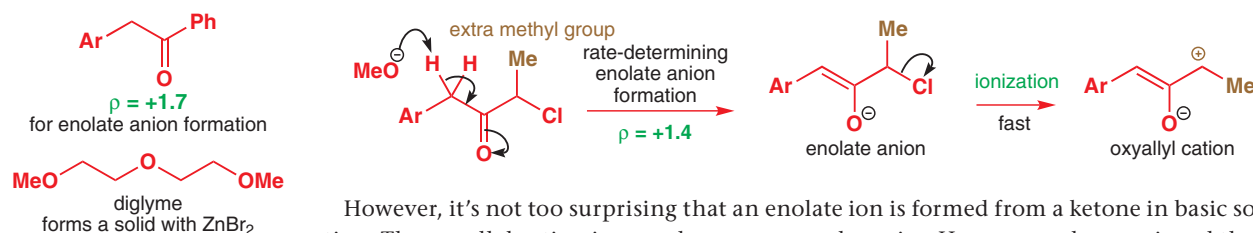

However, it's not too surprising that an enolate ion is formed from a ketone in basic solution. The oxyallyl cation is a much more unusual species. How can we be convinced that it really is an intermediate? One way is to make it by an alternative route. If basic nucleophiles such as the methoxide ion are avoided and reaction of zinc with an α, α' -dibromoketone in a non-nucleophilic solvent like diglyme is used instead, the oxyallyl cation can be trapped in a Diels–Alder reaction. This is the basis for a good synthesis of seven-membered rings.

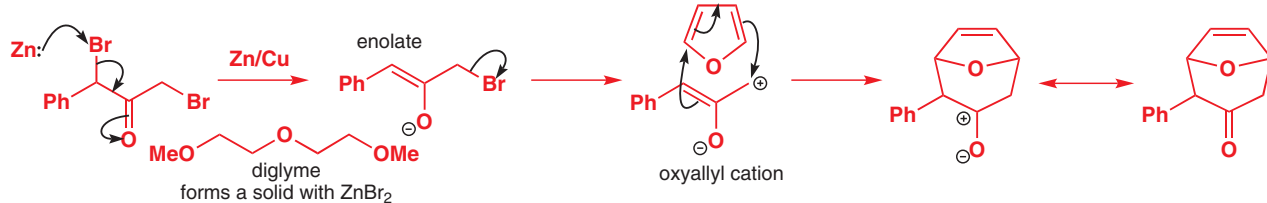

But does the oxyallyl cation go on to give cyclopropanones? In fact, there is good evidence that the two are in equilibrium. If the same method is used to create the diphenyl oxyallyl cation in methanol instead of in diglyme, the normal Favorskii product is produced. Evidently, methoxide is needed only to produce the enolate—methanol alone is enough to decompose the cyclopropanone.

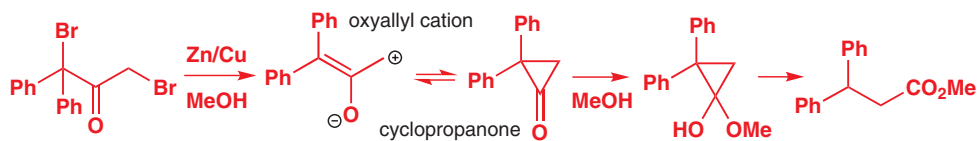

Further information comes from another reaction. If a suitable (1,3-di-*t*-butyl) allene is epoxidized with *m*-CPBA the unstable allene oxide can actually be isolated. On heating, this

➔ For related reactions, see Chapter 34, p. 894.

epoxide gives a stable *trans*-di-*t*-butylcyclopropanone. It is very difficult to see how this reaction could happen except via the oxyallyl cation intermediate.

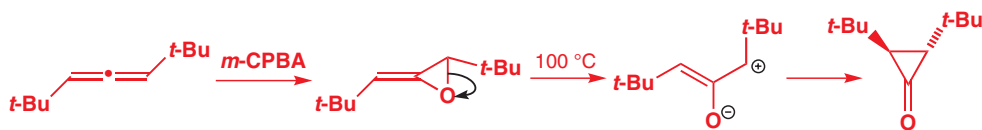

But can the same cyclopropanone be an intermediate in the Favorskii reaction? If the bromoketone is treated with methoxide in methanol, it gives the Favorskii product, but if it is treated with a much more hindered base, such as the potassium phenoxide shown, it gives the same cyclopropanone.

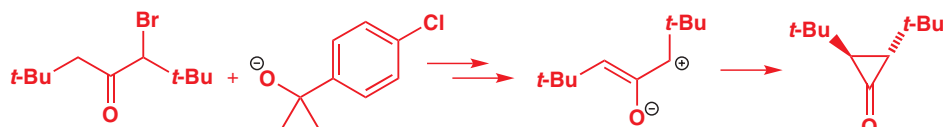

Other, less stable, cyclopropanones—such as this 2,2-dimethyl compound—can be made by carbene addition (Chapter 38) to ketenes. This compound did the Favorskii reaction with methoxide in methanol: the only product came from the expected loss of the less unstable carbanion. This will, of course, be general acid catalysed by methanol as no free carbanion can be released into an alcoholic solvent.

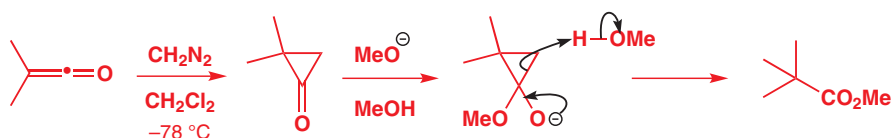

The same cyclopropanone gives a cycloadduct with furans—this must surely be a reaction of the oxyallyl cation and we can conclude that the isomeric reactive intermediates are in equilibrium, and react to give products according to the conditions they find themselves in.

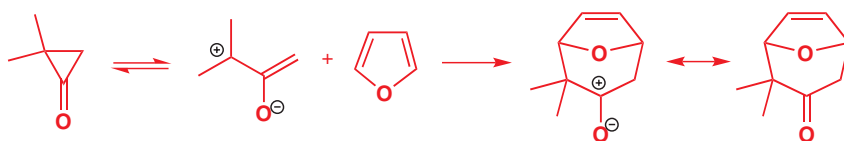

Although it is never possible to prove a mechanism, this interlocking network of intermediates, all known to be formed under the reaction conditions, all being trapped in various ways, and all known to give the products, is very convincing. If any part of the mechanism were not correct, that would throw doubt on all the other reactions as well.

Stereochemistry and mechanism

Although we have left stereochemistry to the last, it is one of the most important tools in unravelling complex mechanisms. You have already seen how inversion of configuration is a vital piece of evidence for an S_N2 mechanism (Chapter 15) while retention of configuration is the best evidence for participation (Chapter 36). You have seen the array of stereochemical evidence for pericyclic mechanisms (Chapters 34 and 35). The chapters devoted to diastereoselectivity (32 and 33) give many examples where information about the mechanism follows from the stereochemistry. We shall not go over that material again, but summarize the types of evidence with new examples. The first example looks too trivial to mention.

Retention or inversion?

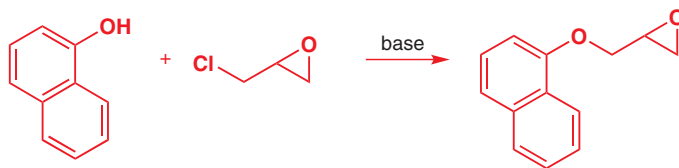

Although this reaction looks like a simple S_N2 displacement by the naphthyloxy anion on the primary alkyl chloride, there is, in fact, a reasonable alternative—the opening of the epoxide at the less hindered primary centre followed by closure of the epoxide the other way round. The electrophile is known as epichlorohydrin and has two reasonable sites for nucleophilic attack.

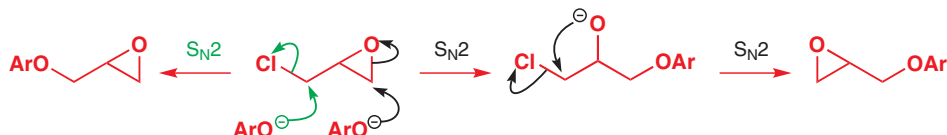

It looks difficult to tell these mechanisms apart since both involve the same kind of reaction. Stereochemistry is the answer. If enantiomerically pure epichlorohydrin is used, the two mechanisms give different enantiomers of the product. Although each S_N2 reaction takes place at a primary centre and the stereogenic centre remains the same, the products shown in orange and in brown are obviously enantiomers.

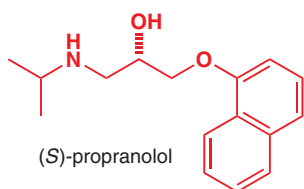
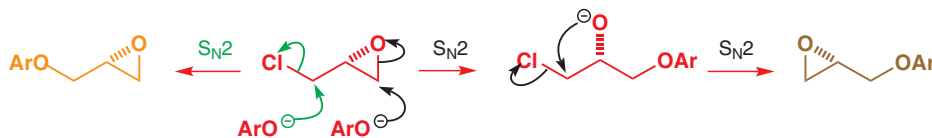

➔ A synthesis of propranolol is given in Chapter 28.

Finding out the mechanism of this process is not idle curiosity as a group of drugs used to combat high blood pressure and heart disease, such as propranolol, are made from epichlorohydrin and it is essential to know which enantiomer to use to get the right enantiomer of the drug. In fact, the epoxide is attacked initially, in preference to the chloride.

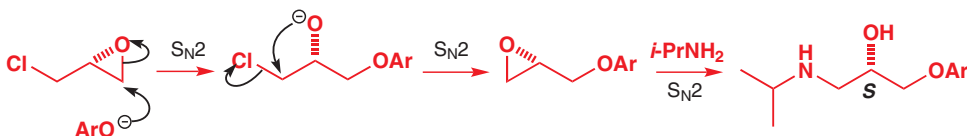

A more complicated example arises from the strange reactions used to make malic acid from chloral and ketene. An initial [2 + 2] cycloaddition is followed by acid treatment and then treatment with an excess of aqueous NaOH. Neutralization gives malic acid.

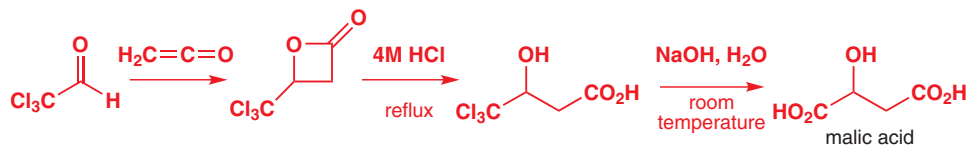

The mechanism of this reaction also looks straightforward: normal ester hydrolysis followed by hydrolysis of the CCl_3 group to CO_2H . Caution suggests investigation, particularly as four-membered lactones sometimes hydrolyse by S_N2 displacement at the saturated ester carbon rather than by attack on the carbonyl group, like the three-membered lactones discussed in Chapter 36 (p. 934). The solution was urgently needed when it was found that enantiomerically pure lactone could be prepared as a single enantiomer. The sequence was repeated with enantiomerically pure lactone: lactone hydrolysis occurred with retention of configuration and must be normal ester hydrolysis by attack of water at the carbonyl group. But the hydrolysis of the CCl_3 group surprisingly occurred with inversion of configuration.

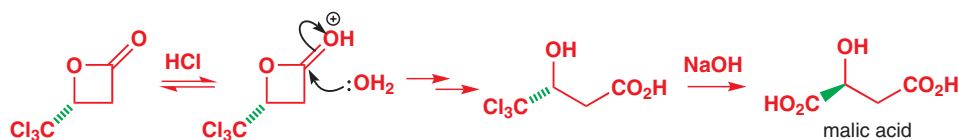

The answer must be a mechanism related to the one we have just seen for epichlorohydrin. Attack by hydroxide on CCl_3 is almost unknown and it is much more likely that intramolecular attack by alkoxide to give an epoxide should occur. The carboxylate anion can then invert the stereogenic centre by intramolecular $\text{S}_{\text{N}}2$ displacement. Notice that the tether ensures attack at the nearer end of the epoxide. The second four-membered lactone also hydrolyses by attack at the carbonyl group.

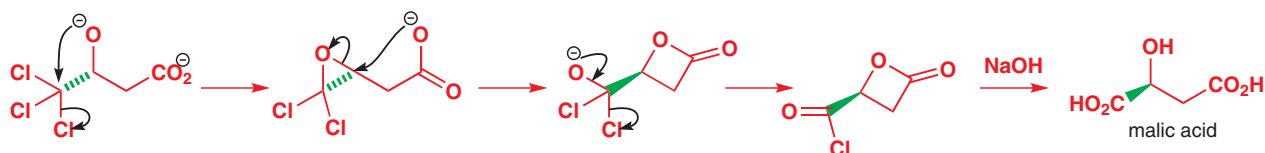

➔ In Chapter 31 we discussed Baldwin's rules for ring closures such as these. The unreactivity of the trichloromethyl group is related to the unreactivity of dichloromethane: see p. 804.

The Ritter reaction and the Beckmann fragmentation

Another collection of related intermediates occurs in the Ritter reaction and the Beckmann fragmentation. The Ritter reaction involves the combination of a tertiary alcohol and a nitrile in acid solution and the proposed mechanism involves a series of intermediates.

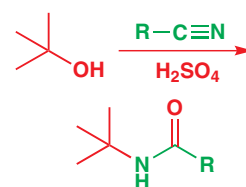
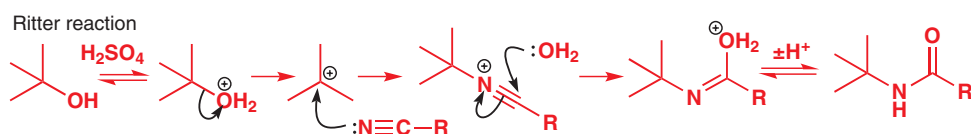

The Beckmann fragmentation also occurs in acid solution on the fragmentation of an oxime with a tertiary alkyl group *anti* to the OH of the oxime. The fragmentation step gives the same cation and the same nitrile together with a molecule of water and these three combine in the same way to give the same amide. We need evidence that the carbocation and the nitrilium ion are genuine intermediates and that the same sequence is found in both reactions.

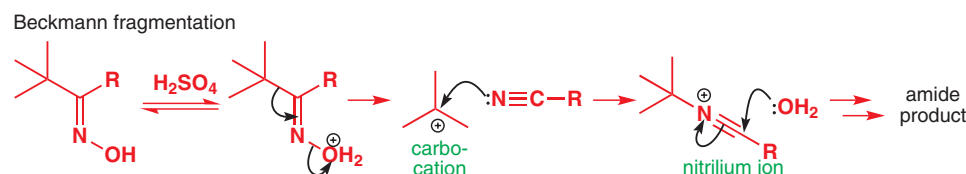

Evidence that the two reactions are intimately related comes from the formation of the same amide from two different starting materials: a tertiary alcohol and an oxime, both based on the decalin skeleton. The oxime has its OH group *anti* to the ring junction to minimize steric hindrance as oxime formation is under thermodynamic control (Chapter 11).

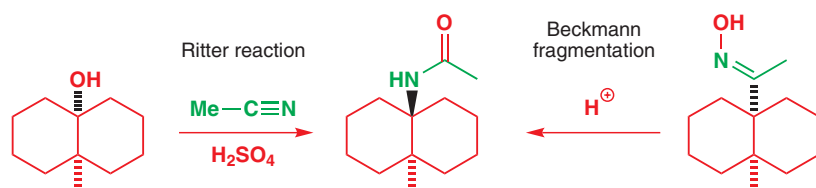

The experiments also provide stereochemical evidence that a carbocation is an intermediate in both reactions. Both starting materials are *cis*-decalins but the product is a *trans*-decalin. The carbocation intermediate has no stereochemistry and can react with the nitrile from either face: since axial attack is preferred the product is the more stable *trans*-decalin. Here's the mechanism for the Beckmann fragmentation:

➔ The Ritter reaction was introduced in Chapter 15 and the Beckmann fragmentation in Chapter 36.

Interactive mechanism for the Beckmann fragmentation

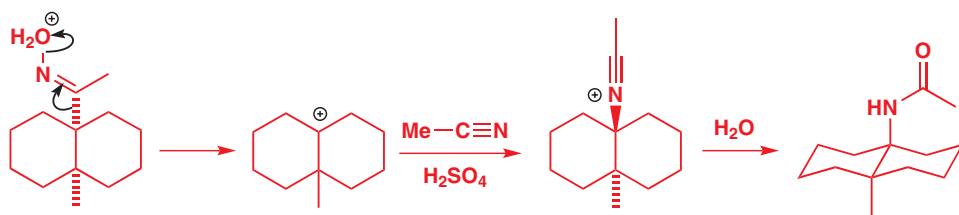

It is also possible to trap the carbocation in other ways. The Beckmann fragmentation of this oxime of an aryl seven-membered ring ketone gives a tertiary carbocation that might be expected to cyclize to give an amide. However, this reaction would give an unfavourable eight-membered ring (see Chapter 32) and does not happen. Instead, the chain twists round the other way and forms a much more stable six-membered ring by intramolecular Friedel-Crafts alkylation.

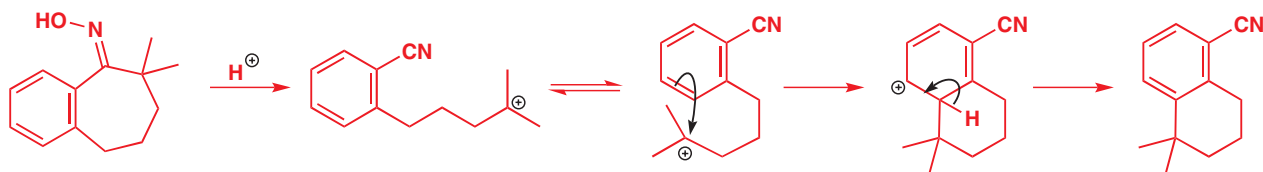

➔ Rearrangements of carbocations were described in Chapter 36, pp. 940–947.

In the Ritter reaction a rather different kind of evidence for the cation is the fact that families of isomeric alcohols all give the same product. In all these cases, rearrangements of the first-formed carbocation can easily account for the products. An example in the decalin series is this Ritter reaction with KCN as the nitrile in acidic solution so that HCN is the reagent. The starting material is a spirocyclic tertiary alcohol but the product is a *trans*-decalin formed by rearrangement.

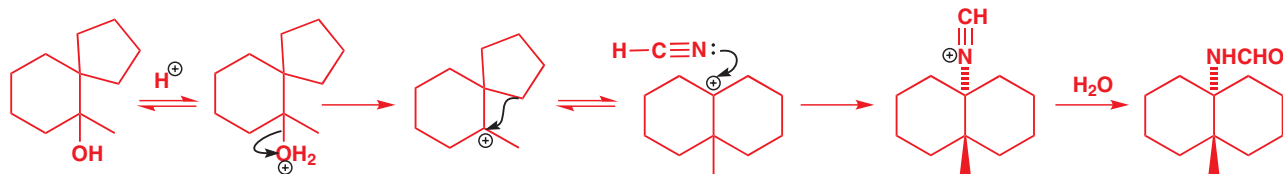

■ It's worth pointing out here that use of cyanides in acid is extremely dangerous.

Trapping the nitrilium ion is also possible. A famous example is the heterocycle (an oxazine, Chapter 32) produced by intramolecular capture of the nitrilium ion with a hydroxyl group. Note that the tertiary alcohol reacts to give the cation while the secondary alcohol acts as the nucleophilic trap.

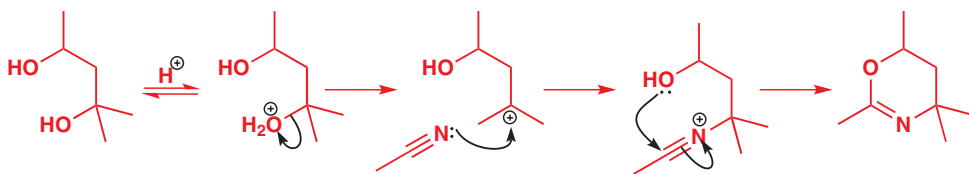

An important example in which the diastereoisomer produced was critical in determining the mechanism is the synthesis of *cis*-aminoindanol, a part of Merck's anti-HIV drug Crixivan (indinavir). The reaction involves treatment of indene epoxide with acetonitrile (MeCN) in acidic solution. The product is a *cis* fused heterocycle. It is easy to see which atoms have come from the nitrile (green) but the substitution of nitrogen for oxygen at one end of the epoxide has occurred with retention of configuration as the *cis*-epoxide has given the *cis* product. Clearly, we have some sort of Ritter reaction and the nitrilium ion has been trapped with an OH group.

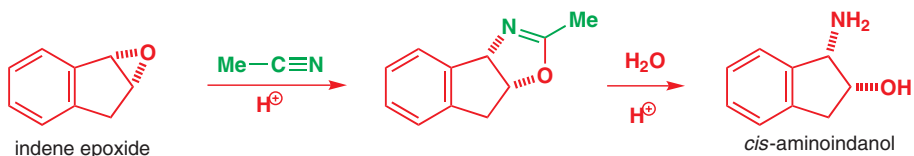

What about the regioselectivity? The obvious explanation is that a cation is formed from the epoxide by a specific acid-catalysed ring opening. But why should the nitrile attack the bottom face of the cation? We should expect it to attack the top face preferentially as the hydroxyl group partly blocks the bottom face.

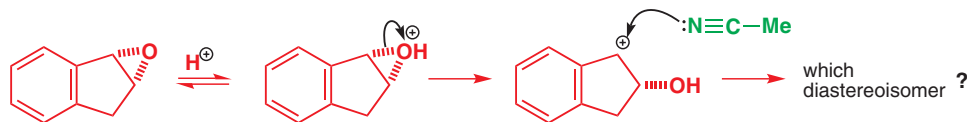

A reasonable suggestion is that the nitrile adds *reversibly* to the cation. Every time it adds to the top face, it drops off again as the OH group cannot reach round to form the heterocycle. But every time it adds to the bottom face (which may well be less often), it is quickly captured by the OH group because 5,5 fused rings are favourable when the ring junction is *cis*. Eventually, all the compound is converted to the heterocycle.

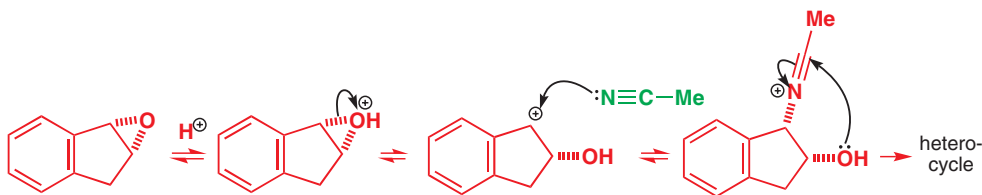

The mechanism of this reaction is of great importance because it is the foundation stone of the synthesis of Crixivan (indinavir)—an anti-HIV drug that has saved thousands of lives.

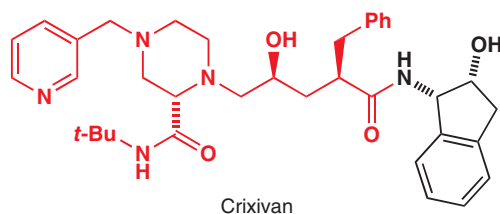

➔ The last step looks a long stretch, but you saw in Chapter 31 that 5-*endo-dig* cyclizations are favourable (p. 813).

🖱 Interactive mechanism for the formation of *cis*-aminoindanol by the Ritter reaction

➔ The story of indinavir is recounted in Chapter 43.

Summary of methods for the investigation of mechanism

This brief summary is for guidance only and the figures quoted are approximate ranges only. The full text above should be used for detail. All methods would not be used in one investigation.

1. Make sure of the structure of the product

- Basic structure (Chapters 3, 13, and 18) and stereochemistry (Chapter 31) by spectroscopic methods.
- Detail of the fate of individual atoms by labelling with D, ^{13}C , and ^{18}O . Double labelling may help.
- The stereochemical course of the reaction (enantio- or diastereoselectivity) may be critical.

2. Kinetic methods

- Rate equation gives the composition of main transition state.
- Deuterium isotope effect: $k_{\text{H}} > k_{\text{D}}$ shows bond to H formed and/or broken in transition state. Values of $k_{\text{H}}/k_{\text{D}}$ of 2–7 typical.
- Entropy of activation shows increase (ΔS^\ddagger positive) or decrease (ΔS^\ddagger negative) in disorder. Typical values and deductions:
 - ΔS^\ddagger positive (rarely larger than $+50 \text{ J mol}^{-1} \text{ K}^{-1}$): one molecule breaks into two or three
 - moderate negative values: no change in number of molecules (one goes to one etc.) or bimolecular reaction with solvent

- large negative values: two molecules go to one or unimolecular reaction with ordered transition state (cycloaddition, etc.)

3. Correlation of structure and reactivity

- Replace one group by another of similar size but different electronic demand (CF₃ for CH₃ or OMe for CH₃).
- Systematic Hammett σ/ρ correlation with *m*- and *p*-substituted benzenes:
 - sign of ρ : + ρ indicates electrons flowing into and – ρ electrons flowing out of ring in transition state
- magnitude of ρ shows effect on the benzene ring:
 - large (around 5), charge on ring (+ ρ , anion; – ρ , cation)
 - moderate (around 2–4), charge on atom next to ring—may be gain or loss of conjugation
 - small (<1), ring may be distant from scene of action or ρ may be balance of two ρ s of opposite sign.

4. Catalysis

- pH–rate profile reveals specific acid or base catalysis.
- Rate variation with [HA] or [B] at constant pH reveals GAC or GBC.
- Deuterium isotope effect: normal ($k_H > k_D$) shows GA/BC, inverse solvent $k(D_2O) > k(H_2O)$ shows SA/BC.
- GA/BC is termolecular and has large negative entropy of activation.

5. Intermediates

- Independent preparation or, better, isolation from or detection in reaction mixture helps.
- Must show that intermediate gives product under reaction conditions.
- Designed trapping experiments often most convincing.

Further reading

An excellent modern and rather more advanced book is E. V. Anslyn and D. A. Dougherty, *Modern Physical Organic Chemistry*, University Science Books, Sausalito, CA, 2005.

Check your understanding



To check that you have mastered the concepts presented in this chapter, attempt the problems that are available in the book's Online Resource Centre at <http://www.oxfordtextbooks.co.uk/orc/clayden2e/>

Connections

➔ Building on

- Nucleophilic substitution at saturated carbon **ch15**
- Conjugate addition **ch22**
- Controlling stereochemistry **ch14, ch32, & ch33**
- Oxidation and reduction **ch23**
- Chemistry of Si and Sn **ch27**
- Aromatic heterocycles **ch29 & ch30**
- Cycloadditions **ch34**
- Rearrangements **ch35 & ch36**
- Radicals and carbenes **ch37 & ch38**

Arriving at

- Transition metals form organic compounds
- The structure of σ and π complexes and the meaning of η numbers
- The bonding is described with the usual orbitals
- Most stable complexes have 18 valence electrons
- Metals catalyse 'impossible' reactions
- Oxidative insertion, reductive elimination, and ligand migration from metal to carbon are key steps
- Carbon monoxide inserts into metal-carbon bonds
- Palladium is the most important metal
- C-C, C-O, and C-N bonds can be made with Pd catalysis
- Cross-coupling of two ligands is common
- Allyl cation complexes are useful electrophiles

➔ Looking forward to

- Asymmetric synthesis **ch41**
- The chemistry of life, especially nucleic acids **ch42**

Transition metals extend the range of organic reactions

Some of the most exciting reactions in organic chemistry make use of transition metals, and in recent years three Nobel prizes have been awarded for work in this area. How about this example? It is a **Heck reaction**, which allows nucleophilic addition to an unactivated alkene. Just a catalytic amount of palladium is needed to make the reaction go: the most useful organometallic reactions are those in which the metal acts catalytically.

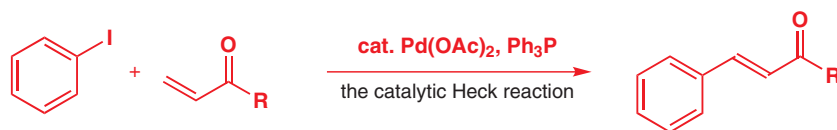

Reagents and complexes containing transition metals are important in modern organic synthesis because they allow apparently impossible reactions to occur easily. Their chemistry complements traditional functional group chemistry and significantly broadens the range of

■ True to our beliefs that explanations are more important than facts, we have given mechanisms for most reactions. You should understand that it is much more difficult to be certain about these mechanisms than in some other areas of chemistry: a great deal of work goes into establishing mechanisms for important organometallic transformations, but many remain speculative. The mechanisms we give are meant to help you understand what is going on and may well turn out not to be correct in every detail.

reactions a chemist can expect to use to make molecules. This chapter introduces the concepts of metal–ligand interaction, describes the most important reactions that can occur while ligands are bound to the metal, and demonstrates the power of organometallic chemistry in synthesis. The efficiency of transition metal-catalysed reactions means that they are routinely used in industrial synthesis. It is important that you understand the rules by which organometallic chemistry works.

The 18 electron rule

There is a contradiction in what is required of a metal complex for it to be useful to us. Initially, it will need to be stable and have a long enough lifetime to enable study and, ideally, storage. But once it enters the reaction vessel, stability is a disadvantage: instead we want reactivity. Our ideal catalyst is a complex that is stable in the resting state, but quickly becomes activated in solution—perhaps by loss of a ligand—so that it can interact with the substrate. Fortunately, there is a simple guide to the stability of transition metal complexes: **the 18 electron rule**. If a complex satisfies the 18-electron rule it means that the metal at the centre of the complex has the noble gas configuration of 18 electrons in the valence shell, and the complex is likely to be stable. The requirement for 18 electrons comes from the need to fill one ‘s’ orbital, five ‘d’ orbitals, and three ‘p’ orbitals with two electrons in each. The 18 electrons we need can come from those the metal already possesses plus those donated by any coordinating ligands.

The table below gives you the number of valence electrons each metal starts with before it acquires any ligands. Notice that the ‘new’ group numbers 1–18 give you the answer without any calculation. The most important are highlighted.

Group	IVB (4)	VB (5)	VIB (6)	VIIB (7)	VIII (8, 9, and 10)			IA (11)
Number of valence electrons	4	5	6	7	8	9	10	11
3d electrons	Ti	V	Cr	Mn	Fe	Co	Ni	Cu
4d electrons	Zr	Nb	Mo	Tc	Ru	Rh	Pd	Ag
5d electrons	Hf	Ta	W	Re	Os	Ir	Pt	Au

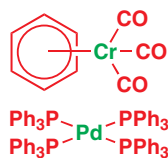

18-electron complexes

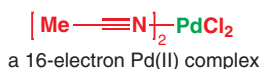

a 16-electron Pd(II) complex

Metals to the left-hand side of this list obviously need many more electrons to make up the magic 18. Chromium, for example, forms stable complexes with a benzene ring, giving it six electrons, and three molecules of carbon monoxide, giving it two each: $6 + 6 + 2 + 2 + 2 = 18$. Palladium is happy with just four triphenylphosphines (Ph_3P) giving it two each: $10 + 2 + 2 + 2 + 2 = 18$.

You may already know from your study of inorganic chemistry that there are exceptions to the 18-electron rule, particularly among complexes of Ti, Zr, Ni, Pd, and Pt, which can all form stable 16-electron complexes. The important 16-electron Pd(II) complex with two chlorides and two acetonitriles (MeCN) will feature heavily in this chapter. The so-called platinum metals Ni, Pd, and Pt are extremely important in catalytic processes, as you will see later on. Their stable 16-electron configuration results from a high-energy vacant orbital caused by the complex adopting a square planar geometry.

Ligands can be attached in many different ways



Transition metals can have a number of ligands attached to them and each ligand can be attached in more than one place. This affects the reactivity of the ligand and the metal because each additional point of attachment means the donation of more electrons. We can show the number of atoms involved in bonding to the metal by a **hapticity number** η . A simple Grignard reagent is η^1 (pronounced ‘eta-one’) as the magnesium is attached only to one carbon atom. A metal–alkene complex is η^2 because both carbon atoms of the alkene are equally involved in bonding to the metal. In these cases the η designation is not very informative as there are no alternatives, and it is usually omitted.

The bonding in these two complexes is very different. In the first there is a simple σ bond between the metal and the alkyl group as in a Grignard reagent $R-MgBr$ and this type of complex is called a σ complex. In the alkene complex, bonding is to the p orbitals only. There are no σ bonds to the metal, which sits in the middle of the π bond in between the two p orbitals. This type of complex is called a π complex.

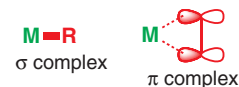

Representing bonds in transition metal complexes

It is difficult to know exactly how to draw the bonding in metal complexes and there are often several different acceptable representations. There is no problem when the metal forms a σ bond to atoms such as Cl or C as the simple line we normally use for covalent bonds means exactly what it says. The problems arise with ligands that form σ bonds by donating both their electrons, and with π complexes. Everyone writes phosphine–borane complexes with two charges but we normally draw the same sort of bond between a phosphine and, say, Pd as a simple line with no charges.

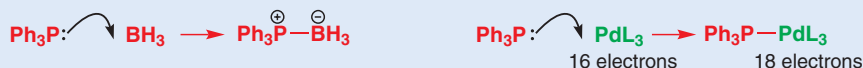

You will sometimes see π complexes drawn with simpler dotted lines going to the middle of the π bond, sometimes with dotted π bonds, and sometimes with bonds (simple or dotted) going to the ends of the old π bond. These are all acceptable as the bonding is complex, as you will see. We might almost say that the ambiguity is helpful: we often don't know either the exact nature of the bonding or the number of other ligands in the complex. In the diagrams in this section we have shown the main bond from metal to ligand as a heavy line in the simplest representation but we also offer alternatives with simple and dotted bonds. Don't worry about this—things will become clearer as the chapter develops. When you have to draw the structure of a complex but you don't know the exact bonding, just draw a line from metal to ligand.

different acceptable ways to draw π complexes

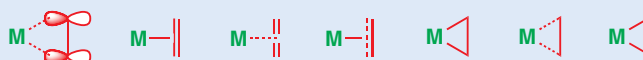

These labels are useful where there is a choice of type of bonding, as with allylic ligands. The metal can either form a σ bond to a single carbon (hence η^1), or form a π complex with the p orbitals of all three carbons of the allyl system—this would be η^3 . If the π complex is made from an allyl cation, the ligand has two electrons, but it has four if it is made from an allyl anion. Similarly, a cyclopentadienyl anion can act as a σ ligand (η^1), an allyl ligand (η^3), or, most usually, as a cyclopentadienyl ligand (η^5). The distinction is very important for electron counting as these three different situations contribute two, four, or six electrons, respectively, to the complex.

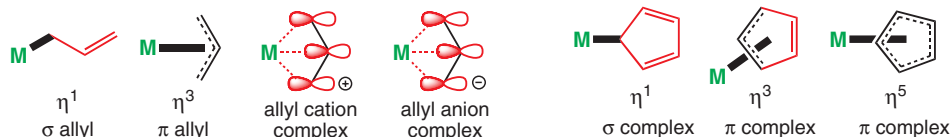

Neutral ligands can also bond in a variety of ways. Cyclooctatetraene can act as an alkene (η^2), a diene (η^4), a triene (η^6), or a tetraene (η^8), and the reactivity of the ligand changes accordingly. These are all π complexes with the metal above or below the black portion of the ring and with the thick bond to the metal at right angles to the alkene plane.

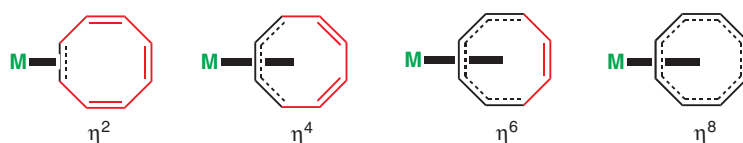

To determine the number of electrons around the transition metal in a complex the valence electrons from the metal ion are added to those contributed by all the ligands. The numbers of electrons donated by various classes of ligands are summarized in the table. Anions such as halides, cyanide, alkoxide, hydride, and alkyl donate two electrons, as do neutral ligands with a lone pair such as phosphines, amines, ethers, sulfides, carbon monoxide, nitriles, and

isonitriles. Unsaturated ligands can contribute as many as eight electrons and can be neutral or negatively charged. If the overall total is 18, then the complex is likely to be stable. If the overall total is less than 18 the complex is called *coordinatively unsaturated*.

Ligand characteristics	Formal charge	Electrons donated
anionic ligands		
Cl^- Br^- I^- CN^- OR^- H^- alkyl^-	-1	2
neutral σ -donor ligands		
	0	2

Organic ligands	Hapto number	Formal charge	Electrons donated
unsaturated σ - or π -donor ligands			
aryl, σ -allyl	η^1	-1	2
alkenes	η^2	0	2
π -allyl cation	η^3	+1	2
π -allyl anion	η^3	-1	4
diene—conjugated	η^4	0	4
dienyls, cyclopentadienyls (anions)	η^5	-1	6
arenes, trienes	η^6	0	6
trienyls, cycloheptatrienyls (anions)	η^7	-1	8
cyclooctatetraene	η^8	0	8
carbene, nitrene, oxo	η^1	0	2

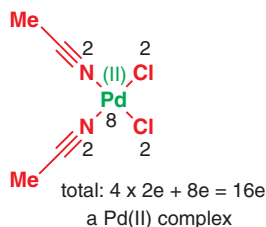
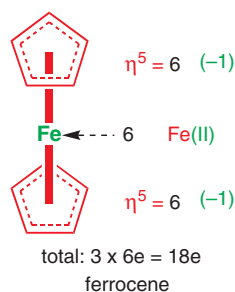
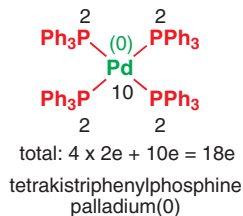

Electron counting helps to explain the stability of metal complexes

Counting electrons in most complexes is simple using the table of ligand characteristics above in conjunction with the table on p. 1070. Take tetrakis(triphenylphosphine) palladium(0): each neutral phosphine donates two electrons, making a total of eight, and palladium still has its full complement of 10 valence electrons as it is in the zero oxidation state. Overall, the complex has a total of 18 electrons and is a stable complex—in fact too stable: it has to lose a PPh_3 ligand before it can enter into reactions.

All of the different classes of ligands listed in the table above can be treated in this way. In ferrocene, the cyclopentadienyl ligands contribute six electrons each and have a formal negative charge, shown in green, which means that the iron in ferrocene is in the +2 oxidation state and will have six valence electrons left. The total for the complex is again 18 and ferrocene is an extremely stable complex.

The useful complex $(\text{MeCN})_2\text{PdCl}_2$ has palladium in the +2 oxidation state because of its two chlorine atoms and the number of electrons is eight for the Pd(II) oxidation state and another two each from the four ligands, making 16 in all. This complex does not fulfil the 18-electron rule and is stable yet reactive.

The oxidation state of metals in complexes

As well as the problem of bond drawing, there is a potential problem over oxidation states too. You can either say that ferrocene is a complex of Fe(II), having two fewer electrons than the normal eight, with two cyclopentadienyl anions contributing six electrons each, or you can say that it is a complex of Fe(0), having eight electrons, with two cyclopentadienyl ligands each contributing five electrons. The simplest approach is to say that a metal is in the (0) oxidation state unless it has σ bonds to ligands such as Cl , AcO , or Me that form bonds with shared electrons. Neutral ligands such as Ph_3P that provide two of their own electrons do not affect the oxidation state of the metal.

Bonding and reactions in transition metal complexes

The majority of ligands have a lone pair of electrons in a filled sp^n type orbital that can overlap with a vacant metal 'dsp' orbital, derived from the vacant d, p, and s orbitals of the metal, to form a conventional two-electron two-centre σ bond. Ligands of this type increase the electron density on the central metal atom.

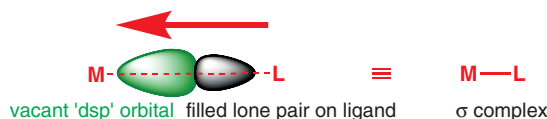

A bonding interaction is also possible between any filled d orbitals on the metal and vacant ligand orbitals of appropriate symmetry such as π^* orbitals. This leads to a reduction of electron density on the metal and is known as **back-bonding**. An example would be a complex with carbon monoxide. Many metals form these complexes and they are known as **metal carbonyls**. The ligand (CO) donates the lone pair on carbon into an empty orbital on the metal while the metal donates electrons into the low-energy π^* orbital of CO. Direct evidence for this back-bonding is an increase in the C–O bond length and a lowering of the infrared stretching frequency from the population of the π^* orbital of the carbonyl.

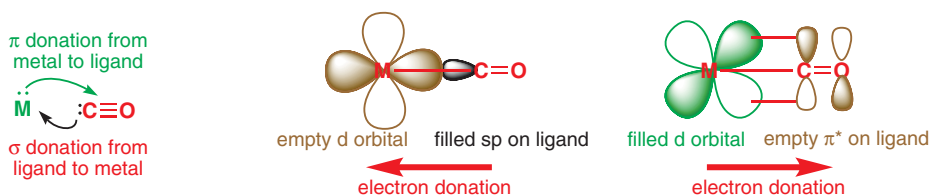

When an unsaturated ligand such as an alkene approaches the metal sideways to form a π complex, similar interactions lead to bonding. The filled π orbitals of the ligand bond to empty d orbitals of the metal, while filled d orbitals on the metal bond to the empty π^* orbitals of the ligand. The result is a π complex with the metal–alkene bond perpendicular to the plane of the alkene. The bond has both σ and π character.

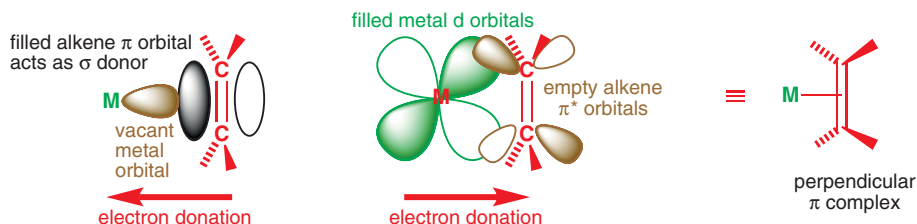

Coordination to a metal by any of these bonding methods changes the reactivity of the ligands dramatically and this is exploited in the organometallic chemistry we will be discussing in the rest of the chapter. You do not need to understand all the bonding properties of metal complexes but you need to be able to count electrons, to recognize both σ and π complexes, and to realize that complexes show a balance between electron donation and electron withdrawal by the metal.

Oxidative addition inserts metal atoms into single bonds

Potential ligands that do not have a lone pair or filled π -type orbital are still able to interact with transition metal complexes but only by breaking a σ bond. This is the first step in a wide variety of processes and is described as **oxidative addition** because the formal oxidation state of the transition metal is raised by two, for example $M(0)$ to $M(II)$, in the process. This is the result of having two extra ligands bearing a formal negative charge. You have seen this process in the formation of Grignard reagents (Chapter 9).

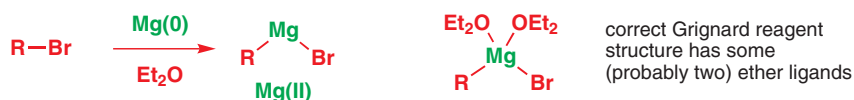

The number of coordinated ligands also increases by two so the starting complex is usually in low oxidation state (0 or 1; the diagram shows 0) and **coordinationally unsaturated**, that is, it has an empty site for a ligand and, say, only 16 electrons, like $(\text{MeCN})_2\text{PdCl}_2$, whereas the product is usually **coordinationally saturated**, that is, it cannot accept another ligand unless it loses one first.

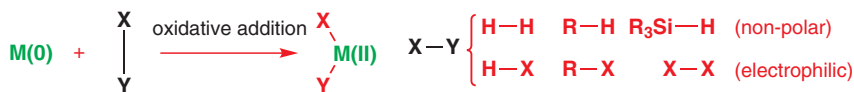

➔ You will see why Wilkinson's catalyst and its derivatives are important catalysts of homogeneous hydrogenation in Chapter 41.

Oxidative addition occurs for a number of useful neutral species, including molecular hydrogen, carbon–hydrogen bonds, and silanes as well as polarized bonds or electrophilic species containing at least one electronegative atom. The resulting species with metal–ligand bonds allow useful chemical transformations to occur. Important examples include the oxidative addition of Pd(0) to aryl iodides and the activation of Wilkinson's catalyst for hydrogenation in solution by oxidative addition to a hydrogen molecule.



Vaska's complex

There are a number of possible mechanisms for oxidative addition and the precise one followed depends on the nature of the reacting partners. Vaska's complex $[\text{Ir}(\text{PPh}_3)_2\text{COCl}]$ has been extensively studied and it reacts differently with hydrogen and methyl iodide. Hydrogen is added in a *cis* fashion, consistent with concerted formation of the two new iridium–hydrogen bonds. The 16e (count them!), d^8 , Ir(I) complex becomes a new 18e, d^6 , Ir(III) species. With methyl iodide the kinetic product is that of *trans* addition, which is geometrically impossible from a concerted process. Instead, an S_N2 -like mechanism is followed involving nucleophilic displacement of iodide followed by ionic recombination.

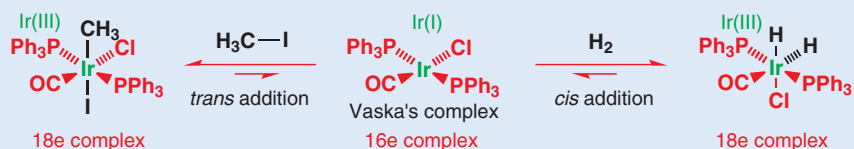

Reductive elimination removes metal atoms and forms new single bonds

If we want to use organometallic chemistry to make organic compounds other than those containing metals, we must be able to remove the ligands from the coordination sphere of the metal at the end of the reaction. Neutral organic species such as alkenes, phosphines, and carbon monoxide can simply dissociate in the presence of other suitable ligands but those that are bound to the metal with shared electrons require a more active process. Fortunately, most reactions that occur around a transition metal are reversible and so the reverse of oxidative addition, known as **reductive elimination**, provides a simple route for the release of neutral organic products from a complex. Our general reaction shows M(II) going to M(0), releasing X–Y. These two ligands were separate in the complex but are bound together in the product. A new X–Y σ bond has been formed.

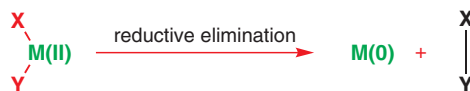

The ligands to be eliminated must be *cis* to one another for reductive elimination to occur. This is because the process is concerted. Two examples from palladium chemistry make this point clear. Warming in DMSO causes ethane production from the first palladium complex because the two methyl groups are *cis* in the square planar complex. The more elaborate second bisphosphine forces the two methyl groups to be *trans* and reductive elimination does not occur under the same conditions.

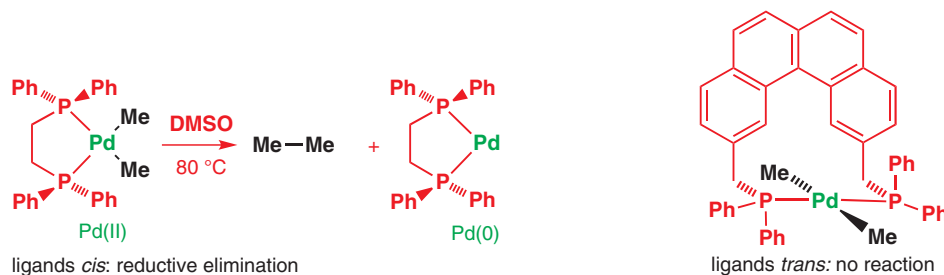

Of course, no one wants to make ethane that way (if at all) but many other pairs of ligands can be coupled by reductive elimination. Reductive elimination is one of the most important methods for the removal of a transition metal from a reaction sequence, leaving a neutral organic product. We will see many examples as the chapter develops but here is an indole synthesis that depends on a reductive elimination at palladium as a last step. In the starting material, palladium has two σ bonds sharing electrons with C, and is Pd(II). In the reaction the two C substituents bond together to form the indole ring and a Pd(0) species is eliminated.

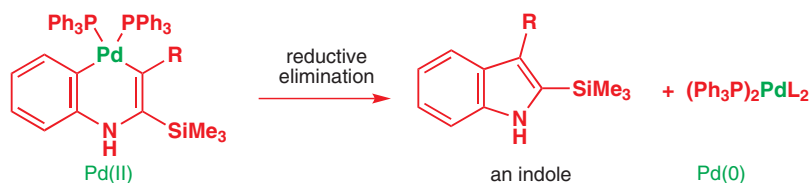

Migratory insertion builds ligand structure

Two ligands can also react together to produce a new complex that still has the composite ligand attached to the metal, ready for further modification. This process involves migration of one of the ligands from the metal to the other ligand, and insertion of one of the ligands into the other metal–ligand bond. It is known as **migratory insertion**. The insertion process is reversible and, as the metal effectively loses a ligand in the process, the overall insertion may be driven by the addition of extra external ligands (L) to produce a coordinatively saturated complex. As with reductive elimination, a *cis* arrangement of the ligands is required and the migrating group (X) retains its stereochemistry (if it has any) during the migration.

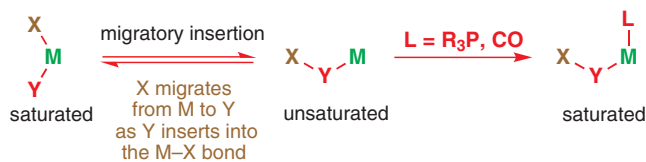

Wilkinson's catalyst is used in homogeneous hydrogenation of alkenes. The catalyst is soluble in many organic solvents such as EtOH, chloroform, or some hydrocarbons. The alkene complexes with the metal and migratory insertion forms an alkyl metal complex by hydrogen transfer. The next step, reductive elimination, usually follows rapidly to give the alkane and a complex that adds a hydrogen molecule to regenerate the catalyst.

L and L_n

We know that the Pd product here must carry more than just the two ligands it is left with after the reductive elimination, but the scheme we have here doesn't tell us what they are. It's quite conventional in such cases—where we are more interested in the structure of the organic product than the remains of the complex—to indicate a general metal ligand 'L', or 'L_n', for an undefined number of unknown ligands.

➔ Migration normally occurs with retention; see Chapter 36.

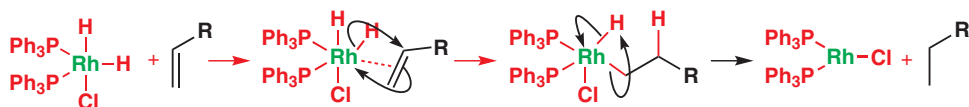

► Polymerization is covered in an additional chapter you will find online.

Migratory insertion is the principal way of building up the chain of an organic ligand before elimination. The group to be inserted must be unsaturated in order to accommodate the additional bonds and common examples include carbon monoxide, alkenes, and alkynes, producing metal-acyl, metal-alkyl, and metal-alkenyl complexes, respectively. In each case the insertion is driven by additional external ligands, which may be an increased pressure of carbon monoxide in the case of carbonylation or simply excess phosphine for alkene and alkyne insertions. In principle, the chain extension process can be repeated indefinitely to produce polymers by Ziegler–Natta polymerization.

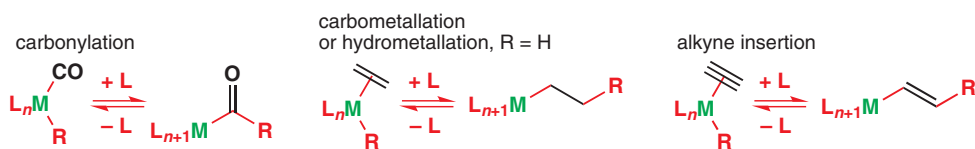

An example of the carbonylation process is the reaction of the tetracarbonyl ferrate dianion $[\text{Fe}(\text{CO})_4]^{2-}$ with alkyl halides. This reagent is made by dissolving metal reduction of the 18-electron $\text{Fe}(0)$ compound $\text{Fe}(\text{CO})_5$. Addition of two electrons would give an unstable 20-electron species but the loss of one of the ligands with its two electrons restores the stable 18-electron structure.

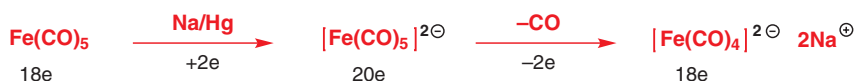

This iron anion is a good soft nucleophile for alkyl halides and can be used twice over to produce first a monoanion with one alkyl group and then a neutral complex with two alkyl groups and four CO ligands. Each of these complexes has 18 electrons. If extra CO is added by increasing the pressure, CO inserts into one $\text{Fe}-\text{C}$ bond to form an iron acyl complex. Finally, reductive elimination couples the acyl group to the other alkyl group in a conceptually simple ketone synthesis. It does not matter which $\text{Fe}-\text{C}$ bond accepts the CO molecule: the same unsymmetrical ketone is produced at the end.

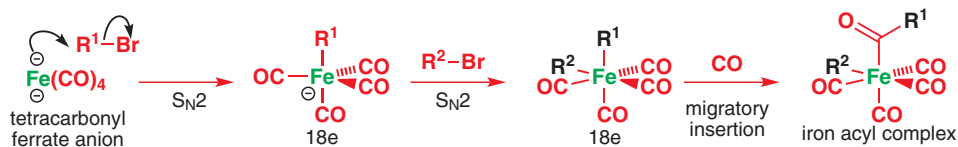

Any good two-electron ligand will cause the CO insertion: Ph_3P is often used instead of an increased CO pressure. The phosphine adds to the iron and pushes out the poorest ligand (one of the alkyl groups) on to a CO ligand in a process of **ligand migration**. We can represent this as the mechanism below, although the phosphine addition and alkyl migration may well be concerted to avoid the formation of a 20-electron complex as an intermediate.





Carbon monoxide incorporation extends the carbon chain

Carbonylation (the addition of carbon monoxide to organic molecules) is an important industrial process as carbon monoxide is a convenient one-carbon feedstock and the resulting metal–acyl complexes can be converted into aldehydes, acids, and their derivatives. The **OXO process** is the hydroformylation of alkenes such as propene and uses two migratory insertions to make higher value aldehydes. Although a mixture is formed, this is acceptable from very cheap and abundant starting materials. Here the metal complex is a catalyst, not a stoichiometric reagent.

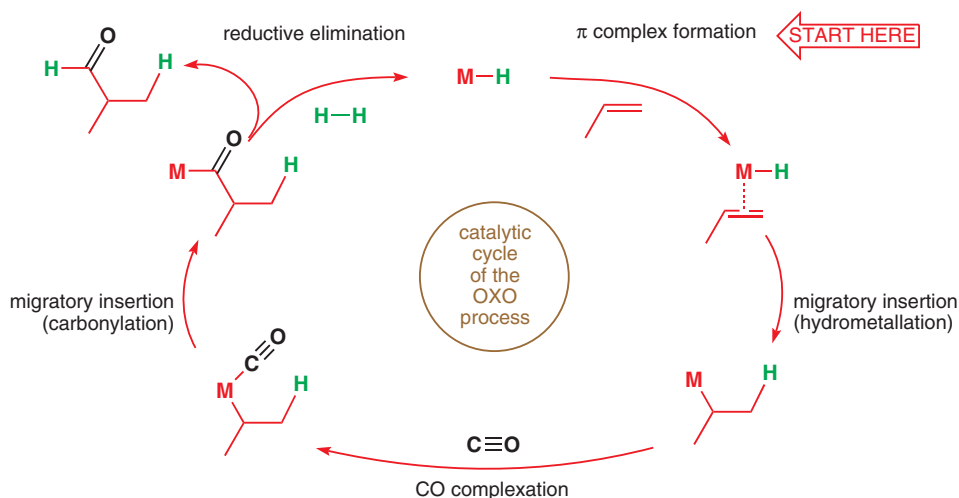

A catalytic cycle (going clockwise from the top) shows the various stages of alkene coordination, hydrometallation (migratory insertion) to produce an alkyl metal species, coordination of carbon monoxide followed by another migratory insertion, and finally reductive cleavage with hydrogen to produce the metal–hydride intermediate, which is then ready for another cycle. The steps leading to the other regioisomeric aldehyde and the ligands on the metal are omitted for clarity.



 Interactive mechanism for the OXO process

The mechanisms of the two key migratory insertion steps are worth discussion. **Hydrometallation** occurs by initial π complex formation followed by addition of the metal to one end of the alkene and hydrogen to the other. Both of the possible regioisomers are formed. The **carbonyl insertion reaction** is another migration from the metal to the carbon atom of a CO ligand.

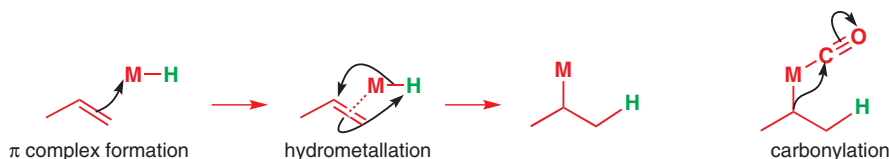

Insertion reactions are reversible

The reverse process, **decarbonylation**, is also fast but can be arrested by maintaining a pressure of carbon monoxide above the reaction mixture. The reverse of hydrometallation involves the elimination of a hydride from the adjacent carbon of a metal alkyl to form an alkene complex.

This process is known as β **hydride elimination** or simply β **elimination**. It requires a vacant site on the metal as the number of ligands increases in the process and so is favoured by the shortage of ligands in 16-electron complexes. In more complex structures, the metal and the hydride must be *syn* to each other on the carbon chain for the elimination to be possible. The product is an alkene complex that can lose the neutral alkene simply by ligand exchange. β elimination is an important final step in a number of transition-metal catalysed processes, but it can be a nuisance because Pd–Et (and other similar Pd–alkyl) complexes cannot be used as β elimination is too fast.

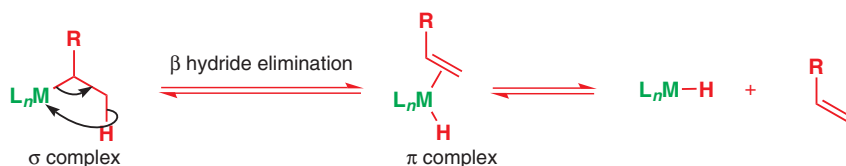

Palladium is the most widely used metal in homogeneous catalysis

These elementary steps form the basis for most of organo-transition metal chemistry, and are the same regardless of the metal and the detailed structure of the ligands. Transition metal catalysis is an enormous and rapidly expanding field that we just do not have the space to discuss in comprehensive detail. Instead, we will concentrate on the chemistry of one important, and representative, transition metal: palladium. Pd-catalysed reactions are widely used in both industrial and academic laboratories, on both a minute and very large scale. The variety of reactions that can be catalysed by Pd together with the range of functional groups tolerated, and usually excellent chemo- and regioselectivity, means that most syntheses of organic molecules of any complexity will now involve palladium chemistry in one or more key steps.

Choice of palladium complex

There are many available complexes of palladium(0) and palladium(II). Tetrakis(triphenylphosphine)palladium(0), $Pd(PPh_3)_4$, and tris(dibenzylidene-acetone)dipalladium(0), $Pd_2(dba)_3$, or the chloroform complex, $Pd_2(dba)_3 \cdot CHCl_3$, which is air-stable, are the most common sources of palladium(0). The detailed structures of some palladium complexes, particularly the dimers, are beyond the scope of this book but we will discuss the reactions in detail. Palladium(II) complexes are generally more stable than their palladium(0) counterparts. The dichloride $PdCl_2$ exists as a polymer and is relatively insoluble in most organic solvents. However, $(PhCN)_2PdCl_2$ and $(MeCN)_2PdCl_2$ (both easily prepared from $PdCl_2$) are soluble forms of $PdCl_2$, as the nitrile ligands are readily displaced in solution. Bis(phosphine)palladium(II) chloride complexes are also air-stable and readily prepared from $PdCl_2$. Palladium is, of course, an expensive metal—these complexes cost about £50–100 per gram—but very little is needed for a catalytic reaction.

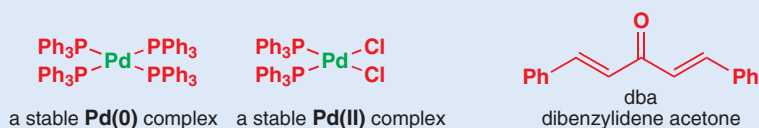

Let's start with a review of the basic chemistry of palladium, as you will be seeing many more examples of these steps in specialized situations. Palladium chemistry is dominated by two oxidation states. The lower, palladium(0), present in tetrakis(triphenylphosphine)palladium, for example, is nominally electron-rich, and will undergo oxidative addition with suitable substrates such as organic halides, resulting in a palladium(II) complex. Oxidative addition is thought to occur on the coordinatively unsaturated 14-electron species, formed by ligand dissociation in solution.



The resulting Pd–R σ bond in such complexes is very reactive, especially towards carbon–carbon π bonds. Thus an alkene in the reacting system will lead to coordination followed by migratory insertion into the palladium–carbon σ bond. Like hydrometallation this process is a migratory insertion and is called **carbopalladation** because carbon and palladium become attached to the ends of the alkene system. There is no change in oxidation state during this process, although the ligands (often phosphines) must dissociate to allow coordination of the alkene and associate to provide a stable final 16-electron product.

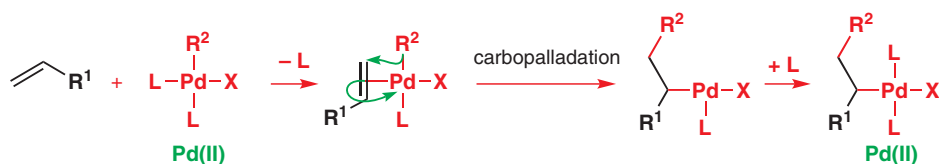

With some metals the process of olefin coordination and insertion may continue, leading to polymerization, but with palladium the metal is expelled from the molecule by a β -hydride elimination reaction and the product is an alkene, plus a Pd(II) complex. For the whole process to be catalytic, this Pd(II) product of β -hydride elimination must be converted to a Pd(0). This occurs in the presence of base, which removes HX from the palladium(II) species. This is another example of reductive elimination: one that forms a hydrogen halide rather than a carbon–carbon or carbon–hydrogen bond, as you saw earlier.

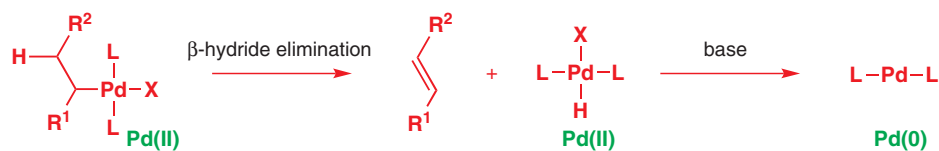

The speed of the β -hydride elimination (which is intramolecular and very fast) means that the original substrate for the oxidative addition reaction must be chosen with care—the presence of hydrogen at an sp^3 carbon in the β position must be avoided. Thus, substrates for oxidative addition reactions in palladium chemistry are frequently vinylic, allylic, or aromatic and never ethyl or *n*-propyl.

The Heck reaction couples together an organic halide or triflate and an alkene

All the individual steps outlined above combine to make up the catalytic pathway in the **Heck reaction** with which we started the chapter. The Heck reaction couples an alkene with an organic halide or triflate $\text{R}^1\text{-X}$ to form a new alkene. The R^1 group in $\text{R}^1\text{-X}$ can be aryl, vinyl, or any alkyl group without β hydrogens on an sp^3 carbon atom. The group X can be a halogen (Br or I) or triflate (OSO_2CF_3). The alkene can be mono- or disubstituted and can be electron-rich, -poor, or -neutral. The base need not be at all strong and can be Et_3N , NaOAc , or aqueous Na_2CO_3 . The reaction is very accommodating!

Triflates

The triflate (trifluoromethanesulfonate) anion, CF_3SO_3^- , or TfO^- , is an excellent, non-basic leaving group. It is often used as an oxygen-based alternative to halides, and metals will insert into the C– OSO_2CF_3 bond. Triflates, particularly aryl and vinyl triflates, can be made conveniently with Comins' reagent.

Comins' reagent

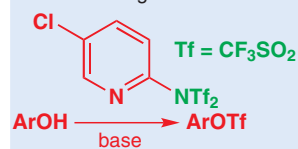

Interactive mechanism for the Heck catalytic cycle

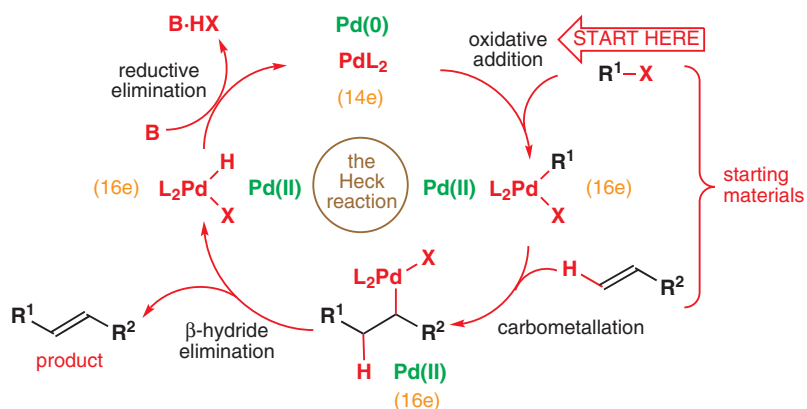

This palladium-catalysed addition of aryl, vinyl, or substituted vinyl groups to organic halides or triflates is one of the most synthetically useful palladium-catalysed reactions. The method is very efficient, and carries out a transformation that is difficult by more traditional techniques. The mechanism involves the oxidative addition of the halide, insertion of the olefin, and elimination of the product by a β -hydride elimination process. A base then regenerates the palladium(0) catalyst. The whole process is a catalytic cycle.

Here is the Heck reaction at work coupling two heterocyclic substrates. Easy chemistry to do, but impossible without a Pd catalyst.

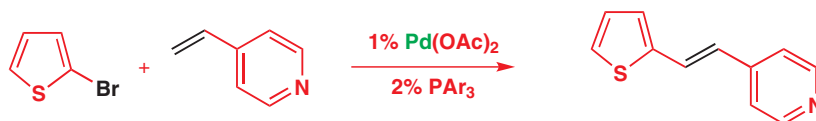

Notice the regioselectivity: unlike the carbonylation on p. 1077, the Heck reaction favours one isomer, and when the alkene is polarized by an electron-withdrawing group the new C–C bond forms at the other end of the alkene. Notice also in this example and those below that the Pd is added as Pd(II), not Pd(0): the box below explains how this works.

The mild conditions of the Heck reaction mean that protected amino acids can be made without any racemization. The two examples below use a more hindered analogue of triphenylphosphine, but the mechanism is the same.

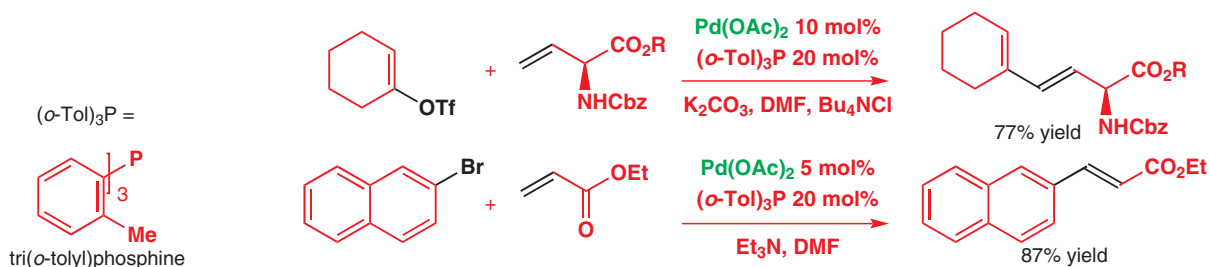

In situ formation of Pd(0) by reduction of Pd(II)

In reactions requiring palladium(0), formation of the active complex may be achieved more conveniently by reduction of a palladium(II) complex, for example Pd(OAc)₂. Any phosphine may then be used in the reaction, without the need to synthesize and isolate the corresponding palladium(0)–phosphine complex. The reduction of palladium(II) to palladium(0) can be achieved with amines, phosphines, alkenes, and organometallics such as DIBAL-H, butyllithium, or trialkylaluminium. The mechanisms are worth surveying as they illustrate the basic steps of organometallic chemistry.

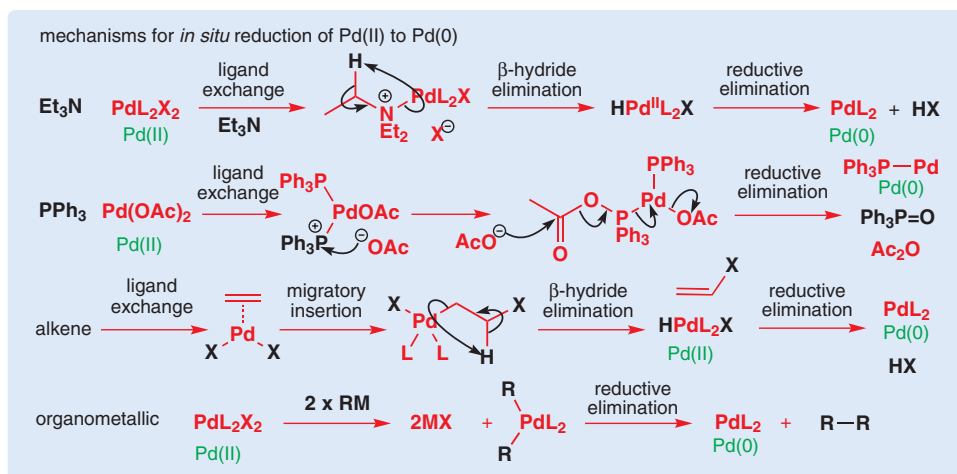

In contrast, electron-donating groups such as ethers lead to attack at the end of the alkene substituted by oxygen to produce the 1,1-disubstituted product. These reactions must be dominated by the interaction of the filled π orbital of the alkene with an empty d orbital on Pd. In the example below, the Heck reaction works even in the absence of a phosphine ligand.

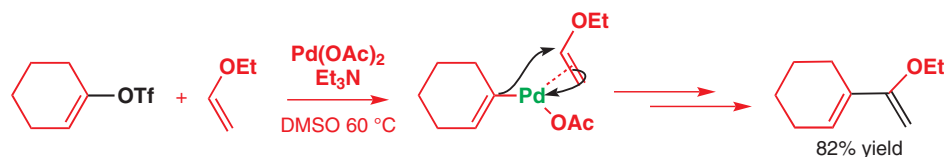

Because β -hydride elimination is reversible, when there is a choice the more stable of the possible alkenes usually results. The reaction of allylic alcohols is particularly important as the more stable of the two alkenes is the enol and a carbonyl compound is formed.

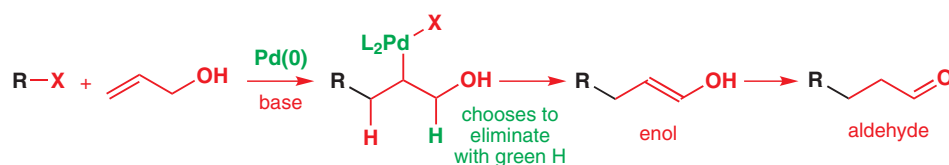

Hydropalladation–dehydropalladation can lead to alkene isomerization

Reversible β -hydride eliminations provide a mechanism for interconverting regioisomers of an alkene, and the following reaction sequence also illustrates another point about the reductive elimination step: it is a *syn* elimination, and the C–Pd and C–H bonds have to eclipse one another for the Pd–H bond to form. Oxidative addition of the aryl iodide to a palladium(0) complex, formed from Pd(OAc)₂ by reduction, gives the active palladium(II) complex ArPdOAcL₂. Carbopalladation occurs as expected on an electron-rich alkene to give the product of aryl addition to the oxygen end of the alkene in a *syn* fashion. β -Hydride elimination must occur away from the aryl group because there is only one C–H bond *syn* to the C–Pd bond. The alkene has moved one position round the ring.

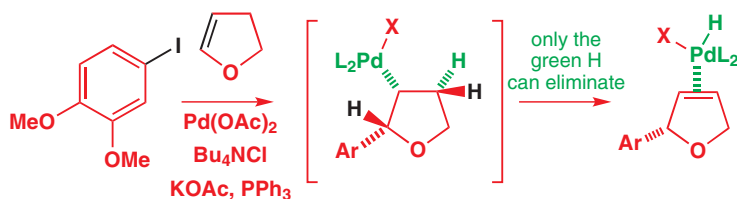

Hydropalladation in the reverse sense gives a new σ complex, which could eliminate either the black or the green hydrogens. Elimination of the green H gives the enol ether, which is the most stable alkene possible due to conjugation.

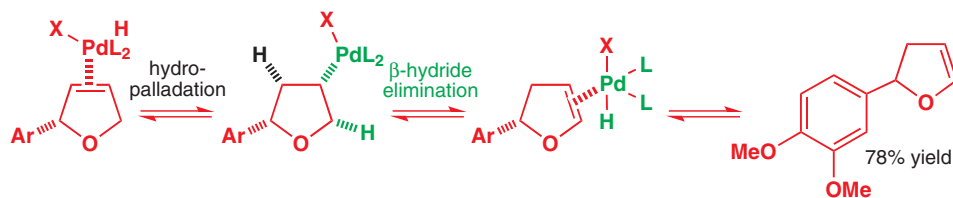

This product now undergoes a second Heck reaction involving naphthyl iodide:

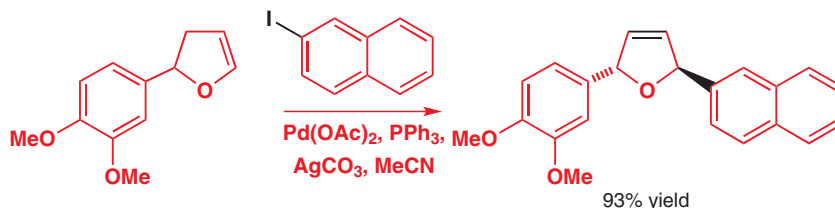

The initial mechanism is much the same. However, the enol ether has two diastereotopic faces: *syn* or *anti* to the aromatic substituent (Ar^1) introduced in the first step. Palladium is very sensitive to steric effects and generally forms less hindered complexes where possible, so the palladium(II) complexes the face of the enol ether *anti* to Ar^1 . This in turn controls all the subsequent steps, which must be *syn*, leading to a final product with *anti* stereochemistry. The requirement for *syn* β -hydride elimination also explains the regiochemical preference of the elimination. In the σ -bonded cyclic structure there is only one hydrogen (green) that is *syn* to the palladium; the one on the carbon bearing the naphthyl substituent is *anti* and cannot be eliminated. Further migrations of the alkene by hydropalladation are prevented by the silver carbonate, which rapidly removes iodide from the intermediate, preventing readdition of Pd–H to the alkene.

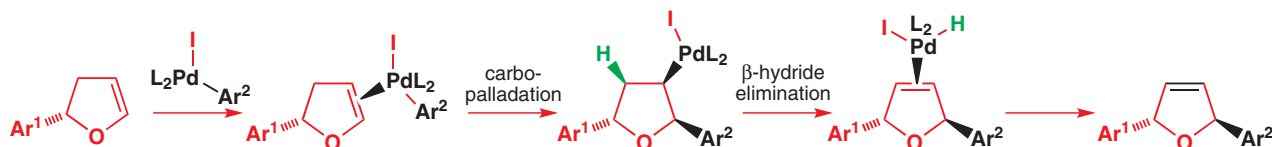

Cross-coupling of organometallics and halides

Other than β -hydride elimination, another important pathway by which palladium(II) intermediates can lead to neutral organic fragments is reductive elimination. This forms the basis of the mechanism for **cross-coupling reactions** between an organometallic reagent and an organic halide or triflate.

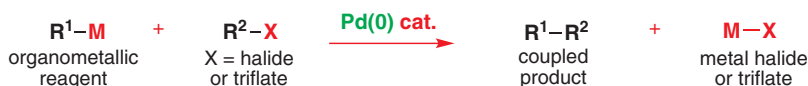

This is a reaction that seems very attractive for synthesis but, in the absence of a transition metal catalyst, the yields are very low. We showed in Chapter 27 how vinyl silanes can be made with control over stereochemistry and converted into lithium derivatives with retention. Neither of these vinyl metals couple with vinyl halides alone. But in the presence of a transition metal—Cu(I) for Li and Pd(0) for Sn—coupling occurs stereospecifically and in good yield.

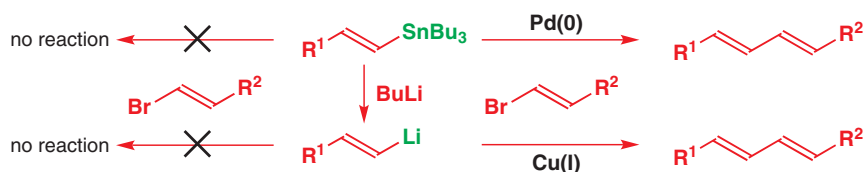

The mechanism of palladium-catalysed cross-coupling starts, as in the Heck reaction, with oxidative addition of the halide or triflate to the initial palladium(0) phosphine complex to form a palladium(II) species. But the next step is new: it is a **transmetallation**, so-called because the nucleophile (R^1) is transferred from the metal in the organometallic reagent to the palladium and the counterion (X =halide or triflate) moves in the opposite direction. The new palladium(II) complex with two organic ligands undergoes reductive elimination to give the coupled product and the palladium(0) catalyst, ready for another cycle.

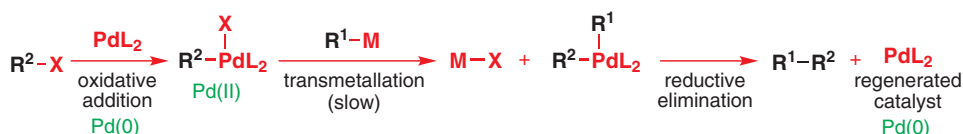

The reaction is important because it allows the coupling of two different components (R^1 and R^2), distinguished by being bonded either to the metal M or to the halide or triflate X . Both components form σ complexes with Pd but the halide partner (R^2X) bonds first by oxidative addition and this R^2-Pd bond must survive while the metal partner (R^1M) transfers R^1 to Pd by transmetallation. Once the two components are joined to the palladium atom, only the cross-coupled product can be formed. R^2X combines with $Pd(0)$ and R^1M with $Pd(II)$. There can then be no confusion. In contrast to the Heck reaction, here the metal defines the location of the new $C-Pd$ bond.

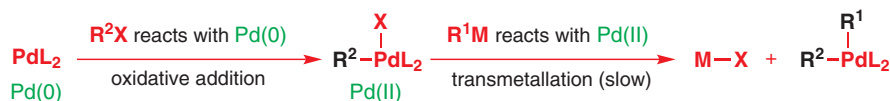

The halide partner (R^2X) must be chosen with care, as β -hydride elimination would decompose the first intermediate during the slow transmetallation step. The choice for R^2 is restricted to substituents without β -hydrogen atoms on sp^3 carbon atoms: vinyl, allyl, benzyl, and polyfluoroalkyl halides, triflates, and phosphates have all been coupled successfully. The organometallic reagent (R^1M) can be based on magnesium, zinc, copper, tin, silicon, zirconium, aluminium, or boron and the organic fragment can have a wide variety of structures as coupling is faster than β -hydride elimination.

R^1-M R^1 = almost anything including examples with β H

$M = MgX, ZnX, Cu, SnR_3, SiR_3, ZrCp_2Cl, AlMe_2, B(OR)_2, BF_4^-$

Cp = cyclopentadienyl

R^2-X R^2 must not have β Hs that can eliminate $X = I, Br, (Cl), OTf, OPO(OR)_2$

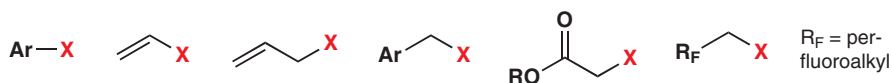

R_F = perfluoroalkyl

The difference in relative reactivity of aromatic iodides and triflates was exploited in this sequential synthesis of substituted terphenyls by repeated coupling with organozinc reagents. The more reactive iodide coupled at room temperature with palladium(0) and trifurylphosphine but warming to $65^\circ C$ was required for the triflate to participate in the second coupling.

■ There is a problem in naming the two partners. The halide partner (R^2X) is sometimes called the electrophile and the organometallic partner (R^1M) the nucleophile. These names describe the nature of the reagents rather than the mechanism of the reaction and we will not use them.

Named coupling reactions

Palladium-catalysed reactions involving organometallic partners based on B, Mg, Sn, and Zn are particularly important and are often referred to by the names of their discoverers: Suzuki coupling for B, Kumada coupling for Mg, Stille coupling for Sn, and Negishi coupling for Zn.

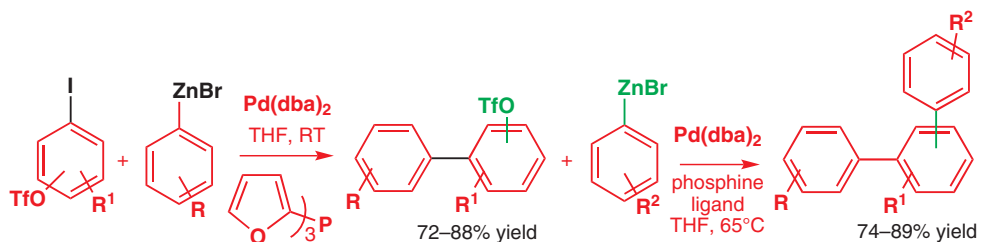

Organometallic Nobels

Organometallic chemistry has been a popular subject for the Nobel prize committee. In 1912 Grignard (Mg) won the award, in 1973 Wilkinson and Fischer for 'sandwich' compounds (such as ferrocene), in 2005 Chauvin, Grubbs, and Schrock for alkene metathesis, and in 2010 Heck, Negishi, and Suzuki (Stille had died in 1989) for transition-metal catalysed couplings.

In the reactions of triflates, a source of halide (typically LiCl) is generally required since triflate is a counterion and may not bind to the metal as a ligand: chloride can take its place.

In spite of the wide range of organometallic reagents that can be used there are two classes that have proved particularly popular because they are stable intermediates in their own right and can be prepared and purified separately before the coupling reaction. These cross-couplings are known by the names of the two chemists whose work made the reactions so valuable. The Stille coupling employs a stannane as the organometallic component (R^1M) while the Suzuki coupling relies on a boronic acid.

The Stille coupling uses stannanes as the organometallic component

Since its discovery in the late 1970s, the Stille coupling has been widely used for the coupling of both aromatic and vinylic systems.

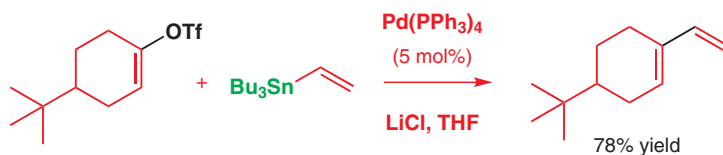

The mechanism involves the oxidative addition of the vinyl or aromatic triflate or halide to give an organopalladium intermediate. Transmetalation with the organostannane forms another organopalladium intermediate with two Pd–C σ bonds. A reductive elimination step releases the product and thereby regenerates the palladium(0) catalyst. Vinyl triflates can be made from enolizable aldehydes or ketones and aryl triflates from phenols, but the reaction also works with vinyl and aryl halides.

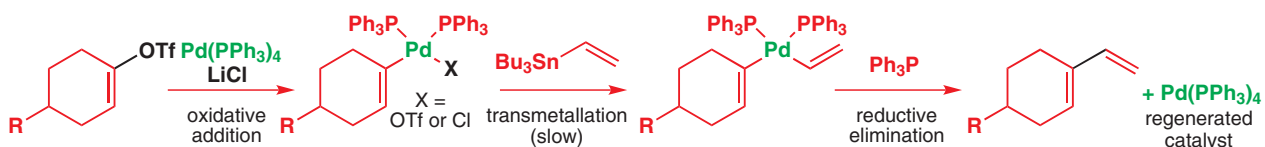

Interactive mechanism for the Stille coupling catalytic cycle

The Stille reaction is widely used to make bonds between sp^2 carbon atoms, but it also works with sp carbons: the example below is a challenging formation of a 10-membered ring containing two alkynes.

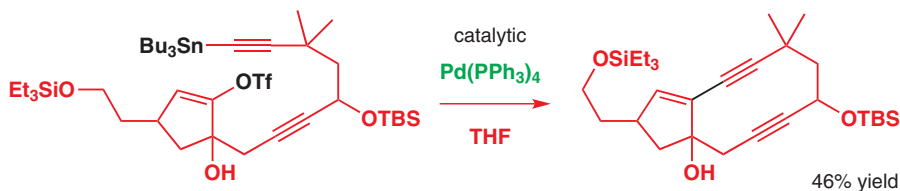

The Stille coupling may be combined with carbonylation in two ways. Acid chlorides may be used as substrates for the reaction with vinyl or aryl stannanes, although an atmosphere of carbon monoxide is frequently required to prevent decarbonylation after the oxidative addition step.

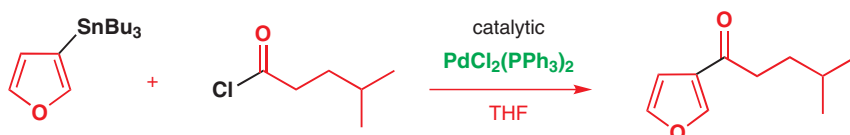

Simply performing a normal Stille reaction in the presence of carbon monoxide may also lead to carbonylated products. These reactions can take place in a CO saturated solution, under one atmosphere of pressure. Using these conditions, excellent yields of the carbonylated product can be obtained, without any of the normal coupling product being present.

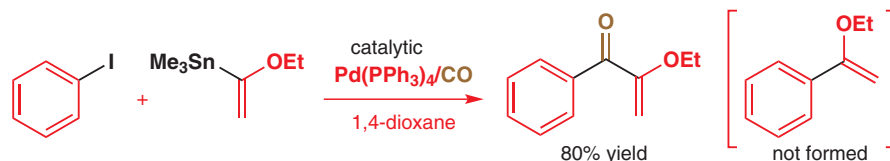

The mechanism follows that of a normal Stille coupling except that the carbon monoxide first exchanges for one of the phosphine ligands and then very rapidly inserts to produce an acyl palladium(II) complex. Transmetalation with the vinyl stannane in the usual way forms trimethylstannyl iodide and the key palladium complex carrying two carbon ligands. Transmetalation is always the slow step in these coupling reactions, allowing time for the carbon monoxide insertion. The final step—reductive elimination—releases the Pd(0) catalyst for the next cycle.

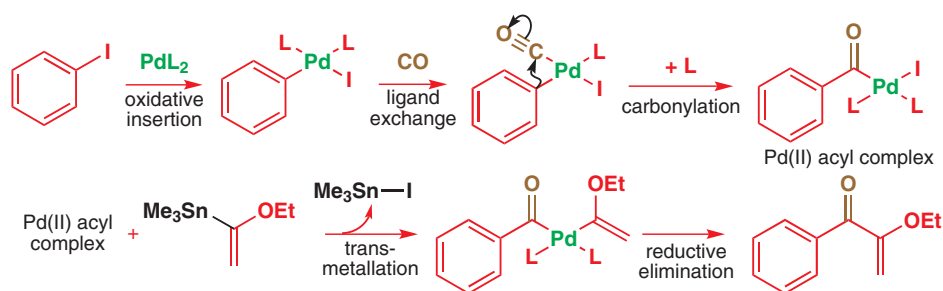

Interactive mechanism for the carbonylative Stille coupling catalytic cycle

Acyl palladium species react like activated acid derivatives

Carbonylation of a halide or triflate provides a direct route to a range of chain-extended acyl derivatives. A carbonyl group substituted with PdX (X = halide or triflate) is a reactive acylating agent, rather like an acid anhydride, as PdX is a good leaving group. Reaction with alcohols and amines gives esters and amides, while reduction with tributyltin hydride gives the aldehyde. Intramolecular attack by alcohols leads to lactones, as demonstrated in the conversion of a vinyl iodide into a 2H-furanone (butenolide). We will see more of these reactions later.

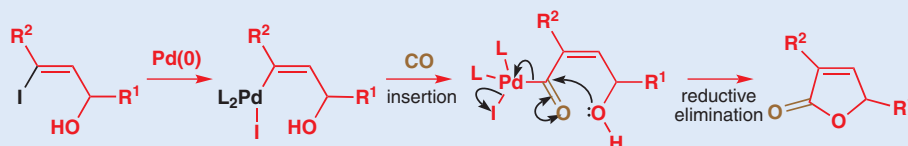

Interactive mechanism for palladium-catalysed carbonylative butenolide formation

The Suzuki coupling couples boronic acids to halides

The Suzuki coupling of a boronic acid or ester with a vinyl or aryl halide or triflate is probably the most commonly used of all cross-coupling reactions. The original version, first reported in 1979, involved hydroboration of an alkyne with catecholborane, followed by palladium(0)-catalysed coupling of the resulting vinyl boronate with an aromatic iodide or bromide. The hydroboration is generally regioselective for the less hindered position and addition of boron and hydrogen occurs *cis* stereospecifically.

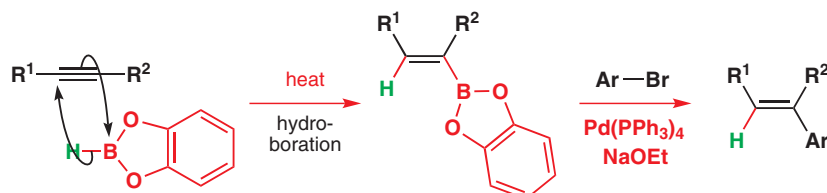

Hydroboration is covered in Chapter 19, p. 446.

➔ Some methods for the synthesis of alkenes with control of double bond geometry were covered in Chapter 27.

As in the Stille coupling, the geometry of both unsaturated components is preserved during the coupling so this is an excellent method for the stereoselective synthesis of dienes. Hydroboration of octyne followed by hydrolysis of the boronate gave exclusively the *E*-vinyl boronic acid. Coupling with the *Z*-vinyl bromide in toluene with palladium(0) catalysis with potassium hydroxide as the base gave the *E,Z*-diene in good yield. These dienes are very useful in the Diels–Alder reaction (Chapter 34).

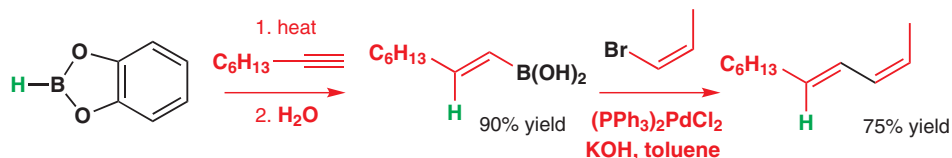

This sort of reaction has been used in the synthesis of the unsaturated units of a range of natural products, including trisporol B. The key step is the stereocontrolled synthesis of an *E,Z*-diene. The geometry of both double bonds comes stereospecifically with retention of configuration from single geometrical isomers of the starting materials.

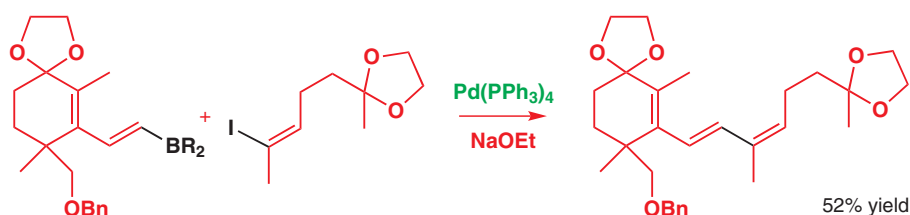

The mechanism of the Suzuki coupling is very similar to that of the Stille coupling. Oxidative addition of the vinylic or aromatic halide to the palladium(0) complex generates a palladium(II) intermediate. This then undergoes a transmetalation with the alkenyl boronate, from which the product is expelled by reductive elimination, regenerating the palladium(0) catalyst. The important difference is the transmetalation step, which explains the need for an additional base, usually sodium or potassium ethoxide or hydroxide, in the Suzuki coupling. The base accelerates the transmetalation step, leading to the borate directly, presumably via a more nucleophilic 'ate' complex.

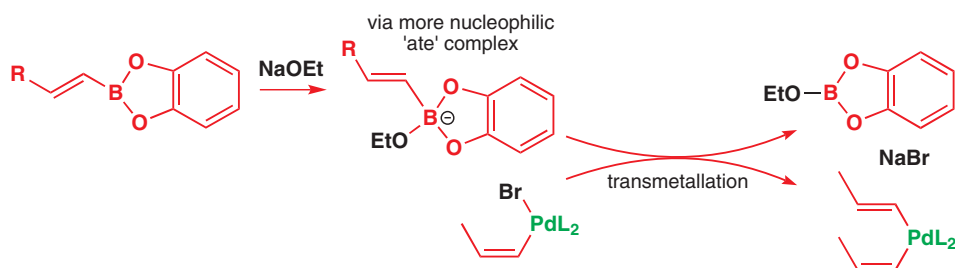

 Interactive mechanism for the Suzuki coupling catalytic cycle

Sterically demanding substrates are tolerated well and Suzuki coupling is often used for aryl–aryl cross-couplings. This example has three *ortho* substituents around the newly formed bond (marked in black) and still goes in excellent yield.

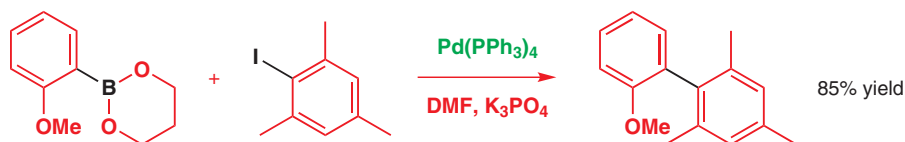

Aromatic heterocycles also couple well. The 2-position of a pyridine is very electrophilic and not at all nucleophilic (Chapter 29) but couplings at this position are fine with either the

halide or the boronic acid in that position. Clearly, it is a mistake to see either of these substituents as contributing a ‘nucleophilic carbon’. It is better to see the reaction as a coupling of two equal partners with the two substituents (the halide and the boronic acid) as control elements to ensure cross-coupling and prevent dimerization.

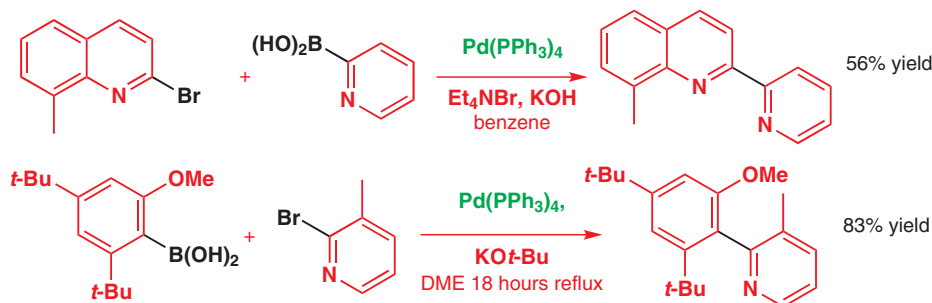

Coupling to alkynes: the Sonogashira reaction

The coupling of terminal alkynes with aryl or vinyl halides under palladium catalysis is known as the **Sonogashira reaction** and is rather like the Heck reaction. It is a catalytic process, requiring a palladium(0) complex; it is performed in the presence of base, and generally uses copper iodide as a co-catalyst. One partner—the aryl or vinyl halide—is the same as in the Stille and Suzuki couplings but the alkyne needs no metal to activate it: the reaction works with the alkyne itself.

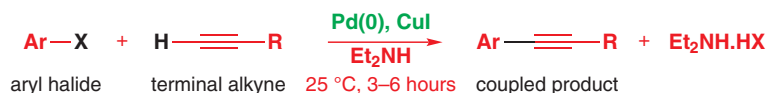

The mild conditions usually employed, frequently room temperature, mean that the reaction can be used with thermally sensitive substrates. By now, you should not be surprised by the mechanism! Oxidative addition of the organic halide gives a palladium(II) intermediate that undergoes transmetalation with the alkynyl copper (generated from the terminal alkyne, base, and copper iodide). Reductive elimination with coupling of the two organic ligands gives the product and regenerates the palladium(0) catalyst.

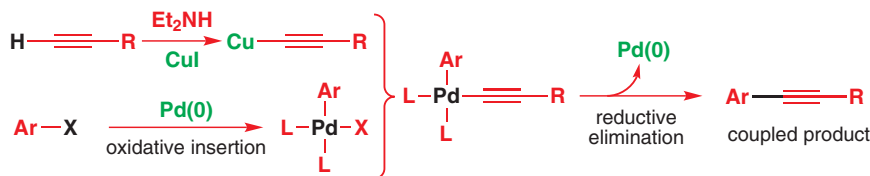

It is usually more convenient, as in the Heck reaction, to use a stable and soluble Pd(II) derivative such as bis(triphenylphosphine)palladium(II) chloride instead of Pd(0). This is rapidly reduced *in situ* to give a coordinatively unsaturated, catalytically active, palladium(0) species. The geometry of the alkene is generally preserved so that *cis* (*Z*) and *trans* (*E*) dichloroethylene give the two different geometrical isomers of the enyne below in >99% stereochemical purity as well as excellent yield.

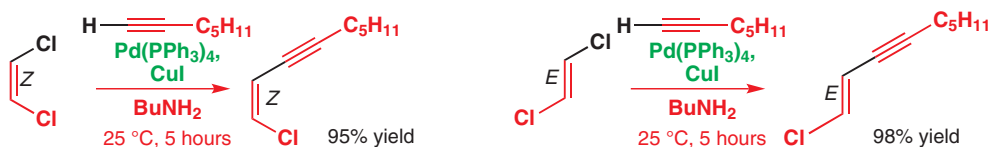

Ene-diynes and the Bergmann cyclization

The Sonogashira reaction provides an important way to make the ene-diyne antibiotics. Symmetrical ene-diynes may be synthesized in one step from two molecules of a terminal alkyne and Z-dihaloethylene. The ene-diyne part of the molecule does the remarkable Bergmann cyclization to give a benzene diradical: the ene-diyne is able to penetrate DNA and the diradical is able to react with it, giving the compounds anticancer activity. To make the most biologically active compounds, however, the reaction is performed sequentially, allowing different functionality on each of the alkyne units.

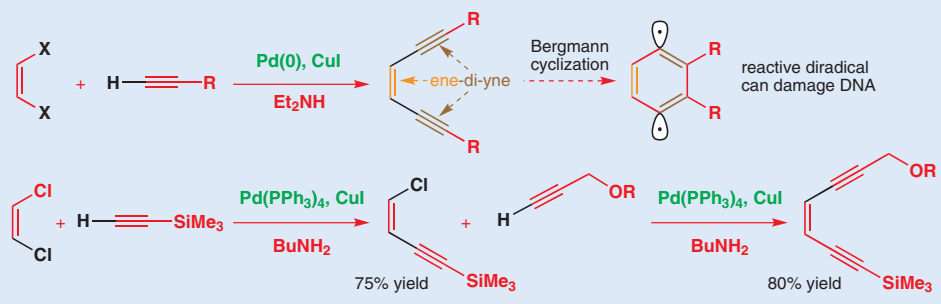

● Palladium-catalysed coupling reactions: a summary

Coupling an aryl or vinyl halide with...	Typical example (X=I, Br, OTf)	See page	Name of reaction
an alkene		1079	Heck
an aryl or vinyl stannane		1084	Stille
an aryl or vinylboronic acid or ester		1085	Suzuki
an alkyne		1087	Sonogashira
an amine		1092 (later in Buchwald-this chapter)	Hartwig

Allylic electrophiles are activated by palladium(0)

Allylic compounds with good leaving groups, such as bromide and iodide, are excellent allylating agents but they suffer from loss of regiochemistry due to competition between the direct S_N2 and S_N2' reactions. This problem was described in Chapter 24. In contrast, π-allyl

cation complexes of palladium allow both the stereochemistry and regiochemistry of nucleophilic displacement reactions to be controlled.



In addition, leaving groups (X) that are usually regarded as rather unreactive still work, which makes the purification and handling of the starting materials easier. Acetate (X=OAc) is the most commonly used leaving group, but a range of other functional groups (X=OCO₂R, OPO(OR)₂, Cl, Br, OPh) will perform a similar role. The full catalytic cycle is shown below, with the intermediate π -allyl complex in equilibrium between the neutral version, which has the leaving group coordinated to palladium, and the cationic π -allyl complex.

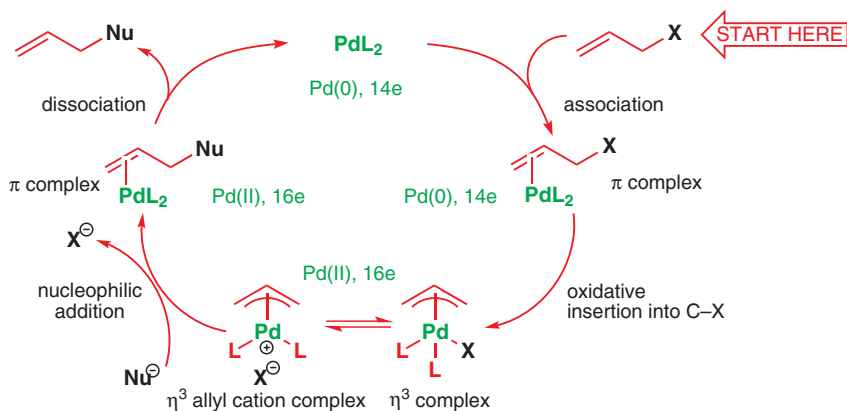

Soft nucleophiles generally give the best results: stabilized enolates such as malonates, or cyanide, are best for carbon–carbon bond formation, but for C–X (X=O, N, S) bond formation the reaction is successful with alkoxides, amines, and thiolates (RS[−]). In the example below an amine nucleophile attacks the allylic system to generate the more stable product with the double bond within the ring.

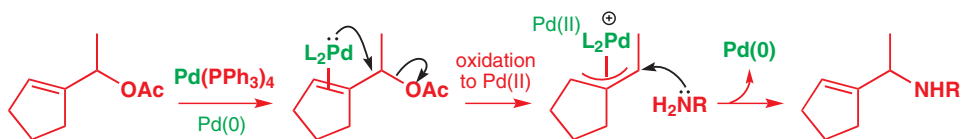

The intramolecular reaction works well to give heterocyclic rings—the regioselectivity is usually determined by the length of the chain and how far it can reach. Here a 6/5 fused product is preferred to a bridged product containing two seven-membered rings.

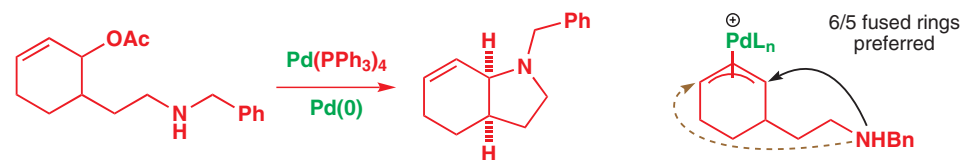

The reaction usually proceeds with *retention* of configuration at the reacting centre. As in S_N2 substitution reactions going with retention (Chapter 36), this actually suggests a double inversion. Coordination of Pd to the double bond of the allylic acetate occurs on the less hindered face opposite the leaving group and we can think of the oxidative addition step as an invertive nucleophilic displacement of the leaving group by a pair of Pd electrons. The nucleophile then adds to the face of the π -allyl Pd cation complex opposite the Pd. The net result is displacement of the leaving group by the nucleophile with retention. Thereafter, the

The Pd π -allyl cation complex

You can represent the palladium π -allyl cation complex in two ways. Either you draw a neutral allyl group complexed to Pd⁺ or you draw an allyl cation complexed to neutral Pd. Although the counting is different (Pd⁺ has only nine electrons: the neutral allyl has three, but the allyl cation only two), both come out as η^3 16-electron species, which is just as well as they are merely different ways of drawing the same thing.

Pd π -allyl cation complex

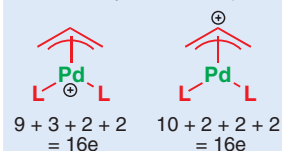

Interactive mechanism for the π -allyl palladium-mediated coupling catalytic cycle

■ The arrows on the middle two diagrams are the best we can do to show how Pd(0) uses its electrons to get rid of the leaving group to become Pd(II), and how it accepts them back again when the nucleophile adds. They are not perfect: it is often difficult to draw precise arrows for organometallic mechanisms, but it is worth thinking about what is happening to the electrons in these steps, and curly arrows help us to do this.

Meldrum's acid has a very stable delocalized enolate: it is as acidic as a carboxylic acid (pK_a 4.97) and the unusual stability of the enolate comes from the fixed conformation of the two carbonyl groups.

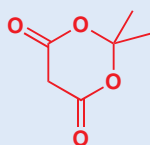

Meldrum's acid

■ For many of the remaining schemes in the chapter we will ignore the additional ligands at palladium for simplicity's sake.

Making vinyl epoxides

The synthesis of vinyl epoxides from dienes is mentioned in Chapter 19. The monoepoxide is formed first as the diene is more nucleophilic than the alkene in the monoepoxide. The main difficulty is that the monoepoxide rearranges with acid catalysis from the by-product, the carboxylic acid of the peroxyacid used in the epoxidation. The solution is simple: the mixture must be buffered to keep the acidity low.

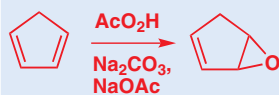

nucleophile attacks from the less hindered face of the resulting π -allyl complex (that is, away from the metal), leading to overall retention of configuration.

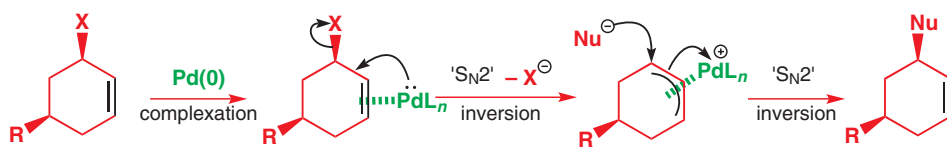

The reaction of this allylic acetate with the sodium salt of Meldrum's acid demonstrates the retention of configuration in the palladium(0)-catalysed process. The tetraacetate and the intermediate π -allyl complex are symmetrical, thus removing any ambiguity in the formation or reaction of the π -allyl complex and hence in the regiochemistry of the overall reaction.

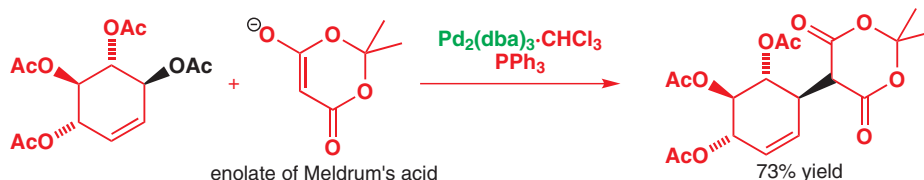

Vinyl epoxides provide their own alkoxide base

Vinyl epoxides and allylic carbonates are especially useful electrophiles because under the influence of palladium(0) they generate an alkoxide base, so no added base is required with these substrates. The overall reaction proceeds under almost neutral conditions—ideal with complex and sensitive substrates. The relief of strain in the three-membered ring drives the reaction with palladium(0) to produce the zwitterionic intermediate. Proton transfer activates the nucleophile, and attack at the less hindered end of the π -allyl palladium intermediate preferentially leads to overall 1,4-addition of NuH.

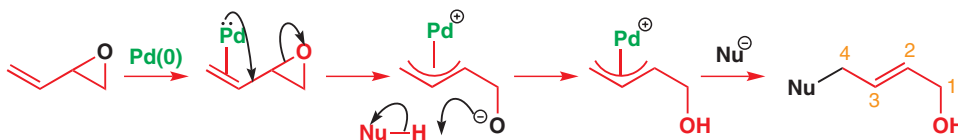

Retention of stereochemistry is demonstrated by the reaction of a substituted malonate with epoxycyclopentadiene. Palladium adds to the side opposite the epoxide so the nucleophile is forced to add from the same side as the OH group. This, no doubt, helps 1,4-regioselectivity.

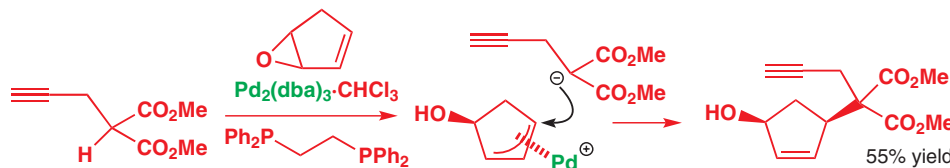

Allylic carbonates produce the required alkoxide by decarboxylation of the carbonate anion that is displaced in the formation of the π -allyl palladium intermediate. Deprotonation activates the nucleophile, which rapidly traps the π -allyl palladium complex to give the allylated product, regenerating the palladium(0) catalyst.

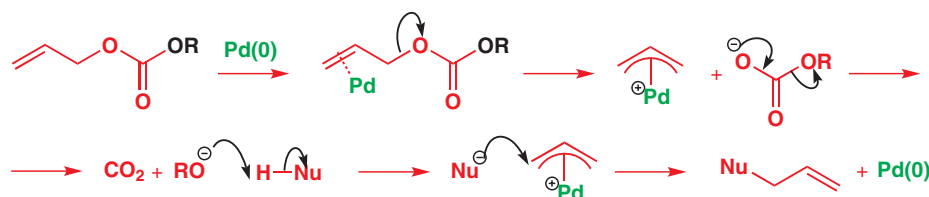

Trost and his group have used both of these palladium-catalysed alkylations in a synthesis of aristeromycin from epoxycyclopentadiene. The *cis* stereochemistry of this carbocyclic nucleotide analogue is of paramount importance and was completely controlled by retention of configuration in both substitutions.

The first reaction is between epoxycyclopentadiene and adenine, one of the heterocyclic building blocks of nucleic acids, and follows the mechanism we have just described to give a *cis*-1,4-disubstituted cyclopentene.

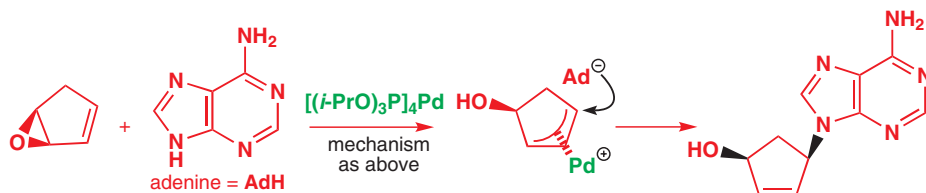
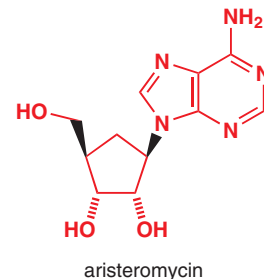

The alcohol is then activated by conversion into the carbonate, which reacts with phenylsulfonylnitromethane, and could later be converted into an alcohol. Once again, retention of stereochemistry during the palladium-catalysed substitution gives the *cis* product.

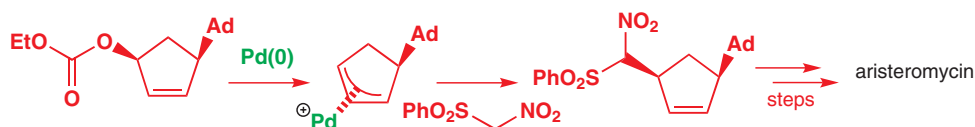

Intramolecular alkylations make rings

π -Allyl intermediates may also be used in cyclization reactions, including the synthesis of small and medium-sized rings using an intramolecular nucleophilic displacement. Three-membered rings form surprisingly easily, taking advantage of the fact that the leaving group can be remote from the nucleophile. The precursors can also be prepared by allylic alkylation. The sodium salts of malonate esters react with this monoacetate under palladium catalysis at the less hindered end to give the allylic alcohol.

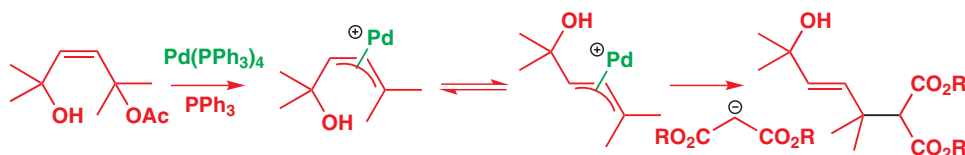

Acetylation activates the second alcohol to displacement so that the combination of sodium hydride as base and palladium(0) catalyst leads to cyclization to the cyclopropane.

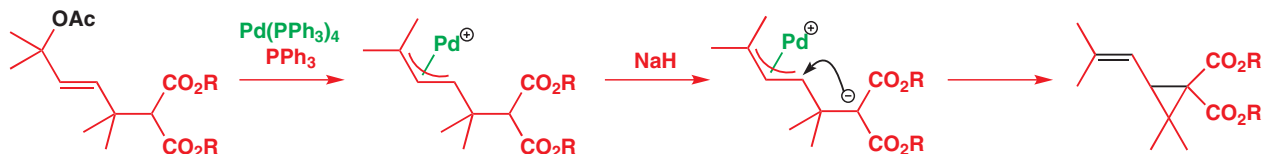

Palladium can catalyse cycloaddition reactions

The presence of five-membered rings such as cyclopentanes, cyclopentenes, and dihydrofurans in a wide range of target molecules has led to a variety of methods for their preparation. One of the most successful of these is the use of trimethylenemethane [3 + 2] cycloaddition, catalysed by palladium(0) complexes. The trimethylenemethane unit in these reactions is derived from 2-[(trimethylsilyl)methyl]-2-propen-1-yl acetate, which is at the same time an allyl silane and an allylic acetate. This makes it both a weak nucleophile and an electrophile in the presence of palladium(0). Formation of the palladium π -allyl complex is followed by removal of the trimethylsilyl group by nucleophilic attack of the

➔ Cycloadditions were described in Chapter 34.

resulting acetate ion, thus producing a zwitterionic palladium complex that can undergo cycloaddition reactions.

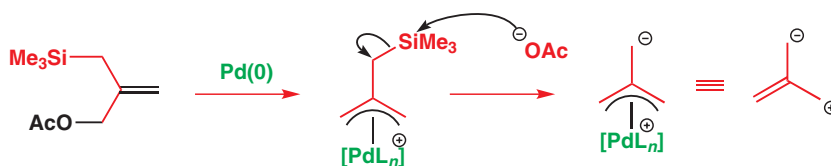

Trimethylenemethane

The symmetrical molecule with three CH_2 groups arranged trigonally about a carbon atom is interesting theoretically. It could have a singlet structure with two charges, both of which can be delocalized, but no neutral form can be drawn. Alternatively, it could be a triplet with the two unpaired electrons equally delocalized over the three CH_2 groups. This form is probably preferred and the singlet form is definitely known only as the palladium complex we are now describing. You might compare the singlet and triplet structures of trimethylenemethane with those of carbenes in Chapter 38.

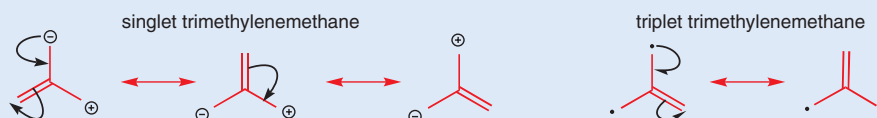

The normal way to do the cycloadditions is to react the complex with an alkene bearing electron-withdrawing substituents that make the substrate prone to Michael-type conjugate addition. Cyclopentenones illustrate the reaction nicely.

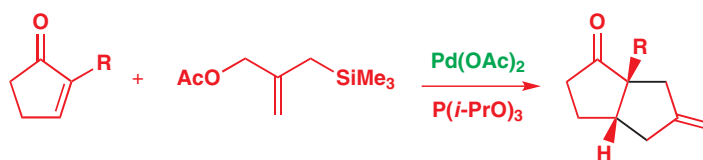

The mechanism is thought to be stepwise (in other words, not a real cycloaddition at all) with conjugate addition of the carbanion followed by attack of the resulting enolate on the π -allyl palladium unit to form a new five-membered ring having an *exo* methylene group.

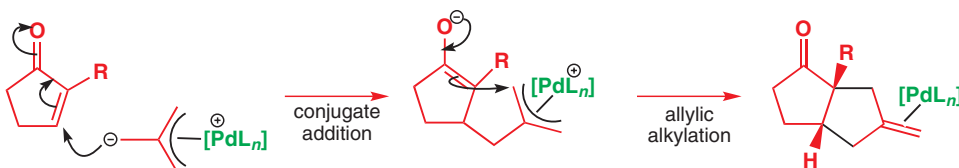

🖱 Interactive mechanism for the trimethylenemethane 'cycloaddition' catalytic cycle

Palladium-catalysed amination of aromatic rings

You've seen that palladium catalysis helps form carbon–carbon bonds that are difficult to make using conventional reactions. It can also help form carbon–heteroatom bonds that are difficult to make, and you have already seen some examples in the reactions of π -allyl complexes. Work starting in the 1990s by Buchwald and Hartwig has shown that Pd can be used to promote nucleophilic substitution at a vinylic or aromatic centre—a reaction which would not normally be possible. For example, aromatic amines can be prepared directly from the corresponding bromides, iodides, or triflates and the required amine in the presence of palladium(0) and a strong alkoxide base.

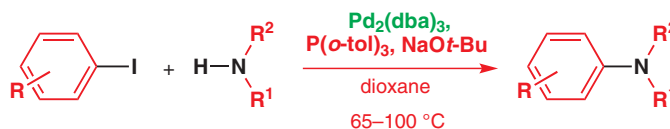

The mechanisms and catalysts used in this ‘Buchwald–Hartwig’ chemistry mirror those of coupling reactions involving oxidative addition, transmetalation, and reductive elimination. The first step, as usual, is oxidative insertion of Pd(0) into the aryl–halogen bond. The Pd(II) complex now adds the amine so that both coupling partners find themselves bonded to the same palladium atom. The base eliminates H–I from the complex and reductive elimination forms the Ar–N bond.

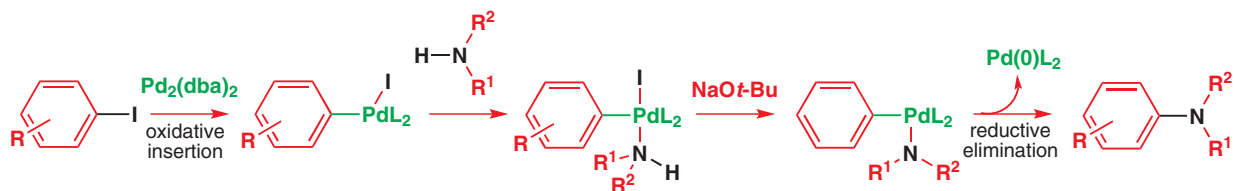

Various bases, such as *t*-BuONa, MeONa, LiN(TMS)₂, or K₂CO₃, have been successful and some of the most successful ligands (coordinating groups shown in brown) are shown below. The fourth structure is a preformed complex used in catalytic amounts.

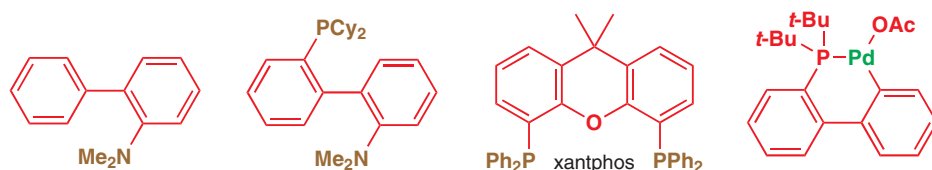

➔ If you are interested in reading more on the design and choice of these ligands, turn to the Further reading section at the end of the chapter.

The range of compounds which can be made is very great: both electron-withdrawing and electron-donating substituents are acceptable; hindered compounds or those with acidic hydrogens such as phenols are tolerated. Even aryl chlorides, which are much cheaper than bromides or iodides, can also be successful.

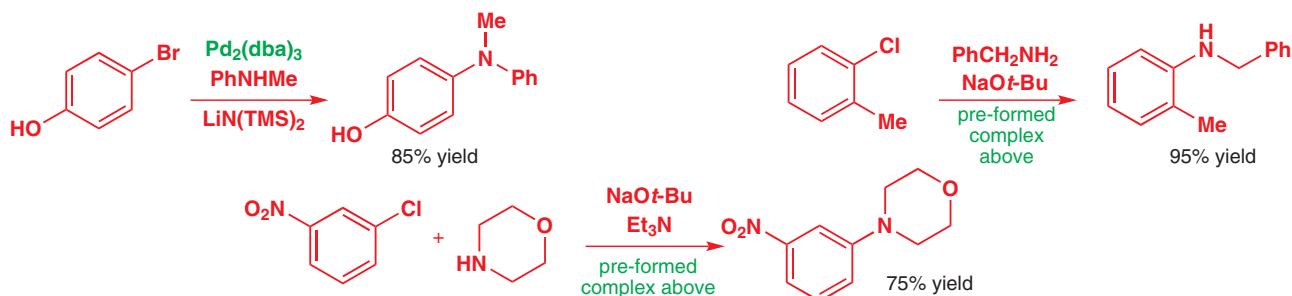

Aromatic heterocyclic halides also work well whether they are electron-deficient or electron-rich. These couplings use the more hindered ligand shown in the margin.

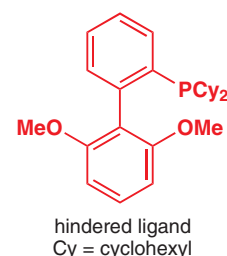
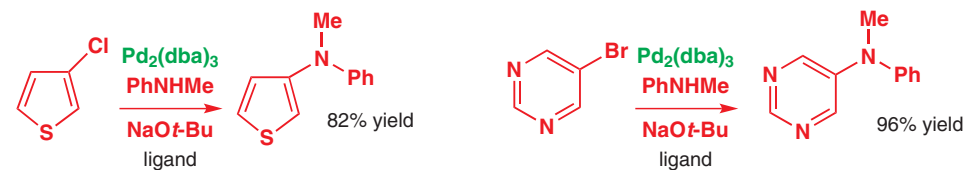

It is tempting to view the amine as the ‘nucleophile’ in these reactions but it is clear that nucleophilicity has little to do with it as amides also couple to aromatic rings under similar conditions. The ability to act as a ligand for palladium is the important thing. The ligand xantphos (see above) is used in these reactions and again the nature of the substituents on the benzene ring is of little account. Even strained azetidines react well.

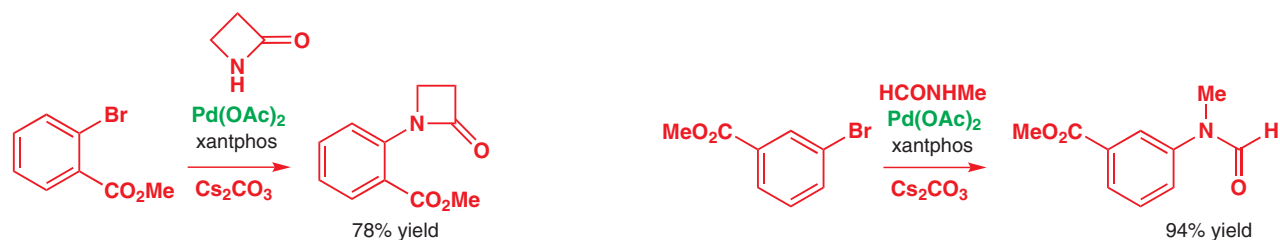

These reactions have been very widely used in the pharmaceutical industry in the making of medicinal compounds. When Sepracor wanted to make their anti-fungal compound itraconazole, it was obvious that they should make the two ends with stereochemistry and join them together with a central achiral section. Right in the middle is a piperazine ring joined to two different benzene rings, one connected through O and one through N. The C–N coupling chemistry of Buchwald and Hartwig could have been made for this problem.

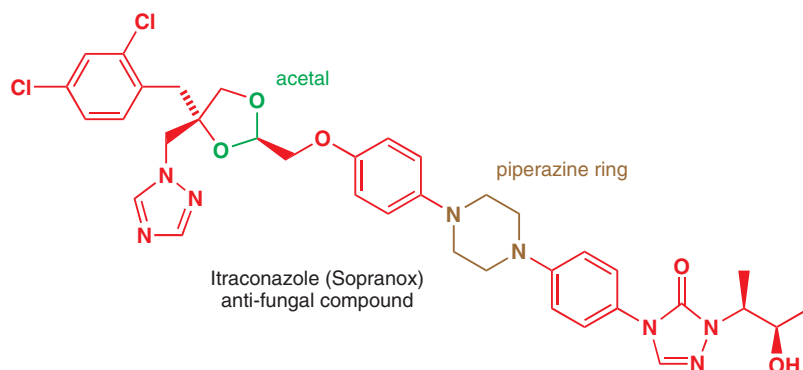

We have already seen that *p*-bromophenol can be joined to an amine with palladium catalysis, so it should be easy to join it to piperazine. However, there is a potential problem of selectivity: we want to add this benzene ring just once, and the way to do this is to protect one nitrogen atom by reductive amination with benzaldehyde. The remaining NH group can then be coupled to the aromatic ring and the benzyl group removed by hydrogenation.

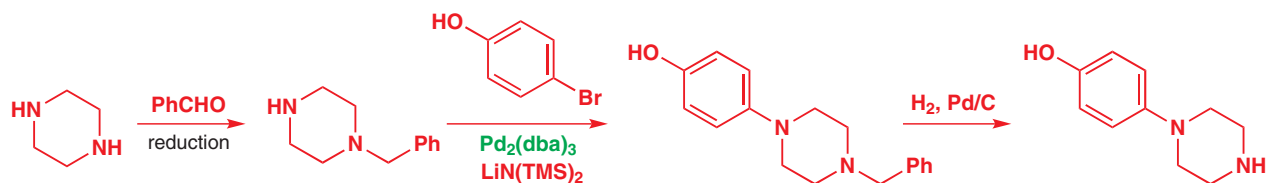

The workers at Sepracor then added the left-hand end of the molecule (we shall call this R¹) to the free OH group. The other aromatic ring, already functionalized with the right-hand end of the molecule (we shall call this R²) was coupled as its bromide to the free NH group by a second Buchwald–Hartwig amination reaction process. It's easy to see how this chemistry simplifies the assembly of such a large and complex molecule.

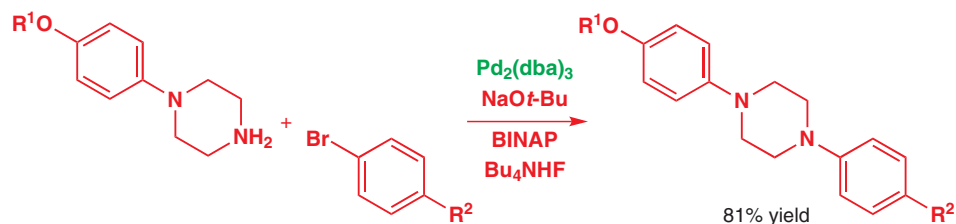

➔ The bisphosphine BINAP is shown on p. 319. It is a chiral compound, but that is irrelevant to its use here.

Nucleophilic aromatic substitution and palladium catalysis compared

You will have noticed that Buchwald–Hartwig chemistry accomplishes the same as nucleophilic aromatic substitution (S_NAr , Chapter 22): the replacement of a halogen by a nucleophile. So what are the differences?

	S_NAr	Buchwald–Hartwig
the leaving group	F > Cl > Br > I fluoride is not the best leaving group but it accelerates the addition	I > Br > Cl >> F iodide is best at the oxidative addition step but chloride will do and aryl chlorides are cheaper
regiochemistry	there must be an electron-withdrawing group <i>ortho</i> or <i>para</i> to the halide	any substitution pattern acceptable

The synthesis of a drug to control blood clotting gives us the opportunity to review both methods. This compound also has a central piperazine ring and disconnection of the right-hand side chain reveals an amine that could be functionalized by alkylation with a suitable benzylic halide or reductive amination.

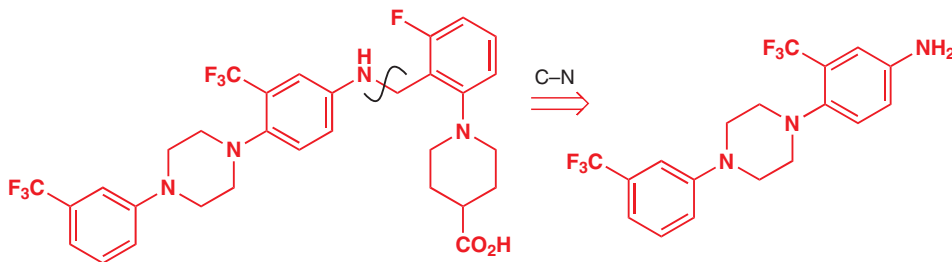

A standard way to make aromatic amines is by nitration and reduction (Chapter 21) so we can think of making this aminobenzene from the nitrobenzene below. Now we can disconnect the two C–N bonds with the idea of putting a halide (X) at the point of substitution in each aromatic coupling partner.

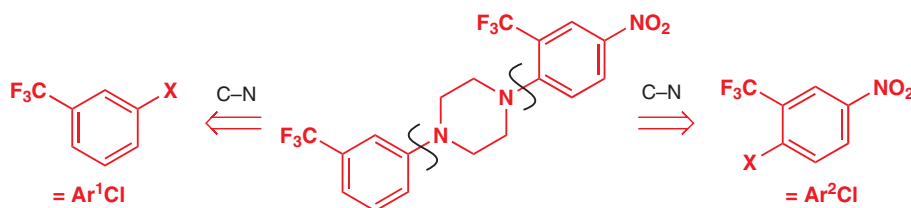

The substituents on the right-hand ring are both electron withdrawing and are *ortho* and *para* to the leaving group. As you know from Chapter 22, this is perfect for ordinary nucleophilic aromatic substitution—so much so that chloride is a good enough choice and it is not necessary to use fluoride. The left-hand ring has again a good electron-withdrawing substituent but it is *meta* to the halide and so nucleophilic aromatic substitution will not work. Palladium catalysis is needed. Chemists at Berlex Biosciences chose to introduce the left-hand ring first.

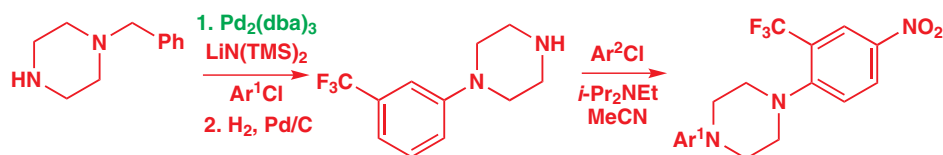

Alkenes coordinated to palladium(II) are attacked by nucleophiles

Now for another case where a transition metal catalysis facilitates a reaction that would not occur under normal conditions: nucleophilic attack on an isolated double bond. Usually alkenes react with nucleophiles only when conjugated with an electron-withdrawing group. But coordination of an electron-rich alkene to a transition metal ion such as palladium(II) changes its reactivity dramatically: electron density is drawn towards the metal and away from the π orbitals of the alkene. This leads to activation towards attack by nucleophiles, just as in conjugate addition, and unusual chemistry follows. Unusual, that is, for the alkene; the palladium centre behaves exactly as expected.



■ This regioselectivity is not the same as in the Heck reaction, where attack mostly occurs at the end of the alkene. Internal nucleophiles transferred from the palladium to the alkene usually prefer the terminal position of the alkene but external nucleophiles usually prefer the more substituted end.

Many nucleophiles, such as water, alcohols, and carboxylates, are compatible with an alkene–Pd(II) complex and can attack the complexed alkene from the side opposite the palladium. The attack of the nucleophile is regioselective for the more substituted position. This parallels attack on bromonium ions but is probably governed by the need for the bulky palladium to be in the less hindered position.

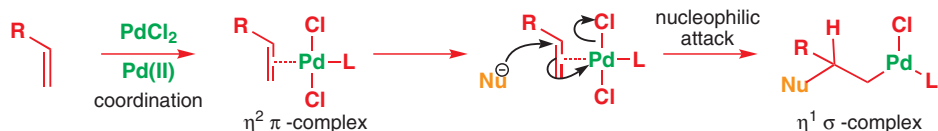

The resulting Pd(II) σ -alkyl species decomposes by β -hydride elimination to reveal the substituted alkene. Reductive elimination of a proton and the leaving group, usually chloride, leads to palladium(0). The weakness of this reaction is that the catalytic cycle is not complete: Pd(II), not Pd(0), is needed to complex the next alkene.

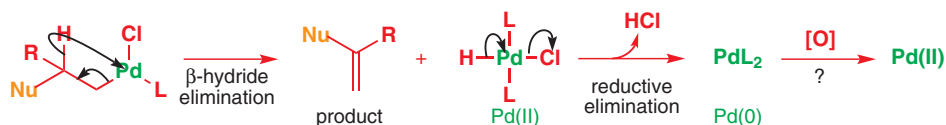

There are two solutions to this problem. We could use stoichiometric Pd(II) but this is acceptable only if the product is very valuable or the reaction is performed on a small scale. It is better to use an external oxidant to return the palladium to the Pd(II) oxidation state so that the cycle can continue. Air alone does not react fast enough (even though Pd(0) must be protected from air to avoid oxidation) but, in combination with copper(II) chloride, oxygen completes the catalytic cycle. CuCl₂ oxidizes Pd(0) to Pd(II) and is itself oxidized back to Cu(II) by oxygen, ready to oxidize more palladium.

Oxypalladation and the Wacker oxidation

This combination of reagents has been used to oxidize terminal vinyl groups to methyl ketones and is known as the **Wacker oxidation**. The nucleophile is simply water, which attacks the activated alkene at the more substituted end in an *oxypalladation* step. β -Hydride elimination from the resulting σ -alkyl palladium complex releases the enol, which is rapidly converted into the more stable keto form. Overall, the reaction is a hydration of a terminal alkene that can tolerate a range of functional groups.

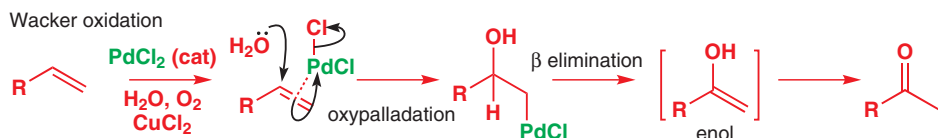

A related reaction is the oxidation of silyl enol ethers to enones. This requires stoichiometric palladium(II), although reoxidation of Pd(0) with benzoquinone can cut that down to about half an equivalent. The reaction provides a valuable way of turning regioselective methods for making silyl enol ethers (Chapter 20) into regioselective methods for oxidizing ketones to enones. The first step is again oxypalladation and β elimination puts the alkene in conjugation with the ketone: there are no β hydrogens on the other side.

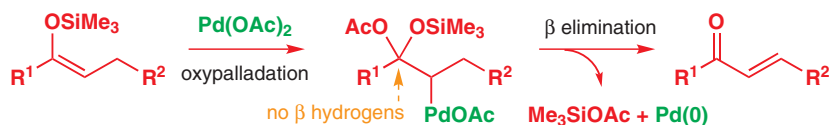

An example of catalytic oxypalladation is the rearrangement of allylic acetates with Pd(II). The reaction starts with oxypalladation of the alkene and it is the acetate already present in the molecule that provides the nucleophile to attack the alkene. The intermediate can reverse the oxypalladation in either direction and the product is whichever allylic acetate has the more substituted alkene. In this case, trisubstituted beats monosubstituted easily.

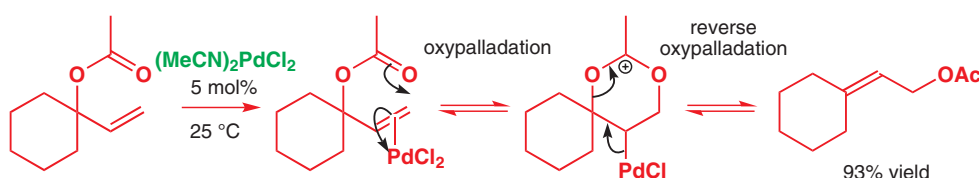

The reaction is *E*-selective, which means that a simple synthesis of an *E,Z*-diene is possible from the symmetrical acetate with two *Z*-allylic alkenes. The one that rearranges goes *E* and the one that stays behind remains *Z*. The driving force for this rearrangement, from one disubstituted alkene to another, is establishment of conjugation.

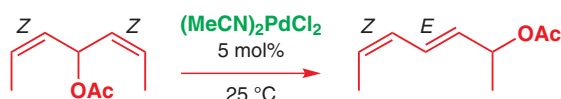

Alcohols and amines as intramolecular nucleophiles

Cyclic ethers and amines can be formed with an intramolecular alcohol or amine nucleophile. Stoichiometric palladium can be avoided by using benzoquinone as the stoichiometric oxidant with a catalytic amount of palladium. In this example intramolecular oxypalladation of a diene is followed by attack of an external nucleophile on a π -allyl complex.

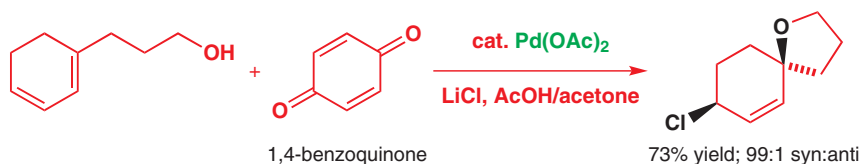

Palladium coordinates to one face of the diene, promoting intramolecular attack by the alcohol on the opposite face. The resulting π -allyl palladium can form a π -allyl complex with the palladium on the lower face simply by sliding along to interact with the double bond. Nucleophilic attack of chloride from the lithium salt then proceeds in the usual way on the face opposite palladium. The overall addition to the diene is therefore *cis*.

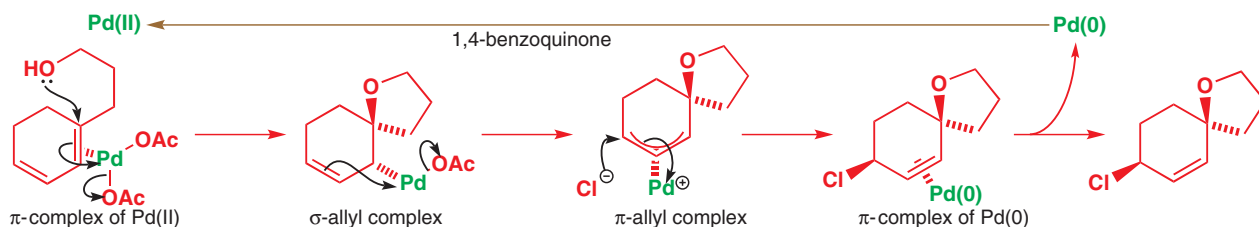

Nitrogen nucleophiles also attack alkenes activated by Pd(II), and benzoquinone can again act as a reoxidant, allowing the use of catalytic quantities of palladium. The mechanism follows the same pattern as for oxygen nucleophiles, and a final isomerization produces the most stable regioisomer of product. In this example the product is an aromatic indole, so the double bond migrates into the five-membered ring.

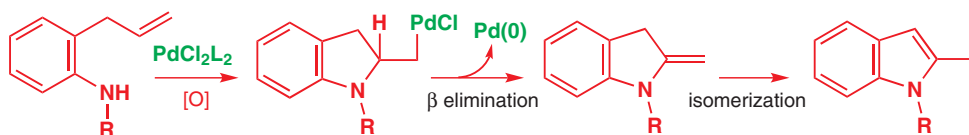

If the substrate lacks a hydrogen suitable for β elimination and there is another alkene present in the molecule, the σ -alkyl palladium intermediate can follow the Heck pathway to form a bicyclic structure in a tandem reaction sequence. Once again, the final step is a palladium-hydride-mediated isomerization to give the endocyclic alkene.

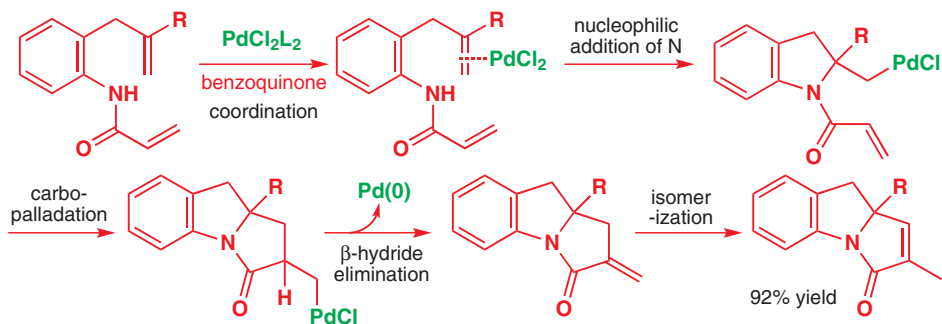

Palladium catalysis in the total synthesis of a natural alkaloid

We take our leave of palladium by presenting a synthesis of an alkaloid, *N*-acetyl clavicipitic acid methyl ester, by Hegedus. The power of organometallic chemistry is illustrated in five of the steps in this seven-step process (the metals are highlighted in orange). Each of the organometallic steps catalysed by Pd(0) or Pd(II) has been described in this chapter. The overall yield is 18%, a remarkably good result for a molecule of such complexity.

The first step is to make an indole by Pd(II)-catalysed cyclization in the presence of benzoquinone as reoxidant. The nucleophilic nature of the 3-position of the indole (Chapter 30) was exploited to introduce the required iodide functionality. Rather than direct iodination, a high-yielding two-step procedure involving mercuriation followed by iodination was employed.

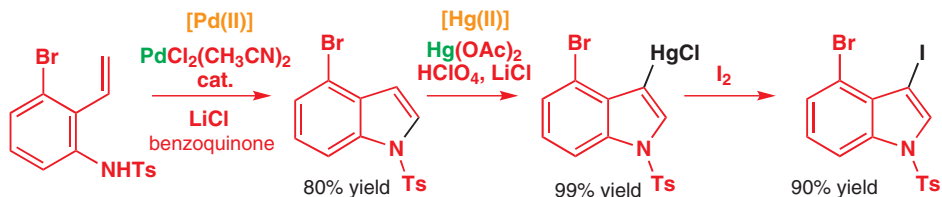

Aryl iodides are more reactive towards oxidative addition than aryl bromides, and a selective Heck coupling (without phosphine ligands) with an unsaturated side chain left the bromide in place. A second Heck reaction of this bromide with an allylic alcohol was used to introduce a second side chain. Cyclization of the amide on to the allylic alcohol was achieved with palladium catalysis, not as might have been expected with palladium(0) but instead with palladium(II), to produce the seven-membered ring. Finally, the conjugated double bond was reduced and the sulfonamide removed under photolytic conditions.

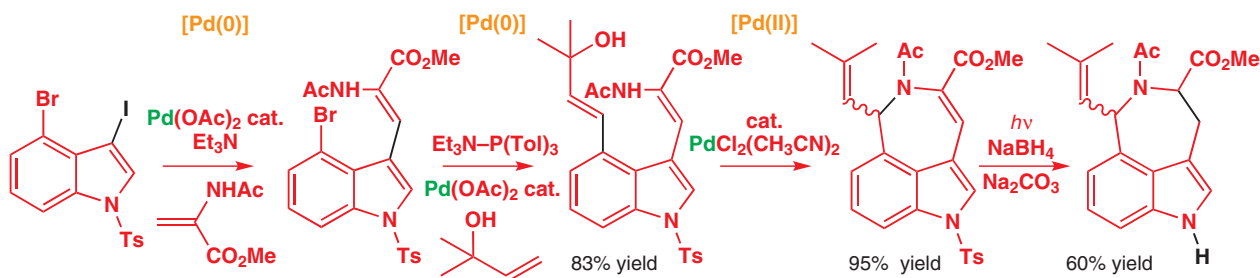

An overview of some other transition metals

Some metals—palladium chief among them—see continual service in catalysis but others have their day and then fall out of favour when better alternatives become available. Tin is less popular now than it was 20 years ago because of its toxicity. A more serious case is mercury. Mercury(II) is an excellent catalyst for the addition of water to alkynes. But mercury is very toxic indeed, and the last ten years have seen its role largely superseded by gold. Do not recoil at the expense! Gold is expensive on the scale used to make rings, plates, medals, and coins, but here it is used in only catalytic quantities. Gold is in fact less expensive than palladium, rhodium, or ruthenium. Part of the age-old appeal of gold is its unreactivity as a metal: it is very stable but it does form Au(I) and Au(III) salts such as AuCl and AuCl₃. Both are available commercially and are generally used as their phosphine complexes.

Gold: activating alkynes

Au(I) and Au(III) form cationic π complexes with alkynes and these react with nucleophiles of many kinds. With water the result is simple: it adds to the more substituted end of the alkyne and the net result is hydration to give a ketone.

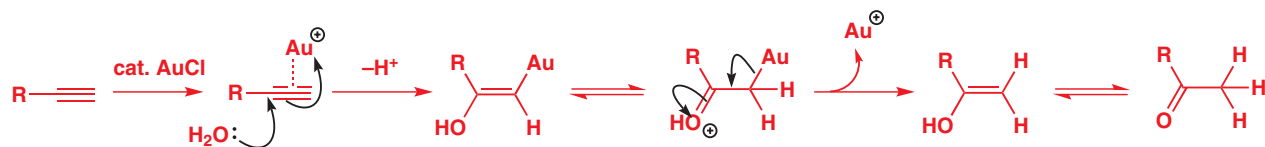

This simple reactivity can be developed in many more elaborate ways you can read about elsewhere, but simple examples include hydration of an enyne to form a conjugated ketone and the capture of the ketone by intramolecular acetal formation. The details give you an idea of reagents, solvents, and yields.

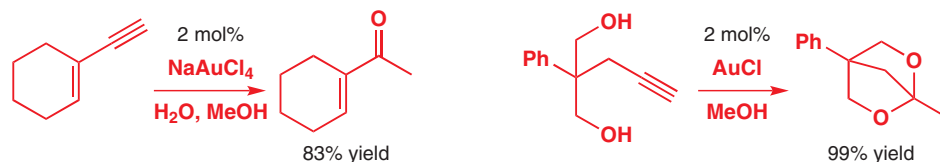

Ruthenium: alkene (olefin) metathesis

The theme of this chapter is that transition metals let you do things to organic molecules which are unthinkable without them. Nowhere is this more true than in metathesis reactions, and we finish the chapter with a reminder of the power of the ruthenium catalysts we introduced in Chapter 38. There we discussed the carbene-based mechanism of the reaction, and we showed you some simple examples such as this cyclization of a symmetrical amine to give a five-membered heterocycle using a catalytic amount of the ruthenium complex known as Grubbs I catalyst.

➔ The structures of three important ruthenium complexes used as catalysts for metathesis are given on p. 1025.

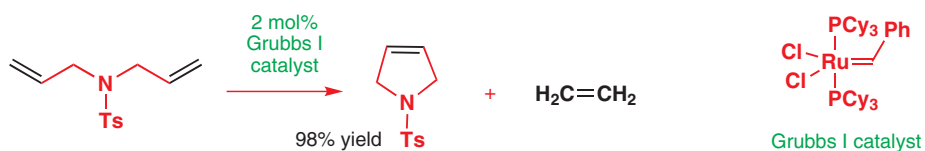

The synthesis of a sleep-inducing drug by GlaxoSmithKline in their laboratories at Verona used a very similar metathesis, although on an unsymmetrical amine and giving a six-membered heterocycle. The starting material is also a single enantiomer and the stereochemistry is important as the cyclopropane, introduced by a Simmons–Smith reaction (Chapter 38), must be be on the opposite face of the six-membered ring to the side chain.

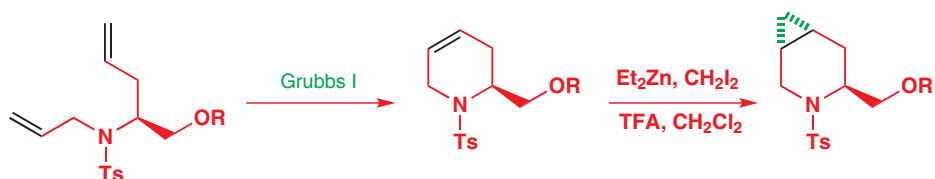

At another GlaxoSmithKline site, in the USA, the development of a drug for osteoporosis and osteoarthritis required a seven-membered heterocycle with two controlled chiral centres. This time the Hoveyda–Grubbs catalyst had to be used but the loading is very low indeed. Notice also that a free OH group does not interfere.

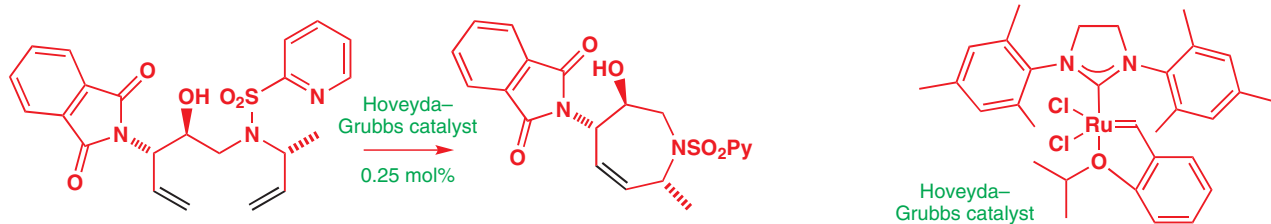

Our third example comes from Syngenta's crop protection laboratory in Basel. It is another cyclization but this time to form an oxygen heterocycle with four chiral centres. The final product of this synthesis is malayamycin A, a natural fungicide found in bacteria. The metathesis step is early in the synthesis and you will notice that the alkene formed in this cyclization is used to provide two more chiral centres in malayamycin.

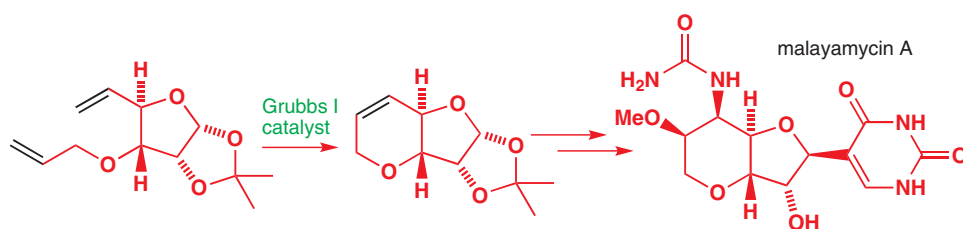

In the next chapter you will see more ways in which ruthenium—along with osmium, titanium, rhodium, and others—can be used to solve the challenges of synthesis as we look at ways of making molecules as single enantiomers.

Further reading

Most textbooks of organometallic chemistry favour the inorganic approach of facts rather than explanation. There are usually plenty of structures and catalytic cycles but very few mechanisms. However, two brief introductions that might help you are: M. Bockmann, *Organometallics 1 and 2*: Oxford Primers, OUP, Oxford, 1994. A book that does contain mechanisms of a number of the reactions in this book, as well as others, is P. Wyatt and S. Warren, *Organic Synthesis: Strategy and Control*, Wiley, Chichester, 2007. Probably the best comprehensive account is J. Hartwig, *Organotransition Metal Chemistry*, University Science Books, New York, 2010.

The references to the examples of drug synthesis by metathesis are: W. M. Maton and GlaxoSmithKline group in Verona, *Organic Process Research and Development*, 2010, **14**, 1239; H. Wang and GlaxoSmithKline group in King of Prussia, Pennsylvania, *Organic*

Process Research and Development, 2008, **12**, 226; O. Loiseleur and Syngenta group at Basel, *Organic Process Research and Development*, 2006, **10**, 518.

Organic Syntheses are a good source of ways to make reagents and ways to carry out reactions. Comins' reagent is featured in *Organic Syntheses*, 1997, **74**, 77.

Leading references for the Buchwald and Hartwig chemistry: J. F. Hartwig and group, *Angew. Chem. Int. Ed.*, 2005, **44**, 1371; S. L. Buchwald and group, *Organic Letters*, 2005, **7**, 3965. Gold chemistry is reviewed by A. Fürstner and P. W. Davies, *Angew. Chem. Int. Ed.*, 2007, **46**, 3410. The drug syntheses are from C. H. Senanayake and group, *Tetrahedron: Asymmetry*, 2003, **14**, 3487; B. Ye and group, *Bioorg. and Med. Chem. Lett.*, 2004, **14**, 761.

The new gold chemistry of alkynes and alkenes is described in a long review H. C. Shen, *Tetrahedron*, 2008, **64**, 3885.

Check your understanding



To check that you have mastered the concepts presented in this chapter, attempt the problems that are available in the book's Online Resource Centre at <http://www.oxfordtextbooks.co.uk/orc/clayden2e/>

41

Asymmetric synthesis

Connections

➔ Building on

- Carbonyl group reactions **ch6, ch9–ch11**
- Stereochemistry and conformation **ch14, ch16, & ch31**
- Electrophilic addition to enolates and alkenes **ch19 & ch20**
- Aldol reactions **ch26**
- Diastereoselectivity **ch32 & ch33**
- Cycloadditions **ch34**

Arriving at

- Why making pure enantiomers matters
- Chirality derives from nature
- The chiral pool provides starting materials, auxiliaries, and catalysts
- Chiral auxiliaries work well in asymmetric alkylation and aldol reactions
- Chiral catalysts for oxidation and reduction reactions
- Ligand-accelerated catalysis
- Catalysis with and without metals

➔ Looking forward to

- Chemistry of life **ch42**
- Chemistry and the future **ch43**



'L'univers est dissymétrique'.
Louis Pasteur, *Comptes Rendus Acad. Sci.*, Paris June 1, 1874.

■ This chapter builds on the concepts introduced in Chapter 14: make sure you understand all the terms used to describe stereochemistry that are defined there. In particular make sure you are absolutely clear on the meanings of *chiral*, *achiral*, *enantiomer*, and *diastereoisomer*, along with what the designators *R*, *S*, *+*, *-*, *L*, and *D* refer to.

Nature is asymmetric

'How would you like to live in Looking-glass House, Kitty? I wonder if they'd give you milk in there? Perhaps looking-glass milk isn't good to drink. . .' Lewis Carroll, *Through the looking-glass and what Alice found there*, Macmillan, 1872.

You are chiral, and so are Alice, Kitty, and all living organisms. You may think you look fairly symmetrical in a looking-glass, but as you read this book you are probably turning the pages with your right hand and processing the information with the left side of your brain. Some organisms are rather more obviously chiral: snails, for example, carry shells that could spiral to the left or to the right. Not only is nature chiral, but by and large it exists as just one enantiomer—although some snail shells spiral to the left, the vast majority of marine snail shells spiral to the right; humans have their stomach on their left and their liver on their right; honeysuckle (*Lonicera*) climbs by spiralling to the left and all bindweed (*Convolvulus*) spirals to the right.

Nature has a left and a right, and it can tell the difference between them. You may think that human beings are sadly lacking in this respect, since as children we all had to learn, rather laboriously, which is which. Yet at an even earlier age, you could no doubt distinguish the smell of oranges from the smell of lemons, even though this is an achievement at least as remarkable as getting the right shoe on the right foot. The smells of orange and lemon differ in being the left- and right-handed versions of the same molecule, limonene. (*R*)-(+)-Limonene smells rounded and orangey; (*S*)-(-)-limonene is sharp and lemony. Similarly, spearmint and caraway seeds smell quite different, although again this pair of aromas differs only in being the enantiomeric forms of the ketone carvone. Evolution has left many of us regrettably sensitive to (+)-androstenone, the smell of stale human urine. (-)-Androstenone is essentially odourless.

Online support. The icon  in the margin indicates that accompanying interactive resources are provided online to help your understanding: just type www.chemtube3d.com/clayden/123 into your browser, replacing **123** with the number of the page where you see the icon. For pages linking to more than one resource, type **123-1, 123-2** etc. (replacing **123** with the page number) for access to successive links.

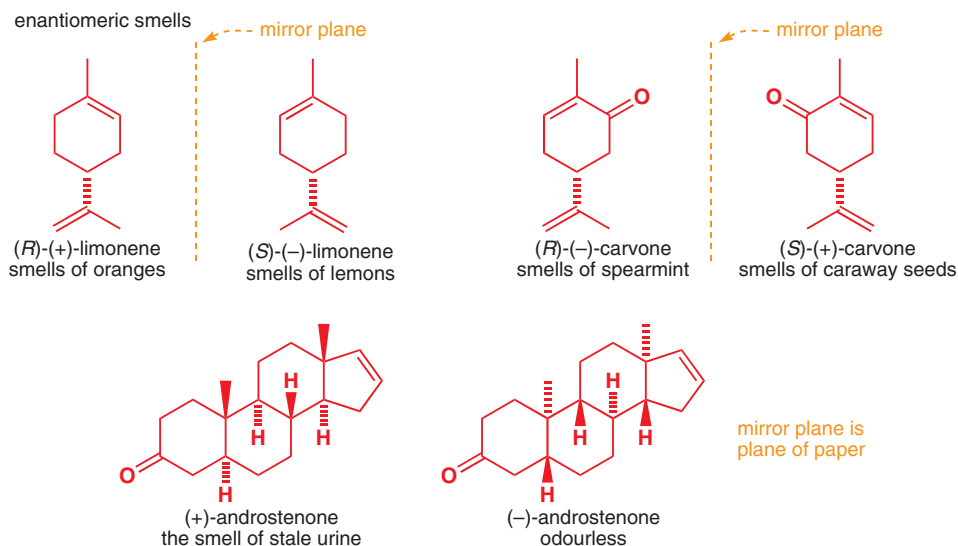

Even bacteria know their right from their left: *Pseudomonas putida* can use aromatic hydrocarbons as a foodstuff, degrading them to diols. The diol produced from bromobenzene is formed as one enantiomer only.

How can this be? We said in Chapter 14 that enantiomers are chemically identical, so how is it that we can distinguish them with our noses and bacteria can produce them selectively? Well, the answer lies in a proviso to our assumption about the identity of enantiomers: they are identical *until they are placed in a chiral environment*. This concept will underlie all we say in this chapter about how to make single enantiomers in the laboratory. We take our lead from nature: all life is chiral, so all living systems are chiral environments.

The sheer complexity of life means that nature has to build its living structures from molecules that are chiral, principally amino acids and sugars. For all of those chiral molecules, evolution has forced the use of a single enantiomeric form, for example every amino acid in your body has the same configuration (usually labelled *S*). From this fact derives the larger-scale chirality of all living structures, from the right-handed double helix of DNA to the location of a blue whale's internal organs. The answer to the question posed by Alice at the start of the chapter is most certainly *no*—her kitten's digestive system will be able to hydrolyse the achiral fats in the looking-glass milk quite easily (achiral compounds are superimposable on their mirror image), but looking-glass proteins (which will be made of *D*-amino acids) and *L*-lactose will be quite indigestible.

For a perfumer or flavour and fragrance manufacturer, the distinction between the differently scented enantiomers of the same molecule is clearly of great importance. Nonetheless, we could all get by with caraway-flavoured toothpaste. Yet when it comes to drug molecules, making the right enantiomer can be a matter of life and death. Parkinson's disease sufferers are treated with the non-proteinogenic amino acid dopa (3-(3,4-dihydroxyphenyl)alanine). Dopa is chiral, and only (*S*)-dopa (known as *L*-dopa) is effective in restoring nerve function. (*R*)-Dopa is not only ineffective, it is quite toxic, so the drug must be marketed as a single enantiomer.

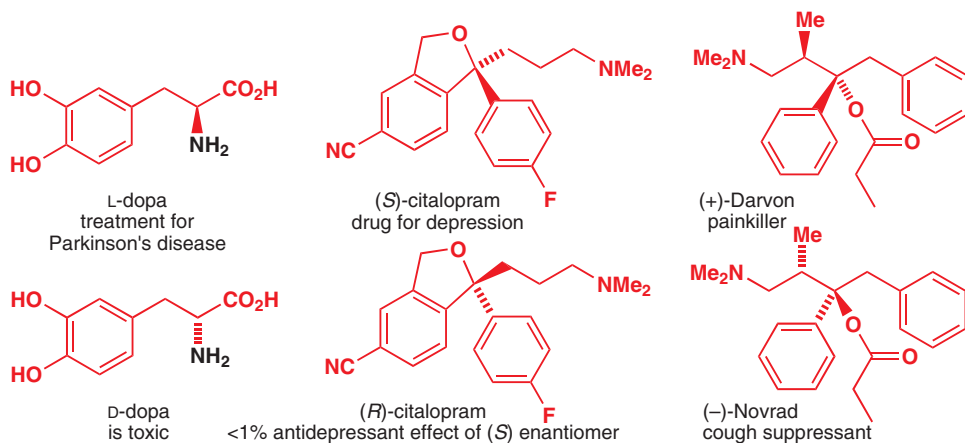

(+)-Androstenone is also a pig pheromone. You may not wish to know that it is the active component of DuPont's Boarmate, used by pig farmers to prepare sows for artificial insemination.

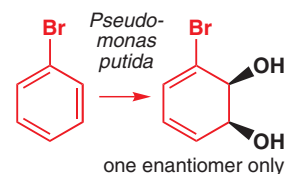

➔ The molecules of life are examined in detail in the next chapter.

■ Natural *L*-amino acids all look like this:

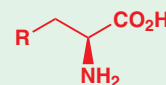

All have *S* stereochemistry except cysteine ($R=SH$), where the priority rules mean the chiral centre is *R*. Some bacteria make their cell walls from 'unnatural' *R*-amino acids to make them unassailable by the (*S*-amino acid-derived) enzymes used by higher organisms to hydrolyse peptides (see p. 1141).

In other cases, only one of the two enantiomers of a drug molecule possesses activity: the antidepressant citalopram and the painkiller naproxen are both marketed only as their *S* enantiomer because the *R* enantiomers are essentially inactive. In a few cases, the enantiomers both have activity, but in different ways: (+)-Darvon and (–)-Novrad are a painkiller and a cough suppressant, respectively.

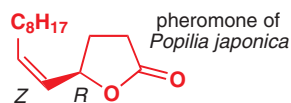

It is not only drugs that have to be manufactured enantiomerically pure. This simple lactone is the pheromone released by the Japanese beetle *Popilia japonica* as a means of communication. The beetles, whose larvae are serious crop pests, are attracted by the pheromone, and synthetic pheromone is marketed as 'Japonilure' to bait beetle traps. Provided the synthetic pheromone is the stereoisomer shown, with the *Z* double bond and the *R* configuration at the stereogenic centre, only 25 µg per trap catches thousands of beetles. You met this compound in Chapter 27, where we pointed out that double bond stereocontrol is important since the *E* isomer of the pheromone is virtually useless as a bait (it retains only about 10% of the activity). Even more important is control over the configuration at the chiral centre because the *S* enantiomer of the pheromone is not only inactive in attracting the beetles, but acts as a powerful inhibitor of the *R* enantiomer—even 1% of *S* enantiomer in a sample of pheromone destroys the activity.

So you see why chemists need to be able to make compounds as single enantiomers. In Chapters 32 and 33 we looked at *relative stereochemistry* and how to control it; this chapter is about how to control *absolute stereochemistry*. We call this asymmetric synthesis.

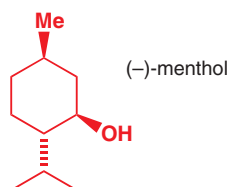

In the last 25 years or so, this subject has occupied more organic chemists than possibly any other, and we are now at a point where it is not only possible (and in fact essential because of strict regulatory rules) to make many drug molecules as single enantiomers, but it is also even possible to make many chiral molecules that are indigenous to nature more cheaply in the laboratory. By 2007, for example, at least 30% of the world's supply of menthol was not extracted from plants but made synthetically. A thousand tonnes of (–)-menthol a year is made by the company Takasago in Japan using the techniques of asymmetric synthesis that you will meet later in this chapter.

The chiral pool: Nature's chiral centres 'off the shelf'

When we first introduced you to enantiomers and chirality in Chapter 14, we stressed that any imbalance in enantiomers always derives ultimately from nature. A laboratory synthesis of a chiral compound from achiral or racemic starting materials alone always gives a racemic mixture of enantiomers. If you want to make just one enantiomer, you have to use a starting material or reagent which is also just one enantiomer. This seems like a chicken-and-egg situation, until you realize that nature provides a collection of 'off the shelf' enantiomerically pure compounds that we can exploit in various ways. This collection of natural, enantiomerically pure compounds is called the **chiral pool**. The principal groups of compounds in the chiral pool are:

1. The amino acids. There is a full list of the natural amino acids found in proteins on p. 554, but for the purposes of this chapter you should make sure you are familiar with the structures below. They all have simple side chains that are simple alkyl groups or functionalized chains with plenty of versatile chemistry, and can be obtained by hydrolysis of protein.

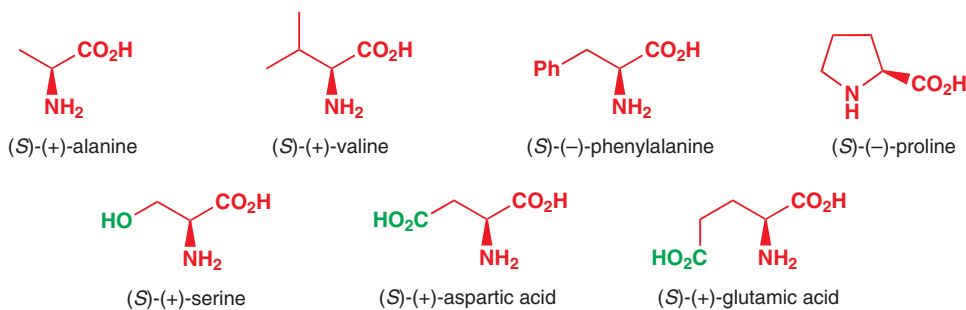

2. Simple derivatives of the amino acids: amino alcohols and hydroxy acids. It's easy to reduce amino acids to amino alcohols with borane (BH_3), usually generated in the reaction mixture by treating sodium borohydride with concentrated sulfuric acid. We will use a number of naturally derived amino alcohols as starting materials in this chapter.

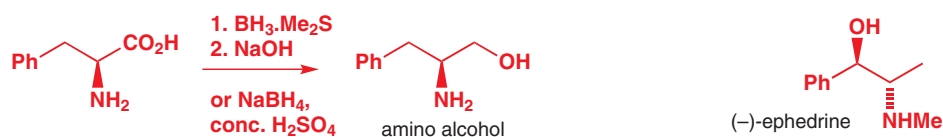

Ephedrine is an amino alcohol which is itself a useful member of the chiral pool—it's a plant extract readily available as either diastereoisomer (see p. 314), each, unusually, also available as either enantiomer.

It's also easy to make hydroxy acids from amino acids by diazotization. You saw this being done in Chapter 33, but as a reminder nitrous acid generates a diazonium salt, which undergoes substitution by water via an intermediate α -lactone. Two configurational inversions are involved, so the product alcohol retains *S* stereochemistry.

diazotization–hydrolysis of amino acids to give hydroxy acids proceeds with overall retention

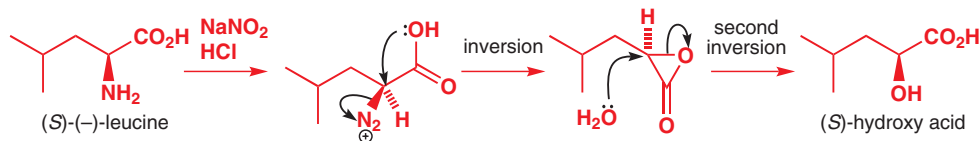

➔ Look back at p. 875 for more on the mechanism of this transformation—it's very important that the reaction goes with overall *retention* of stereochemistry.

Some hydroxy acids are themselves available from nature, and are therefore also members of the chiral pool: both (*R*)- and (*S*)-lactic acid, for example, can be made by bacterial fermentation; mandelic, malic, and tartaric acids are extracted from almonds, apples, and grapes, respectively.

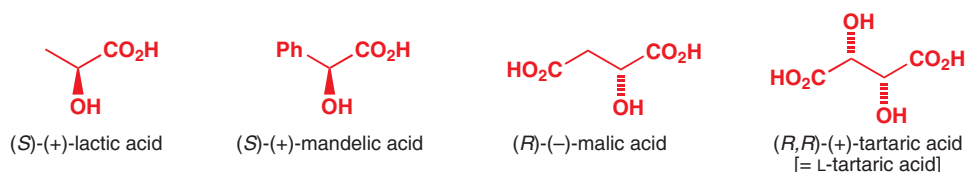

3. Carbohydrates and their derivatives. There are a great many simple carbohydrates available, but one of the most useful is mannose. Reduction to the alcohol gives the C_2 -symmetric compound mannitol, which can be converted to a useful aldehyde by selective protection as a bis-acetal with acetone and a Lewis acid. Cleavage of the remaining diol with sodium periodate gives two equivalents of a useful protected form of glyceraldehyde.

➔ The concept of C_2 rotational symmetry is discussed on p. 320. C_2 symmetry is compatible with chirality. For the oxidative cleavage of diols to aldehydes, see p. 443.

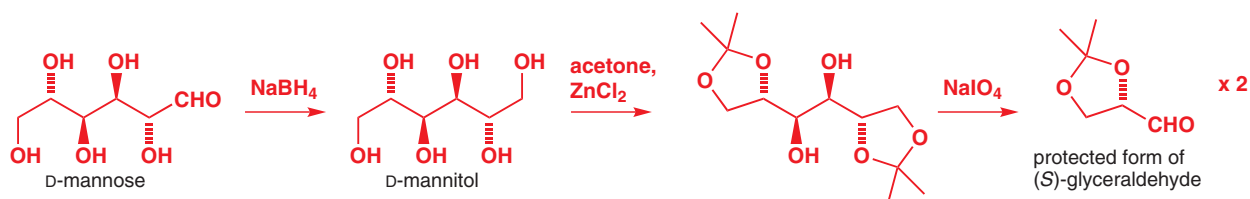

In this chapter we will show you the many and varied ways in which members of the chiral pool can be put to work in asymmetric synthesis, but the most straightforward application is simply to spot that a target molecule has a close structural similarity with, say, an amino

acid. This is what Mori did when he made another important insect pheromone, ipsenol. The left-hand half of the molecule has the same structure as the side chain of leucine, and the *S* chiral centre can also come from (*S*)-leucine.

structural similarity with leucine

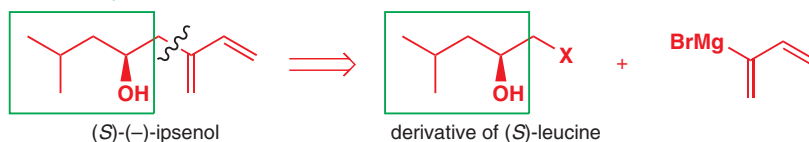

Mori used (*S*)-leucine as the starting material and converted it to the (*S*)-hydroxy acid by the method on p. 875. The hydroxyl group was protected as the THP derivative (Chapter 23).

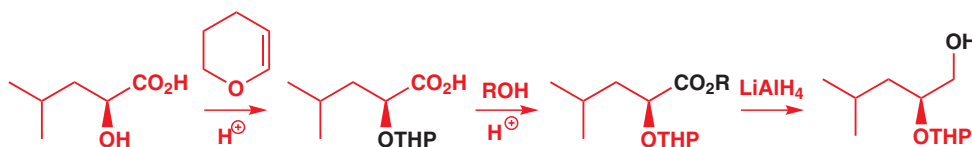

Reduction of the acid, via the ester, then allowed introduction of the tosylate leaving group, which was displaced to make an epoxide. The epoxide was opened by a Grignard reagent to introduce the diene portion and give the target molecule.

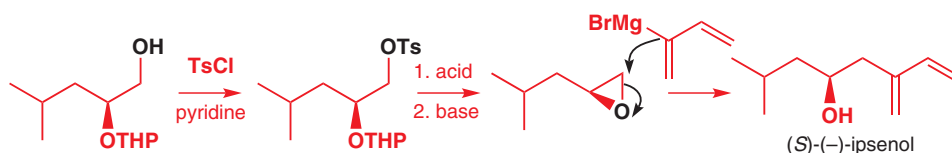

➔ This drawback is highlighted in the synthesis of oseltamivir in Chapter 43 (p. 1174).

This might seem rather long-winded, and long-windedness can be a drawback of syntheses starting from the chiral pool: you have to shoe-horn your synthetic route into the available starting materials. Another drawback of syntheses starting from the chiral pool is the fact that many natural compounds are only available as one enantiomer or, if both enantiomers are available, one is much more expensive than the other. You will see some ingenious ways of circumventing this problem later in the chapter, but we deal with a very simple one in the next section.

Resolution can be used to separate enantiomers

➔ We will not explain resolution again here: turn to p. 322 for the details.

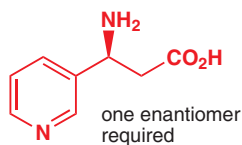

In Chapter 14 we introduced you to resolution as a means of separating enantiomers. Resolution requires an enantiomerically pure resolving agent, which must be a compound from the chiral pool or a simple derivative of that compound. When the Swiss company Cilag wanted one enantiomer of the unusual chiral amino acid in the margin in order to make some potential drug candidates, the chemists there decided the easiest way to get hold of it quickly and in large quantities was to make it in racemic form and then resolve it. It turned out that one of the two enantiomers of the protected derivative below forms a crystalline salt with cheap, readily available (–)-ephedrine, while the other remains in solution. Filtration and treatment with acid to remove the protecting group and protonate the acid gave them a single enantiomer of their target amino acid.

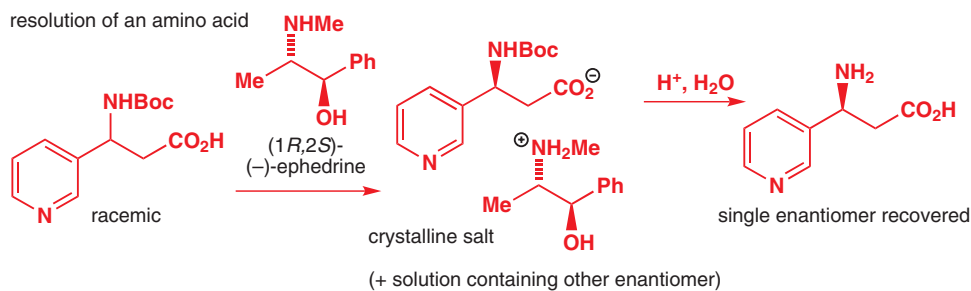

Of course, with resolution, there is a maximum yield of 50% because if you only want one enantiomer, the other is wasted. But there are many cases where you might want *both* enantiomers. You may need to test them both for biological activity, for example. In that case, resolution is ideal—in the example above the chemists at Cilag could get hold of the other enantiomer of the amino acid just by evaporating the mother liquors from the recrystallization. This is a big advantage of resolution: it lets you get both enantiomers using just one compound from the chiral pool.

Chiral auxiliaries

In Chapter 33 we showed you methods for making single diastereoisomers using diastereoselective reactions. Diastereoselective reactions work just as well whether the starting material is racemic or enantiomerically pure—you get the same diastereoisomeric outcome in each case, but if you start with racemic material you get racemic product and if you start with enantiomerically pure material you get enantiomerically pure product. Here's an example, from p. 867:



So if you use a starting material from the chiral pool, you can build new chiral centres in enantiomerically pure form just by using diastereoselective reactions. We showed you two syntheses at the end of Chapter 33 using this idea: the chiral pool starting materials (*S*)-lactic acid and (*S*)-serine were converted to two natural products using a series of diastereoselective reactions to introduce further chiral centres into the molecules.

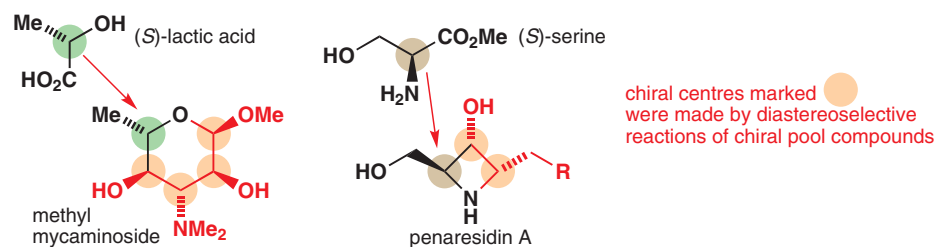

➔ These syntheses are on pp. 872–875.

The syntheses rely on the fact that the structure of the chiral pool starting material is still there in the product. But the same idea can work even if the starting chiral compound is no longer part of the target you are making. In this case the chiral starting material is called a *chiral auxiliary*. Chiral auxiliaries are extremely versatile because they can be used to make a whole variety of target molecules in enantiomerically pure form. We will explain how they work with two examples.

➔ Diels–Alder reactions of cyclopentadiene appear on p. 880.

The product of a Diels–Alder reaction between cyclopentadiene and benzyl acrylate must necessarily be racemic as both reagents are achiral. Although only one *diastereoisomer*—the *endo* product—is formed, it must be formed as an exactly 50:50 mixture of *enantiomers*. There is nothing to tell the diene whether to attack the top or the bottom face of the dienophile so it does both, each 50% of the time.

Diels–Alder reaction gives a racemic product

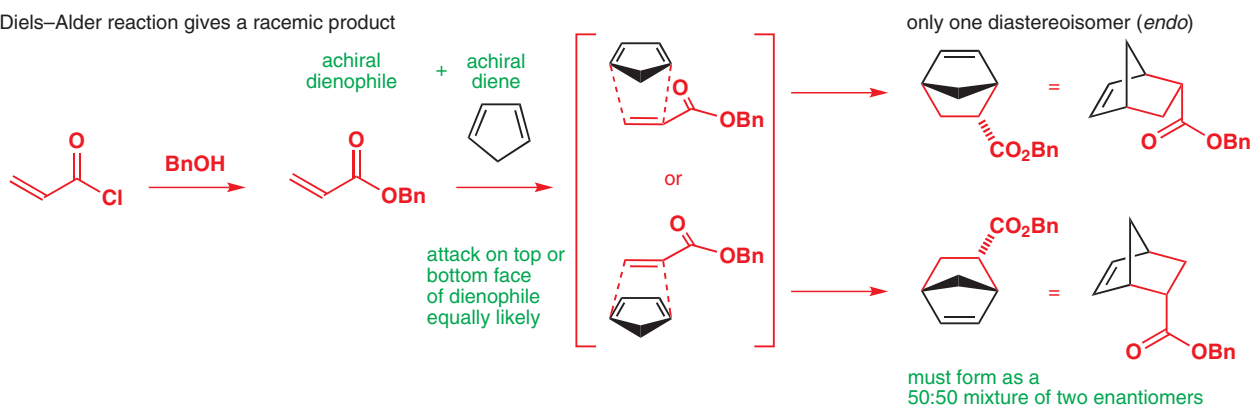

Now see what happens if we replace the achiral benzyl ester group of the dienophile with an amide derived from the amino acid valine. Here's the synthesis of such a dienophile using the amino acid reduction you saw on p. 1105.

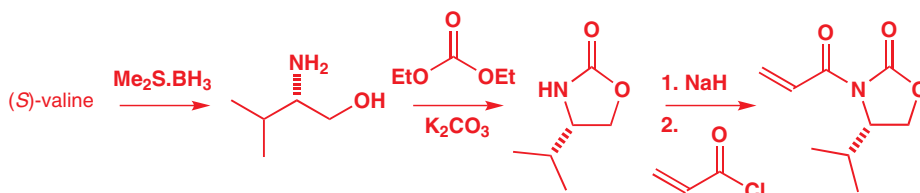

■ As we discussed in Chapter 34, the presence of a Lewis acid increases the rate of Diels–Alder reactions, and in this case is also vital for high stereoselectivity.

The two faces of the double bond of the dienophile are now different because of the chiral centre: they are diastereotopic, and the diene can distinguish between them. If we now do the Diels–Alder reaction in the presence of a Lewis acid, Et_2AlCl , the aluminium chelates the oxygen atoms of the dienophile to form the rigid and reactive structure shown below. The isopropyl group is held in such a way that its steric bulk prevents the diene attacking that face of the prochiral alkene. The diene has no choice but to attack from above, and only one of the possible diastereoisomeric products is formed.

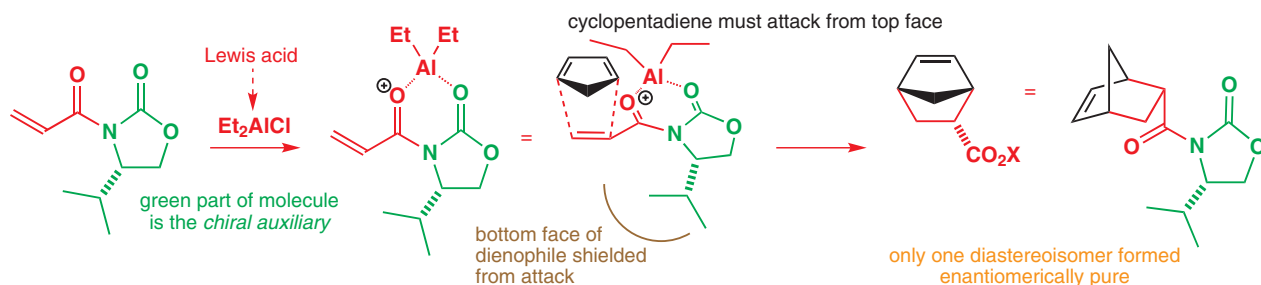

Interactive chiral auxiliary-controlled Diels–Alder reaction

We call the green valine-derived part of this molecule the *chiral auxiliary*—it assists the substrate to react in a diastereoselective way such that only one of the two possible products is allowed to form. The chiral auxiliary was enantiomerically pure to start with, so the product must be diastereoisomerically *and* enantiomerically pure.

Finally comes the step which shows the power of chiral auxiliary strategy: we just remove the chiral auxiliary from the product by treating with a nucleophile. The auxiliary can in principle be used again, but most importantly of all, the product obtained is just one of the two enantiomers we made in the racemic version of this reaction. This isn't a resolution—all

of these steps go in high yield—it is truly an enantioselective synthesis of the Diels–Alder product, using a chiral auxiliary to help us.

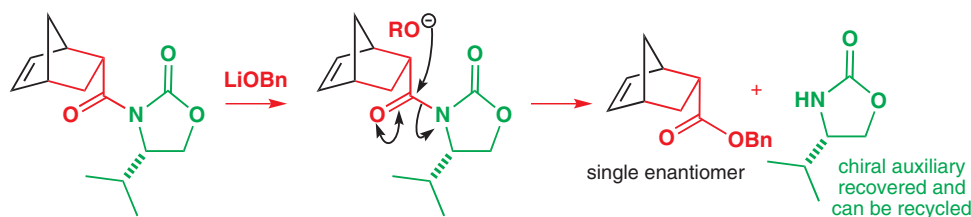

Overall, by sequential attachment of the auxiliary, diastereoselective reaction, and removal of the auxiliary we have made the same product but as a single enantiomer.

● **This is what we mean by a chiral auxiliary strategy**

- 1 An enantiomerically pure compound (usually derived from a simple natural product like an amino acid), called a chiral auxiliary, is attached to the starting material.
- 2 A diastereoselective reaction is carried out, which, because of the enantiomeric purity of the chiral auxiliary, gives only one enantiomer of the product.
- 3 The chiral auxiliary is removed by, for example, hydrolysis, leaving the product of the reaction as a single enantiomer. The best chiral auxiliaries (of which the example above is one) can be recycled, so although stoichiometric quantities are needed, there is no waste.

We have introduced you to this chiral auxiliary before any other because it is more commonly used than any other. It is a member of the oxazolidinone (the name of the heterocyclic ring) family of auxiliaries developed by David Evans at Harvard University, and is easily and cheaply made from the amino acid (*S*)-valine. Even though it is cheap, it can be recycled. The last step of the route above regenerates the auxiliary ready for re-use.

The most versatile chiral auxiliaries should also be available as both enantiomers. For the valine-derived one here, this is not the case—(*R*)-valine is quite expensive since it is not found in nature. However, by starting with the naturally occurring (and cheap) compound norephedrine, we can make an auxiliary that, although not enantiomeric with the one derived from (*S*)-valine, acts as though it were.

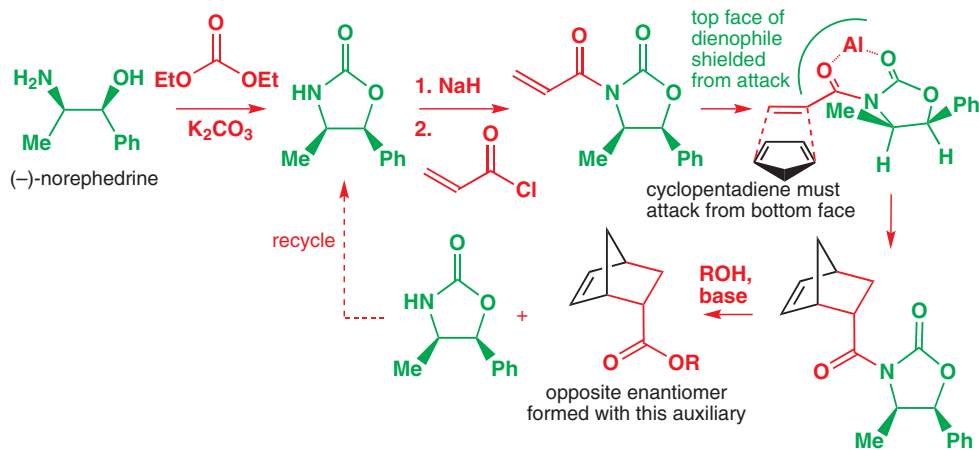

As the diagram shows, the two substituents of the auxiliary lie on the top face of the dienophile and force the cyclopentadiene this time to attack the bottom face. Now when the auxiliary is cleaved from the product the opposite enantiomer is formed. We can choose which enantiomer we want simply by choosing the right auxiliary for the job.

Alkylation of enolates

Chiral auxiliaries can be used in plenty of other reactions, and some of the most common are reactions of enolates. Evans's oxazolidinone auxiliaries are particularly appropriate here

➔ Enolates are a sort of alkene and can form as *cis* or *trans* geometrical isomers. One of the consequences of this is discussed in Chapter 33.

because they are readily turned into enolizable carboxylic acid derivatives. Treatment with base (usually LDA) at low temperature produces an enolate, the bulky auxiliary means that only the *cis* enolate forms: the *trans* enolate is too hindered.

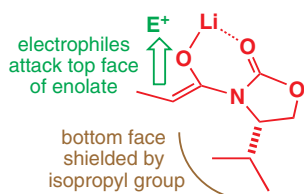
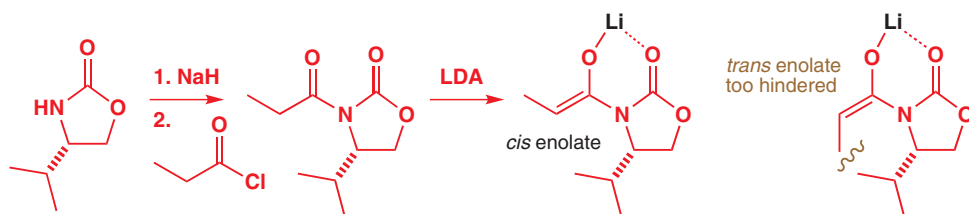

Coordination of the lithium ion to the other carbonyl oxygen makes the whole structure rigid, fixing the isopropyl group round the back of the molecule, where it can provide maximum hindrance to attack on the 'wrong' face of the enolate. Electrophiles have little choice but to attack the enolate from the front, and the table shows the ratio of diastereoisomers (the diastereoisomeric ratio, abbreviated to d.r.) produced for a selection of alkylating agents.

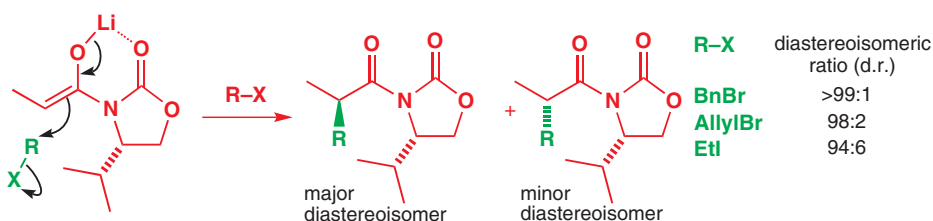

As you can see, none of these reactions is truly 100% diastereoselective and, indeed, only the best chiral auxiliaries (of which this is certainly one) give >98% of a single diastereoisomer. The problem with less than perfect diastereoselectivity is that, when the chiral auxiliary is removed, the final product is contaminated with some of the other enantiomer. A 94:6 ratio of diastereoisomers will result in a 94:6 ratio of enantiomers, or a sample of 94:6 e.r. (e.r. for enantiomeric ratio).

Enantiomeric excess

Compounds that are neither racemic nor enantiomerically pure are usually called *enantiomerically enriched*. Chemists have two ways of referring to the ratio of enantiomers in an enantiomerically enriched sample. The first is the simple one we have just used: e.r. or enantiomeric ratio, expressed as two numbers adding to 100. More common, however, is to express this ratio as an *enantiomeric excess*. Enantiomeric excess (or ee) is defined as the excess of one enantiomer over the other, expressed as a percentage of the whole. So a 94:6 mixture of enantiomers consists of one enantiomer in 88% excess over the other, and we call it an enantiomerically enriched mixture with 88% ee. Why not just say that we have 94% of one enantiomer? Enantiomers are not like other isomers because they are simply mirror images. The 6% of the minor enantiomer can be paired with 6% of the major isomer to form a racemic mixture amounting to 12% of the total. The mixture contains 12% racemate and 88% of one enantiomer, hence 88% ee.

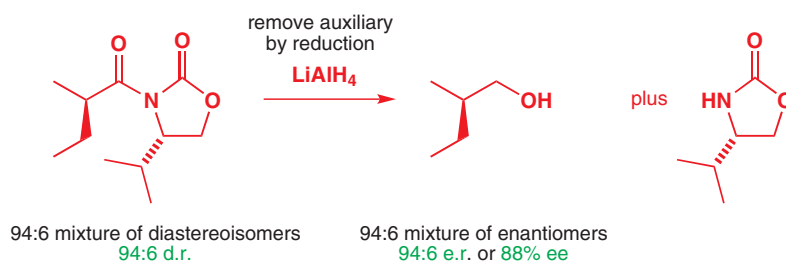

We will see shortly how we can make further use of the chiral auxiliary to increase the ee of the reaction products. But first, we should consider how to measure ee. One way is simply to measure the angle through which the sample rotates plane-polarized light. The angle of rotation is approximately proportional to the enantiomeric excess of the sample (see box). The problem with this method is that to measure an actual value for ee you need to know what rotation a sample of 100% ee gives, and that is not always possible. Also, polarimeter measurements are notoriously unreliable—they depend on temperature, solvent, and concentration, and are subject to massive error due to small amounts of highly optically active impurities.

Is optical rotation proportional to enantiomeric excess?

Imagine you have a sample, A, of an enantiomerically pure compound—a natural product perhaps—and, using a polarimeter, you find that it has an $[\alpha]_D$ of +10.0. Another sample, B, of the same compound, which you know to be *chemically* pure (perhaps it is a synthetic sample), shows an $[\alpha]_D$ of +8.0. What is its enantiomeric excess? Well, you would have got the same value of 8.0 for the $[\alpha]_D$ of B if you had mixed 80% of your enantiomerically pure sample A with 20% of a racemic (or achiral) compound with no optical rotation. Since you know that sample B is chemically pure, and is the same compound as A, it must therefore indeed consist of 80% enantiomerically pure material plus 20% racemic material, or 80% of one enantiomer plus 20% of a 1:1 mixture of the two enantiomers—which is the same as 90% of one enantiomer and 10% of the other, or 80% enantiomeric excess. Optical rotations can give a guide to enantiomeric excess—sometimes called *optical purity* in this context—but slight impurities of compounds with large rotations can distort the result and there are some examples where the linear relationship between ee and optical rotation fails because of what is known as the Horeau effect. You can read more about this in Eliel and Wilen, *Stereochemistry of organic compounds*, Wiley, 1994.

Chemists now usually use chromatography, or occasionally spectroscopy, to quantify ratios of enantiomers. You may think that this should be impossible—since enantiomers are chemically identical and have identical NMR spectra, how can chromatography or spectroscopy tell them apart? Well, again, they are identical *unless they are in a chiral environment*. We introduced HPLC on a chiral stationary phase as a way of separating enantiomers preparatively in Chapter 14. The same method can be used analytically—less than a milligram of chiral compound can be passed down a narrow column containing silica modified with a chiral additive. One enantiomer passes through the silica faster than the other; the two enantiomers are separated and the quantity of each can be measured (usually by UV absorption or by refractive index changes) and an ee derived. Gas chromatography can be used in the same way—the columns are packed with a chiral stationary phase such as the isoleucine derivative shown in the margin.

➔ This is the principle on which resolution relies: see p. 322.

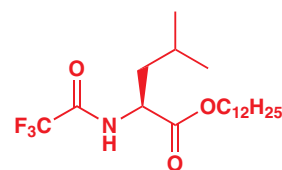

gas chromatography with this chiral stationary phase allows enantiomers to be separated

Distinguishing enantiomers spectroscopically relies again on putting them into a chiral environment. One way of doing this, if the compound is, say, an alcohol or an amine, is to make a derivative (an ester or an amide) with an enantiomerically pure and racemization-proof acyl chloride. The one most commonly used is known as Mosher's acyl chloride, after its inventor Harry Mosher, although there are many others. The two enantiomers of the alcohol or amine now become diastereoisomeric esters, and give different sets of peaks in the NMR spectrum—the integrals can be used to determine ee and, although the ^1H NMR of such a mixture of diastereoisomers may become quite cluttered because it is a mixture, the presence of the CF_3 group means that the ratio can alternatively be measured by integrating the two singlets in the otherwise featureless plain of the ^{19}F NMR spectrum.



Another powerful method of discriminating between enantiomers is to add an enantiomerically pure compound to the NMR sample that simply forms a complex with the compound under investigation. The complexes formed from the two opposite enantiomers are diastereoisomeric, and therefore have different chemical shifts and, by integrating the NMR signals, the ratio of enantiomers can be determined. Among the most commonly used is this alcohol, 2,2,2-trifluoro-1-(9-anthryl)ethanol, or TFAE, which can both hydrogen-bond to and form

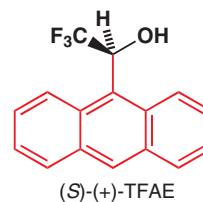

π -stacked complexes with a range of functionalized compounds, and often splits NMR signals due to enantiomeric compounds very cleanly.

Time to go back to chiral auxiliaries. We pointed out that, although we want to get maximum levels of stereoselectivity in our chiral-auxiliary-controlled reaction, we may still have a small percentage of a minor diastereoisomer, which, once we have removed our chiral auxiliary, will compromise the ee of our final product. It is at this point that we can use a trick that essentially employs the chiral auxiliary in a secondary role as a resolving agent. Provided the products are crystalline, it will usually be possible to recrystallize our 94:6 mixture of diastereoisomers to give essentially a single diastereoisomer, rather like carrying out a resolution with an enormous head start. Once this has been done, the chiral auxiliary can be removed and the product may be very close to 100% ee. Of course, the recrystallization sacrifices a few percentage points of yield, but these are invariably much less valuable than the few percentage points of ee gained! Here is an example from the work of Evans himself. During his synthesis of the complex antibiotic X-206 he needed large quantities of the small molecule below. He decided to make it by a chiral-auxiliary-controlled allylation, followed by reduction to give the alcohol. The auxiliary needed is the one derived from norephedrine, and the reaction of the enolate with allyl iodide gives a 98:2 mixture of diastereoisomers. However, recrystallization converts this into an 83% yield of a single diastereoisomer in >99% purity, giving material of essentially 100% ee after removal of the auxiliary.

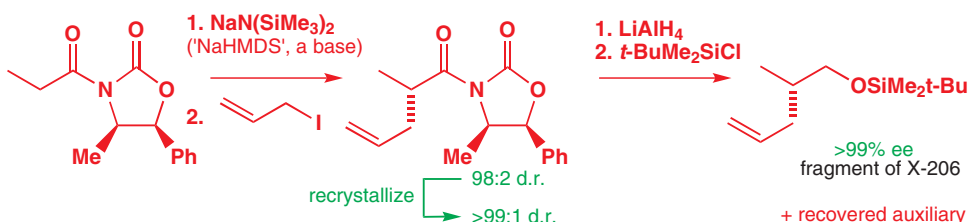

At this point we should also come clean about the asymmetric Diels–Alder reaction we introduced on p. 1108: it is not quite as selective as we implied—a minor diastereoisomer is formed in a 7% yield, with the major isomer accounting for 93%. But just one recrystallization gives >99% diastereoisomerically pure material in 81% yield.

This is one big bonus of using a chiral auxiliary—it's much easier to purify diastereoisomers than enantiomers and a chiral auxiliary-controlled reaction necessarily produces diastereoisomeric products.

Both these examples of auxiliary-controlled alkylation make use of LiAlH_4 reduction to the alcohol in the step which removes the auxiliary. You saw attack with an alkoxide above, and several other alternative methods are possible as well, summarized below. DIBAL ($i\text{-Bu}_2\text{AlH}$, p. 533) reduces the product to an aldehyde, while converting the product to a Weinreb amide (p. 219) makes formation of a ketone possible.

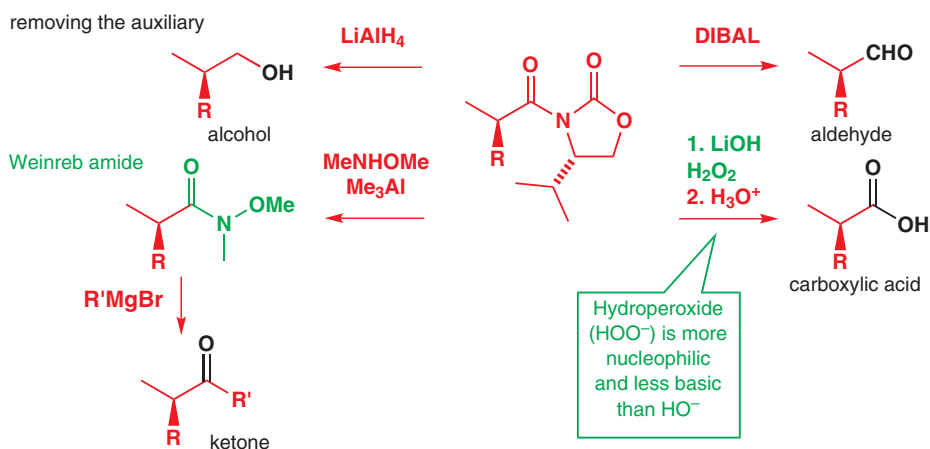

Epimers are pairs of diastereoisomers differing in configuration at just one chiral centre.

Epimerization is the interconversion of such diastereoisomers just as racemization is the interconversion of enantiomers.

Simple hydrolysis under acid or basic conditions risks epimerizing the newly created chiral centre, and a good solution is to use the less basic, more nucleophilic hydroperoxide anion. This was the approach taken by chemists making this component of a collagenase inhibitor. Notice that this auxiliary is a variant based on L-phenylalanine.

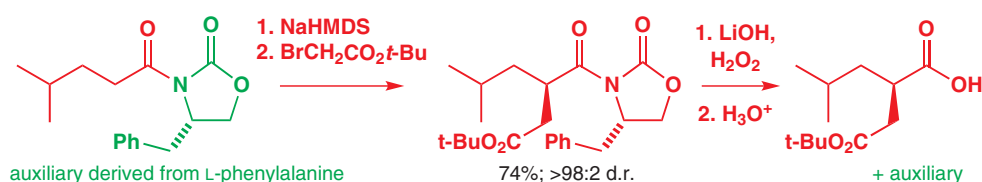

These various ways of removing auxiliaries illustrate the ways in which it is possible to make a virtue out of one of their big disadvantages: chiral auxiliaries must first be attached to the compound under construction, and after they have done their job they must be removed. The best auxiliaries can be recycled, but even then there are still at least two ‘unproductive’ steps in the synthesis.

➔ The reason for the greater nucleophilicity of the hydroperoxide anion is discussed in Chapter 22, p. 513.

Oxazolidinones are not the only auxiliaries

Other auxiliaries are also used, and the choice of auxiliary may depend not only on the selectivity of the reaction under investigation but also on the physical properties of the products. The camphor-based auxiliary of Oppolzer is reputed to confer crystallinity on its derivatives, while the pseudoephedrine auxiliary of Myers is cheap, readily available, and very easy to introduce. More bulky auxiliaries such as 8-phenylmenthol work well where control over long-range interactions, such as conjugate additions, are required.

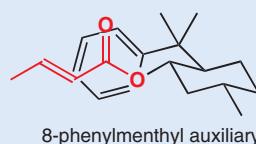
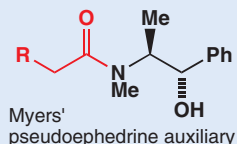
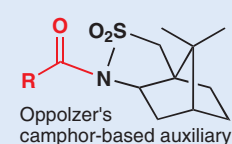

🔍 Interactive mechanism for Oppolzer's sultam in conjugate addition

🔍 Interactive mechanism for 8-phenylmenthol in Diels–Alder reaction

Chiral reagents

A chiral auxiliary is a chiral molecule attached to the starting material of the reaction; diastereoselective reactions of compounds from the chiral pool are likewise controlled by chirality in the starting material, and we call this type of stereocontrol *substrate control*. But it is also possible for enantioselective reactions to be controlled by chiral *reagents*. For example, a typical achiral base will just remove a proton from a substrate, but an enantiomerically pure chiral base can select one of two enantiotopic protons and form a product enantioselectively. The product of course has to be chiral, so we can't use a chiral base to make planar enolates enantioselectively, for example, but we can a chiral base to make chiral organolithiums.

Alkylolithiums are sufficiently strong as bases to remove the protons adjacent to the nitrogen atom of *N*-Boc pyrrolidine, shown in the margin. The product of deprotonation is an organolithium which is a chiral molecule: the lithium-bearing carbon is chiral.

Alkylolithiums can be turned into chiral bases in quite a simple way—by complexation with a chiral ligand. A widely used example is the tetracyclic diamine (–)-sparteine. Sparteine's structure looks complex, but it is a relatively widely available natural product which folds around the lithium atom of an alkylolithium and places the base in a chiral environment.

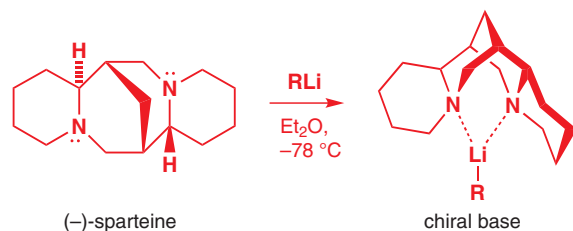

This chiral base can now choose to remove from the pyrrolidine substrate just one of the enantiotopic protons adjacent to nitrogen, and form a chiral, enantiomerically enriched organolithium. The stereochemistry of the organolithium is preserved through its reactions with electrophiles such as the ketone shown here.

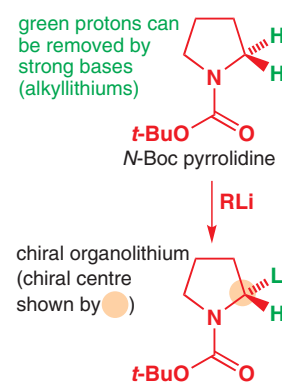

Interactive mechanism for sparteine-mediated lithiation

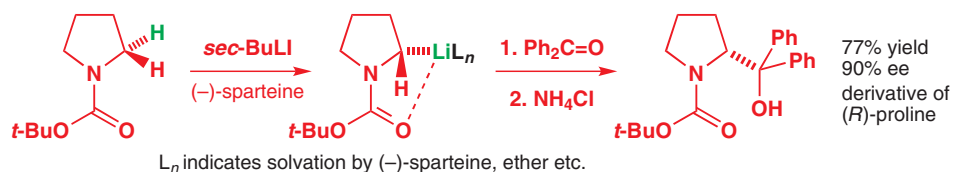

One of the reasons this reaction is so useful is that the products happen to be derivatives of the less readily available (*R*)-proline. But, as with chiral auxiliaries, if you use a chiral reagent you need a full equivalent of the source of enantiomeric purity (here, (-)-sparteine) which can get prohibitively expensive on a large scale. It is for this reason that the real pinnacles of achievement in asymmetric synthesis make use of *asymmetric catalysis*, which we turn to next.

Asymmetric catalysis

➔ Look back at Chapters 31 and 33 (p. 820) if you need reminding about the terms prochiral, enantiotopic, and diastereotopic.

If we want to create a new chiral centre in a molecule, our starting material must have **prochirality**—the ability to become chiral in one simple transformation. The most common prochiral units that give rise to new chiral centres are the trigonal carbon atoms of alkenes and carbonyl groups, which become tetrahedral by addition reactions. In the last section you saw a prochiral, tetrahedral CH_2 group becoming a chiral organolithium by enantioselective removal of one enantiotopic proton. Much more common are the reactions you saw in the section before that, where in every case a prochiral alkene (we can count enolates as alkenes for this purpose) reacted selectively on one face because of the influence of the chiral auxiliary, which made the faces of the alkene diastereotopic.

Catalytic asymmetric reduction of ketones

One of the simplest transformations you could imagine of a prochiral unit into a chiral one is the reduction of a ketone. Although chiral auxiliary strategies have been used to make this type of reaction asymmetric, conceptually the simplest way of getting the product as a single enantiomer would be to use a chiral reducing agent—in other words, to attach the chiral influence not to the *substrate* (as we did with chiral auxiliaries) but to the *reagent*. We need an asymmetric version of NaBH_4 .

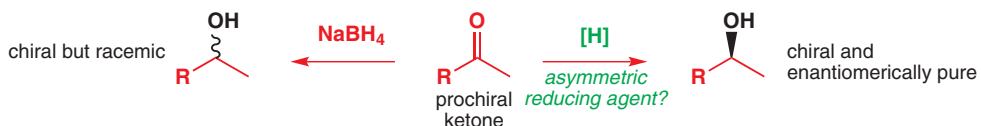

One of the more widely used solutions to this challenge is the chiral borohydride analogue invented by Itsuno in Japan and developed by Corey, Bakshi, and Shibata. It is based on a stable boron heterocycle made from an amino alcohol derived from proline (see the box below for the synthesis), and is known as the CBS catalyst after its developers. The active reducing agent is generated when the heterocycle forms a complex with borane. Only catalytic amounts (usually about 10%) of the boron heterocycle are needed because borane is sufficiently reactive to reduce ketones only when complexed with the nitrogen atom. The rest of the borane just waits until a molecule of catalyst becomes free.

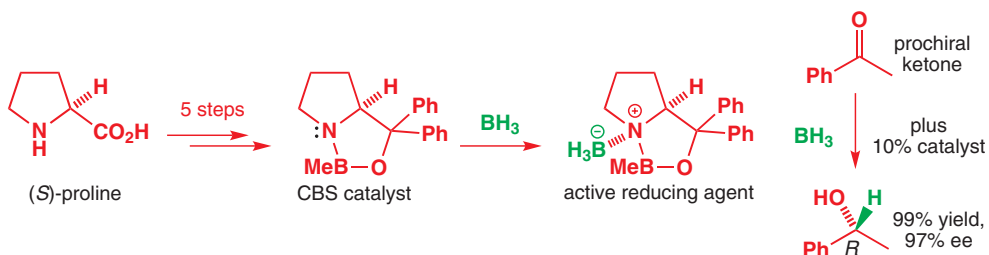

■ The fact that the reactions are catalytic in the heterocycle means that relatively little is needed. Note the distinction from chiral auxiliaries here: although auxiliaries are recoverable, they always have to be used in stoichiometric quantities and recovery is usually a separate step. Later in the chapter you will see catalytic reactions that use 1000 times less catalyst than this one.

CBS reductions are best when the ketone's two substituents are well-differentiated sterically—just as Ph and Me are in the example above. The reaction works because the heterocyclic

catalyst brings together the borane (which complexes to its basic nitrogen atom) and the carbonyl compound (which complexes to its Lewis-acidic boron atom). Complexation activates both partners towards reaction: donating electron density to the borane is essential to persuade it to transfer hydride, and withdrawing electron density from the carbonyl group makes it electrophilic enough to react with a weak hydride source. The hydride is delivered via a six-membered cyclic transition state, with the enantioselectivity arising from the preference of the larger of the ketone's two substituents (R_L) for the pseudoequatorial position on this ring.

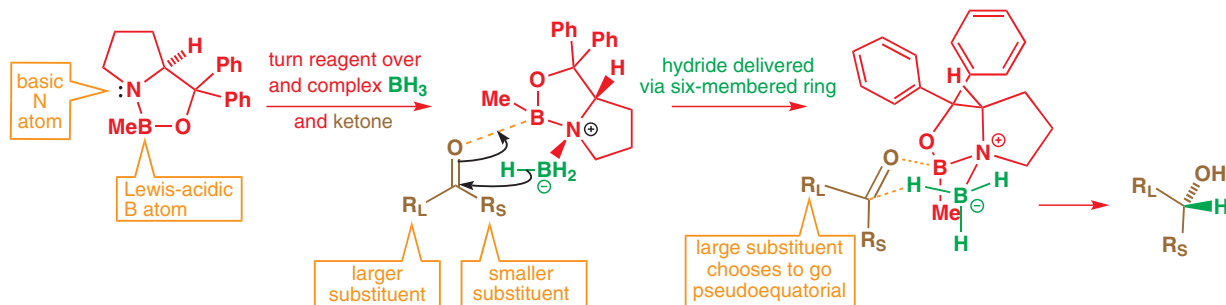

 Interactive asymmetric reduction of ketone with CBS catalyst

Making the CBS catalyst

To make the CBS heterocycle, (*S*)-proline has to be protected as its *N*-Cbz derivative (Chapter 23) and converted to its methyl ester. Esters react with Grignard twice to give tertiary alcohols (Chapter 10), so PhMgBr followed by deprotection gives the amino alcohol needed. Condensation with methylboronic acid ($\text{MeB}(\text{OH})_2$) gives the stable catalyst.

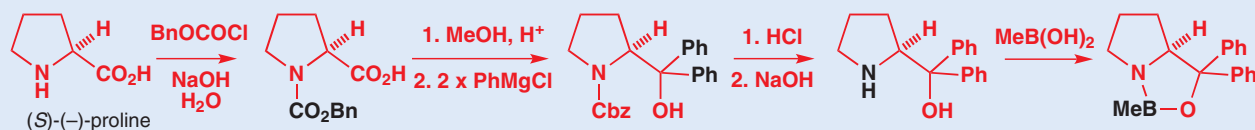

To make the other enantiomer, you would need the rather more expensive 'unnatural' (*R*)-proline, which you can make by the method of p. 1114, but in such a case you might consider using one of the alternative reduction methods described below.

Until recently, the CBS reagent was one of the most commonly used asymmetric reducing agents for ketones. But in the early years of the 21st century a new reaction has taken over that role—one in which the job of bringing together the ketone and the reducing agent is taken by an atom of ruthenium. The ruthenium is added as Ru(II) in a 16-electron complex (see p. 1116) with an aromatic compound such as 1,3,5-trimethylbenzene (known as mesitylene). A chiral ligand is needed—the diamine derivative shown here is best. Only very small amounts (often $\ll 1\%$) of the catalyst and ligand are required, which is a good thing as both are much more expensive than the reagents in the CBS reduction. The reducing agent itself can be hydrogen or, more conveniently, a more easily handled source of hydrogen atoms such as isopropanol (which gets oxidized to acetone) or formic acid (which gets oxidized to carbon dioxide). Here's a typical example; we will explain how it works shortly.

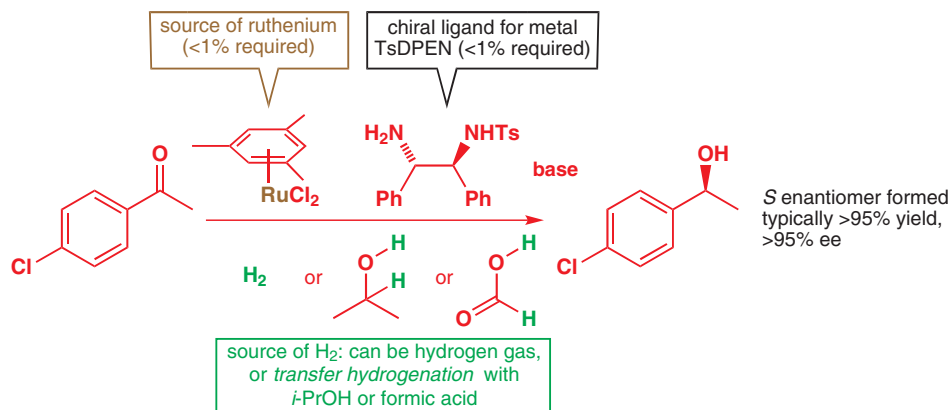

This revolution in asymmetric catalysis using chiral complexes of transition metals was made possible principally by the work of Ryoji Noyori (who developed the Ru- and Rh-catalysed reductions we describe in this chapter) and of K. Barry Sharpless (who developed the Os- and Ti-catalysed oxidations). This work won Noyori and Sharpless the Nobel Prize for Chemistry in 2001, along with William Knowles (who was the first to apply metal-catalysed asymmetric reactions to industrial targets).

■ This section discusses several reactions of organometallic compounds. In order to understand their mechanisms you must be familiar with the terminology associated with organometallic complexes, such as how to 'count electrons', described in Chapter 40.

 Interactive mechanism for ruthenium-catalysed ketone hydrogenation

■ To show how fast this area is moving, we can quote from the first edition of this textbook, published in 2001: 'You would not normally choose catalytic hydrogenation for reducing a carbonyl group to an alcohol and, indeed, carbonyl reductions using hydrogenation with a chiral catalyst are not usually very enantioselective.' A lot has changed in little more than a decade.

You have met several reactions of ruthenium complexes, especially in Chapters 38 and 40, where you saw ruthenium carbenes catalysing the metathesis of alkenes. Ruthenium is one of a select group of transition metals (Pd, Ru, Rh, Cu, Os, and Ti being the others) which play an important role in asymmetric catalysis. The key to their success is the transition metal coordination chemistry we looked at in the last chapter: the metals can act as coordination sites for substrates, and by using other ligands which are chiral and enantiomerically pure, the reactions they catalyse can be made to take place in an asymmetric environment.

The ruthenium-catalysed reduction of ketones starts with coordination of the tosyl-diamine ligand ((*S,S*)-*N*-toluenesulfonyl 1,2-phenylenediamine, or 'TsDPEN') to the ruthenium metal. This is a 16-electron complex, and can be reduced by formic acid to an 18-electron ruthenium hydride.

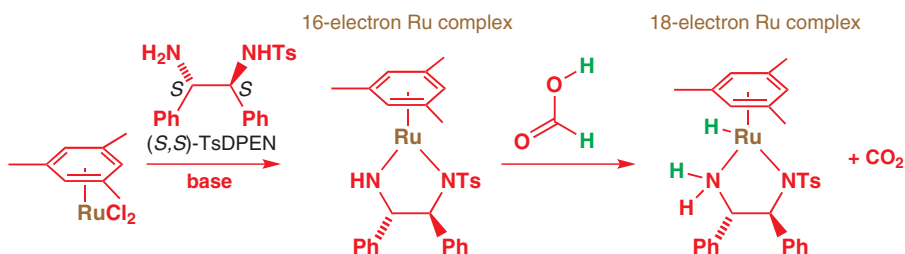

Now comes the reduction. Provided the ketone approaches the ruthenium complex in the right orientation, with the smaller methyl group tucked in under the ruthenium and the larger aryl group pointing away from the bulky ligands, the 18e complex can transfer to the carbonyl group simultaneously H⁻ from Ru and H⁺ from the protonated nitrogen. The chiral ligand means that the alcohol is formed as a single enantiomer, and the ruthenium catalyst is regenerated.

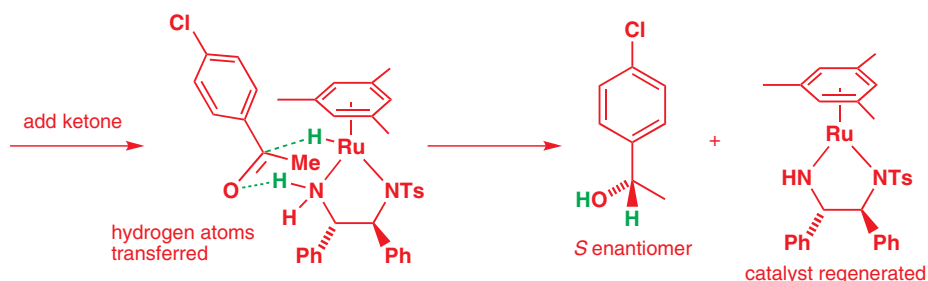

The reduction shown below is particularly important because it generates a late intermediate in the industrial synthesis of the anti-asthma drug montelukast (Singulair). Several methods have been used, but in 2008 chemists at the Croatian pharmaceutical company Pliva patented a method using the ruthenium catalyst with a derivative of TsDPEN as a ligand to give the product in 83% yield and 99.8% ee on a scale of several kilograms.

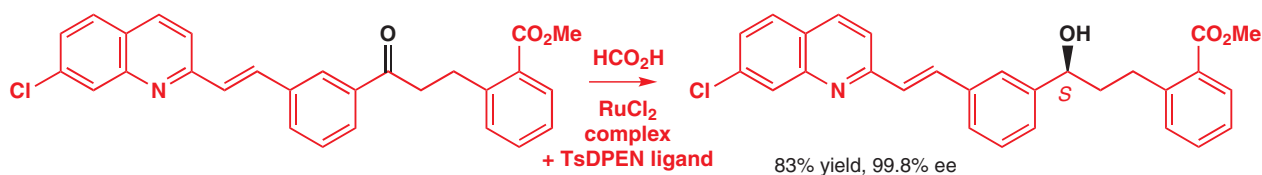

● Two methods for reducing carbonyl compounds enantioselectively

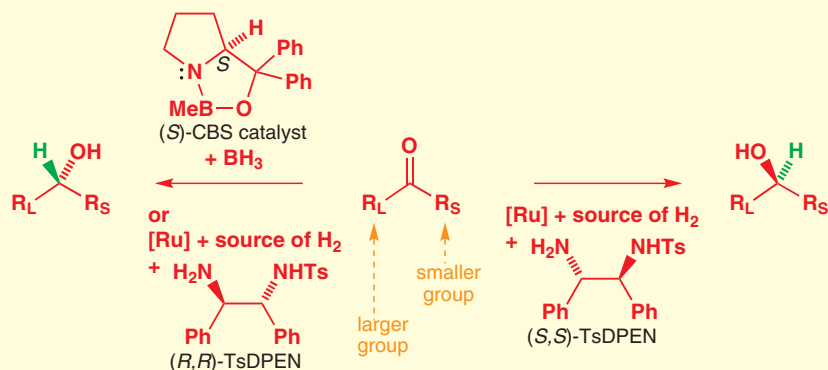

Catalytic asymmetric hydrogenation of alkenes

Reduction of a ketone can give a chiral secondary alcohol, but reduction of an alkene by addition of hydrogen to one of its two enantiotopic faces can give all sorts of products, creating either one or two chiral centres, depending on the substituents on the alkene. By way of illustration (and explanation will follow soon) the alkene hydrogenation below creates, in one step, the two chiral centres of a precursor to the anti-obesity drug taranabant. A single diastereoisomer is formed by *syn* addition of hydrogen, and a chiral ligand ensures that one enantiomer is formed preferentially.

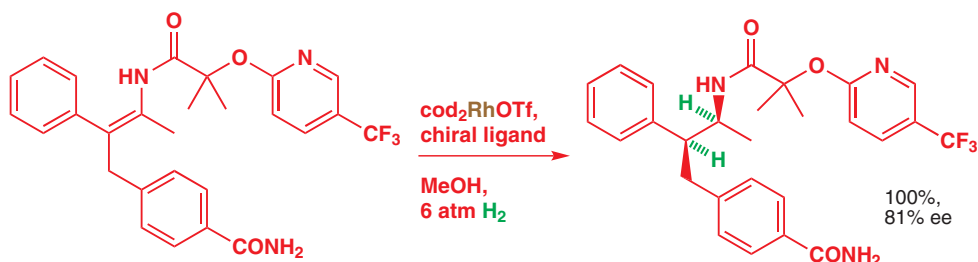

You have seen numerous hydrogenations of alkenes using hydrogen over a solid catalyst of palladium supported on charcoal ('heterogeneous hydrogenation'), but catalytic asymmetric hydrogenation of alkenes uses a different type of catalyst—a soluble complex, often of Ru or Rh with phosphine-containing ligands. The substrates for asymmetric alkene hydrogenation are also more limited than those for hydrogenation with Pd/C because they must carry a functional group close to the alkene, allowing coordination to the transition metal catalyst. In the example above, that functional group is the amide directly adjacent to the alkene.

The inspiration for these catalysts came from the work of Wilkinson in London in the 1960s, who showed that $\text{RhCl}(\text{PPh}_3)_3$ (known as Wilkinson's catalyst) promoted *homogeneous* hydrogenation of alkenes (i.e. during the reaction there is only one, solution, phase). Wilkinson's catalyst is a 16-electron complex of Rh(I), and it works as a catalyst because it can easily lose one of the phosphine ligands to form a 14-electron complex. This undergoes addition of H_2 , giving a 16-electron Ru(III) complex.

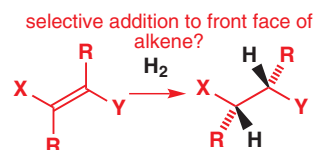
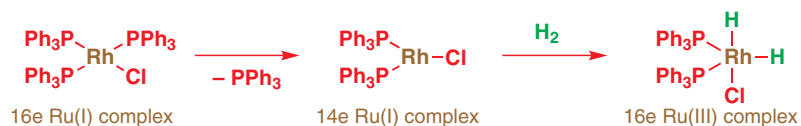

■ cod is the ligand cyclooctadiene, and 6 atmospheres pressure of H_2 is used.

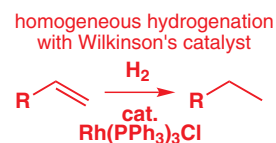

➔ See p. 1074 for more on Wilkinson's catalyst.

The complex is still coordinatively unsaturated, so an alkene can form a π complex with a full complement of 18 electrons. Migratory insertion of one of the hydrogen atoms, followed by reductive elimination, gives back the 14-electron Rh complex and the reduced alkane.

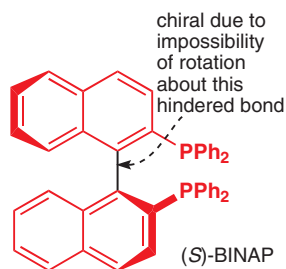
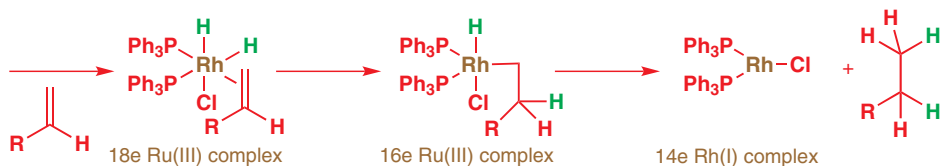

■ The detailed mechanism of this reaction is too complicated for us to examine here. Unusually, it involves two diastereoisomeric complexes, of which the more reactive is the one which is less favoured.

The conceptual advance which allows this sort of hydrogenation to become asymmetric is the replacement of the two achiral triphenylphosphine ligands of Wilkinson's catalyst with chiral phosphine ligands. Notice that two of the triphenylphosphines remain coordinated through the whole reaction mechanism, so by doing this we can ensure that the Rh always remains in a chiral environment.

The usual solution is to use one chiral molecule containing two phosphorus atoms, and the most important of these is BINAP. BINAP is a chelating diphosphine: the metal sits between the two phosphorus atoms, firmly anchored in a chiral environment. The chirality here is of an unusual sort, since BINAP, which you met in Chapter 14 (p. 319), has no chiral centres. It is one of the class of chiral molecules, known as *atropisomers*, whose chirality arises from the inability of the bond between the two naphthalene rings to rotate.

Incorporating (S)- or (R)-BINAP into a hydrogenation with Rh can lead to high enantiomeric excesses in the products because during the migratory insertion step the complex is forced to transfer hydrogen to only one of the two possible enantiotopic faces of the alkene. As we remarked before, asymmetric hydrogenations require a functional group which can coordinate to the metal, and with Rh the best substrates are *N*-acyl enamines. Those of the type shown below give excellent results, and usefully with (S)-BINAP the products are protected amino acids of the opposite enantiomeric series to those found in nature.

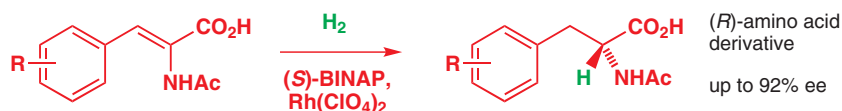

Industrial synthesis of L-dopa

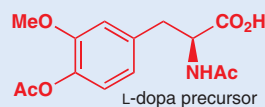

A related hydrogenation to give the product above, using a different catalyst, was developed by William Knowles at Monsanto. This hydrogenation was the first demonstration of the use of asymmetric catalysis in the synthesis of a chiral drug, and Knowles shared the Nobel Prize in 2001 with Noyori and Sharpless.

It is even economical for the more expensive of the natural amino acids to be made synthetically by this type of reaction rather than isolated from natural sources—phenylalanine, which is of industrial importance as a component of the artificial sweetener aspartame (NutraSweet), is manufactured using enantioselective hydrogenation.

Noyori found that using ruthenium instead of rhodium broadens greatly the scope of the substrates that will undergo asymmetric hydrogenation. They still need a functional group—usually the OH group of an alcohol or a carboxylic acid—to allow coordination to the metal, but the alkene itself can be a simple allylic alcohol or unsaturated acid derivative. BINAP is again a good ligand, and of course by choosing which enantiomer of BINAP you use you can choose which enantiomer of the product you get.

Ru-catalysed asymmetric hydrogenation of unsaturated carboxylic acids

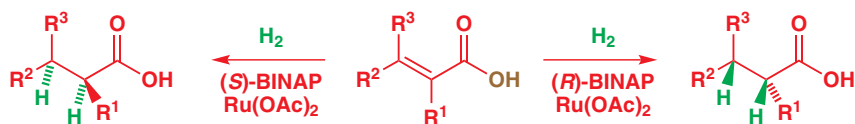

Ru-catalysed asymmetric hydrogenation of allylic alcohols

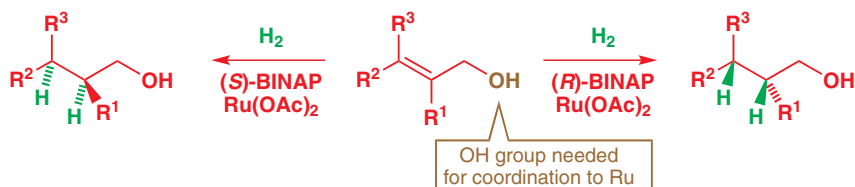

Two important industrial asymmetric syntheses which routinely use this chemistry are the production of the painkiller (*S*)-naproxen and the synthetic intermediate and perfumery compound (*R*)-citronellol. It is gratifying to note that this chemistry, using <1% of Ru, gives citronellol in higher enantiomeric purity than many natural sources of the same compound!

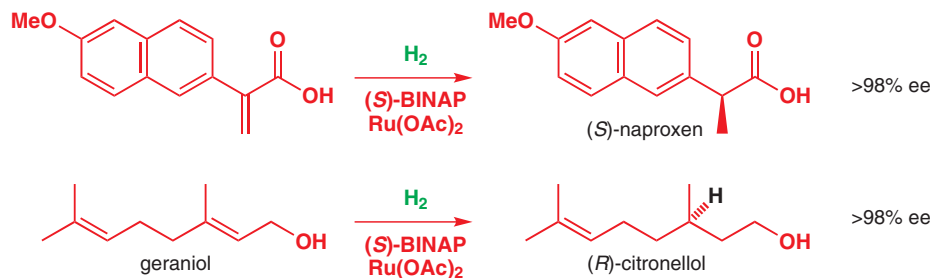

Reduction of unsaturated carboxylic acids gives products that you might alternatively think of making by auxiliary-controlled alkylation methods. When the NutraSweet company needed this chiral branched carboxylic acid as a single enantiomer, they initially used the auxiliary methods of p. 1110 to make a small amount, but they found that ruthenium-catalysed hydrogenation was greatly to be preferred on a large scale: just 22 g of the ruthenium-(&i>S)-BINAP complex is needed to produce 50 kg of product with 90% ee.

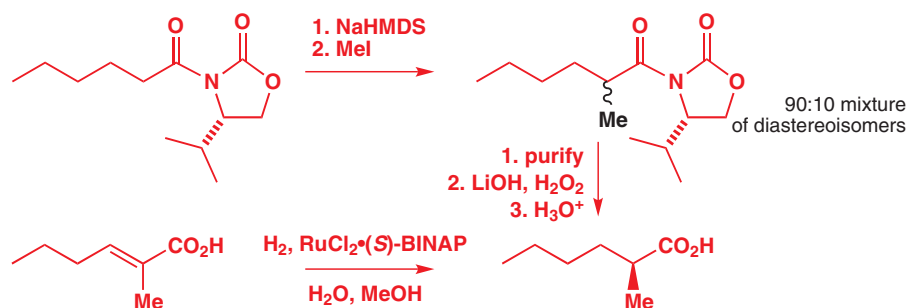

In the last 20 years, the variety of ligands available for rhodium and ruthenium-catalysed hydrogenations has increased to the point where the right combination of metal and ligand will reduce almost any unsaturated carboxylic acid derivative in high enantiomeric excess. Details are beyond the scope of this book, but we leave you with four examples, all from industrial drug syntheses, to illustrate how versatile the method can be.

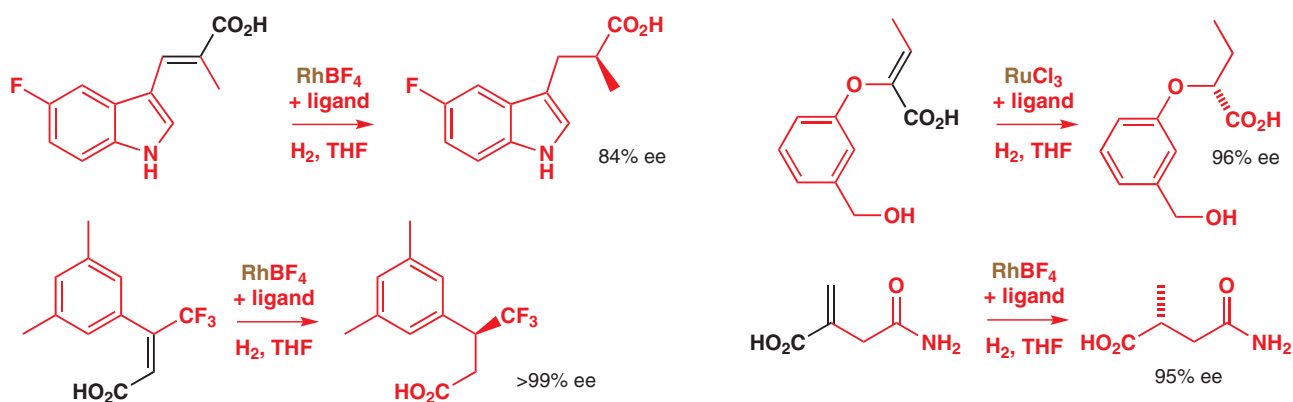

Resolution of BINAP

BINAP is not derived from a natural product, and has to be synthesized in the laboratory and resolved using a naturally derived resolving agent. The scheme shows one method by which enantiomerically pure BINAP may be made—the resolution step is unusual because it relies on formation of a molecular complex, not a salt. The bis phosphine oxide of (*S*)-BINAP co-crystallizes with di-*O*-benzoyl-*L*-tartarate, leaving the (*R*)-phosphine oxide in solution. Base releases the pure (*R*)-phosphine oxide that is resolved, which is then reduced to the phosphine with trichlorosilane.

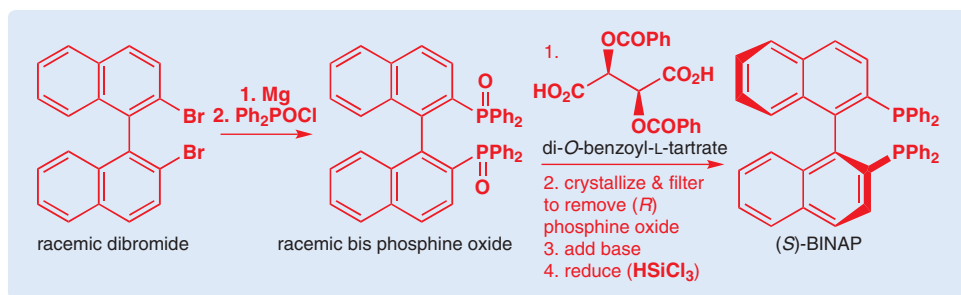

Asymmetric epoxidation

K. B. Sharpless (1941–) studied at Stanford and was first appointed at MIT but is now at the Scripps Institute in California. His undoubted claim to fame rests on the invention of no fewer than three reactions of immense significance: asymmetric epoxidation (AE) and asymmetric dihydroxylation (AD) are discussed in this chapter. The third reaction, asymmetric aminohydroxylation (AA), has still to reach the perfection of the first two.

Asymmetric *hydrogenation* of an alkene can create two new chiral centres, but introduces no new functionality as it does so. Asymmetric *oxidation* of an alkene is different: it can create two new chiral centres and two new functional groups at the same time. We will now look at two examples of asymmetric oxidation, both products of the laboratories of Professor Barry Sharpless.

The first of Sharpless's reactions is an oxidation of alkenes by asymmetric epoxidation. You met vanadium as a transition-metal catalyst for epoxidation with *t*-butyl hydroperoxide in Chapter 32, and this new reaction makes use of titanium, as titanium tetraisopropoxide, $\text{Ti}(\text{O-}i\text{-Pr})_4$, to do the same thing. Sharpless and his co-worker Tsutomu Katsuki surmised that by adding a chiral ligand to the titanium catalyst they might be able to make the reaction asymmetric. The ligand that works best is diethyl tartrate, and one example of the reaction is shown below.

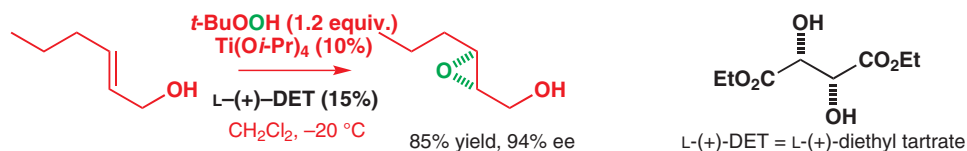

Transition-metal-catalysed epoxidations work only on allylic alcohols, so this is a limitation of the method, but otherwise there are few restrictions on what can be epoxidized enantioselectively, and when this reaction was discovered in 1981 it was by far the best asymmetric reaction known. Because of its importance, a lot of work went into discovering exactly how the reaction worked, and the scheme below shows what is believed to be the active complex, formed from two titanium atoms bridged by two tartrate ligands (shown in orange). Each titanium atom retains two of its isopropoxide ligands and is coordinated to one of the carbonyl groups of the tartrate ligand. The reaction works best if the titanium and tartrate are left to stir for a while so that these dimers can form cleanly. When the oxidizing agent (*t*-BuOOH, shown in green) is added to the mixture, it displaces one of the remaining isopropoxide ligands and one of the tartrate carbonyl groups.

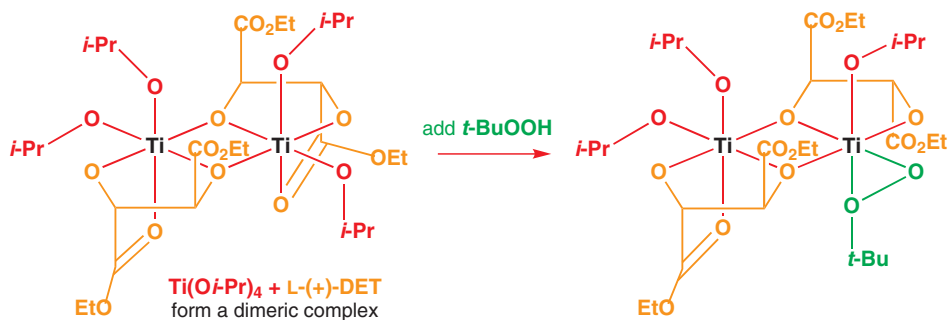

For this oxidizing complex to react with an allylic alcohol, the alcohol must become coordinated to the titanium too, displacing a further isopropoxide ligand. Because of the shape

of the complex the reactive oxygen atom of the bound hydroperoxide has to be delivered to the lower face of the alkene (as drawn), and the epoxide is formed in high enantiomeric excess. Displacement of the product by another molecule of hydroperoxide starts the cycle again.

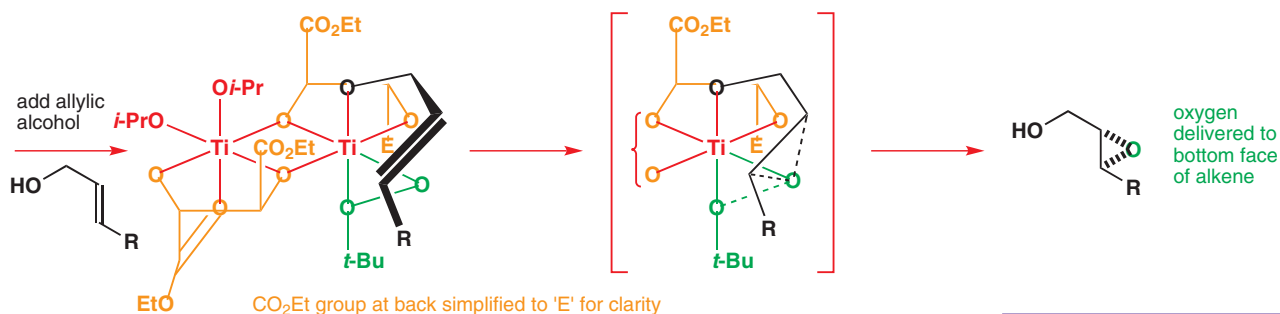

Different allylic alcohols coordinate in the same way to the titanium and reliably present the same enantiotopic face to the bound oxidizing agent, and the preference for oxidation with L-(+)-DET is shown in the schematic diagram below. Tartrate is ideal as a chiral ligand because it is available relatively cheaply as either enantiomer. L-tartrate is extracted from grapes; D-(−)-tartrate is rarer and more expensive, but still cheap by the standards of some of the biphosphine ligands used in the last section. By using D-(−)-tartrate it is, of course, possible to produce the other enantiomer of the epoxide equally selectively.

Interactive mechanism for the Sharpless epoxidation of allylic alcohols

● Enantioselectivity in the Sharpless asymmetric epoxidation

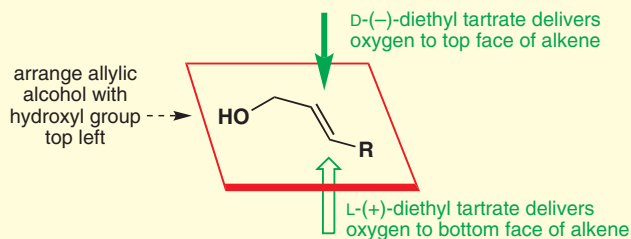

Sharpless also found that this reaction works with only a catalytic amount of titanium–tartrate complex because the reaction products can be displaced from the metal centre by more of the two reagents. The catalytic version of the asymmetric epoxidation is well suited to industrial exploitation, and the American company J. T. Baker has employed it to make synthetic disparlure, the pheromone of the gypsy moth, by oxidation of the epoxy alcohol to an aldehyde with pyridinium dichromate (PDC) (p. 543), Wittig reaction (p. 689), and hydrogenation.

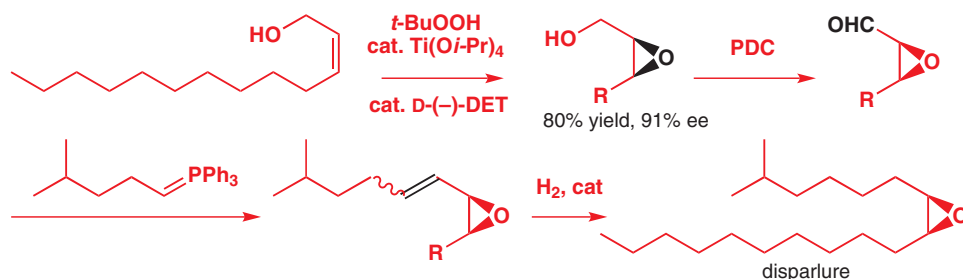

Not many target molecules are themselves epoxides, but the great thing about the epoxide products is that they are highly versatile—they react with many types of nucleophiles to give 1,2-disubstituted products. You met the chiral beta-blocker drug propranolol in Chapter 28, and its 1,2,3-substitution pattern makes it a good candidate for synthesis using asymmetric epoxidation.

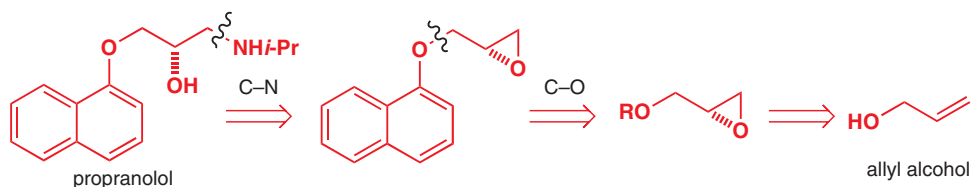

Unfortunately, the obvious starting material, allyl alcohol itself, gives an epoxide that is hard to handle, so Sharpless, who carried out this synthesis of propranolol, used this silicon-substituted allylic alcohol instead. The hydroxyl group was mesylated and displaced with 1-naphthoxide and, after treatment with fluoride to remove the silicon, the epoxide was opened with isopropylamine.

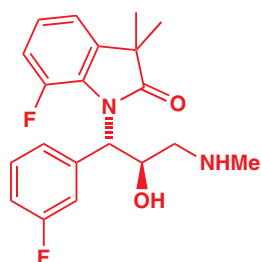
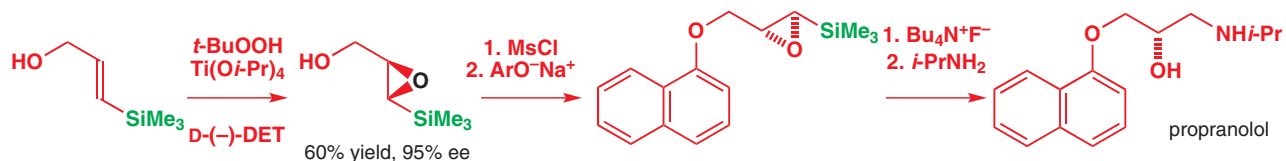

Chemists at the drug company Wyeth needed the amine shown in the margin. The 1,2,3-functional group pattern led them to think of using the Sharpless asymmetric epoxidation, and epoxidation of a fluorinated allylic alcohol using D-(-)-diisopropyl tartrate (DIPT) gave them the enantiomer they wanted with slightly better selectivity than diethyl tartrate. The benzylic end of the epoxide is more reactive towards nucleophilic substitution, and in the presence of $\text{Ti}(\text{O}-i\text{-Pr})_4$, this time simply acting as a Lewis acid, the lithiated heterocycle opens the epoxide with inversion of configuration.

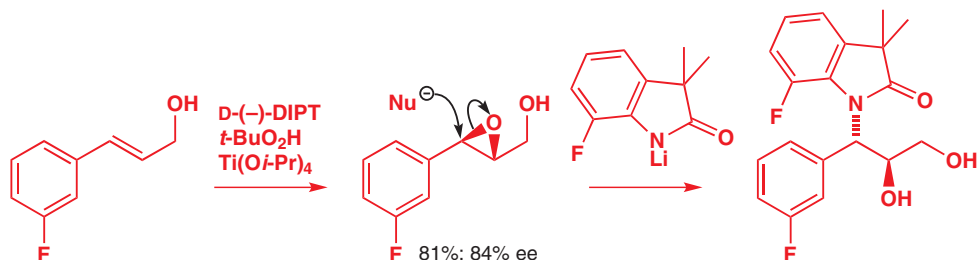

Finally, it's necessary to bring in the amino group, and this can be done by tosylating the less hindered primary hydroxyl group selectively, closing to an epoxide in base, and then reopening the epoxide at the less hindered terminal position with methylamine.

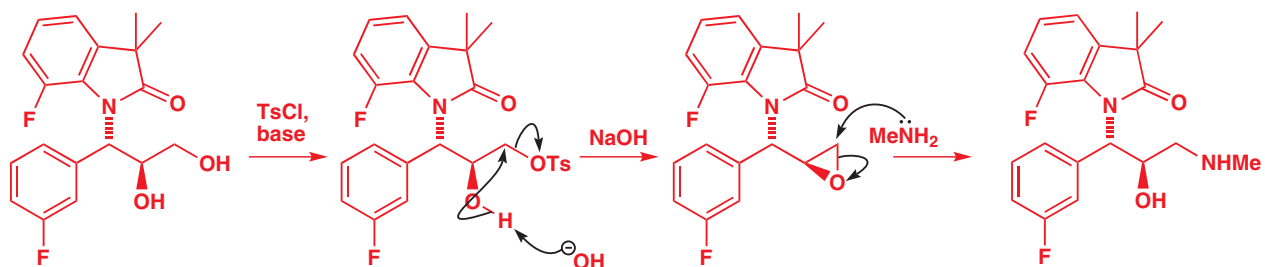

The Sharpless asymmetric epoxidation is reliable, but it works only for allylic alcohols. There is an alternative, however, which works with simple alkenes. The method was developed by Eric Jacobsen and employs a manganese catalyst with a chiral ligand built from a simple diamine. The diamine is not a natural compound and has to be made in enantiomeric form by resolution, but at least that means that both enantiomers are readily available. The diamine is condensed with a derivative of salicylaldehyde to make a bis-imine known as a 'salen'.

■ 'Salen' is an abbreviation of salicyl ethylenediamine and simpler salens had long been used as tetradentate ligands for coordination chemistry.

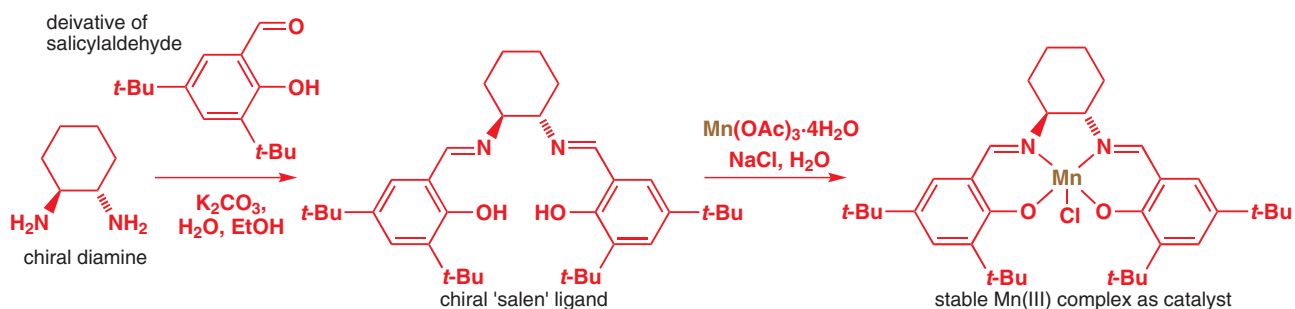

Mn(III) sits neatly in a tetracoordinate pocket in the ligand, and catalyses the epoxidation of simple alkenes by sodium hypochlorite, NaOCl, ordinary domestic bleach. Best results are obtained when the alkenes are *cis* (although an alternative range of ligands, developed by Tsutomu Katsuki, work well with *trans* alkenes), and one of the most significant applications of the Jacobsen epoxidation is with indene, which gives an epoxide in 84% ee with <1% of the catalyst. The mechanism of the reaction is complex and not fully understood, although it probably involves a Mn(V) oxo species and may involve radical intermediates.

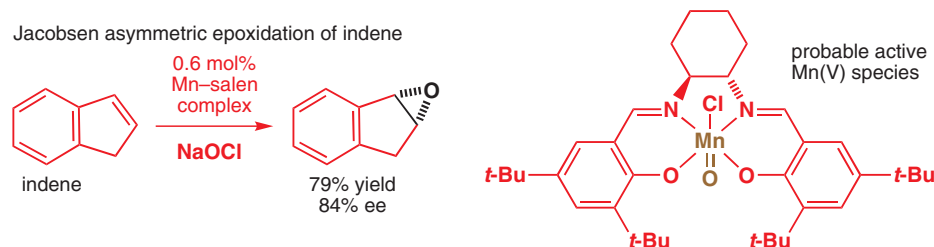

➔ This epoxide plays a starring role in the synthesis of the anti-HIV compound indinavir: see Chapter 43.

Together, the epoxidations of Sharpless, Jacobsen, and Katsuki, plus others we do not have space to cover, provide valuable solutions to many synthetic problems—in particular because epoxides are such useful reactive synthetic intermediates. But no epoxidation reaction is as general as the oxidation reaction we cover next.

Asymmetric dihydroxylation

This alternative asymmetric oxidation really is probably the best asymmetric reaction of all. It is an asymmetric version of the *syn* dihydroxylation of alkenes by osmium tetroxide. Here is an example—although the concept is quite simple, the recipe for the reactions is complicated so we need to approach it step by step.

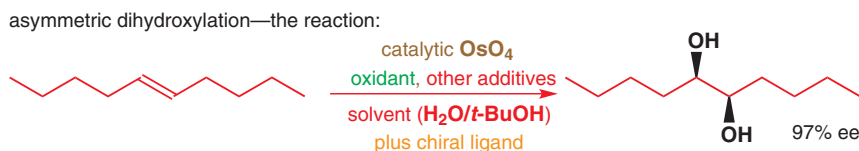

The active reagent is based on osmium(VIII) and is used in just catalytic amounts. This means that there has to be a stoichiometric quantity of another oxidant to reoxidize the osmium after each catalytic cycle— $\text{K}_3\text{Fe}(\text{CN})_6$ is most commonly used. Because OsO_4 is volatile and toxic, the osmium is usually added as $\text{K}_2\text{OsO}_2(\text{OH})_4$, which forms OsO_4 in the reaction mixture. The 'other additives' include K_2CO_3 and methanesulfonamide (MeSO_2NH_2), which increases the rate of the reaction by regenerating the catalyst at the end of each catalytic cycle.

Now for the chiral ligand. Tertiary amines are good ligands for osmium and increase the rate of dihydroxylations: one of the reasons that NMO is used in the racemic version of the reaction (see p. 442) is that the by-product, *N*-methylmorpholine, accelerates the reaction. Sharpless chose some available chiral tertiary amines as ligands, and it turned out that the best ones are based on the alkaloids dihydroquinidine and dihydroquinine, whose structures are shown below. They coordinate to the osmium through the green nitrogen atom.

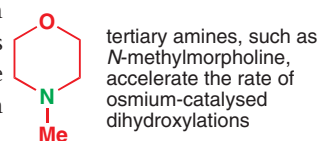

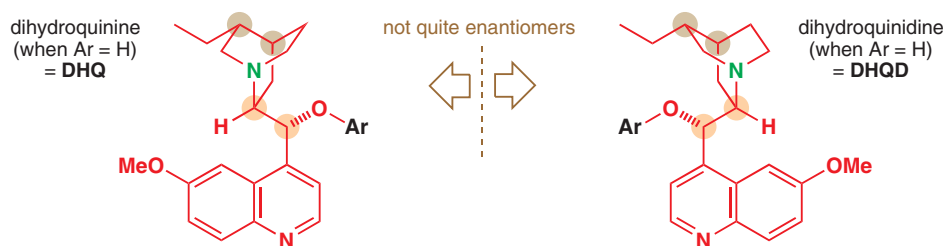

The alkaloids (usually abbreviated to DHQD and DHQ, respectively) must be attached to an aromatic group Ar, the choice of which varies according to the substrate. The most generally applicable ligands are these two phthalazines in which each aromatic group Ar carries two alkaloid ligands, either DHQ or DHQD.

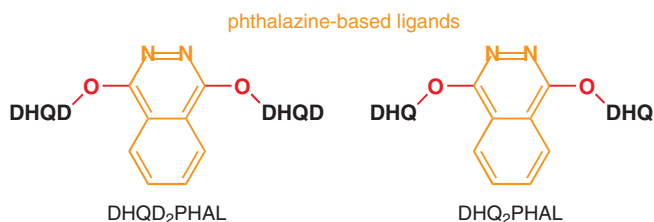

Dihydroquinine and dihydroquinidine are not enantiomeric (although the chiral centres ringed in orange are of opposite configuration in each of the pairs, those ringed in brown remain the same in both), but they act on the dihydroxylation as though they were.

Here, after all that introduction, is a real example, and probably the most remarkable of any in this chapter. *trans*-Stilbene dihydroxylates more selectively than any other alkene, and this particular example is one of the most enantioselective catalytic reactions ever invented.

AD-mix

A mixture of all the reagents except MeSO₂NH₂ can be purchased commercially as AD-mix. AD-mix- α contains DHQ₂PHAL, while AD-mix- β contains DHQD₂PHAL.

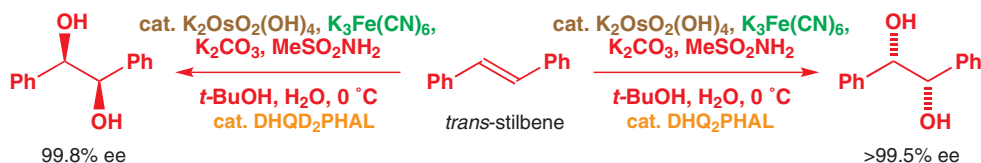

We can sum up the usual selectivity of the AD reaction with the diagram shown below. With the substrate arranged as shown, with the largest (R_L) and next largest (R_M) groups bottom left and top right, respectively, DHQD-based ligands will direct OsO₄ to dihydroxylate from the top face of the alkene and DHQ-based ligands the bottom face.

• Enantioselectivity in the Sharpless asymmetric dihydroxylation

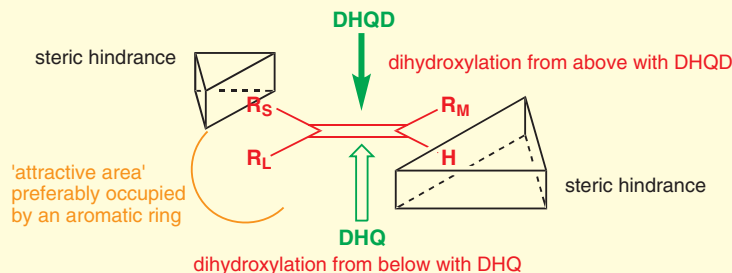

The reason for this must come from the way in which the substrate interacts with the osmium–ligand complex. However, the detailed mechanism of the asymmetric dihydroxylation is still far from clear-cut. What is known is that the ligand forms some sort of 'chiral pocket', like an enzyme active site, with the osmium sitting at the bottom of it. Alkenes can only approach the osmium if they are correctly aligned in the chiral pocket, and steric hindrance forces the alignment shown in the scheme above. The analogy with an enzyme active

site goes even further, since it appears that part of the pocket is 'attractive' to aromatic or strongly hydrophobic groups. This part appears to accommodate R_L , part of the reason why the selectivity in the dihydroxylation of *trans*-stilbene is so high.

The asymmetric dihydroxylation is much less fussy about the alkenes it will oxidize than Sharpless' asymmetric epoxidation. Osmium tetroxide itself is a remarkable reagent, since it oxidizes more or less any sort of alkene, electron-rich or electron-poor, and the same is true of the asymmetric dihydroxylation reagent. The following example illustrates both this and a synthetic use for the diol product.

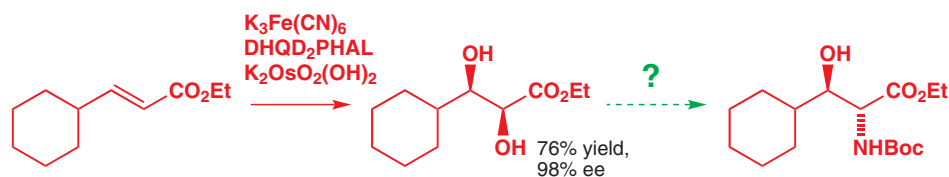

The chemists at Lilly in Spain who made this diol wanted to turn it into the protected amino acid shown after the dotted arrow as part of the synthesis of an anti-HIV compound. The ease with which diols can be made means that there are a number of reliable methods for transforming them into derivatives which undergo the sort of substitution needed. The one used here was to make the diol into a cyclic sulfate using sulfuryl chloride, SO_2Cl_2 . Cyclic sulfates behave like epoxides, and this one opens easily with azide at the more reactive position adjacent to the carbonyl group. Hydrolysis of the remaining sulfate ester, hydrogenation of the azide to the amine, and protection with Boc gave the target compound.

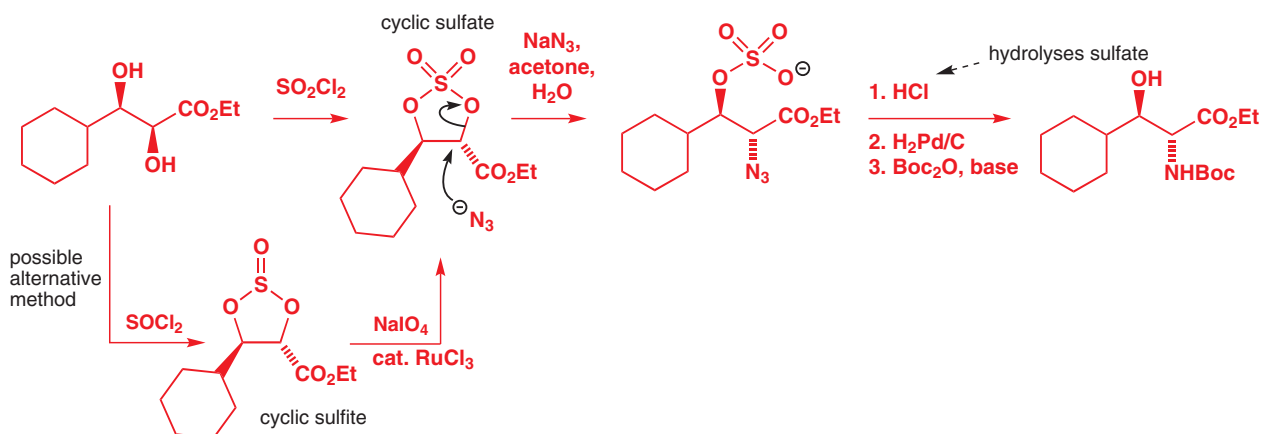

An alternative way of achieving the same transformation to the cyclic sulfate is to use thionyl chloride (SOCl_2) to give a sulfite, followed by ruthenium-catalysed oxidation to the sulfate.

Diols can even be converted with retention of stereochemistry directly to epoxides. Treatment of a diol with trimethyl orthoacetate and acetyl bromide gives firstly the cyclic orthoester, which opens with bromide to a regioisomeric mixture of the bromoacetates. The regiochemistry is irrelevant because treatment with base hydrolyses the ester and closes both of the resulting bromoalcohols to the same epoxide.

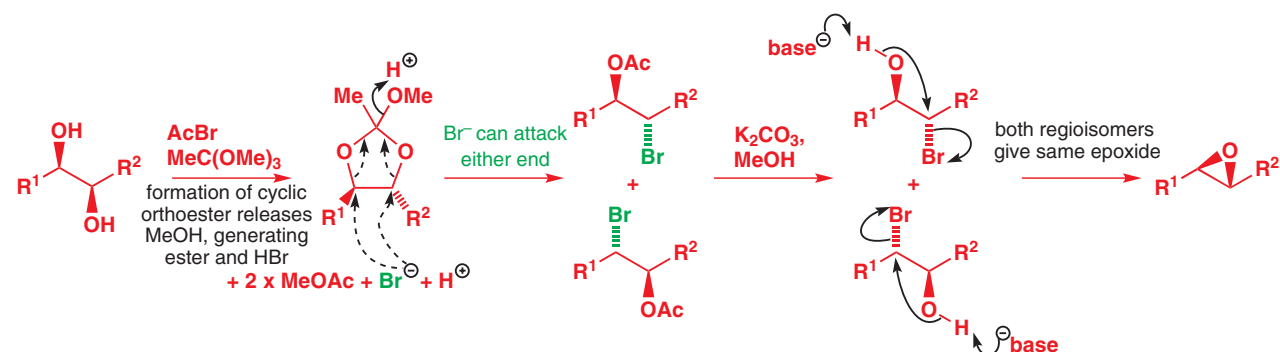

■ You can account for this by considering the mechanism of the dihydroxylation reaction (p. 905): it's a cycloaddition, so either the LUMO or the HOMO of the alkene can be involved.

■ We explained in Chapter 15 that S_N2 reactions adjacent to carbonyl groups are very fast. The regioselectivity of the ring opening of a cyclic sulfate, like that of an epoxide, is directed by the competition between relative rates of two nucleophilic substitution reactions. Benzylic and carbonyl-substituted positions usually open faster. There is more discussion of the regioselectivity of epoxide opening on p. 351.

➔ See Chapter 39, p. 1059, for more on orthoesters.

It's no surprise that when chemists from Bristol Myers Squibb needed the epoxide below, they turned to asymmetric dihydroxylation rather than either of the epoxidation methods we have shown you. Sharpless epoxidation works only with allylic alcohols, and Jacobsen epoxidation performs poorly here, giving only 70–74% ee (mainly because the substrate is not a *cis* alkene). However, asymmetric dihydroxylation saves the day with 98% ee and around 90% yield, and a variant of the reaction we have just shown you gives the epoxide, also in 90% yield—well worth the extra step.

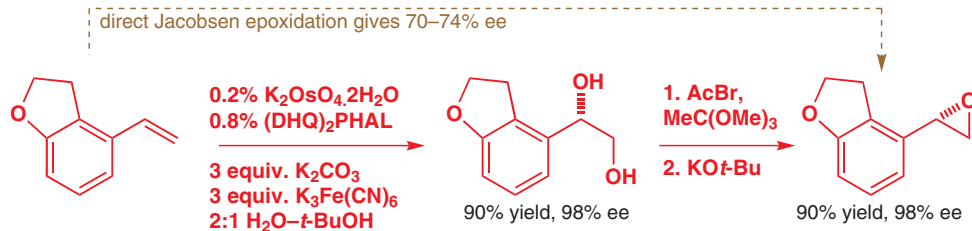

Ligand-accelerated catalysis

Asymmetric dihydroxylation is such a good reaction not just because of the careful way in which the ligands have been designed. It is a good reaction for a more fundamental reason: the reaction on which it is based (osmium-catalysed dihydroxylation) works only very poorly in the absence of the amine ligand. The chiral amine ligands don't just provide a chiral environment, they accelerate the reaction at the same time. This is what we mean by 'ligand accelerated catalysis'.

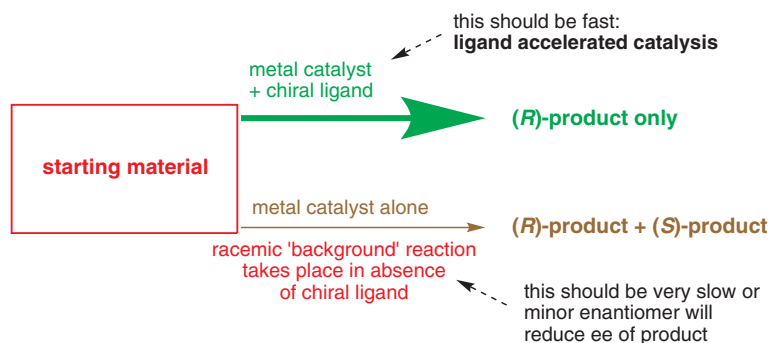

In any asymmetric reaction, we want the reagents to combine with one another only in the presence of the asymmetric influence provided by the chiral ligands. If the reaction works anyway, even without the chiral ligands, we have an uphill struggle because the reagents are quite capable of producing racemic product on their own. Racemic 'background' reactions are the reason why many of the reactions you are familiar with because they work so well racemically—addition of Grignard reagents to aldehydes, for example—don't really have good asymmetric versions. In the next section you will meet some more examples of reactions which are significantly accelerated by the presence of a chiral ligand.

■ In this section we will not consider the detailed mechanisms by which the stereochemistry of the ligand controls the stereochemistry of the product: in many cases this is not known anyway. We simply want to show you how the idea of ligand-accelerated catalysis has led to the discovery of new asymmetric reactions.

Asymmetric formation of carbon–carbon bonds

One of the first reactions you met in this book (Chapters 6 and 9) was the addition of an organometallic reagent to an aldehyde or a ketone. If the products of such an addition are chiral they are of course racemic. How might we make such a reaction enantioselective? One way would be to exploit the idea of ligand-accelerated catalysis and use a reaction which really doesn't work very well in the racemic series.

This is the case when the organometallic reagent is a dialkylzinc. Diethylzinc is commercially available as a solution in toluene or hexane, but it reacts only very slowly with an aldehyde

if the two are just left to stir together. However, if a chiral amino alcohol is added, the reaction becomes much faster. The amino alcohol forms a zinc alkoxide in the reaction mixture, and the coordination of this anionic chiral ligand to zinc both accelerates the transfer of zinc's alkyl groups to the aldehyde and makes that transfer enantioselective.



With alkyne nucleophiles, this reaction works with just catalytic amounts of zinc because the alkynylzinc forms in the reaction mixture when a weak base is added. It's a good way of making alkyne-containing alcohols.

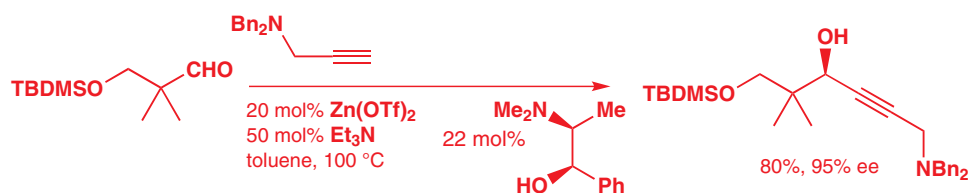

Asymmetric conjugate addition

In Chapter 22 we discussed the fact that copper promotes conjugate addition to electron-deficient double bonds. We can again exploit the low reactivity of organozinc compounds with carbonyl compounds, and with alkenes, if we add a catalytic amount of copper and a chiral phosphorus-containing ligand based on the atropisomeric binaphthyl structure you saw in BINAP. The organozinc has to transmetallate to the organocopper in order to react, and the copper always remains bound to the chiral ligand. Conjugate addition can only take place in a chiral environment, and good ees result.

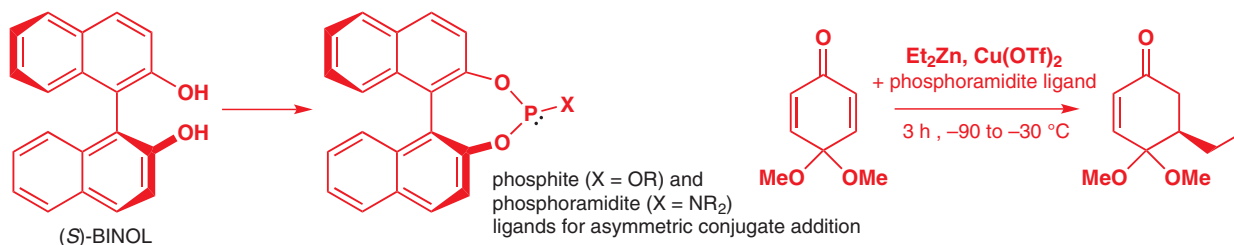

Organocatalysis

It will not have escaped your notice that most of the reactions we have presented in this chapter have made use of metals. Metals have labile coordination sites that can carry chiral ligands at the same time as they allow substrates and reagents to meet together in a chiral environment and then let the products dissociate so that the catalytic cycle can proceed. But in the early years of the 21st century, several chemists around the world realized that it is not always necessary to use a metal to initiate high levels of enantioselectivity in catalytic reactions. Simple chiral and enantiomerically pure organic molecules, many of them amines, can also react reversibly with substrates, providing a chiral environment and simultaneously activating them towards enantioselective attack.

Here is an example, which picks up where we left off: a catalytic enantioselective conjugate addition. As you know from Chapter 11, aldehydes and ketones react with secondary amines to form enamines, via iminium ions. But this unsaturated aldehyde can't form an enamine because the iminium ion that is generated by condensation with the cyclic secondary amine

Interactive mechanism for catalytic enantioselective organozinc addition to aldehydes

cannot lose a proton. The iminium ion is the end of the line for this condensation: it is very reactive towards attack by water (which would reversibly regenerate starting materials), but also towards attack by other nucleophiles. We have just what we want for good asymmetric catalysis—an intermediate species that is reactive, chiral, and enantiomerically pure.

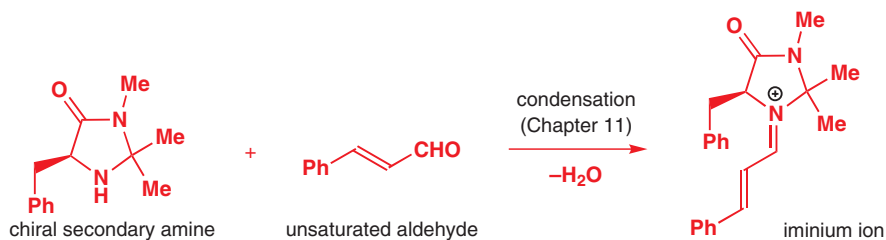

If this condensation is done in the presence of a weak nucleophile—strong enough to attack the positively charged iminium ion but not strong enough to attack the aldehyde itself—an addition reaction takes place. A pyrrole will do: pyrroles react well with cations. The phenyl ring highlighted in green hangs over the front of the molecule so the pyrrole has no choice but to attack diastereoselectively, from behind. The product is an enamine, which in the acidic conditions of the reaction is hydrolysed by the water generated in the initial condensation, revealing the aldehyde in enantiomerically enriched form (93% ee) and regenerating the secondary amine catalyst.

➔ See p. 733 of Chapter 29 for some reactions of pyrrole. You should certainly look back to Chapter 29 if you need reminding why pyrrole reacts in its 2-position.

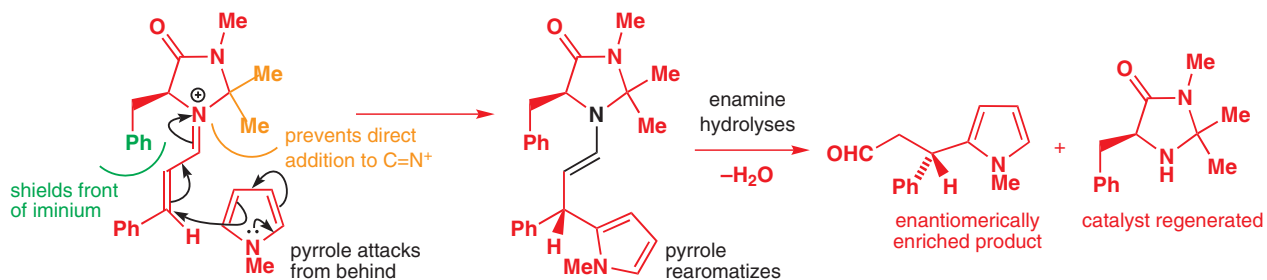

🖱 Interactive mechanism for enantioselective organocatalytic Friedel–Crafts alkylation

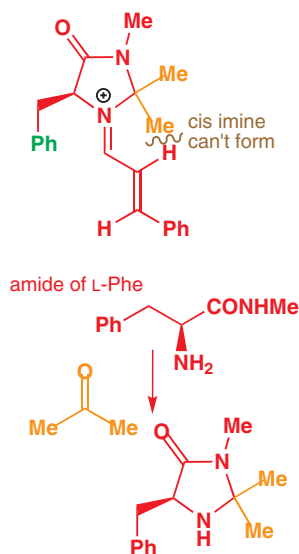

This catalyst and strategy were invented by the Glaswegian chemist David MacMillan at the California Institute of Technology (now at Princeton in New Jersey) and given the name ‘organocatalysis’. Organocatalysis makes use of small organic molecules to achieve catalytic asymmetric transformations, and can be distinguished from the more widespread methods of catalysis which typically use metals. We’ll introduce another type of organocatalysis towards the end of the chapter, but before we move on it’s worth looking at this amine catalyst and the way it works in a little more detail.

The geminal dimethyl group highlighted in orange above is also important to the functioning of the catalyst. Without it, there is clearly a danger that the pyrrole will add directly to the C=N bond of the iminium ion, a reaction that would kill the catalyst because the product is an amine and not an enamine. The methyl groups on both faces of the iminium C=N bond stop this happening. The other thing it ensures is the geometry of the iminium C=N bond. This bond is *trans* so that the alkene can keep away from the quaternary carbon bearing the two orange groups; the benzyl group with the green phenyl may be bigger in terms of total number of atoms, but there is more space for the alkene on that side because the nearest carbon also carries just an H atom. Why is the geometry of the imine important? Well, if any of it were *cis*, it would present the other face to the pyrrole and would be likely to give the opposite enantiomer of product.

Catalysts aren’t used in such great quantities as chiral auxiliaries, and so in general their synthesis does not need to be quite so direct. Nonetheless as you can see from the examples here, organocatalysts are still generally used in much greater quantities (10–20 mol%) than some of the best metal catalysts. In this case you should be able to spot that the left-hand

portion of the cyclic amine is a derivative of L-phenylalanine. Condensation of its *N*-methyl amide with an equivalent of acetone gives the catalyst itself.

Here's a related catalyst—as with the Rh- and Ru-catalysed reactions, fine tuning of the catalyst is important—being used in the synthesis of an important pharmaceutical compound, a COX-2 inhibitor. This time the nucleophile is an indole reacting characteristically at its 3-position.

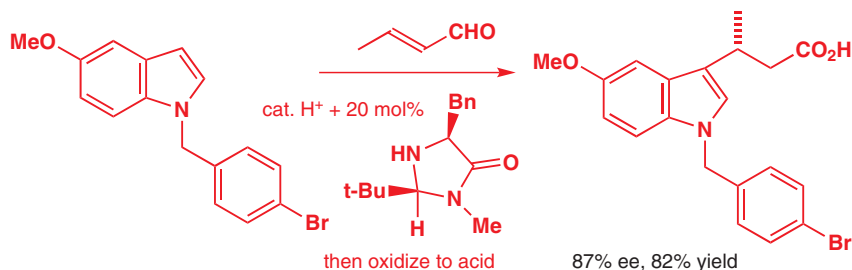

Interactive mechanism for enantioselective organocatalytic indole alkylation

Asymmetric aldol reactions

You saw in Chapter 33 that it is possible to use aldol reactions to create two new chiral centres in a single step, and that the relative stereochemistry of the two chiral centres depends in many cases on the geometry of the enolate used to do the aldol reaction. The power of an *asymmetric* aldol reaction is easy to see: it creates two new chiral centres with control over their absolute stereochemistry, and also constructs a new C–C bond. What is more, the products of aldol reactions are very common features in a huge number of natural products known as polyketides—as you will see in the next chapter, polyketides are made by living things using a series of successive enzyme-controlled aldol reactions.

Chiral auxiliary-controlled aldol reactions: the Evans aldol

An aldol reaction is the addition of an enolate to an electrophile, where the electrophile is an aldehyde or a ketone. You have already seen earlier in this chapter how enolates can be used to make new C–C bonds enantioselectively when we explained how to control enolate alkylation with Evans' chiral auxiliaries. Evans' auxiliaries also provide one of the most straightforward ways of carrying out asymmetric aldol reactions, and we will start with an example before explaining how asymmetric aldol reactions can be done using catalytic methods.

This aldol reaction is carried out using a base (triethylamine) and dibutylboron triflate plus benzaldehyde. The aldol product is formed with outstandingly good selectivity and in high yield, and all that remains is to remove the auxiliary with base and isolate the hydroxy-acid as a single diastereoisomer and a single enantiomer.

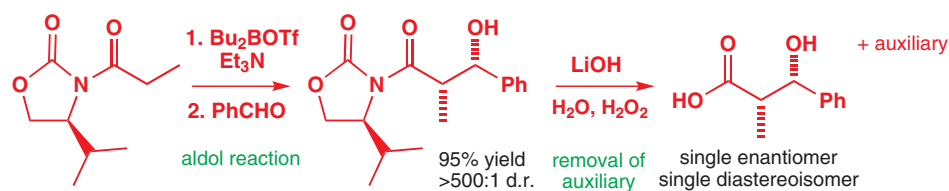

Aldol reactions using the lithium enolate of the acylated auxiliary shown here fail to give good selectivities, so instead we use the boron enolate. The combination of triethylamine and the boron triflate form the stable boron enolate, which has to be *cis* because the size of the auxiliary prevents the *trans* enolate forming. Boron has an empty p orbital, and donation into this orbital from the oxygen of the carbonyl group stabilizes the enolate.

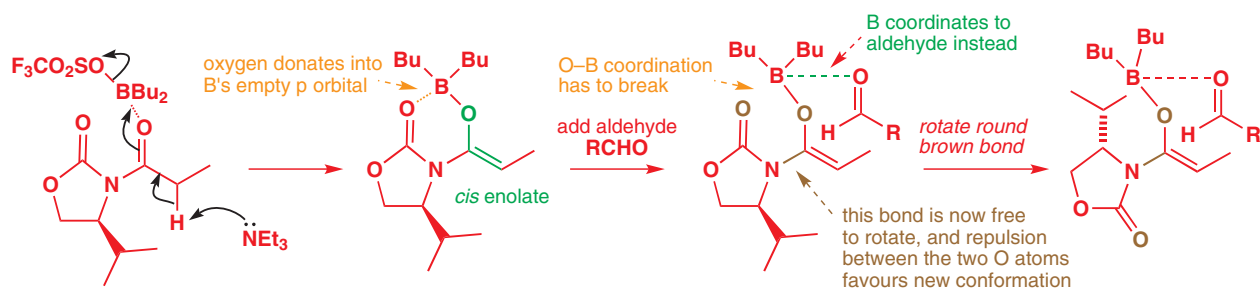

Now the aldehyde is added. If the reaction is to take place, the aldehyde must coordinate to the boron because boron enolates aren't reactive enough to attack aldehydes unless they are activated by coordination to a Lewis acid. However, the aldehyde can't simply coordinate to the boron atom of the enolate because then the boron will end up with five bonds, which is impossible for a first-row element. So, if the reaction is to continue, the boron has to let go of the auxiliary's carbonyl group and coordinate to the aldehyde instead.

At this stage something rather remarkable happens: now that the boron is no longer holding the two oxygen atoms of the enolate close together, repulsion between them (they are both electron-rich atoms) forces the auxiliary part of the enolate to swing round through 180° and end up pointing in the opposite direction. This is highly significant for what happens next because you can see from the last structure in the scheme above that this rotation ends up swinging the isopropyl group of the auxiliary round to the underside of the enolate and therefore forcing the auxiliary to react from the front instead of the back.

The diagrams below continue the story. The aldehyde has to attack the front face of the auxiliary, but it also has to do so through what we termed in Chapter 33 a 'Zimmerman–Traxler transition state'—a six-membered, chair-like cyclic structure which allows the enolate to attack the aldehyde while simultaneously transferring the metal (here the boron) from the enolate oxygen to the new hydroxyl group.

➔ You may wish to refresh your memory of the cyclic transition state for aldol reactions from p. 868.

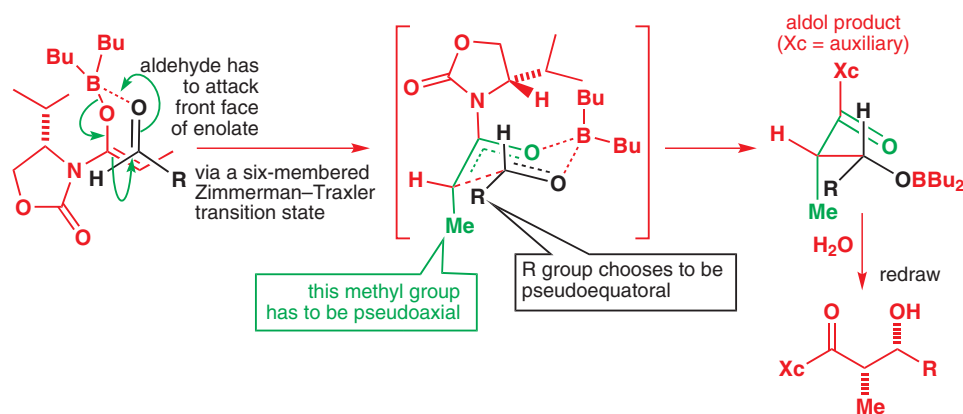

🖱 Interactive mechanism for the chiral auxiliary-controlled aldol reaction

All the usual advantages and disadvantages of chiral auxiliaries apply here: the products are formed in very high selectivity and can be purified to high ee, but the extra steps required to introduce and remove the auxiliary may compromise the overall yield and efficiency of the reaction. Nonetheless, using this method and many others like it, it has now become possible routinely to make polyketide natural products by successive aldol reactions, mimicking nature's approach to these compounds. In a spectacular demonstration of the power of synthetic chemistry to outperform natural sources, chemists at the Swiss pharmaceutical company Novartis made 60 g of the anticancer compound discodermolide by a synthetic route, including five aldol reactions. Four of these, shown by black C–C bonds in the structure below, used the aldol or alkylation reactions controlled by Evans' oxazolidinone chiral auxiliaries. To obtain the same quantity from the natural source, the sponge *Discodermia*, is impossible: the sponge produces minuscule amounts of discodermolide and can be harvested only by using manned submersible vehicles, at some cost to the marine environment.

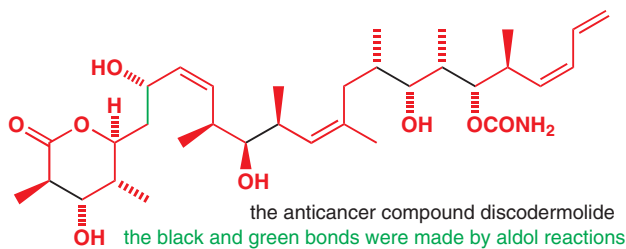

Aldol reactions catalysed by proline

A variety of catalytic ways of doing asymmetric aldol reactions have also been invented, but space prevents us discussing all but one. This one we highlight firstly because it illustrates the use of a supremely simple biologically derived compound to catalyse a complex reaction, and secondly because this discovery was part of the revolution in catalytic thinking which launched the field of organocatalysis in the early years of the 21st century.

The catalyst we will use is the amino acid L-proline—no derivatization or protection required. It was actually back in 1971 that it was first noted that L-proline will catalyse asymmetric aldols, but until the year 2000 examples were limited to this one cyclization. Treatment of a triketone with proline leads to selective cyclization onto one of the two enantiotopic carbonyl groups. A molecule of proline must condense with the least hindered ketone, and in this case an enamine (rather than an iminium ion) can form. The chiral enamine can select to react with only one of the two other carbonyl groups, and it turns out that it chooses with rather high selectivity the one coloured green in the scheme below. Cyclization, in the manner of a Robinson annelation, and hydrolysis of the resulting iminium ion follow on, releasing the molecule of L-proline to start another catalytic cycle. The isolated product is the bicyclic ketone, in 93% ee.

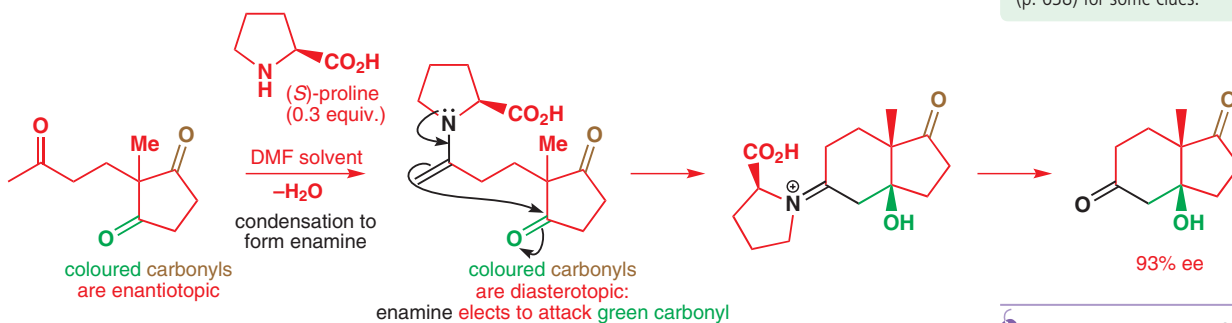

This remained an oddity of a reaction until 2000, when chemists at the Scripps Institute in California, and then others around the world, took the simple expedient of adding L-proline to many other aldol reactions, with considerable success. With care, excellent results can be obtained. Here is an example.

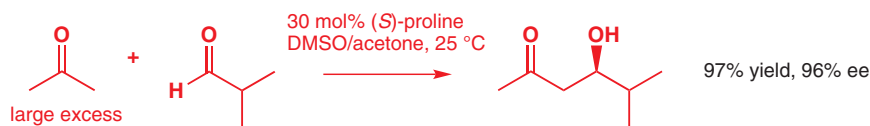

You will remember from Chapter 26 that crossed aldol reactions between enolizable partners, like these, usually need one of the reagents to be converted to an enolate equivalent to ensure selective reaction. Here, the acetone is in excess, but the components are just stirred together at room temperature in DMSO! The key to success is that one of the two components must be more able to form a reactive enamine with proline than the other. In the case above, the acetone-derived enamine is favoured because (1) enamine formation is reversible, (2) the acetone is in excess, and (3) the enamine from acetone is less hindered and more reactive than the enamine that would arise from the aldehyde.

➔ You saw the racemic example of this Robinson annelation on p. 638.

■ You might like to think about how the starting material for this reaction can be made. Look back at the section on the Robinson annelation in Chapter 26 (p. 638) for some clues.

🔗 Interactive mechanism for the proline-catalysed Robinson annelation

■ It has an odd name too: the cyclization is sometimes called the Hajos–Parrish–Eder–Sauer–Wiechert reaction, after its discoverers, but only by those who want to impress their friends.

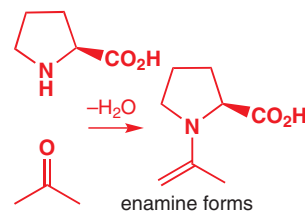

In the aldol reaction itself, proline's carboxyl group has a key role to play because it can participate in a hydrogen bond that organizes the six-membered transition state in such a way that only one of the possible enantiomeric products can form. The diagram below shows how. Water generated in the initial condensation hydrolyses the iminium product of the aldol and regenerates the proline catalyst.

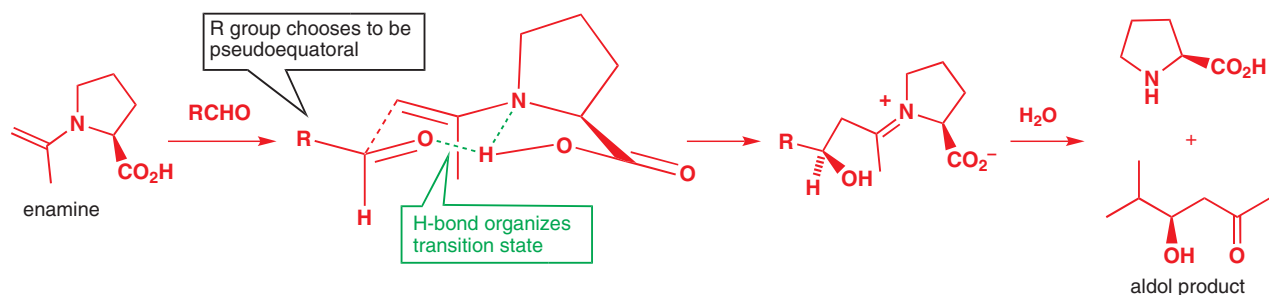

Interactive mechanism for the proline-catalysed enantioselective aldol reaction

See p. 868 for a discussion of enolate geometry and *syn* and *anti* aldols.

Interactive mechanism for the proline-catalysed *anti* selective aldol reaction

Organocatalytic aldol reactions also work well with hydroxylated ketones—the reaction below, for example. In this case, the enamine forms with an *E* double bond, which means that the hydroxyl group has to be equatorial on the six-membered transition state. You should be able to work out from this that the *anti* aldol has to form.

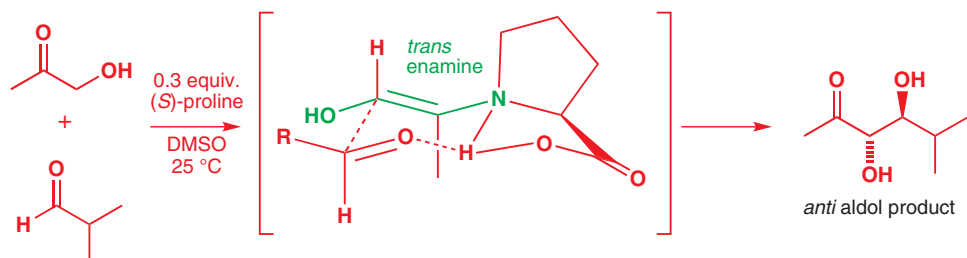

Enzymes as catalysts

We pointed out at the beginning of the chapter that all enantiomeric purity must ultimately derive from nature. We have almost come full circle: the reactions we have just been looking at use one of nature's protein building blocks, L-proline, directly as a catalyst. Even more intriguingly, the reaction just above, which forms a ketodiols, is extremely reminiscent of the aldol reactions which nature uses to build carbohydrates, as you will see in the next chapter.

Yet nature does not use single amino acids to catalyse asymmetric reactions, it uses enzymes. Enzymes are vastly more efficient than L-proline and catalyse a much wider range of reactions, but while they are also much more complicated, their reactivity derives ultimately from the amino acids they are made up of.

Life uses enzymes to catalyse asymmetric reactions, so the question is—can chemists? The answer is yes, and there are many enzymes that can be produced in quantities large enough to be used in the catalytic synthesis of enantiomerically pure molecules. This field—known as biocatalysis—melds ideas in chemistry and biology, and we do not have the space here to discuss it in detail. We leave you with just one example: the reduction of a ketone to an alcohol with an enzyme known as a ketoreductase.

The structure of NADPH is on p. 1150.

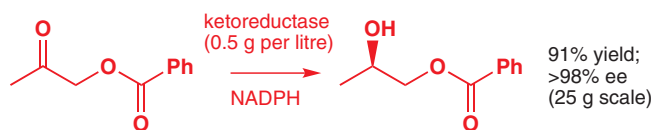

The ketoreductase takes hydride from the reducing agent NADPH (which you will meet in the next chapter) and transfers it enantioselectively to the carbonyl group in the active site of

the enzyme. This ketoreductase, isolated from yeast, may never have met this non-biological substrate—benzoyloxyacetone—before, but the reaction works. In fact this sort of reaction works so well that ketoreductases are used to carry out the reduction needed to produce the pharmaceutical intermediate discussed on p. 1116 on a 230 kg scale.

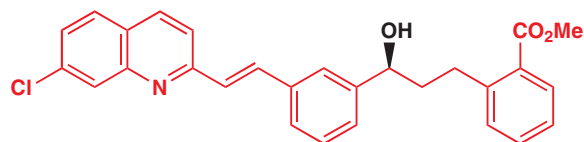

made by enzymatic reduction on a 1/4-tonne scale

Many other groups of enzymes behave similarly: they have evolved to take part in particular biochemical pathways, but they are sufficiently promiscuous that they will happily accept alternative substrates and provide chemically useful products from them. Enzymes are catalysts, like any other. In the next chapter, we take a more detailed look at those biochemical pathways and discuss the organic chemistry of life.

● Summary of the main methods for asymmetric synthesis

Method	Advantages	Disadvantages	Examples
resolution	both enantiomers available	maximum 50% yield	synthesis of BINAP
chiral pool	100% ee usually guaranteed	often only one enantiomer available	amino acid and sugar derived syntheses
chiral auxiliary	often excellent ees; can recrystallize to purify to high ee	extra steps to introduce and remove auxiliary	oxazolidinones
chiral reagent	achieve some otherwise difficult transformations	only a few reagents are successful and often for few substrates	alkyllithium(–)-sparteine complex
chiral catalyst	economical: only small amounts of recyclable material used	only a few reactions are really successful; recrystallization can improve only already high ees	asymmetric hydrogenation, epoxidation, dihydroxylation

Further reading

For an overview of the relationship between smell and stereochemistry, see R. Bentley, *The Nose as a Stereochemist: Enantiomers and Odour*, *Chem. Rev.*, 2006, **106**, 4099. Interesting examples of the use of asymmetric methods in the large scale synthesis of drug molecules are given in M. Ikonaka, *Chem. Eur. J.* 2003, **9**, 379. The prevalence of chiral drugs and the relative importance of asymmetric synthesis and resolution are discussed in B. Kasprzyk-Hordern, *Chem. Soc. Rev.*, 2010, **39**, 4466 and in J. S. Carey, D. Laffan, C. Thomson and M. T. Williams *Org. Biomol. Chem.* 2006, 2337.

For a more advanced treatment of asymmetric synthesis see P. Wyatt and S. Warren, *Organic Synthesis: Strategy and Control*, Wiley, Chichester, 2007, chapters 22–31 and the accompanying *Workbook*, also Wiley, 2008. Very detailed advanced mechanistic discussion of asymmetric hydrogenation and asymmetric epoxidation methods may be found in *Asymmetric Synthesis*, vol. 5, ed. J. D. Morrison, Academic Press, New York (1985). This five-volume set is now rather dated but provides some very valuable discussion of the

classic methods of asymmetric synthesis. There are reviews of asymmetric dihydroxylation in *Chem. Rev.* 1994, **94**, 2483 and *Org. Synth.* 1996, **73**, 1 and of asymmetric hydrogenation in *Acc. Chem. Res.* 2007, pp. 1237–1419 and the *Handbook of homogeneous hydrogenation* published by Wiley, 2007. A very recent comprehensive overview of asymmetric methods can be found in the multi-volume set *Comprehensive Chirality*, pub. Elsevier, 2011.

The Cilag resolution of the pyridyl amino acid is described in *Org. Process Res. Dev.* 2001, **5**, 23. For an informative comparison of different auxiliary and catalytic methods for the synthesis of a simple chiral carboxylic acid, see *Org. Process Res. Dev.* 2003, **7**, 370. For a leading reference to the use of enzymes to reduce ketones, see the account of the Codexis work on montelukast in *Org. Process Res. Dev.* 2010, **14**, 193. The spectacular synthesis of discodermolide by Novartis using a series of aldol reactions is described in *Org. Process Res. Dev.* 2004, **8**, 92, 101 and 107.

Check your understanding



To check that you have mastered the concepts presented in this chapter, attempt the problems that are available in the book's Online Resource Centre at <http://www.oxfordtextbooks.co.uk/orc/clayden2e/>

42

Organic chemistry of life

Connections

➔ Building on

- Acidity and basicity **ch8**
- Carbonyl chemistry **ch10 & ch11**
- Stereochemistry **ch14**
- Conformational analysis **ch16**
- Enolate chemistry and synthesis **ch25 & ch26**
- Sulfur chemistry **ch27**
- Heterocycles **ch29 & ch30**
- Asymmetric synthesis **ch41**

Arriving at

- Nucleic acids store information for the synthesis of proteins
- Modified nucleosides can be used as antiviral drugs
- Proteins catalyse reactions and provide structure
- Other amino acid derivatives act as methylating and reducing agents
- Sugars store energy, enable recognition, and protect sensitive functional groups
- How to make and manipulate sugars and their derivatives
- Lipids form the basis of membrane structures
- The main sorts of natural products are alkaloids, polyketides, terpenes, and steroids
- Alkaloids are amines made from amino acids
- Fatty acids are built up from acetyl CoA and malonyl CoA subunits

➔ Looking forward to

- Three more comprehensive web chapters:
 - The chemistry of life
 - Mechanisms in biological chemistry
 - Natural products
- Organic chemistry today **ch43**

Secondary metabolism is, by contrast, chemistry less fundamental to the workings of life and restricted to smaller groups of organisms. Later in this chapter you will meet alkaloids produced by some plants and terpenes produced by others. Humans produce neither of these, but we do make steroids, as do other animals (and a few plants). All of these molecules are the products of secondary metabolism.

Primary metabolism

Life runs on chemistry, and the chemical side of biology is fascinating for that reason alone. It is humbling to realize that the same molecules are present in all living things, from the simplest single-cell creatures to ourselves. Nucleic acids contain the genetic information of every organism, and they control the synthesis of proteins. Proteins are partly structural—as in connective tissue—and partly functional—as in enzymes, the catalysts for biological reactions. Sugars and lipids used to be thought of as the poor relations of the other two, storing energy and building membranes, but it is now clear that they also have a vital part to play in recognition and transport.

The chemistry common to all living things is known as *primary metabolism* and the chart overleaf shows the molecules of primary metabolism and the connections between them, and needs some explanation. It shows a simplified relationship between the key structures (emphasized in large black type). It shows their origins—from CO₂ in the first instance—and picks out some important intermediates. Glucose, pyruvic acid, citric acid, acetyl coenzyme A (acetyl CoA), and ribose are players on the centre stage of metabolism and are built into many

Online support. The icon  in the margin indicates that accompanying interactive resources are provided online to help your understanding: just type www.chemtube3d.com/clayden/123 into your browser, replacing **123** with the number of the page where you see the icon. For pages linking to more than one resource, type **123-1, 123-2** etc. (replacing **123** with the page number) for access to successive links.

important biological molecules. Use this chart to keep track of the relationships between the molecules of metabolism as you develop a more detailed understanding of them. We start with nucleic acids.

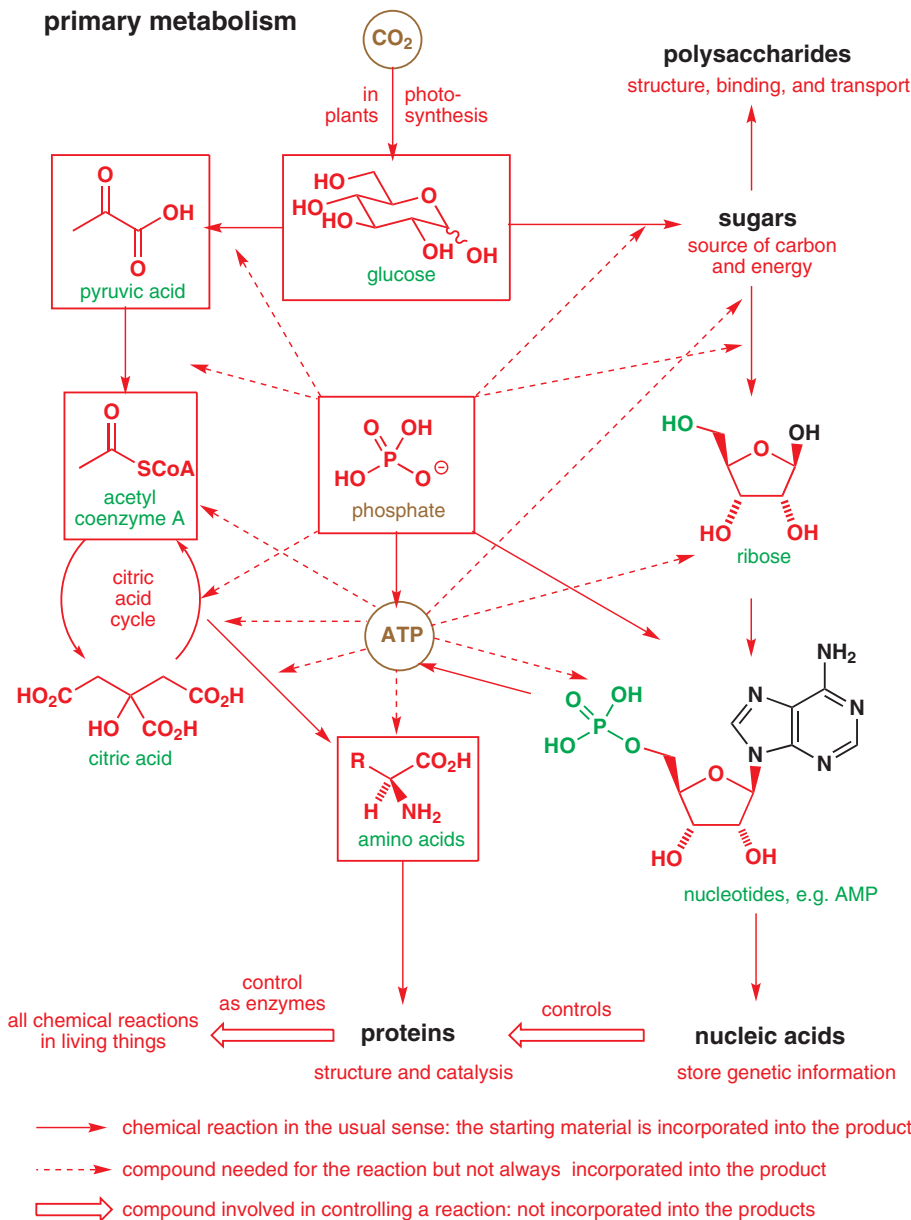

Life begins with nucleic acids

Nucleic acids store genetic information. They are polymers whose building blocks (monomers) are the nucleotides, themselves made of three parts—a heterocyclic base, a sugar, and a phosphate ester. In the example below, adenine is the base (shown in black), adenosine is the nucleoside (base and sugar), and the nucleotide is the whole molecule (base + sugar + phosphate). This nucleotide is called AMP—adenosine monophosphate. Phosphates are key compounds in nature because they form useful stable linkages between molecules and can also be built up into reactive molecules by simply multiplying the number of phosphate residues. The most important of these nucleotides is also one of the most important molecules in nature—adenosine triphosphate or ATP.

Nucleosides and nucleotides

A nucleoside differs from a nucleotide in lacking the phosphate—a nucleoside is just a base and a sugar.

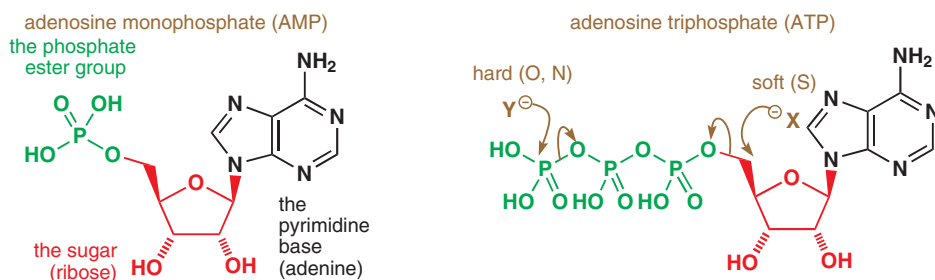

ATP is a highly reactive molecule because phosphates are stable anions and good leaving groups. It can be attacked by hard nucleophiles at a phosphate group (usually the end one) or by soft nucleophiles at the CH_2 group on the sugar. When a new reaction is initiated in nature, very often the first step is a reaction with ATP to make the compound more reactive. This is rather like our use of TsCl to make alcohols more reactive or converting acids to acid chlorides to make them more reactive.

There are five heterocyclic bases in DNA and RNA

Nucleic acids are made up of a selection of five bases, two sugars, and the phosphate group. The bases are monocyclic pyrimidines or bicyclic purines and are all aromatic.

- There are only two purine bases found in nucleic acids: adenine (A), which we have already met, and guanine (G)
- The three pyrimidine bases are simpler: uracil (U), thymine (T), and cytosine (C). Cytosine is found in DNA and RNA, uracil in RNA only, and thymine in DNA only.

The coloured parts of the molecules below emphasize the characteristic features of the bases.

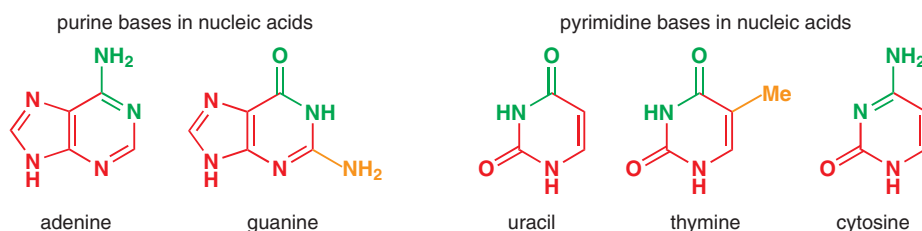

■ You met pyrimidines in Chapter 29 and learned how to make them in Chapter 30, but the purine ring system may be new to you. Make sure you can find the six (or ten) electrons making these compounds aromatic. You may need to draw delocalized structures, especially for U, T, and G.

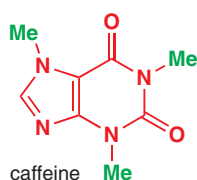

The stimulants in tea and coffee are methylated purines

An important stimulant for many is a fully methylated purine present in tea and coffee—caffeine. Caffeine is a crystalline substance easily extracted from coffee or tea with organic solvents. It is extracted industrially with supercritical CO_2 (or, if you prefer, ‘nature’s effervescence’) to make decaffeinated tea and coffee.

If we, as chemists, were to add those methyl groups we would choose to use a reagent such as methyl iodide, but nature uses a much more complicated molecule. There is a great deal of methylating going on in living things—and the methyl groups are usually added by (*S*)-adenosyl methionine (or SAM), formed by reaction of methionine with ATP. This is a good reaction because sulfur is a good soft nucleophile, triphosphate is a good leaving group, and substitution at primary carbon is easy.

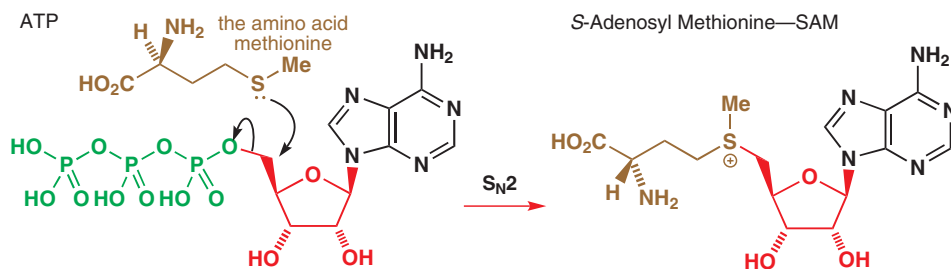

SAM is a sulfonium salt and could be attacked by nucleophiles at three different carbon atoms. Two are primary centres—good for S_N2 reactions—but the third is the methyl group, which is even better. Many nucleophiles attack SAM in this way. In the coffee plant, theobromine (a purine also found in cocoa) is converted into caffeine with a molecule of SAM. The methylation occurs on nitrogen partly because this preserves both the aromatic ring and the amide functionality and also because the enzyme involved brings the two molecules together in the right orientation for *N*-methylation.

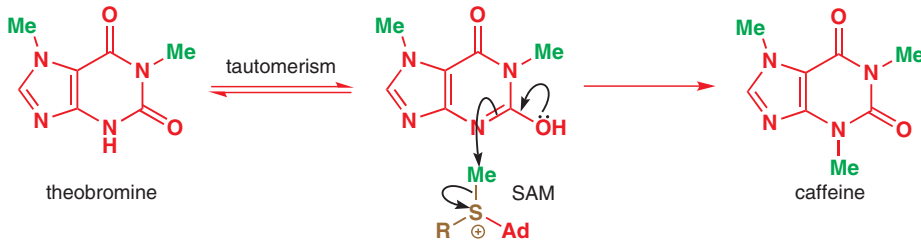
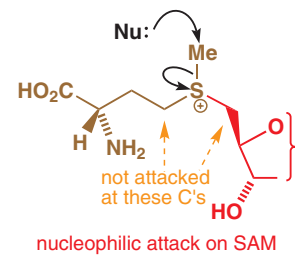

At this point we should just point out something that it's easy to forget: there is *only one chemistry*. There is no magic in biological chemistry, and nature uses the same chemical principles as we do in the chemical laboratory. All the mechanisms that you have studied so far will help you to draw mechanisms for biological reactions and most reactions that you have met have their counterparts in nature. The difference is that nature is very, very good at chemistry, and we humans are only just learning. We still do much more sophisticated reactions *inside* our bodies without thinking about them than we can do *outside* our bodies with all the most powerful ideas available to us in the 21st century.

Nucleic acids exist in a double helix

One of the most important discoveries of modern science was the elucidation of the structures of DNA and RNA as the famous double helix by Watson and Crick in 1953. They realized that the basic structure of base-sugar-phosphate was ideal for a three-dimensional coil. The structure of a small part of DNA is shown on the right. Notice that the 2' (pronounced 'two prime') position on the ribose ring is vacant. There is no hydroxyl group there: that is why it is called *deoxyribonucleic acid*. The nucleotides link the two remaining OH groups on the ribose ring and these are called the 3'- and 5'-positions. This piece of DNA has three nucleotides (adenine, adenine, and thymine) and so would be called -AAT- for short.

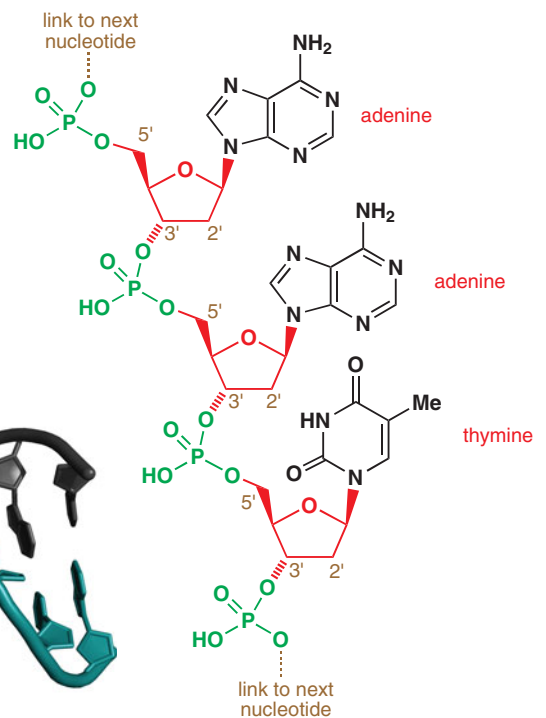
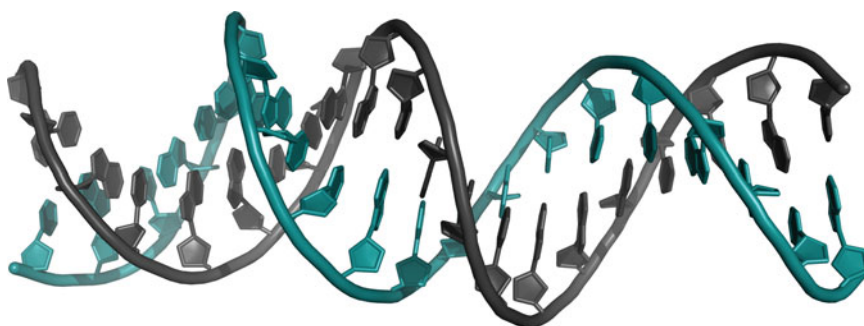

Each polymeric strand of DNA coils up into a helix and is bonded to another strand by hydrogen bonds between the bases. Each base pairs up specifically with another base—adenine with thymine (A–T) and guanine with cytosine (G–C)—like this.

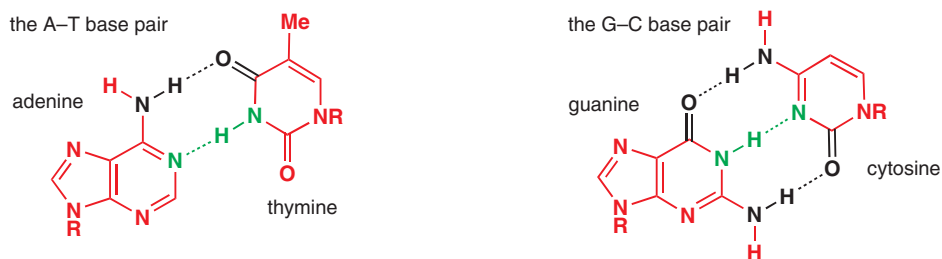

There is quite a lot to notice about these structures. Each purine (A or G) is bonded specifically to one pyrimidine (T or C) by two or by three hydrogen bonds. The hydrogen bonds are of two kinds: one links an amine to a carbonyl group (black in the diagram) and one links an amine to an imine (green in the diagram). A purine has to pair with a pyrimidine because only the combination of larger purine and smaller pyrimidine bridges the gap between the nucleic acid coils. Look back at the green and orange parts of the structures on p. 1136 and you will see that only one hydrogen bond pairing pattern can work. In this way, each nucleotide reliably recognizes another and reliably pairs with its partner. The short strand of DNA above (–AAT–) would pair reliably with –TTA–.

HIV and AIDS are treated with modified nucleosides

Modified nucleosides are among the best antiviral compounds. The anti-HIV drug AZT (zidovudine) is a slightly modified DNA nucleoside (3'-azidothymidine). It has an azide at C3' instead of the hydroxyl group in the natural nucleoside. A more radically modified nucleoside 3-TC (lamivudine) is active against AZT-resistant viruses. This drug is based on cytosine with the sugar replaced by a different heterocycle, although it is recognizably similar, especially in the stereochemistry. Acyclovir (Zovirax), the cold sore (herpes) treatment, is a modified guanosine in which only a ghost of the sugar remains. There is no ring at all and no stereochemistry.

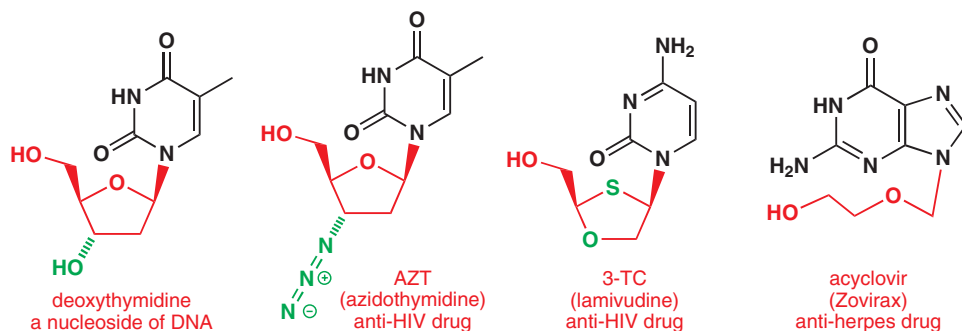

Cyclic nucleosides and stereochemistry

DNA is more stable than RNA because its sugars lack the 2' hydroxyl groups. In ribonucleic acids, the fact that the 2'- and 3'-OH groups are on the same side of the ring makes alkaline hydrolysis exceptionally rapid by intramolecular nucleophilic catalysis.

■ The substituents B¹ and B² represent any purine or pyrimidine base.

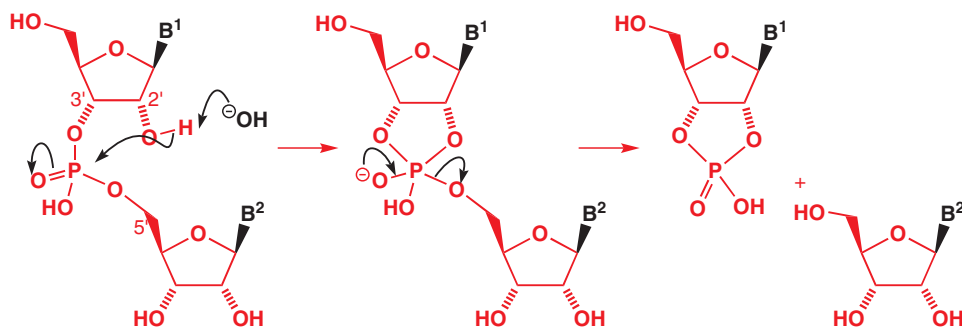

The base removes a proton from the 2'-OH group, which cyclizes on to the phosphate link—possible only if the ring fusion is *cis*. The next reaction involves breakdown of the pentavalent phosphorus intermediate to give a cyclic phosphate. One nucleoside is released by this reaction and the second follows when the cyclic phosphate is itself cleaved by base.

Another cyclic phosphate that can be formed from a nucleotide is important as a biological messenger that helps to control such processes as blood clotting and acid secretion in the stomach. It is cyclic AMP (cAMP), formed enzymatically from ATP by nucleophilic displacement of pyrophosphate by the 3'-OH group.

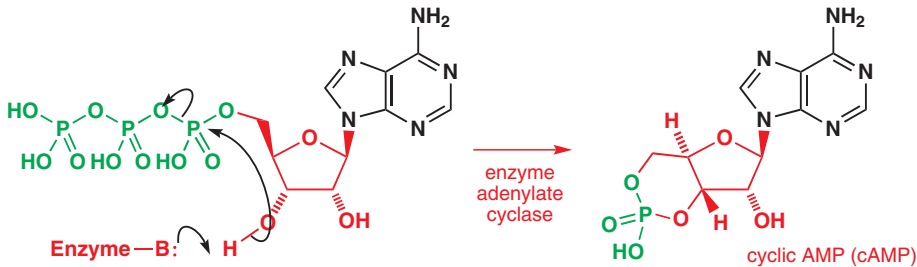

■ Note that cAMP has a *trans* 6,5-fused ring junction.

Proteins are made of amino acids

DNA encodes the information needed to make proteins in the form of triplets of bases (codons), for example thymine–adenine–cytosine (TAC) in the diagram below. As RNA is synthesized from DNA, these are turned into complementary codons (in the example below, AUG) by pairing up the bases as shown on p. 1138. This RNA forms the instructions for protein synthesis by the ribosome—perhaps the most elaborate molecular structure in the known universe. Each codon of the RNA chain tells the ribosome to add a specific amino acid to the growing protein. For example, the codon AUG indicates methionine, which we met as a component of SAM. Methionine is a typical amino acid of the kind present in proteins, but is also the starter unit of all proteins.

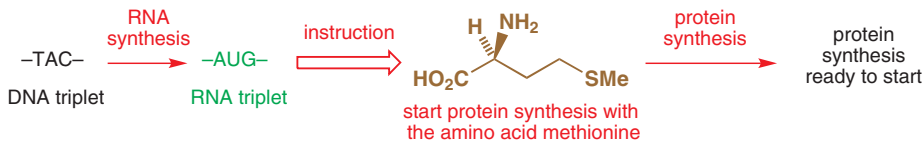

The next codon of RNA directs the ribosome to add the next amino acid, linked to the previous one in the chain by an amide bond. Amino acids used to make proteins have the same basic structure and stereochemistry, shown in the margin, and differ only in the group R.

two views of the general amino acid structure

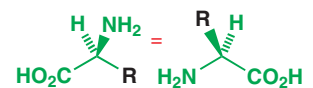

➔ There is a list of the naturally occurring amino acids in Chapter 23 (p. 554), where we discussed the *laboratory* synthesis of peptides.

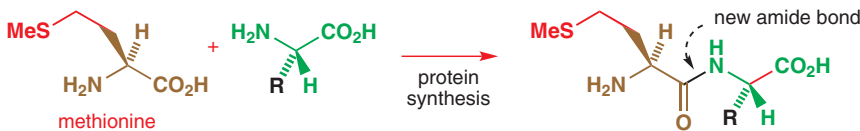

The process continues as more amino acids are added in turn to the right-hand end of the growing molecule. A section of the final protein might look like the structure below. The skeleton of the protein zig-zags up and down in the usual way; the amide bonds (shown in black) are rigid because of the amide conjugation and are held in the shape shown.

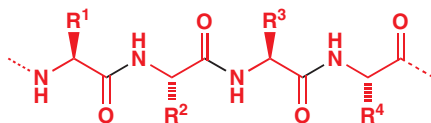

■ Much of the function of enzymes and other proteins derives from their detailed folded conformation, discussion of which is beyond the scope of this book.

Amino acids combine to form peptides and proteins

In nature, the amino acids are combined to give proteins with hundreds or even thousands of amino acids in each one. Small assemblies of amino acids are known as **peptides** and the amide bond that links them is called a **peptide bond**.

An important tripeptide is **glutathione**, present in the tissues of both animals and plants. Glutathione is the 'universal thiol' that removes dangerous oxidizing agents by allowing itself to be oxidized to a disulfide. Glutathione is, however, not quite a typical tripeptide. The left-hand amino acid is normal glutamic acid but it is joined to the next amino acid through its γ -CO₂H group instead of the more normal α -CO₂H group. The middle amino acid is the vital one for the function—cysteine with a free SH group. The C-terminal acid is glycine.

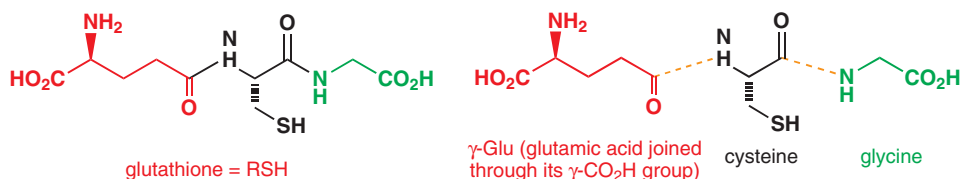

Thiols are easily oxidized to disulfides and glutathione sacrifices itself if it meets an oxidizing agent. The oxidized form of glutathione can later be converted back to the thiol by reduction with NADH, which you will meet later in this chapter.

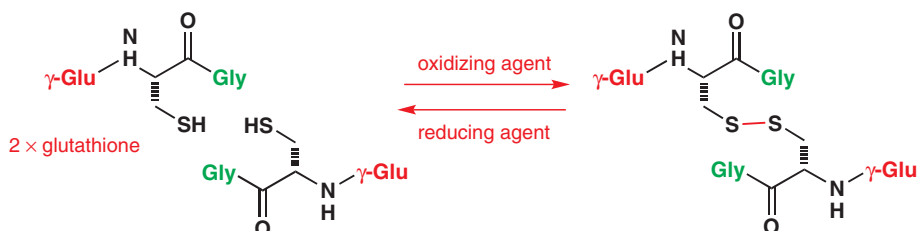

With a stray oxidizing agent such as a peroxide, say H₂O₂, the mechanism below shows how this can be reduced to water as glutathione (represented as RSH) is oxidized to a disulfide.

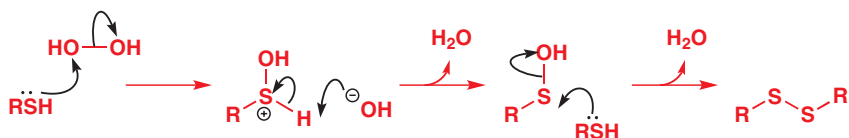

Glutathione also detoxifies some of the compounds we described earlier in this book as dangerous carcinogens such as Michael acceptors and 2,4-dinitrohalobenzenes. The thiol acts as a nucleophile, inactivating the electrophiles. Covalently bound to glutathione they are harmless and can be excreted. More glutathione will be synthesized from glutamic acid, cysteine, and glycine to replace that which is lost.

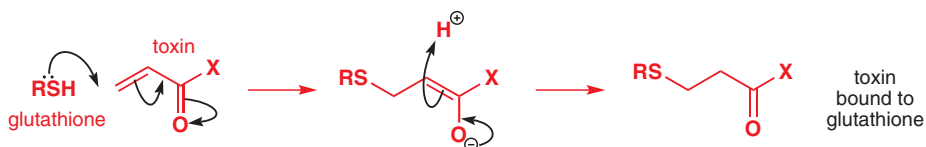

Some short peptides, of around ten amino acids, are hormones. Angiotensin II, for example, is a peptide that causes blood pressure to rise—a very necessary thing in some situations but too much and too often leads to heart attacks and strokes.

Angiotensin-converting enzyme (ACE) is the zinc-dependent enzyme that cleaves two amino acids from the end of angiotensin I to give angiotensin II, and ACE inhibitors are used as treatment for high blood pressure because they inhibit this enzyme. Lisinopril is an example: it is a dipeptide mimic, having two natural amino acids and something else. The 'something else' is the left-hand part of the molecule, linked to the dipeptide (Lys-Pro) through an amine and not

➔ See, for example, the discussion in Chapter 22, p. 516.

➔ You saw some examples in Chapter 23.

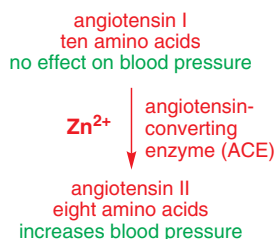

by an amide bond. This stops enzymes from hydrolysing the molecule. Lisinopril binds to ACE because it is *like* a natural dipeptide but it inhibits it because it is *not* a natural dipeptide. Many people are alive today because of this simple deception practised on an enzyme.

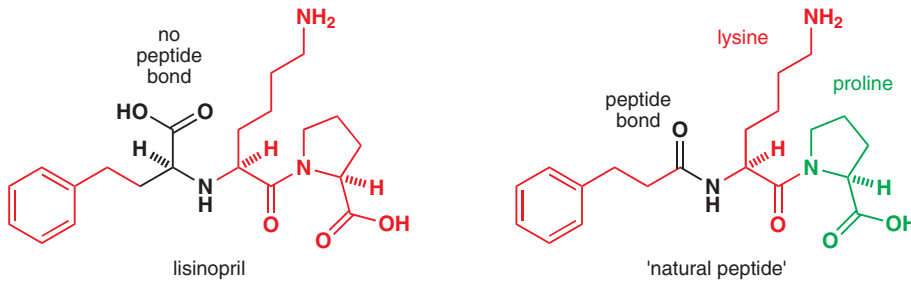

Structural proteins must be tough and flexible

In contrast with the functional enzymes, proteins such as collagen are purely structural. Collagen is the tough protein of tendons and connective tissue, and is present in skin, bone, and teeth. It contains large amounts of glycine (every third amino acid is glycine), proline, and hydroxyproline (again about a third of the amino acids are either Pro or Hyp).

Hydroxyproline is a specialized amino acid that appears almost nowhere else and, along with proline, it establishes a very strong triply coiled structure for collagen. The glycine is necessary as there is no room in the triple coil for any larger amino acid. Functionalized amino acids are rare in collagen.

Hydroxyproline and scurvy

Hydroxyproline is a very unusual amino acid. It is not incorporated into the growing protein chain when collagen is synthesized—instead the collagen molecule is assembled with Pro where Hyp is needed. Once the protein is complete, some of the proline residues are oxidized to hydroxyproline. This oxidation requires vitamin C, and without it collagen cannot be formed. This is why vitamin C deficiency causes scurvy—the symptoms of scurvy suffered by 18th-century sailors (loose teeth, sores, and blisters) were caused by the inability to make collagen.

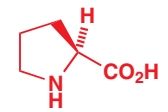
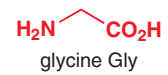

(S)-proline Pro

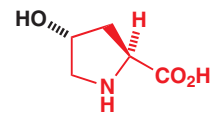

(2S,4R)-hydroxyproline Hyp

Antibiotics exploit the special chemistry of bacteria

We have repeatedly emphasized that all life has very similar chemistry. From the biochemical point of view the most important division is that separating *prokaryotes* from *eukaryotes*. Prokaryotes, which include bacteria, evolved first and have simple cells with no nucleus. Eukaryotes, which include plants, mammals, and all other multicellular creatures, evolved later and have more complex cells, including nuclei. Even then, much of the biochemistry on both sides of the divide is the same.

When medicinal chemists are looking for ways to attack bacteria, one approach is to interfere with chemistry carried out by prokaryotes but not by us. The most famous of these attacks is aimed at the construction of the cell walls of some bacteria that contain 'unnatural' (R)- (or D-) amino acids. Bacterial cell walls are made from glycopeptides of an unusual kind. Polysaccharide chains are cross-linked with short peptides containing (R)-alanine (D-Ala). Before they are linked up, one chain ends with a glycine molecule and the other with D-Ala-D-Ala. In the final step in the cell wall synthesis, the glycine attacks the D-Ala-D-Ala sequence to form a new peptide bond by displacing one D-Ala residue.

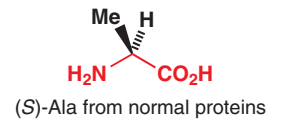

(S)-Ala from normal proteins

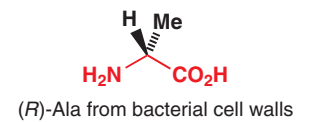

(R)-Ala from bacterial cell walls

■ The reason bacteria have evolved to use these 'unnatural' D-amino acids in their cell walls is to protect them against the enzymes in animals and plants, which cannot digest proteins containing D-amino acids.

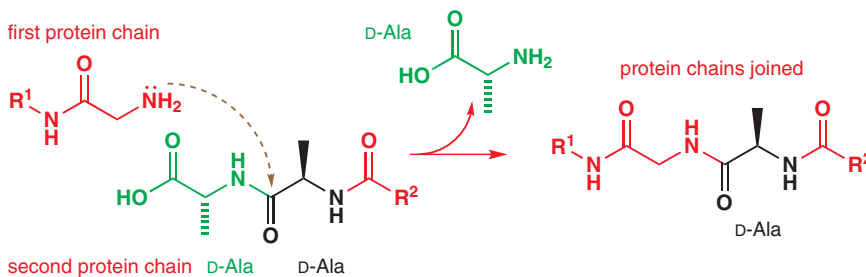

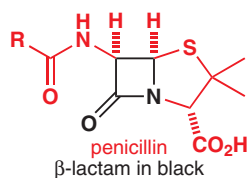

The antibiotic penicillin works by interfering with this step—although this was not even suspected when penicillin was discovered. Penicillin inhibits the enzyme that catalyses the D-Ala transfer in a very specific way. It first binds specifically to the enzyme (so it must be a mimic of the natural substrate) and it then reacts with the enzyme and inactivates it by blocking a vital OH group at the active site. If we emphasize the peptide nature of penicillin and compare it with D-Ala–D-Ala, the mimicry may become clearer.

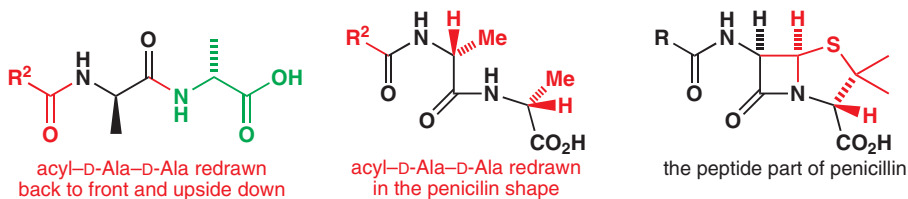

Penicillin imitates D-Ala and binds to the active site of the enzyme, encouraging the OH group of a serine residue to attack the reactive strained β-lactam. This same OH group of the same serine residue would normally be the catalyst for the D-Ala–D-Ala cleavage used in the building of the bacterial cell wall. The reaction with penicillin ‘protects’ the serine and irreversibly inhibits the enzyme. The bacterial cell walls cannot be completed, and the bacterial cells literally burst under the pressure of their contents. Penicillin does not kill bacteria whose cell walls are already complete but it does prevent new bacteria being formed.

Our current last line of defence against bacteria resistant to penicillin, and other antibiotics, is vancomycin. Vancomycin works by binding to the D-Ala–D-Ala sequences of the bacterial cell wall.

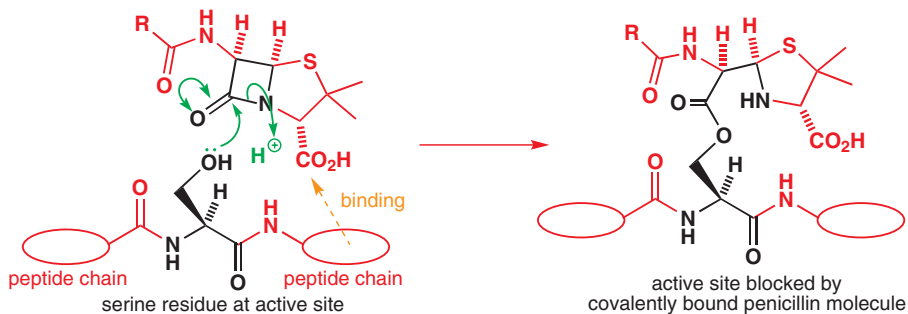

Sugars—just energy sources?

Sugars are the building blocks of carbohydrates. They used to be thought of as essential but rather dull molecules whose function was principally the (admittedly useful) storage of energy. In fact they have much more interesting and varied roles than that. We have already noted that ribose plays an intimate role in DNA and RNA structure and function. Sugars are also often found in intimate association with proteins and are involved in recognition and adhesion processes.

Here are two examples. How does a sperm recognize the egg and penetrate its wall? Recognition of a carbohydrate attached to the membrane of the egg was the first event in all of our lives. And how does a virus get inside a cell? Here again, the recognition process involves specific carbohydrates. One of the ways in which AIDS is being tackled with some success is by a combination of the antiviral drugs we met earlier in this chapter with HIV protease inhibitor drugs, which aim to prevent recognition and penetration of cells by HIV.

Sugars normally exist in cyclic forms with much stereochemistry

The most important sugar is glucose. It has a saturated six-membered ring containing oxygen and it is best drawn in a chair conformation with nearly all the substituents equatorial. It can also be drawn as a flat configurational diagram. We have already met one sugar in this chapter, ribose, because it was part of the structure of nucleic acids. This sugar is a five-membered saturated oxygen heterocycle with many OH groups. Indeed, you can define a sugar as an oxygen heterocycle with every carbon atom bearing an oxygen-based functional group—usually OH, but alternatively C=O.

➡ There is more about the development of drugs for treating HIV in Chapter 43.

two representations of glucose

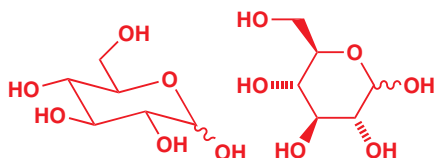

ribose

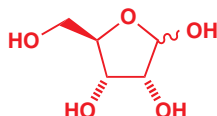

a ribonucleotide

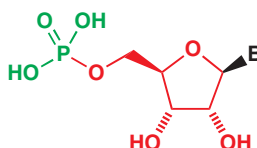

The drawings of glucose and ribose show a number of stereogenic centres, with one centre undefined—an OH group shown with a wavy bond. This is because one centre in both sugars is a hemiacetal and therefore the molecule is in equilibrium with an open-chain hydroxy-aldehyde. For glucose, the open-chain form is this.

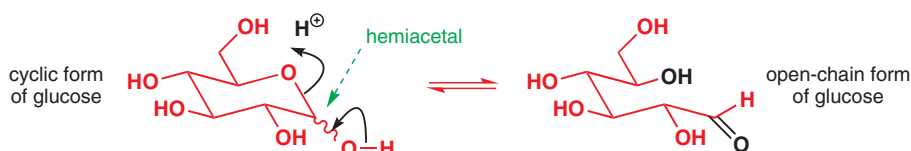

When the ring closes again, any of the OH groups could cyclize on to the aldehyde but there is no real competition—the six-membered ring is more stable than any of the alternatives (which could have three-, four-, five-, or seven-membered rings—check for yourself). However, with ribose there is a reasonable alternative.

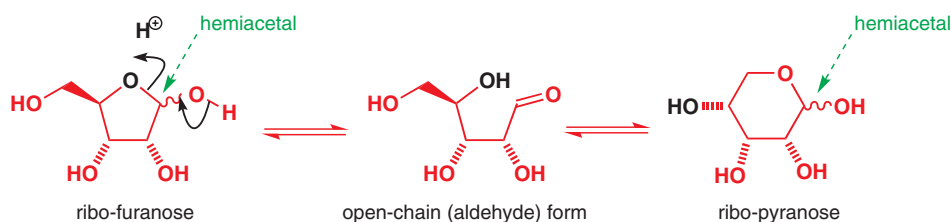

The most important sugars may exist in an open-chain form, as a five-membered oxygen heterocycle (called a *furanose*, after the five-membered aromatic compound furan) or a six-membered oxygen heterocycle (called a *pyranose*, after the six-membered pyran). Glucose prefers the pyranose structure; ribose prefers the furanose structure.

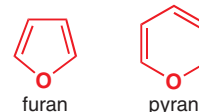

Sugars can be fixed in one shape by acetal formation

The simplest way to fix glucose in the pyranose form is to trap it as an acetal. Acid-catalysed condensation with an alcohol, methanol, for example, gives an acetal and, remarkably, the acetal has an *axial* OR group. Acetal formation is under thermodynamic control (Chapter 11) so the axial compound must be the more stable. This is because of the anomeric effect—so-called because this C atom is called the anomeric position and the acetal diastereoisomers are called anomers. The effect is a bonding interaction between the axial lone pair on the oxygen in the ring and the σ^* orbital of the OMe group.

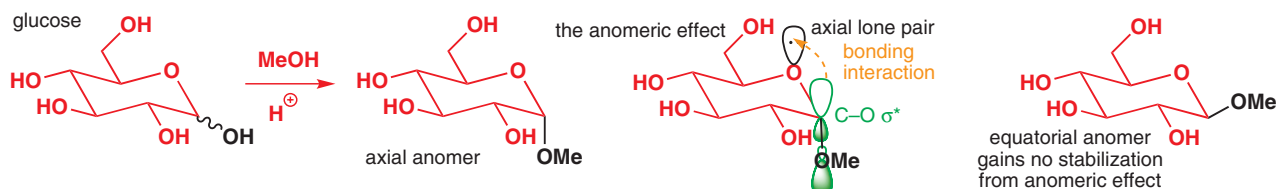

➔ The anomeric effect was discussed in Chapter 31, and you should check that you can still write down the mechanism of acetal formation you learned in Chapter 11.

The formation of acetals allows a remarkable degree of control over the chemistry of sugars. Apart from the simple glucoside acetal we have just seen, there are three important acetals worth understanding because of the way in which they illustrate stereoelectronic effects—the interplay of stereochemistry and mechanism. If we make an acetal from methyl glucoside and benzaldehyde, we get a single compound as a single stereoisomer.

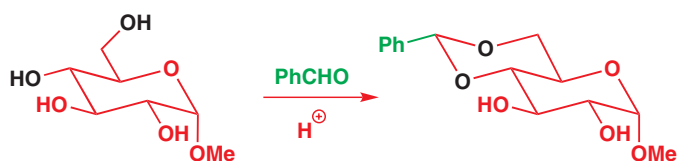

The new acetal could have been formed between any of the adjacent OH groups in the starting material but it chose the only pair (the black OH groups) which give a six-membered ring. The stereochemistry of glucose is such that the new six-membered ring is *trans*-fused to the old so that a beautifully stable all-chair bicyclic structure results, with the phenyl group in an equatorial position in the new chair acetal ring. Acetal formation is under thermodynamic control and this product is the most stable possible acetal.

Acetal formation from sugars and acetone shows quite different selectivity. For a start, cyclic acetals of acetone prefer to be five- rather than six-membered rings. In a six-membered ring, one of the acetone's methyl groups would have to be axial, so the five-membered ring is preferred. A 5,5 or 5,6 ring fusion is more stable if it is *cis*, and so acetone acetals (acetonides) form preferentially from *cis* 1,2-diols. Glucose has no neighbouring *cis* hydroxyls in the pyranose form, but in the furanose form it can have two pairs. Formation of an acetal with acetone fixes glucose in the furanose form. This is all summarized in the scheme below.

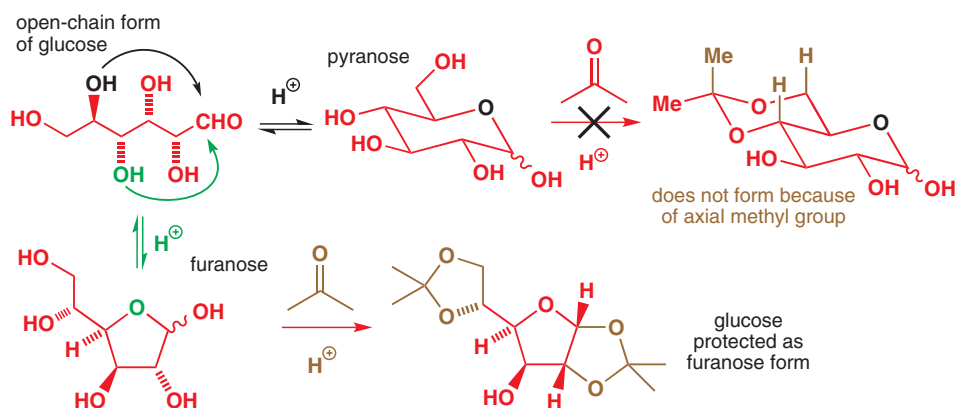

The open-chain form of glucose is in equilibrium with both the pyranose and the furanose forms through reversible hemiacetal formation using the black and green OH groups, respectively. Normally, the pyranose form is preferred, but the furanose form can form a double acetal with acetone, one acetal having two *cis*-fused five-membered rings and the other being on the side chain. This double acetal is the product isolated from the reaction.

If we want to fix glucose in the open-chain form, we must make an 'acetal' of quite a different kind using a thiol (RSH) instead of an alcohol, an aldehyde, or a ketone. The thiol combines with the aldehyde group of the open-chain form to give a stable dithioacetal. The dithioacetal is evidently more stable than the alternative hemiacetals or monothioacetals that could be formed from the pyranose or furanose forms.

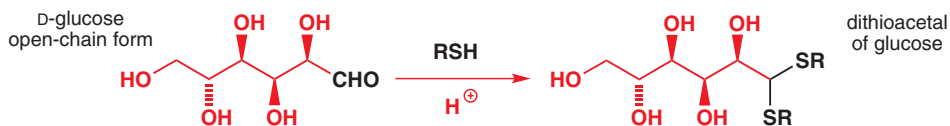

■ The most important *N*-glycosides are, of course, the nucleotides, which we have already described in some detail.

➔ You saw an example in Chapter 6 (p. 129) where acetone cyanohydrin is found in the cassava plant as a glucoside.

Glycosides in nature

Many alcohols, thiols, and amines occur in nature as glycosides, that is as *O*-, *S*-, or *N*-acetals at the anomeric position of glucose. The purpose of attaching these compounds to glucose is often to improve solubility or transport across membranes—to expel a toxin from the cell, for example. Sometimes glucose is attached in order to stabilize the compound so that glucose appears as nature's protecting group, rather as a chemist might use a THP group (Chapter 23).

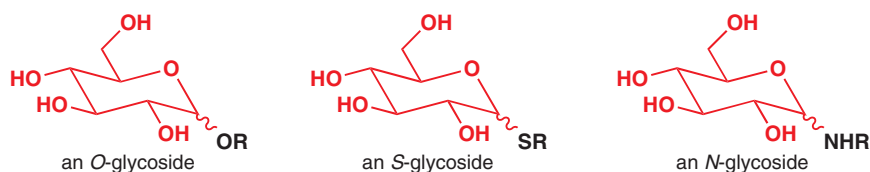

O-Glycosides occur in immense variety with glucose and other sugars being joined to the OH groups of alcohols and phenols to form acetals. The stereochemistry of these compounds is usually described by the Greek letters α and β . If the OR bond is down, it's an α -glycoside; if up, a β -glycoside. An attractive example is the pigment of red roses, which is an interesting aromatic oxygen heterocycle (an anthocyanidin). Two of the phenolic OH groups are present as β -glycosides.

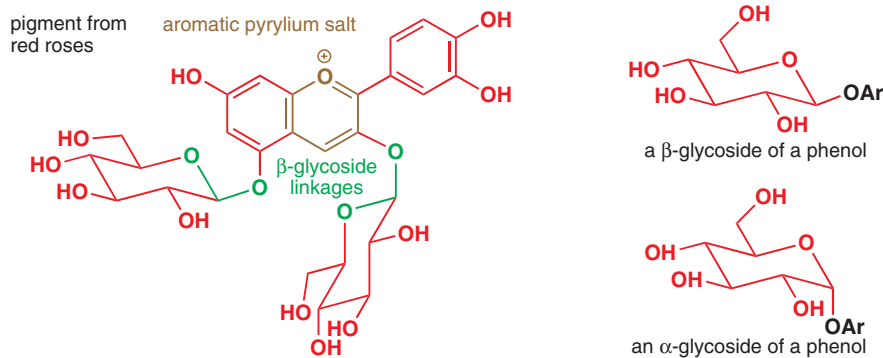

It's often proposed that there are special benefits to health in eating broccoli and brussels sprouts because of the sulfur-containing antioxidants they contain. These compounds are unstable isothiocyanates. They are not usually present in the plant; damage—by cutting or cooking, for example—induces a glycosidase (an enzyme which hydrolyses glycosides) to release the sulfur compound from its glucose protection. A simple example is sinigrin. The *S*-glycosides of the sinigrin group start to hydrolyse in the same way. The sulfur atom is the better leaving group when it leaves as an anion (though worse than oxygen when the hydrolysis occurs in acidic conditions) and the anion is additionally stabilized by conjugation.

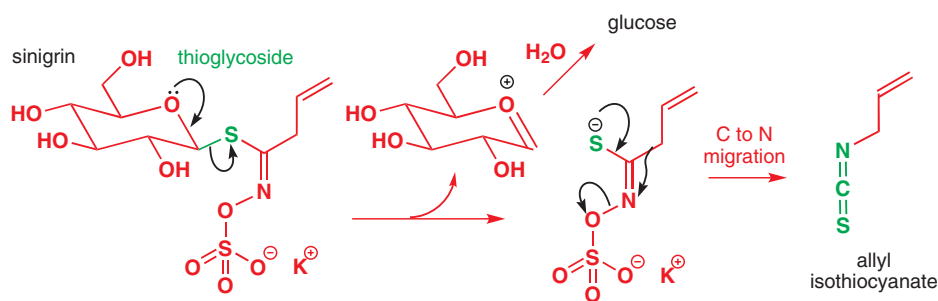

The next step is surprising. A rearrangement occurs, rather similar to the Beckmann rearrangement, in which the alkyl group migrates from carbon to nitrogen and an isothiocyanate ($\text{R}-\text{N}=\text{C}=\text{S}$) is formed. Sinigrin occurs in mustard and horseradish, and it is the release of the allyl isothiocyanate that gives these their 'hot' taste. When mustard powder is mixed with water, the hot taste develops over some minutes as sinigrin is hydrolysed to the isothiocyanate.

The *S*-glycoside in broccoli and brussels sprouts that is proposed to offer protection from cancer is somewhat similar but has one more carbon atom in the chain and contains a sulfoxide group as well. Hydrolysis of the *S*-glycoside is followed by the same rearrangement, producing a molecule called sulforaphane. Sulforaphane protects against cancer-causing oxidants by inducing the formation of a reductive enzyme.

α - and β -glycosides

It is easy to remember which is which, as long as you accept that people who devise nomenclature must be maliciously foolish. Just as *E* means trans and *Z* means *cis* (each letter has the shape of the *wrong* isomer), so α means *below* and β means *above*—each word begins with the *wrong* letter.

➔ The Beckmann rearrangement is described in Chapter 36, p. 958.

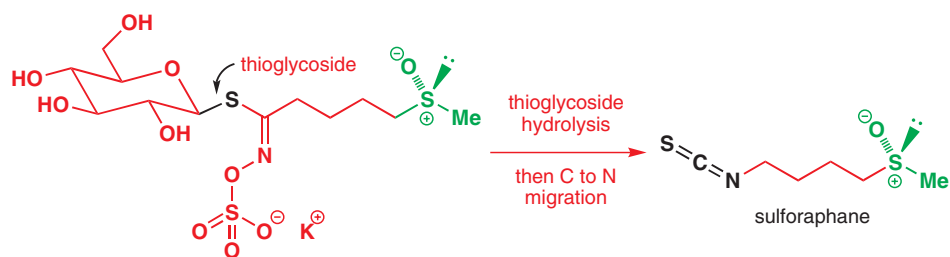

Vitamin C is a derivative of glucose

Nature makes some important compounds from simple sugars. Vitamin C—ascorbic acid—is one of these. It certainly looks very like a sugar as it has six carbon atoms, each having an oxygen atom as substituent as well as an oxygen heterocycle. Like glutathione, it protects cells from stray oxidants as well as being involved in primary redox pathways (we mentioned earlier its role in collagen synthesis). Its reduced and oxidized forms are shown below.

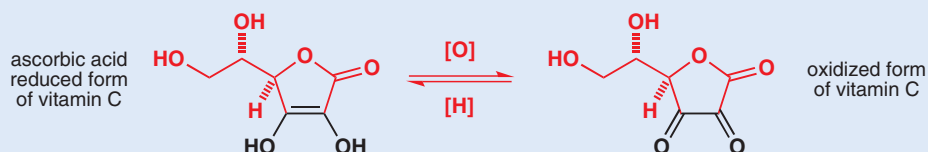

Most sugars are embedded in complex carbohydrates

The most familiar of all sugars is sucrose—the mixed acetal formed from glucose and fructose. Sucrose is of course sweet, and is easily metabolized into fats. But if three of the OH groups in sucrose are replaced by chlorine atoms, a compound 600 times as sweet is produced: less of it is needed to get the same sweet taste and the chlorines reduce the rate of metabolism so that much less fat is made. This is the compound sucralose, discovered by chemists at Tate & Lyle and now used to sweeten soft drinks.

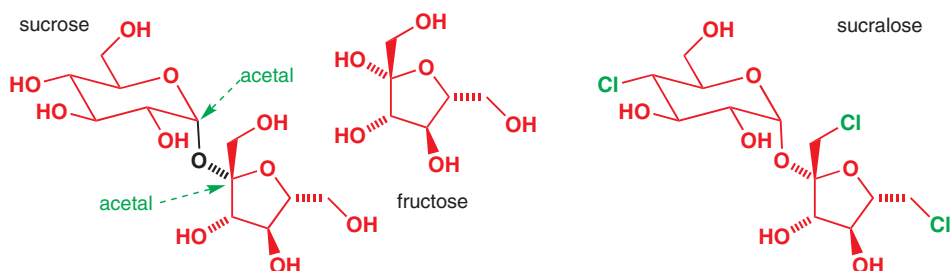

10^{15} kg per year of cellulose is literally an astronomical amount: it's about the mass of one of the moons of Mars, Deimos. Our moon weighs 10^{22} kg.

Sucrose is a disaccharide—two simple sugars linked by an acetal. In general, saccharides have the same relationship to sugars as peptides and proteins have to amino acids. One of the most abundant compounds in nature is a saccharide: cellulose, the structural material of plants. It is a glucose polymer and is produced in simply enormous quantities (about 10^{15} kg per year). Each glucose molecule is joined to the next through an acetal formed by attack of the C4 hydroxyl group of one glucose molecule on the anomeric carbon atom of the next. Here is that basic arrangement.

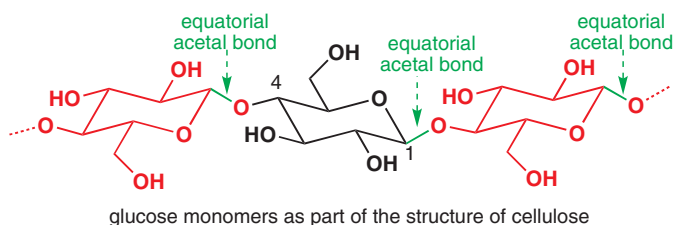

Notice that the anomeric bonds are all equatorial. This means that the cellulose molecule is linear in general outline. It is made rigid by extra hydrogen bonds between the 3-OH groups and the ring oxygen atoms—like this.

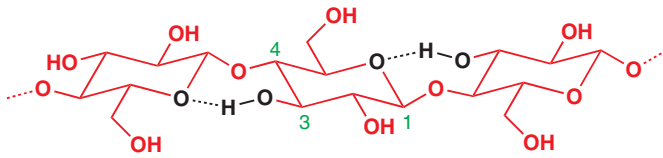

The polymer is also coiled to increase stability still further. All this makes cellulose very difficult to hydrolyse, and humans cannot digest cellulose as we do not have the necessary enzymes. Other mammals have evolved devices such as multiple stomachs (in ruminants, such as cattle) to enable them to degrade cellulose.

Amino sugars add versatility to saccharides

Amino sugars are carbohydrates into which nitrogen is incorporated. These molecules allow proteins and sugars to combine and produce structures of remarkable variety and beauty. The most common amino sugars are *N*-acetyl glucosamine and *N*-acetyl galactosamine, which differ only in stereochemistry. The hard outer skeletons of insects and crustaceans contain chitin, a polymer very like cellulose but made of acetyl glucosamine instead of glucose itself. It coils up in a similar way and provides the toughness of crab shells and beetle cases.

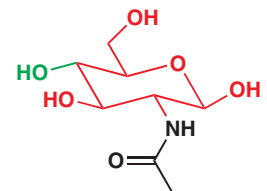
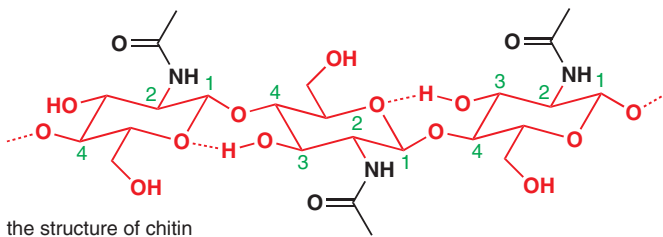

N-acetyl glucosamine

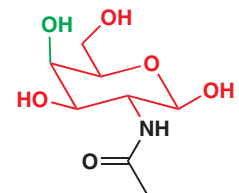

N-acetyl galactosamine

Cell membranes must not be so impermeable as they need to allow the passage of water and complex molecules. These membranes contain *glycoproteins*—proteins with amino sugar residues attached to asparagine, serine, or threonine in the protein. The attachment is at the anomeric position so that these compounds are *O*- or *N*-glycosides of the amino sugars. The structure below shows *N*-acetyl galactosamine attached to an asparagine residue as an *N*-glycoside.

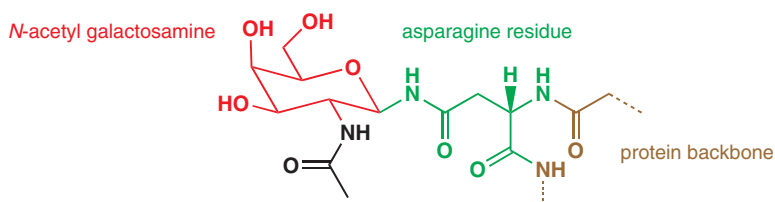

Lipids

Lipids (fats) are the principal components of cell membranes. Along with cholesterol, also a component of the cell membrane, they have acquired a bad name, but they are nonetheless essential to the function of membranes as selective barriers to the movement of molecules. The most common types of lipids are esters of glycerol. Glycerol is just propane-1,2,3-triol but it has interesting stereochemistry. It is not chiral as it has a plane of symmetry, but the two primary OH groups are enantiotopic. If one of them is modified—by esterification, for

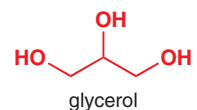

glycerol

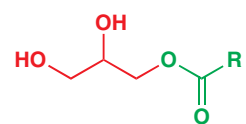

glycerol monoester

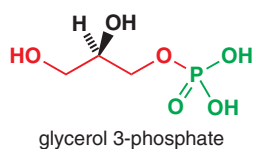

example—the molecule becomes chiral. Natural glycerol 3-phosphate is such an ester and it is optically active.

A typical lipid in foodstuffs is the triester formed from glycerol and oleic acid, which is the most abundant lipid in olive oil. Oleic acid is a mono-unsaturated fatty acid—it has one *Z* double bond in the middle of the C_{18} chain. This bond gives the molecule a marked kink in the middle. The compound actually present in olive oil is the triester, also kinked.

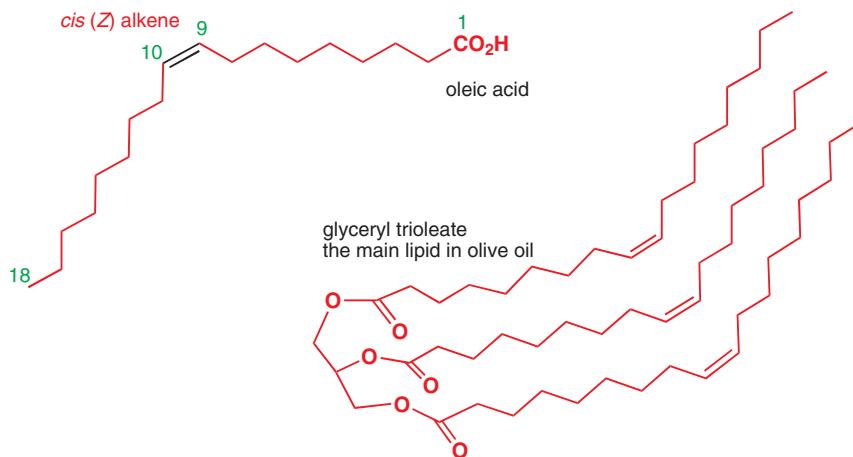

Oil and water do not mix

■ You may have done the Langmuir trough experiment in a physical chemistry practical class. This involves measuring the size of a molecule by allowing an oil to spread on the surface of water in a unimolecular layer.

The lipid has, more or less, the conformation shown in the diagram with all the polar ester groups at one end and the hydrocarbon chains bunched together in a non-polar region. Oil and water do not mix, it is said, but triglyceride lipids associate with water in a special way. A drop of oil spreads out on water in a very thin layer. It does so because the ester groups sit inside the water and the hydrocarbon side chains stick out of the water and associate with each other.

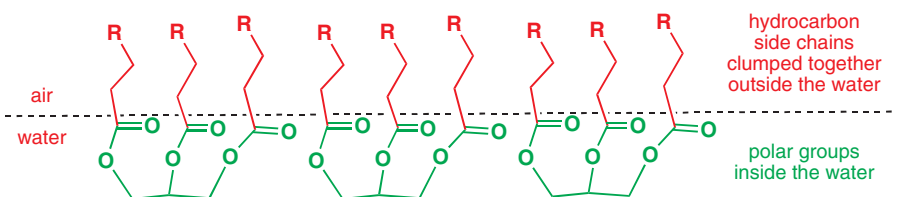

When triglycerides are boiled with alkali, the esters are hydrolysed and a mixture of carboxylate salts and glycerol is formed. This is how soap is made—hard soap is the sodium salt and soft soap the potassium salt.

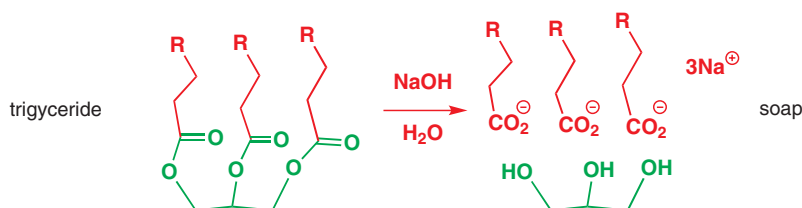

When a soap is suspended in water, the carboxylate groups have a strong affinity for the water and so oily globules or **micelles** are formed with the hydrocarbon side chain inside. It is these globules that remove greasy dirt from you or your clothes.

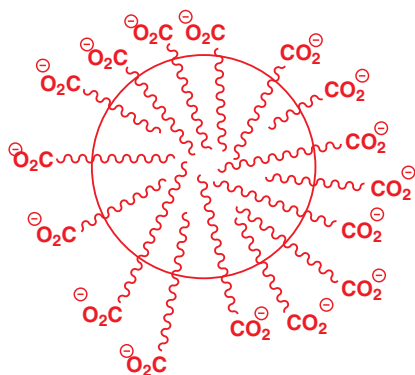

Mechanisms in biological chemistry

Nature uses the same chemistry as we do in the laboratory, and to do that chemistry she needs reagents. Chemists are free to use temperatures typically ranging 100 °C either side of 20 °C, any solvents they choose, inert or reactive atmospheres, and so on. Not so nature: all nature's reagents must work at ambient temperature in the presence of water and in the presence of a reactive gas, oxygen. In this section we will survey some of nature's solutions to these challenges.

Nature's NaBH_4 is a nucleotide: NADH or NADPH

You met nucleotides, and their role in the structure of nucleic acids, earlier in this chapter. Nature also uses nucleotides as reagents. Here is the structure of AMP, just to remind you of a structure you met before, side by side with a pyridine-containing nucleotide.

AMP—an adenine nucleotide

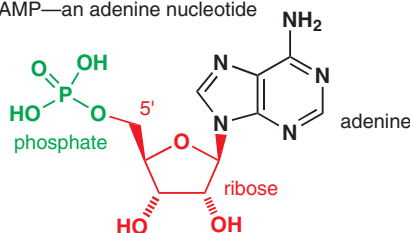

a nicotinamide nucleotide

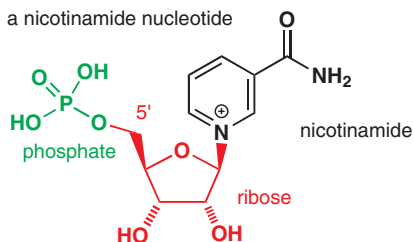

These two nucleotides can combine together as a pyrophosphate to give a dinucleotide called nicotinamide adenine dinucleotide, or NAD (or NAD^+ —note the positively charged pyridinium). Notice that the link is not at all the same as in the nucleic acids. The latter are joined by one phosphate that links the 3' and 5' positions. Here we have a pyrophosphate link between the two 5' positions.

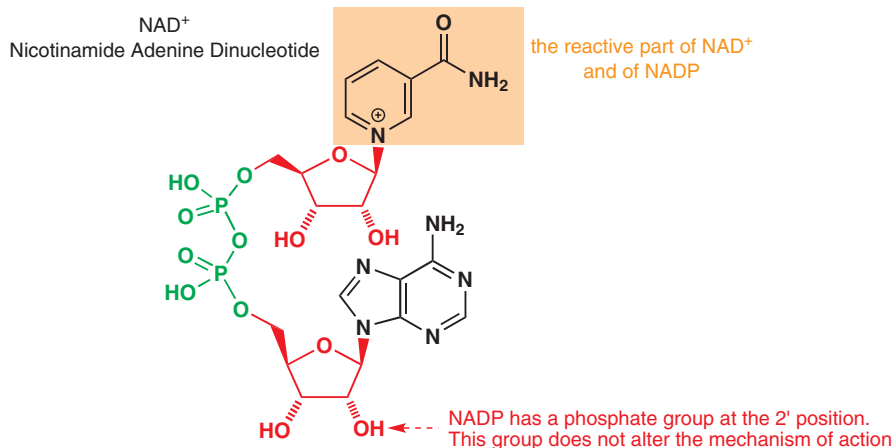

The positively charged pyridinium ring is the part of the molecule which does all the work and from now on we will draw only the reactive part for clarity. NAD^+ is one of nature's most important oxidizing agents. Some biochemical pathway reactions use NADP instead, but this differs only in having an extra phosphate group on the adenosine portion so the same part structure will do for both. NAD^+ and NADP both work by accepting a hydrogen atom and a pair of electrons from another compound. The reduced compounds are called NADH and NADPH .

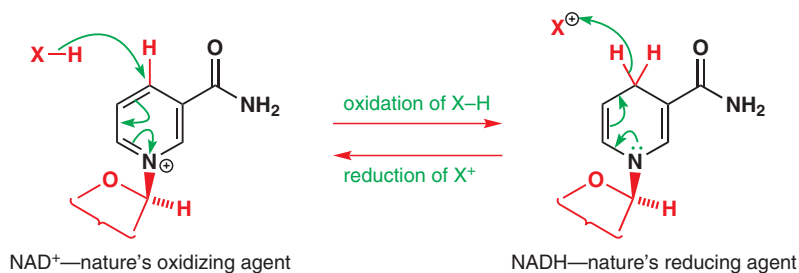

The names of enzymes are usually chosen to tell us where they come from and what job they do and the name ends '-ase'. A **dehydrogenase** is a redox enzyme which catalyses the removal (or, as in this case, the addition) of hydrogen.

The reduction of NAD^+ (and NADP) is reversible, and NADH is itself a reducing agent. We will first look at one of its reactions: a typical reduction of a ketone. The ketone is pyruvic acid and the reduction product is lactic acid—both important metabolites. The reaction is catalysed by an alcohol dehydrogenase.

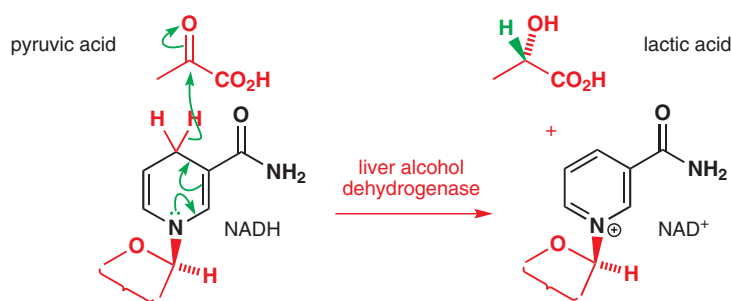

This is a reaction that would also work in the laboratory with NaBH_4 as the reducing agent, but there is a big difference. The product from the NaBH_4 reaction *must* be racemic—the starting material, reagent, and solvent are all achiral.

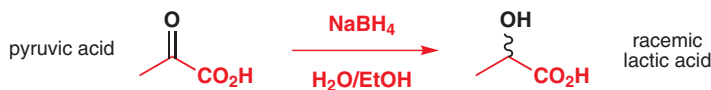

➡ If you are not clear about enantioselective reactions and why NaBH_4 must give a racemic mixture, re-read Chapter 41. If you are not clear about the terms 'enantiotopic' and 'prochiral' re-read Chapters 31 and 33. If you are not clear about what enantiomers are, you must re-read Chapter 14 now.

But the product from the enzymatic reaction is optically active. The two faces of pyruvic acid's carbonyl group are enantiotopic and, by controlling the addition so that it occurs from one face only, the enzyme-catalysed reaction gives a single enantiomer of lactic acid.

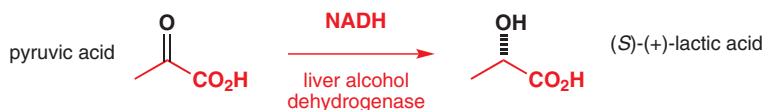

Reductive amination in nature

One of the best methods for making amines in the laboratory is **reductive amination**, in which an imine (formed from a carbonyl compound and an amine) is reduced to a saturated amine. Common reducing agents include NaCNBH_3 and hydrogen with a catalyst.

➡ For more on reductive amination, see Chapter 11.

reductive amination in the laboratory

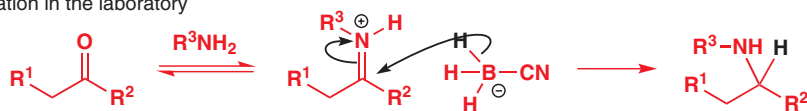

This reaction, of course, produces racemic amines. But nature transforms this simple reaction into an enantioselective and reversible one that is beautiful in its simplicity. The reagents are a pair of substituted pyridines called pyridoxamine and pyridoxal, and the enzyme is an aminotransferase.

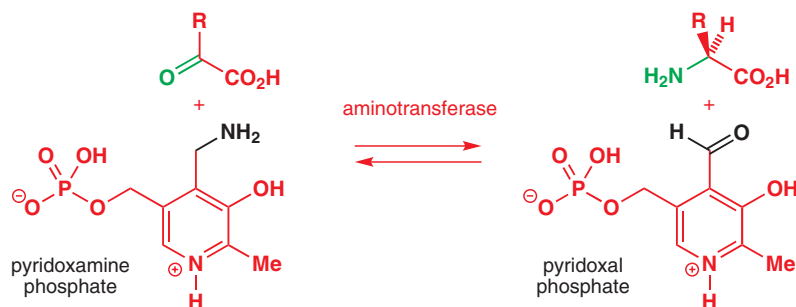

The mechanism of the amination starts with the formation of an imine from the black amino group and the green carbonyl. Removal of the now very acidic proton between the protonated pyridine and the conjugated imino-carboxylic acid gives a dihydropyridine, which rearomatizes by protonation next to the carboxylic acid. This step is enantioselective, with the proton being delivered from the enzyme. Finally, hydrolysis of the new imine gives pyridoxal and a single enantiomer of the amino acid.

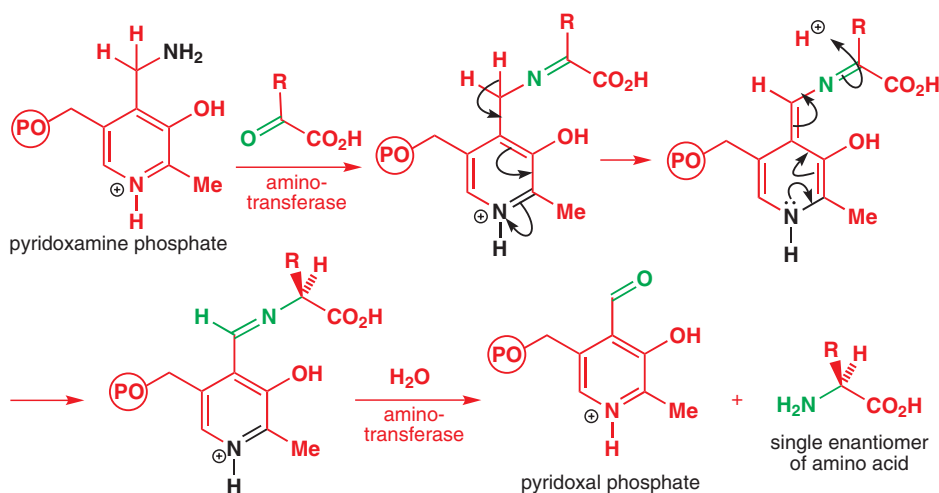

■ 'OP' or 'P' in a circle is commonly used to represent a phosphate group.

Nature's enolate equivalents: lysine enamines and coenzyme A

Nature breaks down glucose to produce energy, and in doing so produces smaller molecules which enter the citric acid cycle and are converted ultimately to carbon dioxide. In the other direction, the six-carbon sugar fructose can be made from two three-carbon fragments. The key reaction in both cases is the step in which the C–C bond linking the two C₃ sugars is formed or broken. The C₃ sugars are glyceraldehyde and dihydroxyacetone, both as their phosphate esters, and the reaction between them is an aldol condensation. The enol of dihydroxyacetone phosphate attacks the electrophilic aldehyde carbonyl group of glyceraldehyde 3-phosphate, catalysed by an enzyme named aldolase. The product is a ketohexose (i.e. a six-carbon sugar with a ketone carbonyl group), fructose-1,6-bisphosphate.

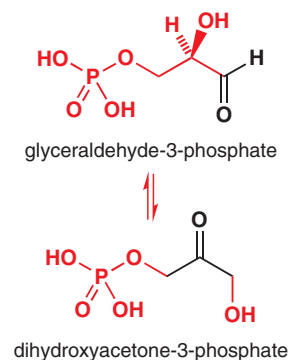

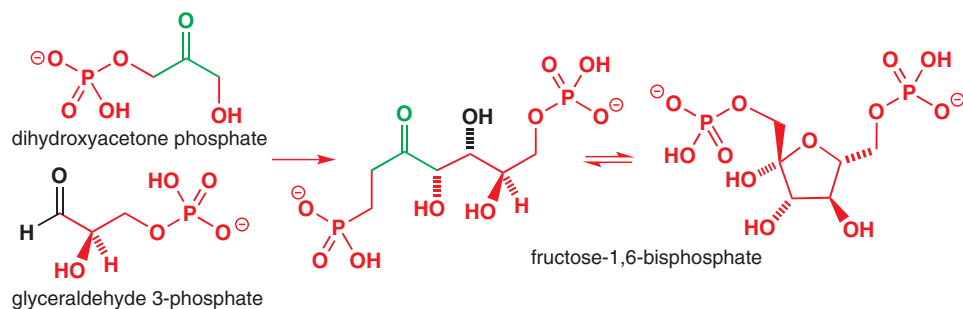

No enolate ion is formed in this aldol reaction. Instead a lysine residue in the aldolase enzyme forms an imine with the keto-triose.

■ The rest of the aldolase molecule is represented by 'Enz'.

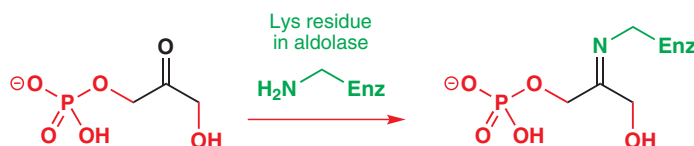

Proton transfers allow this imine to be converted into an enamine, which acts as the nucleophile in the aldol reaction. Stereochemical control (it's a *syn* aldol) comes from the way in which the two molecules are held by the enzyme as they combine. The product is the imine, which is hydrolysed to the open-chain form of fructose-1,6-bisphosphate.

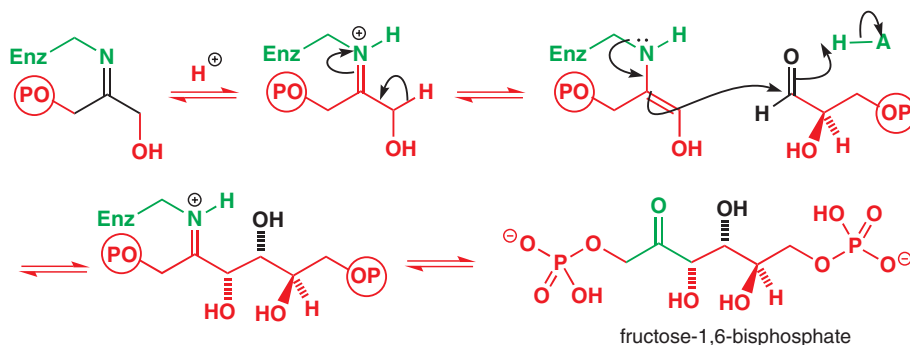

Many other reactions in nature use enamines, mostly those formed from lysine. However, a more common enol equivalent is based on thiol esters derived from coenzyme A. Coenzyme A is an adenine nucleotide at one end, linked by a 5'-pyrophosphate to pantothenic acid, a compound that looks rather like a tripeptide, and then to an amino thiol. Here is the structure broken down into its parts.

■ Compare this structure with that of NAD—the adenine nucleotide is the same, as is the 5'-pyrophosphate link. The difference is at the other end of that link where we find this new tripeptide-like molecule and not another nucleotide. There is also a 3'-phosphate on the ribose ring not present in NAD (and note that while NADP contains a phosphorylated ribose, its phosphate is on the 2' hydroxyl group!).

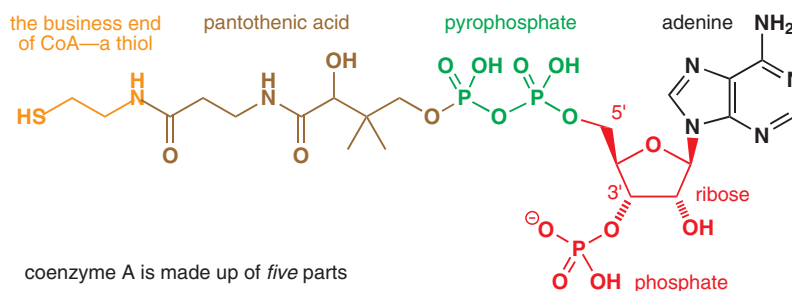

By now you will realize that most of this molecule is there to allow interaction with the various enzymes that catalyse the reactions of coenzyme A. Coenzyme A is conveniently abbreviated in structures to CoASH, where the SH is the vital thiol functional group, and all the

reactions we will be interested in are those of esters of CoASH. These are thiol esters, as opposed to normal alcohol esters, and the difference is worth a few comments.

Thiol esters are less conjugated than ordinary esters, and ester hydrolysis occurs more rapidly with thiol esters than with ordinary esters because in the rate-determining step (nucleophilic attack on the carbonyl group) there is less conjugation to destroy. The thiolate is also a better leaving group.

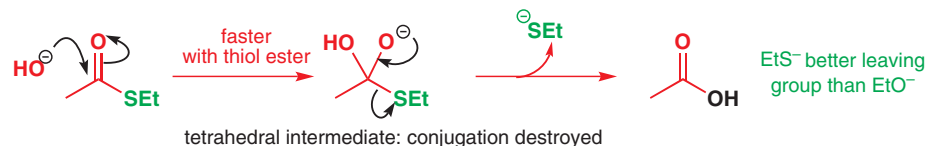
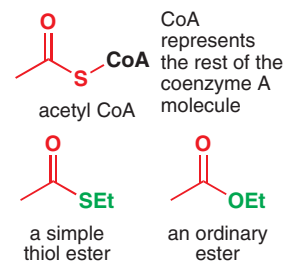

Another reaction that goes better with thiol esters than with ordinary esters is enolization. This is an equilibrium reaction and the enol has lost the conjugation present in the ester. Again, a thiol ester has less to lose so is more enolized, and it is the enolization of thioesters of coenzyme A that we are now going to discuss.

We mentioned the citric acid cycle earlier but we have not so far discussed the chemistry involved. The citric acid cycle allows metabolism to shunt carbon atoms between small molecules, and the key step is the synthesis of citric acid from oxaloacetate and acetyl CoA. The reaction is essentially an aldol reaction between the enol of an acetate ester and an electrophilic ketone, and the enzyme which catalyses the reaction is known as citrate synthase.

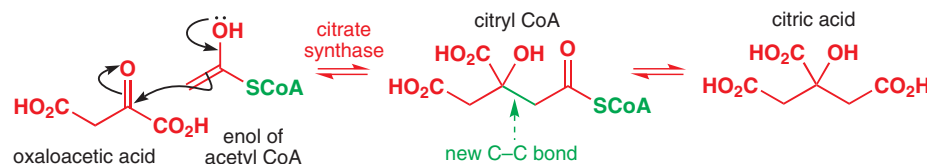
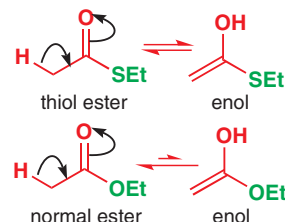

The mechanism shows the enol of acetyl CoA attacking the reactive ketone. In nature all these reactions are catalysed by the enzyme. In the C-C bond-forming step, one histidine residue removes the enol proton and another histidine, in its protonated form, is placed to donate a proton to the oxygen atom of the ketone. You should see now why histidine is so useful to enzymes: its imidazole ring means it can act either as an acid or as a base at neutral pH.

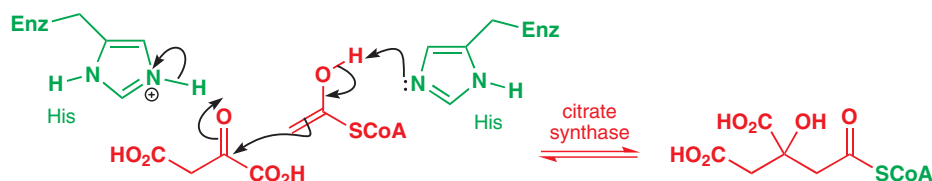

Even the hydrolysis of the reactive thiol ester is catalysed by the enzyme and histidine again functions as a proton donor, with the hydrolysis, like the enolization, being enhanced by the thiol ester.

The two enol equivalents that we have met so far are quite general: lysine enamines can be used for any aldehyde or ketone and CoA thiol esters for any ester. Another class of enol equivalent—the enol ester—has just one representative but it is a most important one.

Phosphoenolpyruvate

Pyruvic acid is an important metabolite in its own right, as we shall see shortly. It is the simplest α -keto-acid (2-oxopropanoic acid). Having the two carbonyl groups adjacent makes them more reactive: the ketone is more electrophilic and enolizes more readily, and the acid is stronger.

Nature uses the enol phosphate of pyruvic acid (phosphoenolpyruvate or PEP) as an important reagent. We might imagine making this compound by first forming the enol and then esterifying on oxygen by some phosphorylating agent such as ATP.

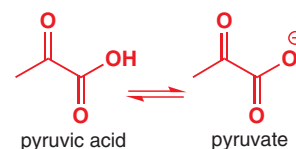

For an explanation of the effect of two adjacent carbonyl groups, see Chapter 26, p. 643.

The $\text{p}K_a$ of protonated imidazole is about 7: see Chapter 8.

This is general acid catalysis, as described in Chapter 39.

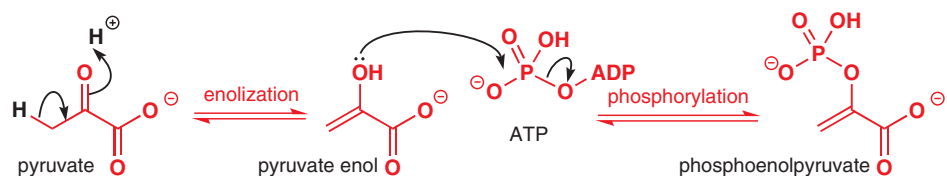

Now, in fact, this reaction does occur in nature as part of the glycolysis pathway, but it occurs almost entirely in reverse. PEP is used as a way to make ATP from ADP during the oxidation of energy-storing sugars. An enol is a better leaving group than an ordinary alcohol, especially if it can be protonated at carbon. The reverse reaction might look like this.

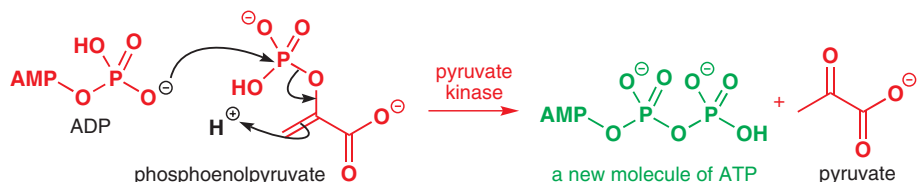

PEP is also used as an enol in the making of carbon–carbon bonds when the electrophile is a sugar molecule. But if PEP is not made by enolization of pyruvate, how is it made? The answer is by dehydration. The phosphate is already in place when the dehydration occurs, catalysed by the enzyme enolase.

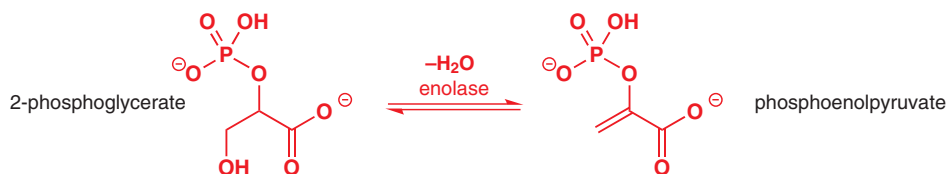

You saw in Chapter 17 how simple OH groups can be lost in dehydration reactions. Either the OH group was protonated by strong acid (this is not an option in living things) or an enol or enolate pushed the OH group out in an E1cB-like mechanism. This must be the case here as the better leaving group (phosphate) is ignored and the worse leaving group (OH) expelled.

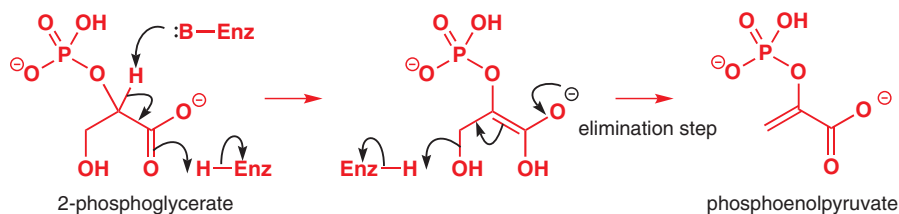

The shikimic acid pathway

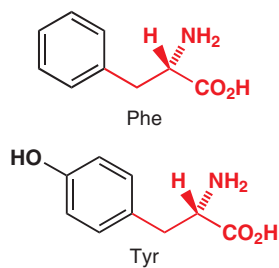

The shikimic acid pathway is responsible for the biosynthesis of a large number of aromatic compounds, particularly in plants. Most important for many mammals is the fact that plants manufacture the aromatic amino acids Phe (phenylalanine), Tyr (tyrosine), and Trp (tryptophan). These are 'essential' amino acids for humans—we have to have them in our diet as we cannot make them ourselves.

So how do plants make aromatic rings? A clue to the chemistry involved comes from the structure of caffeoyl quinic acid, a compound that forms about 13% of the soluble solids from coffee beans. A substantial proportion of instant coffee is caffeoyl quinic acid.

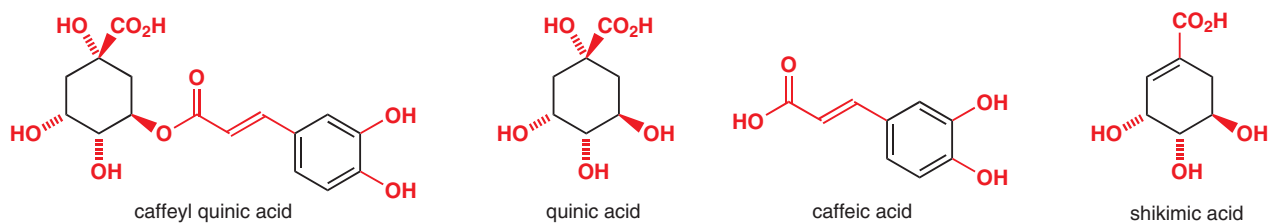

This ester has two six-membered rings—one aromatic and one saturated. You might imagine making an aromatic ring by the dehydration (losing three molecules of water) of a cyclohexane triol and the saturated ring in caffeoyl quinic acid looks a good candidate. It is now known that both rings (shown in black) come from the same intermediate, shikimic acid.

This key intermediate has given its name to nature's general route to aromatic compounds and many other related six-membered ring compounds: the shikimic acid pathway. This pathway contains some of the most interesting reactions (from a chemist's point of view) in biology. It starts with an aldol reaction between phosphoenol pyruvate as the nucleophilic enol component and the C₄ sugar erythrose 4-phosphate as the electrophilic aldehyde.

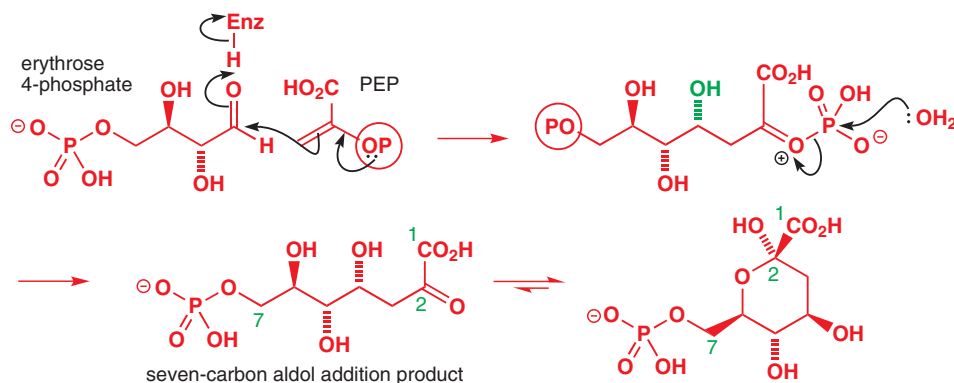

Hydrolysis of the phosphate releases the aldol product, a C₇ α-keto-acid with one new stereogenic centre, which is in equilibrium with a hemiacetal, just like a sugar. This intermediate has the right number of carbon atoms for shikimic acid and the next stage is a cyclization. If we redraw the uncyclized C₇ α-keto-acid in the right shape for cyclization we can see what is needed. The green arrow shows which bond needs to be formed. This bond could be formed by another aldol reaction, and there is an obvious route to the required enol by elimination of phosphate. However, this would require the removal of a proton (green in the diagram) that is not at all acidic.

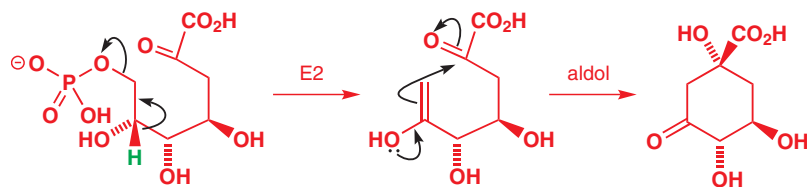
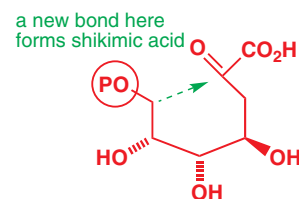

The problem can be avoided if the hydroxyl group at C₅ is first oxidized to a ketone (using NAD⁺ as the oxidant). Then the green proton is much more acidic, and the elimination becomes an E1cB reaction, similar to the one in the synthesis of PEP. True, the ketone must be reduced back to the alcohol afterwards but nature can deal with that easily. There are obviously several more steps to get to shikimic acid but all the C–C bonds are in place, the most significant of them being formed by aldol reactions.

Web link: You can find more on the shikimic acid pathway in the online chapter 'Mechanisms in biological chemistry'.

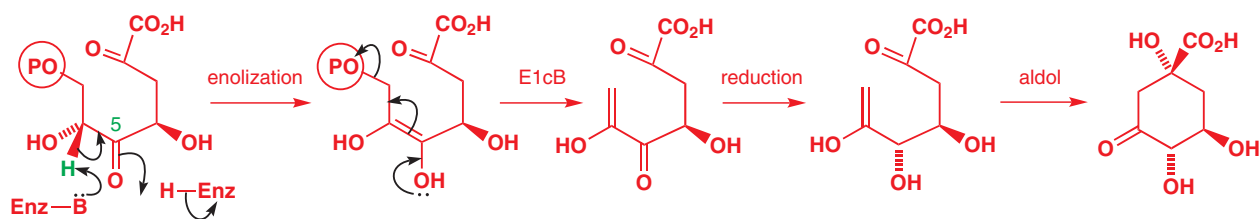

You can find more on the shikimic acid pathway in the online chapter 'Mechanisms in biological chemistry'.

Natural products

Organic chemists mean something particular by the phrase 'natural products'. Of course, all the compounds we have so far discussed are natural and their chemistry is common to most living things. But living things also make chemicals by the processes of secondary metabolism that are found in few, if any, other organisms. The flavouring principles of herbs and fruit, the antibiotics from moulds and the toxic alkaloids in plants are all examples. These compounds are what we mean by 'natural products', especially if they are useful to humans.

Natural products often seem to have little value to the organism itself, and are made by the processes of secondary metabolism. They are classified by the way they are made into terpenes and steroids, alkaloids, and polyketides.

Solanaceae alkaloids

The Solanaceae family includes not only deadly nightshade (*Atropa belladonna*—hence atropine) plants but also potatoes and tomatoes. Parts of these plants also contain toxic alkaloids, for example you should not eat green potatoes because they contain the toxic alkaloid solanine.

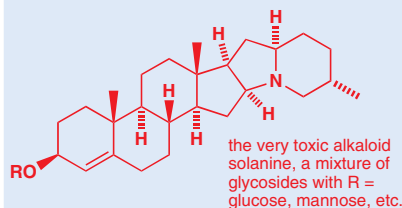

Atropine is a racemic compound but the (*S*)-enantiomer occurs in henbane (*Hyoscyamus niger*) and was given a different name, hyoscyamine, before the structures were known. In fact, hyoscyamine racemizes very easily just on heating in water or on treatment with weak base. This is probably what happens in the deadly nightshade plant.

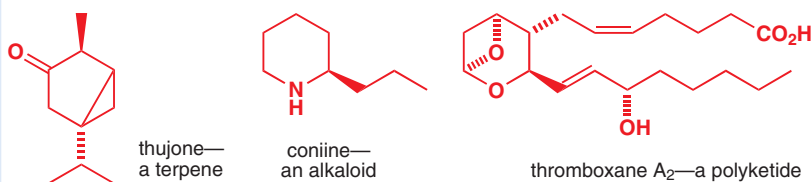

Thujone is a terpene that is thought to be the poisonous principle in absinthe—the drink that reduced many artists and writers to idiocy in Paris around 1900. Coniine is an alkaloid and the poison in hemlock with which Socrates was executed. Thromboxane is a polyketide involved in blood-clot formation and is a human natural product.

Alkaloids are made by amino acid metabolism

Alkaloids were known in ancient times because they are easy to extract from plants and some of them have powerful and deadly effects. Any plant contains thousands of chemical compounds, but some plants, like the deadly nightshade, can be mashed up and extracted with aqueous acid to give a few compounds soluble in that medium, which precipitate on neutralization. These compounds were seen to be 'like alkali' and in 1819 Meissner, the apothecary from Halle, named them 'alkaloids'. Lucrezia Borgia already knew all about this and put the deadly nightshade extract atropine in her eyes (to make her look beautiful: atropine dilates the pupils) and in the drinks of her political adversaries to avoid any trouble in the future. Now, we would simply say that they are basic because they are amines. Below is a selection with the basic amino groups marked in black. Natural products are often named by a combination of the name of the organism from which they are isolated and a chemical part name. These compounds are all *amines* so all their names end in '-ine'. They appear very diverse in structure but all are made in nature from amino acids.

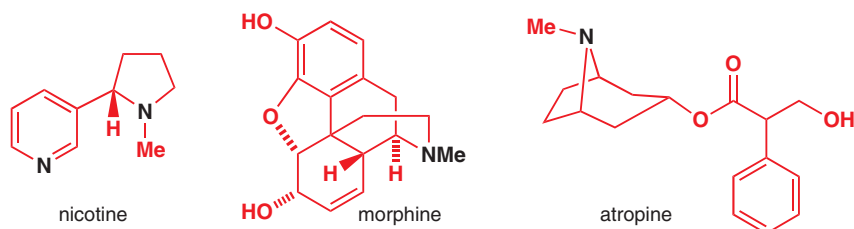

Pyrrolidine alkaloids are made from the amino acid ornithine

Pyrrolidine is the simple five-membered cyclic amine and pyrrolidine alkaloids such as nicotine contain this ring. All are made in nature from ornithine. Ornithine is an amino acid not usually found in proteins (it's one carbon atom shorter than lysine) but most organisms use it, often in the excretion of toxic substances. If birds are fed benzoic acid (PhCO_2H) they excrete dibenzoyl ornithine. When dead animals decay, the decarboxylation of ornithine leads to putrescine, the smell of rotten meat.

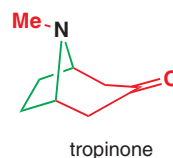
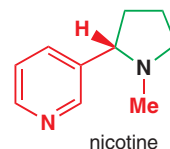
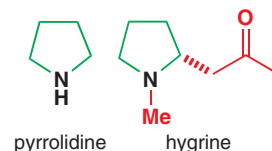
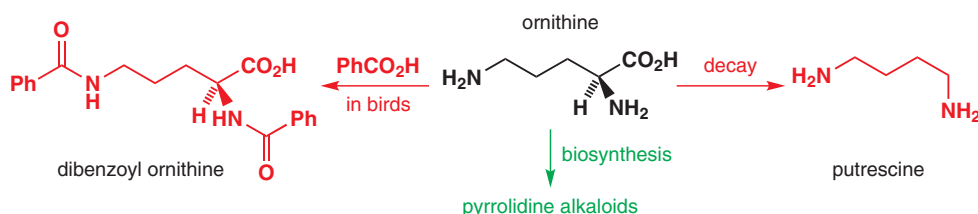

Biosynthetic pathways are usually worked out by isotopic labelling of potential precursors and in the schemes below the isotopically labelled atom is shown with a coloured blob. Some plants—notably the coca plant—produce the simple pyrrolidine alkaloid hygrine, which we will take as an illustration. If ornithine is made with a ^{14}C label at its α position and fed to the plant, labelled hygrine is isolated. If each amino group in ornithine is labelled in turn with ^{15}N , the α amino group is lost but the γ amino group is retained.

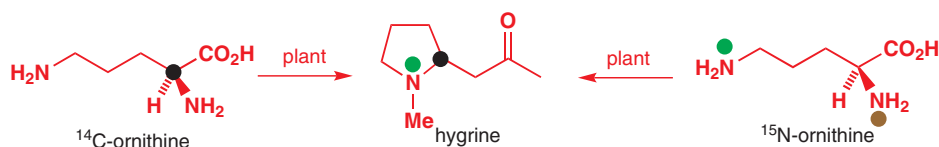

Further labelling experiments along these lines showed that the CO_2H group as well as the α amino group was lost from ornithine and that the rest of the molecule makes the pyrrolidine ring. The three-carbon side chain in hygrine comes from acetate, or rather from acetyl CoA, and the *N*-methyl group comes from (*S*)-adenosyl methionine (SAM, see p. 1136).

Labelling studies such as these tell us the origin of the atoms in the natural product, and we can now work through the biosynthesis—how the molecule is put together from those precursors. The first step is a pyridoxal-catalysed decarboxylation of ornithine.

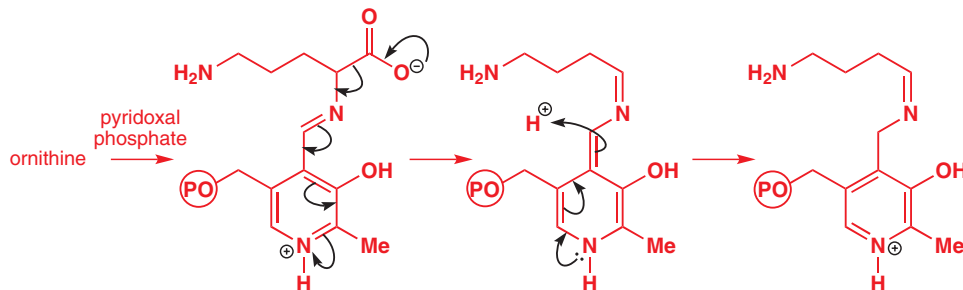

➔ You saw pyridoxal phosphate becoming involved in a reductive amination on p. 1151: here—and in other biochemical pathways too—a similar mechanism leads to decarboxylation.

Now the terminal amino group is methylated by SAM and the secondary amine cyclizes onto the pyridoxal imine to give an amination. Decomposition of the amination the other way round expels pyridoxamine and releases the salt of an electrophilic imine.

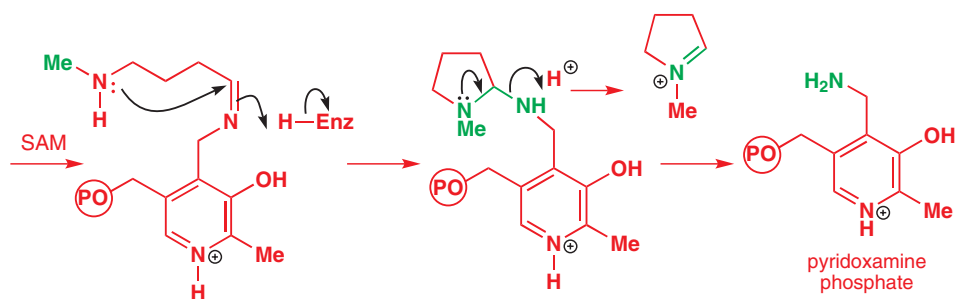

The rest of the hygrine structure comes from two molecules of acetyl CoA. We saw earlier in this chapter that the thiol ester is a good electrophile and also enolizes easily. We need both reactivities now in a Claisen ester condensation of acetyl CoA. The new keto-ester is very like the acetoacetates we used in Chapter 25 to make stable enolates and the CoA thiol ester will exist mainly as its enol, stabilized by conjugation.

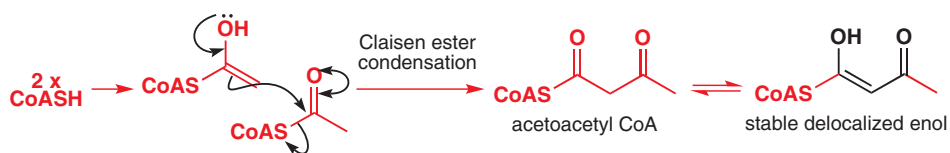

The cell has a good stock of acetyl CoA and its condensation product, and as soon as the iminium ion above is generated, it is attacked by the acetoacetyl CoA. All that remains to form hygrine is the hydrolysis of the CoA thiol ester and decarboxylation of the keto-acid. This is standard chemistry, but you should ensure that you can draw the mechanisms for these steps.

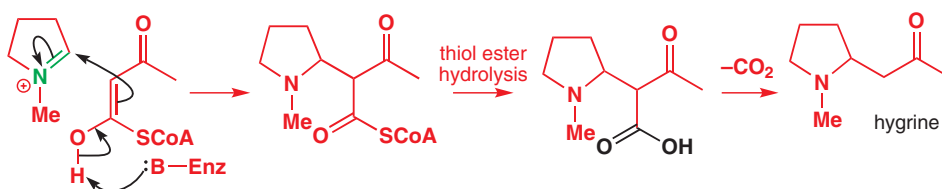

Tropinone is made from hygrine and it is clear what is needed. The methyl ketone must enolize and it must attack another iminium ion resembling the first but on the other side of the ring. A biological oxidant such as NADP is needed.

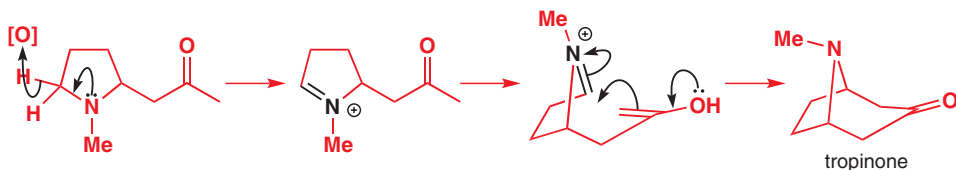

Robinson's tropinone synthesis

This complex route to tropinone was imitated as long ago as 1917 in one of the most celebrated reactions of all time, Robinson's tropinone synthesis. Robinson argued on purely chemical grounds that the sequence of imine salts and enols, which later (as shown in 1970) turned out to be nature's route, could be produced under 'natural' conditions (aqueous solution at pH 7) from a C₄ dialdehyde, MeNH₂, and acetone dicarboxylic acid. It worked and the intermediates must be very similar to those in the biosynthesis.

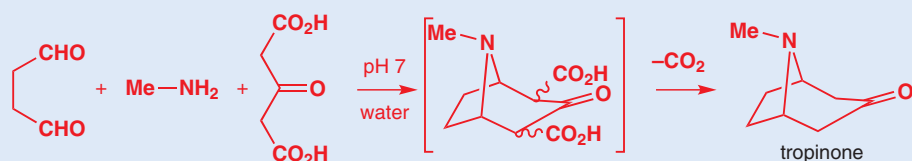

Benzyl isoquinoline alkaloids are made from tyrosine

The benzyl isoquinolines are another family of alkaloids of rather different structure. They all have a benzyl group attached to position 2 of an isoquinoline ring. Usually the alkaloids are oxygenated on the benzene ring and many are found in opium poppies (*Papaver somniferum*). For all these reasons papaverine is an ideal example.

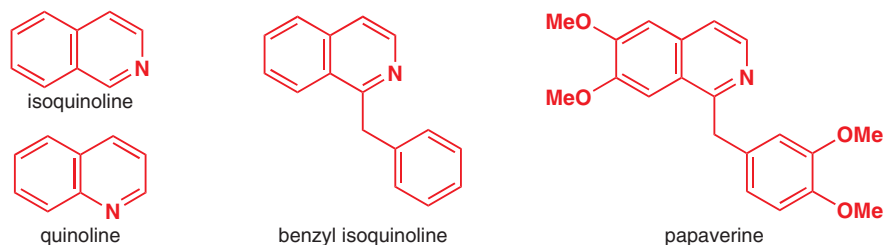

Labelling shows that these alkaloids come from two molecules of tyrosine. One must lose CO_2 and the other NH_3 . We can easily see how to divide the molecule in half, but the details will have to wait a moment.

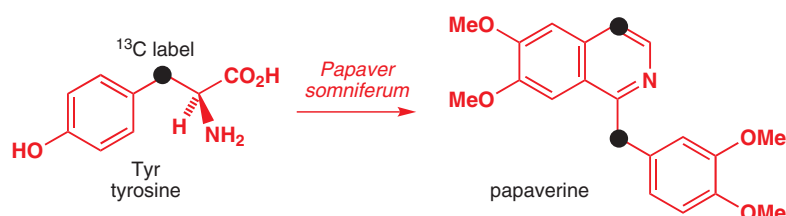

The question of when the extra OH groups are added was also solved by labelling and it was found that dihydroxyphenyl pyruvate (DHPP) was incorporated into both halves but the dihydroxyphenylalanine (an important metabolite, and also a useful medicine, usually called dopa) was incorporated only into the isoquinoline half.

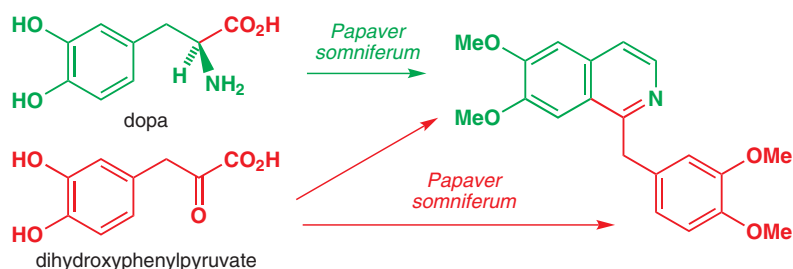

The amino acid and the keto-acid are related by a pyridoxal-mediated transaminase and the hydroxylation must occur right at the start.

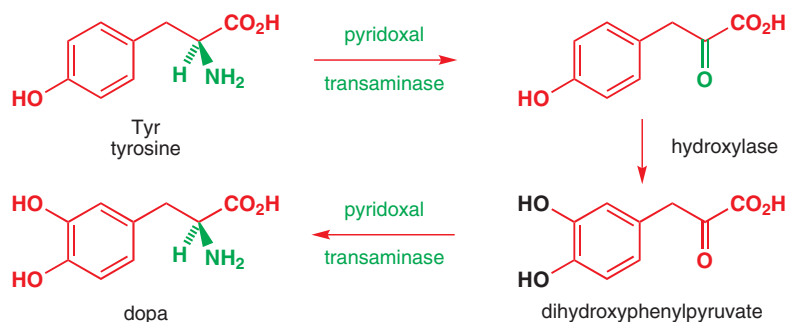

Pyridoxal-mediated decarboxylation of dopa gives dopamine and this reacts with the keto-acid to form an iminium ion perfectly placed for an intramolecular electrophilic aromatic substitution by the electron-rich dihydroxyphenyl ring.

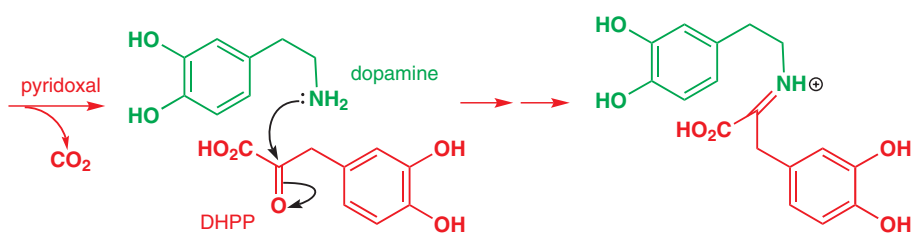

This closes the isoquinoline ring in a Mannich-like process with the phenol replacing the enol in the pyrrolidine alkaloid biosynthesis.

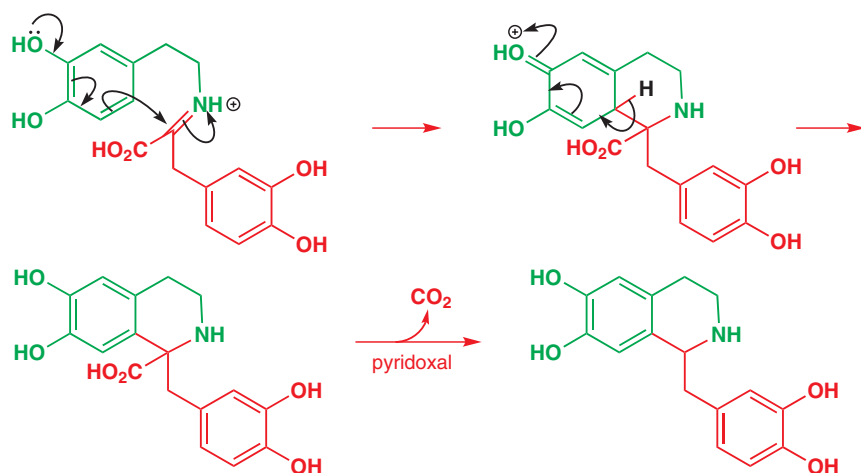

The cyclization product is still an amino acid and it can be decarboxylated by pyridoxal. Now we have something quite like papaverine but it lacks the methyl groups and the aromatic heterocyclic ring, which are introduced by methylation with SAM and oxidation.

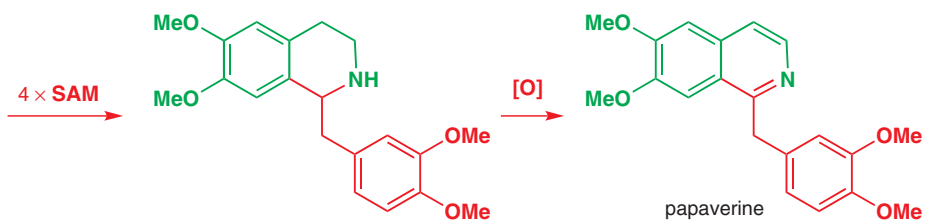

Synthesis of isoquinolines

As with tropinone, it is possible to make benzyl isoquinoline alkaloids very simply under mild conditions in the laboratory, providing that we use an aldehyde as the carbonyl component. The reaction (sometimes known as the Pictet–Spengler reaction) gives a reduced heterocyclic ring, as does the biosynthesis, but chemical oxidation can be used to give the isoquinoline.

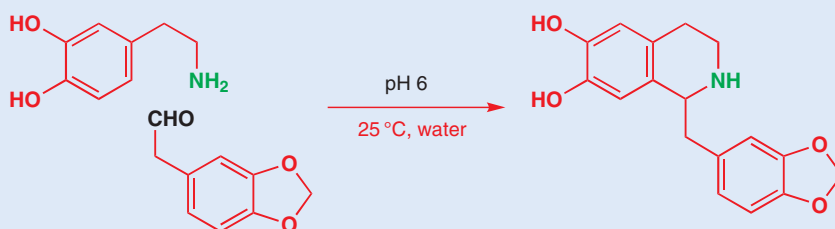

The mechanism is straightforward—the imine is formed and will be protonated at pH 6, ready for the C–C bond formation, which is both a Mannich reaction and an electrophilic aromatic substitution.

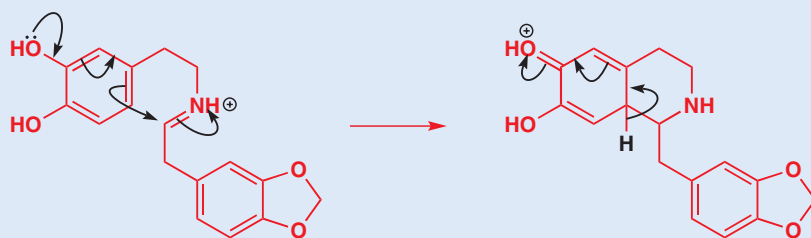

Notice that it was not necessary to protect the OH groups—the acetal on the lower ring is not for protection, and this group (methylenedioxy or dioxolane) is present in many benzyl isoquinoline alkaloids. It is formed in nature by oxidation of an MeO group *ortho* to an OH group on a benzene ring.

Fatty acids and other polyketides are made from acetyl CoA

In the last part of this chapter we will show how nature can take a very simple molecule—acetyl CoA—and build it up into an amazing variety of structures. There are two main pathways from acetyl CoA through malonyl CoA and mevalonic acid and each gives rise to two important series of natural products. Malonyl CoA leads to fatty acids and polyketides while mevalonic acid gives terpenes and steroids. We start with the simplest, the fatty acids. The list below shows just a few of the fatty acids that exist: all are present in a typical diet and you'll find many referred to on the labels of processed foods.

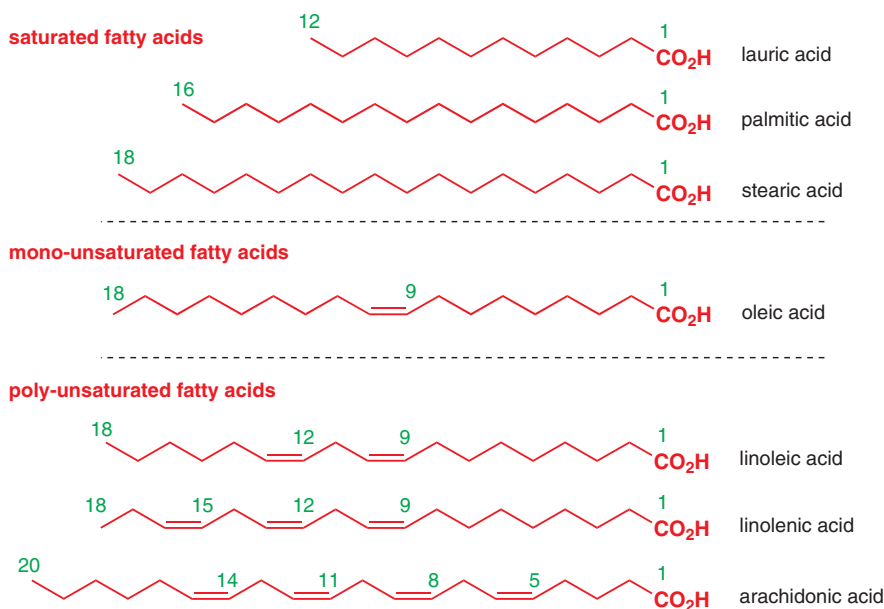
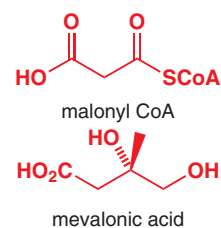

Fatty acids have some important features which you should note:

- They have straight chains with no branching.
- They have even numbers of carbon atoms.
- They may be saturated with no double bonds in the chain or they may have one or more C=C double bonds in the chain, in which case they are usually *cis* (*Z*) alkenes. If there is more than one C=C double bond, they are not conjugated (either with the CO₂H group or with each other)—there is normally one saturated carbon atom between them.

Palmitic acid (C₁₆ saturated) is the most common fatty acid in living things. Oleic acid (C₁₈ mono-unsaturated) is the major fatty acid in olive oil. Arachidonic acid (C₂₀ tetra-unsaturated)

is a rare fatty acid, which is the precursor of the very important biological messengers the prostaglandins, thromboxanes, and leukotrienes.

The prevalence of fatty acids with even numbers of carbon atoms suggests a two-carbon building block, the most obvious being acetate. If labelled acetate is fed to plants, the fatty acids emerge with labels on alternate carbons like this.

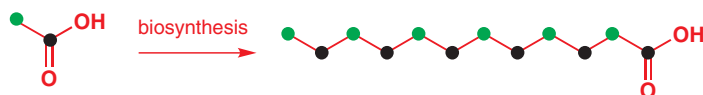

The green blob might represent deuterium (as a CD_3 group) and the black blob ^{13}C . In fact, the reactions are more complex than this suggests as CO_2 is also needed as well as CoA and it turns out that only the first two-carbon unit is put in as acetyl CoA. The remainder are added as malonyl CoA. If labelled malonyl CoA is fed, the starter unit, as it is called, is not labelled.

Malonyl CoA

Malonyl CoA is the thiol ester of CoASH and malonic acid. It is biosynthesized by acylation of acetyl CoA with carbon dioxide.



The first stage in fatty acid biosynthesis is a condensation between acetyl CoA (the starter unit) and malonyl CoA with the loss of CO_2 . This reaction could be drawn like this, with CO_2 being lost as the new C–C bond is formed. When chemists use malonates, we like to make the stable enol using both carbonyl groups, condense, and only afterwards release CO_2 (Chapter 25). As you saw on p. 1158, nature does this in making acetoacetyl CoA during alkaloid biosynthesis, but here things work differently.

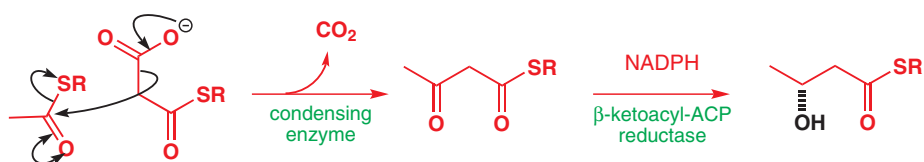

The next step is reduction of the ketone group. This NADPH reaction is typically stereo- and chemoselective, although the stereochemistry is rather wasted here as the next step is a dehydration, typical of what is now an aldol product, and occurring by an enzyme-catalysed E1cB mechanism. The elimination is known to be a *cis* removal of H and OH, and the double bond is exclusively *trans* (*E*). Finally in this cycle, the double bond is reduced using another molecule of NADPH to give the saturated side chain.

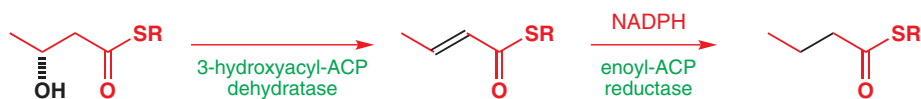

Now the whole cycle can start again using this newly made C_4 fatty acid as the starter unit and building a C_6 fatty acid and so on. Each time the cycle turns, two carbon atoms are added to the acyl end of the growing chain.

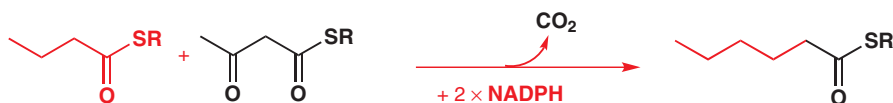

What is so important about unsaturated fatty acids?

Mammals can insert a *cis* alkene into the chain, providing that it is no further away from the carbonyl group than C9. We cannot synthesize linoleic or linolenic acids (see chart on p. 1161) directly as they have alkenes at C12 and C15, so these acids must be present in our diet.

But why are we so keen to have them? They are needed for the synthesis of arachidonic acid, a C₂₀ tetraenoic acid that is the precursor for some very interesting and important compounds. This is the biosynthesis of arachidonic acid.

biosynthesis of unsaturated fatty acids

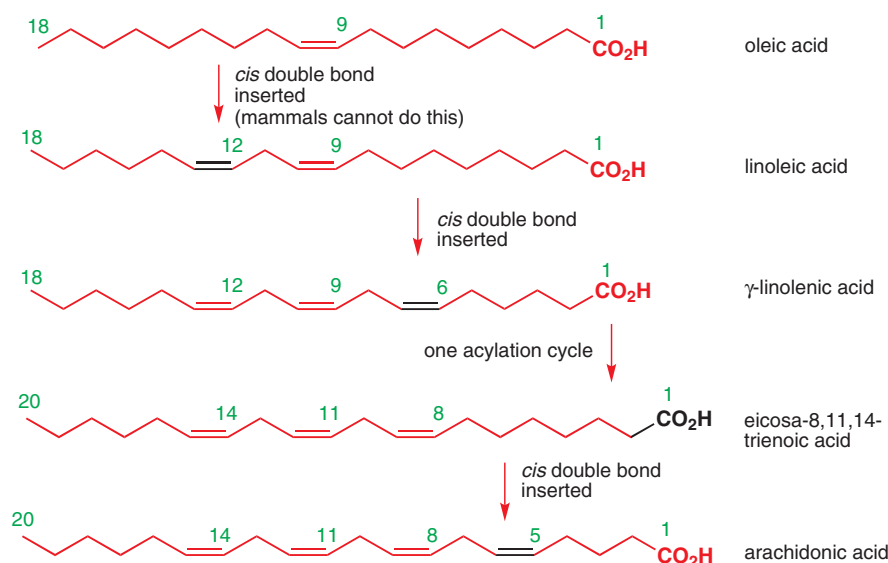

The final product of this chain of events—arachidonic acid—is one of the eicosanoids, so-called because *eicosa* is Greek for twenty. The leukotrienes resemble arachidonic acid most closely, the prostaglandins have a closed chain forming a five-membered ring, and the thromboxanes resemble the prostaglandins but have a broken chain. All are C₂₀ compounds with the sites of the alkenes (C5, C8, C11, and C14) marked by functionality or some other structural feature.

compounds synthesized from arachidonic acid

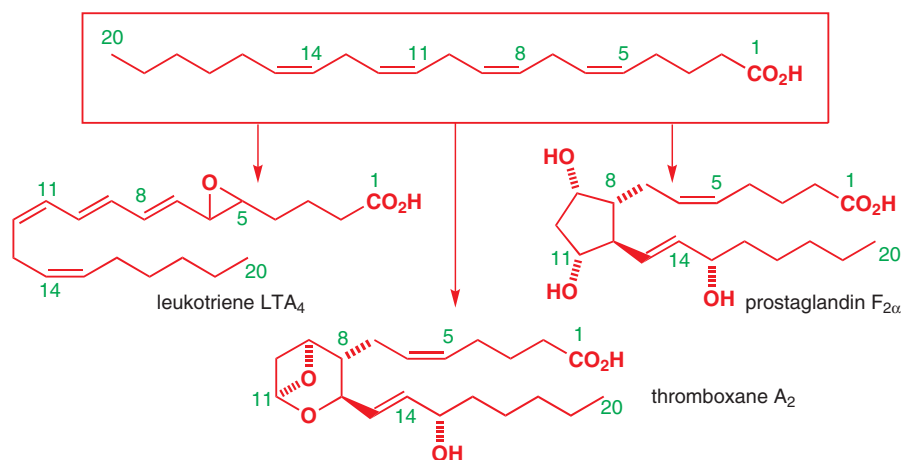

These compounds, made by oxidation of arachidonic acid, are all unstable and all are involved in transient events such as inflammation, blood clotting, fertilization, and immune responses. They are produced locally and decay quickly, and are implicated in autoimmune diseases like asthma and arthritis.

Aromatic polyketides

Other starter units such as 4-hydroxycinnamic acid, made from shikimic acid, can be used to build up aromatic compounds. The addition of three malonyl CoA units gives a linear

Full details of the biosynthesis of the fatty acids and their metabolites are in the online chapter 'Natural products'.

tetraketone (hence the same of this class of natural product) that can cyclize to resveratrol, a compound in red grape skins that has been suggested as one of the compounds in red wine that protects against heart disease.

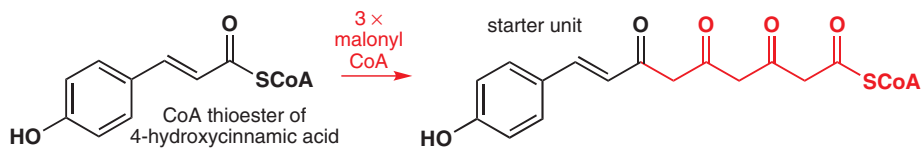

Redrawing this intermediate shows how easily it can cyclize to a six-membered ring. Enol formation allows a very favourable aldol cyclization to give a six-membered ring then dehydration and enolization to make the aromatic ring with hydrolysis of the CoA ester and decarboxylation gives resveratrol.

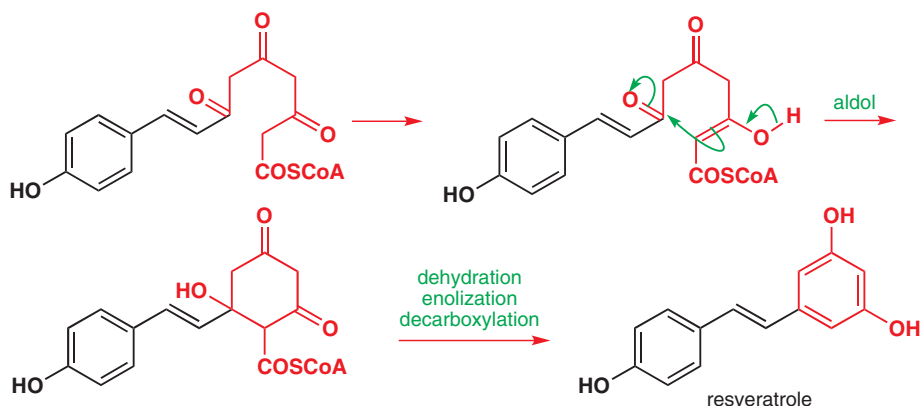

Terpenes are volatile constituents of plants

Terpenes were originally named after turpentine, the volatile oil from pine trees used in oil painting, whose major constituent is α -pinene. The term was rather vaguely used for all the volatile oily compounds, insoluble in water and usually with resinous smells from plants. Oils distilled from plants, which often contain perfumery or flavouring materials, are called essential oils and these too contain terpenes. Examples include camphor from the camphor tree, which is used to preserve clothes from moths, and humulene from hops, which helps to give beer its flavour.

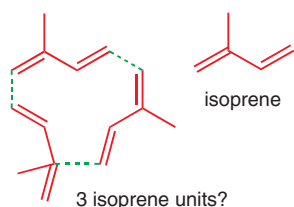
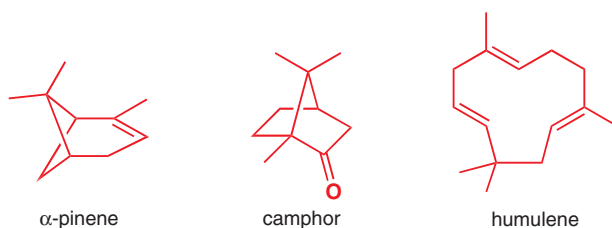

You will notice that they are all aliphatic compounds with a scattering of double bonds and rings, few functional groups, and an abundance of methyl groups. A better definition (that is, a biosynthetically based definition) arose when it was noticed that all these compounds have $5n$ carbon atoms. Pinene and camphor are C_{10} compounds while humulene is C_{15} . It seemed obvious that terpenes were made from a C_5 precursor and the favourite candidate was isoprene (2-methylbuta-1,3-diene) as all these structures can be drawn by joining together 2-, 3-, or 4-isoprene skeletons end to end.

In fact, this is not correct. Isoprene is not an intermediate, and the discovery of the true pathway started when acetate was, rather surprisingly, found to be the original precursor for all terpenes. The key intermediate is mevalonic acid, formed from three acetate units and usually isolated as its lactone.

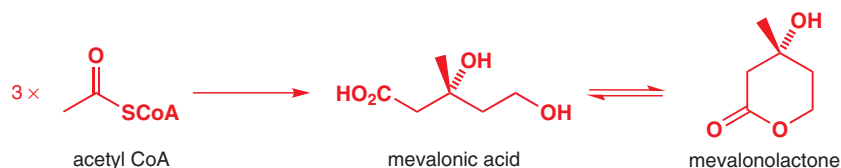

The first step is the Claisen ester condensation of two molecules of acetyl CoA, one acting as an enol and the other as an electrophilic acylating agent to give acetoacetyl CoA. We saw the same reaction in the biosynthesis of the pyrrolidine alkaloids earlier in this chapter.

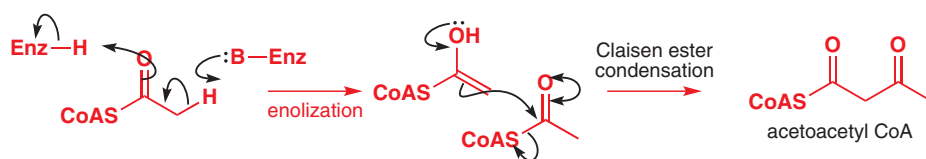

The third molecule of acetyl CoA also functions as a nucleophilic enol and attacks the keto group of acetoacetyl CoA. This is not a Claisen ester condensation—it is an aldol reaction between the enol of a thiol ester and an electrophilic ketone.

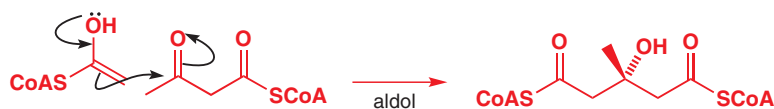

We have drawn the product with stereochemistry even though it is not chiral. This is because one of the two enantiomeric thiol esters is hydrolysed while this intermediate is still bound to the enzyme, so a single enantiomer of the half-acid/half-thiol ester results.

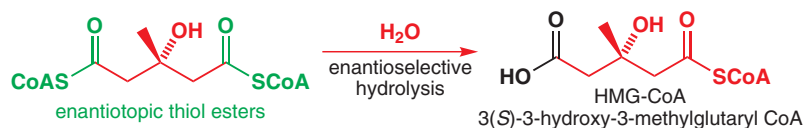

The remaining thiol ester is more electrophilic than the acid and can be reduced by the nucleophilic hydride from NADPH. Just as in LiBH_4 reductions of esters (Chapter 23), the reaction does not stop at the aldehyde level, and two molecules of NADPH are used to make the alcohol. This is mevalonic acid.

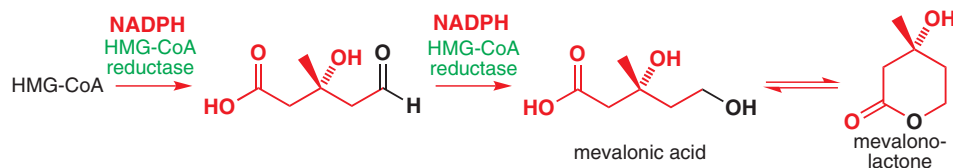

Mevalonic acid is indeed the true precursor of the terpenes but it is a C_6 compound and so it must lose a carbon atom to give the C_5 precursor. The spare carbon atom becomes CO_2 by an elimination reaction. First, the primary alcohol is pyrophosphorylated with ATP; then the CO_2H group and the tertiary alcohol are lost in a concerted elimination.

■ 'PP' indicates the pyrophosphate group transferred from ATP.

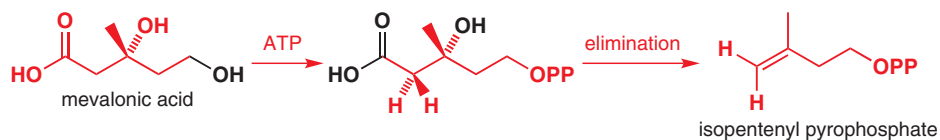
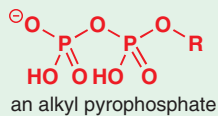

So is isopentenyl pyrophosphate the C_5 intermediate at last? Well, yes and no. There are actually two closely related C_5 intermediates, each of which has a specific and appropriate role in terpene biosynthesis. Isopentenyl pyrophosphate is in equilibrium with dimethylallyl pyrophosphate by a simple allylic proton transfer.

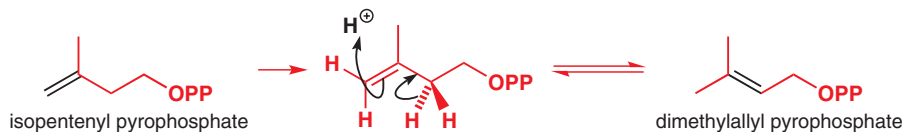

The two C_5 intermediates now react with each other. The dimethylallyl pyrophosphate is the better electrophile because it is allylic, and allylic compounds are good at both S_N1 and S_N2 reactions (Chapter 15). Isopentenyl pyrophosphate is the better nucleophile because it can react through an unhindered primary carbon atom to produce a tertiary cation—we can draw the reaction like this:



Although this idea reveals the thinking behind the reaction, in fact it does not go quite like this. The product is one particular positional and geometrical isomer of an alkene and the cation is not an intermediate. Indeed, the reaction is also stereospecific (discovered again by proton labelling, but we will not give the rather complex details) and this too suggests a concerted process.

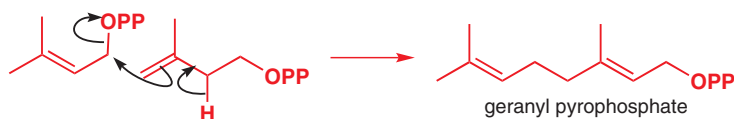

As soon as we start to make typical cyclic monoterpenes from geranyl pyrophosphate we run into a snag. We cannot cyclize geranyl pyrophosphate because it has a *trans* double bond! We *could* cyclize the *cis* compound (neryl pyrophosphate), and it used to be thought that this was formed from the *trans* compound as an intermediate.

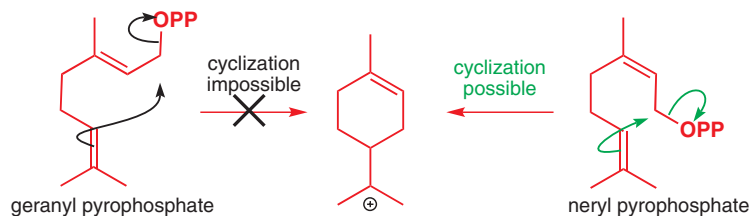

It is now known that nature gets round this problem without making neryl pyrophosphate. An allylic rearrangement occurs to move the pyrophosphate group to the tertiary centre. This is an unfavourable rearrangement thermodynamically and probably occurs via the allyl cation and is catalysed by $Mg(II)$. There is no longer any geometry about the alkene. The molecule can now rotate freely about a single bond and cyclization can occur. Even if only a small amount of the rearranged allylic pyrophosphate is present, that can rearrange and more can isomerize.

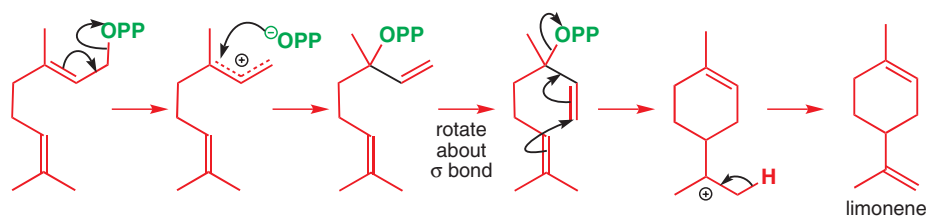

More interesting compounds come from the cyclization of the first formed cation. The remaining alkene can attack the cation to form what looks at first to be a very unstable compound but which is actually a tertiary carbocation with the pinene skeleton. There are many thousands of terpenes with multiple C_5 units all made from mevalonic acid.

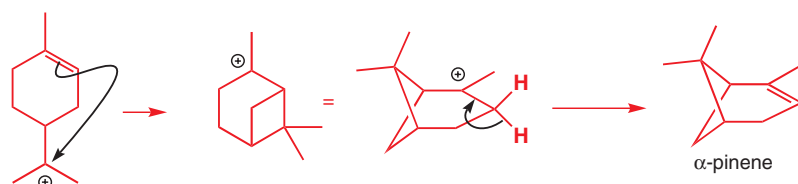

The steroids are another group of compounds derived from mevalonic acid. They include sex hormones such as testosterone and progesterone, and the cholesterol needed to build cell membranes but also implicated in the damage to arteries caused by atherosclerosis.

The synthesis of the steroids is discussed in the online chapter 'Natural products'.

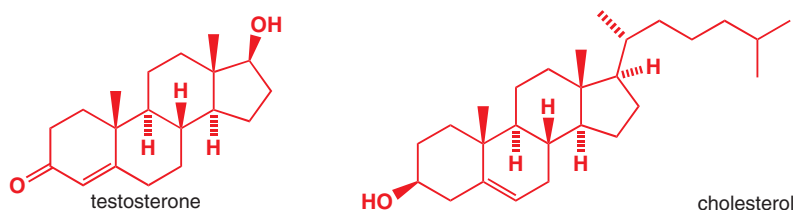

The elucidation of the ways in which organic chemistry underpins life, along with the use of organic chemistry to construct in the laboratory the molecules used by nature, has been one of the greatest scientific success stories of recent decades. In this chapter we have revealed but a glimpse of the immense complexity of the world of biological organic chemistry; you will find an extended version of this discussion in the three chapters on the web, and a book on biochemistry will fill in more detail. The beautiful molecular structures of nature and the reactions used to make them have provided an example for organic chemists to follow—sometimes at a distance, but always in hot pursuit. The next and final chapter of this book tells a few stories of how such scientific inspiration is the key to the future of chemistry, not only for its own sake, but also for the sake of the millions of people whose lives have been improved or even saved by the ingenuity of chemists.

Further reading

P. A. Frey and A. D. Hegeman, *Enzymatic Reaction Mechanisms*, Oxford University Press, Oxford, 2007. A more basic treatment is in two Oxford Primers by J. Mann, *Chemical Aspects of Biosynthesis*, OUP, 1994 and by T. Bugg, *Introduction to Enzyme and Coenzyme Chemistry*, OUP, Oxford, 2004. A more comprehensive treatment is in J. E. McMurry and T. P. Begley, *The Organic Chemistry of Biological Pathways*, Roberts, 2005. For an introduction to biosynthesis, see F. J. Leeper and J. C. Vederas, *Biosynthesis: Polyketides and Vitamins*, Springer, 2000.

Three full chapters from the first edition expand this chapter and are available for download from the website: The chemistry of life, Mechanisms in biological chemistry, and Natural products.

Check your understanding



To check that you have mastered the concepts presented in this chapter, attempt the problems that are available in the book's Online Resource Centre at <http://www.oxfordtextbooks.co.uk/orc/clayden2e/>

Connections

➔ Building on

- The rest of the book [ch1–ch42](#)

Arriving at

- How organic chemistry produced an AIDS treatment in collaboration with biologists
- How organic chemists are in the front line of the fight against epidemics
- Where organic chemistry might be going next

➔ Looking forward to

- Life as a chemist

Science advances through interaction between disciplines

Just as the stonemasons who worked out how to build the great gothic cathedrals of the middle ages transformed architecture, the organic chemists who build molecules on a scale 10^{10} times smaller have transformed our expectations of everyday life. When we are ill, we expect there to be a drug to treat us; when we need to mend something, we expect there to be a sealant, glue, or coating to solve our problem. We expect paints, plastics, and clothes of any colour. If an engineer needs a material with certain properties of strength and flexibility, she expects organic chemists to be able to make it. If a biologist needs a molecule to inhibit an enzyme selectively, he expects organic chemists to be able to make it. In the future the same will be true of plastics that conduct electricity or emit light, or drugs tailored to your own individual genetic makeup. The creative art of organic chemistry has transformed our ability to understand and manipulate the world on a molecular scale and above, and it has been able to do this because of the collaboration between those who can make molecules and those who can use them—between chemists, physicists, engineers, and materials scientists.

The most dramatic scientific developments involving organic chemistry at the beginning of the 21st century are new methods in medicine from collaborations between organic chemists and biologists. Progress is slow but secure across a whole range of diseases long thought impregnable to treatment. That media favourite, ‘the cure for cancer’, is already not just ‘a cure’ but hundreds of successful cures for the hundreds of diseases collectively called ‘cancer’. At the turn of the twenty-first century, it was the case that there was *some* chance of survival for all known types of childhood cancer. The drug Glivec, launched in 2001, now essentially cures 75% of patients with chronic myeloid leukemia. 5-Fluorouracil is a well-established chemotherapy drug that slows down the progression of cancer. But in conjunction with Avastin, which prevents tumours developing their own blood supply, it is much more effective against certain colon cancers. Avastin in conjunction with Taxol (launched in 1992) increases Taxol’s effectiveness against breast cancer. Avastin was launched in 2004, and is expected to be the world’s biggest selling drug by 2014.

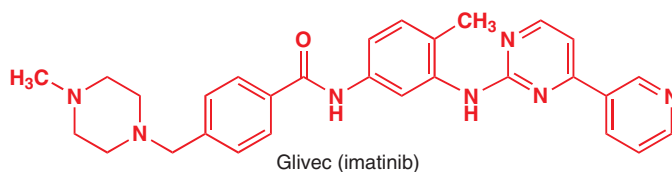

Glivec (imatinib)

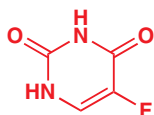

5-fluorouracil

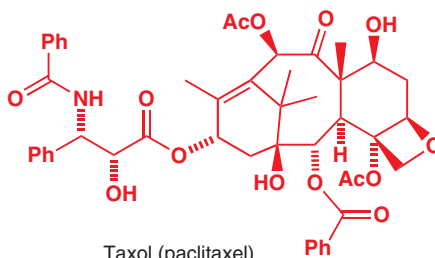

Taxol (paclitaxel)

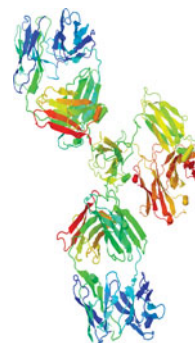

Avastin (bevacizumab)

5-Fluorouracil could hardly be simpler: it interferes with cell proliferation by modifying natural uracil to incorporate a stubbornly unreactive fluorine. Taxol is a rare metabolite of the Pacific yew tree that can be made at great expense in the laboratory, and for a while was produced by chemical modification of a common precursor that can be harvested. It is now made by fermentation using cultured yew tree cells. Avastin is at the other end of the scale of complexity: it is an antibody against a protein involved in blood vessel growth, and we have represented only its gross structure: a detailed structural diagram would be huge. The antibody was induced in mice, its protein sequence was determined and then modified using the techniques of molecular biology which grew out of organic chemistry in the 1960s and 1970s, and it is produced by expression of the modified gene in bacteria. Which of this is chemistry, which is biology, and which is medicine? There is no point deciding.

Chemistry vs viruses

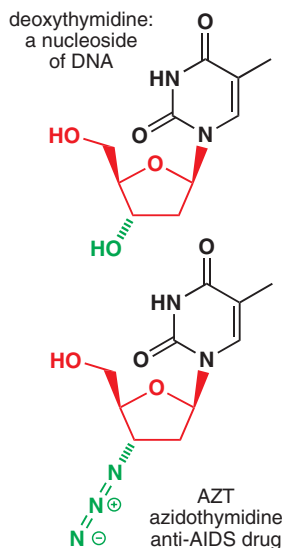

We are going to spend most of this chapter discussing two medical developments, both battles pitting chemists against viruses: one is partly won, and one has fortunately not yet been fought. Like cancer, viruses are an insidious menace because they subvert the body's own biochemical machinery to cause harm, but since the middle of the last century, with antibiotics being used to treat bacterial infections, the threat from infectious disease seemed to be in retreat. So when AIDS (acquired immune deficiency syndrome) first came into the news in the 1980s, medics struggled to explain the mysterious deaths from normally harmless diseases after the patient's immune system had been weakened and eventually destroyed. But the cause was soon identified by biologists as a new virus, HIV (human immunodeficiency virus), and antiviral drugs, notably AZT, were used with some success. These drugs imitate natural nucleosides (AZT imitates deoxythymidine) and inhibit the virus from copying its RNA into DNA inside human cells by inhibiting the reverse transcriptase enzyme.

As is often the problem with antiviral (and anticancer) chemotherapy, the drugs also inhibit the normal function of essential human enzymes and are very toxic. But biologists discovered an alternative point of attack. An enzyme unique to the virus cuts up long proteins into small pieces essential for the formation of new HIV particles. If this enzyme could be inhibited, no new viruses would be formed and neither should the inhibitor interfere with human biochemistry.

Blocking HIV protease inhibitors means mimicking the proteins they slice up, but real peptides are usually poor drugs because humans have their own peptidases which quickly cut up ingested proteins by hydrolysis of the amide link. The solution is to make a drug which looks like the peptide but can't be hydrolysed because the C-N bond of the peptide has been replaced by a C-C bond (green parts of the structures below).

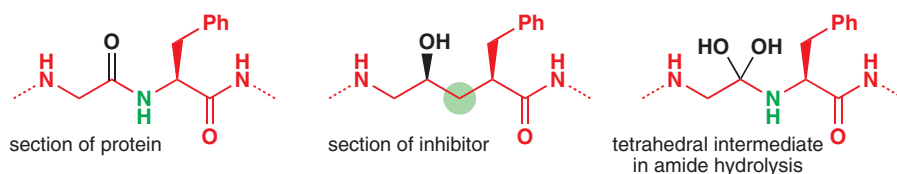

This stops the drug being hydrolysed, but the drug also has to stop the viral protein being hydrolysed. To get it to do this, medicinal chemists used another trick. Enzymes work by binding the transition state for a reaction, and while of course the chemists couldn't make a transition state (it is by its nature unstable) they made a molecule with a sufficient resemblance to the tetrahedral intermediate for amide hydrolysis (black parts of molecules above) that the protease is tricked into taking it into its active site, where it blocks the protease's function.

The knowledge that only one of the two hydroxyl groups of the tetrahedral intermediate was needed was acquired from an X-ray crystal structure showing how the enzyme binds the substrate. Other structural information was also used to design the drugs: for example, HIV protease is a dimeric enzyme and experience with this class of protease suggested correctly that more or less symmetrically placed aromatic or heterocyclic rings would greatly improve binding. Two successful protease inhibitors are shown below, with the active site binding portion in brown and the heterocyclic binding portions in green.

HIV protease inhibitors

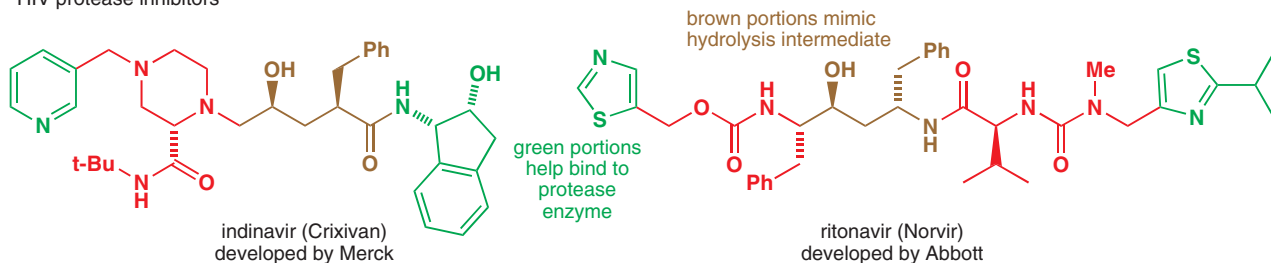

These developments looked so promising that Merck set up a new research station at West Point, Pennsylvania, dedicated to this work. The biochemist in charge, Dr Irving Sigal, was one of the victims of the Lockerbie bombing in 1988 but his work lived on in Crixivan (indinavir). In combination with the antiviral agents AZT and 3TC (Lamivudine), shown with the nucleoside it imitates, indinavir revolutionized the treatment of HIV in the 1990s. Before the use of 'combination therapy', as it is known, most of those with HIV were dead within 2 years. Now no-one knows how long they will survive as the combination of the three drugs reduces the amount of virus to undetectably low levels.

The AIDS crisis led to cooperation between the pharmaceutical companies unparalleled since the development of penicillin during the Second World War. Fifteen companies set up an AIDS drug development collaboration programme, with government agencies and universities contributing as well. The battle is not yet won, of course, and the HIV protease inhibitors have now been joined by a new generation of non-nucleoside reverse transcriptase inhibitors, such as the DuPont–Merck compound efavirenz. These commonly join the other drugs of the types mentioned above as part of the drug regimes known as 'highly active antiretroviral therapy' or HAART. The mixture of drugs used to combat HIV changes as discoveries are made, but life-saving combination therapy of this sort would not be possible without the sort of collaboration between organic chemists, biochemists, virologists, X-ray crystallographers, and molecular modellers that went into discovering and making indinavir.

After indinavir was found to be effective, the job of the chemists was an exceptionally urgent task. They knew that a kilo of compound was needed to keep each patient alive and well for a year (newer HIV protease inhibitors require much smaller doses). Merck built a dedicated plant for the manufacture of Crixivan at Elkton, Virginia, in 1995. Within a year, production was running at full blast and there are millions of people alive today as a result.

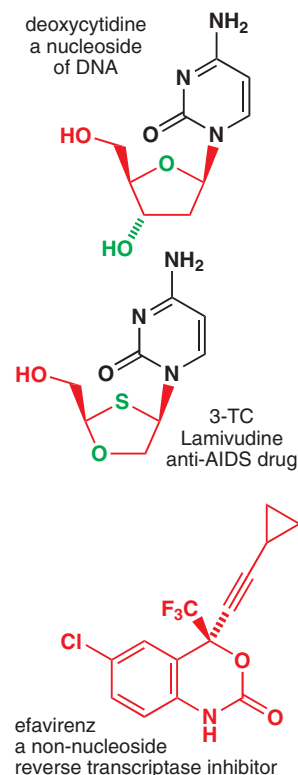

The synthesis of indinavir

Indinavir was a formidable synthetic target. It was probably the most complex compound ever made in quantity by organic synthesis and the 3 g per day dose meant that huge quantities were required. The complexity largely arises from the stereochemistry. As with all chiral new drugs, it is a single enantiomer: there are five stereogenic centres, marked with coloured circles on the diagram below, and their disposition means that three separate pieces of asymmetric synthesis must be devised.

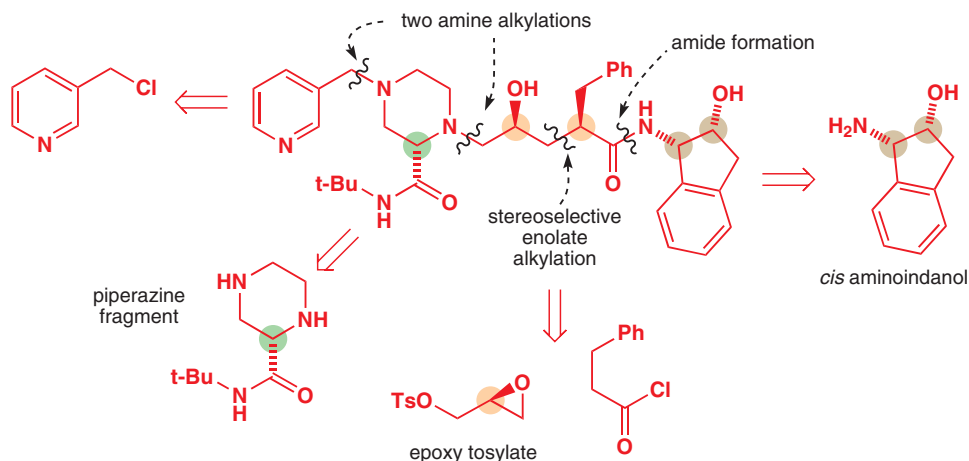

The challenge with indinavir, as with any drug, is to make it efficiently: high yields, few steps. We can start by looking at some likely disconnections, summarized in the scheme above. They are all disconnections of the sorts you met in Chapter 28, and they all correspond to reliable reactions. These disconnections split the molecule into five manageable fragments, three of which contain stereogenic centres and will have to be made as single enantiomers. One of the orange stereogenic centres would have to be made in the enolate alkylation step, so this step will need to be diastereoselective.

Let's take the three chiral fragments in turn. First, the simplest one: the central epoxide. The reagent we need here will carry a leaving group, such as a tosylate, to allow it to alkylate the piperazine to the left, and it can easily be made from an epoxyalcohol. This gives a very good way of making this compound as a single enantiomer—a Sharpless asymmetric epoxidation of allyl alcohol.

➔ Sharpless asymmetric epoxidation was discussed in Chapter 41, p. 1120.

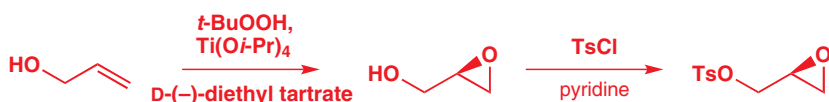

Next, the piperazine fragment. This has two nucleophilic nitrogen atoms and they will both need protecting with different protecting groups to allow them to be revealed one at a time. It will also need to be made as a single enantiomer. In an early route to indinavir, this was done by resolution, but enantioselective hydrogenation provides a better alternative. Starting from a pyrazine derivative, a normal hydrogenation over palladium on charcoal could be stopped at the tetrahydropyrazine stage. The two nitrogens in this compound have different reactivities because one is conjugated with the amide while one is not (the curly arrows in the margin show this). The more nucleophilic nitrogen—the one *not* conjugated with the amide—was protected with benzyl chloroformate to give the Cbz derivative. Now the less reactive nitrogen can be protected with a Boc group, using DMAP as a base.

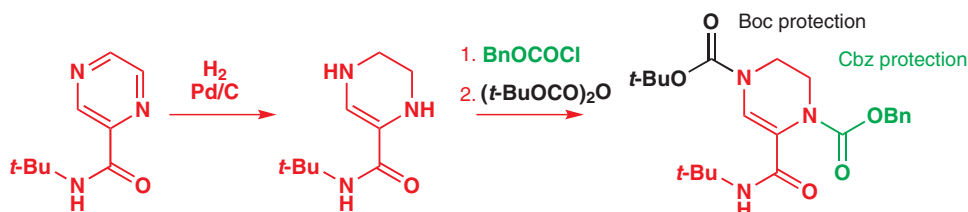
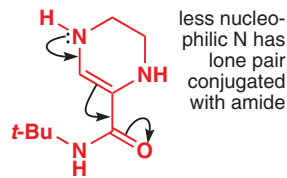

You met asymmetric hydrogenation using BINAP complexes of rhodium in Chapter 41 as a method for the synthesis of amino acids. The substrate and catalyst are slightly different here, but the principle is the same: the chiral ligand, BINAP, directs addition of hydrogen across one of the enantiotopic faces of the double bond with almost perfect enantioselectivity and in very high yield. A further hydrogenation step allowed selective removal of the Cbz group, preparing one of the two nitrogen atoms for alkylation.

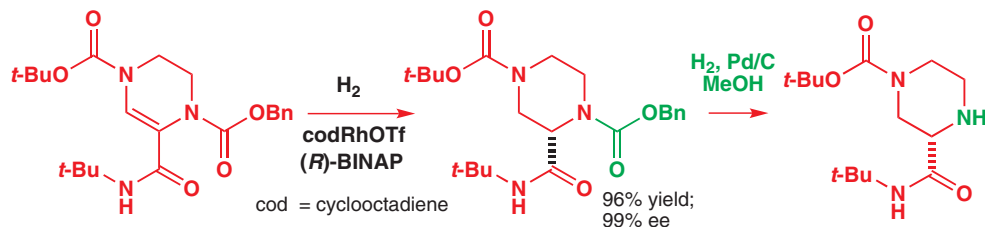

The remaining chiral fragment is a compound whose synthesis was discussed in Chapter 39. It can be made on a reasonably large scale (600 kg) in one reaction vessel, starting from indene. First, the double bond is epoxidized, not with *m*-CPBA but with the cheaper hydrogen peroxide in an acetonitrile/methanol mixture, which generates a peroxyimidic acid (the C=N analogue of a peracid) as the active oxidant. Acid-catalysed opening of the epoxide leads to a cation, which takes part in a reversible Ritter reaction with the acetonitrile solvent, leading to a single diastereoisomer of a heterocyclic intermediate, which is hydrolysed to the amino-alcohol.

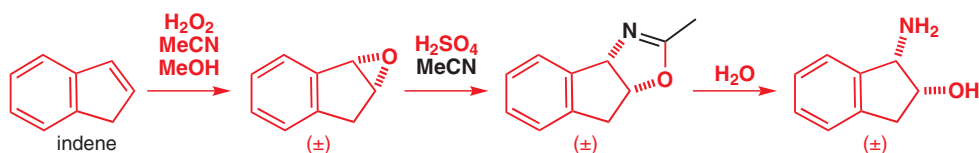

The product is, of course, racemic but, as it is an amine, resolution with an acid should be straightforward. Crystallization of its tartrate salt, for example, leads to the required single enantiomer in 99.9% ee. With such cheap starting materials, resolution is just about acceptable, even though it wastes half the material. It would be better to oxidize the indene enantioselectively, and the solution here, as you saw in Chapter 41, is to use a Jacobsen epoxidation, which gives the epoxide in 79% yield and 84% ee.

Jacobsen asymmetric epoxidation of indene

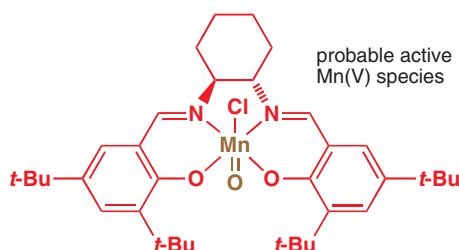

Only one, orange, stereogenic centre remains, and its stereoselective formation turns out to be the most remarkable reaction of the whole synthesis. The centre is the one created in the planned enolate alkylation step, shown in the margin. The obvious way to make this centre is to make Y a chiral auxiliary, which would direct a diastereoselective alkylation before being removed and replaced with the amino-alcohol portion.

But the Merck chemists noticed that amino alcohol itself, certainly once protected, has a remarkable similarity to Evans' oxazolidinone auxiliaries anyway, and it turns out that this amino alcohol will function very successfully as a chiral auxiliary, which does not need to be removed, avoiding waste and saving steps! The amino alcohol was acylated with the acyl chloride, and the amide was protected as the nitrogen analogue of an acetonide by treating with 2-methoxypropene (the methyl enol ether of acetone) and an acid catalyst. The enolate

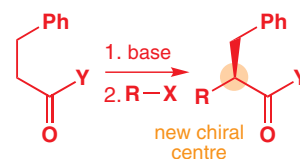

■ Evans auxiliary-directed alkylation is described in Chapter 41, p. 1109.

➔ Turn to pp. 1066–1067 for details of the mechanisms in this reaction sequence and an explanation for its *cis* diastereoselectivity.

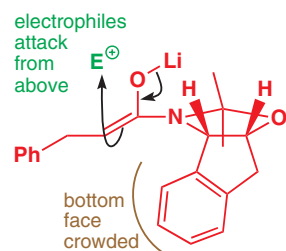
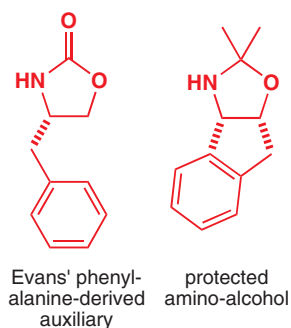

of this amide reacts highly diastereoselectively with alkylating agents, including, for example, allyl bromide.

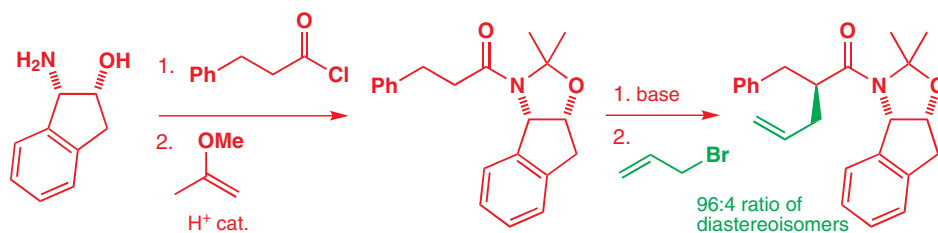

The reason for the stereoselectivity is not altogether clear, but we would expect the bulky nitrogen substituents to favour formation of the *cis* enolate. With the amino-alcohol portion arranged as shown, the top face is more open to attack by electrophiles. The enolate also reacts diastereoselectively with the epoxy-tosylate prepared earlier. The epoxide, being more electrophilic than the tosylate, is opened first, giving an alkoxide, which closes again to give a new epoxide. The absolute configuration at the stereogenic centre within the epoxide was, of course, already fixed (by the earlier enantioselective Sharpless epoxidation).

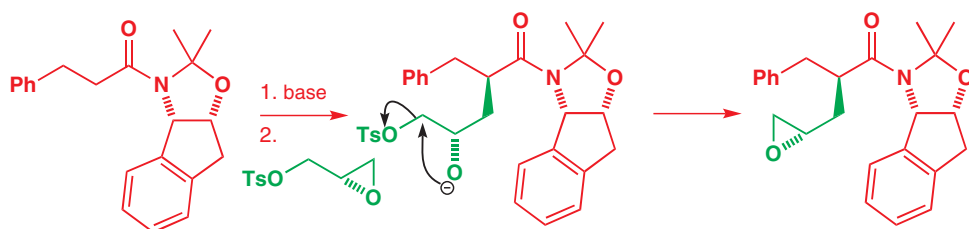

Three of the five fragments have now been assembled, and only the two amine alkylations remain. The first alkylation makes use of the epoxide to introduce the required 1,2-amino-alcohol functionality. The protected enantiomerically pure piperazine reacted with the epoxide, and the product was treated with acid to deprotect both the second piperazine nitrogen and the *gem*-dimethyl group left over from the earlier chiral auxiliary step. The newly liberated secondary amine was alkylated with the reactive electrophile 3-chloromethyl pyridine, and the final product was crystallized as its sulfate salt.

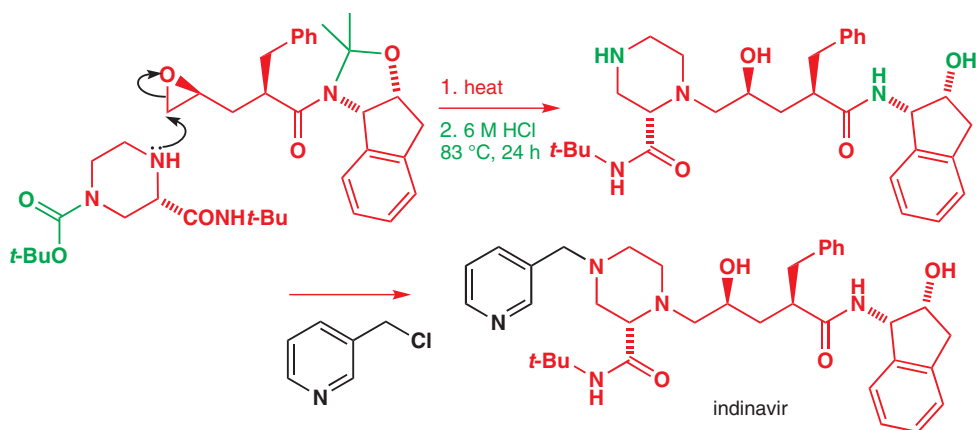

The synthesis of oseltamivir

Our second example of the use of chemistry to save lives is more recent. Several times in the last century major epidemics of influenza have caused deaths, sometimes running into millions. Virologists tell us that a global influenza pandemic is a constant danger, and a number of times in recent years highly aggressive forms of the flu virus have found their way from other animals (often poultry or pigs) into the human population. Fortunately, at the time of writing, none has caused more than a few thousand deaths, the most serious being the swine flu pandemic of 2009–10, which claimed the lives of 18,000 people, many of them in Mexico.

To put this in context, the 1918 flu epidemic, which was caused by the same strain (H1N1) of virus, killed 50–100 million, 3% of the world's population at the time.

Vaccination can prevent the spread of flu, but influenza vaccines are slow to produce and difficult to generalize because of the rate of mutation of the virus. So the first line of defence is a class of antiviral compounds known as neuraminidase inhibitors. Neuraminidase is an enzyme used by the flu virus that targets human cell-surface carbohydrates containing neuraminic acids and allows the virus to release itself from the host cell. Inhibition of this enzyme prevents the new virus particles from spreading.

The drug oseltamivir (Tamiflu), developed by the companies Gilead and Roche, is a neuraminidase inhibitor. Like the HIV proteases described above, it has enough structural similarity with the enzyme's substrate to bind to the enzyme, but once bound it blocks the enzyme's activity. No-one knows how much oseltamivir might be needed if ever a flu pandemic took hold, but clearly the safest course of action is to stockpile the compound in readiness for such an event. The first manufacturing route to oseltamivir made use of the natural product (–)-quinic acid as a naturally derived starting material. Quinic acid is found in coffee beans, but is not available in sufficient quantities for widespread use.

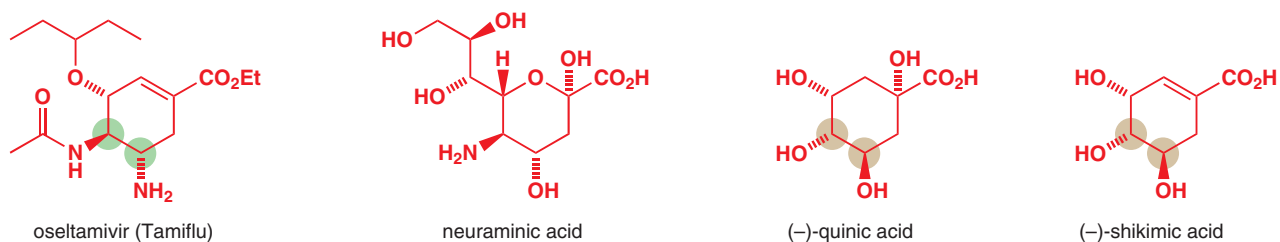

A preferable starting material, and the one that for several years now has been used as the source of the commercial drug, is (–)-shikimic acid. Shikimic acid is the plant metabolite that provides the biochemical precursor to the aromatic amino acids such as phenylalanine, tyrosine, and tryptophan. It is abundant in the spice star anise, grown in China, which can yield 3–7% of shikimic acid.

The similarity of both quinic and shikimic acid with the target drug is obvious; what is perhaps remarkable is just how many steps it takes to get from one to the other. The majority of these steps are concerned with the introduction of the two amino substituents with inversion of stereochemistry at the coloured stereogenic centres. Chiral pool syntheses often have to take long convoluted routes to correct relatively minor 'errors' of structure and stereochemistry. Here this is simply the price we have to pay for a starting material that has the valuable qualities of enantiomeric purity and the right hydrocarbon skeleton.

Oseltamivir is an ethyl ester, and esterification comes first, followed by selective protection of the *cis* diol (the *cis*-6,5-ring system is more stable than the alternative *trans*) and conversion of the remaining hydroxyl group to a methanesulfonate leaving group.

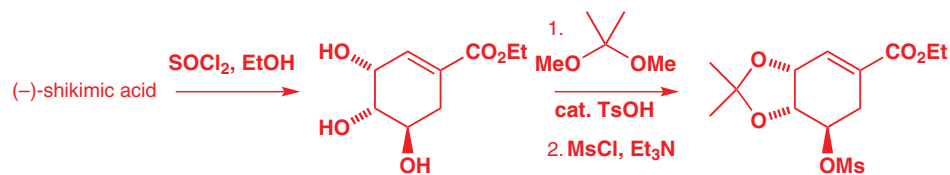

The dioxolane, which is crystalline and easily purified, is then exchanged for the acetal derived from pentan-3-one, ready for a reduction to the rather challenging hindered ether (direct alkylation with a hindered alkyl halide would struggle to avoid competing E2 elimination).

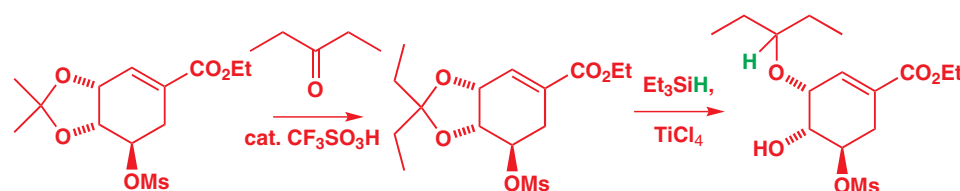

➔ You met shikimic acid in Chapter 42, p. 1154.

The reduction of the acetal is catalysed by a Lewis acid and goes via an oxonium ion, which collects hydride from the mild reducing agent triethylsilane. Silanes react only with cationic electrophiles. The oxonium ion could open either way, but this one is less hindered and possibly allows the titanium some favourable interaction with the mesylate substituent.

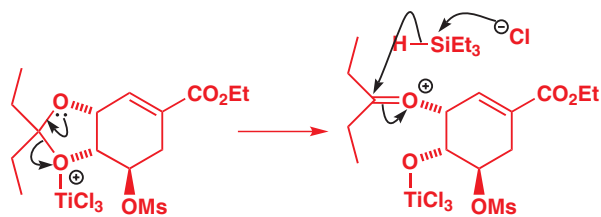

As often in the synthesis of 1,2-difunctionalized compounds, an epoxide is a key intermediate, and in this case an epoxide forms by closure of the newly revealed hydroxyl group onto the mesylate leaving group in base.

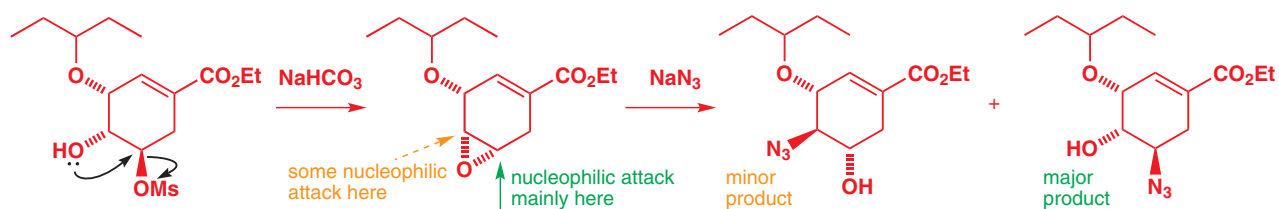

Two amino groups now need introducing with rather specific stereoselectivity, and the next key intermediate is an aziridine, the nitrogen analogue of an epoxide. Azide is not completely regioselective in opening this epoxide, but both regioisomers are formed with complete inversion of configuration.

Azides may be reduced to amines with triphenylphosphine in what is known as the Staudinger reaction. The probable mechanism involves attack of triphenylphosphine on the azide and formation of a phosphinimine via a four-membered intermediate—notice the similarity with the Wittig reaction!

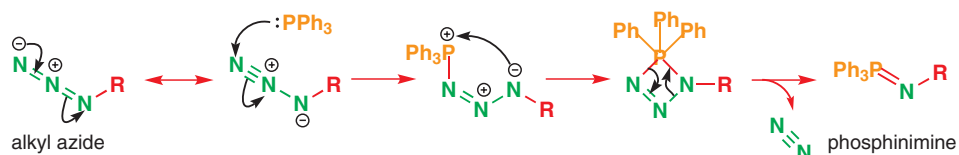

The phosphinimine, in the presence of water, hydrolyses to an amine—overall a molecule of nitrogen is lost and a molecule of water is ‘dismembered’ and shared between the reagents.

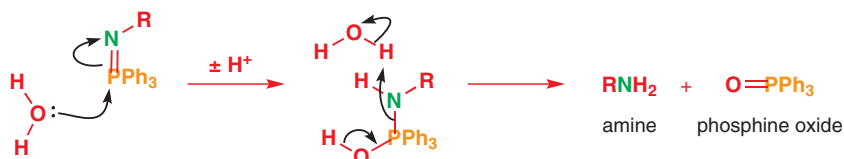

When the azide has an adjacent hydroxyl group, something more interesting happens: the phosphinimine intermediate in the reaction is intercepted by the alcohol, which turns itself into a leaving group. Extrusion of the stable phosphine oxide gives an aziridine, with inversion of stereochemistry as the nitrogen displaces the leaving group. Here is the result with the oseltamivir synthesis:

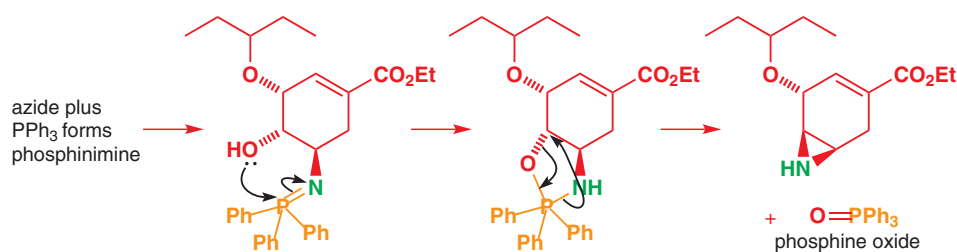

In this case, it doesn't matter which azide you start with: triphenylphosphine converts them both to the same aziridine. Like epoxides, aziridines open with nucleophiles under acid catalysis, and azide is used again to put in the second amino group by attack at the less hindered end of the aziridine. To get the right amino group acetylated, the amide is formed before the azide is reduced, this time with tributylphosphine. The drug is formulated as a stable phosphate salt by treatment with phosphoric acid.

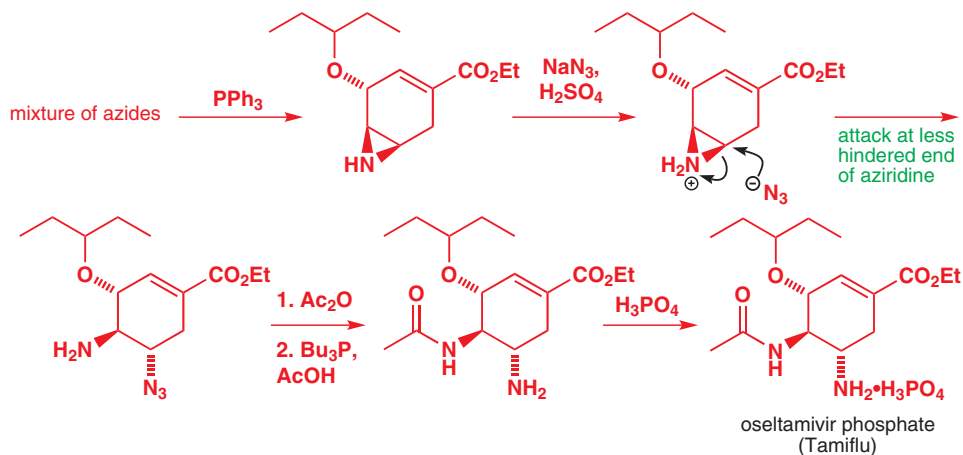

This is not, by any stretch of the imagination, an efficient synthesis, not least because there are two uses of potentially explosive azides, and large amounts of waste are produced from the phosphine steps. However, for several years it was the best route available, and Roche operated it as a manufacturing process on a tonne scale. In the last few years, however, several modifications have been published, and among the most efficient of the alternatives was one devised in 2006 by the Nobel prize-winning chemist E. J. Corey. Corey's route built on the fact that oseltamivir is a cyclohexene, and as you saw in Chapter 34 cyclohexenes are made efficiently by a Diels–Alder reaction.

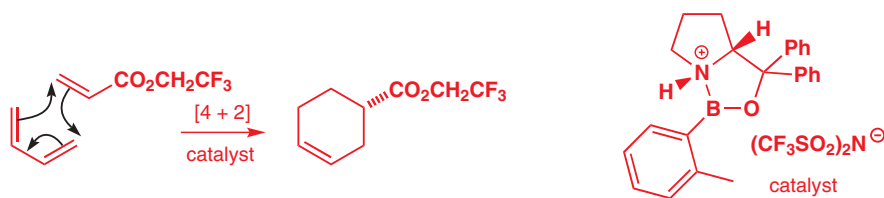

Corey's research group combined the two very cheap reagents butadiene and trifluoroethyl acrylate in the first step of their alternative synthesis: the cycloadduct already has the scaffold of oseltamivir. Not starting with a natural product has its advantages and disadvantages: no longer is supply limited by the world production of coffee beans or star anise, and no longer is there a need to make do with a compound of the wrong relative stereochemistry, wasting valuable resources inverting stereogenic centres in the course of the synthesis. However, as you know from Chapter 41, making an enantiomerically pure compound like oseltamivir *must* involve a natural compound somewhere along the line. Diels–Alder reactions are catalysed by

■ We illustrated a chiral auxiliary approach to asymmetric Diels–Alder reactions in Chapter 41, but it was clearly better to avoid the extra steps and recycling involved in large-scale synthesis with an auxiliary.

Lewis acids, and so by using a catalytic amount of the chiral Lewis acid (whose structure is evidently based on that of the CBS catalyst) it was possible to induce the cycloaddition to proceed enantioselectively.

The product of the Diels–Alder reaction has the ester substituent in place, and the stereochemistry at the single chiral centre has to be used to control stereochemistry at new centres in the molecule. We discussed strategies for doing this in Chapters 32 and 33, and in this case the use of a tethered nucleophile (p. 847) allowed the first amino group to be introduced with the correct stereochemistry. Conversion of the ester to an amide followed by treatment with iodine induced in the nitrogen equivalent of an iodolactonization (an iodolactamization), placing the nitrogen *syn* to the ester and the iodide *trans*.

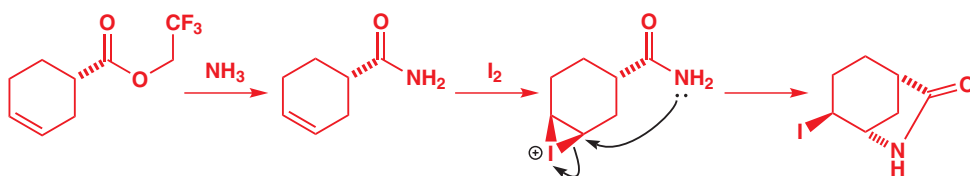

The next key intermediate is a diene, which is reached by an overall oxidation of the iodide: protection of nitrogen and elimination of the iodide gives the only possible alkene. Radical bromination with NBS followed by treatment with base in ethanol both hydrolyses the lactam and eliminates bromide to give the diene.

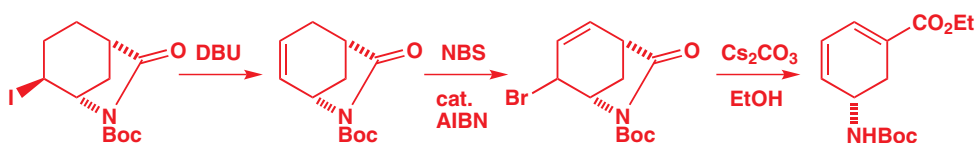

Now for the second nitrogen substituent. Bromination of the less electron deficient end of the diene with *N*-bromoacetamide in the presence of SnBr_4 leads to an intermediate bromonium ion which is opened by the acetamide by-product at the more reactive end adjacent to the alkene, giving a *trans* diaxial product.

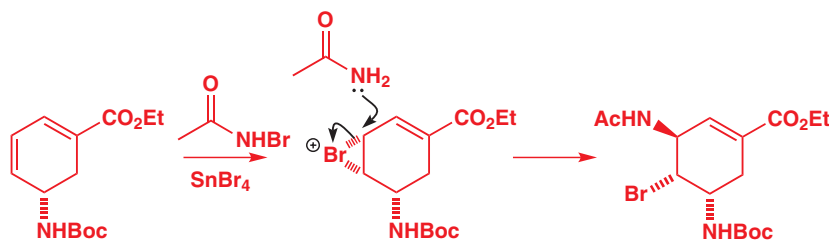

Treatment with base leads to cyclization to an aziridine, and this time the ether is introduced by a copper-catalysed ring opening of the aziridine with 3-pentanol. Treatment with phosphoric acid removes the Boc protecting group and converts the product to oseltamivir phosphate.

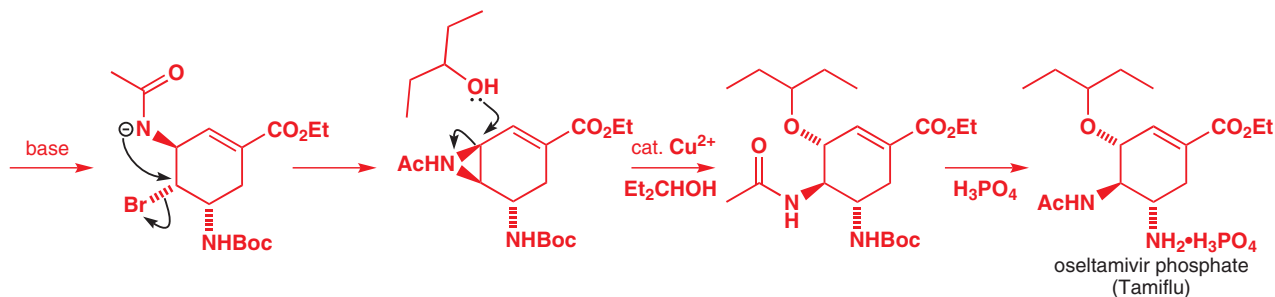

Overall, Corey's route uses just 12 steps, and gives a yield of 30%—about double that of the route from shikimic acid. But much work remains to be done: several of the steps require

conditions or solvents (such as carbon tetrachloride) that are unsuitable for industrial use. Advances are still being made, with even shorter routes being reported since 2006. In some ways it would be best if this vital work were never made necessary, but across the world chemists are working in similar ways to relieve suffering, and potential suffering, caused by illness and disease.

The future of organic chemistry

Not all organic chemists can be involved in such exciting projects as the launching of a life-saving antiviral drug. Some most certainly have to be: resistant bacteria are fast catching up with our current range of antibiotics, and it is teams of organic chemists, in conjunction with biologists, who will be able to erect the next line of defence against these infections. But the chemistry used in such frontline projects is often the product of work by chemists in other institutions who had no idea that it would eventually be used to make a vital drug.

Take the millions of lives saved by the synthesis of indinavir, for example. This drug would not have been possible had not the Sharpless and Jacobsen asymmetric epoxidations, the catalytic asymmetric reduction, and the stereoselective enolate alkylation, along with many of the methods tried but not used in the final synthesis, been invented and developed by organic chemists in academic and industrial research laboratories. Some of the more famous names involved, like Sharpless, Jacobsen, and Noyori, invented new methods, while others modified and optimized those methods, and still others applied the methods to new types of molecules. Yet all built on the work of other chemists.

We can delve deeper into one of the steps in the indinavir synthesis. In 1980 Giovanni Casiraghi, a rather less famous chemist from the University of Parma, published a paper in the *Journal of the Chemical Society* about selective reactions between phenols and formaldehyde. He and his colleagues made the modest discovery that controlled reactions to give salicylaldehydes could be achieved in toluene with SnCl_4 as catalyst. The reaction is regioselective for the *ortho* isomer and the paper described the rather precise conditions needed to get a good yield.

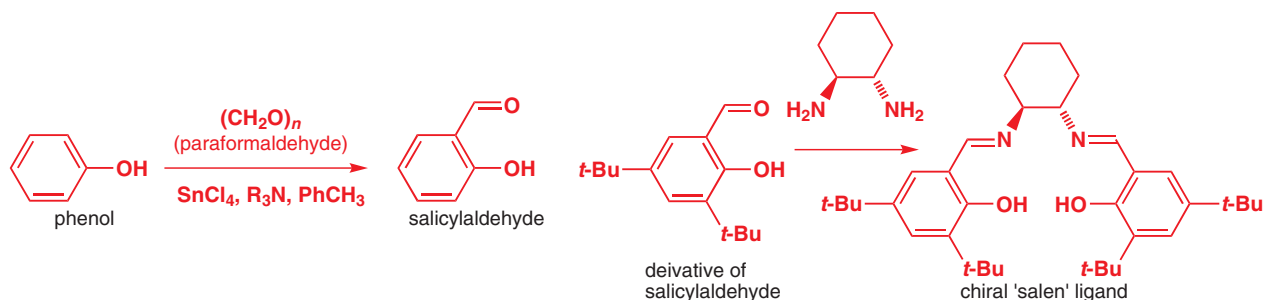

The reaction was also successful for substituted salicylaldehydes. When Jacobsen came to develop his asymmetric epoxidation, he chose salens as his catalysts, partly because they could be made so easily from salicylaldehydes.

Jacobsen epoxidation turned out to be the best large-scale method for preparing the *cis*-aminoindanol for the synthesis of indinavir. This process is very much the cornerstone of the whole synthesis. It cannot have entered Casiraghi's wildest dreams that his work might someday be useful in a matter of life and death. Neither did his four co-workers nor Jacobsen's more numerous co-workers see clearly the future applications of their work. By its very nature it is impossible to predict the outcome or the applications of research. But one thing is certain: good research and exciting discoveries come from a thorough understanding of the fundamentals of organic chemistry.

When Jacobsen's epoxidation was fully described in 1998–99, the Casiraghi method was abandoned in favour of an even older method discovered in the 1930s by Duff. The remarkable Duff reaction uses hexamethylenetetramine, the oligomer of formaldehyde and ammonia, to provide the extra carbon atom. The now otherwise unknown Duff worked at Birmingham Technical College. Later in 1972, a William E. Smith, working in the GEC chemical laboratories

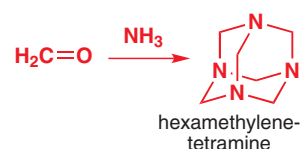

at Schenectady, New York, found how to make the Duff reaction more general and better yielding by using $\text{CF}_3\text{CO}_2\text{H}$ as catalyst. Even so, this method gives a lower yield than the Casiraghi method but it uses less toxic reagents (in particular it avoids stoichiometric tin) and is more suitable for large-scale work. When Duff was inventing his reaction or Smith was modifying the conditions, asymmetric synthesis was not even a gleam in anyone's eyes. It is impossible even for the inventor to predict whether a discovery is important or not.

Where is organic chemistry going next? As we write this chapter, advances are being made in reactions which would have seemed outlandish even just ten years ago. Work published in the years since 2005 has shown, for example, that many reactions of cations can be made to form single enantiomers of products even if they take place just in the vicinity of a chiral anion. Reactions such as the one below, from 2008, promise to revolutionize, yet again, some of the ways in which chemists make chiral compounds.

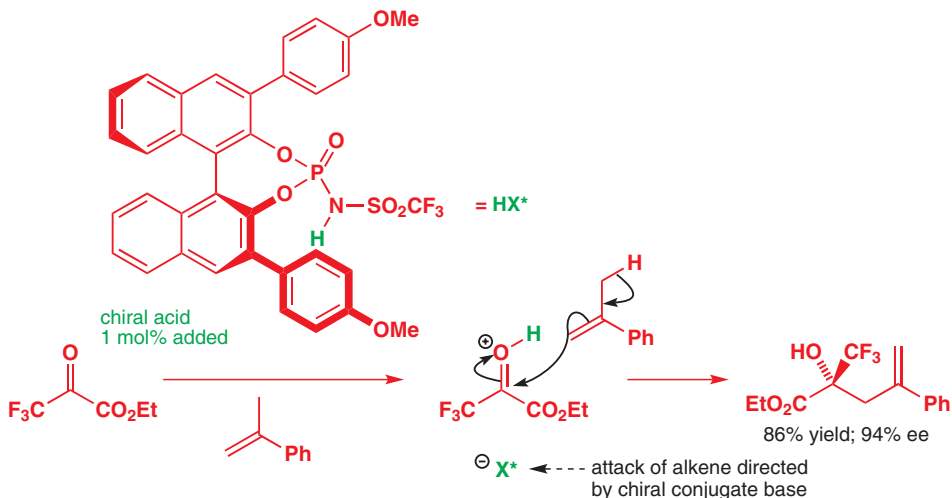

Interactive mechanism for catalytic enantioselective additions controlled by chiral anions

Finding drugs is a difficult job, and the number of new drugs launched each year is dropping as it becomes harder and more expensive to advance beyond existing treatments and as demands for more stringent safety rightly increase. But new drugs are made because...they can be made! What about all those classes of molecules which have never been made, simply because they have never been needed? Among them may well be molecules that will have all the specific attributes we want a potential drug to exhibit. Techniques known as diversity orientated synthesis are now addressing this idea—how to make and study great families of fundamentally different but potentially revolutionary molecules simply and efficiently. It's too early to tell, but the hope is that these techniques will provide breakthroughs in the fight against disease by finding completely new ways to attack their causes.

Nature is a superb synthetic chemist, and organic chemists have spent the last century exploring efficient ways of building molecular structures more efficiently than nature. Nature builds molecules a certain way because there is no alternative—molecules can be biosynthesized only if the enzymes to make them exist; enzymes are only made from the same 20 amino acids; amino acids are built into proteins by the same ribosome. The ribosome is the most complex and beautiful molecular structure in the known universe, but it can make only proteins. Chemists, with the periodic table, a supply of raw materials, a laboratory, and their ingenuity can make anything. Sometimes chemists use Nature's enzymes to do a job, or even force them to evolve to do a job better. By cloning useful enzymes in bacteria and forcing them to mutate, high-speed evolution can be induced, and enzymes can be created which do a job better, faster, or at a different temperature from their original 'wild type' ancestors.

More often chemists use reactions nature can never use—Rh, Ru, Pd, or phosphine ligands for that matter have never been exploited by any known biological process. What molecules chemists will make next, and how they make them, may determine the well-being of huge numbers of people in the future, but we may well not know it until then.

That future is yours as you continue your studies in organic chemistry beyond the scope of this book, and if you do you will want to read about modern work in more specialized areas. Your university library should have a selection of books on related topics we have only touched on, such as orbitals and chemical reactions, NMR spectroscopy, molecular modelling physical organic chemistry, photochemistry, enzyme mechanisms, biosynthesis, organometallic chemistry, asymmetric synthesis, supramolecular chemistry, and polymer and materials chemistry. This book will equip you with enough fundamental organic chemistry to explore these topics with understanding and enjoyment, and, perhaps, to discover what you want to do for the rest of your life. All of the chemists mentioned in this chapter and throughout the book began their careers as students of chemistry at universities somewhere in the world. You have the good fortune to study chemistry at a time when more is understood about the subject than ever before, when information is easier to retrieve than ever before, and when organic chemistry is more interrelated with other disciplines than ever before.

Further reading

For an informative overview of the most important drug molecules of the 20th century, see *Chemical and Engineering News*, 2005, Jun 20 edition.

Indinavir synthesis: I. W. Davies and P. J. Reider, *Chemistry and Industry (London)*, 1996, 412–15. G. Casiraghi, G. Casnati, G. Puglia, and G. Terenghi, *J. Chem. Soc., Perkin Trans. 1*, 1980, 1862–65.

Oseltamivir synthesis from shikimic acid: M. Federspiel and group, *Organic Process Research & Development* 1999, 3, 266–274. Corey

oseltamivir synthesis: Y-Y. Yeung, S. Hong, and E. J. Corey *J. Am. Chem. Soc.*, 2006, 128, 6310–631.

Chiral Brønsted acids: M. Rueping, B. J. Nachtsheim, W. Ieawsuwan, and I. Atodiresei, *Angew. Chem. Int. Ed.*, 2011, 50, 6706.

Diversity-orientated synthesis: D. Morton, S. Leach, C. Cordier, S. Warriner, and A. Nelson, *Angew. Chem. Int. Ed.*, 2009, 48, 104.

Check your understanding



To check that you have mastered the concepts presented in this chapter, attempt the problems that are available in the book's Online Resource Centre at <http://www.oxfordtextbooks.co.uk/orc/clayden2e/>

Figure acknowledgements

- Page 4 Photo of a pair of skunks © Tom Friedel, licensed under Creative Commons: <http://creativecommons.org/licenses/by/3.0/deed.en>
- Page 5 Photo of a gypsy moth © Olaf Leillinger, licensed under Creative Commons: <http://creativecommons.org/licenses/by-sa/2.5/deed.en>
- Page 6 Photo of an oil refinery © Peter Facey, licensed under Creative Commons: <http://creativecommons.org/licenses/by-sa/2.0/deed.en>
- Page 6 Photo of sugarcane © Rufino Uribe, licensed under Creative Commons: <http://creativecommons.org/licenses/by-sa/2.0/deed.en>
- Page 18 Mona Lisa, Bridgeman Art Library. Cartoon by Jeremy Dennis
- Page 25 Photo of a Geodesic dome © iStock/Daniel Loiselle
- Page 45 Photo of an X-ray diffractometer courtesy of Edward E Mayer
- Page 47 Photo of a Mass Spectrometer courtesy of the U.S. Department of Energy's EMSL
- Page 52 Photo of NMR machine courtesy of the U.S. Department of Energy's EMSL
- Page 52 Photo of an MRI scanner courtesy of the Institute of Psychiatry, King's College London
- Page 80 DNA structure © Jonathan Crowe
- Page 81 Photo of a diamond ring © Alice Mumford
- Page 81 Pentacene image from Gross, L. (2009). *The Chemical Structure of a Molecule Resolved by Atomic Force Microscopy*. Volume 325, Science. Reproduced with permission of American Association for the Advancement of Science via Copyright Clearance Center
- Page 82 Photo of a streetlight © Alice Mumford
- Page 82 Hydrogen emission spectra reproduced from Chemistry 3: Introducing inorganic, organic and physical chemistry by Burrows et al (2009) by permission of Oxford University Press
- Page 144 Benzene diffraction image from *Chemistry: a European journal* by GESELLSCHAFT DEUTSCHER CHEMIKER. Reproduced with permission of WILEY - VCH VERLAG GMBH & CO. KGAA via Copyright Clearance Center
- Page 149 Colour spectrum image reproduced from 'Chemistry 3: Introducing inorganic, organic and physical chemistry' by Burrows et al (2009) by permission of Oxford University Press
- Page 150 Photo of blue jeans © Alice Mumford
- Page 163 Photo of soluble aspirin © Alice Mumford
- Page 305 Photo of a pair of hands © Alice Mumford
- Page 305 Photo of a pair of feet © iStock/Valua Vitaly
- Page 305 Photo of gloves and of socks © Alice Mumford
- Page 305 Egyptian art depicting Queen Nefertari © Sandro Vannini/Corbis
- Page 305 Photo of a tennis racquet © iStock/Skip Odonnell
- Page 305 Photo of golf clubs © iStock/Okea
- Page 315 Photo of a handshake © iStock/kokouu
- Page 315 Photo of held hands © iStock/eucyln
- Page 368 Photo of a deckchair © Alice Mumford
- Page 369 Photo of boats © Alice Mumford

- Page 458 Photo of *Callistemon citrinus* (bottle brush plant) © J J Harrison, licensed under Creative Commons: <http://creativecommons.org/licenses/by-sa/3.0/deed.en>
- Page 553 Photo of a peptide synthesiser courtesy of Activotec Ltd., Cambridge
- Page 1002 Photo of snail © Alice Mumford
- Page 1137 DNA structure © Jonathan Crowe
- Page 1156 Photo of deadly nightshade *Atropa belladonna* © H. Zell, licensed under Creative Commons: <http://creativecommons.org/licenses/by-sa/3.0/deed.en>

Periodic table of the elements

		1	2	3	4	5	6	7	8	9		
		I	II	III	IV	V	VI	VII	VIII	VIII		
S	1	3 Li RAM: 6.941 P: 0.98	4 Be RAM: 9.012182 P: 1.57									
	2	Lithium	Beryllium									
	3	11 Na RAM: 22.98977 P: 0.93	12 Mg RAM: 24.305 P: 1.31									
		Sodium	Magnesium									
	4	19 K RAM: 39.0983 P: 0.82	20 Ca RAM: 40.078 P: 1									
		Potassium	Calcium									
	5	37 Rb RAM: 85.4678 P: 0.82	38 Sr RAM: 87.62 P: 0.95									
Rubidium		Strontium										
6	55 Cs RAM: 132.9054 P: 0.79	56 Ba RAM: 137.327 P: 0.89										
	Cesium	Barium										
7	87 Fr RAM: 223 P: 0.7	88 Ra RAM: 226.0254 P: 0.9										
	Francium	Radium										
d	21 Sc RAM: 44.95591 P: 1.36	22 Ti RAM: 47.88 P: 1.54	23 V RAM: 50.9415 P: 1.63	24 Cr RAM: 51.9961 P: 1.66	25 Mn RAM: 54.93805 P: 1.55	26 Fe RAM: 55.847 P: 1.83	27 Co RAM: 58.9332 P: 1.88					
	Scandium	Titanium	Vanadium	Chromium	Manganese	Iron	Cobalt					
	39 Y RAM: 88.90585 P: 1.22	40 Zr RAM: 91.224 P: 1.33	41 Nb RAM: 92.90638 P: 1.6	42 Mo RAM: 95.94 P: 2.16	43 Tc RAM: 98 P: 1.9	44 Ru RAM: 101.07 P: 2.2	45 Rh RAM: 102.9055 P: 2.28					
	Yttrium	Zirconium	Niobium	Molybdenum	Techneium	Ruthenium	Rhodium					
	71 Lu RAM: 174.967 P: 1.27	72 Hf RAM: 178.49 P: 1.3	73 Ta RAM: 180.9479 P: 1.5	74 W RAM: 183.85 P: 2.36	75 Re RAM: 186.207 P: 1.9	76 Os RAM: 190.2 P: 2.2	77 Ir RAM: 192.22 P: 2.2					
	Lutetium	Hafnium	Tantalum	Tungsten	Rhenium	Osmium	Iridium					
	103 Lr RAM: 260 P:	104 Rf RAM: 261 P:	105 Db RAM: 262 P:	106 Sg RAM: 263 P:	107 Bh RAM: 262 P:	108 Hs RAM: 265 P:	109 Mt RAM: 266 P:					
	Lawrencium	Rutherfordium	Dubnium	Seaborgium	Bohrium	Hassium	Meitnerium					
	f	57 La RAM: 138.9055 P: 1.1	58 Ce RAM: 140.115 P: 1.12	59 Pr RAM: 140.9077 P: 1.13	60 Nd RAM: 144.24 P: 1.14	61 Pm RAM: 145 P: 1.13	62 Sm RAM: 150.36 P: 1.17	63 Eu RAM: 151.965 P: 1.2				
		Lanthanum	Cerium	Praseodymium	Neodymium	Promethium	Samarium	Europium				
		89 Ac RAM: 227 P: 1.1	90 Th RAM: 232.0381 P: 1.3	91 Pa RAM: 213.0359 P: 1.5	92 U RAM: 238.0289 P: 1.38	93 Np RAM: 237.0482 P: 1.36	94 Pu RAM: 244 P: 1.28	95 Am RAM: 243 P: 1.3				
		Actinium	Thorium	Protactinium	Uranium	Neptunium	Plutonium	Americium				

Key

Symbol	Xx
Atomic number	...00
Relative Atomic Mass	RAM: 0.000
Electronegativity (Pauling)	...P: 0.0
Element	Name

						1s		
						1 H	2 He	
						RAM: 1.00794 P: 2.2	RAM: 4.002602 P: 0	
						Hydrogen	Helium	
10	11	12	13	14	15	16	17	18
	I	II	III	IV	V	VI	VII	VIII
			p					
			5 B	6 C	7 N	8 O	9 F	10 Ne
			RAM: 10.811 P: 2.04	RAM: 12.011 P: 2.55	RAM: 14.00674 P: 3.04	RAM: 15.9994 P: 3.44	RAM: 18.9984 P: 3.98	RAM: 20.1797 P: 0
			Boron	Carbon	Nitrogen	Oxygen	Fluorine	Neon
			13 Al	14 Si	15 P	16 S	17 Cl	18 Ar
			RAM: 26.98154 P: 1.61	RAM: 28.0855 P: 1.9	RAM: 30.97376 P: 2.19	RAM: 32.066 P: 2.58	RAM: 35.4527 P: 3.16	RAM: 39.948 P: 0
			Aluminium	Silicon	Phosphorus	Sulfur	Chlorine	Argon
28 Ni	29 Cu	30 Zn	31 Ga	32 Ge	33 As	34 Se	35 Br	36 Kr
RAM: 58.6934 P: 1.91	RAM: 63.546 P: 1.9	RAM: 65.39 P: 1.65	RAM: 69.723 P: 1.81	RAM: 72.61 P: 2.01	RAM: 74.92159 P: 2.18	RAM: 78.96 P: 2.55	RAM: 79.904 P: 2.96	RAM: 83.8 P: 0
Nickel	Copper	Zinc	Gallium	Germanium	Arsenic	Selenium	Bromine	Krypton
46 Pd	47 Ag	48 Cd	49 In	50 Sn	51 Sb	52 Te	53 I	54 Xe
RAM: 106.42 P: 2.2	RAM: 107.8682 P: 1.93	RAM: 112.411 P: 1.69	RAM: 114.82 P: 1.78	RAM: 118.71 P: 1.96	RAM: 121.757 P: 2.05	RAM: 127.6 P: 2.1	RAM: 126.9045 P: 2.66	RAM: 131.29 P: 0
Palladium	Silver	Cadmium	Indium	Tin	Antimony	Tellurium	Iodine	Xenon
78 Pt	79 Au	80 Hg	81 Tl	82 Pb	83 Bi	84 Po	85 At	86 Rn
RAM: 195.08 P: 2.28	RAM: 196.9665 P: 2.54	RAM: 200.59 P: 2	RAM: 204.3833 P: 2.04	RAM: 207.2 P: 2.33	RAM: 208.9804 P: 2.02	RAM: 209 P: 2	RAM: 210 P: 2.2	RAM: 222 P: 0
Platinum	Gold	Mercury	Thallium	Lead	Bismuth	Polonium	Astatine	Radon

Other artificially-produced elements have been isolated, but are of no practical interest to organic chemists.

64 Gd	65 Tb	66 Dy	67 Ho	68 Er	69 Tm	70 Yb	Lanthanides
RAM: 157.25 P: 1.2	RAM: 158.9253 P: 1.2	RAM: 162.5 P: 1.22	RAM: 164.9303 P: 1.23	RAM: 167.26 P: 1.24	RAM: 168.9342 P: 1.25	RAM: 173.04 P: 1.1	
Gadolinium	Terbium	Dysprosium	Holmium	Erbium	Thulium	Ytterbium	
96 Cm	97 Bk	98 Cf	99 Es	100 Fm	101 Md	102 No	Actinides
RAM: 247 P: 1.3	RAM: 247 P: 1.3	RAM: 251 P: 1.3	RAM: 252 P: 1.3	RAM: 257 P: 1.3	RAM: 258 P: 1.3	RAM: 259 P: 1.3	
Curium	Berkelium	Californium	Einsteinium	Fermium	Mendelevium	Nobelium	

This page intentionally left blank

Index

3TC *see* Lamivudine

A

A value 375

A, pre-exponential factor 257

AA *see* asymmetric aminohydroxylation

AB system, in ^1H NMR 296–8, 822–3

absinthe 1156

absolute configuration 313

absolute stereochemistry 313, 1104

controlling 1102–33

abstraction, of hydrogen 972–3

radical *see* radical abstraction

ABX systems, in ^1H NMR 298

acceptor synthon 712, 719–20

ACE (angiotensin-converting enzyme)

inhibitors 1140–1

acetaldehyde (ethanal) 28

enolization of 615

$\text{p}K_{\text{a}}$ of 176

reaction with ammonia to form a pyridine 758

use of trivial name 37

acetals 222, 224–8, 247

acyclic, conformation of 804

acyclic, stereoelectronic effects in 804

as functional group 32

as protecting group 228, 548–9, 1175

conversion of to enol ether 467–8

cyclic, conformation of 835

cyclic, stereoelectronic effects in hydrolysis of 800–1

formation

acid catalysis of 224–8

comparison with imine formation 233

difficulty of 226

in sugars 1143

thermodynamic control in 808, 835

from orthoesters 248

from reaction of benzaldehyde and 1,3-diols 808

hydrolysis 227, 247

acid catalysis of 224–8

$\text{S}_{\text{N}}1$ step in 338–9

in Claisen rearrangements 911–12

in nature 229

of esters 248

retrosynthetic analysis of 715

specific/general acid catalysed hydrolysis of 1059

spiroketals 803

stability of cyclic 227–8, 247–8

acetaminophen *see* paracetamol

acetate, as weak base in catalysis 263

in fatty acid synthesis 1162

acetic acid 28

^{13}C NMR spectrum 59

^1H NMR spectrum 270–1, 283, 59–60

as weak acid 166

bond strengths in 207

$\text{p}K_{\text{a}}$ of 169, 172, 176

use of trivial name 37

acetic anhydride, as dehydrating reagent 624

general base catalysis in reactions of 263

in chemoselective acetylation of amines 529

reaction with dicarboxylic acid to form anhydride 606

reaction with substituted pyridine *N*-oxide 731

acetoacetate, dianion, regioselective

alkylation of 601

decarboxylation of 597

in retrosynthesis 708

acetoacetic acid 596

acetone, ^{13}C NMR spectrum 62

as solvent for $\text{S}_{\text{N}}2$ 345, 357

bromination of 461–4

in aldol reaction 615

$\text{p}K_{\text{a}}$ of 176

use of trivial name 37

acetonitrile, as ligand in Pd(II) complex

1070

$\text{p}K_{\text{a}}$ of 585

acetyl chloride 31

^{13}C NMR spectrum 409

in enol ester formation 642

acetyl coenzyme A (acetyl CoA) 1134–5

biosynthesis of fatty acids, polyketides, terpenes and steroids from 1161–7

in citric acid synthesis 1153

N-acetyl galactosamine 1147

N-acetyl glucosamine 1147

acetylacetone, enolization of 458

acetylation, general base catalysis in 263, 1057–8

acetylene, as dienophile in Diels–Alder

reaction 881

deprotonation of with sodium amide

170–1, 187

deprotonation of with strong bases 170–1, 187

$\text{p}K_{\text{a}}$ of 170, 187

achiral 303–4

acid 165, 180

Brønsted 165, 180

chiral Brønsted, use in asymmetric catalysis 1180

carboxylic *see* carboxylic acid

Lewis 180–1

acid anhydrides *see* anhydrides

acid catalysis, effect on rate of reaction 452

general (GAC) 1058–60

in substitution reactions of carboxylic acids 208–9

of acetal formation and hydrolysis 224–8

of aldol reaction 616

of alkene isomerization 264–6

of amide hydrolysis 212

of butene isomerization 254

of dehydration 616, 621, 635

of enolization 452

of ester formation and hydrolysis 208, 244–6

of ester hydrolysis 209–10, 244–6

of ester hydrolysis, kinetics and mechanism 262–3

of hemiacetal and hydrate formation and decomposition 223–4

of imine and enamine formation and hydrolysis 230–2, 233

of substitution reactions at the carbonyl group 207–8

specific (SAC) 1053

features, summary 1055

inverse solvent isotope effect in 1054–5

acid chloride *see* acyl chloride

acid derivatives *see* carboxylic acid derivatives

acid strength, and structure, correlation

between 1041–4

summary of factors affecting 171 *see also* $\text{p}K_{\text{a}}$

acidity *see* $\text{p}K_{\text{a}}$

of carbonyl compounds 595

summary of factors affecting 171

acifran, synthesis of 646

ackee 1016

acquired immune deficiency syndrome *see* AIDS

acridine 750

acrolein, ^{13}C NMR spectrum 77

conjugate addition to 502, 606

in quinoline synthesis 782

molecular orbitals of 502

acronyms, as compound names 39

acrylonitrile, as electrophile in conjugate

addition reactions 510

as Michael acceptor in conjugate addition 610, 612

activation energy 108–9, 250

and rates 256

E_{a} or ΔG^{\ddagger} 250–3

effect of catalyst on 254

of ring closing reactions 806–7

acyclovir (Zovirax) 1138

acyl anion equivalents 663

acyl chlorides, ^{13}C NMR chemical shifts of carbonyl 408–9

α,β -unsaturated, conjugate addition to 506 as functional group 31

bromination of 461–2

chain extension by Arndt–Eistert reaction 1021

conversion to ketones with Grignard

reagents and organolithiums 218

E1cB elimination of 403

enolization of 455

for *C*-acylation of enamines 650

formation of ketenes from 455

- acyl chlorides, ^{13}C NMR chemical shifts of
 carbonyl (*continued*)
 from carboxylic acids 214–15, 730
 in Friedel–Crafts acylations 492–3
 IR for identification of 411
 reaction with alcohols 198–200
 reaction kinetics of 258–9
 reaction with amines 202–3, 695, 701, 714
 reaction with aza-enolates to acylate
 carbon 650–1
 reaction with aziridine 793
 reaction with diazomethane 1006–7
 reaction with enolates 453
 reaction with saturated nitrogen
 heterocycles 791
 reaction with water 206
 reduction to aldehydes 537
 uses of 31
 N-acyl aziridines, 793–4
- acylation, at carbon 640–55
 catalysed by DMAP 726
 chemoselective (N vs O) 529, 546–7
 Friedel–Crafts *see* Friedel–Crafts acylation
 of alcohols 198–9, 208
 of aza-enolates, regioselectivity in 650
 of enamines 650
 of enolates 641
 control with specific enol equivalents
 648–52
 problem with 641
 of free carboxylic acids 651–2
 of Grignard reagents and organolithiums
 218
 of indole nitrogen 779
 of ketones 649, 651
 of pyrrole by Vilsmeier reaction 733–4
 of pyrrole nitrogen 740
 of saturated nitrogen heterocycles 791, 793
- acylium ion, as intermediate in Friedel–Crafts
 acylations 477, 493–4
- acyloin reaction 983–4
 intramolecular 984
 with trimethylsilyl chloride (TMSCl) 983–4
- AD *see* asymmetric dihydroxylation
- Adams' catalyst 535
- addition, 1,4-, *see* conjugate addition
 conjugate *see* conjugate addition
 conjugate vs direct, control of 605–6
 of alcohols to carbonyl compounds 136–7
 of alkyl radicals to alkene, tin method,
 summary 996
 of alkyl radicals to alkenes, tin method
 993–6
 of Grignard reagents and organolithiums
 to carbonyl compounds 132–3,
 182, 187, 190–4, 216
 of water to carbonyl group 133–5
 oxidative 184–5
 radical *see* radical additions
- addition–elimination reactions 201–2,
 511–14 *see also* conjugate
 substitution
- adenine 750, 1135–6
 in aristeromycin synthesis 1091
- adenosine diphosphate *see* ADP
- adenosine monophosphate *see* AMP
- adenosine triphosphate *see* ATP
- adenosine, as nucleoside 1135–6
- S-adenosyl methionine (SAM) 1136–7,
 1157–8, 1160
- adenylate cyclase 1139
- adipic acid *see* hexane-1,6-dioic acid
- AD-mix 1124
- ADP (adenosine diphosphate) 1154
- adrenaline (epinephrine) 314
- AE *see* asymmetric epoxidation
- aflatoxin B₁ 432–3, 817
- AFM *see* atomic force microscopy
- agonist, in drug design 178
- agrochemicals 11
- a_{H} , coupling constant in EPR 976
- AIBN (azoisobutyronitrile) 972
 as initiator for homolysis of tributyltin
 hydride 991–2
 reactivity of radicals from 996
- AIDS (acquired immune deficiency
 syndrome) 1170
 drugs for treatment of 1066–7, 1123, 1125,
 1138, 1142
- alanine 16, 308, 554, 1104
 biosynthesis 235
 (R) (D-alanine), in bacterial cell walls 308,
 1141–2
 ^1H NMR spectrum of N-benzyl
 derivative 833
 racemic laboratory synthesis of (Strecker
 synthesis) 307–8
- alcohols 29
 acylation, kinetics of 258–9
 allylic, asymmetric epoxidation of 1120–2
 from selenium dioxide and alkenes 919
 oxidation and rearrangement with
 Cr(VI) 916–7
 Simmons–Smith cyclopropanation of 1017
 stereoselective epoxidation of 850–1,
 856, 867
 amino, from epoxides and amines 352
 as nucleophiles in conjugate addition 500
 by hydrolysis of esters 209
 by ozonolysis of alkenes 444
 by reaction of organometallics with
 carbonyl compounds 191–4, 216,
 710–11
 by reduction, of carbonyl compounds with
 borohydride 193, 251, 253
 of esters with lithium aluminium
 hydride 217, 298
 of ozonides 907
 conversion to alkyl halides 329–30, 336–7,
 348
 enantioselective synthesis, from aldehyde
 1126–7
 from ketone 1114–17
 Fischer esterification of 208, 244–6
 from alkenes, by hydration 444–5
 by hydroboration 446–7
 from carbonyl compounds by Bouveault–
 Blanc reduction 981
 homoallylic, from allylic silanes and
 carbonyl compounds 676–7
 IR spectra of 67
 nucleophilic substitution on 348–51
 oxidation to aldehyde with PCC or PDC
 732, 1121
 primary, by reduction of aldehydes 132–3,
 530–1
 by reduction of esters 531
 by reduction of carboxylic acids 531–2
 oxidation to aldehydes 545
 oxidation to carboxylic acids 546
 reaction with PBr₃ 329
 protection 549–52
 as silyl ethers 635, 670–1
 protonation with sulfuric acid 173
 reaction with acid chlorides and acid
 anhydrides 198–9
 reaction with alkylating agents to form
 ethers 337, 340
 reaction with carbonyl compounds 223–8
 reaction with carboxylic acids under acid
 catalysis 208, 244–6
 reaction with enol ethers 469
 reaction with epoxides to form ethers
 703–4
 secondary, by reduction of ketones 132–3,
 530–1
 oxidation to ketones 544–5
- $\text{S}_{\text{N}}1$ reaction with alkyl halides to give
 ethers 338
- sulfonylation for elimination reactions 390
- tertiary, from esters and organometallics
 297–8, 216–17
 from tertiary alkyl halides and water
 334, 336
 reaction with HBr 329
- aldehyde 30–1 *see also* carbonyl compounds
 ^{13}C NMR chemical shifts of carbonyl 408–9
 ^1H NMR chemical shifts of proton 410
 ^1H NMR to distinguish from ketone 410
 acid catalysed enolization of 452
 addition of bisulfite 138–40
 aldol reactions of, controlling 632–3
 alkylation of 590–5, 613
 summary 594
 via aza-enolates 593–4
 asymmetric nucleophilic addition to
 1126–7
 Baylis–Hilman reaction with α,β -
 unsaturated carbonyl compound
 792
 by decomposition of ozonides 907
 by hydroformylation of alkenes using
 OXO process 1077
 by hydrolysis of imines 594
 by oxidation of alcohols 545, 667–8,
 732, 1121
 by oxidative cleavage, of alkenes 443–4
 of diols 443
 by reduction, of acid chlorides 537
 of amides 533–4
 of esters 533
 of nitriles 534
 chiral, Felkin–Anh model for
 stereoselective reactions of 859–62
 conversion to alkenes by the Wittig
 reaction 237–8
 to amino acids by the Strecker
 reaction 236

- to epoxides with sulfonium ylids 665–7
 - disproportionation of, in the Cannizzaro reaction 1031–4
 - drawing structure of 31
 - enol and enolate equivalents for 591–5, 632
 - in nature 1151–3
 - enolization of 451, 454
 - formation of enamine by reaction with cyclic amine 791
 - from pinacol rearrangement of epoxides 946
 - γ,δ -unsaturated, synthesis by Claisen rearrangement 911–12
 - hydration of 243
 - in Julia olefination to form alkenes 686–8
 - in McMurry reaction to form alkenes 983
 - nucleophilic addition to 125–40
 - oxidation to carboxylic acids 546
 - pinacol radical reaction of 982
 - protection as acetals 228
 - reaction with alcohols, to form acetals 224–7, 247
 - to form hemiacetals 135–8, 197, 223–4, 247
 - reaction with amines, to form enamines 233–4
 - to form imines 229–37
 - reaction with organometallics 190–1
 - in retrosynthesis 711
 - reaction with water 133–5
 - reduction to primary alcohol 131–3, 530–1
 - region in ^1H NMR 281–2
 - smell of 30–31
 - specific enol equivalents for, summary 595
 - synthesis from organometallics and DMF 219–20
 - unsaturated, synthesis of 545
 - use of ^{13}C NMR to distinguish from acid derivatives 408–10
- aldehyde enolates, problem with 590
- Alder ene reaction 894–6
- Alder, Kurt 878
- aldol disconnection, in retrosynthetic analysis 712–13
- aldol reaction 614–40
- acid-catalysed 616
 - asymmetric 1129–32
 - base-catalysed 615, 618
 - compared with Claisen condensation 640
 - competing, how to avoid during alkylation 585–613
 - conditions for aldol addition or elimination product 616
 - control in 631–6
 - controlling geometry of enolates for 870–1
 - dehydration product of 616
 - diastereoselective, effect of enolate geometry 868–71
 - disconnection in heterocycle synthesis 762
 - Evans 1129–30
 - in nature 1151–6, 1164, 1165
 - intramolecular 636–40, 738, 759
 - mechanism of 615
 - Mukaiyama 636
 - of 1,3-dicarbonyl compounds (Knoevenagel reaction) 629–30
 - of lactone 617, 618
 - of silyl enol ether, mechanism 626
 - of unsymmetrical ketones 617
 - transition state for 869–70
 - with a lithium enolate 625–6
- aldol self-condensation, unwanted in aldehyde enolate alkylation 590
- aldolase enzyme 1151–3
- aldose 315
- aldrin 881
- alga, pheromone of 915
- aliphatic 281
- alkali metal enolates, conjugate addition of 607
- alkaloids 745, 1156–61
- cinchona, in AD reaction 1123–6
 - indole 745
 - papaverine 755
 - synthesis of 1156–61
- alkanes 28
- bond length of C–C in 295
 - bonding in and molecular orbitals of 100
 - bromination of 988–9
 - chlorination of 986–8
 - heats of combustion 367–8
 - region in ^1H NMR spectrum 272–6
- alkene geometry, and relationship to properties of 677–8
- cis/trans* and *Z/E* nomenclature 392, 679
 - control of 677–93
 - by alkyne reduction 681–3
 - by equilibration 679–81
 - by fragmentation 965–6
 - by nucleophilic addition to diyne 683–4
 - by reduction of alkynes 681–3, 707
 - by stereoselective elimination 684–9, 691–3
 - by stereoselective Julia olefination 686–8
 - by stereoselective synthesis 681–8
 - by stereospecific elimination 688
 - by stereospecific Peterson elimination 688–9
 - by stereospecific synthesis 688–93
 - by synthesis of cyclic compounds 678–9
 - by Wittig reaction 689–93
 - summary 678, 693
 - via cyclic compounds 678–9
 - equilibration 241, 264–6
 - by conjugate addition 680
 - by light 680
 - in rings 678–9
 - summary of terminology 405
- alkene metathesis 1023–7 *see also* metathesis
- alkenes 28,
- [3+2] cycloaddition with nitrile oxide 903
 - ^1H NMR, coupling in 415
 - allylic coupling in ^1H NMR 301
 - allylic radical bromination of 990
 - as dienophiles in Diels–Alder reactions 881
 - as electrophiles 498–514
 - summary table of reactions 526
 - as nucleophiles 118, 427–8
 - Baeyer–Villiger oxidation in presence of 954–5
 - bond length of C=C 295
- bonding in and molecular orbitals of 100–1
- bridgehead, from Cope rearrangement 914
- bromination of 427–9
 - comparison with bromination of enol 461

evidence for mechanism 440–1

radical and ionic regiochemistry compared 573

stereospecificity and stereoselectivity of 836, 853

stereospecificity of 440–1
 - via ionic mechanism 971

by elimination 382–4
 - from alcohols 389
 - from alkyl halides 385–8
 - of selenoxides 686
 - of sulfoxides 684–5

by migration in carbene 1019

by reduction of alkynes 537

by Wittig reaction 237–8

catalytic asymmetric reduction 1117–19

chiral, stereoselective electrophilic attack on 865–7

complexation with mercury 444–5

conjugated *see also* α,β -unsaturated carbonyl compounds
 - effects of reaction conditions on reactivity 489
 - with carbonyl groups, effect of 498–503

coordinated to palladium, nucleophilic attack on 1096–8

coupling to organic halide/triflate in Heck reaction 1069, 1079–81

cyclic, ^1H NMR couplings in 814
 - allylic coupling (4J) in 814–15
 - from intramolecular McMurry reaction 983
 - stereoselectivity of epoxidation 848, 850–1, 855

determination of geometry, by NOE 799–800

dihydroxylation of 1123–6

E or *Z* selective formation *see* alkene geometry

electron-rich and electron-deficient, ^1H NMR of 280–1

electrophilic 498–514
 - summary table of reactions 526

electrophilic addition to 427–48
 - orbital interactions 428–9
 - regioselectivity 433–5
 - summary 447

energy difference between *E* and *Z* 265

epoxidation of 429–33, 513–14
 - asymmetric 1120–3
 - effect of substituents 431–2
 - electrophilic, with peracids 429–33
 - mechanism 430
 - nucleophilic, with hydroperoxide 513
 - regioselectivity 431–2
 - stereoselectivity 840–1, 856
 - stereospecificity 430–1, 514, 854–5
 - with *m*-CPBA 430–2

excited state, molecular orbital of 897

from alkynes 543

- alkenes (*continued*)
 from McMurry reaction of ketones 982–3
 functional group interconversions of 707
 geometry *see* alkene geometry
 HOMO and LUMO of in Diels–Alder 886–91
 hydration of 444–5
 regioselectivity of 444–7
 via boranes 446–7
 hydroboration of 446–7
 hydrobromination of 118–19, 433–4
 radical and ionic regiochemistry compared 571
 hydroformylation of using OXO process 1077
 hydrohalogenation of 433–5
 in Alder ene reaction 894–5
 in rings, diastereoselectivity of reactions 835–6, 842, 844–5
 IR spectrum of 70
 isomerization of, acid catalysed 434–5
 by hypopalladation–dehypopalladation 1081–2
 for regiocontrol 570
 isomerization of, in acid 254, 264–6
 isomers of 105
 neighbouring group participation by 935
 NMR spectra of 281
 oxidative cleavage of 443–4, 906–7
 photoisomerization of 105
 preference for ring position 570
 radical addition of alkyl halides to 992–6
 radical bromination of 971, 973
 radical reaction with HBr 984–5
 rates of bromination 437–8
 reaction with carbenes to form cyclopropanes 1013–18
 with hydrogen halides 434–5
 with hydrogen sulfide 434–5
 with NBS and alcohol or water 441–2
 with osmium tetroxide to form diols 442–3, 905–6
 regio- and stereoselective synthesis using vinyl silanes 673–4
 region in ¹H NMR 277–81
 retrosynthetic analysis of 707
 Simmons–Smith cyclopropanation of 1017
 stability of *E* vs *Z* 679
 stereoselective electrophilic addition to 439
 stereoselective epoxidation of 866–7
 stereoselective formation 677–93 *see also* alkene geometry
 stereospecific electrophilic additions to 440–1, 853–4
 stereospecific formation, from E2 elimination reactions 853
 substituted, by palladium catalysis 1096
 summary of stabilizing effects on 405
 Wacker oxidation of to form ketones 1096
 alkoxides, as base for enolate formation 454–6, 595
 as leaving groups 199, 202, 204, 728
 as nucleophile in conjugate addition 503, 511
 as nucleophile in nucleophilic aromatic substitution 518
 choice of for deprotonation of ester 596
 alkoxy, as functional group 29
 alkyl bromides 30 *see also* alkyl halides
 by reaction of primary alcohols with PBr₃ 329
 by reaction of tertiary alcohol with HBr 329
 from hydrogen bromide and alkene 433–4
 reaction with sodium cyanide to form nitrile 716
 synthesis from alcohols 348
 alkyl chains, assembly of 539
 alkyl chlorides 30 *see also* alkyl halides
 from alcohols 348
 from hydrogen chloride and alkene 434–5
 in Friedel–Crafts alkylation 492–3
 rates of solvolysis 338
 reaction with saturated nitrogen heterocycles 791
 synthesis from alcohols 348
 alkyl cyanides *see* nitriles
 alkyl diazonium salt 521
 alkyl group, migration of 940–4
 alkyl halides 30 *see also* alkyl bromides, alkyl chlorides
 α-elimination of 1008–9
 from alcohols 329–30, 336–7, 348
 from hydrogen halide and alkenes 434–5
 radical addition to alkene 992–6
 reaction with enolates 453
 S_N1 reaction with alcohols to give ethers 338
 S_N2 reaction with alcohols to give ethers 340–1
 substitution of halogen for hydrogen 991
 tertiary, alkylation of enolates with 595
 reaction with water 334, 336
 alkyl iodides *see* alkyl halides
 alkyl nitrite, as source of nitronium 521
 alkyl radicals, conjugate addition of 998–9, 993–4
 from borane–oxygen method 998–9
 alkyl tosylate, as alkylating agent 596
 alkylating agents 225 *see also* alkylation
 alkylation, and electrophile choice (table) 587
 chiral auxiliary-controlled 1109–10, 1112
 diastereoselective, of *trans*-fused bicyclic enolates 841–2
 double, of 1,3-dicarbonyl compounds 598
 intramolecular 586
 multiple, how to control 586, 589
 multiple, of amines 700–1
 of 1,3-dicarbonyl compounds 595–8
 of a six-membered cyclic enamine, axial attack 830–1
 of acetoacetate dianion, regioselectivity of 601
 of aldehydes 590–5, 613
 summary 594
 via aza-enolates 593–4
 of alkynes 189, 706–7
 of amines 698, 700–1, 704
 of aza-enolates 593–4
 of benzene by Friedel–Crafts reaction 477–8
 of butenolides, stereochemical control in 834–5
 of carboxylic acids 589–90
 of chiral enolates 1110
 of dianions 601
 of enamines 591–3, 650
 of enolates 584–613
 as disconnection in heterocycle synthesis 760, 770
 C-alkylation vs O-alkylation 590
 formed by conjugate addition 603–5
 regioselectivity of 590, 592, 595–7, 598–604, 613
 stereoselective, in indinavir synthesis 1172–4
 summary of methods (table) 612
 with α-halo carbonyl compounds 760–1
 of esters 589, 595–8, 613
 of imidazole 742–3
 of imines 593–4
 of indole nitrogen 778
 of ketones 588–9, 591–7, 600–4, 613
 regioselectivity of 590, 592, 595–7, 598–604, 613
 of lithium enolates 588–90, 604, 607, 610
 of Mannich base 621
 of nitriles 585–6
 of nitroalkanes 586–7
 of pyrazole with dimethyl sulfate 769
 of saturated nitrogen heterocycles 793
 of sulfoxide anion 661
 of symmetrical ketones 588–9, 591–7, 613
 of unsymmetrical ketones, on less substituted side 588, 592, 600–3, 613
 on more substituted side 595–7, 599–600, 602–4, 613
 S_N1, of cyclopentanone 595
 of silyl enol ethers 595
 stereoselective, of chiral enolate 867–8
 using palladium 1088–91
 alkylbenzenes, σ-conjugation in 484
 alkyllithiums, as chiral bases 1113–14
 alkynes 28–9
 ¹H NMR of 414
 addition to, in stereoselective formation of alkenes 264, 681–4
 alkylation of 189, 706–7
 bonding in and molecular orbitals of 102
 bromination of, reaction mechanism 1036
 by elimination reactions of vinyl halides 398
 complex with mercury 445–6
 coupling by Sonogashira coupling reaction 1087–8
 cycloaddition, with azide 776
 with nitrile oxide 773–4, 903
 deprotonation with strong base 170–1, 176, 187
 hydration of, using gold 1099
 using mercury 445–6
 in antitumor agents 29
 insertion into 1076
 IR spectra of 67–9
 metal derivatives of 187
 metathesis of 1026–7

- oxymercuration of 445–6
 pK_a of 188
reduction to alkenes 537
retrosynthetic analysis of 706–7
terminal, silyl as protecting group for 671
Z alkenes from by addition of nucleophiles to 683–4
- alkynyl silanes, reduction to give vinyl silanes 683
- alkynyl sulfone, as dienophile 739
- alkynyllithiums, as nucleophiles in S_N2 349
from 1,2-dibromoalkenes 398
- allenes, arrangement of p orbitals 146
chirality of 319
- allicin 37
- allopurinol, for treatment of gout 751
synthesis of 758
- allotrope, of carbon 80–1
- allowed reactions, in cycloadditions 896
- allyl, meaning of 37
- allyl acetate, from electrocyclic reaction of cyclopropane 928
- allyl alcohol, ^{13}C NMR spectrum 62
- allyl anion, comparison with enolate 453
metal complex 1071
structure and molecular orbitals 150–2
- allyl cation, from electrocyclic ring opening of cyclopropyl cation 928
metal complex 1071
structure and molecular orbitals 152–3, 336
- allyl group 150–3
- allyl lithium, ^{13}C NMR spectrum 152
- allyl silanes 668
molecular orbitals of 676
reactions of 675–7
synthesis of 675
- allylation, stereo- and regioselective, using palladium 1088–91
- allylic alcohols, asymmetric epoxidation 1120–2
asymmetric hydrogenation 1118
conversion to allylic halides 336–7, 577
from selenium dioxide and alkenes 919
in Simmons–Smith cyclopropanation 1017
oxidation and [3,3]-sigmatropic rearrangement with Cr(VI) 916–17
stereoselective epoxidation of 850–1, 856, 867
- allylic bromides, from alkenes 572–4
from dienes 579–80
isomerization of 579–80
reaction with copper(I) cyanide 576
- allylic bromination 572–4, 989–90
- allylic chlorides, from dienes 579–80
nucleophilic substitution of 578–9
primary, from allylic alcohols 577
regiospecific substitution on 578–9
regiospecific synthesis of 577
- allylic compounds, frontier orbitals of 574
reactivity of 574–81
- allylic coupling, in 1H NMR 295–6, 301, 814–15
- allylic ester, [3,3]-sigmatropic rearrangement of 914
- allylic ethers, sigmatropic rearrangement of 909–18
- allylic halides 336–7 *see also* allylic chlorides, allylic bromides
in S_N1 reactions
in S_N2 and S_N2' reactions 341, 574–9
- allylic radical 573
- allylic rearrangement, palladium catalysed 1097
- allylic strain 866
- allylic sulfoxide, by [2+3]-sigmatropic rearrangement of sulfenate 918
- almond extract, mandelic acid (synthesis of) 213–14
- $[\alpha]_D$, specific rotation 310
- α effect, in hydroperoxide anion 513
in pyridazine 748
- α -elimination *see* elimination, α
- α -halocarbonyl compounds, alkylation of enolate with 760–1
as reagents for 1,4-disconnection 721
in 1,2-disconnections 704
in S_N2 reactions 341–2
- α -haloketone, Favorskii rearrangement of 950–3
- α -hydroxyketone, from acyloin reaction of esters 983–4
- α -keto acids, biosynthesis 1153–5
- α,β -unsaturated aldehydes 500 *see also* α,β -unsaturated carbonyl compounds
by dehydration 632
by Reformatsky reaction 713
 1H NMR spectrum 282
reactions of 502–3, 505–6, 509
- α,β -unsaturated amides, retrosynthetic analysis of 714
- α,β -unsaturated carbonyl compounds 498–502
as electrophiles 498–514
as enolate equivalents 602–5
Baylis–Hilman reaction with aldehyde 792
bromination of 499
by dehydration of aldol product 616
by E1cB elimination 399–404, 616
by elimination of selenoxides 686
by elimination of sulfoxides 684–5
chlorination of 503–4
conjugate addition of enolates to 605–10
conjugate addition vs direct addition 504–7
epoxidation of 514
from alkenes and selenium dioxide 919
in retrosynthetic analysis 705
molecular orbitals compared with dienes 502
polarization of alkene 501–3
reactions of 498–514
with anilines 781
with organocopper reagents 509
with tetrazole 775
reduction with sodium borohydride 506
retrosynthetic analysis of 713–15
- α,β -unsaturated carboxylic acid derivatives, reactions of 500, 508
- α,β -unsaturated carboxylic acids, hydrogenation 1118, 1119
retrosynthetic analysis of 714
- α,β -unsaturated esters, from aldol reaction 628
- retrosynthetic analysis of 714–15
- α,β -unsaturated ketones 500 *see also* α,β -unsaturated carbonyl compounds
from aldol reaction 628
Nazarov cyclization of 927
reactions of 503–5, 507–12, 514
- α,β -unsaturated nitriles, as electrophiles in conjugate substitution 510–13
- alaphrodine 829
- aluminium trichloride, as electrophile 113–14
as Lewis acid catalyst 180–1, 676
catalyst for electrophilic aromatic substitution 474, 477, 493–4
- amelfolide 695
- 'amide' anion 174
- amide bond, conjugation and delocalization in 241–2
rotation of, energy profile of 256
rate constants 256
indicated by 1H NMR 274
structure and conjugation 154–6
- amide linkage 31
- amides 31
 α,β -unsaturated, conjugate addition to 505–6
 γ,δ -unsaturated, synthesis by Claisen rearrangement 912
 ^{13}C NMR chemical shifts of carbonyl 408–9
 1H NMR spectra of 283
as functional group
by Schotten–Baumann method 203
difficulty of formation from carboxylic acids and amines 207
enolates from 456–7
formation using DCC 747–8
from amines, and acyl chlorides 202–3, 403, 695, 701, 714
and anhydrides 177, 695, 701, 714
and esters 203–4
and ketenes 403
from Beckmann rearrangement 958–9
from nitriles by Ritter reaction 353
Hofmann rearrangement to amines 1022
hydrolysis of 212–13
reaction kinetics for 260–1
IR for identification of 411
protonation of 212
reaction with Grignard reagents or organolithiums to form ketones 219
reaction with Lawesson's reagent 772
reaction with water 206
reduction, to aldehyde 533–4
to amine 236, 701–2
with borane 532–3
with DIBAL 533
with lithium aluminium hydride 531
retrosynthetic analysis of 695, 696, 701
slow rotation about C–N bond in 241–3
see also amide bond rotation
stabilization through conjugation 206
unsaturated, as Michael acceptors 610
Weinreb (*N*-methoxy-*N*-methyl amide) 219
- amidines, as bases, elimination with 387
in synthesis of pyrimidine 760, 770–1
- amination, Buchwald–Hartwig 1092–5

- amine oxide, structure of 901
amines 29
¹H NMR spectra of 283
β-halo, rearrangement during hydrolysis of 938
acylation in presence of alcohols 529
alkylation of 698, 700–1, 704
selective, using epichlorohydrin 704
aminoketones from by S_N2 reaction 341–2
aromatic *see also* anilines
¹H NMR of and effect of delocalization 278
diazotization of 522–3
aryl, from Buchwald–Hartwig cross-coupling reaction 1092–5
as leaving groups 212–13
as nucleophiles, for substitution on pyridines 728
in conjugate addition 500, 503, 510, 512
in S_N2 reactions 353
asymmetric synthesis from carbonyl compounds, by nature 1150–1
by Curtius rearrangement of a carboxylic acid 1022
by hydrolysis of amides 212–13
by reduction, of amides 236, 531–3, 701
of azides 353–4, 1176
of imines 234–6, 539
of nitriles 236, 539
of nitro groups 538, 728
of oximes 702, 762
by reductive amination 234–6, 701–2
chiral, as organocatalysts 1128–9
cyclic 791–4
and acyclic, nucleophilicity compared 791, 794
by palladium catalysed cyclization 1098
enamine formation and nucleophilicity 592
danger of multiple alkylations 700–1
from Hofmann rearrangement of an amide 1022
functional group interconversions leading to 700–2
in Mannich reactions 622
neighbouring group participation of 938
primary, dimethylation of 778
protection of 556–9
reactions of, with acyl chlorides 202–3, 695, 701, 714
with anhydrides 695, 701, 714
with carbonyl compounds to form enamines 233–4
with carbonyl compounds to form imines 229–37
with chloroformates 728
with epoxides to give amino alcohols 352, 439
with esters 203–4
retrosynthetic analysis of 698, 699–702
symmetric and antisymmetric stretching in IR spectra 67
amino acids 16, 554–5 (table), 1139–42
¹H NMR of 284–5, 822–3
as acids and bases 167
asymmetric synthesis of 1118
by the Strecker reaction 236
chirality of 307–8
conjugate addition of protected 610
coupling of 747–8
derivatives of in chiral stationary phase 325–7
diastereotopic protons and NMR 822–3
diazotization of 1105
drawing 23
essential, synthesis by plants 1154
from imines in nature 235
in alkaloid biosynthesis 1156–60
in primary metabolism 1135
natural and unnatural 1103–4, 1141
properties 16
protection of 553–9
racemization of 460
resolution of 323–4, 1106
stereochemical nomenclature 1103
structures of (table) 554–5
amino alcohols, 1,2-, retrosynthetic analysis and synthesis of 703, 715
1,3-, retrosynthetic analysis of 715, 716–17
1,3-, synthesis by Mannich reaction 716–17
by nitrile aldol 715
by reduction of amino acids 1105
chemoselective acylation of 529
chiral, as ligand for dialkylzinc additions 1126–7
from amines and epoxides 352, 439
from nitrile oxides 903
amino group 29 *see also* amine
3-amino ketones, retrosynthetic analysis of 716
amino sugars 1147
aminobenzenes *see* anilines
aminohydroxylation, asymmetric 1120
aminoketones, from S_N2 reaction of α-halo carbonyl compounds and amines 341–2
aminonitrile 236
aminotransferase, enzyme 1151
amlodipine, structure of 765
ammonia, as leaving group in imine hydrolysis 231–2
as nucleophile in conjugate addition 505–6
pK_a of 171
reaction, with acetaldehyde to form pyridine 758
with aldehydes to form imines 231
with formaldehyde in synthesis of hexamethylenetetramine 1179–80
shape of molecule 82
ammonium ions, as leaving group in elimination reactions 390
pK_a of 213
tetra-alkyl, to avoid solvation of nucleophiles 344
ammonium salts, unwanted formation of in S_N2 353
amoxicillin 10
AMP (adenosine monophosphate) 1135–6, 1149
amphetamine 29, 314
amphoteric 16
anabolic steroids 379
analgesic, opioid 701
anchimeric assistance 932 *see also* neighbouring group participation
androstenedione 1103
angiotensin-converting enzyme (ACE) 1140–1
angle, bond 365 *see also* bond angles
Bürgi–Dunitz 860
dihedral and torsion 364
anhydride, acetic *see* acetic anhydride
anhydrides (acid anhydrides), ¹³C NMR chemical shifts of carbonyl 409
from dicarboxylic acid with acetic anhydride 606
in Friedel–Crafts acylations 494
IR for identification of 411
reaction with alcohols 198–9, 205
reaction with amines 695
reaction with water 206
anilide 177
aniline, ¹H NMR chemical shifts compared to phenol 482
as an acid and a base 174–5
bromination of 482
electrophilic aromatic substitution, controlling 483
IR spectrum of 66
pK_a of 174–5
anilines, by reduction of nitro compounds 495
reaction with 1,3-dicarbonyl compounds 781
reaction with α,β-unsaturated carbonyl compounds 781
substitution by conversion to diazonium compounds 520–3
sulfonation of 565
anionic oxy–Cope rearrangement 913–14
anions, as nucleophiles 112
from sulfones 663, 664
in electrocyclic reactions 927–8
non-nucleophilic, use in synthesis of carbocation 334–5
of nitroalkane *see also* nitronate anions 587
stabilized by sulfur 660–1
anisole 480
annulenes, 10, 18, and 20 161, 278
anomalous Beckmann rearrangement 959–60
double 803
in 1,3,5-triazine 804
in saturated oxygen heterocycles 801–2
in spiroketals 803
in sugars 801–2, 1143
anomeric effect, on bond strengths 803
on saturated heterocycles 801–3
orbital explanation of 802–3
anomeric position, of sugars 1143
anomers, of sugars 1143
antagonist, in drug design 178
antarafacial 892
migration 920–1
orbital interaction in [3,3]-sigmatropic rearrangements 913

- anthocyanidin 1145
anthracene, Diels–Alder reaction with
 benzyne 893
anthracycline 445–6
anthranilic acid, diazotization of 893
anti aldol product 868–71, 1132
anti aldols, summary 871
anti and *syn* nomenclature 858
antiaromatic, definition of 161
antibiotics 10
 ene-diyne 1088
 mode of action 1141–2
 quinolone containing 782
antibonding orbitals 88–91
 in electrophiles 114
anticancer drugs, mode of action 508
anticholinergic 705–6
anticlinal 366
antidepressant 1103
anti-obesity drug 698–9, 701, 703
antioxidants, nutritional 1145–6
anti-periplanar conformation 365–6
 in E2 elimination 395–7
antipyrene 723
antisymmetric stretch, in IR spectra 67, 70
antitumour agents 12
antiviral drugs 12, 1138, 1170–9
AO *see* atomic orbital
aprotic polar solvents *see* polar aprotic
 solvents
Ar, definition of 24–5
arabinose 316
arachidonic acid 146, 1161, 1163
arene *see* aromatic compound
arginine 175, 555
arildone 708
aristeromycin 1091
Arndt–Eistert reaction 1021
aromatic amines *see* anilines
aromatic compounds 161
 as electrophiles 514–26
 as nucleophiles 471–97
 Birch reduction of 542–3
 IR spectrum of 70
 regiocontrol in synthesis of 566–7
 synthesis by nature 1154–6
 use of numbers in naming 479
 use of *ortho*, *meta*, *para* in naming 479
aromatic heterocycles *see also* heterocycles,
 aromatic
 structures and reactions of 723–56
 synthesis of 757–88
aromatic rings, neighbouring group
 participation by 935–6
 catalytic hydrogenation of 537
 electron distribution by ¹H NMR 278–9
aromatic substitution *see* nucleophilic or
 electrophilic aromatic substitution
aromatic transition states, in Diels–Alder
 reactions 891, 894
aromaticity, Hückel's rule and 161
 in benzene 143–4, 156–7, 159–60
 in heterocycles 162, 724–5, 903
 of porphyrin 753
 orbitals and 157–62
 stabilizing effect on phenol 471–2
Arrhenius equation 257
Arrhenius, Svante 257
arrows, curly *see* curly arrowsfish hook, in
 radical reaction mechanisms 972
 retrosynthetic 694
 types of, summary 123, 266, 694
arsenic pentoxide, in Skraup quinoline
 synthesis 782
arthritis, drug for treatment of 657, 1100, 1163
2-aryl propionic acids 324
aryl halides *see* halobenzenes
aryl ring *see* aromatic ring
aryl, meaning of 24
aryl-aryl cross couplings, via Suzuki coupling
 reaction 1086
aryllithium 563–4
ascorbic acid 6 *see also* vitamin C
 as derivative of glucose 1146
 in treatment of scurvy 1141
asparagine 555
aspartame 9, 31, 558
 synthesis using enantioselective
 hydrogenation 1118, 1119
aspartate, ¹H NMR spectrum 833
aspartic acid 555, 1104, 1118, 1119
aspirin, structure and solubility of 163
 synthesis of 481–2
assignment of *R* or *S* 308–9
asthma, drug for treatment of 1117, 1163
asymmetric aldol reactions 1129–32
asymmetric aminohydroxylation (AA) 1120
asymmetric catalysis 1114–26, 1131–3
asymmetric conjugate addition 1127–9
asymmetric Diels–Alder reaction 1108–9, 1112
asymmetric dihydroxylation (AD) 1120,
 1123–6
asymmetric epoxidation 1120–3
asymmetric hydrogenation 1117–19
asymmetric reduction, in nature 1150
 reduction, using CBS catalyst 1114–15
asymmetric reductive amination, in nature
 1150–1
asymmetric synthesis 1102–33
 by diastereoselective reactions of single
 enantiomers 871–6
 by reagent control 1113–14
 by resolution 1106–7, 1133
 by substrate control 1107–13
 from chiral pool compounds 872–6, 1107–
 10, 1112–13, 1131–3
 summary of methods (table) 1133
 with chiral auxiliaries 1107–10, 1112–13,
 1129–30, 1133
 with chiral catalysts 1114–29, 1131–3
 with chiral reagents 1113–14, 1133
asymmetry, and chirality 304
 in nature 1102–3
atomic emission spectroscopy 82–3
atomic force microscopy 81
atomic orbital 84–8
 2p 86
 2s 85
 factors affecting interactions between 98
 hybrid, sp 102
 sp² 100–102
 sp³ 99–100
atomic orbitals, combining 88
 effect of size, overlap and orientation on
 bonding 98
 energy of, difference between elements 95
 hybridization of *see* hybridization
atomic orbitals, nodes in 85–7
atoms, number in known universe 250
atorvastatin 11
ATP (adenosine triphosphate) 1135–6, 1153–4
Atropa belladonna (deadly nightshade) 1156
atropine 705–6, 1156
atropisomer 319
 BINAP 1118–20
 BINOL 1127
autoimmune diseases 1163
Avastin (bevacizumab) 1169–70
AX spectrum, in ¹H NMR spectra 286–9
AX₂ spectrum, in ¹H NMR spectra 289–91
axial and equatorial attack, by nucleophiles
 on six-membered rings 825–32
axial and equatorial conformers, energy
 difference 374–7
axial and equatorial hydrogens, in ¹H NMR
 415
axial and equatorial lone pairs in
 heterocycles 800–1
axial attack, of nucleophile in S_N2 380–1
 on cyclohexene oxides 837–9
 on cyclohexenes and cyclohexenones
 829–32
axial chirality 319–20, 322, 1118
axial substituents 371, 374–7
 preference in saturated heterocycles
 (anomeric effect) 801–2
 repulsion between 374–8
axial symmetry 320–1
aza-enolates, acylation of with acyl chlorides
 650–1
 alkylation of 593–4
 as specific enol equivalent 624, 632
 formation of 457, 593–4
 from hydrazones 650
azeotrope 228
azetidine, structure of 793
azide, as nucleophile in nucleophilic
 aromatic substitution 518
 as nucleophile in S_N2 353–4, 838–9
 cycloaddition with alkynes 776
 cycloaddition with nitriles 774
 explosiveness of 354
 reaction with triphenylphosphine 1176
 reduction to amines 353–4, 1176
azidothymidine *see* AZT
aziridine, in synthesis of oseltamivir
 (Tamiflu) 1176–7
 pK_a of 793
 reaction with acyl chloride 793
 ring strain and ring opening of 793
aziridines, electrocyclic ring opening of 929
 N-acyl, stretching frequency of C=O
 carbonyl in 794
 slow inversion at nitrogen 794
 synthesis by ring-closing reaction 805
aziridinium ion, formed during
 rearrangement of β-halo amine 938
azo compounds 350, 1006

- azobenzene 350
azoisobutyronitrile *see* AIBN
azoles 725
azomethine ylids 929
AZT (azidothymidine) 754, 1138, 1170–1
azulene 3
- B**
- back-bonding 1073
bacterial cell walls, amino acids in 1103, 1141–2
Baeyer, A. 953
Baeyer–Villiger oxidation, stereochemistry of 955
 which group migrates in 953–8
Baldwin, Sir Jack 810
Baldwin's rules 810–14
 exceptions to 812
 microscopic reversibility in 813
 summary chart of 814
Balmer, Johann 82
Bamford–Stevens reaction 1007–8
barium hydroxide, use as base in aldol reaction 615
barium sulfate, as support in catalytic hydrogenation 537
barrier, to bond rotation 362–3
 to reaction 108–9
Barton, Sir Derek 379, 686
base 165, 180
 choice for formation of enolate anion 585
 Lewis 180
 Schlosser's 1008, 1019
base accelerated sigmatropic rearrangement 914
base catalysis, general, evidence for 263–4, 1057–8
 general, features, summary of 1058
 of aldol reactions 615, 618
 of amide hydrolysis 213
 of enolization 452–4, 615, 618
 of ester hydrolysis 210–11, 262–4
 of hemiacetal and hydrate formation and decomposition 223–4
 specific (SBC) 1053
 evidence for 1055–6
 features, summary of 1056
base catalyst, (weak) pyridine vs (strong) hydroxide 200
base pair, in DNA 1137–8
bases, in nucleic acids 1136
 nitrogen and oxygen compared 177
 nitrogen compounds as 174–7
 p*K*_a of conjugate acid as measure of basicity 174–5
basicity 163–81
 and nucleophilicity, substitution at C=O and saturated carbon compared 355
 inductive effect on 792
 of DBU 741
 role in substitution at saturated carbon 331, 347–8, 355–6
Baumann, Eugen 203
Baylis–Hillman reaction 792
9-BBN *see* borabicyclononane
Beckmann fragmentation 959–60
 determination of mechanism 1065–6
Beckmann rearrangement 958–60, 1145
 anomalous 959–60
 in synthesis of biotin 905
bee pheromone 47, 51, 57–8, 294
 mass spectrum of 47
Beechams 178
beef tallow 212
belfosil 709
Bender, and evidence for tetrahedral intermediates 201–2
bending, of bonds in IR spectra 72
benzaldehyde, ¹H NMR spectrum 488
 in acetal protection of 1,3-diol 808
benzene 60–1
 ¹³C NMR and ¹H NMR spectrum 58–9, 60–1, 277, 473–4
 as nucleophile in conjugate addition 500
 bond length of C–C 295
 carbene insertion into 1018
 conjugation and aromaticity 143–4
 double bond equivalents in 75–6
 drawing 473–4
 heat of hydrogenation 157–8
 IR spectrum as evidence of bond order 70
 nitration of 475–6, 487–9
 NMR
 p*K*_a of 188
 reaction, with bromine 474
 with propionyl chloride 493–4
 with electrophiles 473–8
 region in ¹H NMR spectrum 277–81
 ring current in 277
 structure of 143–4, 473–4
 substituted, synthesis by Diels–Alder reaction 739–40
 sulfonation of 476–7
benzene diradical, by Bergmann cyclization 1088
benzene rings, naming compounds containing 36–7
benzenesulfonic acid 476–7
benzil 666, 950
benzilic acid rearrangement 950
benzocaine, ¹³C NMR spectrum 409
benzo-fused heterocycles, structure and reactions of 745–8
benzoic acid, as preservative 165
 IR spectrum of 67
benzotrile, ¹H NMR spectrum 488
benzophenone 619
 as indicator in THF distillation 981
benzoquinone, for reoxidation of palladium(0) 1097
benzyl allyl ethers, in [2,3]-sigmatropic rearrangements 917
benzyl chloride, alkylation by 586, 594
benzyl chloroformate, for protection of amines with Cbz 556–7 *see also* chloroformates
benzyl esters, as protecting groups 557
benzyl ethers, as protecting groups 551–2
benzyl groups, in ¹H NMR spectra 274–6
 susceptibility to hydrolysis 538–9
benzyl isoquinolines, alkaloid family 1159–61
benzylamine, in reductive amination 717
benzylic cations, in S_N1 reactions 337
benzylic halides, in substitution reactions 341–2, 346–7
benzyltriethylammonium chloride, phase transfer catalyst 585
benzyltrimethylammonium hydroxide (Triton B) 612
benzyne 523–6
 as intermediate, evidence for existence of 524, 1037–8, 1061
 bonding in 523
 Diels–Alder reaction with anthracene 893
 dimerization of 525–6
 formation of 523–4
 from diazotization of anthranilic acid 893
 nucleophilic addition to 523–6
 regiocontrol using 568
bergamotene, synthesis via semipinacol rearrangement 948
Bergmann cyclization 1088
beta-blockers 665, 703–4, 752
β-dicarbonyl compounds *see* 1,3-dicarbonyl compounds
β-emitter 1038
β-hydride elimination, in transition metal complexes 1077–82, 1096–8
β-hydroxyketones, retrosynthetic analysis of 713
β-keto esters *see also* 1,3-dicarbonyl compounds
 as product of Claisen condensation 643
 summary of formation 647
β-lactams 10
 by [2+2] cycloaddition of chlorosulfonyl isocyanate 898, 900–1
 by [2+2] cycloadditions of imines 900
 by rhodium-catalysed carbene insertion into N–H bonds 1023
 diastereoselectivity in reactions of 833
 in mode of action of penicillin 1142
 IR carbonyl stretching frequency 413
 NMR couplings in 816–17
 retrosynthetic analysis of 900
bevacizumab (Avastin) 1169–70
BHT (butylated hydroxytoluene), ¹H NMR spectrum 283
 ¹³C NMR spectrum 58
 IR spectrum 68
 synthesis by Friedel–Crafts alkylation 491
biaryls, chirality of 319–20
 synthesis via Suzuki coupling reaction 1086
bicyclic compounds, fused, spiro and bridged 653, 839
 stereoselectivity in 839–49
 elimination in 389–90
 synthesis by Diels–Alder reaction 879
bimolecular reactions 258–9
BINAP 319–20, 1118, 1119–20
BINOL 1127
biocatalysis 1132–3, 1149–68
biodiesel 6

- biological chemistry 1134–68
 mechanisms in 1149–56
- biosynthesis 1156–67
 of unsaturated fatty acids 1163
- biotin, synthesis of 661, 904–5
- bipy (2,2'-bipyridyl) 732
- Birch reduction 542–3, 973
 of alkynes 543
 of aromatic rings 542–3
 of enones 602–3
- Bismarck Brown 2
- bisulfite addition compound 138–40
- Bitrex 5
- Black, David St. C. 925–6
- Black, James 180
- bleach (sodium hypochlorite), as oxidizing agent 195, 1123
- blood clotting, biological messenger for 1139, 1156
- blood pressure, enzyme in control of 1140–1
- Bn, definition of 37
- Boarmate 1103
- boat conformation, in Diels–Alder reaction 888
 of cyclohexane 369, 370, 373–4
- Boc anhydride 558
- Boc protecting group 557–9, 739, 1172
- N-Boc pyrrolidine, asymmetric lithiation of 1113
- bold bonds 302
- boll weevil pheromone 1021
- bombykol, synthesis 692
- bond angle strain, Thorpe–Ingold effect on 808–10
- bond angles, in butane 365
 in ethane 364
 in propane 365
 in rings (table) 367
 in structural diagrams 18–19
 origins of 103
- bond dissociation energy (table) 971 *see also* bond strength
- bond energy *see* bond strength
- bond length, C=C, in alkene 144, 295
 C–C, in benzene ring 144, 295
 C–C, in butadiene 148
 C–C, in cyclooctatetraene 157
 C–C, in hexatriene 145
 C–C, in naphthalene 161, 295
 C–C, single bond 144, 295
 Cl–O 172
 C–N and C=N bonds 155
 C–O, in carboxylate anion 154
 C–Si 669
 N–CO in DMF 155
- bond order, in diatomic molecules 91
 in IR spectra 70
- bond polarization 183
- bond rotation 360–1
 effect of solvent on 256
 in NMR 58–9, 274
 influence of orbitals 105
- bond strength, anomeric effect on 803
 C–C 961
 C–H 961
 C–O 451, 961
 C=O and C–O 126, 154, 198, 208
 O–H 961
 P=O 238
 poor correlation with reactivity 207
 relative importance in radical reactions 971, 987–8
 S=O 665
 Si–X, compared with C–X 668
 S–X, comparison with other elements 657
 table of 971
- bonding electrons, as nucleophiles 113
- bonding orbital 88–91
- bonding, in transition-metal complexes 1070–3
 orbital overlap and 98
- bonds, hashed, bold, wedged, dashed, cross-hatched, or wiggly 302, 306, 680
 summary of types 97
- bongkreic acid 193
- 9-borabicyclononane 446
- borane, chemoselectivity of 531–3
 for reduction of amides 532–3
 for reduction of carboxylic acids 531–2
 shape of 103
 to reduce amino acids to amino alcohols 1105
- borane-oxygen method, in radical reactions 998–9
- boranes, for regioselective hydration of alkenes 446–7
 oxidation to alcohols of 446–7
- Borgia, Lucrezia 1156
- borohydride *see also* sodium borohydride
 as nucleophile 115
 reaction with carbonyl compounds 193, 251, 253
 reduction of ketone 119
 energy profile 251, 253, 257–8
- boron, energy level diagram 86
- boron enolate, control of geometry 870–1
 in asymmetric aldol reaction 1129–30
 radical formation of 999
- boron trifluoride, as electrophile 113–14, 117
 complexes of 794
- boron trifluoride etherate, as a Lewis acid 180, 662, 676
 in ring-opening of epoxides 794
- boronic acids and esters, use in Suzuki coupling 1085–7
- Bouveault–Blanc reduction 981
- bowsprit position 370
- brace device, use in drawing structures 628
- brackets, square *see* square brackets
- branched chains, names for 26
- branched structures 25–7, 36
- Bredt's rule 390, 914
- brefeldin A 549–50
- brevetoxin B 29–30
- bridged bicyclic compounds, compared with spiro and fused 653
 conformation of 839–40
 examples of 840
 lack of rotation in ¹H NMR 274
 stereoselectivity in 839–41
- bridged bicyclic halide, unreactivity in 335
- bridgehead alkene, from Cope rearrangement 914
 impossibility of 390, 914
- bridgehead carbon, in elimination reactions 389–90
 in bicyclic intramolecular aldol products 637–8
- Bristol Myers Squibb 1126
- bromide, alkyl 30 *see also* alkyl bromide
 synthesis from alcohol 348
- bromide, aryl *see also* bromobenzene
 synthesis from diazonium salts 522–3
- bromide, as nucleophile, in *trans*-diaxial opening of epoxide 849
 in conjugate addition 500
 in S_N2 reaction with ethers to form alcohols 351
- bromination *see also* bromine, reactions of
 and halogenation
 allylic, by radical methods 572–4, 989–90
 aromatic, regioselectivity of 479–80
 base catalysis of carbonyl compounds 462–3
 comparison of enols and alkenes 461
 in synthesis of oseltamivir (Tamiflu) 1178
 of alkanes 988–9
 of alkenes, in five-membered rings 836
 radical and ionic regiochemistry compared 573
 stereospecificity of 853
 via radical 971, 973
 of alkynes, reaction mechanism 1036
 of aniline 482
 of benzene 474
 of carboxylic acid derivatives 461–2
 of cyclopentadiene 579–80
 of enols and enolates 461–4
 of fluorobenzene 490
 of furan 736
 of fused bicyclic alkene, stereoselectivity of 844
 of ketones, selectivity in acid and base 463–4
 of nitrobenzene 488, 566–7
 of phenol 479–80
 of pyrrole 733
 of toluene 484–5
 of α,β-unsaturated carbonyl compounds 499
 stereospecificity of 853–4
 using catalytic pyridine 731
 with pyridinium tribromide 731
- bromine, as electrophile 115–16
 for bromination of carbonyl compounds 461–4
 isotopes in mass spectrometry 49–50
 reactions *see also* bromination
 with alkenes 427–9
 with dienes 435–6
 with enols and enolates 461–4
 use as test for alkenes 108
- bromine molecule, bonding in 116
- bromoalkane, as functional group 30 *see also* alkyl bromides
- bromobenzene, by *ipso* substitution of aryl silanes 673
 from bromination of benzene 731
 nitration of 489–90

- bromobenzene, by *ipso* substitution of aryl silanes (*continued*)
 oxidation by *Pseudomonas putida* 1103
 sulfonation of 490
- bromobutane, from reaction of *n*-butanol with PBr_3 329
- bromocarbonyl compounds, by bromination of enols and enolates 461–4
- bromoform *see* haloform
- bromohydrins, from bromonium ions and water 437
- bromolactonization, for regiocontrol 568–9
- bromonium ion 428
 N-bromosuccinimide *see* NBS
 regioselectivity of nucleophilic attack on 436–7
 stereospecific opening of 441–2
- bromoxynil 491
- Brønsted acid 165, 180
 chiral, use in asymmetric catalysis 1180
- Brønsted base 165, 180
- broperamole 775
- propirime 718
- Brown, H. C. 999
- Bu, definition of 23
- Buchwald–Hartwig cross-coupling reaction 1092–5
- Buckminster Fuller, Richard 25
- buckminsterfullerene ('buckyball') 25, 80–1
- Bürgi–Dunitz angle (trajectory) 860
- burimamide 179
- but-2-ene, barrier to rotation in 362
- butadiene, barrier to rotation in 362
 HOMO of, in Diels–Alder reaction 889–90
 in Diels–Alder reactions 882
 molecular orbitals of 146–8, 502
 reaction with bromine in methanol 580–1
 reactivity and stability compared with ethylene 147–8
- butadiyne, molecular orbitals of 683
 Z-alkenes from 683–4
- butan-1-ol *see n*-butanol
- butane, barrier to rotation in 366
 bond angles in 365
 conformation 365–6
 $\text{p}K_{\text{a}}$ of 188
- n*-butanol, ^{13}C NMR spectrum 62
 reaction with PBr_3 329
- butenal *see* acrolein
- butene, isomerization in acid 254
- butenolide (2H-furanone), butyl nitrite, as source of nitronium ion 521
 by E1cB elimination from lactone 400–1
 enolate from, diastereoselectivity in 834
 synthesis of, 1085
- butylated hydroxytoluene *see* BHT
- butyllithium *see also* alkylolithium
 as nucleophile in conjugate addition 505–6
 in ortholithiation 563–4
 reaction with furan 737–8
 reaction with thiophene 737
- C**
- $\text{C}=\text{O}$ *see* carbonyl
- C_2 axis of symmetry 320–1
- ^{13}C , ^{14}C *see* carbon-13, carbon-14
- ^{13}C NMR is indexed at carbon-13 NMR
- caesium, electronegativity of 612
- caesium carbonate, as base for conjugate addition of nitroalkanes 611–12
- caffeic acid 1155
- caffeine 750–1, 1136–7
- caffeyl quinic acid 1154–5
- cage *see* bridged bicyclic
- Cahn–Ingold–Prelog (CIP) rules 308
- calcium carbonate, as support in catalytic hydrogenation 537
- calcium hypochlorite, as oxidizing agent 195
- calicheamicin 29
- Callisto *see* leptospermone
- cAMP (cyclic AMP) 1139
- camphene, from Wagner–Meerwein rearrangement of isoborneol 943–4
- camphenilol, Wagner–Meerwein rearrangement of 942
- camphor 840, 1164
 diastereoselective reactions of 840
 oxidative cleavage of 841
- camphoric acid and anhydride 841
- camphorsultam, as chiral auxiliary 1113
- canadensolide, structure of 817
- Cane, David E. 1020
- Cannizzaro reaction 164, 620, 1031–4
 determining reaction mechanism 1031–4
- caprolactam, synthesis by Toray process 986
 synthesis of nylon from 958
- capsaicin 690–1
- captan 879
- captodative radicals 978
- caraway odour, (*S*)-(+)-carvone 1102–3
- carbamate, by Curtius rearrangement of an acid 1022
 from reaction of amine with chloroformates 728
- carbanions, [2,3]-sigmatropic rearrangements of 917–18
 sulfur-stabilized 660
- carbapenems 1023
- carbene complexes, ruthenium, in alkene metathesis 1023–7
- carbene equivalents 1017–18
- carbenes 1005, 1013–27
 alkyl substituted, 1,2-migration of hydrogen to 1018–20
 insertion to form cyclopropane 1019
 attack on lone pairs 1023
 α -carbonyl, rearrangement of 1021
 effect of method of formation on structure 1013
 evidence for existence of 1006
 Fischer 1007
 formation, by deprotonation of a cation 1009–10
 by α -elimination 1008–9
 by photolysis of diazomethane 1005
 from diazo compounds 745
 from diazocarbonyl compounds 1006–7
 summary 1027
 spin-flipping after 1014–15
 tosylhydrazones 1007–8
 insertion, into $\text{C}=\text{C}$ 1013–18
- into C–H 1018–20
 into O–H and N–H 1023
- linear 1011–12
- N-heterocyclic, as ligands in metathesis catalysts 1025
- reactions of 1013–27
 summary 1005
 with alkene to form cyclopropanes 1013–18
 with benzene 1018
- rearrangements of 1020–1
- singlet and triplet 1010
- singlet, orbital description of reaction with alkene 1015–16
- stabilization by substitution 1012–13
- stable 1006
- structure of 1010–13
- synthesis of 1005–10, 1013
 summary 1010
- carbenoid 1007
 comparison of -enoid reagents 1018
 in Simmons–Smith cyclopropanation 1017
- lithium, from dibromoalkane 1008–9
- rhodium, from diazo carbonyl 1007
- carbocations, [2,3]-sigmatropic rearrangements of 917–18
 ^1H and ^{13}C NMR spectra 335
 allylic, in $\text{S}_{\text{N}}1$ 336–7
 as intermediate in electrophilic additions 433–5
 in alkene isomerization 254
- benzylic, in $\text{S}_{\text{N}}1$ 337
- formation by migration 940
- formation using superacids 334–5
- heteroatom stabilization in $\text{S}_{\text{N}}1$ 338–9
- HOMO and LUMO of 941–2
- in electrocyclic reactions 927–8
- in $\text{S}_{\text{N}}1$ alkylation of silyl enol ethers 595
- intermediate in $\text{S}_{\text{N}}1$ 334
- involvement in $\text{S}_{\text{N}}1$ reactions (table) 339
- isopropyl, ^1H NMR spectrum 338
- primary, instability of 335
- rearrangement of 940–4
- shape and structure 334
- stability of 334–9, 394
- stabilization, by alkyl substituents 335–6
 by conjugation 336–9
 by silicon 672
tert-butyl, ^1H and ^{13}C NMR of 940–1
- tertiary, stability of 334–5
- carbohydrates 29, 1105, 1142, 1146
- carbometallation 1076, 1079–82
- carbon, allotropes of 80–1
 compared with silicon 668–74
- carbon-13, abundance of 50, 269
 in mass spectrometry 50
 isotopic labelling with, for elucidating biosynthetic pathways 1159, 1162
- ^{13}C NMR (carbon nuclear magnetic resonance) 54–69, 269–70, 408–9
 coupling in 416–18
 integration in 799
 interpretation of 62–3
 of compounds labelled with ^{13}C 417
 proton decoupled spectra 418
 regions of spectrum 56

- signal intensity in 56
 carbon-14, half-life of and use as radioactive label 1038
 isotopic labelling with, for elucidating biosynthetic pathways 1157
 carbon acids, pK_a of 176–7, 237
 carbon atoms, chemical synthesis of 745
 carbon chains, abbreviations 23
 branched 25–7
 drawing 22
 isomers of 26
 names for 23
 carbon dioxide, as solvent 480
 in primary metabolism 1134–5
 reaction with organometallics 190–1
 reaction with phenol 481–2
 supercritical, as solvent 1136
 carbon rings, naming 24
 carbon suboxide 878
 carbonates, allylic, Pd-catalysed addition to 1090
 electrophilicity compared with esters 644
 carbon–carbon bond formation
 asymmetric 1126–32
 by alkylation of alkynes 189
 by alkylation of enolates 584–613
 using aldol and Claisen reactions 614–655
 using organometallics 182–96
 using radical reactions 992–9
 using the Wittig reaction 237–8
 carbon–carbon bond length 144 *see also*
 bond length
 carbon–metal bond 183
 carbon–nitrogen bond length 155 *see also*
 bond length
 carbon–oxygen bond length 154 *see also*
 bond length
 carbon–oxygen bond strength 198, 451 *see also*
 bond strength
 carbonyl compounds, *see also* carbonyl group
 and *individual names of functional groups*: aldehydes, ketones, *etc.*
 acyclic, chelation-controlled attack on 862–5
 acyclic, diastereoselective reactions of 858–65
 addition of bisulfite 138–40
 addition of organometallic reagents to 133, 182, 187, 190–4, 216
 α -substituted, effect of substituent size on stereoselectivity 864–5
 α,β -unsaturated *see* α,β -unsaturated carbonyl compounds
 as nucleophiles 584–613, 614–655
 Bouveault–Blanc reduction to alcohol 981
 bromination of 461–4
 by oxidative cleavage of alkenes 443–4
 complete reduction to alkane 493–4
 conversion to epoxides with sulfonium ylids 665–7
 cyanohydrins from 125
 cyclic, effect of ring strain on reactivity 135
 electrophilic but non-enolizable 622
 enantioselective reduction of 1117
 enol equivalents in nature 1151–3
 enolization blocked in 617
 enolization of 451
 evidence for tautomerism of 451–2
 hydration of, equilibrium constants for 135
 acid/base catalysis of 137–8
 evidence from IR 135
 steric effects on 134
 IR spectra to distinguish between 70, 411
 lithium enolates of 587–90
 lowest energy conformations of 859–60
 models for stereoselective reactions of 859–62, 865
 most reactive conformer of 860, 861–2
 nitrosation of 464–5
 non-enolizable 454, 622
 nucleophilic addition to 125–140
 pinacol reaction of 981–4
 protection as acetals 228
 reaction, with alcohols 135–8, 197, 223–8, 247
 with amines to form enamines 233–4
 with amines to form imines 229–37
 with cyanide ion 125
 with enolates 614–54
 with phosphonium ylids to form alkenes 689–93
 with sodium borohydride 193, 251, 253
 with sulfur ylids to form cyclopropanes 666–7
 with tosyl azide 1006–7
 reactivity series towards nucleophiles 529
 reductive amination of 538
 self-condensation of, how to avoid 585–613
 substitution of ^{16}O for ^{18}O 223
 substitution of the carbonyl oxygen atom 222–3
 thioacetal formation from 662
 unsaturated, migration of double bonds by enolization 459
 carbonyl diimidazole (CDI), as electrophile 742
 carbonyl ene reaction 895–6
 asymmetric 1180
 carbonyl group *see also* carbonyl compounds
 ^{13}C NMR chemical shifts 408–9
 angle of nucleophile attack on 129–30
 as activating substituent in nucleophilic aromatic substitution 519
 as electrophile 114–15
 as functional group 30–1
 bond energies and bond lengths 126–7
 bonding and hydrosilylation in 103
 change in bond angle on nucleophilic attack 128–9
 conjugated *see also* α,β -unsaturated carbonyl compounds
 effects of reaction conditions on reactivity 489, 498–503
 effect of adjacent, on $\text{S}_{\text{N}}2$ reaction 341–2
 energy level diagram of 104
 HOMO–LUMO interactions in reactions of 126–7
 importance in organic chemistry 125
 IR, effects of ring strain and substituents 412–13
 table of frequencies 413
 lone pairs of 103
 molecular orbitals of 103–4, 126–7
 nucleophilic addition to 125–40
 polarization and reactivity of 104
 protection of 548–9
 reaction, with cyanide ion 125
 with organometallic reagents 132–3
 with water (hydrate formation) 134
 with sodium borohydride 130–2
 removal of via thioacetals 540
 substitution of $\text{C}=\text{O}$ 222–39
 substitution reactions at 197–221
 carbonyl oxide, intermediate in ozonolysis 443, 906
 carbonylation, by OXO process, palladium catalysed 1084–5
 transition metal catalysed 1076–7
 carbopalladation, in palladium catalysed coupling 1079, 1082, 1098
 carboxybenzyl *see* Cbz
 carboxyl group 31
 carboxylate anion, conjugation in 154
 in Cannizzaro reaction 620, 621
 neighbouring group participation by 934
 carboxylate salts, reaction with acyl chlorides 202
 reaction with organolithiums to form ketones 218–19
 carboxylic acid derivatives *see also individual functional groups*: esters, amides, *etc.*
 198
 bromination of 461–2
 identification by IR 206, 215, 411
 interconversion of, summary 215
 reactivity of 205–7, 215
 use of ^{13}C NMR to distinguish from aldehyde and ketone 408–10
 carboxylic acids, ^{13}C NMR chemical shifts of carbonyl 408–9
 acylation of 651–2
 alkylation of 589–90
 as functional group 31
 by amide hydrolysis 212–13
 by decarboxylation of malonate derivatives 596
 by ester hydrolysis 209–10
 by oxidation of alcohol 195
 by ozonolysis of alkenes 443–4, 907
 by Wolff rearrangement 1021
 chain extension by Arndt–Eistert reaction 1021
 conversion to acyl chlorides 214–15, 730
 Curtius rearrangement to amines 1022
 ene-diols from in acid solution 456
 enolates from 455
 from alcohols 546
 from aldehydes 546
 from nitriles 214, 586
 from organometallics and carbon dioxide 190–1
 IR spectrum of 67–8
 protection of 555–7
 reaction with alcohols under acid catalysis 208
 reaction with diazomethane 1003–4
 reduction to alcohols 531–2

- carboxylic acids, ^{13}C NMR chemical shifts of
 carbonyl (*continued*)
 tautomerism of 451
 tertiary substituted, from Favorskii
 rearrangement 952–3
 unreactivity towards nucleophiles 207
 γ,δ -unsaturated, by Ireland–Claisen
 rearrangement 914
- carnation perfume 706
- carone, in synthesis of nootkatone 967
 β -carotene 25–6, 28
 retrosynthetic analysis and synthesis of 708
 structure and conjugation 145–6
- carveol 195
- carvone 195, 1102–3
 ^{13}C NMR spectrum 409
 reaction with sulfoxonium ylids 667
- α -caryophyllene alcohol, synthesis via ring
 expansion rearrangement 944–5
- caryophyllene, synthesis via ring expansion
 964
- Casiraghi, Giovanni 1179
- cassava, cyanohydrins in 129
- catalysis, acid or base, of enolization 452–4
 of ester hydrolysis, kinetics and
 mechanism 262–4
 of hemiacetal and hydrate formation
 223–4
- acid, of acetal formation and hydrolysis
 224–8
 of aldol reaction 616
 of ester formation and hydrolysis 207–8
- asymmetric 1114–29, 1131–3
- base, of aldol reaction 615, 618
 of enolization 452–4, 615, 618
- chiral 1114–29, 1131–3
- DABCO in Baylis–Hilman reaction 792
- effect on activation energy 254
- general acid 1058–60
- general base 263–4, 1057–8
- Grubbs I, for metathesis 1025
- Grubbs II, for metathesis 1025
- homogeneous 1078–1101
- Hoveyda–Grubbs, for metathesis 1025, 1100
- in substitution reactions at the carbonyl
 group 262–3
- isomerization of butene by acid 254
- Lewis acid, of Alder ene reaction 895
 of Diels–Alder reaction 891
- ligand-accelerated 1126
- metal and organo- and compared 1128
- nucleophilic, iodide as, in $\text{S}_{\text{N}}2$ 358
- phase transfer, use in alkylation 585
- solvent as 256–7
- specific acid 262, 1053–5
- specific base 262, 1055–6
- stabilization of transition state by 254
- transition metal, concepts 1069–72, 1099
 gold 1099
 overview 1099
 palladium 1069–99
 ruthenium 1077, 1099–100
- catalysts, enzymes as 1132–3, 1149–68
- catalytic cycle, for Pd-catalysed nucleophilic
 displacement reactions 1089
 of Heck reaction 1080
 of OXO process 1077
- catalytic hydrogenation 534–9
 for removal of benzyl ether protecting
 group 551
 in synthesis of margarine 536
- metal catalysts for 535
- of acid chlorides 537
- of alkenes 535–7
- of alkynes 537
- of imines 538
- of nitro groups 538
- stereoselectivity of 535
- substrate reactivity series 539
- catecholborane, use in Suzuki coupling
 1085–6
- cation *see* carbocation
- cats, sleep inducing substance of 5
- CBS catalyst, synthesis of 1114–15
- Cbz (carboxybenzyl) protecting group 556–7,
 1172
 ^1H NMR spectrum 275
- CDCl_3 *see* deuteriochloroform
- CDI (carbonyl diimidazole) 742
- Cecropia* juvenile hormone 183, 191, 677–8
- cedrol 389
- cell membranes, components of 1147
- cell recognition, in nature 1142
- cell walls, amino acids in bacterial 1103
- cellulose 229, 1146–7
- centre, chiral 306–7
 stereogenic 306–7
- centre of symmetry 320–2
- cerium chloride, chelation by in reduction of
 chiral ketone 864
 effect on addition of borohydride to α,β -
 unsaturated ketones 506
- cerulenin, synthesis and ^1H NMR spectrum
 815
- cetaben 698, 700
- chain extension, by Arndt–Eistert reaction
 1021
- chain reactions, radical *see* radical chain
 reactions
- chair conformation, in transition state for
 aldol reaction 869–70
 in transition state for Claisen
 rearrangement 910–11
 of Alder ene transition state 896
 of cyclohexane 368, 370–3, 373–4
 of cyclohexanones, axial or equatorial
 attack on 826–32
- α -chamigrene, 604
- charge, conservation of 118
 role in reactions 108–9
- charges, drawing 21
 in brackets 251
- Chauvin, Yves 1025, 1084
- chelation control 862–5
- chelation, to stabilize tetrahedral
 intermediates 219
- cheletropic reaction 1015–16
- chemical ionization 46, 48
- chemical shift, effect of electronegativity on
 272
 in ^{13}C NMR 55–6
 in ^1H NMR 272–85
- relation to reactivity 280, 281
- terms used to describe 57
- variation of in ^1H vs ^{13}C 270
- chemoselectivity 528–61
 by kinetic control 546
 by thermodynamic control 546
- in acetylation of amine in presence of
 alcohol 529
- in aldol reactions 618, 619
- in hydrolysis of ester in presence of amide
 529
- in reactions of dianions 547
- in reactions of trianions 548
- in reduction, of aromatic rings in presence
 of carbonyl groups 537
 of carboxylic acids in presence of esters
 532–3
 of enolization 582
 of esters in presence of carboxylic acids
 532–3
 of ketone in presence of ester 529
 of salmefamol 530
 of α,β -unsaturated carbonyl compounds
 536
 problems of, in retrosynthetic analysis
 698–9
- chilli peppers, capsaicin from 690
- chiral, defined 303
- chiral auxiliary, in asymmetric aldol reaction
 (Evans aldol) 1129–30
 in asymmetric alkylation 1109–10, 1112
 in asymmetric Diels–Alder reaction
 1108–9
 removal of 1108
 use in asymmetric synthesis 1107–13,
 1129–30, 1133
- chiral Brønsted acids, use in asymmetric
 catalysis 1180
- chiral catalysts 1114–29, 1131–3
- chiral centre 306–7
- chiral drugs 325–6
- chiral ligand, (–)-sparteine 1113–14
 BINAP 118–20
 BINOL 1127
 DHQ and DHQD 1123–6
 diethyl tartrate (DET) 1120–2
 phosphoramidite 1127
 salen 1122–3
 TsDPEN 1115–17
- chiral memory, example of 835
- chiral objects, in everyday life 304–5
- chiral pool 1104–6
 asymmetric synthesis with 872, 873–5
 disadvantages of using 1106
 enantioselective syntheses with
 compounds from 1107–13, 1131–2
- chiral reagents, in asymmetric synthesis
 1113–14, 1133
- chiral reducing agent 1114–17
- chiral shift reagents 1111–12
- chiral stationary phase 325–7
 in determination of enantiomeric excess
 1111
- chiral sulfoxides 660
- chirality 302–6, 312–13
 axial, in BINAP 1118

- in nature 322–3, 1102–3
 planes and centres and axes of 322
- chitin, structure 1147
- chloral *see* trichloroacetaldehyde
- chloral hydrate 134–5
- chloramines 428
- chlorbenside 697–8
- chloric acid (HClO₃), pK_a of 172
- chloride, alkyl *see* alkyl chloride, alkyl halide
 aryl *see* chlorobenzene, halobenzene
 as leaving group from tetrahedral intermediate 200–1
 as leaving group in substitution of pyridines 728
 as nucleophile in conjugate addition 500, 504
- chlorination, of alkanes 986–8
 of aromatic compounds 481
 of α,β -unsaturated carbonyl compounds 503–4
- chlorine, isotopes in mass spectrometry 49–50
 photolysis of 986
- chloroalkanes *see* alkyl chlorides
- chlorobenzenes, nitration of 489–90
 synthesis from diazonium salts 522–3
- chloroform, as solvent for NMR *see also* deuteriochloroform 55
 α -elimination of 1009
- chloroformates, reaction with amines 728 *see also* methyl chloroformate, benzyl chloroformate
- chloroperbenzoic acid, *meta-see* m-CPBA
- 4-chlorophenol, pK_a of 176
- chlorophyll, structure and conjugation 149
- chloropyridines, from pyridones 729
- chlorosulfonic acid, reaction with toluene 485–6
- chlorosulfonyl isocyanate, in synthesis of β -lactam 898, 900–1
- chlorous acid (HClO₂), pK_a of 172
- chlorphedianol 711
- cholestanol 379
- cholesterol 949, 1147, 1167
- chromate ester 195
 [3,3]-sigmatropic rearrangement of 917
- chromatography, chiral 325–7
 use in determination of enantiomeric excess 1111
- chromic acid 194
- chromium, stable complexes of 1070
- chromium(VI) (chromium trioxide), as oxidizing agent 194–5
 for oxidation of alcohols 544–5
 for oxidation of tertiary allylic alcohol 916–17
- chrysanthic acid 25, 664
¹H NMR spectrum 292–3, 815
- chuangxinmycin 780, 798–9
- cigarette beetle 4
- cimetidine 178–80, 512, 723, 754
- cinchona alkaloids, in AD reaction 1123–6
- cinflumide 714
- CIP rules *see* Cahn–Ingold–Prelog rules
- cis* and *trans* coupling constants, and ring size 814–17
- cis* and *trans* dienophiles, Diels–Alder reactions 881–2
- cis* chrysanthic acid, ¹H NMR coupling in 815
- cis/trans* isomerization, of butene 254
- cis/trans* isomers 306, 311
- cis*-9,10-octadecenamide 5
- cis*-alkenes, from alkynes 537
- cis*-butenedial (maleic dialdehyde), from furan 736
- cis*-decalin 378–9, 845
 stereoselective reactions of 845–6
 substituted, by hydrogenation of Wieland–Miescher ketone 845
- cis*-enolate, effect on diastereoselectivity of aldol 868–71
- cis*-fused bicyclic rings, stereoselectivity in 842–6
- cis*-jasmone 2, 9, 547
- cis*-stilbene, epoxidation of 431
- citalopram 1103
- citral, industrial synthesis 915
- citrate synthase 1153
- citric acid 31, 1134–5
- citric acid cycle 1135, 1151–3
- citronellal, use in manufacture of (–)-menthol 896
- citronellol, synthesis of 1119
- citrus fruits, smell of 28
- CLA *see* conjugated linoleic acid
- Claisen condensation 640–55
 avoiding self-condensation during alkylation 589
 between ketones and esters 645
 compared with aldol reaction 640
 in biosynthesis 1165
 in heterocycle synthesis 769
 in retrosynthetic analysis 717
 intramolecular 652–4
 mechanism 640
 symmetry in 653–4
 to form 1,3-dicarbonyl compounds 766–7
- Claisen rearrangement 909–12
 aliphatic 910–11
 alkene geometry in 910–11
 γ,δ -unsaturated carbonyl compounds from 911–12
- clavicipitic acid 1098–9
- clavulanic acid, structure of 790
- cleavage, of alkenes, by ozonolysis 906–7
- Clemmensen reduction 494, 540, 568
- ‘click’ chemistry 776
- clobutinol 716
- clopirac, synthesis of 734, 760
- coal, as source of organic compounds 3
- CoASH *see* coenzyme A
- cocaine 5, 790, 793, 840
- coconut oil, principal component of 211
- COD *see* cyclooctadiene
- codeine 164, 793
 solubility of 164
- codon (triplet) 1139
- coenzyme A (CoASH) 1134–5, 1151–3
- coenzymes, definition of 44
- coffee, chemical responsible for smell and taste of 659
 instant, component of 1154
- collagen 1141
- collagenase inhibitor 1112–13
- Collins’ reagent 194
- collisions, between molecules 108
- colour, conjugation and 141, 148–9
- combination therapy, in treatment of AIDS 1171
- combustion, heat of, for alkanes 367–8
 for isooctane (petrol) 250
- Comins’ reagent 1079
- common names 38 *see also* trivial names
- common organic acids, pK_a of 172–3
- concentration effects, in radical addition 994–5
- condensation, aldol *see also* aldol condensation 617
- condensing enzyme 1162
- conditions, of reaction, choice of according to mechanism 329–32, 345
- configuration 306, 361–2
 absolute and relative 313
 assignment of (*E/Z*) 308
 assignment of (*R/S*) 308–9
 determination by NMR 796–7
 inversion of, in S_N2 343–4, 351, 352, 380–1
 retention of in Baeyer–Villiger oxidation 955
 retention of, in neighbouring group participation 932–4, 936–7
- conformation 306, 360–81
 effect on coupling constants 796–9, 802
 energy difference in staggered vs eclipsed 364, 366
 envelope, in five-membered rings 834
 half-chair (flattened chair) in cyclohexenes 829
 names for (in six-membered rings) 370–1, 373
 names for (open chain) 365–6
 of 1,3,5-triazine 804
 of acyclic acetals 804
 of acyclic structures 363–6
 of bridged bicycles 839–40
 of butane 365–6
 of chiral alkenes 865–6
 of chiral carbonyl compounds 859–60
 of chiral enolates 867–8
 of cyclobutane 369
 of cyclohexanes 374–9
 of cyclopentane 370
 of cyclopropane 369
 of esters 804–5
 of ethane 363–4
 of five-membered rings 370
 of fused bicycles 841, 842
 of norbornane 839–40
 of pentane 804
 of propane 365
 of ring structures 366–79
 of saturated heterocycles 796–805
 of spiroketals 803
 of sugars 801–2

- conformation (*continued*)
of sulfur stabilized anions 660
role in diastereoselective reactions 859–65
twist-boat 830
- conformational analysis 360–81
- conformational preference, in cyclohexene oxides 837–8
in five-membered rings 834–5
in four-membered rings 833
in six-membered rings 826–32, 837–9
- conformer 366
axial and equatorial, energy difference 374–7
in diastereoselective reactions of acyclic chiral carbonyls 860, 861–2
- coniine 790, 1156
- coniochaetone A and B, structure and ¹H NMR 818–19
- conjugate acid 167
- conjugate addition 499–511
1,3-relationship in 705
as 1,5-disconnection, retrosynthetic analysis of 719
asymmetric 1127–9
axial attack in six-membered rings 829–32
base catalysis of 503
chiral auxiliaries for 1113
diastereoselective, to unsaturated five-membered rings 834–5
equilibration of alkenes by 680
followed by alkylation 603–5
in synthesis of saturated heterocycles 762, 812–13
kinetic vs thermodynamic control 504–5
molecular orbitals in 502–3, 889
of 1,3-dicarbonyl compounds 606–7, 762
of alkyl radicals 998–9
of allylic sulfones 664
of butyllithium as nucleophile 505–6
of cyanide 504–5, 721
of enamines 608
of enolates 605–13
alkali metal enolates 607
anion-stabilizing substituents to promote 610
lithium enolates 607
regioselectivity in 605–6
thermodynamic control in 605–6, 607
of hydroperoxide ion 513–14
of nitroalkanes 611
of protected amino acids 610
of silyl enol ethers 608–9
of sodium borohydride 506
of tetrazole 775
potassium *tert*-butoxide as base for 607
rate of reaction 504–5
reactivity sequence 506
regioselectivity of 581–2
role of copper(I) salts 508–9
silyl enol ethers from 508
solvent for 503
summary of controlling factors 509–10
to enones 504, 603–5, 609
to nitriles 510, 610
to unsaturated nitro compounds 511, 610–11, 904
- conjugate addition, vs direct addition (1,2-addition) 504–7
effect of nucleophile 506–9
effect of reaction conditions 504–5
effect of structure 505–6
- conjugate base 167
in E1cB elimination 399
- conjugate reduction 603
- conjugate substitution 511–14
- conjugated carbonyl compounds *see* α,β -unsaturated carbonyl compounds
- conjugated linoleic acid 5
- conjugation 141–62
and delocalization, defined 145
and heteroatom stabilization of carbocations in S_N1 338–9
effect of solvents on 256
effect on barrier to bond rotation 362
effect on IR spectra 411–12
effect on LUMO of 1,2-dicarbonyl 643–4
effect on NMR 412
effect on radical stability 977–9
effect on reactivity of carbonyl group 205–7, 500–3
effects on enol stability 457–9
in alkenes, effect on ¹H NMR chemical shifts 280–1
in allyl cations 336–7
in amides 241–2
in aromatic rings, effect on ¹H NMR 278–80
in pyrrole 735
in thioesters and esters compared 1153
stabilization of carbocation by 336–9
stabilization of transition state in S_N2 reaction by 341–2
- conrotatory 925–6
- conservation of charge, in reaction mechanisms 118
- constant, equilibrium, definition of 242–3 *see also* equilibrium constant
- constitutional isomers 306
- contraceptive, oral 187, 949
- cooking, hydrolysis during 1145–6
- coordinatively saturated 1074
- coordinatively unsaturated 1074
- Cope rearrangement 913–17
- copolymerization 997
- copper, in acylation of Grignard reagents and organolithiums 218
in Sharpless synthesis of 1,2,4-triazoles 775
- copper iodide, use as co-catalyst in Sonogashira coupling reaction 1087–8
- copper(I) salts, for regioselective nucleophilic addition to allylic compounds 576
in reaction with diazonium salts 522–3
promotion of conjugate addition by 508–9, 603–5
transmetallation with 508–9
- coprostanol 379
- Corey, Elias James 1177
synthesis of oseltamivir (Tamiflu) by 1177–9
- Corey–Bakshi–Shibata catalyst *see* CBS catalyst 1114–15
- corgoine, synthesis of 793
- corylone (caramel and roast meat flavour) 9
- COT *see* cyclooctatetraene
- cotton, herbicide for 767
- coupling constant, a_{H} , in EPR 976
- coupling constant, J , in ¹H NMR 288
and conformation 796–9, 802
cis and *trans*, in rings 814–17
cis and *trans*, alkenes 293–4, 295, 299–300
factors affecting (summary) 294–5, 300–1
typical values of (table) 300–1
- coupling, in ¹H NMR 285–301
heteronuclear, in NMR 415–16
² J (geminal) 298–300, 817–24
AB pattern 822–3
and ring size 819–20
between diastereotopic protons 820–4
effect of π -contribution 820
in six-membered rings 819
² J and ³ J , influence on magnitude of (summary) 820
³ J (vicinal) 295, 300, 822–3
and Karplus relationship 796–8
and ring size 814–17
axial-axial 797–9, 802, 820
axial-equatorial 797–9
effect of dihedral angle on 796–8
in beta-lactams 816
in *cis* and *trans* chrysanthemoid acid 815
in cyclic acetals 797–8
in cyclic alkenes 814
in epoxides 815
in five-membered rings 817
in four-membered rings 815
in furans 817
in penicillins 816
in six-membered rings 797–9, 802
in saturated heterocycles 798
in thienamycin 816–17
in three-membered rings 815
orbital effects in 796–8, 800–1
⁴ J (*meta*, *W*, or allylic) in aromatic rings and alkenes 295–6, 301
allylic, in ¹H NMR 295–6, 301
in cyclic alkenes 814–15
long-range 295–6, 301
- coupling reaction *see* cross coupling
- Buchwald–Hartwig 1092–5
C–C, palladium catalysed 1079–88, 1098–9
C–N, palladium catalysed 1092–5
Heck 1069, 1079–81
of amino acids 747–8
of organometallics and halides 1082–8
palladium catalysed, summary 1088
- COX-2 inhibitor, synthesis of 1129
- cracking, of dimers and polymers 248–9
- Cram, Donald 936
- Cram's rule, for nucleophilic additions to carbonyls 860
- Crick, Francis 1137
- Crixivan *see* indinavir
- cross metathesis 1025–6
- cross-condensation, of esters 643
in aldol reactions 618
- cross-coupling reactions, palladium-catalysed 1082–8

- reactivity of halides and triflates 1083–4
crossed aldol reactions 619
 asymmetric 1131–2
 involving formaldehyde 620
crossover experiments 1038–9
crotonaldehyde 616
crotyl bromide 576
crude oil, as source of organic compounds 3, 6
cubane, IR and NMR spectra 420
 synthesis via Favorskii rearrangement 952
 α -cuparenone, synthesis via intramolecular C–H carbene insertion 1020
cuprates, in conjugate addition 509, 603–5
curly arrows 106, 116–24
 atom-specific 119, 131
 double headed 217
 fish hook, in radical reaction mechanisms 972
 in reaction mechanisms 120–4
 S-shaped for migration 940
 summary 120
 tips on drawing 267
Curtin–Hammett principle 860
Curtius rearrangement 882, 1022
Cyanamid 767
cyanide 31
 as functional group
 as leaving group 128
 as nucleophile in conjugate addition 500, 721
 as nucleophile towards carbonyl group 112
 bonding and molecular orbitals of 127
 reaction with formaldehyde 108
 reaction with imines to form aminonitriles 236
cyanine dyestuff 755
cyano group 31 *see also* nitrile
 as activating substituent in nucleophilic aromatic substitution 519
cyanoacetamide, IR spectrum 65
cyanoborohydride *see* sodium cyanoborohydride
cyanoethylation, with acrylonitrile 510
cyanohydrin 127–9
 enzymatic hydrolysis of 129
 from aldehyde and cyanide 121
 from carbonyl compounds 125
 in synthesis 128
 release of hydrogen cyanide from 129
 reversibility of formation 128
cyclamate 25
cyclic acetals, synthesis and stability 227–8, 247–8 *see also* acetals, cyclic
cyclic AMP (cAMP) 1139
cyclic hemiacetals, stability of 223, 247 *see also* hemiacetals, cyclic
cyclic molecules, effect on nucleophilicity of heteroatoms 791–2, 794
 reactions of, stereoelectronic effects in 801
 stereoselectivity in 825–51
cyclic nucleosides 1138–9
cyclic phosphate, in cAMP 1139
cyclic sulfate, from diol and sulfuryl chloride 1125
cyclic transition state, aldol reaction 625, 626
 for lithium enolate formation 625
cyclization, Baldwin's rules for 810–13
 by alkene metathesis 1023–4
 electrocyclic 922–3, 927
 of radicals 999–1002
 palladium catalysed 1091
cyclizine, synthesis of 791
cycloadditions 877–908
 [1+2], of singlet carbenes to alkenes 1015
 [2+2], in alkene metathesis 1024
 in synthesis of β -lactams 898, 900–1
 ketenes in 898–900
 photochemical 896–8
 thermal 898–901
 [3+2] 901–7 *see also* 1,3-dipolar cycloadditions
 as disconnection in heterocycle synthesis 772
 HOMO and LUMO in 901, 903
 intramolecular 902, 904–5
 of alkyne and nitrile oxide 773–4
 of azide and alkyne 776
 of azide and nitrile 774
 palladium catalysed 1091–2
 reverse, in decomposition of THF 795
 reverse, in ozonolysis 906
 stereochemistry of 902–5
 to form five-membered rings 901–5
 [4+2] 878–93 *see also* Diels–Alder cycloaddition
 ketene equivalents in 899
 of selenium dioxide and alkenes 919
 [4+3] 893–4
 [4+4], failure of 887, 893
 Diels–Alder 877–93 *see also* Diels–Alder reaction
 dimerization of dienes 880, 887–8
 entropy of activation in 1052
 for trapping reactive intermediates 893–4
 frontier orbital description 886
 meaning of square brackets 894
 of alkenes with osmium tetroxide 905–6
 of dienes and trienes 894
 palladium catalysed 1091–2
 photochemical 896–8
 reverse *see* reverse cycloaddition
 summary 907–8
cycloalkancarboxylic acids, synthesis of 598
cycloalkanes, ring strain in 368
cyclobutadiene 421
cyclobutane, conformation of 369, 833
cyclobutanone, diastereoselectivity in reduction of 833
 hydration of 135
 synthesis by [2+2] cycloadditions of ketene 898–900
cyclobutene, electrocyclic opening of 922, 923–4
cyclododecanone, ring expansion by fragmentation 964–5
cycloheptadiene, from [3,3]-sigmatropic rearrangement 915
 electrocyclic reaction of 922
cycloheptatrienyl radical, EPR of 976
cyclohexa-1,3-diene, in Diels–Alder reaction 880
cyclohexadienes, isomerization of 543
cyclohexane, ^1H and ^{13}C NMR spectra 60–1, 373–4
 barrier to ring-flipping 373–4
 how to draw 371–4
cyclohexanes, conformation of 368–9, 370–9
 coupling constants and dihedral angles in 796
 effects of conformation on E2 elimination 396–7
 reactions of 379–81, 826–9, 837–9
 stereoisomerism in 376–8
cyclohexanol, pK_a of 173
cyclohexanone, ^1H NMR spectrum 293
cyclohexanones, alkylation of 589
 conformational preference in 827
 equatorial vs axial attack 827–9, 832
 equilibration and conformational preference of 826, 837–9
 how to draw 827
cyclohexene, ^1H NMR and ^{13}C NMR spectra 277, 280
 heat of hydrogenation 157–8
 reaction with hydrogen bromide 433
cyclohexene oxides, conformational preference in 837–8
 regioselectivity of ring opening 836–9, 873
 stereochemical requirements for formation by $\text{S}_{\text{N}}2$ 836–7
cyclohexenes, and cyclohexenones, axial attack on 829–32
 barrier to inversion 829
 by E1 elimination 389
 conformational preference in 829
 reactions of 830–2, 850–1
 stereoselective epoxidations of 856
cyclohexenol, reaction with HBr 336
cyclohexenones, axial attack on, in conjugate addition 831–2
 as products of Robinson annelation 639
cyclohexyl halides, E2 elimination from 396–7
cyclooctadiene, electrocyclic ring closure of 928
cyclooctatetraene, as metal ligand 1071
 dianion and dication 158–9, 160
 heat of hydrogenation 157–8
 structure and bond length of 157, 160
cyclooctene, heat of hydrogenation 157–8
cyclopentadiene, [1,5]-sigmatropic hydrogen shifts in 919
 bromination of 579–80
 dimerization 248–9
 HOMO and LUMO of 920–1
 hydroboration of 446
 hydrochlorination of 579
 in Diels–Alder reactions 880–1, 884, 1108–9
 in synthesis of longifolene 650
 monoepoxidation of 432
 stable anion from 162
 substituted, by fragmentation reaction 920

- cyclopentadienyl anion 162
 as intermediate in E1cB elimination 401
 as ligand, σ or π complex 1071
- cyclopentane, conformation of 370
- cyclopentanone, enamine formation from 650
 from Nazarov cyclization 927
 pseudoequatorial vs pseudoaxial attack of nucleophiles on 834
 substituted, from intramolecular C–H carbene insertion 1019
- cyclopentenes, diastereoselectivity of electrophilic addition to 835–6
- cyclopentenones, diastereoselectivity in 834–6
 synthesis from 1,4-dicarbonyl compounds 759
- cyclophane 662
 [7]-*para*-, ^1H NMR spectrum 278
- cyclopropane, conformation of 369
 examples of compounds containing 1016
- cyclopropanes, [3,3]-sigmatropic opening of 915
 as intermediate in Favorskii rearrangement 951–2
 by alkylation of conjugate addition product 607
 by intramolecular alkylation 586
 by Simmons–Smith reaction 1017
 formation from carbenes and alkenes 1013–19
 from sulfur ylid and unsaturated carbonyl compound 666–7
 palladium-catalysed formation of 1091
- cyclopropanone, hydration of 135
- cyclopropyl cation, electrocyclic ring opening of 928
- cyclization, Nazarov 927
- cypermethrin 128
- cysteine 555
 in glutathione 1140
 stereochemistry of 1103
- cytidine, modified for HIV treatment 1138
- cytosine 1136
 ^1H NMR spectrum 285
- D**
- 2,4-D *see* dichlorophenoxyacetic acid, 2,4-
- D,L nomenclature 310–11
- D_2O *see also* deuterium oxide
 as NMR solvent 272, 284–5
- DABCO (1,4-diazabicyclo[2.2.2]octane), $\text{p}K_{\text{a}}$ of 791
 in the Baylis–Hilman reaction 792
 structure of 840
- Dacron (polyester) 210
- Dakin reactions 954
- damascenone 4
- daminozide 695
- dapsone 140, 657
- Darvon 326, 1103
- Darzens reaction 639
- dashed bonds 302
- dative bond 110
- dba *see* dibenzylidene acetone
- DBU (1,8-diazabicyclo[5.4.0]undec-7-ene) 175
 as base in E2 elimination 387
 basicity of 741
 in E2 elimination 391
- DCC (dicyclohexylcarbodiimide), in amino acid coupling 747–8
- DDQ (dichlorodicyanoquinone) 3
 in oxidation of dihydropyridine 764
- DEAD (diethyl azodicarboxylate) 39
 in Diels–Alder reaction 884
 in Mitsunobu reaction 349–50
- deadly nightshade (*Atropa belladonna*) 705–6, 1156
- Dean–Stark head 228, 245
- decaffeination process 1136
- decalin, conformation of 378–9, 637
 ring expansion of 963–4
- decamethrin 11, 1016
- decarbonylation 1077–8
- decarboxylation, of 1,3-dicarbonyl compounds 596–8, 606, 630, 654
 of pyrrole 735
 of sodium trichloroacetate 1009
 spontaneous, after aldol reaction 630
 using sodium chloride (Krapcho reaction) 597–8
- decomposition, and entropy 249
- deformation frequencies, of bonds in IR spectra 72
- degradation, to determine structure and configuration 310–11, 1037
- dehydration, of aldol product 616
 of alkenes 389
- dehydrogenase, enzyme 1150
- delocalization 141–62
 and conjugation, defined 145
 effect of solvents on 256
 effect on reactivity of carbonyl group 205–7
 effect on reactivity of oxime 232
 importance in enolate stability 629–30
 in alkenes, effect on ^1H NMR 280–1
 in amide bond 241–2
 in aromatic rings, effect on ^1H NMR 277–80
 in imidazole 741
 in pyridine 726
 in pyrrole 733
 in triazoles 743
- δ , in NMR 273 *see also* chemical shift
- denatonium benzoate *see* Bitrex
- deoxycytidine 1171
- deoxydaunomycinone 445–6
- deoxyribonucleic acid 1136–8 *see also* DNA
- deoxythymidine 1170
- deprotonation, irreversible in Claisen condensation 641
 of alkynes with strong base 170–1, 176, 187
 of phenols with potassium carbonate 173
- derivatization, for determination of structure 232
- deshielding 55
 in benzene 277
- desilylation, electrophilic 73
- Dess–Martin periodinane 545
- DET *see* diethyl tartrate
- determination of absolute configuration 310–11
- determination of mechanisms 1029–68
- deuterated solvents, for NMR 272
- deuteration, of phenol 472
- deuterium, exchangeable, in ^1H NMR 275, 284–5
 incorporation as evidence of enolization 451–2
 isotopic labelling with 811
 for elucidating biosynthetic pathways 1162, 1166
- deuterobenzene, as solvent for NMR 272
- deuteriochloroform (CDCl_3), as solvent for NMR 55, 272
- deuteromethanol, as solvent for NMR 272
- Dewar benzene 143
- dextrorotatory 310
- DHP *see* dihydropyran
- DHPP (dihydroxyphenylpyruvate) 1159
- DHQ (dihydroquinine), as chiral ligand 1123–6
- DHQD (dihydroquinidine), as chiral ligand 1123–6
- diamond, atomic structure 81
- dianions, chemoselective reactions of 547
 of acetoacetate derivatives, regioselective alkylation of 601
- diastereoisomers 311, 313, 315, 852
 and enantiomers, distinction between 313–16
 chirality of 312–13
 different chemical properties of 376
 drawing and interpretation of 855–6, 859
 from aldol reaction 626
 from stereoselective reactions 855–6
 from stereospecific reactions 853–5
 separation by chromatography 312, 323
- diastereomers *see* diastereoisomers
- diastereoselectivity 825–76
 importance of conformational control 859–65
 in acyclic compounds 852–76
 in enantiomerically pure compounds 871–6
 in rings 825–51
 β -lactones and cyclobutanones 833
 bridged bicyclic 840
 cyclohexanones 826–9, 832
 cyclohexenes 829–32
 cyclopentanones 834
 cyclopentenes 834–6
 fused bicyclic 841–2, 844–5
 summary 851
 of aldol reactions 868–71
 of alkylation of butenolides 834–5
 of alkylation of enolates 603, 604–5
 of Diels–Alder reactions 881–9
 of electrophilic addition to acyclic alkenes 865–8
 of electrophilic addition to cyclic alkenes 835–6
 of nucleophilic addition to chiral carbonyl compounds 858–65
- diastereotopic, definition of 821
 faces 850, 856

- diastereotopicity 820–4
in acyclic compounds 822–3
diaxial interactions 374–7
1,4-diazabicyclo[2.2.2]octane *see* DABCO
1,8-diazabicyclo-[5.4.0]-undecene-7 *see* DBU
diazo transfer agent 1007
diazocarbonyl compounds (diazoketones),
synthesis and formation of
carbenes from 1006–7, 1021
in Wolff rearrangement 1021
diazomethane 3, 350
formation, structure and reactivity of 1004
photolysis of to produce carbenes 1005
reaction with acyl chloride 1006–7
reaction with carboxylic acid 1003–4
reaction with phenol 1004
ring expansion using 949, 953
diazonamide A 45
diazonium salt 495, 521
alkyl, semipinacol rearrangement of
948–9
nucleophilic aromatic substitution on
520–3
stability and decomposition of 252
synthesis of 521
diazotization 521
of 2-aminobenzoic acid 893
of amino acids 1105
of anilines 252, 521–3, 566–7
DIBAL (diisobutylaluminium hydride) 26, 39
for reduction of esters and amides 533
for reduction of lactones to hemiacetals
533
for reduction of nitriles to aldehydes 534
dibenzoyl peroxide, as radical initiator 571,
971, 985
homolysis of 971
radical elimination of 974
dibenzylidene acetone (dba) 680, 1078
dibromoalkane, α -elimination of 1008–9
dibutylamine, pK_a of 792
dicarbonyl compounds *see also* diketones,
keto acids, keto esters, and
malonates
1,2-, by nitrosation 464
from acyloin reaction 983
1,3- *see also* β -keto-esters, malonates
acidity of 595
alkylation of 595–8
as specific enol equivalent 624, 628
conjugate addition of 606–7, 762
decarboxylation of 596–7
from Claisen condensation 766–7
in synthesis of pyrazole 760, 768, 769
in synthesis of pyrimidine 760, 770–1
Knoevenagel reaction of 629–30
 pK_a of 629
reaction with acetamide to form
pyridones 766–7
reaction with anilines to form
quinolines 781
reaction with hydroxylamine 772–3
retrosynthetic analysis of 717
stability of enol form 457–8
1,4-, from Friedel–Crafts acylation of
succinic anhydride 722
from nitroalkane conjugate addition
product 612
in cyclopentenone synthesis 759
in furan synthesis 759
in pyrrole synthesis 758
in thiophene synthesis 759
retrosynthetic analysis of 721–2, 760,
770
1,5-, from conjugate addition of enolates
608–9
in synthesis of pyridine 759, 765–6
retrosynthetic analysis of 719
1,6-, by ozonolysis 444
 β *see* dicarbonyl compounds, 1,3-
dichloroacetyl chloride, ketene from 899
dichloroalkane, α -elimination of 1008–9
dichlorocarbene, by decarboxylation of
sodium trichloroacetate 1009
dichlorodicyanoquinone *see* DDQ 3
dichloroketene 455, 899–900
dichloromethane, unreactivity of 804
dichlorophenoxyacetic acid. 2,4- (2,4-D) 481,
696, 697
diclofenac potassium salt, mass spectrum of
49–50
dictyoptereine 1016
dicyclohexylcarbodiimide *see* DCC
dieldrin 881
dielectric constants, of common solvents
(table) 256
Diels, Otto 878
Diels–Alder reaction 877–93 *see also*
cycloaddition, [4+2]
and Alder ene reaction, compared 894–5
chiral auxiliary-controlled 1108–9
effect of solvent 888
enantioselective 1108–9, 1112, 1177–8
in retrosynthetic analysis 882
intramolecular 888–9
kinetic and thermodynamic control in
884–5
Lewis acid catalysis of 891
mechanism of 878–9
molecular orbital diagram of 886
of pyrones 739
of thiophene sulfone 739
preference for *endo* product 884–5, 887–8
recognizing products of 881
regioselectivity in 889–91
reverse electron demand 887
stereochemistry of 881–4
transition state of 878, 885
with aromatic heterocycles 738–40
Woodward–Hoffmann rules applied to
892–3
dienes, and 1,3-dipoles, difference between
901
bromination of 435–6
by ene-yne metathesis 1026–7
by reduction of aromatic compounds
542–3
dimerization by cycloaddition 880, 887–8
electrophilic addition to 435–6
in Diels–Alder reaction 886–91
monoepoxidation 432
reaction with hydrogen bromide 435
stereochemistry of, in Diels–Alder reactions
882–9, 921
stereospecific synthesis via Suzuki coupling
reaction 1086
by oxypalladation 1097
dienone-phenol rearrangement 949–50
specific acid catalysis in 1054
which group migrates in 956
dienophiles 880–1
chiral 1108
HOMO and LUMO of 886–91
stereochemistry of 881–2, 884–9
diethyl adipate 245
diethyl azodicarboxylate *see* DEAD
diethyl carbonate, in Claisen condensations
645
in crossed ester condensation 643
diethyl ether, as nucleophile 117
from acid-catalysed reaction of ethanol
121–2
stability in the presence of organolithiums
795
use of ‘ether’ as trivial name for 37
diethyl fumarate, conjugate addition to 606
diethyl malonate *see* malonates
diethyl oxalate, in Claisen condensations 645
in crossed ester condensations 643
in Reissert indole synthesis 779
diethyl tartrate (DET), in asymmetric
epoxidation 1120–2
diethylaluminium chloride, as Lewis acid for
asymmetric Diels–Alder 1108
diethylamine, pK_a of 792
diethylzinc, asymmetric addition to an
aldehyde 1126–7
difluoroacetic acid, pK_a of 176
difunctional compounds, 1,2-, retrosynthetic
analysis of 720
dig nomenclature, in Baldwin’s rules 810
dihedral angle 364, 796
effect on coupling constants in 1H NMR
796–8
dihydrofolate synthase 754
dihydrofolic acid 753
dihydropteroate synthase 753
dihydroxypropan, for protection of alcohols 469
dihydropyridines, as heart drugs 764–5
from Hantzsch synthesis 763–4
oxidation of 763, 764
dihydroquinidine (DHQD), as chiral ligand
1123–6
dihydroquinine (DHQ), as chiral ligand 1123–6
dihydroquinoline, from α,β -unsaturated
carbonyl compounds and aniline
781
dihydroxyacetone 1151
dihydroxylation 442–3, 905–6
asymmetric 1120, 1123–6
by opening of epoxide 442
of alkene by osmium tetroxide 442–3,
905–6
stereospecificity of 442–3
dihydroxyphenylalanine *see* dopa
dihydroxyphenylpyruvate (DHPP) 1159
diisobutylaluminium hydride *see* DIBAL
diisopropylamine, for synthesis of LDA 588

- diketones *see also* dicarbonyl compounds
 1,2-, LUMO of 643–4
 rearrangement of under basic conditions 950
 synthesis by nitrosation of enols 464–5
 1,4-, formation of cyclopentanone from 738
 from hydrolysis of furan 736–7, 738
 in synthesis of pyridazine 759–60, 767–8
 1,5-, reaction with hydroxylamine to form pyridines 765–6
 1,6-, from reduction of acylated thiophene 737
- diketopiperazine 321
- dimedone, tautomerism 457–8
- dimerization, effect of temperature on equilibrium in 248–9
 of carbonyl compounds 616–18
 of dienes by Diels–Alder cycloaddition 880, 887–8
 of ketyl radicals 981, 983–4
- 1,4-dimethoxybenzene, ¹H NMR spectrum 271
- dimethyl fumarate, as dienophile in Diels–Alder reaction 882
 by inversion of dimethyl maleate 679
 physical properties 677
- dimethyl maleate, as dienophile in Diels–Alder reaction 882
 physical properties 677
 synthesis from maleic anhydride 679
- dimethyl malonate *see* malonates
- dimethyl phosphite, ¹H NMR spectrum 416
- dimethyl sulfate 340, 769
 O-methylation of enolate by 467
- N,N*-dimethylacetamide *see* DMA
- dimethylallyl pyrophosphate 1166
- N,N*-dimethylaminopyridine *see* DMAP 726
- dimethylbenzene *see* xylene
- dimethyldioxirane (DMDO), epoxidation with and mechanism of 432
 oxidation of furan with 736
- N,N*-dimethylformamide *see* DMF
- dimethylsulfide, as nucleophile 116
 for reduction of ozonide from ozonolysis 443, 907
- dimethylsulfoxide *see* DMSO
- 2,4-dinitrophenylhydrazine, synthesis of 516
- diols, 1,1- *see* hydrates
 1,2- and 1,3-, selective protection of 808
 by asymmetric dihydroxylation 1123–6
 by bacterial oxidation of aromatic rings 1103
 by dihydroxylation 442–3, 905–6
 by opening of epoxide with water 442
 by pinacol reaction 981
 conversion to epoxides, with retention of stereochemistry 1125–6
 from alkenes and osmium tetroxide 442–3, 905–6
 from asymmetric epoxidation of allylic alcohols 1120–2
 reaction with carbonyl compounds to form acetals 228, 247, 346–7
 rearrangement of 945–6
 retrosynthetic analysis of 720
syn 442–3
- dioxane, as solvent 790, 794
- dioxolane 227–8, 247, 429
 as protecting group, for ketone 548–9
 for 1,2-diol 808
- diphenylmethane, synthesis of 492–3
- 1,3-dipolar cycloaddition *see* cycloaddition, [3+2]
- dipolarophile, definition of 901
- 1,3-dipole, and diene, difference between 901
 definition of 901
 linear 902–3
- dipole moment, effect on IR spectra 71
- dipoles, role in reactions 108–9
- diradical 681
- disaccharide 229, 1146
- Discodermia* 1130
- discodermolide, synthesis of 1130–1
- disconnection approach *see* retrosynthesis
- disconnection 695
 1,1 C–C 709–11, 716, 720
 1,2 C–C 707–9, 714, 719
 1,2-diX 702–5
 1,2-NO 715
 1,3-diCO 717, 766, 769
 1,3-diO 712–14, 716, 718, 762, 766
 1,3-diX 705, 710, 715–17
 1,3-NO 715, 718, 766
 1,4-diCO 721–2, 760, 770
 1,5-diCO 719, 762
 C=N imine 701–2, 781
 C–Br alkyl halide 718
 C–C 706–11, 716
 C–N amide 695, 696, 701–2, 708, 714, 717, 769, 779
 C–N amine 698, 700, 716, 718, 1122
 C–N imide bond 719
 C–O acetal 715
 C–O ester 698, 707
 C–O ether 696, 699, 704, 708, 717, 1122
 C–P 709
 C–S sulfide 697–8, 768
 C–X 695–706
 Diels–Alder 882
 guidelines for 697–9, 706, 709
 of ketones 710
- disiloxane, by hydrolysis of silyl enol ether 469
- disparlure 5, 1121
- Dispersol 9
- disrotatory 925–6
- dissociation, of acids 169
 of hydrogen chloride, into ions vs radicals 970
- dissociation energies (table) *see also* bond strength 971
- dissolving metal reductions 540–3, 602–3
- disulfides 658, 659
 from thiols, in nature 1140
- dithianes 661, 662, 663, 795
 as acyl anion equivalent 663, 795
 from dithiols 662, 633
 hydrolysis of 663
- dithioacetal 227, 238, 657, 662 *see also* dithiane, thioacetal
- dithiolane, decomposition of 795
- diversity orientated synthesis 1180
- Djerassi, Carl 950
- D-line, of sodium lamp 310
- DMA (*N,N*-dimethylacetamide), slow bond rotation in 256
- DMAP (*N,N*-dimethylaminopyridine), as catalyst for acylation 726
 p*K*_a of 740
 structure of 726
- DMDO *see* dimethyldioxirane
- DMF (*N,N*-dimethylformamide) 39
¹³C NMR spectrum 156, 409
¹H NMR spectrum 274, 282
 as electrophilic source of formyl (–CHO) group 219–20
 as solvent for S_N2 reactions 344, 345, 352, 586, 596
 barrier to bond rotation in 362
 in Vilsmeier reaction 734
- DMP *see* Dess–Martin periodinane
- DMS *see* dimethylsulfide
- DMSO (dimethylsulfoxide), as solvent 39, 255, 345, 586, 597
 in Swern oxidation 667–8
- DNA (deoxyribonucleic acid) 80, 1136–8
 and RNA, stability compared 1138–9
- Dolabella* (sea-hare), anticancer agent from 861
- dolastatin, synthesis from isoleucine 861
- donor synthon 712, 719–20
- dopa (L-dopa, dihydroxyphenylalanine) 1103, 1159
 industrial synthesis of 1118
 synthesis by Baeyer–Villiger oxidation 954
- dopamine 1160
- double anomeric effect 803
- double bond equivalents 75–6
- double bond isomers 306, 311 *see also* geometrical isomers
- double bond, region in IR spectrum 65, 70–1
- double bonds, carbon–carbon *see* alkenes
- double isotopic labelling, in determining mechanisms 1038–9
- double-headed curly arrows 217
- doublet, in ¹H NMR 285, 287–8
- doublet of doublets, in ¹H NMR 292–3
- doublet of triplets, in ¹H NMR 293–4
- doxipicoline 715
- drawing 17–22
 π complexes, in transition metal complexes 1071
 acyclic diastereomers 859
 bicyclic structures 839–40
 bonds, in transition metal complexes 1071
 cyclohexanes 371–4
 cyclohexanones 827
 decalins 371–2
 guidelines for 17–22
 norbornane 839–40
 shorthand 19
 spiroacetals 803
 structures with stereogenic centres 309
 drugs, synthesis, on industrial scale 1119, 1113, 1133
 chiral 325–6, 1103
 dsp orbital 1073

- du Vigneaud 555
 Duff reaction 1179–80
 dyes 9, 755
 and pigments, defined 149
 dynamic NMR 374
- E**
- E/Z* isomers 306, 311
 E1 elimination *see* elimination, E1
 E1cB elimination *see* elimination, E1cB
 E2 elimination *see* elimination, E2
 Earl Grey tea, aroma of 948
 eclipsed conformation 363–4
 ecstasy *see* MDMA
 ectocarpene 915
 EDTA (ethylenediaminetetraacetic acid), ¹H
 NMR spectrum 284–5
 ee *see* enantiomeric excess
 eicosa-8,11,14-trienoic acid 1163
 eicosanoids 1163
 18-electron rule 1070
 electrocyclic reactions 922–30
 photochemical 926–7
 rules for 923–5
 stereochemistry of 925–6, 929
 Woodward–Hoffmann treatment of 923–4
 electromagnetic radiation, wavelength 64
 electromagnets, in NMR spectrometer 53,
 277
 electron, as a particle and as a wave 83
 in orbital 83–4
 mass of 51
 spin of 84
électron célibataire 974
 electron distribution, effect in NMR 55
 in aromatic rings 278–9
 electron donating groups, effect on radical
 stability 978–9
 effect on S_N1 vs S_N2 346–7
 electron donation, from alkyl groups 484
 electron impact ionization 46–8
 electron paramagnetic resonance 975–6
 see also EPR
 electron transfer 973
 electron withdrawing groups, effect on
 aromatic chemical shifts 488
 effect on electrophilic aromatic
 substitution 487–9
 effect on radical stability 978–9
 effect on S_N1 vs S_N2 346–7
 electronegative atoms, effect in Felkin–Anh
 model 861–2
 in electrophiles 114–15
 electronegativity, and ¹H NMR chemical
 shifts 272
 and polarization of carbonyl group 126–7
 effect on coupling in ¹H NMR 295, 300
 effect on molecular orbitals 96
 effect on NMR chemical shift 55–6, 422
 of metals 183
 of sulfur 657
 origin of and trends in 95
 summary of common elements 114
 table of values *see periodic table in endpapers*
 of book
 electronic effects, in S_N1 and S_N2 346–7
 electronic structure, of carbenes 1011–12
 electrophiles 109
 allylic, activated by palladium 1088–92
 choice for alkylation (table) 587
 effects of structure on determining S_N1 vs
 S_N2 (table) 347
 empty orbitals as 113
 epoxides as 351–2, 354
 ethers as 351
 for alkylation of enamines 592–3
 for conjugate addition of enolates 605–13
 for S_N1 alkylation of silyl enol ethers 595
 hard and soft 507
 how to identify 113, 120
 non-enolizable carbonyls as 622
 silicon as 632
 sulfonium salts as 664
 types of 113–16
 electrophilic addition, comparison of
 benzene and cyclohexene 474
 of bromine to fused bicyclic alkene 844
 of water to alkene 444–5
 regioselectivity of 433–5
 stereospecificity of 853
 to alkenes 427–48
 stereospecificity of 439–42
 stereoselectivity of 439, 865–8
 strategies for regiocontrol 570
 summary 447
 to cyclic alkenes, diastereoselectivity of
 835–6
 to dienes 435–6
 to dienes, regioselectivity of 579
 to enols 464–5
 electrophilic alkenes 498–514 *see also*
 alkenes, electrophilic; conjugate
 addition
 electrophilic arenes 514–26 *see also* aromatic
 compounds, electrophilic;
 nucleophilic aromatic substitution
 electrophilic aromatic substitution 471–97
 as disconnection in heterocycle synthesis
 769
 blocking groups 565
 bromination 474, 488, 490
 chlorosulfonation 485–6
 choice of solvent 480
 combined effects of substituents 491–2
 compared with electrophilic addition 474
 competing effects of substituents 491–2
 conjugating substituents, effect of 486–9
 diazotization 566–7
 directing groups in, order of precedence
 491–2
 effect of steric hindrance 483
 effect of substituents, alkyl 484–6
 electron withdrawing 486–9
 halogen 489–90
 nitro group 487–9, 566–7
 nitrogen 482–3
 oxygen 479–82
 trifluoromethyl 487
 energy profile 478
 evidence for mechanism 475
 Friedel–Crafts acylation 493–4
 Friedel–Crafts alkylation 492–3
 inductive effect in 483
 intermediate in 474–5
ipso, with arylsilanes 672–3
 kinetic and thermodynamic control of
 regioselectivity 566
 nitration 486–90, 492
 of activated pyridines 729–30
 of alkyl benzenes 484–6
 of aniline 482–3
 of benzene 473–8
 of furan 735
 of halobenzenes, comparisons between
 490
 of indole 745–6
 of isoquinoline 749
 of phenols 472–3, 479–82
 of pyridine 726–7
 of pyrroles 733–5
 of quinoline 749
 of thiophene 735
 position of substitution 563
 rate determining step 475
 regioselective *ortho* substitution 563–4
 regioselectivity of 483–7, 563–7
 relative rates 482
 sulfonation of toluene 485–6
 sulfonation to control regiochemistry 565
 summary of directing and activating
 effects and groups 491
 summary table of products 495–6
 summary table of reactions 478, 496–7
 trapping of intermediate 1060–1
 electrophilic radicals 995–7
 electrophilic substitution, of vinyl silanes
 673–4
 electrophilicity, of carboxylic acid derivatives
 205–7
 of esters and carbonates compared 644
 electrospray ionization 46, 48
 electrostatic attraction, role in reactivity
 108–9
 unimportance in S_N2 355–6
 elimination,
 α, in synthesis of carbenes 1008–9
 of alkyl halides 1008–9
 of chloroform 1008–9
 of dihaloalkanes 1008–9
 E1 386–8
 acid catalysed 383–4
 compared with alkene isomerization 434
 competition with S_N1 reaction 467–8
 effect of polar solvents 389, 393–4
 example of substrates 388
 of alcohols 389, 616
 rate equation 386
 regioselectivity of 391–4
 stereoselectivity of 855, 391–3
 strength of base required 388–7
 to form *E*-alkenes 684
 transition state for 392–4
 E1cB 399–404
 base catalysis of 399–400
 enolate intermediate in 399
 equilibrium constant for deprotonation
 401
 favoured by delocalization 400

- elimination (*continued*)
 for enone or enal formation 616
 from aldol product 616
 from Mannich product 621
 in mechanism of Fmoc deprotection 559
 in nature 1154, 1156, 1162
 leaving groups in 400
 of β -halocarbonyl compounds 400–1
 rate determining step and rate equation 401–2
 regio and stereoselectivity 402, 569
 stabilization of intermediate 401
 to form *E*-alkenes 684
- E2 382–3, 386
 anti-periplanar transition state of 395–7
 effects of base on regioselectivity of 398–9
 effects of steric hindrance 395
 evidence for reaction mechanism 396–7
 examples of substrates 388
 for making alkynes 398
 from cyclohexanes, effects of conformation 396–7
 in diene formation 387
 of alkyl halides 383, 385–7
 of vinyl halides to give alkynes 398
 rate equation for 383, 386
 regioselectivity of 398–9
 stereoelectronic effects in 801–2
 stereospecificity of 395–6, 853
 with basic nucleophile 382–3
- 'Hofmann's rule' 399
 Peterson 671
 radical 974
 reductive *see* reductive elimination
 'Saytsev's rule' 399
 step in acetal formation 225
- elimination reactions, comparison of E1, E2, and E1cB 402
 effects of concentration 386
 effects of nucleophile 384–5
 effects of steric hindrance 385–7
 effects of temperature 385–6
 entropic effects 385–6
 in bicyclic structures 389–90
 leaving groups in 390
 stereoselective 678, 684–93
 vs substitution reactions 384–6, 404–5
- elimination–addition mechanism, in benzyne reactions 523–6
- enals 500 *see* α,β -unsaturated aldehydes
- enamines 233–4
 [3,3]-sigmatropic rearrangement of 916
 ^1H NMR spectrum 280–1
 acylation of with acyl chlorides 650
 addition to carbonyl compounds 591–3
 alkylating agents for 591–3, 650
 as specific enol equivalents 608, 624, 632
 axial attack on 830–1
 formation 233, 591, 791
 thermodynamic control over 592
 from lysine, enolate equivalent in nature 1151–3
 nucleophilicity compared to enolates 591
 stability 233
 tautomeric forms 456–7
- enantiomeric excess, measurement of 1110–12
 enantiomerically enriched 1110
 enantiomerically pure 308
 enantiomers 303, 309, 313, 315, 852
 and diastereoisomers, distinction between 313–16
 difference between 5, 309
 in nature 322, 1104–6
 separation of 322–7
- enantioselective *see also* asymmetric enantioselective synthesis 1102–33
 enantiotopic 821
 faces, definition and examples of 856
 endiandric acids 925–6
endo face, in bridged bicyclic compounds 840
endo nomenclature, in Baldwin's rules 810
endo selectivity, in Diels–Alder reaction 884–5, 887–8, 1108–9
- ene reaction 894–6 *see also* Alder ene reaction
 enediolate, from acyloin reaction of esters 983–4
- ene-diols, from carboxylic acids 456
 ene-dienes 1088
 energy, activation *see* activation energy
 energy, of intermediates and transition states 250–3, 320–3
 energy barriers 108–9
 relation to rate of bond rotation 363
- energy difference, between axial and equatorial conformers 374–8
 between *E*- and *Z*-alkenes 265
- energy level diagram, of helium molecule 91
 of hydrogen molecule 89
 of interaction between electrophile and nucleophile 111
 of nitric oxide (NO) 96
 of nitrogen molecule 94
- energy levels, in NMR 53, 270, 287–91
 of electrons in atoms 82–3
- energy minima, local and global, defined 370
 energy profile diagram 241–65
 of $\text{S}_{\text{N}}1$ reaction 334
- ene-yne metathesis 1026–7
 enol borinate *see* boron enolate
 enol equivalents, enamines as, in conjugate addition 608
 for aldehydes (and ketones) 591–5
 in nature 1151–4
- enol esters 642
 enol ethers *see also* silyl enol ethers
 by acetal decomposition 467–8
 by methylation of enolate 467
 comparison with alkenes and ethers 469
 coupling constants in ^1H NMR of 280–1, 295, 300
 from aldehyde 467–8
 from Diels–Alder cycloadditions 890
 from enols and enolates 466–8
 hydrolysis of 468
 reaction with alcohols 469
- enol form, of carbonyl compound 450
see also enols
- enol, specific equivalent of 624 *see also* enols;
 specific enol equivalents
- enolate equivalents 465–6 *see also* specific enolate equivalents
- for aldehydes 632
 for ketones 634
- enolates 449–70
 alkali metal, conjugate addition of 607
 alkylation of 584–613, 760–1
 summary of methods (table) 612
 regioselective 590, 592, 595–7, 598–604, 613
 stereoselective 603, 604–5, 844–5, 867–8, 1110
- anion stabilizing substituents to promote conjugate addition of 610
- as intermediates in E1cB elimination reactions 399–404
- as nucleophiles 453, 460–8
 axial attack on six-membered ring, 831–2
 base catalysed bromination of 462–3
 by base catalysed enolization 452–4
 charge distribution in 453
 chiral, conformation of 867–8
 stereoselective alkylation of 867–8, 1110
- cis* and *trans* 869
 condensation with ethyl formate 771
 conjugate addition of 605–13
 control of regiochemistry by use of enones 601–5
 cyclization of, in Favorskii rearrangement 952
 equilibration of 600
 for aldol reaction and acylation at carbon, summary (table) 652
 formation of, by conjugate addition 503, 603–5, 792
 choice of base 454–6, 595
 kinetic and thermodynamic control 599–601, 634–6, 654
 geometry of, controlling 869–1
 effect on diastereoselectivity 868–71, 1132
- lithium *see* lithium enolates
 molecular orbitals of 453
 of aldehydes, problems with 590
 of amides 455
 of diethyl malonate 629
 of esters 454–5, 631
 of ketones, regioselectivity in formation 454, 601
 of β -lactones 833
 of malonic acid 629–30
 preference for alkylation at C or O 466–8, 590
 reaction, with acyl chlorides 453
 with alkyl halides 453
 with carbonyl compounds 614–54
- silyl enol ethers as stable enolate equivalents of 466–7
 sodium and potassium 589
 stability of, influence of substitution 599, 610
 stable equivalents 465–6 *see also* specific enolate equivalents
 summary of types 453
 synthons representing 712
- enolization 450–1
 acid catalysed 452, 461

- as mechanism for racemization or epimerization 459–60, 826
- base catalysed 452–4, 615, 618
- chemoselectivity of 582
- impossibility of 454, 622
- migration of double bonds by 459
- nitrogen analogue of in imine/enamine equilibrium 234
- of amino acids 460
- requirements for 456
- substituents preventing (table) 622
- enols **449–70** *see also* enolates
 - as intermediates in conjugate addition 503–4
 - as nucleophiles 460–8
 - as reaction intermediates 460–8, 503–4
 - bromination, comparison with alkenes 461
 - equivalents of *see* specific enol equivalents
 - from 1,3-dicarbonyl compounds 457–8
 - from esters 631
 - nitrosation of 464–5
 - reaction at oxygen 466–8
 - regioisomeric 454
 - stability of 451, 457–9
 - sulfenylation of 470
 - summary of types **453**
 - tautomerism in 457–8
- enones 500 *see also* α,β -unsaturated ketones
 - by elimination of sulfoxides 684–5
 - by palladium catalysed oxidation of silyl enol ethers 1097
 - conjugate addition to 603–5, 609
 - formation by E1cB elimination 616, 621
 - formation by Mannich reaction 621
 - reaction with hydroxylamine 419
 - reductive alkylation of 601–5
- enophiles 895
- enoyl-ACP reductase enzyme 1162
- enthalpy, ΔH , in intra- and intermolecular reactions 247
 - and equilibria, 246–9
- entropy, ΔS , 246–7
 - and decomposition 249
 - and equilibria 246–9 as a factor in the formation of hemiacetals and acetals 247–8
 - in intra- and intermolecular reactions 247
- entropy of activation, in cycloadditions 1052
- in epoxide opening 1052–3
- in ring closing reactions, relation to size 806–7
- 'E-numbers', common preservatives 165, 168
- envelope conformation, of five-membered rings 370, 834
- enyne, by Sonogashira coupling reaction 1087–8
- enzymes 309, 1134–5
 - aldolase 1151–3
 - aminotransferase 1151
 - angiotensin-converting (ACE) 1140–1
 - β -ketoacyl-ACP reductase 1162
 - citrate synthase 1153
 - condensing 1162
 - enoyl-ACP reductase 1162
 - glycosidase 1145
 - ketoreductase 1132
 - liver alcohol dehydrogenase 1150
 - protease 1170
 - pyridoxal transaminase 1159
 - as catalysts 1132–3, 1149–68
 - directed evolution of 1180
- ephedrine 314–15, 1105
 - as resolving agent 1106–7
- epibatidine 739, 740
- epichlorohydrin, regioselectivity of attack 703–4, 785, 1064–5
- epimerization 1112
- epimers 1112
- epinephrine *see* adrenaline
- episulfonium ion (thiiranium ion) 665
- epoxidation *see* alkenes, epoxidation
 - asymmetric 1120–3
 - enzymatic, in metabolism 432–3
 - Houk model for 866–7
 - Jacobsen 1122–3, 1126
 - of allylic alcohols, stereoselectivity of 850–1, 856, 867
 - of α,β -unsaturated carbonyl compounds 513–14
 - chiral alkenes, stereoselectivity of 866–7
 - of cyclic alkenes, stereoselectivity of 835–6, 840, 843–4, 850, 855
 - of homoallylic alcohols 856
 - reagents for 429–33, 513–14
 - regioselective, of dienes 432
 - stereospecificity of 854–5
 - with vanadyl acetoacetate 850–1
- epoxides, ^1H NMR coupling in 815
 - acid-catalysed opening of 438–9
 - as electrophiles in $\text{S}_{\text{N}}2$ reactions 351–2, 354
 - by ring closure 437, 1126
 - entropy of activation in opening of 1052–3
 - from alkenes 429–33, 513–14 *see also* epoxidation; alkenes, epoxidation
 - bromoalcohols (bromohydrins) 437, 1126
 - diols 1125–6
 - electrophilic alkenes 513–14
 - α -halocarbonyl compounds 640
 - sulfur ylids 665–7, 744
 - fused to six-membered rings, axial attack on 836–9, 873
 - in 1,2-disconnections 703
 - opening of 351–2, 354, 438–9, 838–9, 1120–3
 - regioselectivity 438–9, 1125
 - specific base catalysis 1055
 - stereospecificity of opening of 854
 - Payne rearrangement of 938–9
 - pinacol type rearrangement of, to form aldehydes 946
 - rate of formation by ring-closing reaction 808–9
 - reaction with alcohols to form ethers 703–4
 - with base 438
 - with bromide 439
 - with hydrazine 704
 - with imidazole 742–3
 - with thiol 121–3
 - with triazole 743
 - with amines 439
- epoxidizing agents 429–33, 513–14
- epoxyketone 513
 - in Eschenmoser fragmentation 965
- EPR (electron paramagnetic resonance) 975–6
 - drawbacks of using for mechanistic determination 1034
 - for observation of carbenes 1006, 1010
- equation, Arrhenius 257
- rate 257–62
- equatorial and axial attack, on six-membered rings 825–32
- equatorial and axial conformers, energy difference 374–7
- equatorial and axial hydrogens, in ^1H NMR 415
- equatorial attack, impossibility for cyclohexenes 829–32
- equatorial substituents 371, 374–7
- equilibration, as means of stereochemical control 826, 829, 832
 - of enolates 600
 - of non-conjugated and conjugated alkenes 679–81
- equilibrium **240–9**, 264–6
 - constant 242–3
 - acidity (K_{a}) 169
 - relationship to equilibrium composition 243–4
 - variation with temperature 248–9
 - variation with ΔG 243–4
 - between acetal and carbonyl compound 226, 247
 - between axial and equatorial conformers 374–8
 - between hemiacetal and carbonyl compound 223, 247
 - control of 208–10, 244–6
 - enthalpy and 246–9
 - entropy and 246–9
 - parasitic 618
- erectile dysfunction, drug for treatment of 768–70
- ergosterol, photochemical [1,7]-sigmatropic shift of 922
- erythronolide A 187
- erythrose 4-phosphate 1155
- Eschenmoser fragmentation 965
- Eschenmoser rearrangement *see* orthoamides
- Eschenmoser, Albert 965
- Eschenmoser's salt 621
- Escheweiler–Clarke method 716, 778
- esomeprazole 11
- ESR *see* EPR
- essential oils 1164
- esterification 208
 - using pyridine as nucleophilic catalyst 726
- esters 31
 - ^{13}C NMR chemical shifts of carbonyl 408–9
- reagents for synthesis 429–33, 513–14
- ring strain in 351–2
- sensitivity to acid 432
- spiro 432
- stereochemical requirements for formation by ring closure 836–7
- vinyl, synthesis 1090

- esters (*continued*)
 acyloin reaction of to form α -hydroxyketones 983–4
 aldol reactions of, controlling 631–2
 alkylation of 589, 595–8, 613
 by Arndt–Eistert carbene homologation of acid 1021
 by Baeyer–Villiger oxidation of a ketone 953–8
 by Favorskii rearrangement of α -halo ketones 950–2
 chemoselective hydrolysis in presence of amide 529, 557–8
 Claisen condensation of 645
 compared with carbonates 644
 lactones 804–5
 thioesters 1153
 conformation and stereoelectronic effects 804–5
 enol equivalents of 631–2
 in nature 1151–3
 enolates from 454–5, 588
 ethyl and *t*-butyl, as protecting group 555–6
 formation of, stereochemical issues 351
 from alcohols and acyl chlorides 198–9, 258–9
 alcohols and anhydrides 198–9
 alcohols and carboxylic acids under acid catalysis 208, 244–6
 alcohols, summary 209
 diazomethane with carboxylic acid 1003–4
 γ,δ -unsaturated, synthesis by Claisen rearrangement 912
 hydrolysis of 206
 chemoselective 546–7
 Hammett relationship in 1041–4
 mechanism in acid and base 209–12, 262–4, 1053, 1056
 specific acid/base catalysis 1053, 1056
 study of mechanism by isotopic labelling 211
 variation of rate with pH 262
 in conjugate addition reactions 606, 607, 610
 IR for identification of 411
 molecular orbitals of 804–5
 neighbouring group participation by 932–3
 non-enolizable 643
 reaction with amines 203–4
 reaction with base 454–5
 reaction with organolithium or Grignard reagents 216–17, 297–8, 710
 reduction, to aldehydes with DIBAL 533
 to alcohols with lithium aluminium hydride 217, 531
 to alcohols with lithium borohydride 531
 retrosynthetic analysis of 695, 698, 707
 reversibility of formation 208–9, 244–6
 smell and taste of 31
tert-butyl as protecting group 556
 Et, definition of 23
 η , hapto number, definition 1070
 ethane, barrier to rotation in 362
 bond angles in 364
 bonding and molecular orbitals 100, 116
 conformation of 363–4
 ethane-1,2-diol *see* ethylene glycol
 ethanoic acid *see* acetic acid
 ethanol, ^{13}C NMR spectrum 55
 metabolism of 28
 pK_a of 172
 ethene *see* ethylene
 ether 29, 37 *see also* diethyl ether
 ethers, allylic, sigmatropic rearrangement of 909–18
 as electrophiles in $\text{S}_{\text{N}}2$ reactions 351
 by reaction of alcohols and epoxides 703–4
 by reaction of alcohols with sulfuric acid 173–4
 cleavage by Lewis acids 351
 cyclic, by intramolecular oxypalladation 1097
 increased reactivity with Lewis Acids 794
 ring-opening of 794
 from alcohol and alkyl halide 338, 340
 from phenols 173, 1004
 neighbouring group participation by 934–5
 retrosynthetic analysis of 696, 698, 699, 704, 708, 717
 trityl 337
 ethoxide, as base 596, 642
 ethyl acetate 37
 in Claisen ester condensation 641
 ethyl acetoacetate, alkylation of 596
 as specific enol equivalent 629
 in Robinson annelation 639
 synthesis of by Claisen condensation 642
 ethyl acrylate, ^1H NMR spectrum 299
 ethyl benzoate, in crossed ester condensations 643
 ethyl chrysanthemate 1017–18
 ethyl ester, as protecting group 555
 ethyl formate, in crossed ester condensation 643, 771
 ethyl group, ^1H NMR spectrum 292
 ethyl octadecanoate 6
 ethyl stearate 6
 ethyl vinyl ether, ^1H NMR spectrum 300
 ethylene glycol (ethane-1,2-diol) 228, 247
 dehydration of 457
 ethylene oxide 429, 794
 ethylene, bonding in and molecular orbitals of 100–1, 142
 ethylenediaminetetraacetic acid *see* EDTA
 ethyne, bonding in 102 *see also* acetylene
 ethynylolestradiol 187
 eukaryotes 1141
 Evans' aldol reaction 1129–30
 Evans' auxiliary 1108–13, 1129–30
 evolution, directed, in enzyme development 1180
 exact mass, atomic, of common elements 51
 exaltone, synthesis by ring expansion 964–5
 exchange, of acidic protons in ^1H NMR 283–5
 rate of, in NMR (equation) 374
 excited state, in atomic emission spectroscopy 82
 of alkene 897
 exclusion principle, of Pauli 84
exo face, in bridged compounds, definition of 840
exo nomenclature, in Baldwin's rules 810
exo product, from Diels–Alder reaction 884
exo-brevicomine, synthesis by Eschenmoser fragmentation 965
exo-methylene carbonyl compounds 609, 621
 exoskeleton, of insects and crustaceans 1147
 explosives 354, 744–5
 extraction, acid–base 164–5
- F**
 ^{19}F NMR, use in analysis of enantiomeric excess 1111–12
 farnesol 187
 fats, hydrolysis of 211–12
 saturated and unsaturated 536, 1148
 structure of 31
 fatty acids 17, 211–12, 1161
 biosynthesis 1161–3
 unsaturated 1162–3
 Favorskii rearrangement 950–3, 1061–3
 Feist's acid, structure determination of 318–19
 Feldene *see* piroxicam
 Felkin–Anh model 859–62, 874
 effect of electronegative atoms in 801, 861–2
 felodipine, structure and synthesis 765
 fenarimol 192
 fenfluramine 702
 fenpiprane 710
 fentiazac 772
 ferrate salts, in AD reaction 1123–6
 ferrocene, structure 1072
 FGI *see* functional group interconversion
 fialuridine 12
 field strength, in ^1H NMR, and effect on spectra 288–9
 fingerprint region 72
 first-order kinetics 259–60, 329–31
 Fischer carbenes 1007
 Fischer esterification 208–9
 Fischer indole synthesis 775–80
 [3,3]-sigmatropic rearrangement in 916
 recognizing substitution pattern from 778–9
 Fischer projections 316
 Fischer, Emil 775–6, 1084
 Five-membered rings, by intramolecular radical reactions 1000–1
 by [3+2] cycloadditions 901–5
 conformation of 370, 834–5
 diastereoselective reactions of 835–6
 rate of formation 806–7
 flagstaff position 370
 flattened chair *see* half-chair
 flavour chemistry, terpenoids in 274
 flavouring, synthetic 9
 Fleming, Ian 913
 Fleming–Tamao, oxidation 673
 flexibilene, by intramolecular McMurry reaction 983
 flipping *see* ring flipping, spin flipping
 fluconazole, structure and synthesis 744
 fluorenylmethoxycarbonyl *see* Fmoc

- fluoride, alkyl, as functional group 30
fluoride, as leaving group in nucleophilic aromatic substitution 515, 518
fluorine atom, energy level diagram of 86
fluorine, coupling to ^{19}F in NMR 416–17
fluoroacetic acid, pK_a of 176
fluoroalkane, as functional group 30
fluorobenzene, ^{13}C NMR spectrum 416
 bromination of 490
 nitration of 489–90
5-fluorouracil 1169–70
flupirtine, synthesis of 728
Fmoc protecting group 559
folic acid, structure and biological synthesis 753–4
formaldehyde, failure of aldols with 620
 hexamethylenetetramine from by reaction with ammonia 1179
 hydration of 133–5
 molecular orbitals of 126–7
 reaction with cyanide 108
 reaction with organometallics 191
 salicylaldehydes by reaction with phenols 1179
 use in Mannich reaction 620
formalin 620
formate esters, ^1H NMR spectrum 282
 pyrolysis of 968
formate ion, as reducing agent 620
formic acid 37
 as a reducing agent and hydrogen source 716, 1115–17
 as weak nucleophile and solvent 345–6
foscarnet 12
four-membered rings, and ^1H NMR 816–17
 by [2+2] cycloadditions 897–901
 by double alkylation of 1,3-dicarbonyl compounds 598
 conformation of 369, 833
 fragmentation in synthesis of nootkatone 967–8
 from benzyne 525–6
 rate of formation 806–7
 stereoselective reactions of 833
FR-900848 ('jawsamycin'), structure of 1016
fragmentation, in mass spectrometry 48
fragmentation reactions 931, 959–69
 Beckmann 959–60
 effect of bond polarization on 960–2
 effect of stereochemistry on 962–4
 entropy of activation in 1052
 Eschenmoser 965
 in caryophyllene synthesis 964
 in ring expansion reaction 963–5
 in synthesis of nootkatone 966–9
 of small rings 961
 orbital interaction in 962–3
 push and pull effect in 961–2
 retro-aldol 962
 stereoelectronic effects in 801
fredericamycin, lithiation in synthesis of 564
free energy, ΔG 243–4, 246–9
 effect on equilibrium constant 243–4
Friedel–Crafts 492–4
Friedel–Crafts acylation, advantages over alkylation 493–4
 intramolecular 494
 of benzene 477–8
 of furan 735
 of thiophene 735, 737
 on pyridine, lack of 727
 phosphoric acid as catalyst of 494
 regioselectivity of 568
 with anhydrides and cyclic anhydrides 494, 722
 with succinic anhydride 722
Friedel–Crafts alkylation, asymmetric 1128
 in synthesis of BHT 491
 multiple substitutions 492–3
 of benzene 477–8
 problems with 492–3
 rearrangement of alkyl halides during 493, 945
 synthesis of diphenylmethane 492–3
Friedel–Crafts disconnection 720, 722, 782
frontalin, structure and ^1H NMR spectrum 822
frontier orbitals *see also* HOMO, LUMO
 in [1,5]-sigmatropic hydrogen shifts 920–1
 in [3,3]-sigmatropic rearrangements 913
 in conjugate addition 502, 889
 in cycloadditions 886–7
 in radical additions 995–6
fructose, from glyceraldehyde and dihydroxyacetone 1151
fruit fly, pheromone of 803
fruity peony perfume 710–11
Fukui, Kenichi 892
fumaric acid 105, 311
functional group interconversion (FGI), in retrosynthetic analysis 699–702
 in amine synthesis 700–2
 of alkenes 707
functional group removal, halogen, by tributyltin hydride 493–4, 539–43, 991
functional groups 16, 27–33
 drawing 19, 21
 effect on NMR chemical shift (table) 423–5
 effect on radical stability 978–9
 naming 35
 oxidation level of 33
furan 735–8
 acetal formation from 736
 as diene in Diels–Alder reaction 880, 884
 bromination of 736
 by via lactone reduction 761
 electrophilic aromatic substitution on 735
 exo adduct from Diels–Alder reactions of 739
 Friedel–Crafts acylation of 735
 from 1,4-diketone 738, 759
 hydrolysis of 736
 lithiation of 737–8
 maleic dialdehyde (*cis*-butenedial) from 736
 nitration of 735–6
 NMR couplings in 817
 oxidation of by DMDO 736
 regioselectivity in reactions of 735
 retrosynthetic analysis of 758–60
 structure and reactivity of 735–8
furanose 1143
furfural 737
furonol 9
fused bicyclic compounds, *cis* and *trans* 841–2
 compared with spiro and bridged 653
 conformation of 378–9, 841, 842
 stereoselectivity in 841–6, 848–50
- G**
GAC *see* general acid catalysis
galactosamine 1147
galvinoxyl 975, 998–9
 γ,δ -unsaturated carbonyl compounds, by Claisen rearrangement 911–12
garlic, taste and smell of 37
gas chromatography, use in analysis of enantiomeric excess 1111
gas constant, *R* 243
gasoline, combustion energy 250
gauche (synclinal) conformation 365–6
gauche effects, in acyclic acetals 804
gauss, as unit of coupling in EPR 976
GBC *see* general base catalysis
GC *see* gas chromatography
geminal (?) coupling *see* coupling
general acid catalysis, evidence for 1058–60
 in acetal hydrolysis 1059
 in nature 1059
 of orthoester hydrolysis 1059
general base catalysis 263–4
 evidence for 1057–8
 in acetylation 1057–8
 in nature 1059
 in synthesis of alkenes, summary of 693
geometrical isomers 306, 311
 calculating energy difference between 265
 control of 681–93
 equilibration in acid 254, 264–6
 of imines and oximes 231
 properties of 677–8
geometry *see also* alkene geometry
 assigning *E* or *Z* 392
 of alkenes summary of terminology 405
 of dienes, in Diels–Alder reactions 882–9
 of dienophiles in Diels–Alder reactions 881–2
 of enolates 869–871
geraniol, asymmetric hydrogenation of 1119
geranium oil 790
geranyl pyrophosphate 1166
Gibbs free energy *see* free energy
Gibbs, Willard 243
Gilman reagents 578
gingerol, retrosynthetic analysis of 635, 713
GlaxoSmithKline (GSK) 178
GlaxoWellcome 178
Gleevec or Glivec *see* imatinib
global energy minimum 370
glucosamine 1147
glucose 229, 1134–5, 1142–4
 conformation and anomeric effects 801–2
 cyclic hemiacetal structure 137
glutamic acid 555, 1104
 in glutathione 1140
glutamine 555

- glutathione 657, 1140
 glyceraldehyde 1151
 importance in D,L nomenclature 310–11
 protected, from mannose 1105
 glycerol, structure 17
 glycerol (propane-1,2,3-triol) 211, 1147
 3-phosphate 1147–8
 monoester 1147
 trioleate 1148, 1161, 1163
 glycerol, in Skraup quinoline synthesis 782
 glycine 554
 ¹H NMR spectrum 284–5, 833
 achiral structure of 307, 822, 856
 component of collagen 1141
 in glutathione 1140
 structure 16
 glycolysis pathway 1154
 glycosidase enzyme 1145
 glycosides, in nature 1144–6
 O-glycosides 1145
 S-glycosides 1145–6
 gold, catalysis by 1099
 grandisol 25, 1021
 grapefruit, smell and taste of 5, 659, 969
 grapes, health benefits of 6
 graphite, atomic structure 81
 Greek letters, in naming of organic structures 459, 500
 green pepper, chemical responsible for flavour 752–3
 Grignard reagents 182–94
 as bases 132–3
 as Lewis acids for epoxide rearrangement 946
 as nucleophiles 133
 chelation controlled addition 863–4
 complex with ether 185
 detailed structure 1074
 diastereoselective addition to chiral carbonyl compounds 858–64
 making 184–5, 187, 549
 polarized bond of 132
 reaction with acyl chlorides to form ketones 218
 amides or nitriles to form ketones 219–20, 231
 esters to form tertiary alcohols 216
 α,β -unsaturated carbonyl compounds 508–9
 retrosynthetic recognition of 710–11
 transmetallation of 508–9
 use as base in aza-enolate formation 594
 Grignard, Victor 1084
 Grubbs, Robert 1025, 1084
 Grubbs I and II catalysts, for metathesis 1025
 guaiazulene, synthesis and ¹H NMR 814
 guaiol 814
 guanidine, basicity of 175, 178, 512–13
 disconnection of in retrosynthetic analysis 718
 in orb weaver spider toxin 236
 in synthesis of trimethoprim 771
 guanine 1136
 degradation in human metabolism 751
 guanosine, modified for treatment of herpes 1138
- H**
¹H NMR *see* NMR, ¹H
 H1N1 virus 1174–5
 HAART (highly active antiretroviral therapy) 1171
 Hajos–Parrish–Eder–Sauer–Wiechert reaction 1131
 half-chair (flattened chair) conformation in cyclohexene 829
 of cyclohexene 373–4
 of cyclohexene oxide 837–8
 halides, as nucleophiles in conjugate addition 500
 haloalkanes 30 *see also* alkyl halides
 from alkenes 427–9
 elimination to give alkynes 398
 from 1,2 dibromoalkenes 398
 halobenzenes *see also* chlorobenzenes, bromobenzenes, iodobenzenes
 from diazonium salts 522–3
 nitration of 489–90
 reactivity towards nucleophilic aromatic substitution 518
 haloform reaction 462–3
 halogen, reduction by tributyltin hydride 991–2
 halogenation, of enols and enolates 461–4, 469
 of silyl enol ethers 469
 halogen–lithium exchange 188
 halogen–metal exchange 188–9
 halogens, as aromatic substituents 489–90
 as electrophiles 115
 compounds containing 12
 homolysis by light 971
 halolactonization, for regiocontrol 568–9
 halomon 12
 Hammett, Louis P. 1041
 Hammett reaction constant, ρ 1043–4
 Hammett relationship, in ester hydrolysis 1041–4
 in mechanism determination 1041–8
 non-linear plots 1048
 Hammett substituent constant, σ 1042–3
 Hammond postulate 989
 Hantzsch, Arthur 763
 Hantzsch pyridine synthesis 763–5, 783
 haptic number η , definition 1070
 hard and soft nucleophiles 357, 507, 658
 and conjugate addition 506–7
 and enolate alkylation 590
 attack on ATP 1136
 hashed bonds 302
 HCl *see* hydrogen chloride, hydrochloric acid
 heats of combustion, of alkanes 367–8
 heavy water (D₂O), as NMR solvent 272
 Heck, Richard F. 1084
 Heck reaction 1069, 1079–82
 Hegedus, Louis 1098–9
 Heisenberg, Uncertainty Principle of 83
 helenalin 508
 helium, inability to form bonds 91
 helium atom, energy level diagram 85
 helix, double, in DNA 1137–8
- hemiacetals, acid/base catalysed formation of 137–8, 223–4
 by reduction of lactones 533
 cyclic, anomeric effects in 801
 from hydroxy aldehydes 136–7
 from hydroxy ketones 137
 decomposition 224
 formation, by acetal hydrolysis 338–9
 from alcohols and carbonyl compounds 135–8, 197, 223–4, 247
 in nature 229
 in sugars 229, 801, 1143
 instability 198, 223–4, 247
 stable cyclic 136–7, 247
 hemiaminal 230–1
 hemlock, poison from 1156
 henbane (*Hyoscyamus niger*) 1156
 Henry reaction 622–4
 heptan-2-one, ¹H NMR spectrum 294
 mass spectrum of 48, 51
 heroin 793
 herpes virus, drug 708, 1138
 hertz, conversion to ppm, in NMR 288
 heteroatoms, definition of 32
 nucleophilicity in rings 791–2, 794
 protons attached to, in ¹H NMR 282–5
 heterocycles 723–824, 1089
 aromatic, amination by Buchwald–Hartwig cross-coupling reaction 1093
 benzo-fused, structure and reactions 745–8
 coupling by Suzuki coupling reaction 1086
 examples (table) 754–5
 five-membered, synthesis of 759, 903–4
 in Diels–Alder reactions 738–40
 natural products containing 723
 nitrogen and oxygen containing, isoxazole 751
 oxazole 751
 nitrogen and sulfur containing, 1,2,5-thiadiazole 752
 isothiazole 751
 thiazole 751
 nitrogen containing, acridine 750
 adenine 750
 imidazole 725
 indole 745
 indolizine 750
 isoquinoline 749
 purine 750–1
 pyrazole 725
 pyridone 728–9
 quinoline 749
 tetrazole 744
 triazole 725
 pyrazine 724
 pyridazine 724
 pyridine 724
 pyrimidine 724
 pyrrole 725
 oxygen containing, furan 735–8
 pyriliium cation 732
 pyrone 732
 retrosynthetic analysis of 757–88
 six-membered, synthesis of 759–60

- structures and reactions of 723–56
sulfur containing, thiophene 735–7
synthesis, by ring modification 787–8
synthesis by cycloaddition reactions (summary) 787
synthesis of (summary) 785–8
- aromaticity of 162
- as nucleotide bases 1135–6
- nomenclature used for 724, 725
- saturated 789–824
- conformation of 796–805
 - effect of stereoelectronics on conformation 801–5
 - examples of natural products containing 790
 - from intramolecular Michael additions 812
 - from intramolecular nucleophilic substitution 805–10, 812
 - nitrogen containing, anomeric effect on conformation of 804
 - as nucleophiles 791
 - by ring-closing reactions 806
 - in drugs 793
 - reactions of 790–4
 - ring opening 793
 - nomenclature 793
 - orientation of lone pairs in 800–1
 - oxygen containing, ^1H NMR coupling in 801–3
 - anomeric effects in 801–3
 - in sugars 801–2
 - reactions of 794–5
 - ring opening of 794
 - spiroketals, anomeric effect in 803
 - reactions of 790–5
 - sulfur containing, reactions of 795
 - synthesis of 805–14
 - by ring-closing reactions 805–13
- N-heterocyclic carbenes, as ligands in metathesis catalysts 1025
- representation of 1025
- structure and ^{13}C NMR of carbene in 1006, 1010
- heterolysis (heterolytic cleavage), definition of 571, 970
- heteronuclear coupling, in NMR 415–16
- hexachloroacetone, in synthesis of secondary allylic chlorides 577–8
- hexadecanoic acid (palmitic acid) 212
- hexamethyldisiloxane 469, 670
- hexamethylenetetramine 1179–80
- hexanedioic acid 35
- by ozonolysis of cyclohexene 444
 - X-ray crystal structure of 44
- hexatriene, electrocyclic ring closing of 922–3
- shape and NMR spectrum 145
- high performance liquid chromatography *see* HPLC
- highest occupied molecular orbital *see* HOMO
- highly active antiretroviral therapy (HAART) 1171
- high-resolution mass spectrometry (HRMS) 50
- himalchene 631
- hindrance, steric *see* steric hindrance
- hirsutene 992
- histamine, pK_a of 178
- histidine, as acid and base 555, 754, 1153
- HIV (human immunodeficiency virus) 1170
- HIV, drugs for treatment of 1066–7, 1123, 1125, 1138, 1142
- HIV protease inhibitors 1142, 1170–4
- HOBt *see* hydroxybenzotriazole
- Hoffmann, Roald 892
- Hofmann rearrangement 1022
- Hofmann's rule 399
- HOMO, definition of 111
- of allyl cation and anion 150–3
 - of butadiene 889–90
 - of carbocation 941–2
 - of cyclopentadiene 920–1
 - of nucleophile 111, 356
 - of pyridine 729–30
 - of pyrrole 733, 744
 - role in Diels–Alder reactions 886–91
- homoallylic alcohols, epoxidation of 856
- from allyl silanes and carbonyl compounds 676–7
- homogeneous catalysis 1078–101
- homogeneous hydrogenation 1117–19
- HOMO–LUMO interaction 110–11
- in [3+2] cycloadditions 901, 903
 - in conjugate addition 502–3
 - in photochemical [2+2] cycloadditions 897–8
 - in reactions of carbonyl group 126–7
 - in $\text{S}_{\text{N}}2$ 355–6
 - in thermal [2+2] cycloadditions 898–901
- homolysis (homolytic cleavage), definition of 571, 970
- ease of (table) 971
 - of hydrogen chloride 970
 - photochemical 971
- homotopic 820
- faces, example of 856
- Hooke's Law 64
- hops, terpenes from 1164
- Horeau effect 1111
- hormones 1140
- sex 1167, 379
- Horner–Wadsworth–Emmons reaction 570, 628, 692
- Horner–Wittig reaction *see* Horner–Wadsworth–Emmons reaction
- Houk, K. N. 865
- Houk model, for reactive conformation of chiral alkenes 865–7
- house fly, pheromone of 540–1
- Hoveyda–Grubbs catalyst, for metathesis 1025, 1100
- HPLC, use in determination of enantiomeric excess 1111
- HRMS *see* high-resolution mass spectrometry
- Hückel's rule 161–2
- Hughes, Edward David 329–30
- human immunodeficiency virus *see* HIV
- humulene 1164
- Hund's rule 86
- hybridization 99–103
- change during reactions of carbonyl group 127
 - effect on pK_a 175–6
 - hydrate formation (hydration) 134–5
 - equilibrium constants for 135
 - hydration, of aldehyde, energy profile 243
 - of alkenes 444–5
 - of alkynes 445–6
 - hydrazine, by reduction of diazonium salt 777
 - in synthesis of pyridazine and pyrazole 759–60, 767–8
 - reaction with epoxide 704
- hydrazone 232
- formation in Fischer indole synthesis 776
 - in aza-enolate formation 650
- hydride ion, H^- , as base 130 *see also* sodium hydride, potassium hydride
- energy level diagram 84
 - lack of nucleophilicity of 586
 - pK_a 237
- hydride migration 941–2
- hydride transfer 530–1
- hydroalumination, of alkynes 683
- hydroboration 446–7
- strategies for regiocontrol 570
- hydrobromination, of alkenes 118–19
- radical and ionic compared 571–2
- hydrocarbon chains *see* carbon chains
- hydrocarbon framework 17
- branched 25–7, 36
 - drawing 22
 - naming 34
- hydrochloric acid, strength in water 166
- hydrochlorination, of cyclopentadiene 579
- hydroformylation of alkenes 1077
- hydrogen, abundance of ^1H 269
- hydrogen (^1H) NMR *see* NMR, ^1H
- hydrogen abstraction 972–3
- hydrogen atom, energy level diagram 84
- hydrogen bonding, in epoxidation of allylic alcohols 856
- in IR spectra 67–8
 - in stabilization of enols 458
- hydrogen bromide, addition to dienes 435
- pK_a of 172
- hydrogen chloride, addition to alkenes 434–5
- dissociation of 970
 - ionization of 166, 970
 - pK_a of 169, 172
 - $\text{S}_{\text{N}}1$ reaction with alcohols 348
- hydrogen cyanide, pK_a of 188
- hydrogen fluoride, pK_a of 171, 172
- hydrogen iodide, addition to alkenes 434–5
- pK_a of 170, 172
- hydrogen molecule, energy level diagram 89
- hydrogen peroxide, for synthesis of peroxy acids 430
- in Baeyer–Villiger oxidation 954
 - in oxidation of pyridine to N-oxides 730
 - reaction with boranes 446–7
- hydrogen sulfide, addition to alkenes 434–5
- hydrogenation 534–9 *see also* catalytic hydrogenation
- asymmetric, of alkenes 1117–19
 - by Lindlar's catalyst 681–2
 - enantioselective, in indinavir synthesis 1172
 - heat of, as measure of stability 157–8, 241

- hydrogenation (*continued*)
 homogeneous 1117–19
 of aromatic nitro compound 769
 of imines to amines 235
 of Wieland–Miescher ketone 845
 stereospecificity and stereoselectivity of 842, 845
 transfer 1115–17
- hydrogenolysis, of benzylic C–O and C–N bonds 538–9, 717
 of sulfides and thioacetals 663
- hydrolysis, of acetals 227, 247, 338–9
 of amides, reaction kinetics of 260–1
 of carboxylic acid derivatives 206
 of cyclic acetals, stereoelectronic effects on 800–1
 of dithianes 663
 of enamine 592–3
 of enol ethers 468
 of esters 209–12, 262–4, 547
 in presence of amide 529, 557–8
 Hammett relationship 1041–4
 of fats and glycerides 211
 of glycosides in nature 1145–6
 of imines 231–2, 594, 632
 of nitriles 213–4
 of nitroalkanes (Nef reaction) 612
 of orthoesters 248
 of oximes 232
 of silyl enol ethers 469
 of thioesters in nature 1153
 prevention of in acetal formation 226–7, 247–8
- hydrometallation 1076–7
- hydronium ion (H₃O⁺) 166
 concentration in water 168
- hydropalladation–dehydropalladation 1081–2
- hydroperoxide, as nucleophile for removal of oxazolidinone auxiliary 1112, 1121
 for epoxidation of α,β -unsaturated carbonyl compounds 513–14
 reaction with boranes 446–7
- hydroxide, as base in E2 elimination 386
 as leaving group in E1cB elimination 400, 1154
 as nucleophile 113, 117
 in Cannizzaro reaction 620
 by dissociation of water 168
 in E2 elimination 382–3
 pK_a of 170
- hydroxy acids, by diazotization of amino acids 1105
 natural 1105
- hydroxy ketones, synthesis from nitrile oxides 903–4
- hydroxybenzotriazole, in amino acid coupling 747–8
- hydroxyl group *see also* alcohol 29
 aromatic, from amino group via diazonium salt 521
 effect on solubility of organic compounds 29
 protection and deprotection of 549–52
- hydroxylamine 229, 901
 addition to enones 419
 effect of pH on reactivity 773
- reaction with 1,3-dicarbonyl compound 772–3
- hydroxyproline, in collagen 1141
- hydroxypyridines, tautomerism of 728
- hygrine 1157–8
- hyoscyamine 1156
- Hyoscyamus niger* (henbane) 1156
- hyperconjugation *see* σ -conjugation
- hyperfine splitting, in EPR 976
- hypertension, drug for treatment of 699–700
- hypochlorite, as oxidizing agent 195
- hypochlorous acid (HClO), pK_a of 172
- hypoglycin, structure of 1016
- hypophosphorous acid, in radical reactions 1001–2
- Hz, conversion to ppm, in NMR 288
- I**
- I*, nuclear spin, of ¹H and ¹³C 270
- i*-Bu *see* isobutyl
- ibuprofen 26, 324–5
¹³C NMR spectrum 409
 racemization of *in vivo* 460
- IBX, precursor to DMP/Dess–Martin periodinane 545
- identification of natural products 421–2
 of unknown compounds 418–22
- imatinib 11, 1169–70
- imidazole 178, 451, 725, 741, 754
 acid/base properties 741
 as catalyst in silyl ether formation 741
 delocalization in 741
 nitration of 742
 pK_a of 178, 741
 reaction with electrophile 742–3
 structure of 725
 tautomerism of 451, 742
- imidazolium cation, deprotonation of in carbene formation 1009–10
- Imigran 777
- imines, alkylation of 593–4
 comparison (and interconversion) with enamines 233–4, 456–7
 formation of 229–37
 variation of rate with pH 263
 comparison with acetal formation 233
- hydrolysis of 231–2, 594, 632
 in aldol reactions 632
 in synthesis of β -lactams by [2+2] cycloadditions 900
 pK_a of 726, 793
 reaction with cyanide 236
 reduction of 234–6
 stability of 231–2
 stereoisomers of 231
 tautomerism in 456–7
- iminium ions 233
- iminium salt, formation of 621
- indene, asymmetric epoxidation with 1123
- indigo 9, 149–50
- indinavir (Crixivan), synthesis of 1066–7, 1123, 1171–4, 1179
- indole 745
 acylation of nitrogen 779
 by palladium catalysed cyclization 1098
- electrophilic aromatic substitution 745–6
 enantioselective alkylation of 1129
 Fischer synthesis 775–80
 Mannich reaction of 746–7
 methylation of nitrogen 778
 regioselective reactions, compared with pyrrole 745–6
 Reissert synthesis 779–80
 retrosynthetic analysis of 775–9
 role in biochemistry and medicine 755
 substitution of Mannich product 747
 Vilsmeier reaction of 746
- indole alkaloids 745
- indolizine, structure of 750
- indomethacin 744, 779
 tetrazole substitute 774
- inductive effect 134
 on aromatic ¹H NMR chemical shifts 279–80
 on ester electrophilicity 644
 on IR spectra 411–12
 on nucleophilicity and basicity of cyclic amines 792
- influenza, drug for treatment of 1174–9
- infrared spectroscopy *see* IR spectroscopy
- infrared stretching frequency *see* stretching frequency
- Ingold, Sir Christopher 240, 308, 329–30, 358
- initiation, of radical reactions 571–3
- initiator, radical, AIBN as 972
 borane-oxygen as 998–9
 dibenzoyl peroxide as 971, 985
 inorganic acids, pK_a of 170
- inositol 318
- insecticide, decamethrin 1016
 pyrethrin group 664, 815
- insertion, oxidative 184–5
- insertion reaction, intramolecular, of α -dicarbonyl 1019
 of carbenes, summary 1005
 into C=C 1013–18
 into C–C 1021
 into C–H 1018–20
 into O–H and N–H 1023
 of nitrene into C–C 1022
 of oxygen, in Baeyer–Villiger 953–7
- integration, of ¹³C NMR 799
 of ¹H NMR 270
- intermediates, cyclic, in neighbouring group participations 932
 to control stereochemistry 847–50
 detection by spectroscopy 419–20, 1060–3
 effect of solvent on reaction 256
 experimental evidence for 1061
 in reaction pathways 253
 trapping 893–4
 variation of concentration with time 264
- intermolecular and intramolecular reactions, enthalpy and entropy in 247
- International Union of Pure and Applied Chemistry *see* IUPAC
- intramolecular [3+2] cycloaddition 902, 904–5
 aldol reaction 636–40
 alkylation 586
 Claisen condensations 652–4

- Diels–Alder reactions 888–9, 891
 radical reactions 999–1002
 rates, compared to intermolecular 938
 intramolecular reactions, regiocontrol from 568–9
 inverse solvent isotope effect, in specific acid catalysis 1054
 inversion of configuration in S_N2 343–4, 351, 352, 380–1
 iodide, aryl, synthesis from diazonium salts 522–3 *see also* iodobenzenes
 iodide, as a nucleophilic catalyst 358
 as leaving group in semipinacol rearrangement 948
 S_N2 reaction with ethers to form alcohols 351
 Iodide, alkyl, as functional group 30 *see also* alkyl iodides
 iodine, hypervalent compounds for oxidation 545
 use in alkene equilibration 680
 iodoalkane 30 *see also* alkyl halides
 iodobenzene, from diazonium salts 522–3 *see also* iodobenzene
 nitration of 489–90
 iodoform reaction 462–3
 iodolactamization, in synthesis of oseltamivir (Tamiflu) 1178
 iodolactonization, regioselectivity 568–9
 stereoselectivity and stereospecificity 847–8, 853–4
 ionic reactions, definition of 877
 ionization, in mass spectrometry 46–8
 ioxynil 491
i-Pr *see* isopropyl
 iproniazid 26
 ipsenol, synthesis of 1106
ipso 416, 473
 substitution of aryl silanes 672–3
 IR spectra, bond bending 72
 bond strength and vibrational frequency 66
 C=N oxime stretching frequency 230
 C=O stretching frequencies (table) 413
 effects of conjugation 411
 in carboxylic acid derivatives 206, 215
 in *N*-acyl aziridines 794
 inductive effect 411
 effect of dipole moment 71
 estimating carbonyl frequencies 413–14
 fingerprint region 72
 hydrogen bonds in 66–8
 identifying C–Cl bonds 72
 interpretation of 66–71
 of amines 66
 peak shapes in 69
 regions of 65–6
 scale 64–5
 symmetric and antisymmetric stretching in 67, 70
 typical deformation frequencies 72
 IR spectroscopy 43, 63–72
 bond vibration in 64
 use in identifying unknown compound 72–8, 498–9
 use to identify functional groups 63, 66–71
 IR stretching frequency *see* stretching frequency
 Ireland, Robert E. 914
 Ireland–Claisen rearrangement 914
 iridium, in Vaska's complex 1074
 iron, as catalyst for bromination 488, 567
 iron acyl complex, from migratory insertion of CO 1076
 isoborneol, Wagner–Meerwein rearrangement of 943–4
 isobucaine, synthesis of 546
 isobutanol, ^{13}C NMR spectrum 62
 isobutene, reaction with hydrogen bromide 433–4
 isobutyl group 26
 isobutyl propionate, flavour of 31
 isobutyraldehyde, in crossed aldol reactions 632
 isocyanates, β -lactams from 898, 900–1
 from Curtius or Hofmann rearrangement 1022
 in [2+2] cycloadditions 898, 900–1
 isoelectronic structures 102–3
 isoleucine 554, 874–5
 isomenthol 377
 isomer, definition and examples 26
 isomerization of an amide bond, rate constants for 256
 of alkenes, by acid catalysis 254, 264–6, 434–5
 by hypopalladation–dehypopalladation sequence 1081–2
 of allyl bromides 435–6
 isomers, constitutional 306
 geometrical, properties of 677–8
 stereo- 306, 311
 isonopinone, structure of 947
 isooctane (2,2,4-trimethylpentane) 3, 28
 combustion energy 250
 isopentyl acetate, flavour of 31
 isopentyl pyrophosphate 1166
 isopentyl valerate, flavour of 31
 isoprene (2-methylbuta-1,3-diene) 1164–5
 reaction with hydrogen bromide 435
 isopropanol, as hydrogen source 1115–17
 isopropyl cation, ^1H NMR spectrum 338
 isopropyl group 26
 isopulegol, from Alder ene reaction of citronellal 896
 isoquinoline 749, 755
 ^1H NMR spectrum 282
 by intramolecular Vilsmeier reaction 784
 electrophilic substitution of 749
 role in biochemistry and medicine 755
 isoquinoline alkaloids 1159–61
 isothiazole, structure of 751
 isothiocyanates, in green vegetables 1145
 isotopes, abundance of ^1H and ^{13}C 269
 detection of by mass spectrometry 49–50
 radioactive, use and disadvantages of 1037–8
 relative abundance of 50
 isotopic labelling, ^{13}C , detection by NMR 417
 by ^{82}Br in S_N2 345–6
 by ^{82}Br to show rate of S_N2 345–6
 double, with ^{13}C 1038–9
 examples of atoms used 1037
 for elucidating biosynthetic pathways 1157, 1159, 1162, 1166
 in crossover experiments 1038–9
 in mechanism determination 211, 1019, 1032, 1037–8
 in mechanism of ester hydrolysis 211
 kinetic isotope effect 1050–2
 of carbonyl compounds with ^{18}O 223
 to show neighbouring group participation 937
 with ^{13}C 417, 1038–9
 with ^{14}C 623
 with ^{18}O 201–2, 211, 223
 with deuterium 811, 1162, 1166
 isoxazole, by [3+2] cycloaddition 903
 from 1,3-dicarbonyl and hydroxylamine 772–3
 from nitrile oxide and alkyne 772–4
 reduction of 751
 retrosynthetic analysis of 772
 structure and aromaticity of 751, 903
 itraconazole 1094
 IUPAC 34
- J**
J, coupling constant, definition of 288 *see also* coupling constant
 Jacobsen, Eric 1122
 Jacobsen epoxidation 1122–3, 1126, 1173
 Jamaican vomiting sickness, causative agent 1016
 Japanese beetle pheromone 4, 1104
 japonilure 4, 1104
 jasmone 2, 9
 jawsamycin *see* FR-900848 1016
 Johnson–Claisen rearrangement *see* orthoesters
 Jones oxidation; Jones' reagent 544, 731–2
 Julia, Marc 686
 Julia, Sylvestre 687–8
 Julia olefination 686–8
 one-step 687–8
 Julia–Kociński reaction 687–8
 juvenile hormone 183, 191, 677–8, 965–6
- K**
K, as symbol for equilibrium constant 242–3
k, as symbol for rate constant 257
K_a, as symbol for acidity constant 169
 Karplus relationship 796–8
 Katsuki, Tsutomu 1120, 1123
 kcal (kilocalories), use of unit 244
 Kekulé structure of benzene 143, 473
 ketal 227–8, 247–8
 ketene, dimer of, NMR spectrum 419–20
 ketene acetals, from E2 elimination 387
 in conjugate addition 609
 ketene equivalents, in [4+2] cycloadditions 899
 ketenes, cyclobutanone from 898–900
 formation from Wolff rearrangement 1021
 from acyl chlorides 455
 from E1cB elimination of acyl chloride 403

- ketenes, cyclobutanone from (*continued*)
 in [2+2] cycloadditions 898–900
 IR and NMR spectra 420
 orbitals of 419
- keto acids 235
 from Friedel–Crafts acylation 494
- keto alkynes, from Eschenmoser
 fragmentation 965
- keto form, of carbonyl compound 450
- keto-enol tautomerism 450–1, 471
- keto-hexose 1151
- ketones 30–1 *see also* carbonyl compounds
¹³C NMR, chemical shifts of carbonyl
 group 408–9
¹H NMR to distinguish from aldehydes 410
 acylation of 649, 651
 addition of bisulfite 138–40
 aldol reactions of, controlling 634–6
 alkylation of 588–9, 591–7, 600–4, 613
 regioselectivity 590, 592, 595–7, 598–
 604, 613
 asymmetric reduction of 1114–17, 1132,
 1150
 Baeyer–Villiger oxidation of 953–6
 bicyclic, diastereoselective reactions of
 840–6
 bromination of 461–4
 by decarboxylation of acetoacetate
 derivatives 596
 by hydration of alkynes, using gold
 catalysis 1099
 by hydrolysis of dithiane 795
 by hydrolysis of nitroalkanes (Nef
 reaction) 612
 by oxymercuration of alkynes 445–6
 by ozonolysis of nitro group 612
 by pinacol rearrangement 945–6
 by semipinacol rearrangement 947
 by Wacker oxidation of alkenes 1096
 chemoselective reduction of in presence of
 ester 529
 chiral, Felkin–Anh model for
 stereoselective reactions of 859–62
 Claisen condensation with esters 645
 conversion to alkenes by the Wittig
 reaction 237–8
 conversion to epoxides with sulfonium
 ylids 665–7
 disconnections of 710
 enol equivalents for 591–634
 in nature 1151–3
 summary 595
 enolization of 451, 454
 five-membered cyclic, diastereoselectivity
 of nucleophilic attack on 834
 formation of enamine by reaction with
 cyclic amine 791
 four-membered cyclic, diastereoselectivity
 of nucleophilic attack on 833
 from carboxylate salts with organolithiums
 218–19
 from nitriles and Grignard reagents 220, 231
 from nitro compounds using TiCl₃ 899
 from secondary alcohols 544–5
 from Weinreb amides 219–20, 1112
 McMurry reaction to form alkenes 982–3
 mechanism of lithium enolate formation
 from 588
 nitrosation of 464–5
 nucleophilic addition to 125–40
 pinacol reaction of 981
 prochiral, definition of 856–7
 protection as acetals 228, 548
 reaction with alcohols to form acetals
 224–8, 247–8
 with alcohols to form hemiacetals 135–
 8, 197, 223–4, 247
 with borohydride 119, 130–1, 251, 253,
 257–8, 530–1
 with enolates 614–54
 with organometallics 190–1
 with primary amines to form imines
 229–37
 with secondary amines to form
 enamines 233–4
 with sulfur ylids 744
 with water 133–5
 spirocyclic, diastereoselective reduction
 of 847
 symmetrical, alkylation of 588–9, 591–7,
 613
 synthon representing 712
 unsaturated, Baeyer–Villiger oxidation of
 954–5
 unsymmetrical, alkylation on less
 substituted side 588, 592, 600–3,
 613
 alkylation on more substituted side
 595–7, 599–600, 602–4, 613
 use of ¹³C NMR to distinguish from acid
 derivatives 408–10
 Wieland–Miescher 845
 γ,δ -unsaturated, synthesis by Claisen
 rearrangement 912
- ketoreductase, enzyme 1132
- ketorolac 738
- ketose 315
- ketyl radical anion, as indicator in THF
 distillation 981
 formation and structure 980
 reaction in protic vs aprotic solvents 981
- ketyl 973
- KHMDS *see* potassium hexamethyldisilazide
- KIE *see* kinetic isotope effect 1050–2
- kilocalories (kcal), use of unit 244
- kinetic and thermodynamic control 264–6
 in conjugate vs direct addition reactions
 605–6
 in reactions of sulfur ylids 666–7
 over electrophilic aromatic substitution
 566
- kinetic and thermodynamic stability 250
- kinetic control, in conjugate addition 504–5
 in control of alkene geometry 264–6, 678,
 684
 in Diels–Alder reactions 884–5
 in electrophilic addition 434–6
 in enolate formation 600–1
 in reactions of sulfonium ylids 667
 in ring-opening of epoxides 838–9
 of ring-forming reactions 806–10
- kinetic enolate, formation of 601, 634–5, 654
- kinetic isotope effect (KIE) 1050–2
 kinetic product *see* kinetic control
- kinetics, of reactions 250–66
 S_N1 and S_N2 as examples 329–33
- Knoevenagel, Emil 629–30
- Knoevenagel reaction 629–30
- Knorr pyrrole synthesis 761–3
- Knowles, William 1116
- Kociński, Philip 687
- Kolbe–Schmidt process 481
- Krapcho decarboxylation 597–8
- K-selectride (potassium tri-sec-
 butylborohydride), to reduce
 enones to enolates 603
- K_w (ionization constant of water) 168
- L**
- L and L_m , meaning of 1075
- labelling *see* isotopic labelling
- lactam, C=O stretching frequency 413
- lactam, β *see* β -lactam
- lactate dehydrogenase 28
- lactic acid 28, 209, 309, 311, 1105
¹³C NMR spectrum 54, 56
¹H NMR of methyl ester 275
 as starting material in asymmetric
 synthesis 872–3, 1107
 by reduction of pyruvic acid by NADH
 1150
- lactol 136–7
- lactones, enolization of 617, 618
 fused bicyclic, by iodolactonization 848
 in Claisen condensations 654
 reactivity compared to esters 804–5
 reduction by sodium borohydride 617
 reduction to hemiacetals 533
- lactonization 400–1
- laetrile 31–2
- laevorotatory 310
- LAH *see* lithium aluminium hydride
- lamivudine (3TC) 1138, 1171
- Langmuir trough experiment 1148
- large rings 368, 807
 rate of reaction 806–7
- lauric acid 1161
- Lawesson's reagent 759
 in synthesis of thioamide 772
- LCAO 88–99
- LDA (lithium diisopropylamide) 26, 39, 174
 as base in E2 elimination 398
 chemoselectivity in formation of enolates
 465–6
 compared with LiTMP 793
 for making aza-enolates from imines 594
 for making enol esters 642
 for making lithium enolates 465–6, 1110
 formation of 588
 in aldol chemistry 625–6, 631, 634
 regioselectivity in kinetic enolate
 formation 600–1
 variants of 588
- L-dopa *see* dopa
- Le Châtelier's principle 249
- leaving group ability, and relationship to pK_a
 202–4, 792

- and ring strain 351–2
 effect of acid catalysts 208
 effect on rate of S_N1 and S_N2 331, 347–8
 effect on stability of tetrahedral intermediates 200
- leaving groups and nucleophiles compared 357–8
- leaving groups 197–8
 axial and equatorial 379–81
 DABCO, in Bayliss–Hilman reaction 792
 hydroxide as, rare cases 400, 1154
 in elimination reactions 390
 in nucleophilic aromatic substitution 516, 518, 728
 in S_N1 and S_N2 347–52, 357–8
 phosphates in ATP 1136
- Lehn, Jean-Marie 936
- leprosy, drug for treatment of 657
- leptospermon, stable enol and herbicide 458
- leucine 16, 554, 1105, 6
- leukaemia, drug for treatment of 1169
- leukotrienes 854, 1162–3
 synthesis of single diastereoisomers of 854–5
- Lewis acid 180–1
 aluminium chloride 180–1
 boron trifluoride 180
 common examples of 180–1
 diethylaluminium chloride 1108
 halogen-selective, silver oxide as 934
- Lewis acid catalyst, for enolization 461
 for ring-opening of cyclic ethers 794
 in Alder ene reaction 895
 in aldol reactions 626
 in cleavage of aryl alkyl ethers 351
 in conjugate addition of silyl enol ethers 608–9
 in Diels–Alder reaction 891
 in Friedel–Crafts reactions 477
 in reactions of allyl silanes 676
 in S_N1 alkylation of silyl enol ethers 595
- Lewis base 180
- LHMDS *see* lithium hexamethyldisilazide
- $LiAlH_4$ *see* lithium aluminium hydride
- ligand migration 1076
- ligand-accelerated catalysis 1126
- ligands, chiral *see* chiral ligands
 for Buchwald–Hartwig cross-coupling reaction 1093
 for Sharpless asymmetric dihydroxylation 749, 1123–6
 N-heterocyclic carbenes, in metathesis catalysts 1025
 transition metal, classes and characteristics 1070–2
- light, energy associated with 971
 equilibration of alkenes by 680
- lilac perfume 709–10
- limonene 28, 1102–3
- Lindlar's catalyst, in hydrogenation of alkynes 537, 541, 681–2
- linear 1,3-dipoles 902
- linear combination of atomic orbitals *see* LCAO
- linearmycin 22
- linoleic acid 17, 536, 1161, 1163
 X-ray crystal structure 18
- linolenic acid 536, 1161, 1163
- lipids 1134–5, 1147–9
 in cell membranes 1147
- Lipitor *see* atorvastatin
- lipoic acid, ^{13}C NMR spectrum 409
- lisinopril 1140–1
- lithiation 563–4
 of furan 737–8
 of thiophene 737
- lithium acetylide, by deprotonation of ethyne 189
- lithium aluminium hydride,
 diastereoselective reductions of cyclic ketones with 828, 834
 for removal of chiral auxiliary 1110, 1112
 in reduction of esters to alcohols 217, 531
 reduction of amides to amines 236
 reduction of nitriles to amines 236
- lithium atom, energy level diagram 85
- lithium borohydride, reduction of esters with 531
- lithium carbenoid 1008–9
- lithium carboxylates, reaction with organolithiums 218–19
- lithium chloride, in metal catalysed reactions of triflates 1084
 in synthesis of allylic chlorides 577
- lithium cuprate, in conjugate addition 509
- lithium diisopropylamide *see* LDA
- lithium enolates, [3,3]-sigmatropic Cope rearrangement of 914
 alkylation of 588–90, 604, 607, 610
 as specific enol equivalents 465–6, 624, 625
 control of geometry 870–1
 cyclic mechanism for formation 625
 formation using LDA 465–6
 from silyl enol ethers 466–7
 geometry of 870–1
 in aldol reactions 625
 in conjugate addition 607
 mechanism of formation 588
 of carbonyl compounds, to prevent self-condensation 587–90
 of esters 631
 tetrameric structure of 625, 626
- lithium hexamethyldisilazide (LHMDS) 588, 635
- lithium tetramethylpiperidide 588, 793
- lithium tri-*sec*-butyl-borohydride *see* L-selectride
- LiTMP *see* lithium tetramethylpiperidide
- liver alcohol dehydrogenase 1150
- local energy minimum 370
- locking groups, and effect on conformation of cyclohexanes 377–9
- lone pairs, as nucleophiles 112
 drawing 21
 orientation of 790, 794, 800–1, 803–5
- longifolene, synthesis of 650, 948
- long-range coupling 295–6, 301
- loose S_N2 transition state 437–8, 441
- Lossen rearrangement 1022
- Low-temperature baths, for reactions 133
- low temperatures, to slow reactions 252–3, 266
- lowest unoccupied molecular orbital *see* LUMO
- LSD (lysergic acid diethylamide), structure of 745
- L-selectride (lithium tri-*sec*-butyl-borohydride), to reduce enones to enolates 603
 diastereoselective reductions of cyclic ketones with 828, 834
- LTMP *see* lithium tetramethylpiperidide
- LuCh reduction 506, 536–7
- LUMO 111
 of allyl cation and anion 150–3
 of carbocation 941–2
 of carbonyl groups with adjacent electronegative atoms 862
 of cyclopentadiene 920–1
 of electrophile 111, 356
 of nitrile oxide 903
 of pyridine 726–7
 role in Diels–Alder reactions 886–91
- LUMO–HOMO interaction *see* HOMO–LUMO interaction
- lycopene, red plant pigment 141
- lysergic acid diethylamide *see* LSD
- lysine 16, 23, 555
 X-ray crystal structure 20
- lysine enamines, enolate equivalent in biochemistry 1151–3
- lyxose 316

M

- m*- as prefix *see meta*
- Macmillan, David 1128
- macrolide 219
- magnesium enolates 649
- magnesium(II), as catalyst in nature 166–7
- magnetic field, induced 54
 role in 1H NMR 270, 277
- magnetic resonance imaging *see* NMR
- malaria, drug for treatment of 724
- malayamycin A 1100
- maleic acid 105
 structure and melting point 311
- maleic anhydride, ^{13}C NMR spectrum 409
 as dienophile in Diels–Alder reaction 880, 884
- maleic dialdehyde (*cis*-butenedial), from furan 736
- maleic hydrazide, structure and synthesis of 748
- malic acid 31, 1105
- malonate esters, in retrosynthesis 708 *see also* malonates
- malonate radical, reactivity of 996–7
- malonates, alkylation of 596
 as specific enol equivalents 629
 decarboxylation of 597
 in conjugate addition 606
- malonic acid 596, 630
- malonic anhydride 420
- malonyl coenzyme A 1161–4
- maltol 9
- maltose 229
- mandelic acid 310, 1105
 from benzaldehyde 213–4
 in asymmetric synthesis 322–3

- manganese(VII), for oxidation of alcohols 546
- manganese, as catalyst in asymmetric epoxidation 1123
- manicone 627
- Mannich base, formation of 621
- Mannich disconnection, in retrosynthetic analysis 716–17, 766, 778
- Mannich reaction 620
- in heterocycle synthesis 766, 778
- in synthesis of 3-amino alcohol 716–17
- of indole 746–7
- of pyrroles 734
- D-mannose 1105
- margarine, manufacture of 536
- Markovnikov's rule 433–4
- masked ketene *see* ketene equivalent
- mass spectrometer, components of 46–7
- mass spectrometry 43, 46–52
- ionization techniques 46
- isotope patterns 49
- use in identifying unknown compounds 72–8
- McMurry reaction 982–3
- m*-CPBA (*meta*-chloroperbenzoic acid), for
- epoxidation of alkenes 430–2
- for oxidation of pyridine to *N*-oxide 730
- for oxidation of sulfides and selenides 685–6
- in Baeyer–Villiger oxidations 953
- in diastereoselective epoxidation 836, 840–1, 843–4
- stereoselective epoxidation of *cis*-fused bicyclic alkene 843–4
- MDMA 5
- Me, definition of 23
- mechanisms, detailed study of 240–68, 1029–68
- drawing curly arrows for 120–4
- in biological chemistry 1149–56
- relationship to kinetics of reaction 258
- shorthand versions 204, 217, 267
- summary of 266–7
- mechanistic determination, by detection of intermediates 1060–3
- by systematic structural variation 1040
- methods for, summary 1067–8
- of benzyne reactions 1061
- of Favorskii rearrangement 1061–3
- of S_N1 vs S_N2 1040, 1044–8
- using crossover experiments 1038–9
- using entropy of activation 1052–3
- using general acid/base catalysis 1057–60
- using Hammett relationships 1041–8
- using isotopic labelling 1032
- using kinetic isotope effects 1050–2
- using solvent isotope effect 1054–6
- using specific base catalysis 1055–6
- using stereochemistry 1063–7
- medium rings, definition of 368, 806
- transannular interactions in 807
- Meerwein's salt (trimethyloxonium tetrafluoroborate) 225, 467, 664
- megahertz, conversion to ppm, in NMR 288
- Meissner, Carl F. W. 1156
- Meldrum's acid, structure and pK_a 1090
- memory of stereochemical information, example of 835
- menthofuran, structure and synthesis 760
- menthol 2, 1104
- synthesis by Alder ene reaction 896
- use in resolution 324
- mercaptan *see* thiol 659, 663
- Merck 816, 1023, 1066, 1171–3
- mercurinium ion 444–6
- mercury, decline in use for catalysis 1099
- mercury(II), for hydrolysis of thioacetals 663, 795
- in hydration of alkenes and alkynes 444–6
- mesityl oxide, conjugate addition to 503
- mesitylene (1,3,5-trimethyl benzene) 1115–17
- meso* compounds 317–18
- mesyl chloride *see* methanesulfonyl chloride
- mesylate *see* methanesulfonate
- meta*, meaning of 36, 479
- meta* coupling, 1H NMR in aromatic rings 295–6, 301
- metabolism, primary and secondary 1134, 1156
- meta*-chloroperbenzoic acid *see* *m*-CPBA
- metacyclophane 662
- metal carbonyls 1073
- metallacyclobutane, intermediate in metathesis 1024
- metallacyclobutene, intermediate in ene-yne metathesis 1026–7
- metallation, of furan 737–8
- of thiophene 737
- regioselective, of aromatic compounds 563–4
- metal–ligand interaction, concepts 1069–72
- metallocarbenes 1007
- metals in complexes, oxidation states of 1072
- meta*-substitution, regioselective formation of 525
- metathesis 1023–7, 1099–100
- catalysts for 1025
- cross 1025–6
- ene-yne 1026–7
- mechanism of 1024
- ring-closing 1023–4
- methadone, synthesis via pinacol rearrangement 947
- methane, bonding and molecular orbitals 98–100
- pK_a of 170
- shape of 81
- methanesulfonate, as leaving group 349, 390–1
- methanesulfonate esters, E1cB step in mechanism of formation 403–4
- in eliminations 391, 400
- synthesis from alcohols 349
- methanesulfonic acid, pK_a of 173
- methanesulfonyl chloride, elimination to sulfene 404
- in synthesis of allylic chlorides 577
- methanol, as solvent for S_N1 reactions 346–7
- methine group, in 1H NMR 274–6
- methionine 16, 23, 555, 1136, 1139
- crystal structure of 44
- methoxide, as base in Claisen condensation 647
- as nucleophile in conjugate addition 502
- N*-methoxy-*N*-methyl amide (Weinreb amide) 219
- methoxymethyl cation, in S_N1 reactions 338
- methyl acetoacetate, 1H NMR spectrum 276
- methyl benzenesulfonate, 1H NMR spectrum 488
- methyl benzoate, 1H NMR spectrum 488
- nitration of 489
- methyl cation, shape of 103
- methyl chloroformate *see* chloroformates
- methyl cyanoacrylate *see* superglue
- methyl esters, from diazomethane with carboxylic acid 1003–4 *see also* esters
- methyl ethers, as protecting groups 552
- methyl group, in 1H NMR 272–6
- methyl lactate, 1H NMR spectrum 275
- methyl methacrylate, ^{13}C NMR spectrum 409
- methyl mycaminoside, synthesis of 872–3, 1107
- N*-methyl-*N*-nitrosotoluenesulfonamide, as source of diazomethane 1004
- N*-methyl-*N*-nitrosoourea, as source of diazomethane 1004
- methyl phenyl sulfide 660
- methyl phenyl sulfone 660
- methyl phenyl sulfoxide 660
- methyl propiolate (methyl propynoate), IR spectrum 69
- methyl radical, EPR and absorption spectrum of 976
- methyl vinyl ketone, conjugate addition to 606
- N*-methylaniline, IR spectrum of 66
- methylation 467 *see also* alkylation
- in biological chemistry 1136–7
- of amines by reductive amination with formaldehyde 234–5
- of indole nitrogen 778
- methylene group, diastereotopicity in 820–4
- in 1H NMR 274–6
- methylene insertion reactions, by diazoalkanes 953
- methyleneation of carbonyl compounds by the Wittig reaction 237–8
- methylolithium, ^{13}C NMR spectrum 152
- addition to α,β -unsaturated esters 582
- N*-methylmorpholine-*N*-oxide *see* NMO
- 2-methyloxirane *see* propylene oxide
- 2-methylpropan-1-ol *see* isobutanol
- 2-methylpropan-2-ol *see tert*-butanol
- methyltriphenylphosphonium bromide, 1H NMR spectrum 416–17
- metamide 178–9
- metronidazole, synthesis of 743
- mevalonic acid 1161, 1165–7
- mevalonolactone 1165
- MHz, conversion to ppm, in NMR 288
- micelles 1148–9
- Michael acceptors 623 *see also* α,β -unsaturated carbonyl compounds
- examples of 500, 605, 609–10
- reaction with nitronates 623
- unsaturated amides as 610
- unsaturated nitriles as 610

- unsaturated nitro compounds as 610–11
with *exo*-methylene groups 609
- Michael addition 500 *see also* conjugate addition
- axial, in six-membered rings 831–2
in synthesis of saturated heterocycles 812
- palladium catalysed 1092
- microscopic reversibility 813, 1056
- migration, during oxidation of boranes 447
of alkyl groups from C to N, in Curtius rearrangement 1022
of alkyl groups in carbocations 940–4
of aryl and alkyl groups in carbenes 1021
of hydride 941–2, 1018–20
to oxygen, in Baeyer–Villiger reaction 953–8
1,2-, stereochemistry of 955
- migration origin and terminus 939
- migratory insertion 1075–7
- milbemycin, synthesis of 551
- millitesla, as unit of coupling in EPR 976
- mint flavour, chemical responsible for 760
- mirror images 302–6
- Mitsunobu, Oyo 349
- Mitsunobu reaction 349–51, 578
for synthesis of secondary allylic chlorides 577–8
- MO *see* molecular orbital
- models, molecular 361
- Mogadon *see* nitrazepam
- molecular formula, from high-resolution mass spectrometry 50
- molecular ion, in mass spectrometry 48
- molecular models 361
- molecular orbital (theory) 88–99
and excited states 897
antibonding 88
bonding 88
effect on bond rotation 105
in Alder ene reaction 895–6
in conjugate addition reactions 502–3
of allyl cation 336
of allyl cation and anion 150–3
of allyl silanes 676
of benzene 160
of butadiene 146–8
of butadiyne 683
of carbenes 1011–12
of carbonyl group 126–7
of cyclooctatriene 160
of ethene (ethylene) 142
of polyatomic molecules 98–103
of radicals 976–9
of vinyl silanes 674
 π 91–5
 π^* 91–5
 σ 91–5
 σ^* 91–5
symmetry of 92–3
- molecular orbital diagram, for Diels–Alder reaction 886
for S_N2 reaction 356
of radicals 977–9
- molecular sieves 226
- Monastral green 9
- montelukast (Singulair), synthesis of 1117
- Mori, K. 873–5, 1106
- morphine 793
- morpholine 790–1
as amine for enamine formation 592, 608
in preparation of enamine 650
 pK_a of 792
- Mosher, Harry S. 1111
- Mosher's esters, use in analysis of enantiomeric excess 1111
- mother liquor 324
- moxnidazole 704
- Moxysyte *see* thymoxamine
- Mozingo reaction 540
- MsCl *see* methanesulfonyl chloride
- Mukaiyama, Teruaki 636
- Mukaiyama aldol reaction 636
- multicolanic acid 645
- multiplet, in 1H NMR 291–2
- muscalure, chemoselectivity in synthesis of 540–1
- muscone 25
synthesis by ring expansion 964–5
- mustard gas 664–5
participation of sulfides in 935
- Myers, pseudoephedrine chiral auxiliary of 1113
- myristic acid (tetradecanoic acid) 211
- myrtenal, 1H NMR spectrum 274, 282, 300
- ## N
- n-, N-, N,N-*: compound names starting with these prefixes are indexed under the first word of the name
- NAD, NAD⁺, NADH (nicotinamide adenine dinucleotide) 1140, 1149–50
- NADP, NADPH, NADPH₂ (nicotinamide adenine dinucleotide phosphate) 1132, 1149–50
- nafmidone 704–5
- NaHMDS *see* sodium hexamethyldisilazide
- names, trivial *see* trivial names
- naming compounds 33–42
acronyms 39
branched structures 36
containing benzene rings 36
use of Greek letters 500
use of numbers in 35–6
use of *ortho*, *meta*, *para* (*o-*, *m-*, *p-*) 36, 479
use of suffixes and prefixes 35
use of trivial names 37
- naphthalene 161
bond length of C–C 295
coupling constants in 1H NMR 295
drawing 473–4
regioselectivity of electrophilic aromatic substitution 565–6
- naproxen 1104
asymmetric synthesis of 1119
resolution of 324–5
- natural gas, smell of 4
- natural product synthesis 872–5, 992, 1098–9
- natural products, biosynthesis 1156–67
containing aromatic heterocycles 723
nomenclature 1156
- nature, chirality in 323, 1102–3
- NBS, as bromine source 441, 573, 836, 990
- Nef reaction 612
TiCl₃ as alternative to 899
- Negishi, E-i. 1084
- Negishi coupling 189
- neighbouring group participation 931–8
effect on rates 931–2
effect on stereochemistry 932–4, 936–7
in activity of mustard gas 935
labelling studies of 937
by alkenes 935
by amines 938
by carboxylate groups 934
by esters 932–3
by ethers 934–5
by phenyl rings 935–6
by sulfides 932, 934
phenonium ion in 935–6
racemization by 936–7
- neighbouring groups, definition of 932
- neon atom, energy level diagram of 86
- neopentyl (*t*-butylmethyl), structure 940
- neopentyl chloride, lack of reactivity in S_N1 and S_N2 343
- neopentyl iodide, silver nitrate induced rearrangement of 940
- nerolidol 193–4
- neryl pyrophosphate 1166
- neuraminic acid 1175
- neuraminidase inhibitors 1175
- neutron, mass of 51
- Newman projection 363–4
- Nexium *see* esomeprazole
- NHC *see* *N*-heterocyclic carbene
- nickel, as catalyst for hydrogenation 535–7
- Nicolaou, Kyriacos Costa 926
- nicotinamide adenine dinucleotide *see* NAD
- nicotinamide adenine dinucleotide phosphate *see* NADP
- nicotine 790, 1157
 1H NMR spectrum 275
- nicotinic acid 730
chlorination of 730
- niflumic acid, synthesis of 730
- nisoxetine 717
- nitrate, structure of 901
- nitration, conditions for 476
of 3,4-dimethoxybenzaldehyde 492
of acridine *N*-oxide 750
of benzene 475–6, 487–9
of furan 735–6
of halobenzenes 489–90, 566–7
of imidazole 742
of isoquinoline 749
of methyl benzoate 489
of nitrobenzene 487–9
of *para*-xylene (1,4-dimethyl benzene) 780
of phenol 481
of phenyltrimethyl ammonium ion 486–7
of pyridine, strategies for 727
of pyridine *N*-oxide 730
of quinoline 749
of substituted pyrazole 769
of trifluoromethylbenzene 487

- nitration, conditions for (*continued*)
regioselectivity of 486–7
trapping of intermediates 1060–1
- nitrenes, formation and rearrangement 1022
- nitric acid, for oxidative cleavage of camphor 841
in oxidation of dihydropyridine 783
- nitric oxide (NO) 95–6
- nitrile oxide, [3+2] cycloaddition of 773–4, 903–5
structure of 901
synthesis of 773, 902–3
- nitriles 31
alkylation of 585–6
as nucleophile in Ritter reaction 353
by conjugate addition reactions 500
by dehydration of amides 213
cycloaddition with azide in tetrazole synthesis 774
deprotonation of 456
from alkyl bromide and sodium cyanide 716
hydrolysis to carboxylic acids 213–14, 586
 pK_a of 175
reaction with Grignard reagents 220, 231
reduction to amine 236, 716
reduction to aldehyde with DIBAL 534
unsaturated, as Michael acceptors 510–13, 610
- nitrite, structure of 901
- nitro aldol reaction (Henry reaction) 622–4
- nitro compounds 30, 901 *see also*
nitroalkanes, nitroalkenes,
nitrobenzenes
as intermediates in aromatic chemistry 494–5
unsaturated, as Michael acceptors 511, 610–11
- nitro group 30
activating effect in nucleophilic aromatic substitution 516–17
comparison with nitroso group 464–5
conversion to diazonium salt 495
drawing 30, 70
electron withdrawal by 488
equivalence of N–O bonds in 70, 154
for regiocontrol in electrophilic aromatic substitution 494–5, 566–7
IR spectrum of 70
reduction to amino group 538
structure and conjugation 154
symmetric and antisymmetric stretching in IR spectra 70
- nitroalkanes 623
 1H NMR spectra 280–1, 282
alkylation of 586–7
as ketene equivalent in [4+2] cycloadditions 899
as termite defence compounds 623, 624
conjugate addition of 611, 623
conjugate addition to 511, 904
conversion to ketones 612, 899
cyclic, synthesis of 587
deprotonation of 177, 456, 611, 622
hydrolysis to ketone (Nef reaction) 612
 pK_a of 177, 586, 611
reaction to form nitrile oxide 773
reaction with ozone to form ketones 612
- nitrobenzene 476
 1H NMR spectrum 282, 488
bromination of 488
by nitration of benzene 487–9
halogenated, nucleophilic aromatic substitution on 518
in Skraup quinoline synthesis 782
nitration of 487–9
- 4-nitrocinnamaldehyde, IR spectrum of 70
- ^{15}N , isotopic labelling with, for elucidating biosynthetic pathways 1157
- nitrogen, N_2 , energy level diagram of 86
bonding in 91–5
- nitrogen, as a stereogenic centre in aziridines 794
- nitrogen-containing compounds, in mass spectrometry 51–2
- nitrogen acids and bases 174
compared with oxygen bases 177
- nitrogen fixing bacteria 188
- nitrogen gas, as leaving group in nucleophilic aromatic substitution 520–3
- nitrogen heterocycles, saturated, reactions of 790–4
- nitrogen insertion, by Beckmann rearrangement 958–9
- nitromethane, anion of 622–3
 pK_a of 177, 586
- nitronate anion 587, 622
- nitron, as 1,3-dipole 901
synthesis of 902
- nitronium ion (NO^+) 476
from sodium nitrite with acid 521
- nitrosamine 521
- nitrosation, of carbonyl compounds 464–5
- nitroso group, structure of 464–5, 522, 901
- 9-nitrosojulolidine 3
- nitro-stabilized anion 587
- nitrous acid, in nitrosation of enols 464–5
- NMO 1123
as reoxidant for osmium tetroxide 442
in dihydroxylation with osmium tetroxide 906
in TPAP oxidation 545
- NMR spectrometer 54
rating in MHz 288–9
- NMR spectroscopy 43, 52–63 *see also* NMR, 1H or ^{13}C NMR
bond rotation in DMF by 156
chemical shift in 57
delocalization of a cation in 152–3
diastereotopic groups in 820–4
effect of electronegativity on chemical shift 55–6, 422 (table)
effect of functional groups on chemical shift (table) 423–5
evaluation of exchange rate (equation) 374
heteronuclear coupling 415–16
nuclear energy levels in 270, 287–91
recording of spectra 270
resonant frequency of ^{13}C 418
resonant frequency of 1H 418
sensitivity of 57
solvents for 55, 272
symmetry in 57–8
use to follow course of reactions 335
use to solve unknown structures 62, 72–8, 418–22
- NMR, 1H (proton nuclear magnetic resonance) 59–62, 269–301, 414–18
AB system 296–8, 822–3
ABX systems in 298
AX spectrum 286–9
AX₂ spectrum 289–91
abbreviations used in 293
aldehyde region 281–2
alkene and benzene region 277–81
axial/equatorial substitution 818–19
carbon satellites in 417
chemical shift 59, 272–85
additive effects of substituents on (table) 425–6
and relation to reactivity 280, 281
summary (table) 276
compared with ^{13}C 269–70
conformation of saturated rings by 796–800, 802
coupling 285–301 *see also* coupling
determination of configuration by 796–7
diastereotopic protons 822–3
effect of chiral shift reagents 1111–12
effect of electronegativity on chemical shifts in 61, 272–3
electron distribution in aromatic rings 278–9
evidence for ring-flipping in cyclohexane 373–4
exchange of acidic protons in 283–5
factors affecting coupling constants (summary) 294–5, 300–1
inductive effects in 279–81
integration in 270–2
negative chemical shift 414
nuclear Overhauser effect in 799–800
of alkynes 414–15
of methyl group (table) 273
of protons attached to heteroatoms 282–5
of small rings 414
of *t*-butyl group 273–4
protons on saturated carbon in 272–6
ring currents 277–8
regions of spectrum 60, 273
relationship to pK_a 283
relaxation of protons in 799
roofing in 298, 822
rotation of bonds in 274
singlets in 286
splitting using Pascal's triangle 291
tetramethylsilane (TMS) as reference for 270
to compare electron distribution in aromatic rings 279–80
to determine enantiomeric excess 1111–12
to study reactive intermediates 940–1
- NMR, ^{13}C *see* carbon-13 NMR
- NMR, ^{19}F , use in analysis of enantiomeric excess 1111–12
- N–O bonds, functional groups containing 901
- NO *see* nitric oxide
- NO^+ *see* nitronium
- Nobel prize winners: Kurt Alder (Chemistry, 1950) 878

- Svante Arrhenius (Chemistry, 1903) 257
 Derek Barton (Chemistry, 1969) 379
 James Black (Physiology/Medicine, 1988) 180
 Herbert C. Brown (Chemistry, 1979) 999
 Yves Chauvin (Chemistry, 2005) 1025, 1084
 Elias James Corey (Chemistry, 1990) 1177
 Donald Cram (Chemistry, 1987) 936
 Francis Crick (Physiology/Medicine, 1962) 1137
 Otto Diels (Chemistry, 1950) 878
 Emil Fischer (Chemistry, 1902) 776, 1084
 Kenichi Fukui (Chemistry, 1981) 892
 Victor Grignard (Chemistry, 1912) 1084
 Robert Grubbs (Chemistry, 2005) 1025, 1084
 Roald Hoffmann (Chemistry, 1981) 892
 William Knowles (Chemistry, 2001) 1116
 Jean-Marie Lehn (Chemistry, 1987) 936
 Ei-ichi Negishi (Chemistry, 2010) 1084
 Ryoji Noyori (Chemistry, 2001) 604, 1116
 George Olah (Chemistry, 1994) 334–5
 Charles Pedersen (Chemistry, 1987) 936
 Robert Robinson (Chemistry, 1947) 638
 Richard Schrock (Chemistry, 2005) 1025, 1084
 K. Barry Sharpless (Chemistry, 2001) 1116
 Akira Suzuki (Chemistry, 2010) 1084
 Vincent du Vigneaud (Chemistry, 1955) 555
 James D. Watson. (Physiology/Medicine, 1962) 1137
 Geoffrey Wilkinson (Chemistry, 1973) 1084
- nodes, in orbitals 85–6
 NOE (nuclear Overhauser effect) 799–800
 nomenclature *see* naming compounds
 nomenclature, +/- 310
anti/syn 858
cis/trans and *Z/E* 679
D/L 310–11
R/S 308–9
 for alkene geometry 392
 or heterocycles 724, 725
 for natural products 1156
 of azo compounds 1006
 of bicyclic compounds 839
 of enolate geometry 869
 of prochiral faces and groups 856–7
 of saturated heterocycles 793
 systematic 34–41
 terms used in Baldwin's rules 810
 trivial 33–4, 36–9
- non-polar solvents 255–6
 non-steroidal anti-inflammatory drug (NSAID) 324–5, 1104, 1119
 nootkatone, synthesis via fragmentation 966–9
 norbornadiene, in Diels–Alder reaction 881
 norbornane, conformational drawing 839–40
 norbornanone, diastereoselective attack on 840
 norbornene, diastereoselective attack on 840–1
 norcaradiene, by electrocyclic closure of cycloheptatriene 922
- norephedrine, use in chiral auxiliary synthesis 1109
 Novartis 10–11, 1130
 Novrad 326, 1103
 Noyori, Ryoji 604, 1116
 N-propylglucosamine, as a resolving agent 325
 NSAID *see* non-steroidal anti-inflammatory drug
 Nu *see* nucleophile
 nuclear energy levels, and NMR spectra 270, 287–91
 nuclear magnetic resonance, *see* NMR, ¹H NMR, or ¹³C NMR
 nuclear Overhauser effect (NOE) 799–800
 nuclear spin, *I*, of ¹H and ¹³C 53, 270
 nuclei, energy level differences in ¹H NMR 270
¹H NMR 270, 287–91
 NMR-active 53
 nucleic acids 1134–9
 nucleophiles 109, 112–13
 addition to alkynes to form *Z* alkenes 683–4
 allyl silanes as 675–7
 and leaving groups compared 357–8
 anionic and neutral compared 205
 basicity of 177
 carbonyl compounds as 584–613, 614–55
 dependence of axial and equatorial attack on 380–1, 826–8, 832, 834
 for conjugate addition and substitution 507
 hard and soft 357, 385, 444, 453, 506–7
 and conjugate addition, 506–7
 and elimination 385
 and enolate alkylation 462, 590
 attack on ATP 1136
 how to identify 112–13, 120
 in S_N1 reaction 352–3
 in S_N2 reaction 353–8
 nitroalkanes as, in conjugate addition 611
 saturated nitrogen heterocycles as 790–5
 solvent as 337–8
 summary of types 113
- nucleophilic addition, diastereoselective 855, 864–5
 to chiral carbonyl compounds 858–65
 effect of chelation on 864–5
 equatorial vs axial in six-membered rings 825–32
 Felkin–Anh model for 859–60
 in attack on four-membered rings 833
 pseudoequatorial vs pseudoaxial in cyclopentanones 834
 to bridged ketones, face of attack 840
- nucleophilic addition, to alkenes conjugated with carbonyl groups *see* conjugate addition
 to allylic carbonates, palladium catalysed 1090
 to benzyne 523–6
 to carbonyl groups 125–40
 to conjugated carbonyl groups 489
 to electrophilic alkenes 498–514
 to enol ethers 468
 to vinyl epoxides 1090
- nucleophilic aromatic substitution 514–26
 activating substituents for 519
- alkoxide as nucleophile 518
 amine as nucleophile 515
 azide as nucleophile 518
 compared with Buchwald–Hartwig coupling 1095
 evidence for intermediate in 516–17
 in synthesis of ofloxacin 519–20
 of pyridines 726–8
 of quinolines 784
ortho, *para*-directing groups 516
 rate of reaction 518–19
 regioselectivity of 567–8
 requirements for 515–16
 similarities with conjugate substitution 515
 S_N1 mechanism of 520–3
 types of leaving group and mechanism 518
- nucleophilic catalysis, by DMAP 726
 by imidazole 741
 by iodide in S_N2 358
 by pyridine in acylation 200
 by pyridine in bromination reactions 726, 731
- nucleophilic radicals 995–6
 nucleophilic substitution *see also* S_N1; S_N2
 adjacent to indole 778
 at a carbonyl group 197–221
 summary 220
 at saturated carbon (S_N1 and S_N2) 328–59
see also S_N1; S_N2
 summary of S_N1 vs S_N2, (table) 347
 at silicon 469, 669–70
 determination of S_N1 vs S_N2 328–9, 1040, 1044–8
 effect of neighbouring group on rate of 931–2
 in synthesis of saturated heterocycles 812
 intramolecular, in synthesis of saturated heterocycles 805–10
 of allylic compounds 574–9
 of carbonyl group oxygen 222–39
 on pyridazine 748–9
 on pyridine *N*-oxides 730–1
 on pyrrole 738–9
 on quinoline *N*-oxide 750
 S_N1 *see* S_N1
 S_N2 *see* S_N2
 stereochemistry and 343–4
 to give secondary allylic chlorides 577–8
 using palladium 1088–92
- nucleophilicity, enamines and enolates compared 591
 in S_N2 reactions 355–6
 increase of in absence of solvation 344
 inductive effect on 792
 of amines vs cyclic amines 791, 794
 vs water and alcohol 177
 of organometallics 183–4
 of thiols vs alcohols 658
 towards C=O, relationship to pK_a 792
- nucleoside analogues 1138, 1170–1
 nucleosides 1135–6, 1170–1
 nucleosides, cyclic 1138–9
 nucleotides, in primary metabolism 1135
 NADH and NADPH as 1149–50
 numbering, use of in names of compounds 35
 Nurofen *see* ibuprofen

- NutraSweet *see* aspartame
 nylon, synthesis of by Beckmann rearrangement 958
- O**
o- as prefix *see ortho-*
 oblivon 529
 ocfentanil 701–2
 octadecanoic acid (stearic acid) 212
 octatriene, electrocyclic ring-closing of 924
 oestradiol 25
 oestriol 1005
 oestrone 187, 548, 949
 synthesis of 548
 ofloxacin 783
 synthesis of 519–20
 ofornine 699–700
 O-glycosides 1145
 Olah, George 334–5, 338
 olean 5
 olefin *see* alkene
 olefination *see* alkenes, synthesis
 oleic acid 536, 1148, 1161, 1163
 oleum, for sulfonation 476–7, 485–6
 olive oil, lipid in 1148, 1161, 1163
 ondansetron 755
 retrosynthetic analysis and synthesis of 778
 opioid painkiller 701
 opium poppy (*Papaver somniferum*) 1159
 Oppolzer, camphorsultam auxiliary of 1113
 Oppolzer, Wolfgang 631, 650
 opsin 681
 optical activity 309–10
 optical purity 1111
 optical rotation, in analysis of enantiomeric excess 1111
 orb weaver spider 236–7
 orbital, atomic **84–8** *see also* atomic orbital
 dsp 1073
 effect of alignment on couplings in NMR 796–8, 800–1
 hybridized, *see* hybridization
 molecular **88–99** *see* molecular orbital
 orientation of 86
 phase of 87
 shape of 84–6
 wavefunction of 84, 87
 orbital overlap 108–11
 and Baldwin's rules 810–14
 and unreactivity of dichloromethane 804
 effect on bonding 102
 importance of, summary 801
 in Alder ene reaction 895
 in anomeric effect 802–3
 in Baeyer–Villiger reactions 955, 957
 in C–H insertion by carbene 1020
 in cyclopropane formation by carbenes 1015–16
 in Diels–Alder cycloaddition 878, 882
 in fragmentation reactions 962–3
 in thermal [2+2] cycloadditions 898–9
 order, of reaction 259
 organic elements 11, 23, 42
 summary 42
 organic structures, determining **43–78**
 guidelines for drawing 17–22
 organocatalysis 1127–9, 1131–2, 1180
 and metal catalysts compared 1128
 organochlorine compounds, as pesticides 881
 organocopper reagents 218, 508–9
 organolithiums **182–93**
 as bases 132–3
 as nucleophiles 132–3
 chiral 1113–14
 decomposition of solvents by 795
 for formation of dianions and trianions 547–8
 from 1,2-dibromoalkenes 398
 in ring-opening of cyclic ethers 794
 making 185–7
 polarized bond in 132
 reaction with acyl chlorides to form ketones 218
 reaction with esters to form tertiary alcohols 297–8, 216–17
 organomagnesium reagent *see* Grignard reagent
 organometallic chemistry
 electropositive metals (Li, Mg, Zn) **182–96**
 transition metals **1069–101**
 organometallics, aggregate structures 184, 185
 as bases 132–3, 186–7
 as nucleophiles 132–3
 commercially available 186
 coupling with organic halide/triflate 1082–8
 formation of 184–90
 by deprotonation with another organometallic 187
 by halogen–metal exchange 188–9
 in catalysis **1069–101**
 nucleophilicity of 183–4
 polar **182–96**
 polarized nature of carbon–metal bond 132
 reaction with carbon dioxide 190–1
 reaction with carbonyl compounds **182–96**
 reaction with α,β -unsaturated carbonyl compounds 508–9
 regioselective reactions of 563–4
 sensitivity to water 132–3
 solvents for 794
 transition metals 1069–101
 organophosphorus compounds,
 disconnections of 709
 organosilicon compounds 668
 organozincs 189
 ornithine, pyrrolidine alkaloids from 1157–8
 ortho, meaning of 36, 479
 ortho, para-directing effect 480, 483
 orthoamides, use in Claisen rearrangements 911–12
 orthoesters 248
 from neighbouring group participation of acetate 937
 general acid catalysed hydrolysis of 1059
 in Claisen rearrangements 912
 ortholithiation 563–4
 oseltamivir (Tamiflu) 10
 synthesis of 1174, 1177–9
 osmate ester 905–6
 osmate salts, in AD reaction 1123–6
 osmium tetroxide (OsO₄), as catalyst for AD 1123–6
 cycloaddition with alkenes 905–6 *see also* dihydroxylation
 osmylation *see* dihydroxylation
 osteoporosis, drug for treatment of 1100
 'Owen Bracketts', [O] symbol 626
 oxalate *see* diethyl oxalate
 oxaloacetate, in citric acid synthesis 1153
 oxalyl chloride, in Swern oxidation 545, 667–8
 oxanamide intermediate, retrosynthetic analysis of 713
 oxaphosphetane intermediate, in Wittig reaction 238, 690–2
 oxazole 725, 751
 oxazolidinones, as chiral auxiliary 1108–13, 1129–30
 Weinreb amides from 1112
 oxenoid 1018
 oxetane 429, 794
 ¹H NMR spectrum 291–2
 by ring-closing reaction 805, 808–9
 ring opening of 794
 oxidants, for asymmetric dihydroxylation 1123–6
 oxidation, Baeyer–Villiger 953–8
 Fleming–Tamao 673
 Jones 544
 of alcohols or aldehydes or ketones 544–5
 to carboxylic acids 195, 546
 of alkyl boranes to alcohols 446–7
 of dihydropyridine 763, 764
 of furan with DMDO (dimethyl dioxirane) 736
 of quinoline with potassium permanganate 750
 of sulfides 685
 of thiophene 739
 Swern 545, 667–8
 Wacker 1096
 oxidation levels, of carbon 32–3
 oxidation of alcohols, with chromium(VI) 194–5
 with transition metals 194–5
 oxidation state, comparison with oxidation level 32
 of metals in complexes 1072
 sulfur 657
 oxidative addition 184–5, 1073–4
 oxidative cleavage, of C=C 443–4, 841, 906–7
 of C=N with ozone 612
 oxidative insertion 184–5
 N-oxide, of pyridine 730
 oxidizing agent 195, **544–6**
 table of chemoselectivity 544
 oxime 229–30, 232
 from nitrosation of carbonyl compounds 464–5
 hydrolysis and stability of 232
 in Beckmann fragmentation 959–60
 in Beckmann rearrangement 958–9
 in pyrrole synthesis 762

- oxidation to nitrile oxide 773
 reduction of 702, 762
 stereoisomers of 231
 structure of 901
- oxine (8-quinolinol), synthesis of 782
- oxirane *see* ethylene oxide
- oxiranes *see* epoxides
- OXO process 1077
- 3-oxobutanoic acid *see* acetoacetic acid
- oxonium ion, as electrophile 122
 as intermediate in acetal formation 225, 233
 attack on by allyl silanes 676–7
 in hydrolysis of enol ethers 468
 in S_N1 reactions 338
 2-oxopropanoic acid (pyruvic acid) 1153–4
- oxyallyl cation, as intermediate in Favorskii reaction 951
 evidence for 1061–3
 formation of and use in [4+3] cycloadditions 893–4
- oxy-Cope rearrangement 913–14
- oxygen, O_2 , with borane, as initiator of radical reactions 998–9
- oxygen, ^{18}O , isotopic labelling with 201–2, 211, 223
 in tetrahedral intermediates 201–2, 211
- oxygen atom, energy level diagram of 86
- oxygen bases, compared with nitrogen bases 177
- oxygen heterocycles, saturated, reactions of 794–5
- oxygen insertion, in Baeyer–Villiger reaction 953–6
- oxymercuration, in hydration reactions 445–6
- oxypalladation 1096–7
- oxypalladation, reverse 1097
- oxytocin 555
- ozone 906
 1,3-dipolar cycloaddition with alkenes 906–7
 in oxidation of quinoline 750
 reaction with alkenes 443–4, 906–7
 reaction with nitroalkanes to form ketones 612
- ozonide, from ozone and alkene 906–7
- ozonolysis 443–4, 612, 906–7
- P**
- p-* as prefix *see para-*
- p* orbital 86
- Pacific yew tree 1170
- paclitaxel *see* Taxol 1169–70
in situ reduction of, mechanism 1080–1
- palladium, π -allyl complexes of, use in synthesis 1089–92
 activation of allylic electrophiles by 1088–92
 allylations and alkylations with 1088–91
 amination catalysed by 1092–5
 as catalyst for hydrogenation 535–9
 catalysis by 1069–99
 choice and cost 1078
 coordination to alkenes 1096–8
 on carbon, for reduction of aromatic nitro groups 495
 stable complexes of 1070
 tetrakis(triphenyl)phosphine 12
- palladium(0), catalysis by 1069–99
- palladium(II), catalysis by 1072, 1078, 1080–1, 1096–9
- pallescensin A 649
- palm oil 212
- palmitic acid (hexadecanoic acid) 212, 1161
- palytoxin 15
- pantothenic acid 1152
- Papaver somniferum* (opium poppy) 1159
- papaverine 755, 1159–60
- para*, meaning of 36, 479
- para*-toluenesulf-... *see* toluenesulf-...
- para*-xylene (1,4-dimethyl benzene), nitration of 780
- paracetamol 31, 696
 ^{13}C NMR spectrum 58–9
 IR spectrum 68
- paracetamol, synthesis 481
- paraformaldehyde 621
- parasitic equilibrium 618
- Parkinson's disease 1103, 1118
- partial double bond character, of DMF 156
- participation
 by sulfur, in synthesis of episulfonium ion 665
 by π systems 935–6
- Pascal's triangle, and splitting in 1H NMR 291
- Paternò–Büchi reaction 896–8
- Pauli exclusion principle 84
- Payne rearrangement, of epoxy alcohol 938–9
- PCC (pyridinium chlorochromate) 39, 194–5, 545, 731–2
- PDC (pyridinium dichromate) 194, 731–2, 545, 1121
- pea moth pheromone 360–1, 707
- pederin, structure and 1H NMR 819
- Pedersen, Charles 936
- pefloxacin 780–1
- penaresidin A, synthesis of 873–5, 1107
- penicillin 657
 mode of action 1141–2
- penicillin V, E1cB elimination in synthesis of 403
- pentacene, viewed by atomic force microscopy 81
- pentaerythritol, synthesis of 620
- pentalenolactone 1020
- pentane, lowest energy conformation of 804
- pentazole 744
- pentenal, IR and NMR 412
- PEP (phosphoenolpyruvate) 1153–4
- peptide bond 31, 1140
- peptides 156, 1140
 ^{13}C NMR of carbonyl groups 409
 biological synthesis 1139–42
 protecting groups for use with 553
 synthesis of 553–9
- peracids *see* peroxy acids
- perchlorate anion (ClO_4^-), shape of 172
- perchloric acid ($HClO_4$), pK_a of 172
- perfume 9
- pericyclic reactions, classification of, summary 922
 cycloadditions 877–908
 electrocyclic 922–30
 sigmatropic 909–22
 Woodward–Hoffmann rules for 892
- periodate *see* sodium periodate
- periodinane 545
- periplanone B 929–30
- peroxide, as oxidant in Sharpless epoxidation 1120
 hydrogen 430, 513
 reduction by glutathione 1140
- peroxy acids, comparison with carbenoids 1018
 for epoxidation of alkenes 429–32
 in Baeyer–Villiger oxidations 953
 synthesis of 430
- persistent radicals 974–5, 979
- pest control, compound used for 183
- Peterson elimination 671, 675, 688–9
 stereospecificity of 689–90
- pethidine, synthesis by Favorskii rearrangement 952–3
- petrol, combustion energy 250
- Pfizer 11, 529, 657, 744, 768
- Ph 24–5
- pH 166
 effect on rate of imine formation 231, 263
 effect on reactions of hydroxylamines 773
 of stomach 163
 relationship to pK_a 167, 168–9
- phase transfer catalysis 585
- phase, of orbital 87
- phenaglycodol 720–1
- phenol 37
 1H NMR spectrum 472, 480
 comparison with enols 471–2
 deuteration with D_2O 472
 electron distribution in 480
 keto form 472
 nitration of 481
 orbitals of 480
ortho, *para*-directing effect in 480
 pK_a of 173
 reaction with bromine 479–80
 reaction with carbon dioxide 481–2
 stabilizing effect of aromaticity 471–2
- phenols, by rearrangement of dienone 949–50
 electrophilic aromatic substitution of 479–82
 from aniline via diazonium salt 521
 IR spectrum of 67
 preference for enol form 459
 reaction with diazomethane 1004
 reaction with formaldehyde in synthesis of salicylaldehydes 1179
- phenonium ion, in neighbouring group participation 935–6
- phenyl (Ph) 24
 neighbouring group participation by 935–6
- L-phenylalanine, as source of chiral auxiliary 1113
- phenylalanine 16, 554, 1104, 1154
 1H NMR spectrum 274
 in aspartame synthesis 1118

- phenylglycine 236
- phenylhydrazine 232
in Fischer indole synthesis 916
reaction with carbonyl compounds 775–6
- phenylhydrazone 232
[3,3]-sigmatropic rearrangement of 916
- 8-phenylmenthol, as chiral auxiliary 1113
synthesis of 832
- phenylsilane 668
- phenylsodium, deprotonation of
dihaloalkanes using 1008
- phenyltrimethyl ammonium ion, nitration
of 486–7
- phenylramidol 703
- pheromone, of bee 47, 51, 57–8, 294
of boll weevil 1021
of fruit fly 803
of house fly 540–1
of Japanese beetle 4, 1104
of marine brown alga 915
of pea moth 360–1
of pig 1103
of silkworm 692
of termite 685
- phosgene 742
- phosphate ester, cyclic, in cAMP 1139
in nucleotides 1135–6
- phosphates, as leaving groups in ATP 1136
in primary metabolism 1135
- phosphine 656
as ligands for palladium 1072, 1078, 1093
for *in situ* reduction of Pd(II) 1080–1
- phosphine oxide 238, 656
as a by-product of the Wittig reaction 690
reduction to phosphine 1119–20
- phosphinimine 1176–8
- phosphites, as ligands for asymmetric
conjugate addition 1127
- phosphoenolpyruvate (PEP) 1153–4
2-phosphoglycerate 1154
- phosphonate, stabilization of enolate by 628
- phosphonium salts 237, 358, 627, 689
in the Wittig reaction 237
synthesis 358
- phosphonium ylids, in the Wittig reaction
237
compared with sulfonium ylids 665
- phosphoramidites, as ligands for asymmetric
conjugate addition 1127
- phosphorane 627, 689
- phosphoric acid, ¹H NMR 416
as catalyst in Friedel–Crafts acylations 494
as catalyst of E1 elimination of alcohols
389
- phosphorus oxychloride (POCl₃), reaction
with pyridone 729
reaction with quinolones 784
- phosphorus pentachloride (PCl₅), in synthesis
of acyl chlorides 215
- phosphorus pentoxide (P₂O₅), in synthesis of
nitriles from amides 213
- phosphorus tribromide (PBr₃), in synthesis of
alkyl bromides 348
- phosphorus, coupling to ³¹P in NMR 416
- phosphorus–oxygen bond, energy of P=O
double bond 238
- phosphoryl chloride *see* phosphorus
oxychloride
- phosphorylation, in nature, by ATP 1154
- photochemical [2+2] cycloadditions 896–8
electrocyclic reactions 926–7
sigmatropic shifts 921–2
- photolysis, of diazomethane 1005
of halogens 986, 988
- photorhodopsin 681
- photostationary state 681
- phthalazine-based ligands, in AD reaction
1124–6
- physical organic chemistry 240–68
- π bond, as nucleophile 113, 118
- π -complex 1071, 1073
- π orbital 91–5
- π^* orbital 91–5
- π -participation, in Baeyer–Villiger oxidation
956
- π -stacking complexes 1111–12
- picric acid (2,4,6-trinitrophenol) 176
- Pictet–Spengler reaction 1160–1
- pig pheromone 1103
- Pigment Red 254 9
- pigments and dyes, defined 149
- pinacol reaction 981–4
- pinacol rearrangement 945–9
reverse 949–50
semi- 947–9
- pinacolone, by rearrangement of pinacol 945
- pine forests, smell of 28
- pineapple, smell and taste of 659
- α -pinene 28, 840, 1164, 1167
- β -pinene 895–6
- piperazine 791
Buchwald–Hartwig cross-coupling of
1094–5
- piperidine 790–1
as amine for enamine formation 592
 pK_a of 175, 630, 726, 792
substituted, ring opening of epoxide fused
to 838–9
use in Mannich reaction 622
- piperazine, pK_a of 792
- piroxicam 458, 657
- pK_a 163–81, 205
of acetaldehyde 176
of acetic acid 169, 172, 176
of acetone 176
of acetonitrile 585
of acetylene (ethyne), an alkyne 170, 187
of alcohols 173
of alkynes 188
of amides 175, 176
of amidines 175
of amines 174
of ammonia 171
of ammonium ions 174, 213
of aniline 174–5
of aziridine 793
of benzene 188
of benzophenone imine 793
of butane 188
of carbon acids 176–7
of carbonyl compounds 595
of carboxylic acids 173, 176
- of chloric acid (HClO₃) 172
of chlorous acid (HClO₂) 172
of common organic acids 172–3
of cyclohexanol 173
of DABCO (1,4-diazabicyclo[2.2.2]octane)
791
of DBU 175
of dibutylamine 792
of diethylamine 792
of 1,3-dicarbonyl compounds 629
of difluoroacetic acid 176
of DMAP 740
of ethanol 172
of first row element ‘hydrides’, table 171
of fluoroacetic acid 176
of HBr 172
of HCl 169, 172
of HF 171, 172
of HI 170, 172
of histamine 178
of hydride ion 237
of hydrogen cyanide 188
of hydroxide (OH⁻) 170
of hypochlorous acid (HClO) 172
of imidazole 178, 741
of imine 726
of inorganic acids 170
of Meldrum’s acid 1090
of methane 170
of methanesulfonic acid 173
of morpholine 792
of nitriles 175
of nitroalkanes 611
of nitromethane 177, 586
of *para*-nitrophenol 176
of *para*-chlorophenol 176
of perchloric acid (HClO₄) 172
of phenol 173, 176
of piperazine 792
of piperidine 175, 630, 726, 792
of potassium *tert*-butoxide 213
of protonated amide 175, 212
of pyrazine 748
of pyridazine 748
of pyridine 175, 630, 726, 792
of pyrimidine 748
of pyrrole 732, 740
of quinuclidine 791
of sulfur-containing compounds 660
of sulfuric acid 170
of tetrazole 744
of triazole 743
of triethylamine 174, 791
of trifluoroacetic acid 176
of water 169, 170
- pK_a , and aldol chemoselectivity 623
and leaving group ability 202–4, 347–8, 792
and nucleophilicity 177, 355, 792
and substitution at saturated carbon 331,
347–8, 355–6
calculations with 169, 170, 171
comparison of carbon, nitrogen, and
oxygen acids 176–7
consideration in Claisen condensation 641
consideration in aldol reactions 629
correlation of reactivity with 1041–4

- definition of 165–9
 effect of delocalization 172–3, 175
 effect of electron withdrawing groups 175–6, 179
 effect of electronegativity 170, 171, 176–7
 effect of hybridization 175–6, 188
 effect of substituents 175–6, 179
 effects on halogen–lithium exchange 188
 factors determining 170–7
 inductive effect on 792
 relation to ^1H NMR shifts of O–H protons 283
 relationship to pH 167, 168–9
 role in development of the drug cimetidine 178–80
 small ring effects on 794
 solvent-dependent limits of 170–1
 summary of factors affecting 171
 pK_{aH} , definition and use of 174 *see also* basicity
 planarity, evidence for lack of in ring structures 368, 370
 plane-polarized light, rotation of 309–10
 planes of symmetry 304–6, 312, 320–1
 plants, terpenes from 1164–7
 platinum, as catalyst for hydrogenation 535, 537–8
 platinum metals 1070
 platinum oxide *see also* Adam's catalyst 535
 +/- nomenclature 310
 POCl_3 *see* phosphorus oxychloride
 poison dart frogs, neurotoxin from 680
 polar aprotic solvents 255–6
 polarimetry 309–10
 in analysis of enantiomeric excess 1111
 polarity of common solvents (table) 256
 polarization, effect on bond cleavage 960–2
 polarized light 309–10
 polio virus, drug 708
 polyester fibre manufacture 210
 polyethylene, structure 22
 polyketides 1129–30, 1156, 1163–4
 polymerization, entropy and 249
 of pyrrole in acid 733
 Ziegler–Natta 1076
 polyphosphoric acid (PPA) 777
 polysaccharides 229, 1135
 polystyrene 26
 polyunsaturated fats 31
 poly(vinyl chloride), PVC 30, 259
 polyzonimine 692
Popilia japonica 1104
 porantherine, synthesis of 549
 porphyrin, aromaticity of 753
 formation from pyrrole 753
 in haemoglobin 761–2
 retrosynthetic analysis of 761–2
 potassium amide, as base 589
 potassium carbonate, as weak base 587, 620
 potassium enolates 589
 conjugate addition of 607
 potassium hexamethyldisilazide (KHMDs) 589, 687
 potassium hydride, as base for thermodynamic enolate formation 599
 in base-accelerated sigmatropic rearrangement 914
 potassium osmate, in AD reaction 1123–6
 potassium permanganate, for oxidation of alcohols 546
 for oxidation of quinoline 750
 potassium *tert*-butoxide, as base for kinetic conjugate addition 607
 as base in E2 elimination 386
 pK_{a} of 213
 potassium tri-*sec*-butylborohydride *see* K-selectride
 PP *see* pyrophosphate
 PPA *see* polyphosphoric acid
 ppm, conversion to Hz, in NMR 288
 Pr, definition of 23
 pre-exponential factor, *A* 257
 prefixes, in compound names 27, 35
 prenyl bromide, reaction with phenols 575
 synthesis of 337, 435
 preservatives, acids as, in foodstuffs 165, 168
 primary alcohols, reaction with PBr_3 329
 primary carbocations, instability of 335
 primary carbon, meaning of 27
 primary metabolism 1134–5
 priority rules, in assignment of configuration 308
 prismane, isomer of benzene 143
 prochiral, definition of 822, 856–7, 1114
 faces and groups, nomenclature for 856–7
 prochirality, in asymmetric synthesis 1114
 in diastereoselective reactions 856–8
 progesterone 949, 1167
 projection, Newman 363–4
 prokaryotes 1141
 proline 16, 554, 1104
 as precursor to CBS catalyst 1114
 in collagen 1141
 to catalyse aldol reaction 1131–2
 propagation, of radical reactions 572–3, 985
 propane, barrier to rotation in 365
 bond angles in 365
 conformation of 365
 propane-1,2,3-trio 1147 *see also* glycerol
 propanedioic acid *see* malonic acid
 propanoic acid, as catalyst for orthoester hydrolysis 911
 propargyl alcohol 671
 propenal *see* acrolein
 propene, ^{13}C NMR spectrum 152
 propiconazole 11
 propionyl chloride, reaction with benzene 493–4
 propiophenone, reduction to propylbenzene 493–4
 propranolol 703–4
 synthesis 1064, 1121–2
 propylene oxide, ^{13}C NMR spectrum 62
 prostaglandins 533, 1162–3
 prostaglandin E_2 , synthesis of 604–5
 protease inhibitors, for treatment of HIV 1170–4
 protecting group 548–60
 acetal, for aldehydes and ketones 228, 549, 1175
 acetonides, for 1,2-diols, 808
 benzaldehyde acetals, for 1,3-diols 808
 benzyl amine, for amines 552
 benzyl ester, for carboxylic acids 557
 benzyl ether, for alcohols 551
 Boc, for amines 558, 739–40, 1172
 Cbz, ^1H NMR spectrum 275
 Cbz, for amines 556–7, 1172
 Fmoc, for amines 559
 glucose as nature's 1144–5
 methyl ether, for alcohols 551
 silyl ether, for alcohols 550, 635, 670–1
 silyl, for terminal alkynes 671
 tert-butyl ester, for carboxylic acids 555, 1172
 THP (tetrahydropyranyl), for alcohols 550
 protecting groups, assessing the need for 552
 for peptide synthesis 553–9
 for sugars 808
 summary 560
 protection *see* protecting groups
 proteins 1134–5, 1139–42
 biosynthesis of 1139–42
 structural 1141
 protic solvents 255–6
 protodesilylation 674
 proton (^1H) NMR *see* NMR, ^1H
 proton exchange, in ^1H NMR 284–5, 833
 proton nuclear magnetic resonance (NMR) *see* NMR, ^1H
 proton transfer, alternative mechanisms for 136
 during enolization 450–1
 in tetrahedral intermediates 201–2
 rate of 257–8
 proton, as electrophile 117
 mass of 51
 solvation by water 166
 protonation, of alcohols with sulfuric acid 173
 of amides 212
 protons, exchange for deuterium in ^1H NMR 275, 283–5
 provitamin D_2 921, 927
 pseudoaxial 829, 834
 vs pseudoequatorial attack, on cyclopentanone 834
 pseudoephedrine 314–15, 1113
 pseudoequatorial 829, 834
 vs pseudoaxial attack, on cyclopentanone 834
Pseudomonas putida 1103
p-toluenesulf-... *see* toluenesulf-...
 PTSA *see* toluenesulfonic acid
 puckered, conformation of cyclobutane 369
 puffer fish, poison from 790
 pulegone, synthesis of 832
 purine degradation, in human metabolism 751
 purines, as bases in nucleic acids 1136
 structure of 750–1
 push-pull effect, in fragmentation 961–2
 in pinacol rearrangements 945–6
 putrescine 29, 1157
 PVC *see* poly(vinyl chloride)
 pyran ring 469
 in sugars 1143
 pyranose 1143

- pyrazine 9, 724
 p*K*_a of 748
- pyrazole 725
- pyrazoles, alkylation of 769
 from 1,3-diketone and hydrazine 760, 768, 769
 nitration of 769
 retrosynthetic analysis of 768–9
- pyrethrins 11, 664, 1016
- pyrethrum flowers, chrysanthemic acid from 292
- pyridazine 724
¹H NMR spectrum 752
 from 1,4-diketone and hydrazine 759–60, 767–8
 from dihydropyridazolone 767–8
 nucleophilic substitution of 748–9
 p*K*_a of 748
 retrosynthetic analysis of 767
 α-effect in 748
- pyridine 37
¹H NMR spectrum 282, 724
 activated, electrophilic aromatic substitution of 729–30
 as a polar organic solvent 337, 726
 as a weak base 337
 as nucleophilic catalyst of acylation 199–200
 as nucleophilic catalyst of bromination 726, 731
 comparison of structure with benzene 724
 complex with chromium trioxide (Collins' reagent) 194
 conjugation in 282
 electrophilic aromatic substitution of 726–7
 Hantzsch synthesis 763–5, 783
 HOMO of 729–30
 nucleophilic substitution on 728
 orbital structure of 724
 p*K*_a of 175, 630, 726, 792
 reactivity of 725–6
 retrosynthetic analysis of 763, 766
 synthesis from 1,5-diketones 759, 765–6
 synthesis, from acetaldehyde and ammonia 758
 unreactivity towards Friedel–Crafts acylation 727
 unreactivity towards nitration 727
 use in Mannich reaction 624
- pyridine *N*-oxide 730–1
 2-methyl, reaction with acetic anhydride 731
 reduction to pyridine 730
- pyridinium chlorochromate *see* PCC
- pyridinium dichromate *see* PDC
- pyridinium tribromide 731
- pyridones 728–9, 781
 chlorination by reaction with POCl₃, 729
 from acetamide and 1,3-dicarbonyl 766–7
 from hydroxypyridines 728
- pyridoxal 235, 1151
- pyridoxal phosphate 1157–8
- pyridoxal transaminase 1159
- pyridoxamine 235, 1151
- pyrilium cation 733
- pyrimidine 724
¹H NMR spectrum 285–6
 p*K*_a of 748
- pyrimidines, as bases in nucleic acids 1136
 from amidine and 1,3-diketone 760, 770–1
 retrosynthetic analysis of 770
 role in biochemistry and medicine 754
- pyrolysis, of formate group 968
- pyrones, Diels–Alder reaction of 739
 structure and regioisomers of 732
- pyrophosphate (PP) 1166
- pyrrole 725
¹H NMR spectrum 283, 422, 725, 733
 acylation by Vilsmeier reaction 733–4
 asymmetric Friedel–Crafts reaction of 1128
 Boc protection of 740
 bond lengths in 733
 bromination of 733
 decarboxylation of 735
 delocalization in 733
 Diels–Alder reaction of 739
 electrophilic aromatic substitution reactions of 733–5
 formation of porphyrins from 753
 HOMO of 733, 744
 Knorr synthesis of 761–3
 Mannich reaction of 734
 nucleophilic substitution on 738–9
 nucleophilicity at nitrogen 740
 orbitals of 725
 p*K*_a of 732
 polymerization with acid 733
 retrosynthetic analysis of 758, 761–2
 synthesis, from 1,4-dicarbonyl compounds 758–9
 synthesis, strategies for substituted pyrroles 761–3
tert-butyl ester as blocking group with 761
- pyrrolidine 233, 790–1
 enamine formation with 592, 608
 in Mannich reaction 622
N-Boc, asymmetric lithiation of 1113
 rate of formation by ring-closing reaction 809–10
- pyrrolidine alkaloids 1156–8
- pyruvate 1153–4
- pyruvic acid (2-oxopropanoic acid) 28, 229, 1134–5, 1153–4
 conversion to alanine by reductive amination 235
 reduction by NADH to form (*S*)-(+)-lactic acid 1150
- Q**
- quartet, in ¹H NMR 291–2
- quartz crystals, chiral 323
- quaternary carbon, meaning of 27
- queen bee substance, synthesis of 685
- quinic acid 1155, 1175
- quinine 2, 723, 755, 780
- quinine-derived ligands, for Sharpless asymmetric dihydroxylation 749, 1123–6
- quinoline 749, 755
 as additive in catalytic hydrogenation 537–8
 by reaction of aniline with α,β-unsaturated carbonyl compounds 781
 from 1,3-dicarbonyl compounds and anilines 781–2
 nitration of 749
N-oxide 750
 oxidation with potassium permanganate 750
 retrosynthetic analysis and synthesis of 781–2
 role in biochemistry and medicine 755
 Skraup synthesis 781–2
 nucleophilic aromatic substitution of 784
- 8-quinolinol (oxine) 782
- quinolone 781
 reaction with POCl₃ 783–4
 retrosynthetic analysis and synthesis of 782–3
 synthesis, from enamine diester 783
- quinolone antibiotics 782–3
- quinone, as dienophile in Diels–Alder reaction 879
- quintet, in ¹H NMR 291–2
- quinuclidine, p*K*_a of 791
 structure of 791
- R**
- R* *see* gas constant
- R, as abbreviation for alkyl group 29
- R,S* nomenclature 308–9
- racemic mixture 307–8
- racemization, in S_N1 343–4
 of drugs *in vivo* 460
 of stereogenic centres adjacent to carbonyl groups 459–60
- radical abstraction 572–3, 972–3
- radical addition, borane-oxygen method 998–9
 C–C bonds by 992–9
 concentration effects in 994–5
 for formation of carbon–carbon bonds 993–4
 frontier orbital effects in 995–6
 of triplet carbenes to alkenes 1015
 regioselectivity of 571–2, 574
 tin method 993–6
 to acrylonitrile 993–4
 to alkenes 571–2, 971, 973, 992–7
- radical anions and cations, in mass spectrometry 47
- radical bromination, allylic 989–90
 of alkanes 988–9
- radical chain reaction 571–4, 984–1102
 of alkene with HBr 984–5
 summary of steps in 985–6
- radical chlorination, regioselectivity of 986–8
- radical copolymerization 997
- radical initiator, AIBN as 991–2
 borane-oxygen as 998–9
- radical reactions 571–4, 970–1002
 intramolecular 999–1002
 regiocontrol in 571
- radical substitution 972–3, 990–2

- radical–radical reactions 980–4
by borane–oxygen method 998–9
- radicals, by dissociation of hydrogen chloride 970
- captodative 978
- conjugate addition of 998–9
- EPR for determination of structure 975–6
- formation, by addition 973
by elimination 974
by homolysis of weak bonds 971–2, 974, 985
by hydrogen abstraction 972–3
by photochemical homolysis 971
summary 974
- from dissolving metal reactions 542–3
- hard/soft reactivity of 997–8
- in acyloin reaction 983–4
- in Birch reductions 542–3
- in mass spectrometry 47
- in McMurry reaction 982–3
- ketyl, pinacol reaction of 981, 983–4
- molecular orbitals (SOMO) of 976–9
- persistent 974–5, 979
- reduction of carbonyl group via 981
- regiocontrol in reactions of 571
- stability, factors affecting 977–9
- summary of reactions 980, 998
- trapping by vitamin E 975
- unreactive 974–5, 979
- writing mechanisms involving 972
- radical-stabilizing groups, summary of 979
- radio waves, in NMR 53
- radioactive isotopes, use and disadvantages of 1037–8 *see also* isotopic labelling
- Raney nickel 537
for reduction of aromatic nitro groups 728
for reduction of sulfides and thioacetals 540, 663
for reduction of thiophene 737
- ranitidine 512
- raspberry ketone 536
- raspberry ketone, ¹³C NMR spectrum 409
- rate constant, *k* 257
- rate-determining step (rate-limiting step) 257–8
change of 1049
experimental determination of 1041–8
in S_N1 and S_N2 reactions 330, 332
- rate equation 257–62
experimental determination of 330
for S_N1 332
for S_N2 330
use in determining reaction mechanisms 1031–2
- rate-limiting step *see* rate-determining step
- rate of bond rotation, relation to energy barriers 363
- rate of reaction 250–66
effect of pH 262–3
effect of solvents 255
intramolecular vs intermolecular 938
nucleophilic substitution, effect of participation on 931–2
ring formation and relation to size 806–7
S_N1 and S_N2, factors affecting 331–2, 347–8
compared 345–6
- rates, and spectroscopy 374
- Re* and *Si*, in assignment of prochiral faces and groups 856–7
- reaction constant, *p* 1043–4
- reaction coordinate, definition of 243
- reaction intermediates 253
detection by spectroscopy 419–20
effect of solvent on 256
variation of concentration with time 264
- reaction kinetics 250–66
- reaction mechanism, detecting change of 1048
drawing curly arrows for 109, 120–4
establishing experimentally 1029–68
relationship to kinetics 258
- reactivity, poor correlation with bond strength 207
quantified effects of structure (Hammett relationship) 1041–8
relation to ¹H NMR chemical shifts 280, 281
- reagent control, in asymmetric synthesis 1113–14
- rearrangement, [1,5]-sigmatropic 919–22
[3,3]-sigmatropic 731
allylic, palladium catalysed 1097
Beckmann 958–60, 1145
benzilic acid 950
by alkyl group migration 940–4
by ring expansion to relieve ring strain 944–5
Claisen 909–12
Cope 913–17
Curtius 882, 1022
during Friedel–Crafts alkylation 945
Favorskii 950–3
guidelines for spotting 945
Ireland–Claisen 914
Lossen 1022
of carbenes 1020–1
of carbocations 940–5
of dienone to phenol 949–50
of diols 945–6
of epoxides 946
of nitrenes 1022
of β-halo amine 938
orbital description of 941–2
Payne 938–9
pinacol 945–9
semipinacol 947–9
sigmatropic 909–22
stereochemistry of 957–8
Wagner–Meerwein 942–4
Wolff 1021
working out mechanisms for 941, 943–5
- rearrangement reactions 931, 937–59
- recrystallization, for purification 1112
to improve ee 1112
- red wine, resveratrole from 1164
- RedAl, to reduce alkynes to *E* alkenes 682–3
- reduced mass 64–5
- reducing agents 530–43
bulky 603
chiral 1114–17
effect of size on diastereoselective reactions 826–8, 832, 834
- in nature (NADH or NADPH) 1140, 1149–50
summary (table) 534
- reduction *see also* catalytic hydrogenation
asymmetric, using CBS catalyst 1114–15
asymmetric, by hydrogenation 1115–17
in nature 1150
- Birch, of aromatic rings or alkynes 542–3, 973
- Bouveault–Blanc 981
by single electrons 542–3, 973, 981
chelation-controlled stereoselectivity of 863
chemoselective, of ketone in presence of ester 529
summary table of chemoselective reducing agents 534
- Clemmensen 493–4
- diastereoselective, of a cyclopentanone 834
of a four-membered ketone 833
of a spirocycle diketone 847
of bridged bicyclic compounds 840
of chiral carbonyl compounds 858–61
of Wieland–Miescher ketone 845
- dissolving metal, of enones 602–3
- Luche 506
- of alkenes 534–7 *see also* hydrogenation
of alkynes 537, 542–3 *see also* hydrogenation
- of amides 701, 702
- of aromatic rings 537, 542
- of aromatic nitro groups 495, 728, 769
- of benzylic ketones to methylene groups 493–4
- of carbonyl compounds, chemoselectivity in 530
- of chiral ketone, chelation control in 864
Felkin–Anh model for 861
- of conjugated double bonds 603
- of diazonium salt to hydrazine 777
- of imines by catalytic hydrogenation 538
- of isoxazoles 751
- of ketone with borohydride 119, 257–8
- of nitrile to amine 716
- of nitroalkene to nitroalkane 623, 624
- of N–O bonds by zinc 902
- of oximes 702
- of pyridine *N*-oxides 730
- of sulfones, by sodium amalgam, in Julia olefination 686
- of thiophene with Raney Ni 737
- of α,β-unsaturated ketones in presence of cerium chloride 506
- reductive amination 234–7, 538, 701–2
asymmetric, in nature 1150–1
by catalytic hydrogenation 538
to form amine 701–2
using a nitrile 716
with benzylamine 717
- reductive elimination, in palladium catalysed reactions 1074–87, 1093, 1096
in transition metal complexes 1074–5
reflux 245
- Reformatsky reaction 631, 713
- refractive index changes, detection by HPLC 1111

- regiocontrol *see also* regioselectivity
 in synthesis of aromatic compounds 566–8
 strategies for 563–82 *see also*
 regioselectivity
 using tethers 568–9
- regioselectivity 562–83
 by kinetic or thermodynamic control 566
 enones to control in enolate formation
 601–5
 from elimination reactions 569–70
 of alkylation of acetoacetate dianion 601
 of alkylation of ketone enolates 590, 592,
 595–604, 613
 of allylic substitution using palladium
 1088–92
 of aromatic sulfonation 565
 of attack on cyclic sulfates 1125
 of Baeyer–Villiger oxidation 953–8
 of benzyne reactions 524, 568
 of Birch reductions of aromatic
 compounds 542–3
 of Claisen condensation of ketones 645
 of conjugate addition to α,β -unsaturated
 carbonyl compounds 504–8, 581–2
 of cycloaddition to form triazoles 775
 of Diels–Alder reactions 889–91
 of electrophilic addition to alkenes 433–5
 of electrophilic aromatic substitution
 479–80, 486–90, 565
 of epoxide opening 438–9, 836–9, 1125
 of formation of enamines and enols 592
 of formation of enolates from ketones,
 summary 601
 of halogenation of ketones 469
 of halolactonization 568–9
 of Heck reaction 1080–1
 of hydration of alkenes and alkynes 444–7,
 571
 of hydroboration of alkenes 446–7
 of intramolecular reactions 568–9, 653–4,
 891
 of nitrosation of ketones 464–5
 of nucleophilic aromatic substitution
 515–17
 of nucleophilic attack on bromonium ions
 436–7
 of opening of cyclohexene epoxides 836–9
 of photochemical [2+2] cycloadditions 898
 of radical bromination of an alkene 986
 of radical reactions compared with ionic
 reactions 571–4, 986
 of reactions of indole 746
 of reactions of pyrrole, thiophene, and
 furan 735
 of reactions of silanes 672–7
 of reactions of vinyl, aryl, and allyl silanes
 676
 of ring opening of aziridine 939
 of S_N1 reactions 336–7
 of sulfonation of toluene 485–6
- regiospecific, definition of 577
- Reissert indole synthesis 779–80
- relative configuration 313, 1104
- relative stereochemistry 313, 1104
 control of 825–76
- relaxation, of protons, in ^1H NMR 799
- between axial substituents 374–8
 between molecules 108–9
 between orbitals in eclipsed conformation
 364–5
- resolution 322–7, 1106–7, 1111, 1133, 1173
- resolving agent 325
- resveratrole 6, 1164
- retinal 1, 681
 ^{13}C NMR spectrum 409
- retro-aldol reaction 605–6
- retro-Diels–Alder reaction 739–740, 884–5
- retrosynthetic analysis (retrosynthesis)
 694–722
 chemoselectivity problems in 698–9
 common starting materials for 711–12
 definition of terms used in 697, 712
 donor and acceptor synthons in 712
 functional group interconversion (FGI) in
 699–702
 of 1,2-difunctional compounds 720
 of 1,3-difunctional compounds 713, 717
 of 1,4-difunctional compounds 721–2,
 760, 770
 of 1,5-difunctional compounds 719
 of 2-amino alcohols 715
 of 3-amino alcohols 715, 716–17
 of 3-amino ketones 716
 of 3-hydroxy ketones 713
 of acetals 715
 of alkenes 707, 720
 of alkynes 706–7
 of amides 695, 696, 701
 of amines 698, 699–702
 of aromatic heterocycles 757–88
 of diols 720
 of esters 695, 698, 707
 of ethers 696–9, 704, 708, 717
 of furan 758–9
 of pyrrole 758
 of sulfides 697–8
 of α,β -unsaturated carbonyl compounds
 713–14
 of β -hydroxy ketones 713
 umpolung reactivity in 719–21
 using aldol reaction 712
 using Claisen ester disconnection 717
 using Friedel–Crafts acylation 720, 722, 782
 using Mannich reaction 716–17
- retrosynthetic arrows 694
- reverse cycloaddition *see also* retro-
 Diels–Alder
 [2+2], in olefin metathesis 1024
 [3+2] 685, 906
 [3+2], in decomposition of THF 795
- reverse electron demand Diels–Alder
 reactions 887
- reverse oxypalladation 1097
- reverse pinacol rearrangement 949–50
- reverse transcriptase inhibitor 1171
- reversibility, of cyanohydrin formation 128
 of Diels–Alder reaction 884–5
 of reactions on heating 248–9
 of sigmatropic rearrangements 918
- ρ (rho), reaction constant 1043–4
- rhodium, as catalyst, for asymmetric
 hydrogenation 1117–19
 for carbene insertion 1019–20, 1023
 for hydrogenation 535
 for nitrile reduction 716
 carbene complex of 1007
- rhodopsin 681
- ribofuranose 1143
- ribonucleic acid *see* RNA
- ribonucleotide 1143
- ribopyranose 1143
- ribose 137, 315–16, 1134–7, 1142–3
- ribosome 1139, 1180
- ring-closing metathesis 1023–4
- ring-closing reactions, activation energy of
 806–7
 classification of, by Baldwin's rules 810
 effect of ring size on reactions 806–7
 in synthesis of saturated heterocycles
 805–13
 thermodynamic control of 808–10
 Thorpe–Ingold effect in 808–10
- ring closure, electrocyclic 922–3
- ring contraction, in Favorskii rearrangement
 952
- ring current, effect on ^1H NMR chemical
 shifts 277
- ring expansion, by fragmentation 963–5
 in α -caryophyllene alcohol synthesis 944–5
 of cyclic ketone using diazomethane 949
- ring flipping, of *cis*-decalin, 845
 impossibility of in *trans*-decalins and
 steroids 378–9, 381
 in substituted cyclohexanes 838
 of six-membered rings 373–4, 376–81
- ring formation, kinetic control of 806–10
 rate and relation to size 806–7
 thermodynamic control of 808–10
 Thorpe–Ingold effect in 808–10
- ring inversion *see* ring flipping
- ring opening, Baldwin's rules for 810, 813–14
 electrocyclic 922–4, 928–9
 of aziridine 793, 929
 of cyclic ethers 794
 of epoxides, stereospecificity of 854
 of small rings, by electrocyclic reactions
 928–9
 regioselective, of cyclohexene oxides of
 reactions 836–9
- ring size, and ^1H NMR 814–17
 and geminal (?) coupling 819–20
 and neighbouring group participation 935
 small, medium, and large, definition of
 806
 thermodynamic control of in acetal
 formation 808
- ring strain 366–8
 and leaving group ability 351–2
 driving ring-opening reactions 793–4
 driving rearrangement 944–5
 effect on IR carbonyl stretching frequency
 413
 effect on orbital hybridization 413
 effect on rate of ring formation 806–7
- ring synthesis, by double alkylation of
 1,3-dicarbonyl compounds 598
 by intramolecular acyloin reaction of
 esters 984

- by intramolecular alkylation 586–7
- by intramolecular radical reactions 1000–1
- by palladium catalysed cyclization 1091
- five-membered, by [3+2]-dipolar cycloadditions 901–5
- four-membered, by [2+2] cycloadditions 897–901
- heterocycles, aromatic 757–788
 - saturated 805–14
- seven membered, by [4+3] cycloadditions 893–4
- ten-membered, using Stille coupling 1084
- by alkene metathesis 1023–4
- rings, bicyclic, stereoselectivity in 839–49
 - bond angles in (table) 367
 - bridged bicyclic, stereoselectivity in 839–41
 - cis* and *trans* alkenes in 678–9
 - diastereoselectivity in, summary 851
 - effect on nucleophilicity of heteroatoms 791–2, 794
 - evidence for lack of planarity in 368, 370
 - five-membered, ¹H NMR couplings in 817
 - conformation of 370, 834–5
 - stereoselective reactions of 835–6
 - formation by metathesis 1099–100
 - four-membered, ¹H NMR coupling in 816–17
 - conformation of 369, 833
 - stereoselective reactions of 833
 - fused bicyclic, stereoselectivity in 841–6, 841–6, 848–50
 - in transition states and intermediates 847–51
 - saturated, rate of ring-closing reactions 806
 - six-membered, ¹H NMR and axial/equatorial substitution 797–9, 802, 818–19
 - conformational preference in 456, 457–74, 826–32, 837–9
 - diastereoselective attack on 826–9
 - equatorial vs axial attack on 825–32
 - germinal (?) couplings in 819–20
 - how to draw 371–4
 - opening of epoxides fused to 836–9
 - reactions of 826–32, 837–9, 850–1
 - small, effect on p*K*_a 794
 - fragmentation in 961
 - small, medium, and large, definitions of 368
 - spirocyclic, stereoselectivity in 846–7
 - temporary, for control of stereochemistry 847–51
 - three-membered, conformation of 369
 - NMR coupling in 815
- ritonavir 10
- Ritter reaction 353, 1173
 - determination of mechanism 1065–6
 - relationship to Beckmann fragmentation 959–60
- RNA (ribonucleic acid) 1136, 1138–9
 - biological synthesis of 1139
 - stability compared with DNA 1138–9
- Robinson, Robert 638
- Robinson, tropinone synthesis of 1158
- Robinson annelation 638–9
- roglitimide 707–8, 719
- 'roofing', in ¹H NMR 298, 822
- rose oxide ketone 790
- rose, pigment from 1145
 - smell of 4
- rosoxicin, structure and synthesis of 783
- rotation, of amide bond, rate constants 256
 - of bonds 360–1
 - energy barriers 362–3
 - in ¹H NMR 274
- rotation, of plane-polarized light (optical rotation) 309–10
- ruminants, cellulose digestion in 1147
- ruthenium, as catalyst 1099–100
 - for alkene metathesis 1023–7
 - for asymmetric reduction of carbonyl group 1115–17
 - for hydrogenation 535
 - in asymmetric hydrogenations of alkenes 1116–19
- S**
- s orbital 84–5
- SAC *see* specific acid catalysis
- saccharides 1146–7
- saccharin, synthesis of 485
 - para*-toluenesulfonic acid as by-product 227
- S-adenosyl methionine (SAM) 1136–7, 1157–8, 1160
- salbutamol, protecting group strategy in synthesis of 552
- salen (salicylthylenediamine) ligand 1122–3, 1179
- salicylic acid, synthesis and ¹³C NMR spectrum 409, 481–2
- salmefamol 530
- SAM (S-adenosyl methionine) 1136–7, 1157–8, 1160
- sandalwood oil, fragrance 942
- sandaverine, synthesis of 793
- santene 942
- saponification 212
- saturated carbons, protons attached to in ¹H NMR 272–6
- saturated fats 31, 211, 536
- saturated fatty acids 1161
- saturated, meaning of 29
- Saytsev's rule 399
- SBC *see* specific base catalysis
- s*-Bu *see* *sec*-butyl
- Schiff base 235
- Schlosser's base 1008, 1019
- Schotten, Carl 203
- Schotten–Baumann method 203
- Schreiber, Stuart L. 929–30
- Schrock, Richard 1025, 1084
- s*-cis 879–80
- scurvy, cause and treatment 1141
- Seagal, Irving 1171
- sea-hare (*Dolabella*), anticancer agent from 861
- seaweed pheromone, [3,3]-sigmatropic rearrangement of 915
- sec*-butanol, inversion by S_N2 343
- sec*-butyl 26–7
- second law of thermodynamics 246
- second-order reaction 258–9, 329, 331–3
- secondary carbon, meaning of 27
 - carbon, S_N2 at 341–3, 347, 380–1
- secondary metabolism 1134, 1156
- selectivity *see also* chemoselectivity, regioselectivity, and stereoselectivity 528
- selectride *see* L-selectride, K-selectride
- selenium dioxide, in allylic oxidation of alkenes 919
- selenium, and sulfur compared 686
 - oxidation to selenoxides 685–6
- selenoxides, by oxidation of selenides 685–6
 - elimination to form alkenes 686
 - in [2+3]-sigmatropic rearrangements 918–19
- self-condensation, avoiding 585–613
 - in aldol reactions 616–18
- semicarbazide 232
- semicarbazone 232
- semipinacol rearrangement 947–9
- separation of enantiomers 322–7
- septamycin, step in synthesis of 218
- serine L-serine, as starting material in asymmetric synthesis 873–5, 1107
- serine 554, 1104
- serotonin 1, 755, 777
- serricornin 4
- seven-membered ring synthesis, by [4+3] cycloaddition 893–4
- sex hormone 379, 949, 1167
- S-glycosides 1145–6
- shape, of molecules 80–105
- Sharpless, K. Barry 1116
- Sharpless asymmetric aminohydroxylations (AA) 1120
- Sharpless asymmetric dihydroxylations (AD) 1120, 1123–6
- Sharpless asymmetric epoxidation (AE) 1120–3, 1172
- Sharpless 'click' synthesis of triazoles 775
- shell, in electronic structure 86
- shielding, in NMR 54, 270
- shifts, chemical *see* chemical shifts
 - sigmatropic 919 *see also* sigmatropic shifts
- shikimic acid 1154–6, 1163
 - ¹³C NMR spectrum 409
 - in synthesis of oseltamivir (Tamiflu) 1175
 - pathway 1154–6
- short-cuts (short-hand), allowable when drawing mechanisms 204, 217, 267
- shower gel, ingredients of 6–8
- Si* and *Re*, in assignment of prochiral faces and groups 856–7
- σ bond, as a nucleophile 113, 119
- σ orbital 91–5
- σ* orbital 91–5
- σ, substituent constant 1042–3
- σ-complex 1071
- σ-conjugation 484
- sigmatropic 910
 - [1,3]-sigmatropic hydrogen shifts 921, 919–22
 - [1,5]-sigmatropic hydrogen shifts 919–21
 - [1,7]-sigmatropic hydrogen shifts 921

- [2,3]-sigmatropic rearrangement 917–19
 [3,3]-sigmatropic rearrangement 731, 909–17
 in Fischer indole synthesis 776
 in synthesis of citral 915
 of silyl enol ethers and lithium enolates 914
 sigmatropic reactions (rearrangements)
 909–22
 reversibility of 918
 sigmatropic shifts 919–21
 silanes 656, 668
 alkynyl, for protection and activation
 671–2
 allyl, as nucleophiles 675–7
 aryl, *ipso* substitution with electrophiles
 672–3
 reactivity of, compared to alkenes 675
 regioselectivity of reactions of 672–7
 vinyl and aryl and allyl, reactions with
 electrophiles, summary 676
 vinyl, electrophilic substitution of 673–4
 sildenafil *see* Viagra
 silica, SiO₂ 325
 silicon, affinity for electronegative atoms
 668–9
 compared with carbon 668–74
 in organic chemistry 669–77
 nucleophilic substitution at 469, 669
 β-cation stabilization by 672
 silkworm, pheromone of 692
 silver nitrate, in rearrangement of neopentyl
 iodide 940
 silver oxide, as halogen-selective Lewis acid
 934
 silyl enol ethers, [3,3]-sigmatropic
 rearrangement of 914
 ¹H NMR spectrum 280–1, 282
 alkylation of 595
 as specific enol equivalent 624, 466–7
 for regioselective halogenation 469
 formation, from lithium enolates 466
 thermodynamic control in 599–600, 636
 in aldol reactions 626
 in conjugate additions 608–9
 of esters 631
 palladium catalysed oxidation to enones
 1097
 reaction with PhSCl 470
 stability, influence of substitution on 600
 silyl ethers,
 as protecting group 549–50, 635, 670
 for alcohols 670
 cleavage by TBAF 669
 from acyloin reaction of esters with TMSCl
 984
 removal of 550
 silyl groups, as 'super-protons' 671–3
 silyl halides, regioselective reaction with
 enolates 466–7
 silyl ketene acetals 609
 silyl triflates 670
 silylating agents, in conjugate addition
 reactions 508
 Simmons–Smith reaction 1009, 1017–18
 single bonds, region in IR spectrum 65
 single electron reductions 973
 singlet carbene *see* carbene, singlet
 singlet, in ¹H NMR 286
 singly occupied molecular orbital *see* SOMO
 Singulair *see* montelukast
 sinigrin 1145
 sirenin 1018
 six-membered rings 456, 457–74
 ¹H NMR of axial vs equatorial substitution
 818–19
 conformational preference in 826–32,
 837–9
 equatorial vs axial attack 825–32
 fragmentation of in synthesis of
 nootkatone 968
 geminal (*γ*) couplings in 819–20
 how to draw 371–4
 opening of epoxides fused to 836–9
 rate of reaction 806–7
 S_N2 reactions on 379–81
 stereochemical control in 826–32, 837–9
 synthesis by [4+2] cycloadditions 878–93
 vicinal (*β*) coupling in 797–9, 802
 16-electron complexes 1070
 skeleton, of insects and crustaceans 1147
 Skraup quinoline synthesis 781–2
 skunk, smell of 4, 657
 small rings, definition of 368, 806
 effect on pK_a 794
 smell, and stereochemistry 1102–3
 Smith, Kline and French 178
 SmithKline Beecham 178
 S_N1 and S_N2 *see also* substitution
 S_N1 and S_N2 mechanisms, choice between
 333, 347
 contrasts between 342–7
 effect of leaving group 347–52, 357–8
 effect of nucleophile 352–8
 electronic effects 346–7
 kinetic evidence for 329–33
 reaction rate and structure (table) 342,
 345–6, 347, 355–6
 relative rates compared 345–6
 solvent effects 344–6
 stereochemical consequences 343–4
 steric effects 342–3, 380–1
 S_N1 reaction, competition with E1
 elimination 467–8
 energy profile diagram 334
 examples of 336, 558
 of allyl systems 576
 regioselectivity in 336–7
 with aromatic electrophiles *see*
 nucleophilic aromatic substitution,
 S_N1 mechanism
 with benzene as nucleophile 477
 S_N2 reaction 340–2, 557
 at secondary centre 341–3, 347
 at tertiary centre 343, 347, 705
 effect of nucleophiles, (tables) 355–6
 in opening of epoxide 438
 inversion of stereochemistry in 439–41
 loose *see* loose S_N2
 molecular orbitals and 356
 on allylic compounds 574, 578–9
 on six-membered rings 379–81
 stereospecificity of 853
 transition state of 340–1, 343
 S_N2' reaction 574
 compared with S_N2 574–5
 S_NAr *see* nucleophilic aromatic substitution
 S_EAr *see* electrophilic aromatic substitution
 soap 212, 1148
 SOCl₂ *see* thionyl chloride
 sodium, for reduction of carbonyl group 973,
 981, 983–4
 sodium acetylide, from deprotonation of
 acetylene 171, 187, 189
 sodium amalgam, as reducing agent in Julia
 olefination 686
 sodium amide, as base 170–1, 187, 589
 in formation of benzyne 523–5
 sodium borohydride 131–2, 193, 251, 253 *see also*
 borohydride
 chemoselectivity of reactions with
 carbonyl compounds 132
 comparison with lithium aluminium
 hydride 132
 for reduction of aldehydes and ketones
 130–2, 530–1
 in demercuration 444–6
 in radical chain reactions 994
 mechanism of reduction with 131
 reduction of lactones 617
 of α,β-unsaturated carbonyl compounds
 506, 536–7
 of α,β-unsaturated nitro compounds 511
 sodium bromide, insolubility in acetone 255
 sodium chloride, bonding in 96–7
 energy level diagram of 97
 in Krapcho decarboxylation of esters 598
 reaction with sulfonic acid 477
 sodium cyanide *see* cyanide
 sodium cyanoborohydride 234
 sodium enolates 589, 607
 sodium ethoxide, as a base 644, 596
 sodium hexamethyldisilazide
 (NaHMDS) 589
 sodium hydride, as base in Claisen
 condensation 645, 654
 sodium hypochlorite (bleach) 195, 1123
 sodium in liquid ammonia, as reducing agent
 542–3, 682
 sodium iodide, solubility in acetone 255
 sodium nitrite, in formation of diazonium
 compounds 521
 in nitrosation of enols 464–5
 sodium periodate 443, 661
 sodium triacetoxyborohydride 234
 sodium trichloroacetate, in dichlorocarbene
 synthesis 1009
 sodium triphenylmethyl, as base 643
 sodium vapour lamps 82
 soft and hard nucleophiles 357, 658
 radicals 998
 Solanaceae alkaloids 1156
 solanine, alkaloid 1156
 solenoid 277
 solubility, of acids and bases 163–4
 solvation, of salts by water 255
 solvent choice, for ionic salts 187, 345
 for organometallics 187
 in organic reactions 255
 solvent effects, in S_N1 and S_N2 344–6

- solvent isotope effect, use in determining reaction mechanisms 1055–6
- solvent peak, in ^{13}C NMR 55
- solvent, as catalyst 256–7
- as nucleophile 337–8, 345–6, 353
- as reagent 255 *see also* solvolysis
- choice of, for ionic salts 187, 345
- classes of (protic, aprotic, polar, non-polar) 163, 255–6
- deuterated, for NMR 272, 284–5
- dielectric constants (polarity) of (table) 256
- effect on Diels–Alder reaction 888
- effect on reaction rates and products 255–7
- effect on $\text{S}_{\text{N}}1$ vs $\text{S}_{\text{N}}2$ substitution reaction 344–6
- for organolithium and Grignard reagents 186, 255, 795
- in limiting pK_{a} 170–1
- pyridine as 337, 726
- solvolysis 337–8, 931–2
- SOMO (singly occupied molecular orbital) 976–7, 995–7
- Sonogashira coupling 1083, 1087–8
- sp orbital 102
- sp² orbital 100–2
- sp³ orbital 99–100
- sparteine 1113–14
- spear-mint odour, (*R*)-(-)-carvone 1102–3
- specific acid catalysis (SAC) 262, 1053
- evidence for 1053–5
- in acetal hydrolysis 1059
- in dienone–phenol rearrangement 1054
- in ester hydrolysis 1053
- inverse solvent isotope effect in 1054–5
- specific base catalysis (SBC) 262, 1053
- evidence for 1055–6
- in epoxide opening 1055
- in hydrolysis of ester 1056
- specific enol equivalents (table) 624–5
- for aldehydes and ketones 591–5, 595, 632, 634
- for control of acylation 648–52
- for esters 631
- from 1,3-dicarbonyl compounds 628
- Wittig reagents as 627
- specific rotation 310
- spectrometry, mass *see* mass spectrometry
- spectroscopic methods, for identification of unknown compounds 72–8, 418–22
- summary of 46, 408
- spectroscopy 43
- and rates 374
- EPR (ESR) *see* EPR
- for detection of reactive intermediates 419–20
- NMR *see* NMR, ^1H NMR or ^{13}C NMR
- sphingosine 683
- spider toxin, synthesis of 236–7
- spin, of electrons 84
- spin-flipping, in carbenes 1014–15
- spiro compounds 432, 653
- chirality of 320
- spiroacetals 803
- spirocycles, stereoselectivity in 847
- synthesis via pinacol rearrangement 946
- spiroepoxides 432
- spiroketals 803
- square brackets, in nomenclature of sigmatropic rearrangements 910
- in terminology of cycloadditions 894
- stability, of cyclic and acyclic hemiacetals and acetals 223, 227, 247
- of radicals, factors affecting 977–9
- of tetrahedral intermediates 200–1, 218–20
- stability, relative, of *cis* vs *trans* alkenes 241
- stabilized ylids 689–90, 691–3
- staggered conformation 363–4
- stannanes, in Stille coupling 1084–7
- star anise 1175
- starting materials, choosing, for synthesis 711–12
- stationary phase, chiral, for determination of enantiomeric excess 1111
- in chromatography 325–7
- Staudinger reaction 1176
- stearic acid (octadecanoic acid) 212, 536, 1161
- stereochemical memory 835
- stereochemistry 302–27
- absolute 313
- control of 1102–33
- as means of determining reaction mechanisms 1063–7
- cis* vs *trans*, and coupling constants 815
- drawing 21
- effect on fragmentation 962–4
- elucidation using NOE 799–800
- in rings, control of 825–51
- in $\text{S}_{\text{N}}1$ and $\text{S}_{\text{N}}2$ reactions 343–4
- indication of neighbouring group participation 932–4, 936–7
- inversion of in Mitsunobu reaction 350–1
- of [2,3]-sigmatropic rearrangements 917–18
- of electrocyclic reactions 925–6, 929
- of epoxide opening 352, 354
- of ester formation 351
- of sigmatropic shifts, summary 919–21
- of sugars 1142–5
- relative 313
- control of 825–76
- stereoelectronic effects 789–824
- and conformation of saturated heterocycles 801–5
- anomeric effect 801–3
- explanation for Baldwin's rules 810–14
- in acyclic acetals 804
- in esters 804–5
- orbital requirements for 804
- summary 801
- stereogenic centre 306–7
- how to draw 309
- nitrogen as in aziridine 794
- compound with more than one 313–17
- stereoisomers 303, 306, 309, 311, 361
- number of possible 316–18
- of imines and oximes 231
- of substituted cyclohexanes 376–8
- stereoselective, definition of 396, 852
- stereoselectivity, effect of chelation 862–5
- Felkin–Anh control 864
- in [2+2] cycloadditions 897, 900–1
- in reactions of vinyl silanes 673–4
- in alkylation of enolates 603, 604–5, 867–8
- in bicyclic molecules 839–49
- bridged bicyclic compounds 839–41
- fused bicyclic compounds 841–6, 848–50
- spirocyclic bicyclic compounds 846–7
- in cyclic molecules 825–51
- in Diels–Alder reaction 881–9
- in five-membered rings 834–6
- in four-membered rings 833
- in synthesis of alkenes, summary 693
- of Alder ene reaction 895–6
- of alkene dihydroxylation 905–6
- of alkene hydrogenation 842, 845
- of allylic substitution using palladium 1088–92
- of carbonyl ene reaction 896
- of catalytic hydrogenation 535
- of Claisen rearrangement 910–11
- of electrophilic addition to alkenes 439
- of elimination reactions 678, 853–5
- of epoxidations of alkenes 514, 866–7
- cyclic alkenes 843–4, 850–1, 855
- of rearrangement reactions 957–8
- of the Heck reaction 1081–2
- of the Julia olefination 686–7
- of the Wittig reaction 690–3
- with cyclic transition states and cyclic intermediates 847–51
- stereospecific, definition of 396, 852
- stereospecificity, in cross-coupling reactions 1082
- in epoxidation of alkenes 430–1, 514, 854–5
- in synthesis of alkenes 688–93
- of electrophilic addition reactions 440–1, 853–4
- of epoxide opening reactions 854
- of iodolactonization reactions 853–4
- of Peterson elimination 688–9
- of singlet vs triplet carbene reaction with alkenes 1014–15
- of $\text{S}_{\text{N}}2$ reactions 853
- steric hindrance 129
- effect on reactivity of radicals 979
- effect on regioselectivity of electrophilic aromatic substitution 483
- in nucleophilic additions to carbonyl compounds 129
- in $\text{S}_{\text{N}}1$ and $\text{S}_{\text{N}}2$ reactions 342–3, 380–1
- steroids 639, 848–50, 1156, 1167
- conformation of 379, 841
- synthesis in nature 1167
- stilbene, asymmetric dihydroxylation of 1124
- epoxidation of 431
- reaction with NBS and water 441
- Stille coupling 1083–5
- stomach, pH of 163
- Stork, Gilbert 634
- strain, in rings 366–8
- s-trans* 804–5, 879–80
- conformation, of esters 804–5
- Strecker reaction 236, 307–8, 324
- Streptomyces* fungi 1020

- stretching frequency, in IR 64 *see also* IR spectra
- structural variation, for determination of reaction mechanisms 1034, 1036, 1040–8
- structure determination 43–78, 407–26
by ^1H NMR 269–301
by degradation 1037
- structure, of molecules 80–105
- strychnine 25, 745
- styrene, reaction with hydrogen bromide 433
- substituent constant, σ 1042–3
- substituent effects, in Hammett relationship 1041–8
- substituents, axial and equatorial 371, 374–7
effect on radical stability 977
effect on ring-forming reactions 808–10
- substitution *see also* $\text{S}_{\text{N}}1$, $\text{S}_{\text{N}}2$
and elimination, competition between 384–6
aromatic *see* nucleophilic or electrophilic aromatic substitution
at saturated carbon and $\text{C}=\text{O}$ compared 355–6
at the carbonyl group 197–221, 262–3
with loss of $\text{C}=\text{O}$ 222–39
kinetic studies and mechanisms 257–63
compared with elimination 404–5
electrophilic, aromatic *see* electrophilic aromatic substitution
in acyl chlorides 198–9, 202–3, 218
in anhydrides 198–9
intramolecular, in synthesis of saturated heterocycles 812
nucleophilic aromatic *see* nucleophilic aromatic substitution
nucleophilic, at saturated carbon 328–59
see also $\text{S}_{\text{N}}1$, $\text{S}_{\text{N}}2$
effect of neighbouring group on rate of 931–2
intramolecular $\text{S}_{\text{N}}2$, in synthesis of saturated heterocycles 805–10
mechanisms compared 328–9
stereospecificity of 853
radical 972–3
- substitution, stereochemistry and 343–4
- substrate control, in asymmetric synthesis 1107–13
- succinic anhydride, Friedel–Crafts acylation with 494, 722
- sucralose 1146
- sucrose 3, 29, 32, 1146
- Sudafed 314
- suffixes, in names of compounds 35
- sugars 1134–5, 1142–7
amino 1147
as examples of stable hemiacetals and acetals 229, 808
conformation of 801–2
in cell membranes 1147
protection of 808
stereoisomers of 315–16
- sulfa drugs 753–4
- sulfamethoxazole 753
- sulfamethoxy-pyridazine 753
- sulfanilamide 565
- sulfapyridine 565, 723
- sulfate, cyclic 1125
- sulfenate ester 918
- sulfene 403–4
- sulfenyl chloride 658–9
- sulfenylation, of silyl enol ethers 470
- sulfides 656–9, 660
alkylation to give sulfonium salt 664
by sulfenylation of enol ethers 470
from thiols 336
in mustard gas 935
neighbouring group participation by 932, 934
oxidation of 685
retrosynthetic analysis of 697–8
synthesis of, by $\text{S}_{\text{N}}2$ 354–5, 380
- sulfinate anion 659
- sulfite 657, 1125
- sulfonamide 657
- sulfonates 390, 657 *see also* toluenesulfonate, methanesulfonate
as leaving groups
sulfonation, of aromatic rings 476–7, 485–6, 490, 565
regioselectivity of 565
- sulfone 656, 657, 659–60
anion from 663, 664
allylic, conjugate addition of 664
as activating substituent in nucleophilic aromatic substitution 519
reaction with aldehydes 686
- sulfonic acids 659, 476–7 *see also*
toluenesulfonic acid,
methanesulfonic acid
by sulfonation of aromatic compounds 485–6
in regiocontrolled aromatic substitution 565
- sulfonium salt 658–9, 664–5
in *S*-adenosyl methionine 1136
- sulfonium ylids 665–7, 1018
- sulfonyl chlorides *see also* toluenesulfonyl chloride, methanesulfonyl chloride
- sulforaphane 1145–6
- sulfoxides 659, 660
activating substituents in nucleophilic aromatic substitution 519
alkylation of 661
allylic, in [2,3]-sigmatropic rearrangements 918
as oxidizing agent 545
chiral 660
elimination to form alkenes 684–5
oxidation 685
stabilization of anion by 661
- sulfoxonium ylids 667–8
- sulfur compounds, basicity and pK_{a} 660, 663
smell of 4
- sulfur dioxide 658
- sulfur heterocycles, saturated, reactions of 795
- sulfur nucleophiles, in $\text{S}_{\text{N}}2$ 354–5, 380
- sulfur trioxide, electrophilic aromatic substitution by 485–6
- sulfur ylids *see also* sulfonium ylids, sulfoxonium ylids
- sulfur, bond strengths to 657
comparison with selenium 686
crystalline 657
electronegativity of 657
functional groups containing 659–60
in organic chemistry 656–68
oxidation states of 657
stabilization of adjacent anion 660, 795
versatility of 657
- sulfuric acid, as dehydrating reagent 637
for hydrolysis of nitrile to carboxylic acid 586
in catalysis of E1 elimination of alcohols 389
in E1 elimination 383–4
 pK_{a} of 170
- sulfuryl chloride 658, 659
- sumatriptan, structure and synthesis 755, 777, 778
- superacid 334–5, 485
- supercritical carbon dioxide 1136
- superglue 6
- superimposable mirror images, and chirality 303–4
- super-protons, silyl groups as 671–3
- suprafacial 892
in sigmatropic rearrangements 913
- Suzuki, Akira 1084
- Suzuki coupling 1083, 1085–7
- Swern oxidation 545, 626, 667–8
mechanism of 668
- swine flu 1174–5
- symmetric stretch, in IR spectra 67, 70
- symmetry, centre of 320–2
planes of 304–6, 312, 320–1
planes of, centres of, and axes of, summary 322
- syn* aldol product 868–71
- syn* diols, from alkenes and osmium tetroxide 905–6
- syn/anti* nomenclature 858
- synclinal (*gauche*) conformation 365–6
- syn*-periplanar 365–6
- Syntex 325
- synthesis, asymmetric 1102–33
diversity orientated 1180
of natural products 872–5
planning *see* retrosynthetic analysis
- synthon 695–6, 712
donor and acceptor 712, 719–20
- systematic nomenclature 34–41

T

- Taber, Douglass F. 1020
- Tamao oxidation *see* Fleming–Tamao oxidation 673
- Tamiflu *see* oseltamivir
- tamoxifen, synthesis of 393
- tandem reactions 603–5, 640
- taranabant 1117
- tartaric acid 31, 317–18, 1105
- tautomerism 629
in NMR 449–50
in thioamide 772
keto-enol 450–1

- of 1,3-dicarbonyl compounds 457–8
- of carboxylic acids 451
- of hydroxypyridines 728
- of imidazole 451
- of imines 456–7
- of tetrazole 744
- of triazoles 743
- tautomers 629
- Taxol (paclitaxel) 1169–70
 - geminal (?) coupling in 820
 - synthesis via pinacol radical reaction 982
- tazadolene 717
- TBAF (tetra-*n*-butylammonium fluoride) 550, 669
- TBDMS (*tert*-butyldimethylsilyl), as
 - protecting group 549–50, 670
- TBDPS (*tert*-butyldiphenylsilyl), as alcohol
 - protecting group 670
- t*-Bu, *t*-butyl *see tert*-butyl
- TCP 480
- temperature, convenience of –78 °C 253
 - effect on equilibrium constants 248–9
 - effect on rates of reaction 250–3, 257, 266
- TEMPO (2,2',6,6'-tetramethylpiperidine *N*-oxide) 975
- ten-membered ring, conformational drawing
 - of 637
 - formation, using Stille coupling 1084
- terephthalic acid 210
- termination, of radical reactions 572–3
- termite, defence mechanism 501, 623, 624
 - pheromone of 685
- termolecular reactions 260–1
- terodilin 702
- terpenes 1156, 1164–7
- terpenoid 274
- tert*-butanol, ¹³C NMR spectrum 62
 - ¹H NMR spectrum 283
 - as solvent 1123
 - in E1 elimination reaction 383–4
 - reaction with HBr in synthesis of *tert*-butyl bromide 329
 - reaction with thiols in synthesis of sulfide 336
- tert*-butoxide, as base in E2 elimination 386
 - see also* potassium *tert*-butoxide
- tert*-butyl bromide, by reaction of *tert*-butanol with HBr 329
 - in E2 elimination reaction 382–3
- tert*-butyl cation, ¹H and ¹³C NMR spectrum 940–1
- tert*-butyl ester, as blocking group in pyrrole synthesis 761
 - as protecting group 556
 - S_N1 cleavage of 598
 - use of to avoid Claisen self-condensation 589
- tert*-butyl group 27
 - ¹H NMR spectrum 273–4
 - effect on conformation of cyclohexanes 377–8
- tert*-butyl hydroperoxide, use as oxidant 919, 1120–2
- tert*-butyl methyl ether, ¹H NMR spectrum 61
- tert*-butylamine, ¹H NMR spectrum 283
- tert*-butylcyclohexanol 311, 797
- tert*-butyldimethylsilyl *see* TBDMS
- tert*-butyldiphenylsilyl *see* TBDPS
- tert*-butyloxycarbonyl *see* Boc
- tert*-butylthiol 4, 283
- tertiary amine, as non-nucleophilic base 455
- tertiary carbocations, stability 334–5
- tertiary carbon, meaning of 27
- Terylene (polyester) 210
- TES (triethylsilyl), as alcohol protecting group 670
- testosterone 25, 1167
- tet* nomenclature, in Baldwin's rules 810
- tethers, for regio and stereocontrol 568–9, 847–8
- tetraalkylammonium chloride, as phase transfer catalyst 585
- tetracarbonyl ferrate, iron acyl complex from 1076
- tetradecanoic acid (myristic acid) 211
- tetrahedral angle 18
- tetrahedral intermediate 199–202
 - evidence for existence 201–2
 - formation of in rate-determining step 258
 - stability of 200–1, 218–20
- tetrahydrane 420–1
- tetrahydrofolic acid 754
- tetrahydrofuran *see* THF
- tetrahydropyrans 479 *see also* THP
 - anomeric effect in 802–3
 - synthesis by ring-closing reaction 805
- tetrahydropyryl *see* THP
- tetrakis(triphenyl)phosphinepalladium(0) [Pd(PPh₃)₄] 12, 1072
- tetralin, from naphthalene 161
- tetralone, regioselective synthesis of 568
- 2,2',6,6'-tetramethylpiperidine (TMP) 793
- 2,2',6,6'-tetramethylpiperidine *N*-oxide (TEMPO) 975
- tetramethylsilane (TMS), in ¹H NMR 55–6, 270
- tetra-*n*-butylammonium fluoride *see* TBAF
- tetra-*n*-propylammonium perruthenate *see* TPAP
- tetrazole, as carboxylic acid substitute in medicinal chemistry 744, 774
 - by [3+2] cycloaddition of azide and nitrile 774, 904
 - pK_a of 744
 - retrosynthetic analysis of 774
 - structure and tautomerism 725, 744
 - use in one-step Julia olefination 687–8
- tetradotoxin, structure of 790
- TFAE (2,2,2-trifluoro-1-(9-anthryl)ethanol) 1111–12
- theobromine 1137
- thermal cycloadditions *see* cycloadditions
- thermodynamic and kinetic control 264–6
 - in conjugate vs direct addition reactions 605–6
 - in electrophilic aromatic substitution 566
 - in reactions of sulfur ylids 666–7
- thermodynamic control, in acetal formation 808, 835, 1143
 - in conjugate addition 504–5
 - in Diels–Alder reactions 884
 - in electrophilic addition 434–6
- in enamine formation 592
- in enolate and enol ether formation 599–602, 636
 - in intramolecular aldol reaction 637
 - in reactions of sulfonium ylids 667
 - in ring-closing reactions 808–10
 - in synthesis of aromatic heterocycles 758
 - in synthesis of *Z*-alkenes 264–6
 - of enolate conjugate addition 605
- thermodynamic enolate, formation of 636
- thermodynamic silyl enol ethers, formation
 - of 636
- thermodynamic stability, vs kinetic stability 250
- thermodynamics, second law of 246
- thermodynamics, summary of principles 249
- THF (tetrahydrofuran) 39, 794
 - decomposition by organometallics 253, 795
 - in lithium enolate complex 625–6
 - ring opening of 794
- thiadiazole, 1,2,5- 752, 785
- thiazoles 725, 751, 771–2
- thienamycin 816–17
- thiiranium *see* episulfonium
- thioacetals 657, 661–2 *see also* dithianes
 - for removal of carbonyl groups 540
 - hydrolysis of 663
 - of glucose 1144
- thioacetate, as nucleophile in S_N2 355
- thioamide 772
- thioate anion 657, 658
- thiocarbonyl compounds, stability of 662
- thioctic acid, ¹³C NMR spectrum *see* lipoic acid
- thioesters 355
 - compared with esters 1153
 - of coenzyme A 1152–3
- thioether *see* sulfide 659
- thiol 27, 657–8
 - in glutathione 1140
 - reaction with epoxide 121–3
 - sulfide from 336
- thiolate anion 659
 - conjugate addition to nitroalkene 904
 - in nucleophilic aromatic substitution 517, 728
 - in Payne rearrangement 938–9
- thiols 4
 - as nucleophiles 354–5
 - from hydrogen sulfide and alkene 434–5
 - in conjugate addition 500–1, 506–8, 582
 - oxidation to disulfides 1140
- thionyl chloride, in synthesis of acyl chlorides 214–15, 462, 658
- thiophene 735–7
 - desulfurization 737
 - electrophilic aromatic substitution reactions 735, 737
 - from 1,4-dicarbonyl compounds 759
 - oxidation of 739
 - reaction with butyllithium 737
 - regioselectivity in reactions of 735
 - sulfone 739
 - sulfoxide 739
- thiophenesaccharin, synthesis of 582

- thiophile 918
 third-order kinetics 260
 Thorpe-Ingold effect 808–10
 THP (tetrahydropyran, -yl) 469, 550–1, 794
 three-dimensional structures, drawing 21
 three-membered rings *see also* cyclopropane, epoxide, aziridine etc.
 conformation of 369
 effect on ¹H NMR 414, 815
 fragmentation of 967
 rate of formation 806–7
 threonine 554
 thromboxane antagonist 705
 thromboxane 714, 1156, 1162
 thujone 1156
 thymidine 1138
 thymine 1136
 thymoxamine, synthesis of 521–2
 Tiffeneau–Demjanov rearrangement 949, 956–7
 timolol 752, 785–6
 tin, decline in use of 1099
 for reduction of aromatic nitro groups 495
 tin hydrides, in radical carbon-carbon bond formation 993–4
 tin tetrachloride, as Lewis acid 595
 tin(II) chloride, for reduction of diazonium salt to hydrazine 777
 TIPS (triisopropylsilyl), as alcohol protecting group 670
 titanium alkoxide, in Sharpless asymmetric epoxidation 1120–2
 titanium tetrachloride, as Lewis acid 595, 609, 626, 676
 titanium tetraisopropoxide, as Lewis acid 1122
 titanium, use in McMurry reaction 982–3
 TMP (2,2,6,6-tetramethylpiperidine) 793
 TMS *see* trimethylsilyl, trimethylsilane
 TNT (2,4,6-trinitrotoluene) 30, 176
 tolmetin, synthesis of 734
 toluene 37
 bromination of 484–5
 protonation of 485
 sulfonation and chlorosulfonation of 485–6
 toluenesulfinate, as leaving group 344, 349, 380, 390–1, 664, 948
 toluenesulfonate esters (tosylates), synthesis from alcohols 349, 403
 as alkylating agents 596
 toluenesulfonic acid (PTSA, TsOH, tosic acid) 227, 389, 485, 627
 toluenesulfonyl azide 1006–7
 toluenesulfonyl chloride (tosyl chloride, TsCl) 344, 349, 658, 659
 toluenesulfonyl hydrazine, -one *see* tosylhydrazine, -one
 topanol 354 50, 61–2
 Toray process 986
 torsion angle 364
 tosic *see* toluenesulfonic
 tosyl *see* toluenesulfonyl
 tosylate *see* toluenesulfonate
 tosylhydrazine, in Eschenmoser fragmentation 965
 tosylhydrazone 965, 1007–8
 TPAP (tetra-*n*-propylammonium perruthenate) 545
 tranquilizers 793
trans and *cis* coupling constants, and ring size 814–17
trans-alkenes *see* alkenes, *trans*
 transannular strain, in medium rings 807
trans-cycloheptene 679
trans-cyclooctene 679
trans-decalin 378–9, 381, 841
trans-diaxial opening, of epoxide 849
trans-enolate, in aldol reactions 868–71
 transesterification 209–10
 transfer hydrogenation 1115–17
trans-fused bicyclic rings 841–2, 848–50
trans-hexatriene, conformations of 145
 transition metal catalysis, gold 1099
 palladium 1069–99
 ruthenium 1099–100
 transition metal complexes, bonding and reactions in 1073–8
 chiral 1115–17, 1117–26
 stability and 18-electron rule 1070
 transition metals, as oxidizing agents 194–5
 in formation of carbenes 1007
 valence electrons of, table 1070
 transition state, cyclic, to control stereochemistry in reactions 850–1, 862–5, 869–70
 definition of 251, 253
 effect of solvent on 256
 experimental investigation of 1041–8
 Felkin–Anh 859–62
 for amide C–N bond rotation 256
 for CBS reductions 1115
 for diastereoselective epoxidation 835–6, 850
 for ring-opening of an epoxide 837
 Hammond postulate and 989
 how to draw 251
 in Baeyer–Villiger oxidation 956
 in catalysed reactions 254
 in Grignard reagent formation 185
 in reduction of a ketone with borohydride 251
 mimic of by HIV protease inhibitors 1171
 of [2,3]-sigmatropic rearrangements 917
 of Alder ene reaction 896
 of Claisen rearrangement 910–11
 of Diels–Alder reaction 878, 885, 891
 of S_N2 reaction 340–1, 343
 Zimmerman–Traxler 869–70, 1130
 transmetallation 189, 218, 1083–8
trans-retinal, ¹³C NMR spectrum 409
trans-stilbene, asymmetric dihydroxylation of 1124
 epoxidation of 431
 travel sickness, drug for treatment of 791
 trialkylborane 446
 trialkylsilyl chloride, for protection of hydroxyl group 549–50
 trianions, chemoselective reactions of 547
 triazine, 1,3,5-, structure and conformation of 804
 triazole, pK_a of 743
 reaction with epoxide 743
 triazoles 725
 1,2,3-, synthesis, from azide and alkyne 776
 1,4-disubstituted, selective synthesis of 775
 acid/base properties in 743
 by [3+2] cycloaddition 775
 in fungicides 11
 tautomerism of 743
 tributyltin hydride 991–4
 trichloroacetaldehyde, hydration of 134–5
 2,4,6-trichlorophenol 480
 2,4,6-trichlorophenyl ester, for activation of carboxylic acids 558–9
 trienes, cycloaddition of 894
 electrocyclic ring closing of 922–3
 triethylamine, pK_a of 174, 791
 triethylsilane, as reducing agent 668, 1175–6
 triethylsilyl *see* TES
 2,2,2-trifluoro-1-(9-anthryl)ethanol (TFAE) 1111–12
 trifluoroacetic acid, ¹³C NMR spectrum 416–17
 pK_a of 176
 trifluoromethylbenzene, nitration of 487
 trifluoromethyl group 487, 519
 trifluoroperacetic acid *see* peroxy trifluoroacetic acid
 trig nomenclature, in Baldwin's rules 810
 triglyceride 1148
 triisopropylsilyl *see* TIPS
 trimethoprim 770–1
 trimethylenemethane 1091–2
 trimethyloxonium fluoroborate *see* Meerwein's salt
 trimethylphosphite, as nucleophile for sulfur 918
 trimethylsilyl (TMS), as protecting group 670
 as 'super-proton' 671–3
 trimethylsilyl chloride, as electrophile 466–7
 for formation of silyl enol ethers 670
 in conjugate addition reactions 508
 in silyl enol ether formation 626
 use in acyloin reaction 983–4
 use in enolate trapping 632
 trimethylsilyl triflate, as Lewis acid with allyl silanes 676
 trimethylsilylacetylene 671–2
 trimetozine, synthesis of 791
 2,4,6-trinitrophenol (picric acid) 176
 2,4,6-trinitrotoluene *see* TNT 176
 triphenylmethyl *see also* trityl 337
 anion 643
 radical, and dimer 973–5, 979
 triphenylphosphine, as nucleophile in S_N2 358
 for reduction of azides 354, 1176
 for reduction of ozonide 443, 907
 in Mitsunobu reaction 349–51
 in synthesis of secondary allylic chlorides 577–8
 in Wittig reaction 237
 to cause CO insertion into transition metal ligands 1076

- triphenylphosphine oxide, as by-product of the Wittig reaction 238
- triple bonds, carbon-carbon *see* alkynes
- region in IR spectrum 65, 69
- stability and acidity 188
- triplet (codon) 1139
- triplet carbene 1010
- triplet, in ^1H NMR 289–92
- trisporol B 1086
- tritium (^3H , T), as radioactive label 1037
- Triton B (benzyltrimethylammonium hydroxide) 612
- trityl cation (triphenylmethyl cation) 337
- trityl chloride (TrCl), reaction with primary alcohols 337
- trivial names 33–4, 36–9
- tropinone 1157–8
- truffle, smell of 4, 657
- tryptophan 16, 554, 755, 1154
- as precursor to indole alkaloids 745
- X-ray crystal structure 20
- TsCl *see* toluenesulfonyl chloride
- TsDPEN, as chiral ligand 1115–17
- TsOH *see* toluenesulfonic acid
- turpentine 1164
- twist-boat conformation 370, 373–4, 378, 830, 839
- tyrosine 554, 1154
- alkaloids from 1159–61
- in synthesis of L-dopa 954
- U**
- ulcer treatment drug, cimetidine 178–80
- ultraviolet absorption, for detection in HPLC 1111
- ultraviolet light, associated energy of 971
- for radical initiation 572
- ultraviolet-visible (UV-vis) spectroscopy 148–50
- umpolung 720
- Uncertainty Principle, Heisenberg's 83
- unimolecular reactions 259–60
- universe, number of atoms in 250
- unknown compounds, identification of 418–22
- unsaturated carbonyl compounds *see* α,β -unsaturated carbonyl compounds
- unsaturated fat 31, 536
- unsaturated fatty acid 1148, 1161–3
- unsaturated, meaning of 29
- unstabilized ylids 689–91, 693
- uracil 754, 1136
- uric acid 750–1
- UV *see* ultraviolet
- UV-visible spectra 148–50
- V**
- valerian root oil 948
- valine 554, 1104
- chiral auxiliary from 1108
- Valium 326, 793
- vanadyl acetoacetate 850–1
- vancomycin 308, 1142
- vanillin 9
- ^{13}C NMR spectrum 409
- Vaska's complex 1074
- venlafaxine 715–16
- vernolepin 508
- Viagra 723, 768–70
- vibrational spectroscopy 64
- vicinal (3J) coupling *see also* coupling 295, 300
- and ring size 814–17
- in saturated heterocycles 796–9, 802, 814–17
- in six-membered rings 797–9, 802
- Villiger, V. 953
- Vilsmeier reaction 733–4, 746
- vinegar 28
- vinyl alcohol 456–7
- vinyl cation, structure and reactions of 264
- vinyl epoxides, synthesis and reactivity 1090
- vinyl group, coupling constants in 299–300, 293–4, 295
- vinyl halides, elimination to give alkynes 398
- from 1,2 dibromoalkenes 398
- vinyl silanes, molecular orbitals of 674
- alkenes from 673–4
- by reduction of alkynyl silanes 683
- vinylogous 512
- violet oil 707
- vision, chemistry of 681
- vitamins
- A, retrosynthetic analysis and synthesis of 708, 915
- B₁₂ 38
- B₆ 235
- C (ascorbic acid) 6, 1141, 1146
- ^1H NMR spectrum 275
- acidity of 458–9
- D, biosynthesis of 922, 927
- D₂ 921, 927
- E, as radical trap 975
- vivalan, structure and synthesis 612
- Vollhardt, K. P. C. 548
- von Liebig, Justus 950
- W**
- Wacker oxidation 1096
- Wadsworth–Emmons reaction *see* Horner–Wadsworth–Emmons reaction
- Wagner–Meerwein rearrangement 942–4
- water, addition to carbonyl group 133–5
- as a solvent for organic compounds 163–4
- as an acid and a base 167–8, 170
- as nucleophile 113
- as solvent in amide synthesis 177
- as solvent in Diels–Alder reaction 888
- concentration of, in water 169, 243
- deuterated (heavy water, D₂O), as NMR solvent 272, 284–5
- ionization constant (K_w) 168
- pK_a of 169, 170
- reaction with carboxylic acid derivatives (hydrolysis) 206
- shape of molecule 82
- solvation of salts by 255
- Watson, James D. 1137
- wavefunctions, of orbitals *see* orbital, wavefunctions of
- wavelength, absorption and colour (table) 64, 149
- wave-particle duality 83
- W-coupling, in ^1H NMR 295–6, 301
- weak base, acetate as 263
- catalysis by 1057
- pyridine as 199–200
- wedged bonds 302
- Weinreb, S. M. 219
- Weinreb amides (N-methoxy-N-methyl amides) 219, 1112
- Wieland–Miescher ketone 845
- wiggly bonds 306, 680
- wiggly line, meaning of 21
- wild type enzymes 1180
- Wilkinson, G. 1084, 1117–18
- Wilkinson's catalyst 1074, 1117–18
- Williamson ether synthesis 340
- wine, chemical responsible for taste of corked 790
- health benefits of 6, 1164
- wing-shaped, conformation of cyclobutane 369
- Wittig, Georg 237
- Wittig reaction 237–8, 570, 689–93
- examples of 628, 1121
- in retrosynthetic analysis 720
- stereoselectivity and mechanism 689–93
- Wittig reagents, as specific enol equivalents 627
- Wolff rearrangement, of α -carbonyl carbene 1021
- Wolff–Kishner reduction 540
- Woodward, Robert 892
- Woodward–Hoffmann rules 892–3
- and [1,5]-sigmatropic hydrogen shifts 920–1
- and [2,3]-sigmatropic rearrangements 917–18
- and [2+2] photochemical cycloadditions 897
- and [3,3]-sigmatropic rearrangements 912
- and Alder ene reaction 895
- and Diels–Alder reaction 892–3
- and electrocyclic reactions 923–4
- X**
- X, as abbreviation for halogen 30
- xanthine oxidase 751
- xanthine, oxidation to uric acid 751
- XantPhos 1093
- X-ray crystallography 44–5
- xylene, as solvent 358
- xylose 316
- Y**
- yew tree 1170
- ylid (ylide) 237
- from carbene attack on lone pair 1023
- phosphorus, in aldol reaction 627, 628
- in Wittig reaction 237, 689–93
- stabilized and unstabilized 689–93
- sulfur, for formation of epoxides 665–7

Z

- Z/E*-alkenes, calculating energy difference
 between 265
- Z*-alkenes *see* alkenes
- Zantac *see* ranitidine
- zeolite 226
- Ziegler–Natta polymerization 1076
- zig-zag, drawing carbon chains as framework
 18–19
- Zimmerman–Traxler transition state, for aldol
 reaction 869–70, 1130
- zinc carbenoid, in Simmons–Smith reaction
 1009, 1017
- zinc enolates, [4+3] cycloaddition reaction
 of 893–4
- formation of 631
- zinc, as reducing agent 494, 658–9, 899, 902
- organometallic derivatives of 189
- Zovirax *see* acyclovir
- zwitterion 167, 174
- of glycine, ¹H NMR spectrum 284–5