

Aquaponics and Renewable energy



Charlie Price

 **AquaponicsUK**



UNIVERSITY OF
STIRLING

- Social enterprise operating on a not for profit basis.
- Providing components and complete systems to the emerging aquaponics industry
- The profits from which provide research and development funding.
- Starting with the two ABLE project prototype systems, we now have a further 4 projects planned for 2009/2010 in cities across the midlands.
- Also international interest from projects from Kenya, SA, Rwanda, Portugal and Afghanistan.

What is aquaponics ?

- Aquaponics involves the integration of **aquaculture** and **hydroponics**.
- Aquaponics provides is low input, high output system with high value crops ranging from fish, prawns, herbs and salad crops.
- There are three main cycles taking place.
 - Water – recirculated and topped up with rainwater harvesting
 - Wastes – fish wastes-nitrates-plants, offcuts-worms-fish
 - Heat – heating gains in the day and heat losses at night
- Minimising Costs and Maximising Outputs

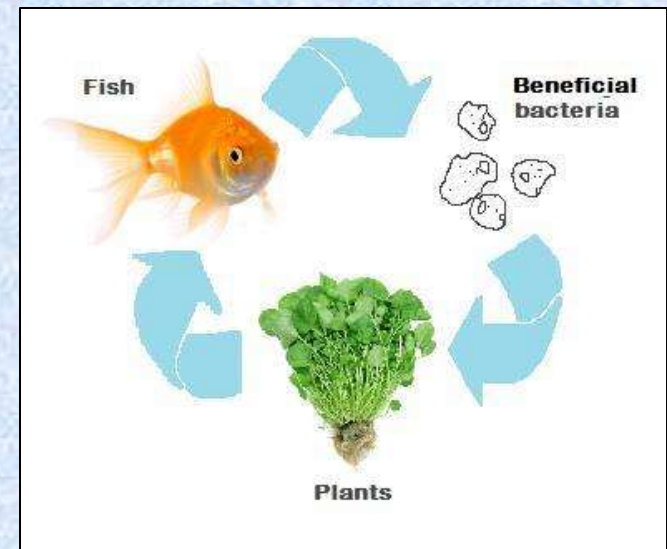

How aquaponics works....

- Fish are cultured as in any aquaculture system (and at the similar densities)
 - Dissolved wastes provide a nutrient source for plants grown hydroponically.

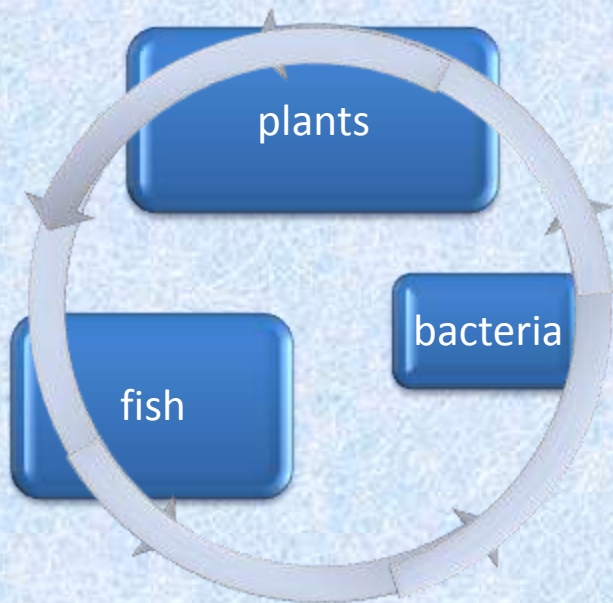

- Waste products utilised as resources in an ecosystems approach
- Low input, high output

How aquaponics works....

Solids removal – a game of two halves

Media Filled Grow Beds

Mechanical and biological filtration provided by the growing media into which crops are planted.

Usually with beds filled with expanded clay balls or gravel.



Constraints being scaling up due to cost weight issues

Ideal for small to medium systems or as a component

Solid settlement tanks

Separate filtration after the fish to remove solids.

Generally three stages, solid removal, fine solids removal and degassing



Then once solids removed and degassed water ready for hydroponic component for nitrogen stripping

Either deep water circulation (DWC) and floating rafts or nutrient film technique (NFT)

How aquaponics works....

Hydroponics – DWC (deep water circulation)

- Plants grown on floating rafts.
- Aeration required
- rafts floated down channels for harvesting



How aquaponics works....

Hydroponics – NFT (nutrient film technique)

- Plants grown in gully's with a constant film of water passed over the roots.
- Cheap and easy to set up
- Aquaponics requires adapting conventional hydroponic NFT system to account for biological loadings



How aquaponics works....

Harvesting – driven by demand

- Continuous or in batch harvesting depending on market demand.
- Important to maintain balance in biomass.
- Crops can be also be planted and cropped on demand due to the fast production cycles



How aquaponics works....

Feeding – from low input to no input

- Fish are feed either a complete pellet diet or with worms and off-cuts as supplementary feed
- Or feed with worms and off-cuts as supplementary feed
- Feeding rates based on desired growth rates and plant surface area



A case study

Renewable Energy & Aquaponics



The Able Project

- Able project set up around 6 years ago, to provide an outdoor educational facility for youth offenders, and community service “participants”.
- Existing Aquaculture system growing tilapia, sturgeon, carp and catfish.
- 34 acres of willow coppice which is feeding a biomass 60kw biomass boiler.
- Also classrooms, outdoor vegetable allotments and a 5 acre orchard.
- And now 3 aquaponics greenhouses.



From design to operation

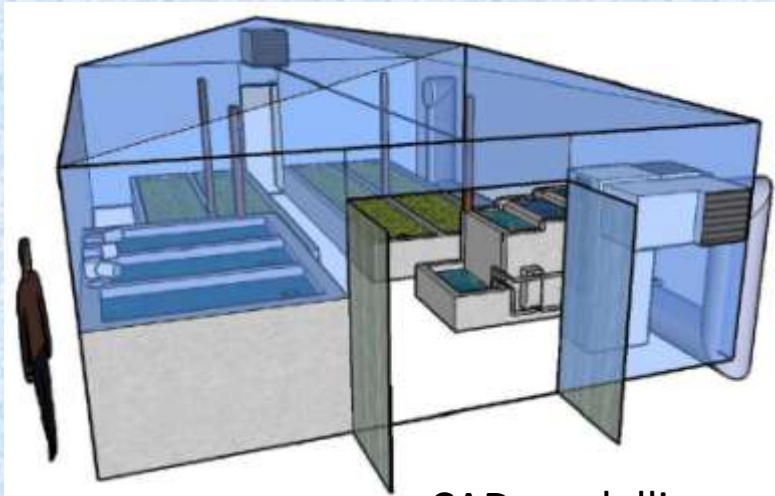

CAD modelling



Construction



Commissioning and training



How the ABLE system is designed

- Designed as an interactive learning facility
- As such more “user friendly” than a commercial unit
- Principles remain the same
 - Demand driven production
 - Energy efficient
 - As a scalable model for commercial production



How the system operates ?

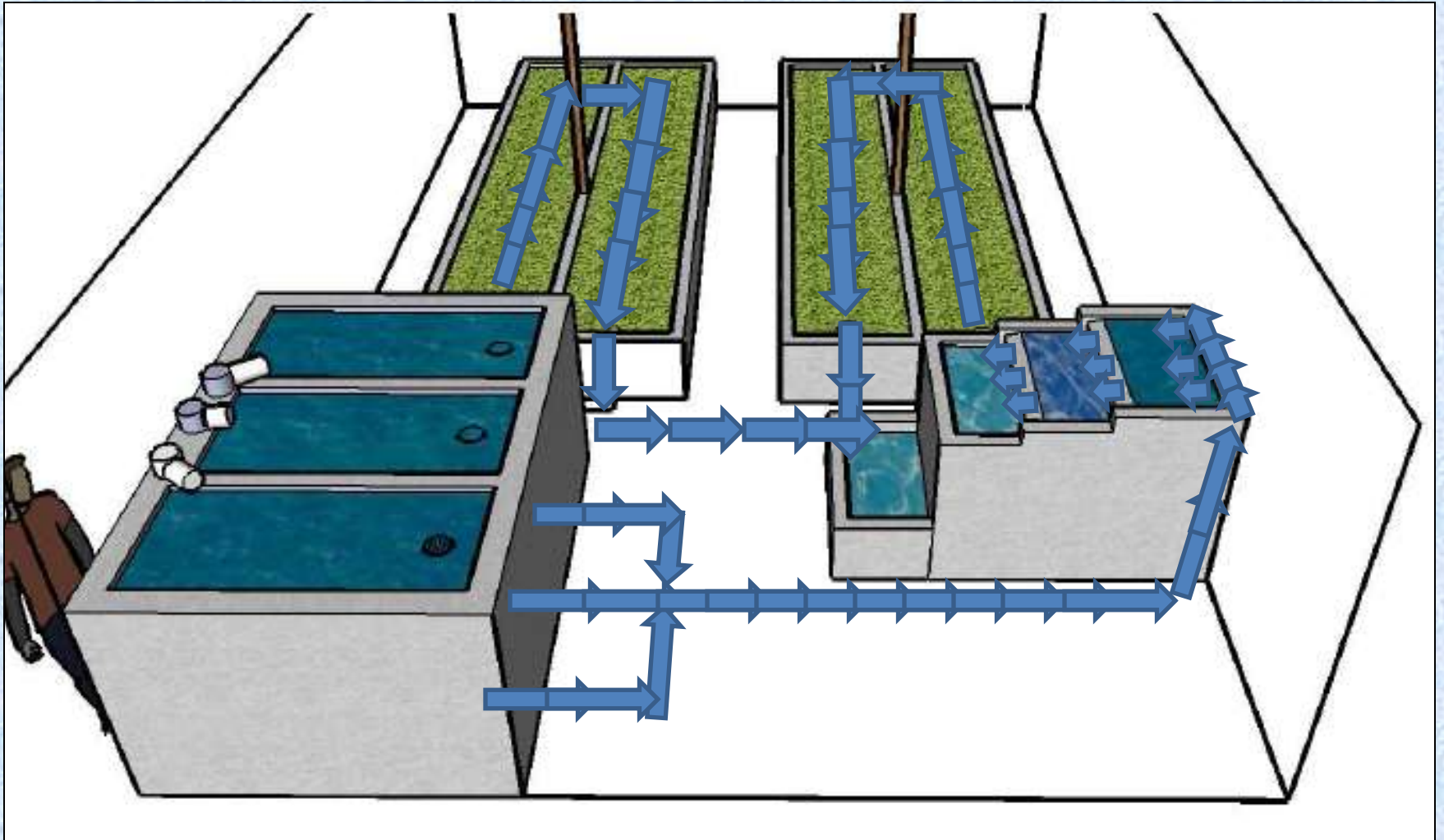

The fish tanks

- Three tanks, made to measure and built into the structure of the greenhouse.
- We integrated 12mm laminated, toughened glass windows into the fronts so people can see what's inside and observe body form and stock condition.
- 3 tanks to allow for staggered harvest so that a relatively constant biomass is maintained average $20\text{kg}/\text{m}^3$

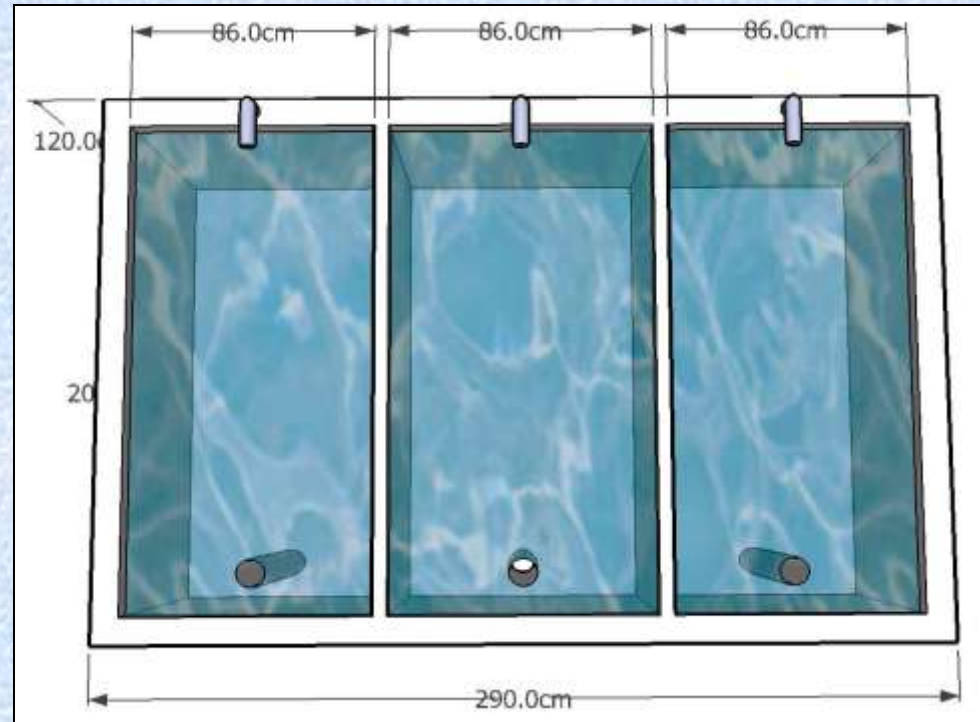
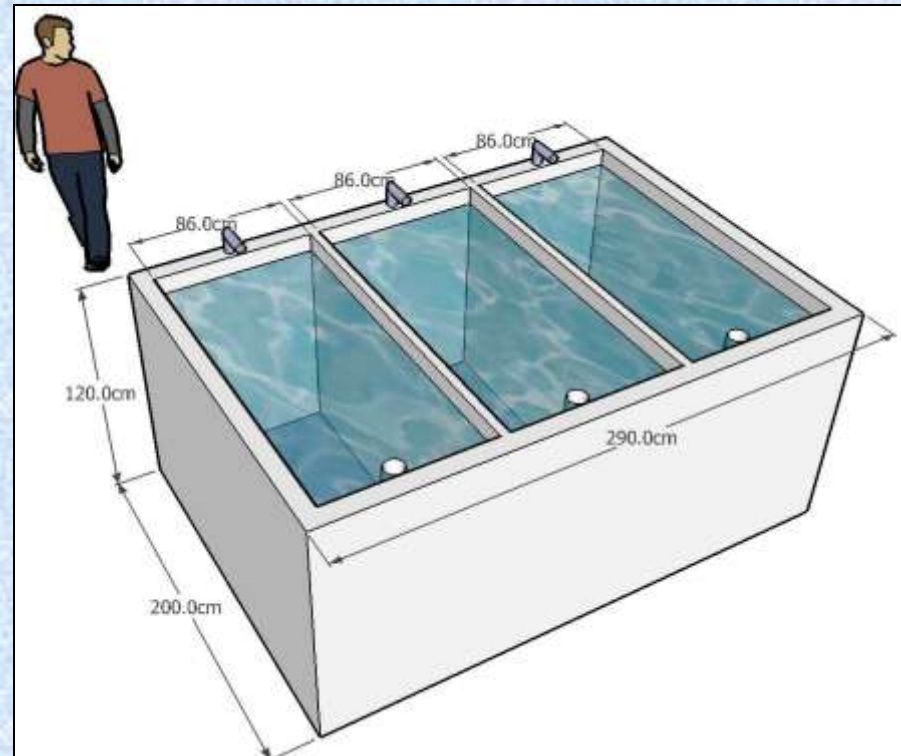



The filter tanks

- Three stage filter tank with sump tank attached
 - First stage – Primary solids removal tank – baffled flow
 - Second stage – fine solids removal tank – brush screen and mussels
 - Third stage – degassing tank - aeration

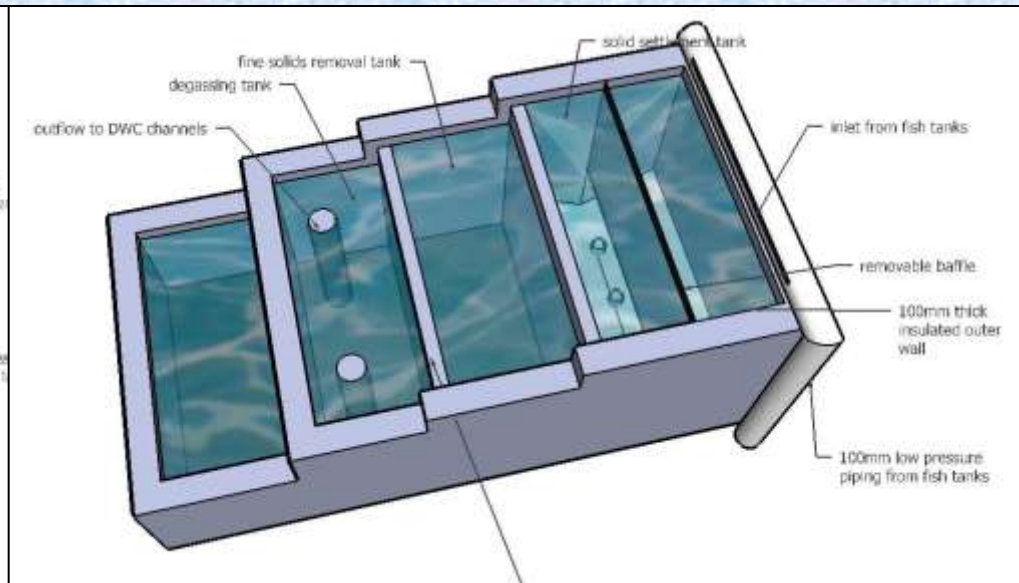
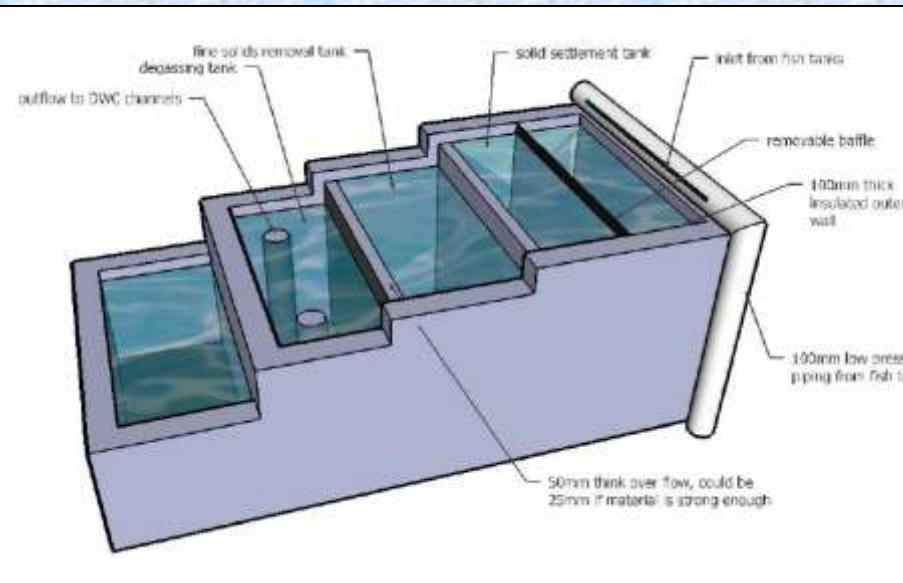

- Sump tank taking return flow from hydroponics tanks before being pumped back to fish tanks



Heating and Cooling

- Air to water source heat pump
- Either heating the air or water through heat exchangers, or by cooling the greenhouse by extracting the heat inside.
- Heat pump exhaust air is 5 degrees colder than the intake – giving cooling function
- The water of the system is used like a heat storage vessel storing energy during the day for release at night

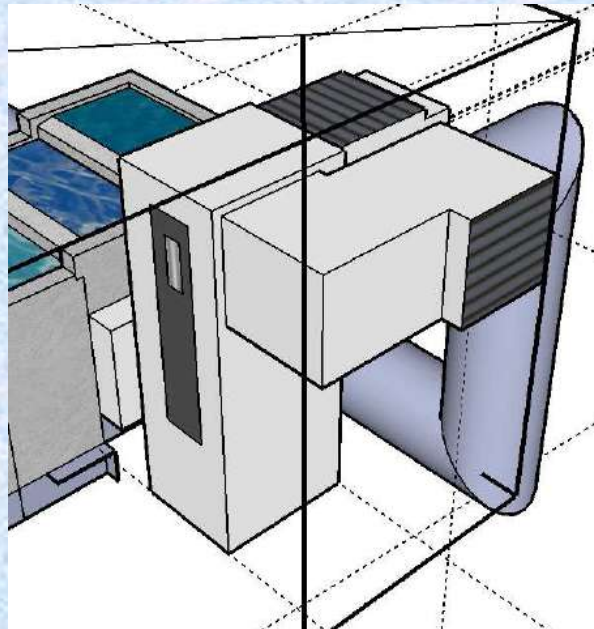
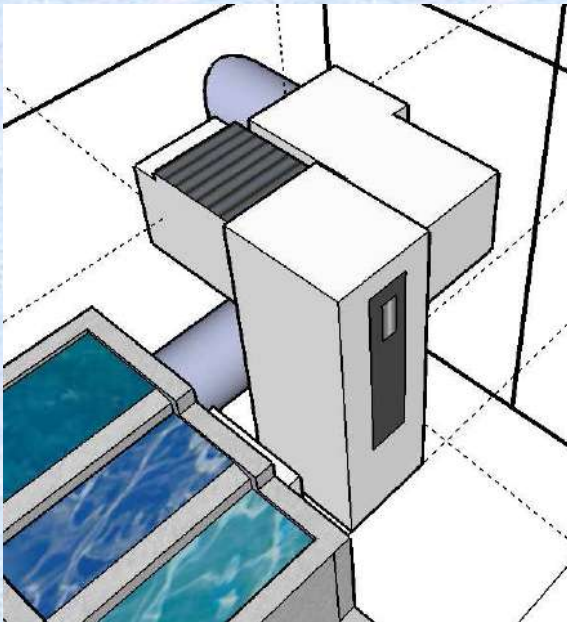

LWC 60M-I/VL
LWC 80M-I/VL
W x D x H in mm
577 x 700 x 1800

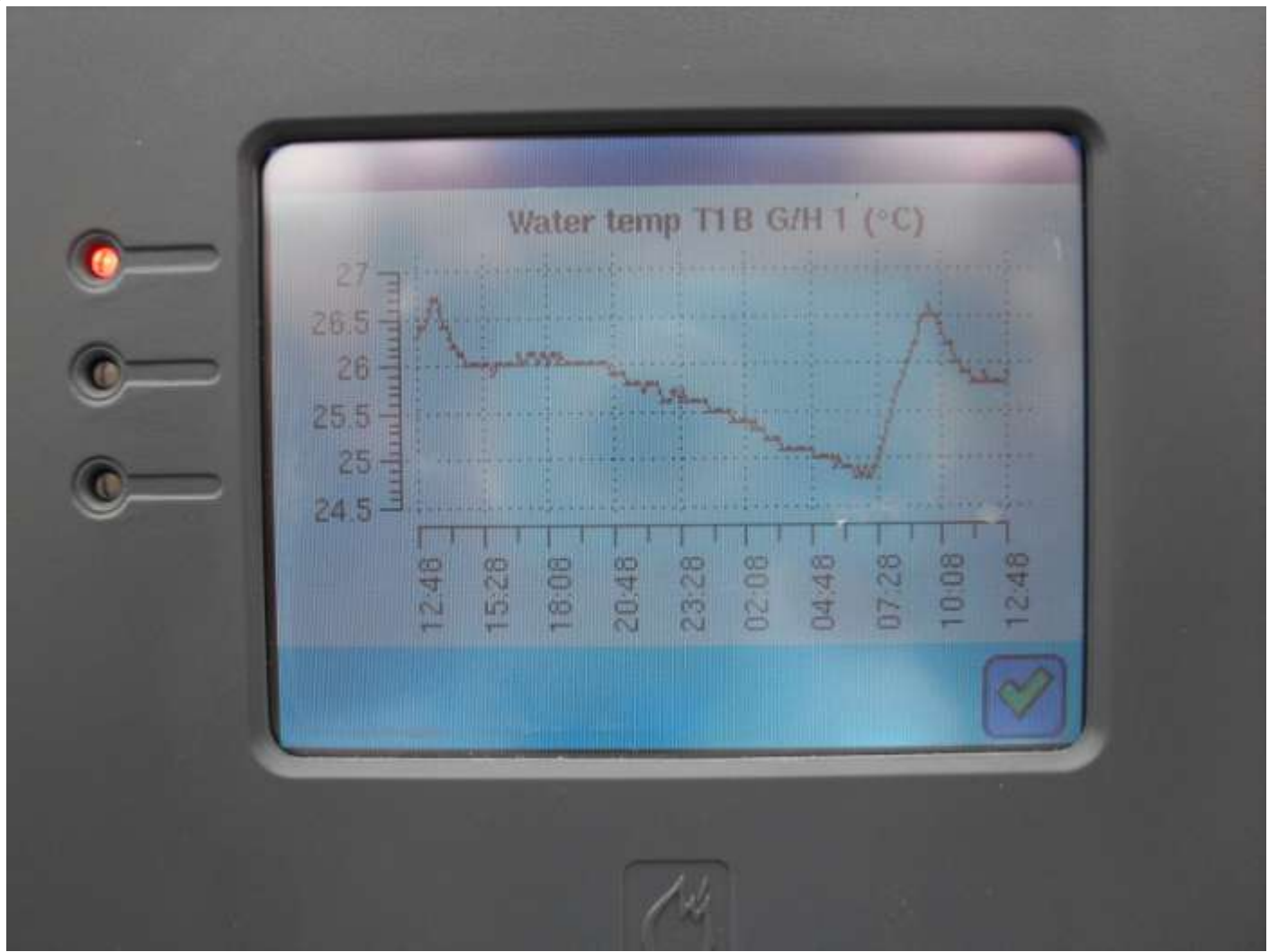

Ducting

- Ducting required to either channel air from outside and to outside, or from inside the greenhouse and returned to the greenhouse.
- VCDs (variable control dampers) incorporated to control air flow via actuators

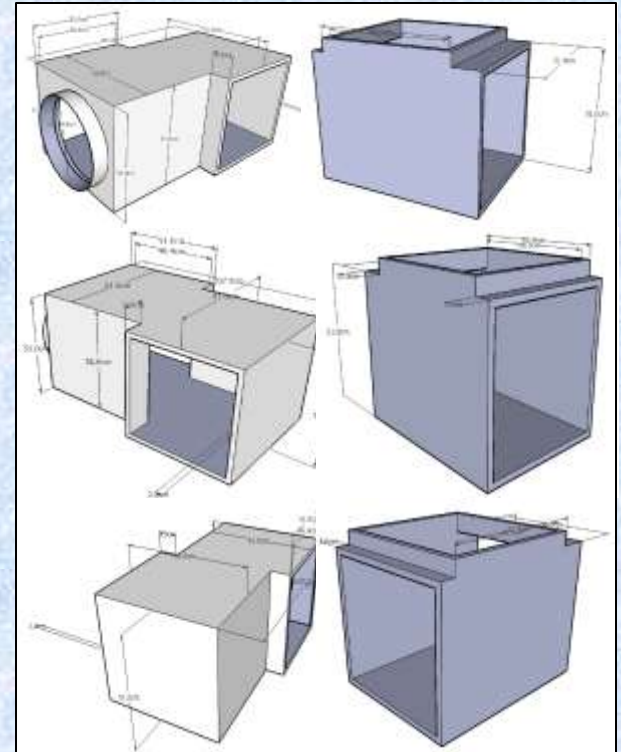
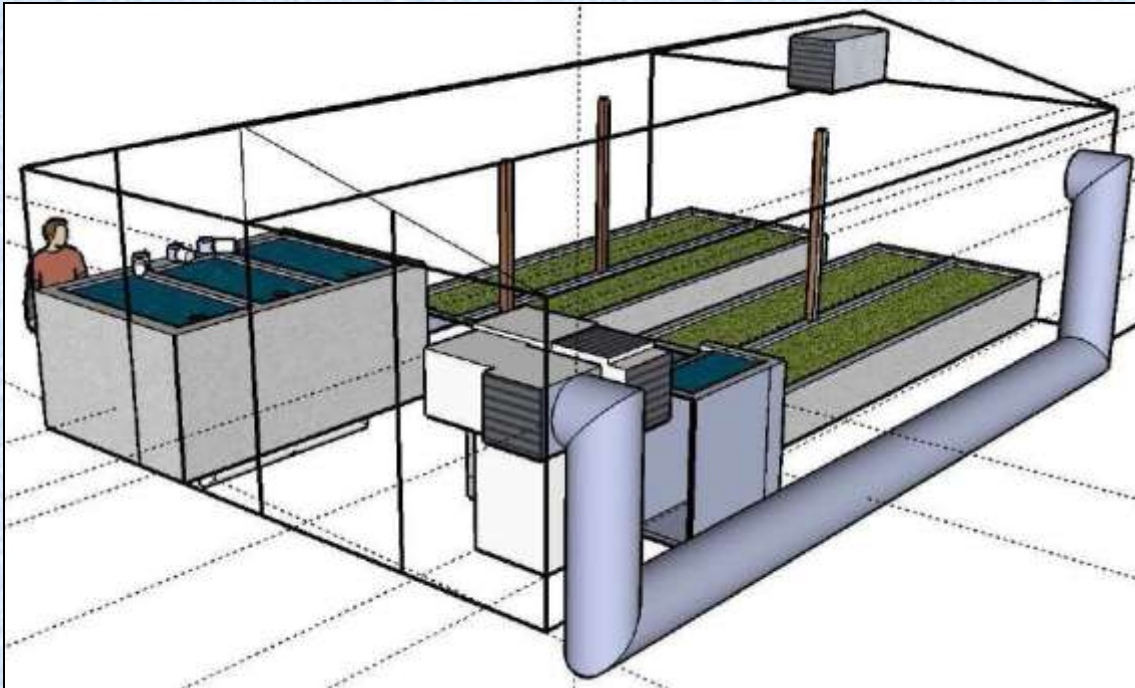

Heat exchange

- Flat plate heat exchanger
- To heat the water of the system or alternatively extract heat from it

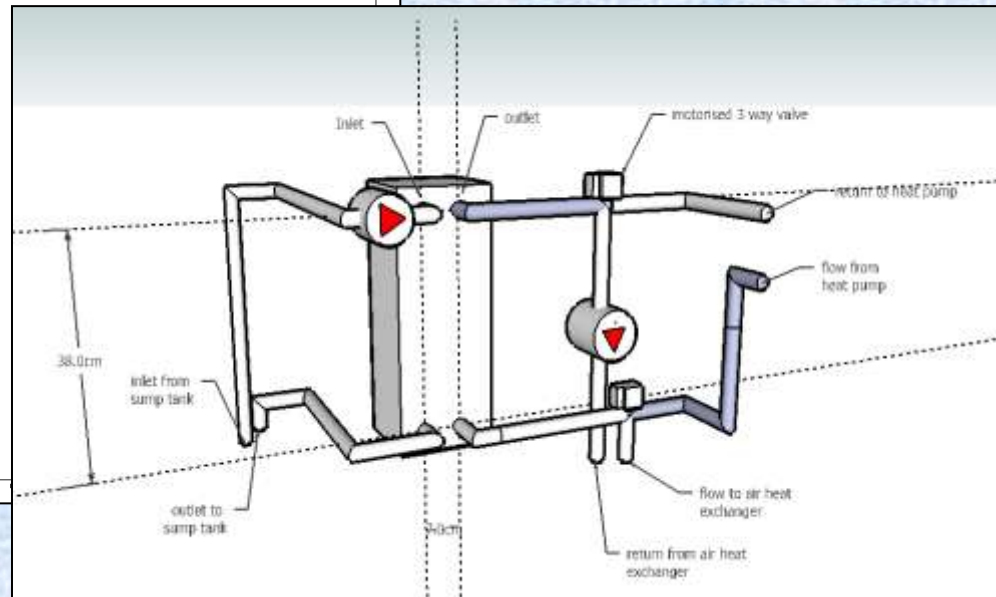
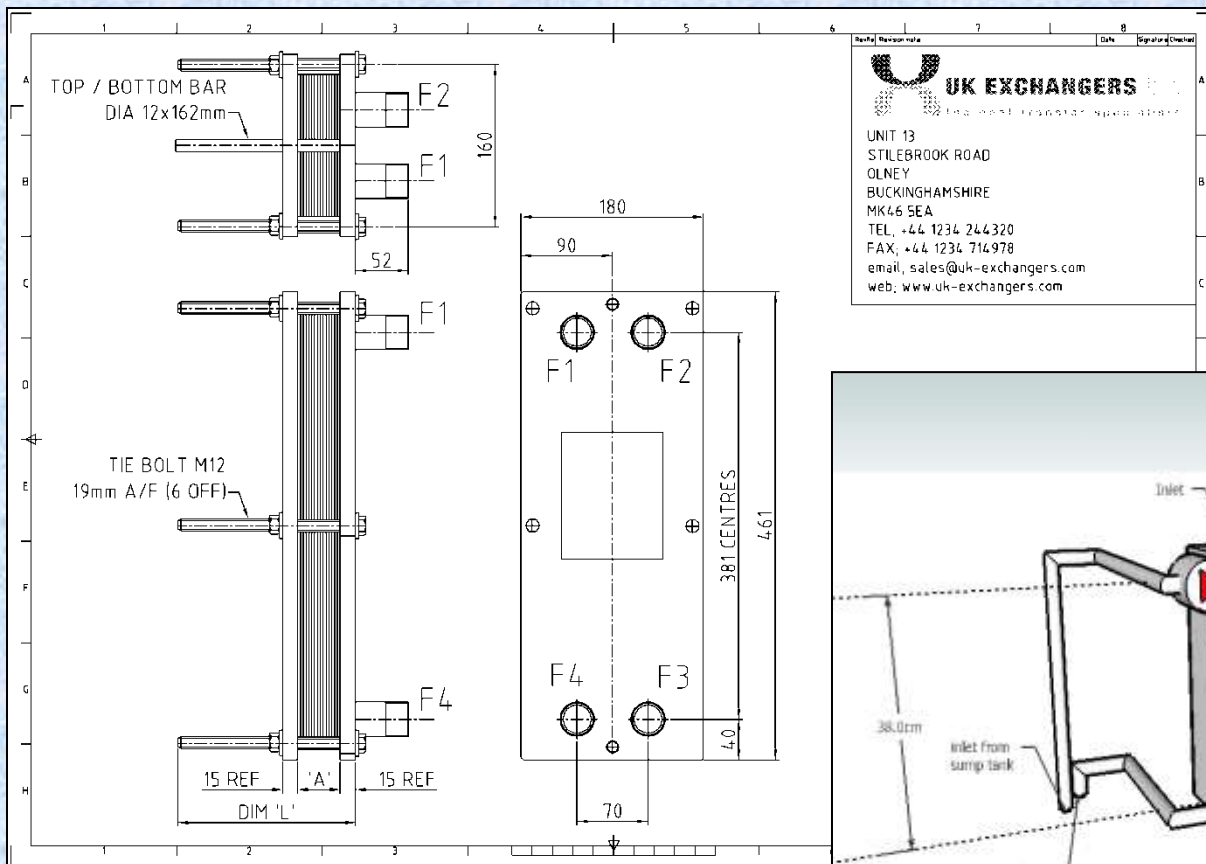

Enhanced integration..Closing the loop

- Composting linked with vermiculture to produce worm tea for foliar plant feed and worms for supplementary fish food.
- Prawns integrated into hydroponic tanks to help clear up any detritus.
- Looking at freshwater mussels to be stocked into filter tanks for fine solids removal.
- Free solar gain converted and stored as cheap energy

Life cycle assessment

- An in depth appraisal of the system
- Exploring the implication of different materials and production processes
- Used to inform material choices and lower impacts

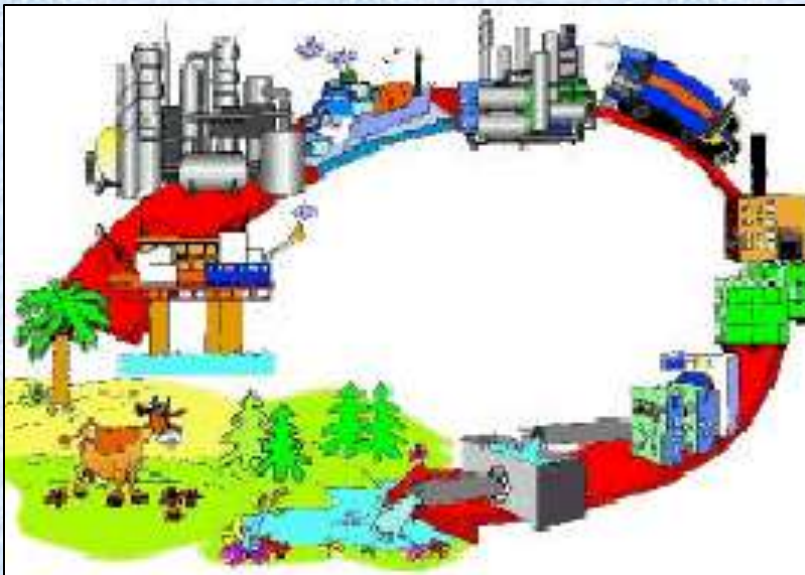

- An exciting tool to validate our “green” credentials and the implications of production.

Publicity and support



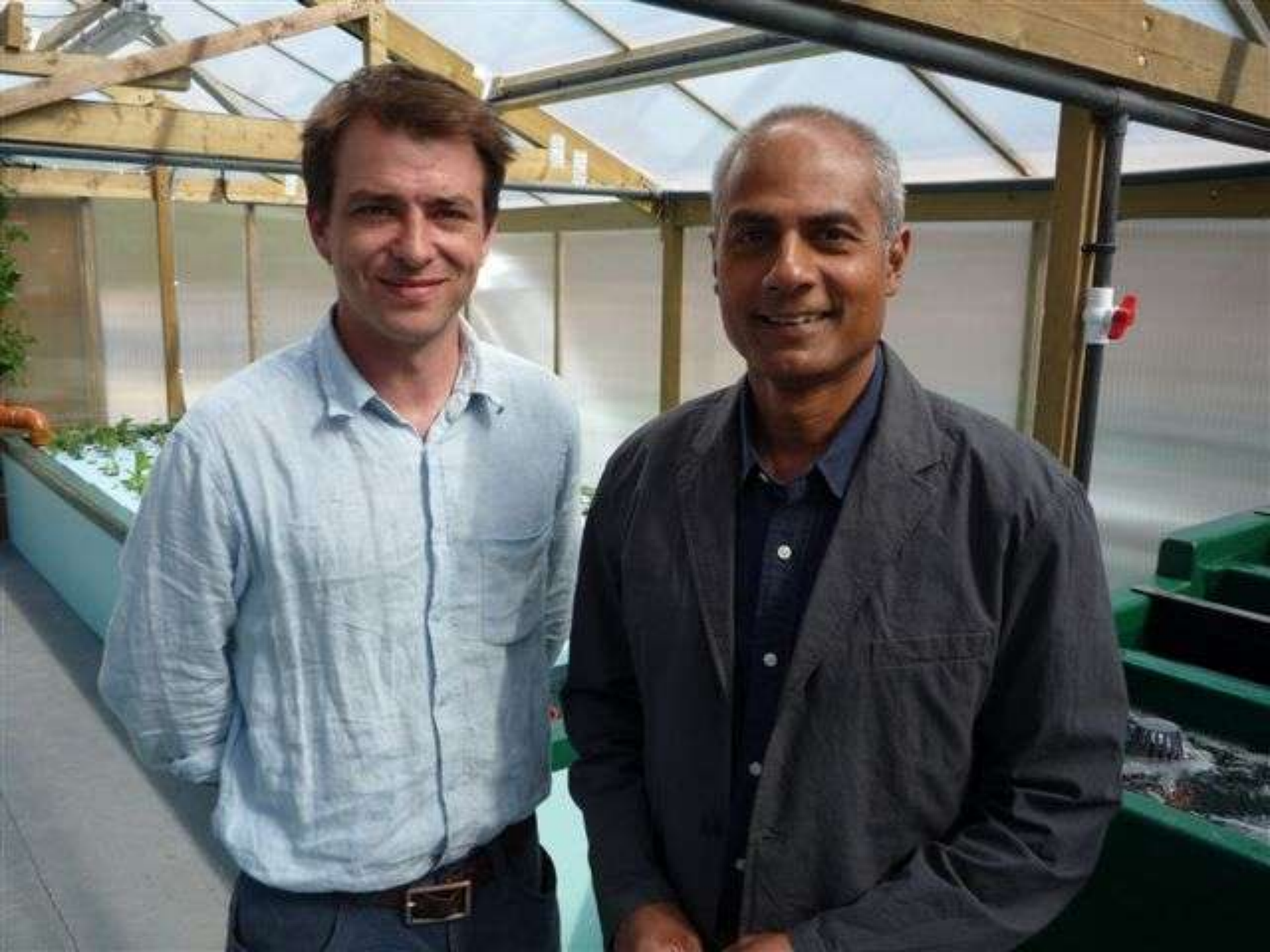

Other renewable energy options

- Water and Ground source heat pumps
- Biomass
- Combined Heat and Power (CHP)
- Heat Recovery

Water and ground Source heat pumps

- Work through cycle of compression and decompression
- Efficiency measured by COP – coefficient of performance
- WSHP & GSHP generally have COP's of 4-4.8

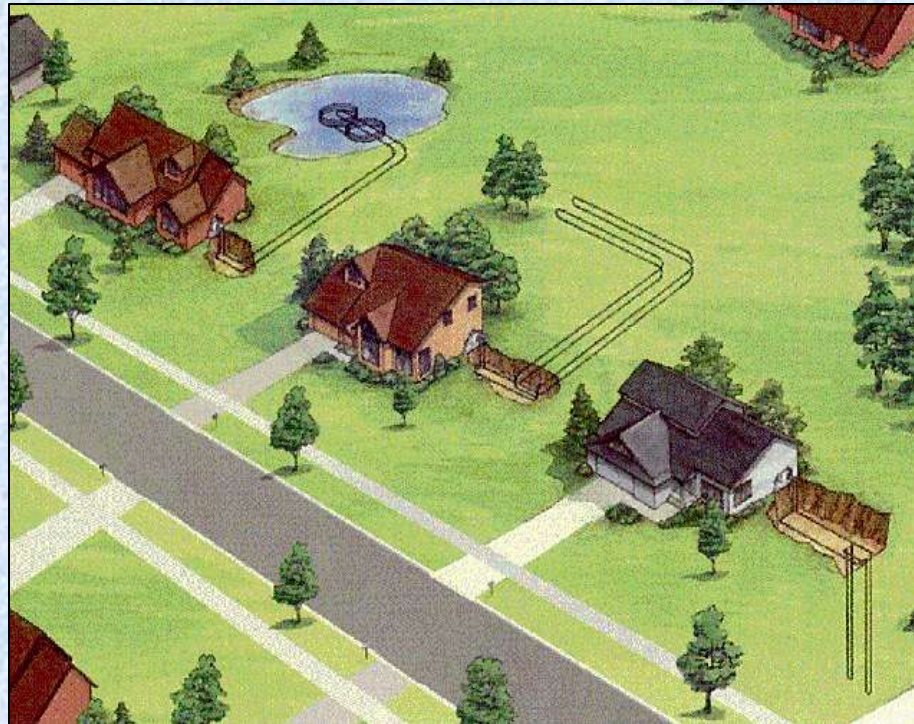

Biomass

- Energy derived from the combustion of photosynthetically derived matter
- Biomass systems can be automated or manual loading
- Biomass fuels include solid wood, wood chips, pellets and grain
- Fuel is combusted twice using – “woodgasification”



Combined heat and power (CHP)

- Combined heat and power involves the combustion of fuel to generate electricity and capturing “waste” heat in the process.
- CHP fuels include gas, diesel and oil, as well as biogas, biodiesel and biomass.

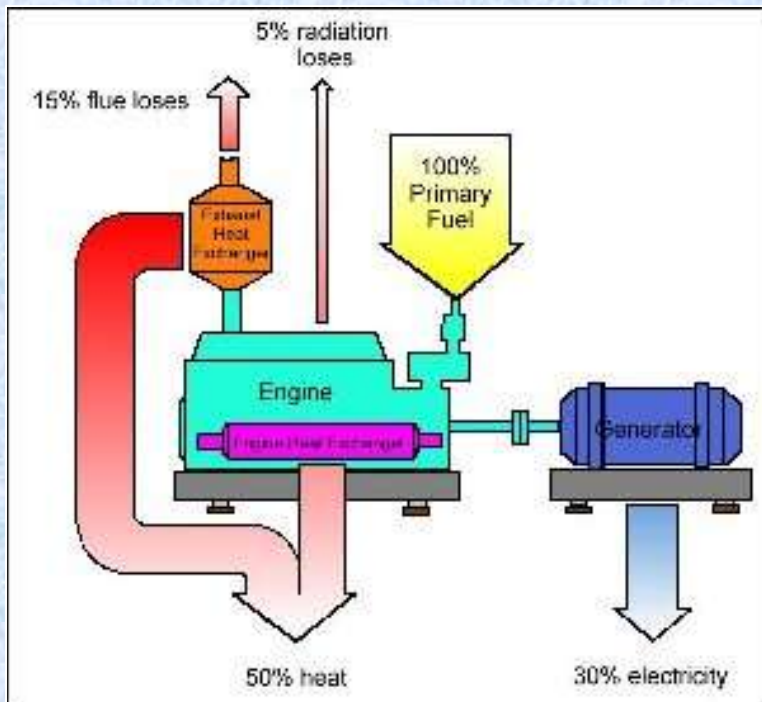

Heat Recovery

- Designed to exchange the heat between warm exhaust air and colder intake air
- Can be passive or active
- Systems sized according to volume, heat load and ventilation requirements

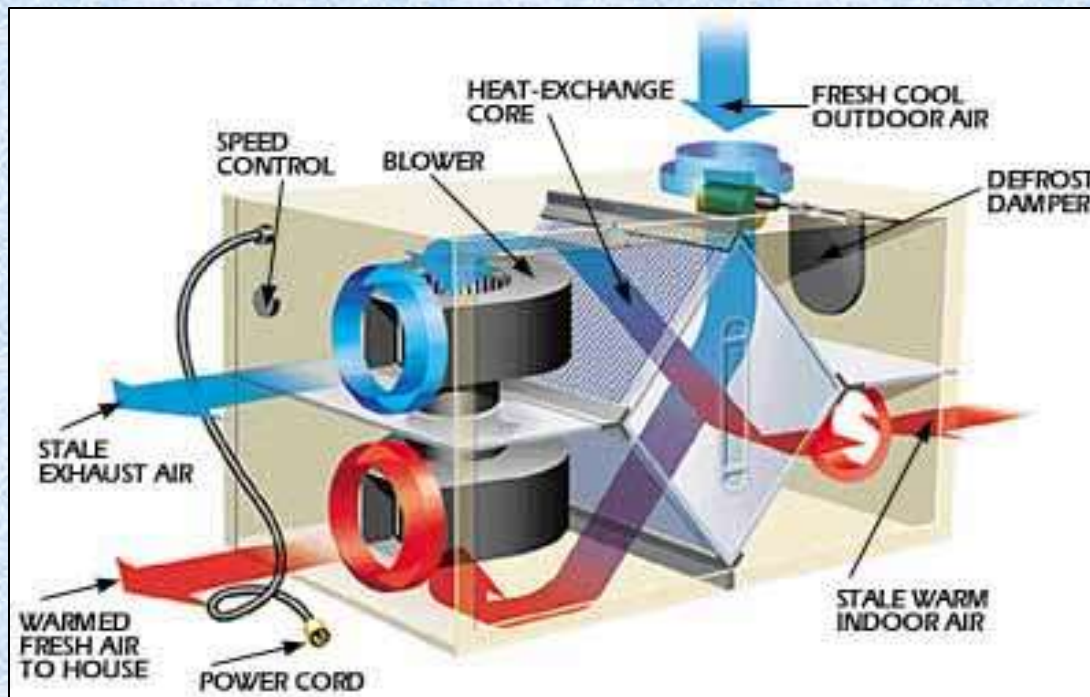

Thank you..