

LIBRARY
ANNEX

2

POULTRY APPLIANCES
AND
HANDICRAFT

GEORGE B. FISKE

SF 4817
135

Cornell University

Library

OF THE

New York State College of Agriculture

Ag. 2543

20/11/10

8806

Cornell University Library
SF 487.F53

Poultry appliances & handicraft; how to m



3 1924 003 144 072

mann

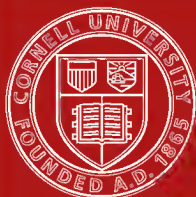

Cornell University Library

The original of this book is in
the Cornell University Library.

There are no known copyright restrictions in
the United States on the use of the text.

POULTRY
Appliances
& Handicraft

*HOW TO MAKE & USE
LABOR-SAVING DEVICES
WITH DESCRIPTIVE
PLANS FOR FOOD & WATER
SUPPLY BUILDING &
MISCELLANEOUS NEEDS
Also Treats on ARTIFICIAL
INCUBATION & BROODING*

Compiled by

GEORGE B. FISKE



Copiously Illustrated

*ORANGE JUDD COMPANY
New York Nineteen Hundred and Six*

Copyright 1902
by
Orange Judd Company

CONTENTS

CHAPTER I

DEVICES FOR FEEDING

Troughs for fowls—Troughs for chicks—Hoppers—Shell and grit feeders—Automatic feeders—Pens and frames—Exerciser.

CHAPTER II

FOUNTAINS AND WATER SUPPLY

System for poultry plant—Self-feeding fountains—Covered fountains—Heated fountains—Water for chicks—Water for ducks.

CHAPTER III

MILLS AND FOOD MACHINERY

Bone and meat grinders—Food choppers—Fodder cutters—Grit machines.

CHAPTER IV

CONVENIENT ROOSTS

A model arrangement—Portable perches—Lice proof—Cold weather plans—Droppings boards and manure bins—For young chickens.

CHAPTER V

DOORS AND WINDOWS

Divided door—Partition doors—Plan for self-opening—Convenient windows—Warm windows.

CHAPTER VI

NESTING CONTRIVANCES

Essentials of a good nest—Two nests from one box—A locked nest—Wire nests—Movable arrangement—Nest for egg eaters—Homemade recording nest box—Combined nest and roosts—Nests for ducks.

CHAPTER VII

HELPS IN HATCHING SEASON

The incubator problem—Grundy's advice on incubators—How to make an incubator—Egg tester—Cabinet, cases and carriers for eggs—Shipping case.

CHAPTER VIII

FROM INCUBATOR TO BROODER.

Brooder management—An expert's directions—Improved brooders—Cheap brooder—Large hot water system—Home-made device—Brooders for summer or mild climate.

CHAPTER IX

TRAPS FOR POULTRY PESTS

The rat nuisance—Improved box trap—Cat trap—Skunk trap—Protection from hawks—Trapping a hawk.

CHAPTER X

THIRTY USEFUL DEVICES

Interior conveniences—Ventilators—Pulleys—Aids in cleaning houses—Dust baths—Feeding arrangements—Feed cookers—Anti-scratching devices—Poultry hooks—Exerciser for ducks—Cutting combs and wings—Protecting injured fowls.

LIST OF ILLUSTRATIONS

	PAGE
Feeding Trough	1
Slatted Feeding Box	2
Trough for Chicks	2
Dry Feed for Chicks	3
Feeding Hopper	4
Shell and Grit Feeder	5
Automatic Feeders	6
Feeding Pens for Chickens	7
Wire Frame	7
Automatic Trough	8
Feeding by Clockwork	9
Feeding Board and Exerciser	9
System for Water Supply	11
Tank Fountain	12
Protection for Water Dish	13
Covered Water Dishes	14
Winter Fountain	15
Lamp Water Heater	16
Kettle and Heater	17
Fountain Warmer	18
Non-freezing Fountain	19
Chick Fountain	20
General Purpose Fountain	20
Water for Chicks	21
Casing for Water Can	22
Safe Water Dish	22
Oyster Can Fountain	23
Box for Water Dish	23
Pool for Ducks	24
Drinking Water for Ducks	24
Hand Bone Mills	26
Mounted Bone Mills	27
Food Chopper	28

	PAGE
Root Cutters	29
Fodder Cutter	30
Grit Pounder	31
Small Grit Pounder	32
Grit Mill	32
Improved Roost	35
Low Improved Roost	36
Portable Roost	37
Portable Lice-proof Roost	37
Lice-proof Supporter for Roost	37
Kerosene Pan for Roost	37
Cold Weather Roost	38
Warm Roosts	39
Separate Roosting Pens	40
Roosts and Dropping Boards	41
Roosts and Manure Bin	41
Roosts for Chickens	42
Combination Door	44
Combination Door	45
Self-opening Doors	46
Warm Windows	47
Protected Windows	48
Double Windows	49
Plain Nest Boxes	52
Secure Nest Box	53
Three Useful Nest Ideas	54
Good Nesting Arrangements	55
Trap Nest Boxes	56
Roost Protected by Nest	57
Nest from a Candy Pail	58
Nests for Ducks	59
Plan for Homemade Incubator	64
Section Plan of Incubator	65
Incubator Drawer and Heater	65
Ventilator Box for Incubator	66
Egg Tester	70
Egg Cabinet	71
Egg Case	72
Egg Carrier	72
Egg Shipping Case	73

	PAGE
Diagram of Brooder with Drum	78
Improved Brooder	79
Brooder for Fifty Chicks	80
Small Lamp Brooder	81
Homemade Brooder	82
The Sure Brooder	83
Heater, Water Barrel and Piping	86
Diagram of Brooder	87
Section View of Brooder	88
Brooder for Mild Climate	89
Outdoor Brooder and Run	90
Improved Rat Trap	93
Cat Trap	94
Skunk Trap	95
Protection from Hawks	96
Trapping a Hawk	97
Setting a Hawk Trap	98
Interior Conveniences	101
Good Ventilation	102
Screw Pulley	103
Homemade Pulley	103
Conveniences for Inside Work	104
Dust Bath	105
Outside Dust Bath	106
For Dusting Fowls	106
Heater for Poultry House	107
Heater and Ventilator	108
Lamp Heater	109
Feed Cooker	110
Small Cooker for Stove	111
Worm Box	112
To Prevent Scratching	113
Shipping Crates	114
Hook for Catching Poultry	115
Duck at Exercise	115
Leghorns with Combs Cut	116
Shield for Injured Fowls	117
Holding a Pigeon	118

INTRODUCTORY NOTE

ABOUT one hundred and fifty handy devices are explained and illustrated in this little book. These have been selected for superior merit from a much larger number available. Here skilled poultry keepers from all parts of the country have detailed the favorite short-cuts that have saved them most loss and trouble. Many new ideas have been added, making the whole a collection in a condensed form of the best practice in poultry mechanics and handicraft. The suggestions cover every department and stage of progress, from egg to market, and include all branches and grades of the business. Not every poultryman will need them all, but it is apparent that anyone who keeps chickens, turkeys or waterfowl will find among the number abundant practical hints for decreasing labor, waste and worry.

CHAPTER I

DEVICES FOR FEEDING

A considerable part of the soft food is spoiled and wasted where it is fed on the ground or on boards and shingles. Where one hundred fowls are kept and twice the number of chickens raised, the loss by such methods may be reckoned at three to five bushels of feed a year. Feeding troughs are easily made, and will quickly save their value, besides tending to prevent the spread of disease so often resulting from placing the food where the fowls can soil it.



FIG I: FEEDING TROUGHS

Troughs and Boxes—Figure I shows at the left of the illustration a feed trough that hens cannot roost upon, cannot get their feet into, and at which they cannot well quarrel. A V-shaped body, with ends as shown, is made and a hinged cover placed so as to fold up against the long slope of the ends. A stout wire is strung from the top of one end to the top of the other, and from this wire extend down to nails driven into the front edge of the trough. When the food has been placed inside and the cover closed, the hens eat by sticking their heads through the upright wires.

An excellent covered trough or box is shown at the right of Figure 1. The top is hinged, and so can be raised to put the food inside. The fowls can then insert only their heads at the sides and ends. The roof-shaped top, having a sharp apex, affords no chance for



FIG 2: SLATTED FEEDING BOX

getting upon the feed box, and remaining there, as is the case with flat-topped covers. This device will also aid in keeping the hens from pecking at each other when eating.

A capacious slatted feed box is shown in Figure 2, suitable for soft feed or for grain. The hens cannot get into it or crowd each other. The cover, which slopes so they will not fly upon it, is covered with wire netting which permits grain to be thrown into the box without



FIG 3: TROUGH FOR CHICKS

raising the cover. Hens do not like to fly up and light on this netting. A square pan may be placed in one end of this box in which to keep water, and in this position it can neither be soiled nor spilled.

Young chickens while with the hen are serious wasters of soft food, whether fed wet or dry. Figure 3

illustrates a little trough for chicks. It is of wood two inches deep and ten inches long for thirty chicks. The ends are one and one-half inches higher, so a slat can be put on it to keep the dirt out of it. It should be placed in a coop where the larger birds cannot enter.

A good feeder for dry cooked feed or dry meal and grain for chicks is shown in Figure 4. Make a trough exactly as for a pig except that it has a crack one-fourth of an inch wide at the bottom. Raise the trough a little above the ground by means of two strips, *c*, fastened to the ends, *b*, and place a board, *d*, beneath the crack of sufficient width that the chicks may eat from it; two and one-half inches is sufficient. Cover the top, *d*, and the trough is complete. By it the food is kept fresh and clean, yet the chicks may help themselves at any time.



FIG 4: DRY FEED FOR CHICKS

Bement's feeding hopper is not a patent affair, and is a serviceable contrivance for those who practice the plan of letting the fowls help themselves to their ration of whole grain. In Figure 5, the end section shows size and operation. *a* is a flap or hinged door, to be opened and shut at pleasure; *b*, a hinged cover, through which feed is supplied; *c*, an incline, throwing the corn or other grain as wanted into the feeding trough. This feeding hopper will answer a very good purpose where there are no rats or mice.

Feeders for Shell, Bone and Grit—Sharp grit, broken oyster or clam shells and charcoal in granular form are necessary for the health and productiveness of fowls. An excellent box for supplying these is

shown in Figure 6. It is self-delivering, but the grating or wire netting over the front keeps the fowls from throwing the material out with their bills, and thus wasting it. Kept before them in this way the hens need never be out of the necessary articles.

A similar feeder with single compartment and no grating is shown at the right of the preceding in Figure

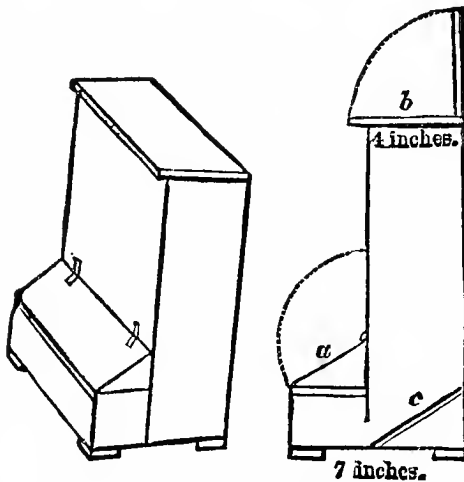
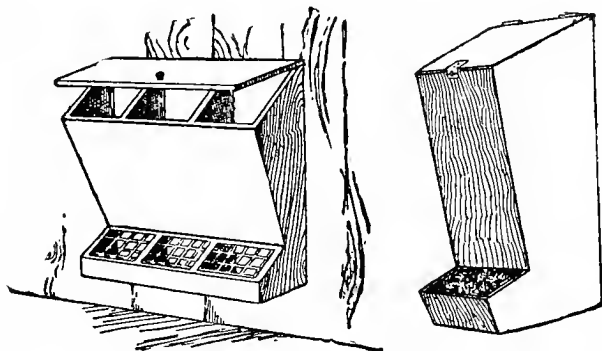

FIG 5: FEEDING HOPPER

7. It is filled at the top and is self-feeding. For winter use as grit nothing is quite so good as the small quarry stone fragments which may be obtained for almost nothing at any stoneyard. These are kept on hand, sifted to the right size, at the poultry supply stores and are now quite commonly used by the best professional poultrymen. If there is no quarry or stoneyard near by, a grit that will answer very well is a barrel or two of gravelly sand, some of which should be shoveled into

the coop every week or two in winter. Oyster shells are not hard enough to take the place of grit.

A simple and effective shell or grit feeder is depicted in Figure 8. It can be made of any desired size. The essential points to the box are: The lid for filling, at 1; a board, 2, to prevent the shells becoming scattered about; check board, 3, slanting backward with small space of one to two inches to hold grit, and the lower edge should be on a level with top of board, 2.



FIGS 6—7: SHELL AND GRIT FEEDER

Hang by hole, 4, just high enough so poultry can get at the grit easily. The fowls pick it out over board 2, at 5.

A shell feeder very easy to make is that shown at the right of the preceding in Figure 9. It is a good style where the shells and grit are mixed and fed from one box. The dotted lines, *b b*, indicate a sharp piece of tin bent to cover half of the holes in the inside to prevent shells from coming out too fast. The hole, *a*, in the back of the box, is to hang up the box. The box is filled with ground shells and hung up within easy

reach of the hens, who soon learn to pick the shells from the holes, *c c*.

Feeding Pens for Young Chickens—Where large and small chickens run at large in the same lot the feeding of them becomes a difficult matter, as the larger crowd the weaker and take most of the food. Get one or more big but low dry goods or grocery boxes and remove a part of each side, as shown in Figure 10, at the left, making the opening just high enough to permit the small chicks to enter. Stretch a wire from

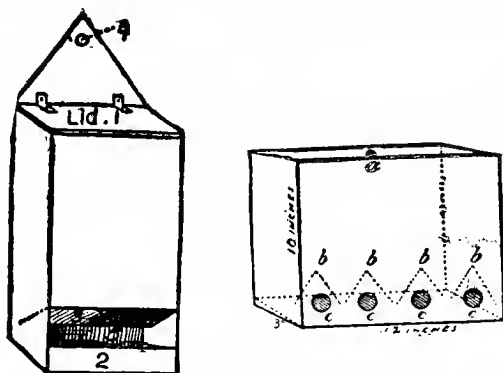

FIGS 8—9: AUTOMATIC FEEDERS

side to side at the top and throw feed inside for the younger broods. They will quickly learn to start for their own quarters when the feed dish appears.

The cut at the right of Figure 10 shows a framework low at one end and much higher at the other, under which chickens of all ages and sizes can be fed, and each one allowed to eat in peace. All sizes of chicks fed together in an open space results in the big ones trampling on the smaller, and robbing them of their share. Some such arrangement as that shown is abso-

lutely essential where chickens have to be hatched during a considerable space of time in the spring. An ideal condition is to have the chicks all early and all of a size, but few can accomplish this desirable end.

A wire-topped feeding frame appears in Figure 11. The framework of the rack proper is about

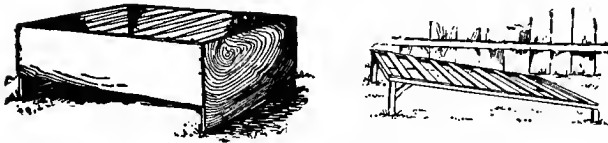

FIG 10: FEEDING PENS FOR CHICKENS

forty inches square and consists of two-inch strips nailed to four small two by two posts about five inches high, thus leaving a space of about three inches between the frame and ground for the chickens to enter. The top is covered with wire netting and the cross sticks are inserted to keep it from sagging.

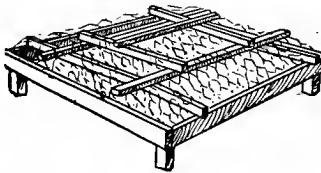

FIG 11: WIRE FRAME

Automatic Feeder—This plan, shown in Figure 12, may be used for grain, shells, scraps or grit, and may be adapted to fowls of any age and size. It is simple in construction and may be of any size desired, but for thirty or forty hens it should be about one foot wide, three feet long and one and one-half feet high.

The ends, *a a*, should be cut as shown, then a board as wide as the ends and as long as the feeder should be nailed horizontally between the ends as they stand upright and four inches below the shoulders. Cut the sides, *b b*, and nail in position, next make a V-shaped trough as long as the feeder and invert between the lower edges of *b b* to keep the food from running out too much at once. Nail on strips, *c c*, which should be four inches wide, and put on a cover with hinges.

Feeding by Clockwork—A feed box as in Figure 13 may be quite easily arranged to open at a certain hour each morning or afternoon, thus providing for the

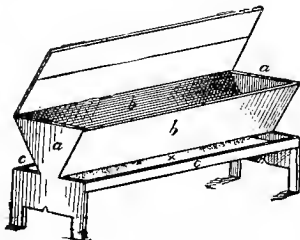

FIG 12: AUTOMATIC TROUGH

fowls during the keeper's absence. Any alarm clock with a fixed key will answer. Unscrew the key that winds the alarm by turning it backward. Have a piece of thin but strong iron, about four inches long, welded to the key, so that it protrudes beyond the clock.

Make a box, of any desired shape, but with a cover on hinges that protrudes beyond the box, having the part that protrudes heavier than the part that covers the box, so that the box will open when not prevented from doing so by the piece of iron, *a*, or the alarm key of the clock. Set the alarm for the hour it is desired to feed, do not wind it too tight, and have the alarm key

pointing in the same direction as the minute hand does when five minutes before the hour.

Have the clock secured to a block of wood, so that the lid of the box is kept closed by the alarm key. When the alarm goes off, at feeding time, the alarm

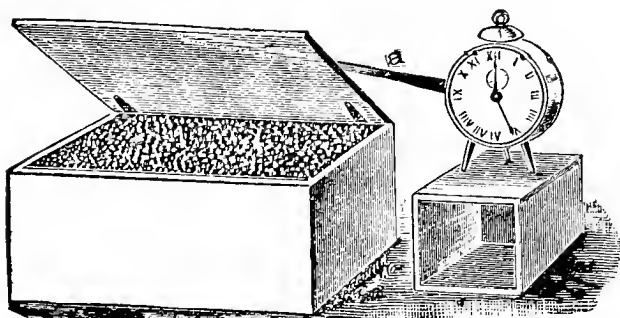

FIG 13: FEEDING BY CLOCKWORK

key will turn and the feed box open. The hens will soon get used to the alarm bell, and run for their feed when they hear it. The same plan can be used for feeding a horse, by having the alarm key support the bottom of the box, which opens with a hinge and allows



FIG 14: FEEDING-BOARD AND EXERCISER

the feed to drop in the manger. The alarm key must be well screwed on to the clock, using a small piece of twine or glue on the thread of the screw, and the clock must be set well back on the block of wood, so as not to prevent the alarm key revolving.

Feeding for Exercise—Plenty of eggs and fertile ones never come from fowls that are allowed to stuff themselves and sit on roosts and boxes all the time until they become sluggish and overfat. The feed board illustrated in Figure 14 is recommended by H. H. Stoddard. A series of boards are firmly joined to reach across all the pens, being attached by wires to the rafters. A supply of fine grain, like wheat, is placed on the boards over each pen, and shaken down a little at a time by a blow from a hammer applied at one end. The grain falls into several inches of litter below, and the fowls scratch for it.

CHAPTER II

FOUNTAINS AND WATER SUPPLY

The weak point about most large poultry plants is a poor water supply. Usually the water is carried to each flock in pails and poured into the dishes or fountains, with much labor and with poor results.

When large numbers of birds are kept, it is of course desirable that a system be adopted for saving labor. A practical system in use is where the water is

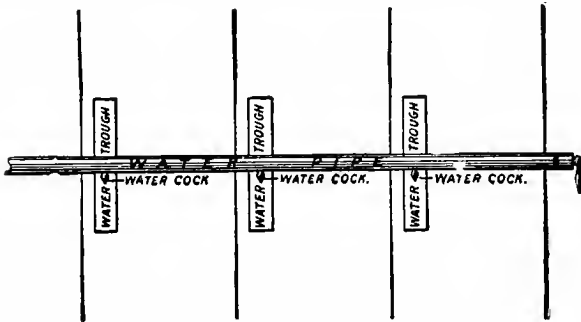

FIG 15: SYSTEM FOR WATER SUPPLY

supplied by inch pipes and having a cock in each pen directly over the water trough. Figure 15 shows a diagram drawing of this plan. The flow of the cocks is regulated by having the one in the first pen run very slowly and gradually increasing the flow of water in each pen. Thus all the troughs will be full at the same time. The pipe may rest on the fencing which divides

the runs. This plan of watering, designed by G. C. Watson of the Pennsylvania experiment station, can also be used in brooder houses to good advantage.

It is important to give fowls fresh, clean drink. A tank shown in Figure 16 is well worth copying. The upper part may be a syrup can with the bottom cut off.

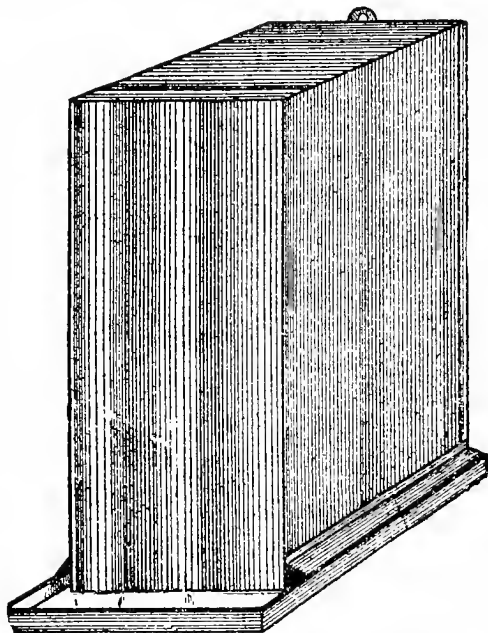

FIG 16: TANK FOUNTAIN

In front at the lower edge a V-shaped notch may be cut three-quarters of an inch deep. On the opposite side, at the top, a bucket ear may be soldered. At the sides of the bottom and near the corners, narrow strips projecting outward should be soldered to slide under

corresponding strips on the bottom pan. The projecting tins should be double to gain strength. Let the pan be an inch and a half deep and at least one inch larger in front. It may fit comfortably at the sides and back to slide easily. Let the can be turned bottom side up, filled and inverted. It may then be hung up to suit the fowls, the ear soldered on at the top of the back slipping over the hook in the wall. Such a tank is best made of galvanized iron. It is a satisfactory affair for poultry of any age.



FIG 17: PROTECTION FOR WATER DISH

For Clean Water—Where plain open dishes are used, as on most farms, they should be put inside a crate to keep the birds from stepping into them or sitting on the edge. An old berry crate will do very well. One made to order is shown in Figure 17. It is a box and it needs no back, as the highest side is to be set against the wall. The top is hinged so it can be raised to set the basin in, and there is a shelf six inches from the bottom to hold the basin and slats in front. The hens cannot stand on it nor in it, nor scratch dirt into it.

Another ingenious plan for keeping the water clean appears at the left of Figure 18. A board bracket is nailed to a post or to one of the studding timbers and on the under side of it is horizontally fastened a square piece of broad board which serves as a shelf to keep the droppings from falling into the drinking vessel below. The vessel should be of such a height that the fowls cannot get between it and the shelf so as to roost on the edge of the vessel. Blocks may be placed below it for this purpose. At the same time the shelf should be sufficiently high that the fowl need only to stoop

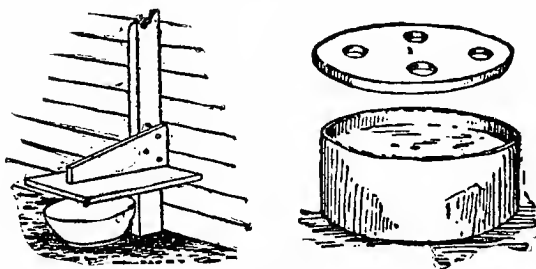

FIG 18: COVERED WATER DISHES

very slightly to drink. This simple contrivance will be found of great service in protecting the drinking water which must be given to the fowls in their houses on stormy or very cold days.

The fountain shown at the right side of Figure 18 will also keep the water fairly clean, besides having a distinct merit of its own. Such breeds as the Leg-horns, Minorcas and some others have such large combs and wattles that there is much danger in watering them in winter from open dishes. They wet these head appendages, then become chilled and many times frozen. A device for avoiding this is shown in the cut. A dish,

whose sides do not flare at all, is fitted with a circular piece of board that will loosely fit inside. In this board are four or more small round openings, through which the fowls can thrust their beaks, but not their combs or wattles. As the water is consumed the board falls, bringing the surface always within reach.

Heated Fountains—Water from which the chill has been warmed away is a stimulant to egg production, just as it is to the milk flow when given to cattle. The illustration shows a plan which has been used in a

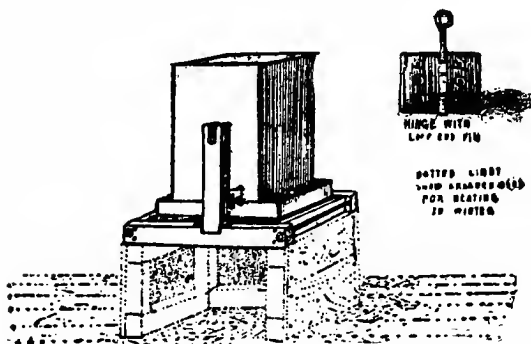

FIG 19: WINTER FOUNTAIN

cold climate all last winter, keeping the water free from ice during the severest weather.

The one in Figure 19 holds about thirteen gallons, but could be made to contain twice that quantity if desired. It is a capital idea for both summer and winter. Anyone can make the frame for the fountain and any tinsmith can make a galvanized tank after this pattern. The cost of the frame, including end rods and braces, will not be over fifty cents, while the tank will cost about fifteen cents per pound, all made. In summer it should be kept out of doors,

either on grass or a wood platform, so the ducks and geese cannot foul the water. A shade of some kind should be furnished.

During the winter the fountain should be furnished with a base, as indicated by dotted lines. Use a brooder stove in freezing weather. It will be unnecessary to burn the stove during the night, for a very



FIG 20: LAMP WATER HEATER

little heat will thaw it out in the morning. It will be better to set the fountain between two pens, for the birds can drink from both sides, as may be seen in the picture.

In constructing one of these fountains, loose pin butt hinges are used to fasten the bottom to the top.

The rod or axle on which it rests goes completely through the fountain and is of galvanized iron, being soldered around it to make it tight. When filling, the fountain is turned bottom up and made fast by the little hooks, as seen in the cut. The rod should be exactly in the center of the tank. The principle is the same as in all fountains that turn in the hand, only the frame in which it rests makes it possible to increase the size.

A fountain like that in Figure 20 may be kept from freezing at very little expense for oil, and it works per-

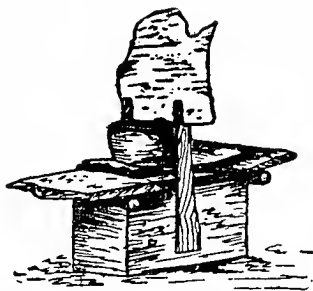

FIG 21: KETTLE AND HEATER

fectly if the funnel part is carefully soldered where it joins the dish. Take a plain side, cake-baking tin with a funnel in the center; also, a butter firkin or nail keg, and a small naphtha hand lamp (without the cotton filling). Place the lamp on the bottom of the firkin, lower the tin until the wick of the lamp is half an inch up the funnel, now insert four screws in the bottom of the firkin, opposite to each other, and just above the bottom of the tin. These pressing against the slanting sides of the tin will support, and turned out or in will raise or lower the tin. Tack the firkin

hoops at the top, middle and bottom, between top and middle hoop on two sides, cut out one or two staves to allow the fowls a place to reach the water. Nail a piece of tin, loosely, on under side of cover, also a strap or rope on firkin for a bail, and it is complete. Use kerosene, and regulate the flame to prevent smoking.

Figure 21 shows a very simple but effective heated fountain which can be rigged up in fifteen minutes with common tools. The top of a box is covered with zinc or sheet iron, projecting at the ends enough to make a stand for the fowls while drinking, or if pre-

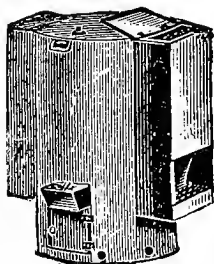

FIG 22: FOUNTAIN WARMER

ferred, the box may be partly sunk in the earth and banked a little at the ends. A common hand lamp is placed in the box under the metal cover, which should not come within three or four inches of the chimney. A very small blaze is enough, and none is needed on mild days. The iron kettle holding the water should be a large one. Keep the fowls off the edge by a partition of tin, as shown.

Fountain Warmer—Figure 22 shows a patent contrivance furnished by the supply stores, and so arranged that food and water or water and milk may be

kept warm and free from ice. Fountain and feed box work automatically. Oil is burned. The idea could be combined with the fountain shown in Figure 19 or 21 so that more than one substance may be kept warm from a single lamp.

Anti-Freeze Fountain—An earthen jug is so fastened into the half barrel by means of crosspieces that its mouth will come near the bottom of the tub, upon one side—a piece of a stave being removed at that

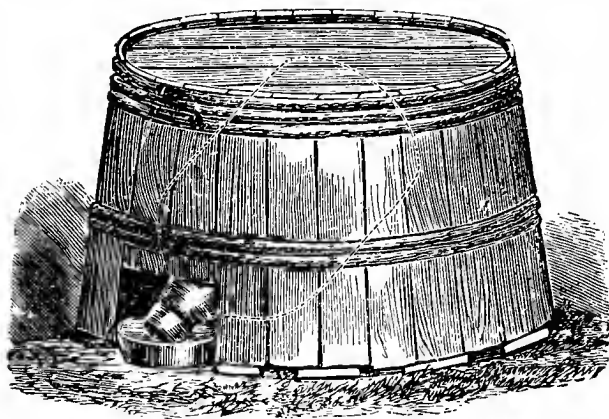

FIG 23: NON-FREEZING FOUNTAIN

point (Figure 23). The space around the jug is filled with fermenting horse manure, and slats are nailed across, when the "fountain" is ready for use. Fill the jug with water and cork it; then invert the tub, bringing the mouth of the jug over a basin, as shown in the engraving. When the cork is withdrawn the water will flow until the mouth of the jug is covered; it will then cease, and as the water is used, more will come from the jug, and so on, forming a continuous self-acting foun-

tain. Such a contrivance will keep the water from freezing, except in the coldest winter weather. The jug should be emptied at night.

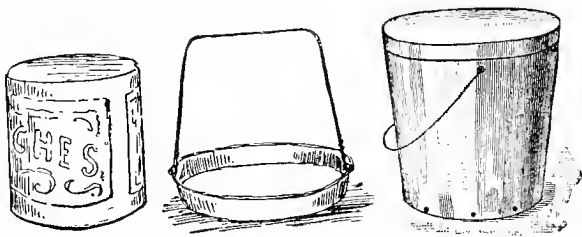

FIG 24: CHICK FOUNTAIN

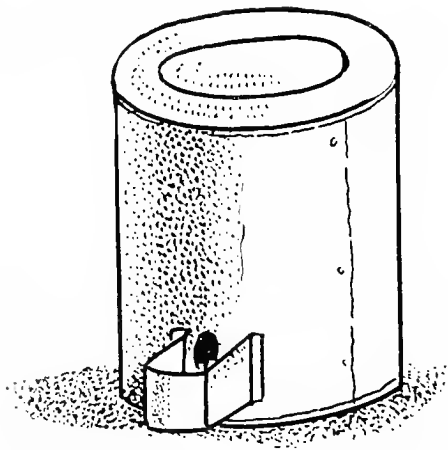

FIG 25: GENERAL PURPOSE FOUNTAIN

Chick Fountains—A fountain for little chickens should be so arranged that they can always get water without soiling it or running the risk of drowning. Many of the chick fountains are also very good for

fowls of all ages. The simplest form is that of the bottle or can filled and placed mouth down over a plate or shallow dish. An improved form is shown in Figure 24. Select one of the gallon-size fruit cans and set it upside down in a tin cake dish from the five-cent counter. Make two dents in the edge of the can, as shown, and fit a wire from one edge of the plate up over the can, and down to the other side. If preferred, a pail may be used, as shown at the right of the basin,

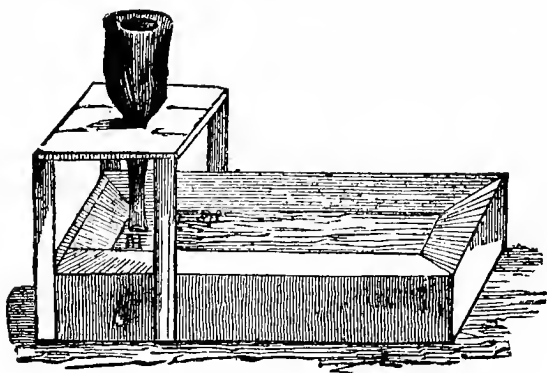

FIG 26: WATER FOR CHICKS

the cover fitting air-tight and holes being punched near the bottom.

Figure 25 is also a fountain from an old fruit can with the top soldered tight again, a hole punched near the bottom and a lip soldered on to hold the flow. All the preceding chick fountains, as also the bottle fountain in Figure 26, depend on keeping the tank air-tight above the water line, so that the water can escape only as fast as the chicks drink it, thus admitting air from below.

Figure 26 explains itself. A bottle holding one or two gallons will work as well as the small one shown.

It should be fitted with a cork having a groove at one side for convenience when replacing the bottle after refilling. A shallow dish may be used instead of the wooden box.

Figure 27 shows the invention of an exasperated poultryman whose hens with chicks insisted on scratch-

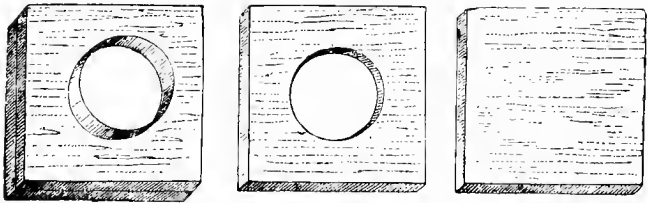

FIG 27: CASING FOR WATER CAN

ing over the water dish as soon as possible. It is of four square pieces of plank, all but the lower section being hollowed out enough to admit the water can. The whole thing being quite heavy, it cannot be upset by the fowls. If the dish is a deep one, a stone should be kept in it to prevent chicks from drowning.



FIG 28: SAFE WATER DISH

A water dish in which chicks are never drowned appears in Figure 28. There is a wooden box eighteen inches long and four inches wide. It should be about two inches deep on the inside. The cover is a board one inch thick, with four or five three-fourths-inch

holes bored through it. Make the cover a little smaller than the box, so it will go easily inside. Fill box half full of water and allow board to float on top. The board will support the weight of the chick and the water will rise about half way through the holes. Using this, the chicks will not get wet.

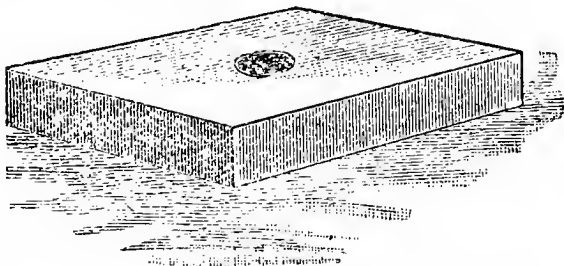

FIG 29: OYSTER-CAN FOUNTAIN

A similar effect is secured in a very simple way in Figure 29. Take an oyster can and cut an opening on one side, as illustrated. It cannot be turned over, and water will not spill out when carrying it. When

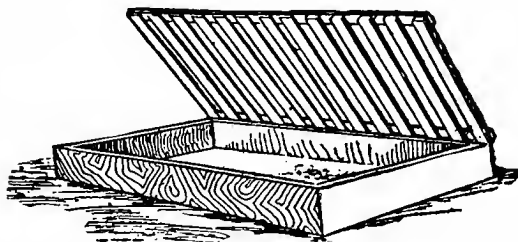

FIG 30: BOX FOR WATER DISH

full it will hold enough water for about fifteen chicks one day. It will cost but little, as it can be made of any

size by a tinner in a short time, if desired of larger capacity.

Protection for Water Dish—Make a shallow box and hinge to it a cover of slats made of laths, as in

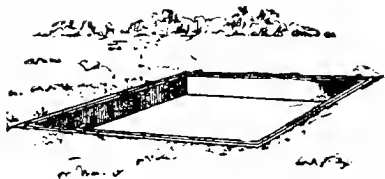

FIG 31: POOL FOR DUCKS

Figure 30. Through these the fowls can reach the water, but cannot soil it. Have the box just large enough to set the dish of water within, and shut the

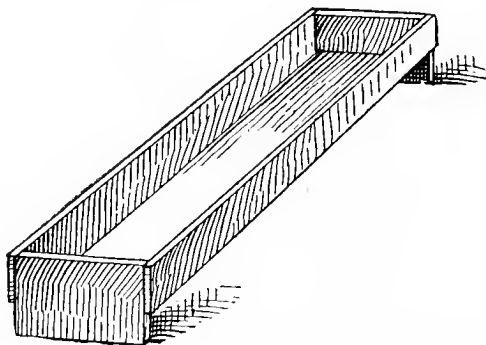

FIG 32: DRINKING WATER FOR DUCKS

slat cover down over it. A similar device for giving water in a way to keep the fowls out of the water vessel is to have a moderately high box, with slats up and

down one side. Then set the water dish within, and the fowls can drink through the slats. The top of the box, or cover, should be sloping, to keep the fowls off from it.

Water for Ducks—Where no pool of water is at hand for ducks, a small pool can easily be made for them, as in Figure 31. Dig a square hole eight inches deep and as large as desired. Put eight-inch boards around the sides. Now tamp down the bottom hard and level, and coat the surface with an inch of cement, bringing the coating up to the top of the boards at the sides, of the same thickness as the bottom. Drive shingle nails thickly into the boards to give the cement something to cling to. In the same way a pool for a “water garden” can be made for the growing of aquatic plants.

Where the object is merely to supply the abundance of drinking water so necessary to young ducks at feeding time, a large flat trough, as in Figure 32, will answer the purpose.

CHAPTER III

MILLS AND FOOD MACHINERY

Prepared foods, grit, shells, meat and clover, may be bought at most large agricultural stores. Special home machines for such purposes are therefore not positively required even where a complete food assort-

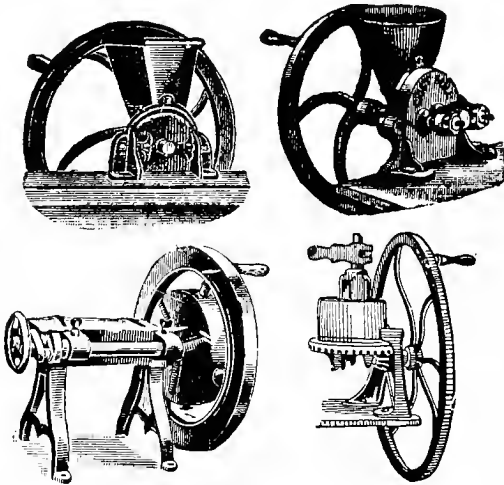

FIG 33: HAND BONE MILLS

ment is wanted. But where home resources are to be utilized to full extent and every penny saved, a few good food machines will pay well for the keeping.

Bone Mills—One of these machines is needed on every farm, since it affords the only means of making

full use of the bone refuse which is constantly accumulating. A first-class mill will work bone and flesh of dead animals and the waste from the table or market into pieces that can be swallowed by the fowls.

By grinding and feeding the bones their full value is secured, as they furnish a first-class egg food, while most of the fertilizing value is secured in the manure. Manure from animal food is nearly as rich as guano.

Several types of the hand bone mill are shown in Figure 33. The two upper mills are for dry bones

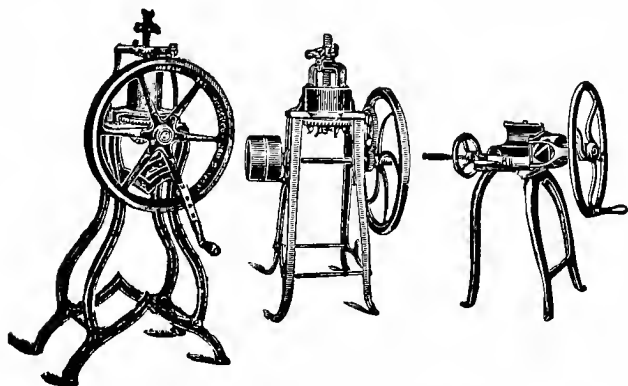

FIG 34: MOUNTED BONE MILLS

only, and are therefore less useful for general purposes. They cost about five dollars each, but some of this type are sold as low as two dollars and a half.

The two mills at lower part of Figure 33 are for green bones. The first pattern works with a chopping motion. The second, one of the oldest and most popular styles, has a cutting action. Both are good for their size, but to operate them with heavy bones is tedious work. For a good-sized flock it is best to have a large

mill as shown in Figure 33, arranging it to run by power attachment if possible. A one-horse sweep power will drive a good-sized machine. Figure 34 shows the Ohio, Mann and Adam makes, besides which there are many others equally effective. Bones, if tolerably fresh, and meat may be quite freely fed if the fowls are watched and the quantity reduced at first sign of bowel disorder. The larger machines cost from

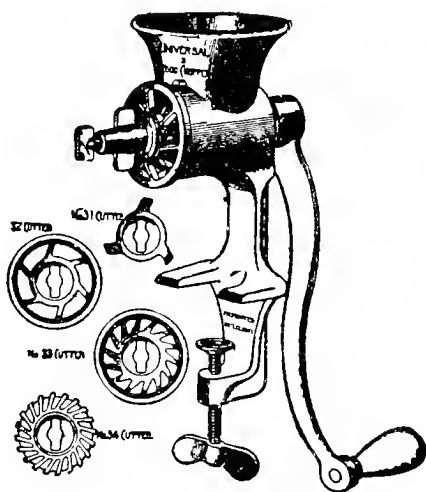

FIG 35: FOOD CHOPPER

eight dollars to twenty-five dollars, according to size and style.

Food Choppers—Where plenty of liver, lights or other solid meat can be had cheap from slaughter houses, such meat will furnish the best form of animal food. It can be worked up very fast in a large, strong meat cutter like that shown in Figure 35, which will cut three or four pounds a minute, fine or coarse, and

can be bought of the supply stores for about two dollars, with a choice of several different makes. These machines will work up any kind of soft refuse food.

For Vegetables and Fodder—For reducing green vegetables, root pulpers, as shown in Figure 36, are

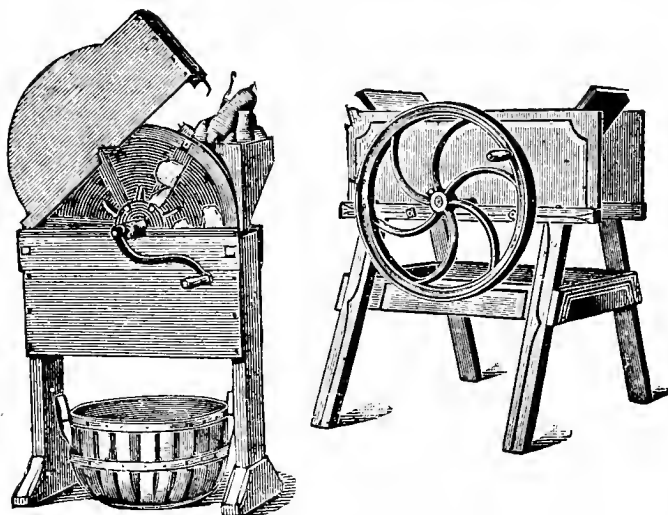

FIGS 36—37: ROOT CUTTERS

useful. Machines may be had which will answer for cattle and for poultry also. Fowls will consume large quantities of finely-cut vegetables, reducing the grain bill and maintaining the relaxed condition of the system favorable to egg production.

Cut fodder will always pay for fowls in close quarters or in winter where snow covers the ground. The old style hand lever cutters will cut clover or rowen fine enough for chickens. Some styles of the wheel cutters, like the one in Figure 37, are made with

special reference to needs of poultry and can be set to cut very short. In summer the lawn mower affords a convenient supply of short, tender grass for chicks and older fowls in yards. The surplus should be kept for winter use.

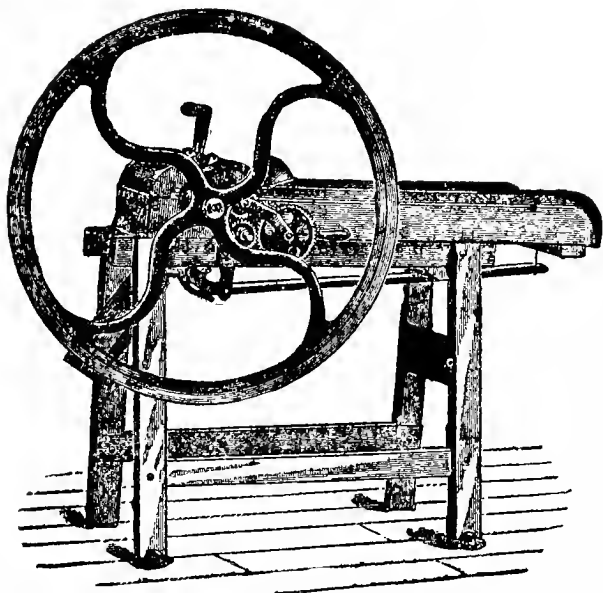

FIG 38: FODDER CUTTER

To Balance a Small Mill—Attach a small crank mill such as is used for grinding coffee and grain for household use to the balance wheel of a corn sheller, fodder cutter or similar weighty machine, simply tying the handle of the mill to a spoke of the large wheel. The mill, if not already secure, should be bolted to the wall at the right height for the power. A mill geared

this way may be driven very fast for coarse grinding, and is very convenient for preparing special mixtures for poultry or for cooking purposes. A small bone cutter may be operated in the same manner.

Grit Pounders—To keep poultry in thrift, and furnish material for eggshells, lime is necessary, as we have said. Oyster shells and clam shells are much used. To pound these, a log of wood may be slightly



FIG 39: GRIT POUNDER

hollowed at one end, and surrounded with a piece of tin (Figure 39), an opening being left to admit the handle of the pestle, which is like a wooden mallet, the striking end being armed with small bolts, driven into the wood so as to leave the heads exposed. A ring to prevent splitting will be an improvement.

Another style, good for crockery and glass, is shown in Figure 40. Take a piece of railway iron about two feet long, and make a box without top or

bottom, one foot high, and just wide and long enough to fit neatly over the rail. Place the dishes, etc, in this mortar and break up with an old ax or sledge. When done remove box and let the chickens at the grit.

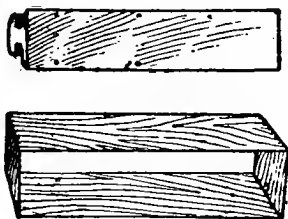

FIG 40: SMALL GRIT POUNDER

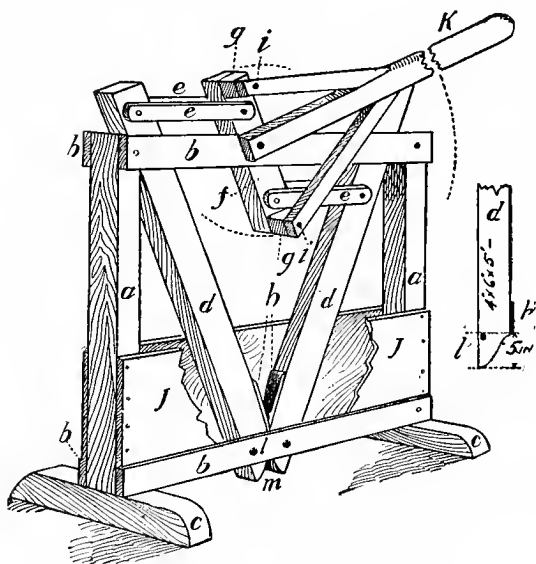

FIG 41: GRIT MILL

A very powerful grit machine is that in Figure 41. It does rapid work with crockery, glass or shells, crushing them with an action much like that of a pair of strong jaws. The grinders are the six-foot arms, *d d*, shod with roughened iron plates above the pivots at *l*, and moved to and fro by means of the lever, *K*.

The frame, *a b a b*, is four by five feet, made of timber four by six inches. The hopper, *J J*, is one foot deep. The pivots at *l, b, e, e*, are stout bolts set to play freely, but the bolt at *g i* is screwed tight. The small side drawing shows construction of grinder arms.

CHAPTER IV

CONVENIENT ROOSTS

The most simple form of good roost comprises a series of straight poles, two inches thick and with bark left on. They should be all on a level and not more than three feet from the ground. They may extend straight across the building, each pole resting in a socket cut into a frame joist of each side, thus allowing each or all poles to be easily removed for cleaning. Lightness and a neat appearance will be gained if two by four building joists with two of the corners rounded off are used in place of poles.

Another decided improvement is to attach the roosts to a frame, and attach the whole by hinges and a cord, as in Figure 42, thus allowing the frame to shut down close against the wall. The cord, *c*, is hung from the roof and is hooked to the frame. At *d* is a support to steady the frame.

A modification of this plan is shown in Figure 43, which represents a very low roost for young chickens or for heavy breeds. The frame of roosts simply rests upon the floor, and when moved it is leaned back against the wall in direction of dotted lines, *c c*. The bars of this roost are made flat to prevent crooked breast bones, often resulting in heavy young birds from pressure against small or sharp roosts.

Portable perches are shown in Figures 44 and 45. They are very handy, not only at cleaning time, but to be transferred from one house to another. In Figure 44 is a simple form of single pole on V-shaped frame

with droppings board below. In Figure 45 are two poles. It prevents the chickens from crowding at ends of perches, as the ends do not connect with the sides or ends of building. The kerosene cups prevent vermin from working to and from any part of the building

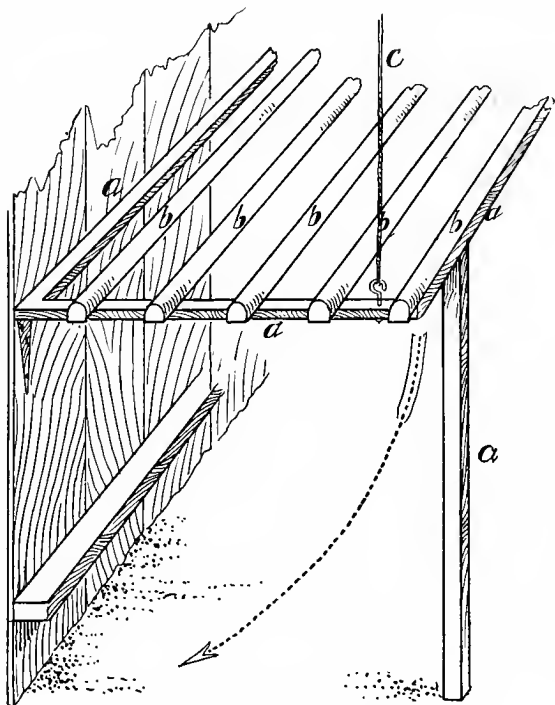

FIG 42: IMPROVED ROOST

on the chickens at night. The coop is more easily kept free from vermin, and does away with whitewashing and cleaning in a great measure. They are not expensive, and in many cases the standards can be mortised

in the four beams, and then would require only four pieces of timber. Perches are fourteen inches high, made of two by fours, and are twenty-two inches wide. The perches are not mortised all the way through and are not fastened.

Vermin Proof—The preceding cut, Figure 45, shows the supports of the roost protected by an oil cup.

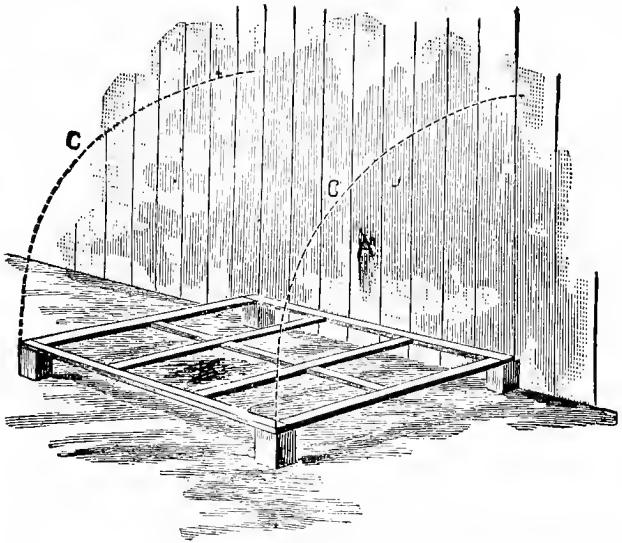

FIG 43: LOW IMPROVED ROOST

In Figure 46 appears a somewhat similar device, where the pole rests on the point of a malleable iron bracket. In the illustration, A is a saucer shaped collar, B the cavity in the collar, D a hole bored through the two by four roost scantling C. It is designed that kerosene oil be poured through D until B is filled and this will keep the little red mites from crawling from the ground and

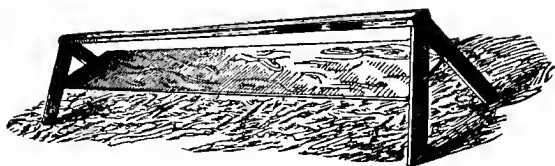

FIG 44: PORTABLE ROOST



FIG 45: PORTABLE LICE-PROOF ROOST

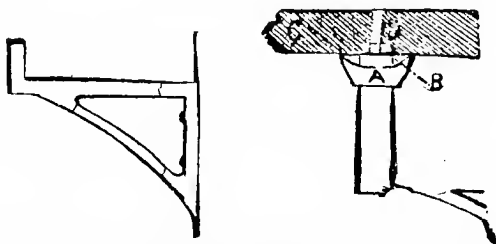

FIG 46: LICE-PROOF SUPPORTER FOR ROOST

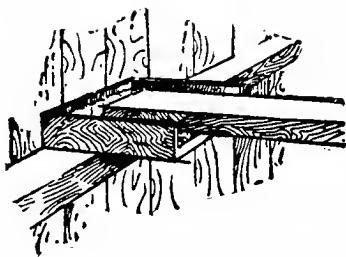

FIG 47: KEROSENE PAN FOR ROOST

sides of the building to the roost. The brackets should be placed upon opposite sides of the building, so that each roost will extend clear across. The hole in the roost should be made so large that it can be easily taken off.

A plan slightly more simple is depicted in Figure 47, where the roost pole rests in a square pan or metal box. The pan is charged with water, on top of which floats a layer of oil.

Cold Weather Plans—Where a small flock of Leghorns, or other tender, large-combed breed, is kept, it is important to provide a very warm roosting place for them if winter eggs are to be looked for in severe

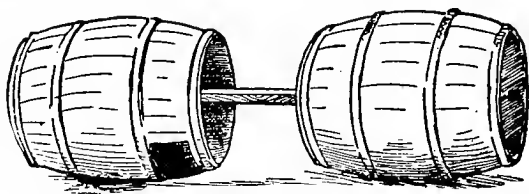

FIG 48: COLD WEATHER ROOST

climates. Figure 48 shows a simple way to make such a warm roosting place. The barrels shut up close together in use, and the fowls enter and leave by the opening that is shown. The barrels can be removed as warm weather approaches, and the usual roosts substituted.

In Figure 49 is shown one end of the poultry house partitioned off, and the separated portion divided in two by a platform at the middle point from floor to ceiling. The upper part contains the roosts and below is a dusting place, with a small window toward the sun. In front is a hinged door that shuts up before the roosts at night to provide warmth, and shuts down over the

dusting room in the daytime for warmth. Two round openings give entrance to the dusting room and ventilation to both places.

Writes J. E. Jones of Wayne county, New York: "My plan of keeping Light Brahma fowls warm winter nights is as shown in Figure 50, at the left of the illustration. It appears, after due experience, to be best

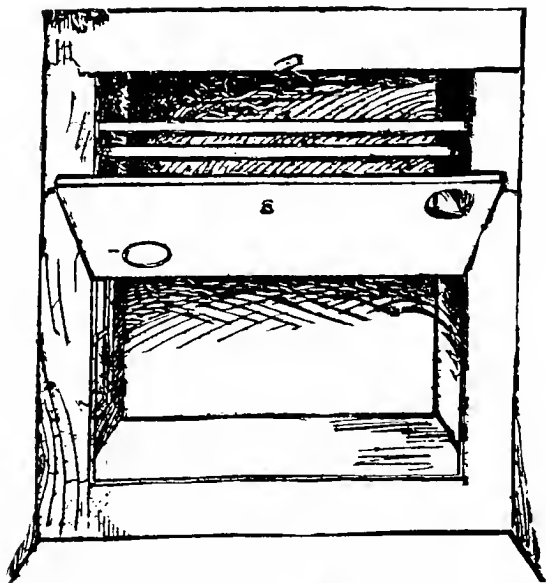

FIG 49: WARM ROOSTS

with Brahmas and Cochins to have no roosts, but to have the fowls sit upon the floor at night. The floor should have a thick coating of road dust or loam, and upon this a thick coat of leaves or straw. On such a floor fowls will rest most comfortably. If roosts are provided, even low ones, some of the fowls will not go

upon them, their great weight making them timid. They will huddle on the floor under the roost, where they would become cold, and their plumage probably soiled in the morning. A low, small addition is made to the regular poultry quarters, the height not being more than half that of the latter. Across the front of the opening is a burlap curtain, hung on a wire, which is drawn across the opening on cold nights, making the fowls very warm within. This low addition

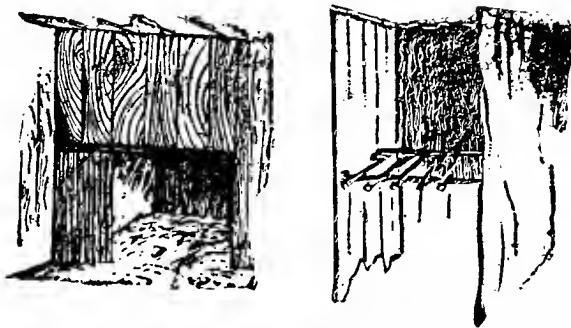

FIG 50: SEPARATE ROOSTING PENS

can very easily be made if the poultry quarters are in another building, the night quarters being let out into the room adjacent."

Another curtain plan for cold weather appears in Figure 50 at the right. Have all the perches, *b*, in one end of the coop and fasten rings to the ceiling so that a heavy burlap or flannel curtain, *a*, may be hung, dividing the coop. There will be enough natural heat from the fowls' bodies to warm this smaller space in the coldest weather. Hang the curtain in place after the fowls go to roost.

Droppings Boards—These are convenient where the droppings are removed often, as they should be in summer, at least. The convenient roosting device shown in Figure 51 is submitted by Mrs. J. Fairbank, a successful Pacific coast poultrywoman, who writes:

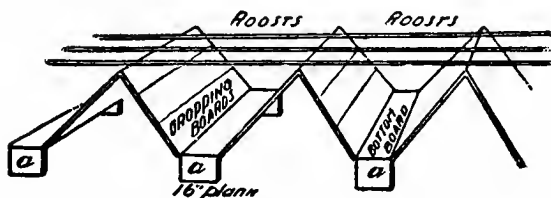

FIG 51: ROOSTS AND DROPPING BOARDS

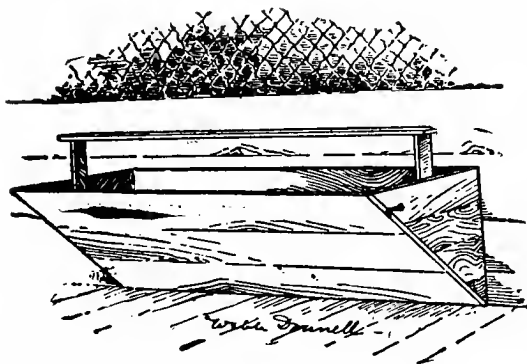

FIG 52: ROOSTS AND MANURE BIN

“To arrange this plan of roosting and droppings boards, first take a two by eight plank, sixteen inches long, nail one end to the floor, five feet from the north side. Take a one by eight-inch board, five feet long, to which nail a cleat sixteen inches from the floor and nail the

other end of the board to the side of the wall. Nail the bottom board, one by eight feet, on top of a short end piece. Cut rafter two by four inches by six feet. Nail rafter to short plank and to meet other rafters, and nail on boards to make slanting platform. Chaff should be placed in the space under the dropping boards, thus making the entire floor available for exercise. Hoe the droppings from the bottom board into a box."

Roost and Manure Bin—Figure 52 shows one of the best plans for caring for poultry manure. The

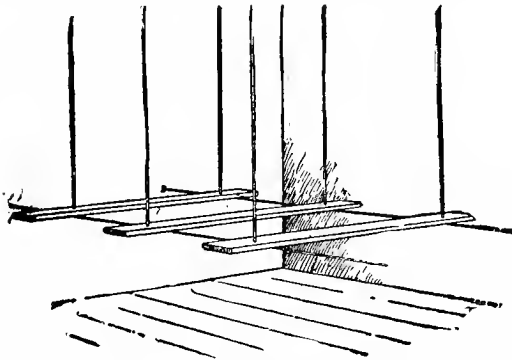

FIG 53: ROOSTS FOR CHICKENS

manure bin is built against the side of the pen, and has a single roost in the center above it.

The front of this triangular box is detachable and is taken away when the manure is to be removed. This need not occur until the box is full, plaster or road dust being scattered over the surface every morning, which will prevent the giving off of ammonia or unpleasant odors. A special advantage of this plan is that it takes no floor space and does away with the ne-

cessity of removing the droppings every day, as in the case of the ordinary platform beneath the roosts.

Roosts for Chickens—As the chickens obtain size, they may be taught to go to roost in some room that is not occupied. Here they will be always under cover and safe at night from their enemies. Make the roost of broad strips of board, to prevent crooked breast bones, and to reduce the risk of vermin use the plan of hanging the roosts shown in Figure 53. The strips rest on horizontal wires, to which they are stapled beneath, and are held firmly up by wires from the ceiling. Number 12 wire is stout enough. The same plan may be used to advantage in the regular poultry house.

CHAPTER V

DOORS AND WINDOWS

A poorly made, badly hung door will be a prime nuisance so long as it lasts, and becomes worse year by year. The doorpost should be large and heavy and well braced to prevent sagging. If set in the ground it should reach down several feet. Leather hinges should not be used even for a slat gate, but rather the

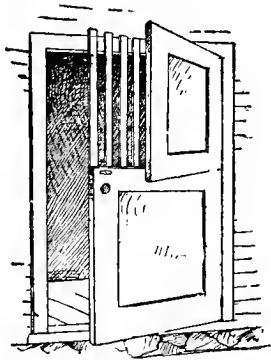

FIG 54: COMBINATION DOOR

strap iron hinges, which are not costly and a good supply of which should be kept on hand.

A divided door for a poultry house appears in Figure 54, giving a combination for both summer and winter use. The lower half has laths nailed to the inside and covering the space filled by the upper half

of the door. The latter may be opened in summer for ventilation. When shut and secured by the button on the lower half, the whole becomes a solid door. The same arrangement will also be found useful in ventilating the poultry quarters upon warm days in winter. Such ventilation, with plenty of sunlight to keep the place warm, and litter in which the fowls must scratch for food so as to get exercise, are prime requisites to success with poultry in winter.

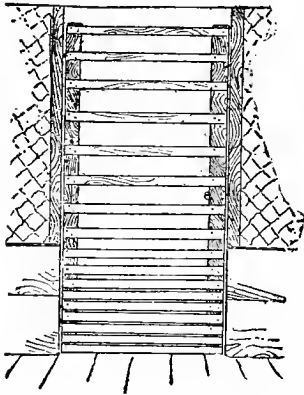
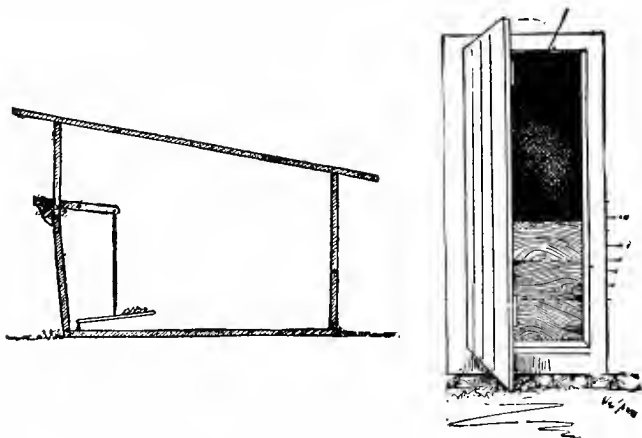

FIG 55: COMBINATION DOOR

Door Between Pens—Where a long poultry building is divided into a number of pens the divisions must be boarded at the bottom to prevent the fowls, particularly the males, from fighting. A good door for such a division is shown in Figure 55. It is made of lath in the ordinary way, but has the laths at the lower part very near together, the spaces growing more open as they go up. This prevents fighting. makes a handsome gate and one easily constructed.

Self-Opening Door—Fix the coop as shown in the diagram (Figure 56), and the chicks will let themselves out of their coops. When one gets upon the board with grain upon it, he pulls the latch open overhead, and the door in front falls. Even without the grain, chicks will open the door. The same device can be used for hens in their houses.

Still another plan to avoid early rising appears in Figure 57. Have boards fitted to slide across the



FIGS 56—57: SELF-OPENING DOORS

doorway of the chicken quarters, and a long hook, to keep the door partly open. Put in one board at first, and teach the chicks to fly up over it at night. Then put in another board, and presently another. Then animals cannot get in at night, while the chicks can go out at dawn. By varying height of board the device can be adapted to chickens of any age.

Good Windows—Common square or rectangular sashes are best for general purposes, and they can

usually be had cheap at auction sales or from dismantled buildings. These windows are, of course, set vertically into the wall, as they will not shed water well if set at much of a slant. Slanting windows must be without crossbars and the ends of the panes must overlap, as in hotbed sashes. Slanting windows usually give more trouble than they are worth, are constantly leaking or breaking, and are not durable. One window to a pen is enough and each one should be made easily

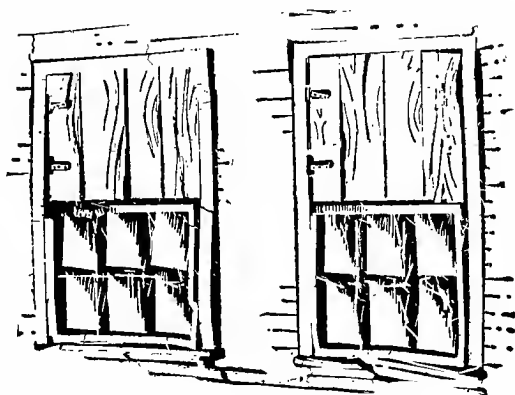
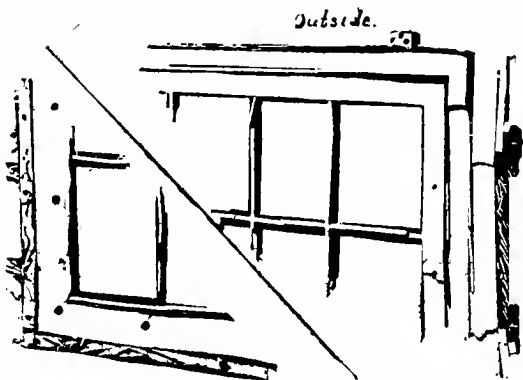

FIG 58: WARM WINDOWS

removable in summer. The space may be protected with wire netting, which may be left on the whole year. If new glass must be bought, the second or third grades will answer. For doing a cheap job, crossbars are not absolutely needed, as if the panes are fitted closely and firmly in the upright bars, the ends of the panes may be brought together without a bar between. Brads may be used instead of putty glazing. A window thus made is a cold affair and is not desirable for severe climates.

Warm Windows—Many poultry houses have twice the glass that is desirable. The houses get very warm in the daytime and very cold at night in winter. An excellent remedy is shown in Figure 58. The upper portion of each sash is removed and a solid board shutter substituted. This can be opened during the warm part of each day, giving the fowls outdoor air with indoor scratching opportunities. Even on cold days these shutters can be opened for a half hour, to thor-



FIGS 59—60: PROTECTED WINDOWS

oughly air the building. In summer the shutters can be opened a little way and fastened, the open space being slatted to prevent the fowls from going out. This will keep the house cool at that season.

Ordinary windows let in much cold about their sides. A helpful plan is to screw wide pieces of board around the outside of the sash, allowing the strips to project two or more inches all around the sash, as shown in Figure 60. Nail strips to the wall around this extended sash and hinge the strips to the exten-

sion of the sash. The window can thus be opened readily, but when closed no cracks are left unstopped. With sashes hinged in this way, the windows of poultry houses may be opened during the warmer and sunnier portions of the day, giving almost the same conditions as are found in open scratching sheds, but without the inconveniences of the latter.

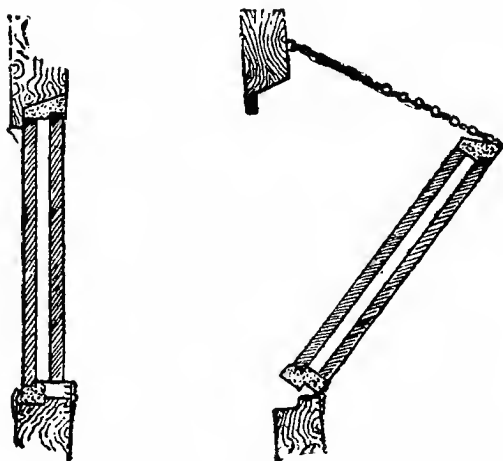

FIG 61: DOUBLE WINDOWS

No farm building more greatly needs double windows in winter than the poultry house, but there is the trouble of securing proper "airing out" of the house on pleasant days in winter, where double windows are used. A double window that can be opened and then closed tightly against the entrance of wind is shown in Figure 61. The top and bottom are fitted to pieces of wood of such shape and fitting that air cannot enter.

The whole is then hinged and swung as one window. One window in a house fitted in this way, with the outside door, will give ample opportunity for ventilating the house every sunny morning. The rest of the windows can be of the ordinary double pattern.

CHAPTER VI

NESTING CONTRIVANCES

A good nest is both safe and attractive. It should be large enough so that two hens at the same time will not break eggs. It should be low at one side so that hens need not jump down upon the eggs. It should have a cover for seclusion and to keep idle fowls from roosting on the edge. The opening should face away from the light, as darkness discourages egg-eating and other forms of interference on the part of mischief makers. For similar reasons the box should be about two and one-half feet above the floor. An alighting board in front of the entrance will afford the layer a chance to enter carefully, as her instinct teaches. The nest filling should be renewed twice a year, and also whenever used several weeks by a sitter. The filling should be abundant enough to prevent breakage and should be free from coarse or thorny material. The presence of a nest egg will usually prevent scratching, but if very young birds are there, they may pull the hay about somewhat. In such cases a filling of shavings or excelsior may be used, and care should be taken not to drop grain into the nests. Nests should be numerous and all about alike, so that none will be overcrowded. If raised well above the floor the space they occupy will not be missed. Every box should be arranged for easy and quick removal when desired.

A very simple nest and easily made, is described by A. B. Hewitt, who writes: "I make them of old soap, candle or starch boxes. Take the box

with the lid nailed on and four inches from one end rule a line as shown by the dotted line in the first illustration in Figure 62. Then mark the other end of the box on the opposite sides in the same way, also shown by the dotted line. Now saw the box where these lines are, and it will make two nests like the one shown in the second half of the figure. Nail a cleat of one-inch stuff just at the top, and inside of the high sides of the box. This cleat makes a convenient han-

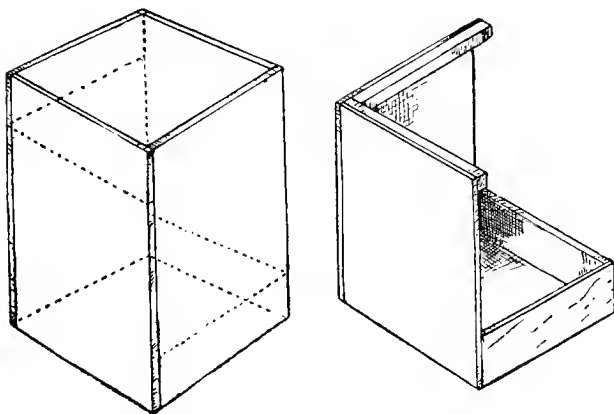

FIG 62: PLAIN NEST BOXES

dle, and at the same time strengthens the box. The nests should be placed beneath the droppings board with the high sides next to the entrance of the pen or henhouse. By tarring all the joints or painting them with a solution of carbolic acid, they are easily kept free from vermin. They will be found much better than a long box, as one can be removed at any time for setting a hen in another part of the building. I never have any trouble from the hens flying off their nests

upon my approach. The boxes should be bought for from eight to ten cents each."

The cuts in Figure 63 show how a contrivance can be made for laying hens which will keep out hogs, dogs, or any animals liable to destroy the eggs. The framework is two by three scantling. Then ordinary boards are used for the sides and roof. The hens go in at the entrance and pass around either end of *a*, gaining access to the nests. A little door, *b*, at the end, shown in the right-hand cut, closed, by means of a hasp, permits entrance for the removal of the eggs. This

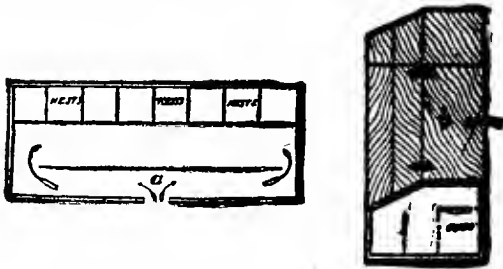

FIG 63: SECURE NEST BOX

little nesting place can be moved to any convenient part of the yard and the eggs deposited there are secure. The hens will soon learn to go to it. The material required is eight pieces of one by twelve inches eight feet long, two pieces of one by fourteen inches three feet long, two pieces of two by three inches three feet long, eight pieces of one by twelve inches twelve feet long, two pieces of one by three inches eight feet long, and one piece of one by ten inches six feet long, with two pounds of eightpenny nails.

Open-work nests, as in Figure 64, at the left of the illustration, are easily kept clean and free from

lice. They may be bought ready-made, or may be woven from old bale hay wire or from willow wands. A thorough singeing or scalding will renovate the nest at any time. The nest should have a wooden edge-piece for the hen to alight on, and a large card for dates of sitters is a convenience.

A plan for transferring sitters is shown at the right of Figure 64. The nest boxes, b, d, are placed on a board platform, e, extending through the partition between a room for layers and another for the sitters.

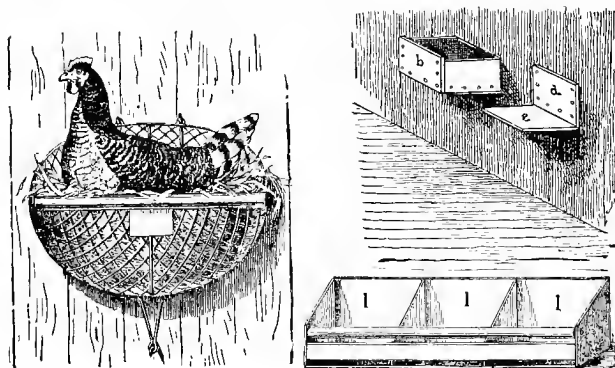

FIG 64: THREE USEFUL NEST IDEAS

When a hen is to be set, the box with hen and eggs is simply pushed through the partition.

Prevents Dirty Nests—Fowls can be prevented from roosting on the edge of their nest boxes by placing a two-inch roller at the front of the boxes, as shown in Figure 64, l l l. The roller revolves easily upon a wooden pin at each end. The sides of the boxes are made slanting for the same reason.

A New Nesting Arrangement—To make dark nests inside a henhouse is a matter involving not a

little work. And even then the nests often prove a nuisance, since the fowls roost on them and soil them constantly. A handy contrivance for securing dark nests is shown in Figure 65. Where the fowl-house is inside another building, or has a hallway, this plan can be easily and conveniently used. Long boxes are used for the nests, each having a partition across the middle with a round opening through it large enough for a hen to pass through. Two other round openings for each nest are made. One in the outside

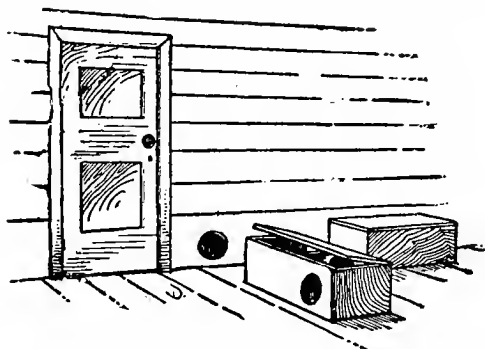

FIG 65: GOOD NESTING ARRANGEMENTS

of the box, as shown, another in the partition of the henpen. Place the box against the outside of the partition so that the two openings will come together, when the hen can enter and pass around into the dark nest. A hinged cover gives access to the eggs.

Homemade Recording Nest Box—One of the best non-patented devices for keeping egg records is that used at the Maine experiment station and illustrated herewith (Figure 66). In the drawing are shown two of the completed nests from side to side, one of them closed after the entrance of a hen and the other re-

opened for the entrance of another layer. After each hen has laid, the attendant removes her, and each hen has a band with a number attached to her leg and the eggs may be numbered to correspond. This process is gone through in the attempt to pick out the best layers to keep over for breeders and the experiment station hopes to establish a strain of wonderful layers.

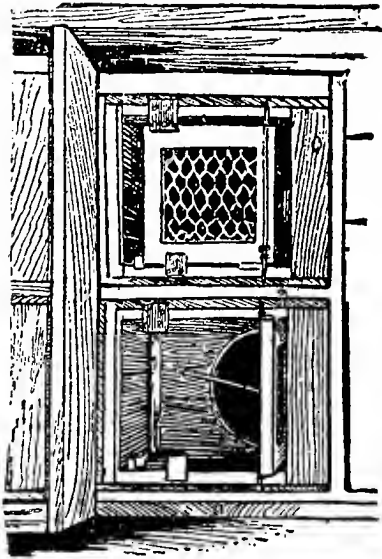

FIG 66: TRAP NEST BOXES

For those who wish to make their own boxes, the following directions are supplied by Professor Gowell of the Maine station:

It is a box-like structure, without front end or cover, twenty-eight inches long, thirteen inches wide and thirteen inches deep inside measurements. A

division board with a circular opening seven and one-half inches in diameter is placed across the box twelve inches from the back end and fifteen inches from the front end. The back section is the nest proper. Instead of a close door at the entrance, a light frame is covered with wire netting. The door is ten and one-half inches wide and ten inches high and does not fill the entire entrance, a good margin being left all round to avoid friction. It is hinged at the top and opens up into the box. The hinges are placed on the front of the door.

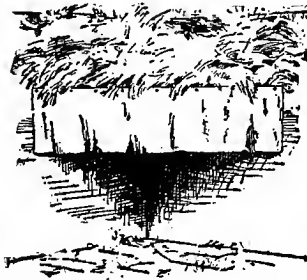

FIG 67: ROOST PROTECTED BY NEST

The trip consists of one piece of stiff wire about three-sixteenths of an inch in diameter and eighteen and one-half inches long, bent as shown. A piece of board six inches wide and just long enough to reach across the box inside is nailed flatwise in front of the partition and one inch below the top of the box, a space of one-fourth of an inch being left between the edge of the board and the partition. The purpose of this board is only to support the trip wire in place. The six-inch section of the trip wire is placed across the board and the long part of the wire slipped through the one-fourth-inch slot and passed down close to and in front

of the center of the seven and one-half-inch circular opening. Small wire staples are driven nearly down over the six-inch section of the trip wire into the board so as to hold it in place and yet let it roll sidewise easily.

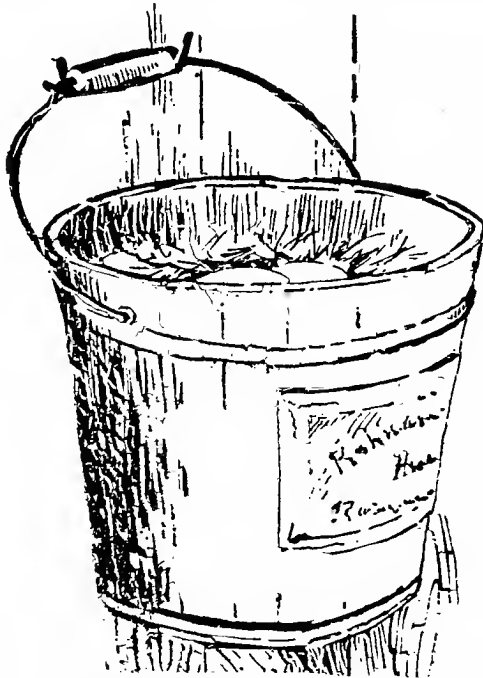

FIG 68: NEST FROM A CANDY PAIL

When the door is set, a section of the wire comes under a hardwood peg or tack in the lower edge of the door frame. The hen passes in through the circular opening, and in doing so presses the wire to one side, which lets the door down and fastens itself by a wooden

latch or lever. The latch is five inches long, one inch wide and one-half inch thick, and is fastened loosely one inch from its center to the side of the box, so that the outer end is just inside of the door when it is closed. Pieces of old rubber belting are nailed at the outside entrance for the door to strike against.

Roosting and Nesting Device—Figure 67 shows a very excellent roosting and nesting device that has done duty in the cold of a Maine winter. It is in use for a small pen of Leghorns—a breed that must be

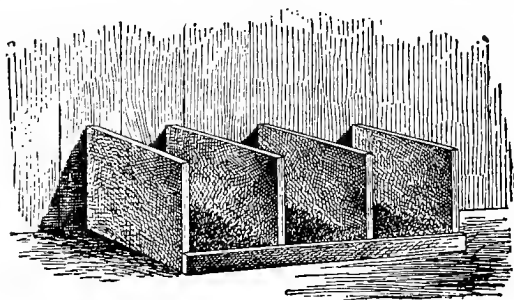

FIG 69: NESTS FOR DUCKS

kept warm at night, if eggs are to be had at this season of the year. The roost is put across the corner of the pen and a piece of burlap is stretched before it. A few crosspieces are laid across the corner at the curtain's upper edge, and on these is piled a lot of waste hay, making a very warm roosting place. The Leghorns delight to fly up on this hay and lay their eggs under the impression that they are stealing away their nests. Humoring a Leghorn in this way is conducive to laying, and the eggs can easily be reached. As the whole thing can be put up in five minutes' time, there is no excuse for frosted combs on the Leghorns.

At stores where candy is sold, one can buy for a few cents the light, but large, wooden pails in which broken candy and certain grades of chocolates are shipped from the factory. These pails make excellent hens' nests when hung from two hooks in the manner shown in Figure 68. The weak point of this nest and several others described is that no alighting board is provided and no shelter to keep fowls off the edge. These improvements, however, can be added. Such nests can be taken out of doors, emptied and cleaned in a moment, and having no corners or open joints, as do boxes, there is no place for vermin to hide about them. This is a special point in favor of the use of such pails as nests, for the ordinary nest is usually a breeding place for these troublesome pests.

Nests for Ducks—Some duck raisers use a plain nest, as shown in Figure 69. These nests are made of one-inch boards, twelve inches high and sixteen inches long, set fourteen inches apart, and held together in front with a three-inch strip. The nests are nailed to the back of the house.

CHAPTER VII

HELPS IN HATCHING SEASON

No doubt but that a good operator can hatch perfect chicks by incubator and keep up the vigor and excellence of his stock year after year without using a single sitting hen, but complete success requires care and experience. Very complete manuals on the subject may be had free by writing to those who advertise the machines. Of late years many very practical incubators have been placed on the market, while the older makes have been greatly improved, especially in regard to heat regulation. The incubator catalogs contain plenty of testimonials, and by writing to some of the more prominent of these, the intending buyer may soon decide which machine is best suited to his taste and conditions.

While there are still many points of difference between manufacturers as to hot air or hot water heat, moisture or no moisture, cooling and ventilation, yet most of the incubators now on the market will hatch eggs satisfactorily in the hands of a careful operator. By the use of common sense and following the instructions laid down by the makers, even a beginner can expect good hatches from fertile eggs. With experience, hatches of seventy-five to ninety per cent of fertile eggs are commonly obtained.

Incubators vary in capacity from fifty to four hundred eggs. One size is as easy to run as another. For the practical farmer a machine of one hundred, one hundred and fifty or two hundred-egg capacity is the

best size. Three hatches in a season will, with average success, give as many chickens as ordinarily wanted.

Something depends on the machine, but more on the operator, and most of all on the eggs. Any machine that will keep even heat can be made to hatch successfully. If the temperature is kept at one hundred and two or one hundred and three degrees, if ventilation is reasonably good, if eggs are all of the same kind of shell so that the air will enlarge at the same rate, and if the air cell is watched and by ventilation or moistening, if necessary, made to correspond with the air-cell charts furnished with the machine, the eggs having also been turned as directed, then a poor hatch is almost surely the fault of the eggs.

Early in the season eggs are less likely to be fertile. Very late in the season many are infertile, and the germs are feeble, causing many to die in the shell. Eggs with thick, dark shells are harder to hatch than others, and many germs die in the shell or turn out feeble chicks. Eggs should be of about the same age, should not be kept over two weeks before starting and must all be put into machine at same time. Extremely large eggs and long slender ones do not hatch well.

Better operate the machine empty a few days at beginning of each season. Fill the lamp every morning and trim the wick by scraping off the top. Have a new wick for every hatch and use good oil. If accidents happen and temperature goes above one hundred and five, chicks will be somewhat injured. Even one hundred and ten for a few hours does not necessarily kill, but most of the chicks will be weakened. Eggs should be sprinkled and cooled at once after having been much overheated.

In five days from the start, test the eggs, take out those that are not fertile, mark doubtful ones, putting them back to be inspected ten days later. Give no

moisture the first week, very little the second and a great deal the latter part of the last week. But follow the directions from the manufacturer as to moisture and depend more upon the size of the egg air cell than upon any set rule. Turn the eggs at intervals of twelve hours and change the position of the drawers each time. Drawers that are nearest the lamp should be placed furthest away once in twenty-four hours, the front end of the drawer being turned to the back of the machine. When the eggs begin to pip do not disturb the hatch till it is well through, as taking out moist chickens from the machine lowers the temperature, lessens the degree of moisture and impairs the hatch of the remainder.

A well-known Illinois poultryman, Fred Grundy, was asked to give some elementary incubator advice. He wrote as follows:

“Practice with the machine until you can run it steadily day and night without any change in the temperature of the egg chamber. You should be able to do this in a week. Then put in the eggs. This will lower the temperature of the egg chamber very much unless the eggs are first warmed. I prefer warming nicely before putting in. Very early in the morning is the best time for starting, for the thermometer can be looked at at least once each hour until ten o'clock the following night. If it remains steady everything is right. At the end of ten days you may test out the infertile eggs, and put in one pan of lukewarm water for moisture. Repeated experiments have thoroughly satisfied me that each hatching should be placed in the machine at one time, and no eggs added thereafter even if two-thirds are tested out as infertile.

“At the end of two weeks the heat of the hatching eggs will be such that you must watch closely lest the temperature rise too high. Be sure that it never goes

above one hundred and three degrees. If there must be a variation, ninety-five degrees is far better than one hundred and five. If the air in the room is constantly warm and dry, place a second pan of lukewarm water in the machine at the end of the second week. If the room is in a cellar and moisture shows on the windows, one pan of water under the eggs is quite sufficient.

"When the eggs begin to hatch don't open the door for love or money. Have the thermometer fastened so the chicks cannot knock it over and see that the temperature does not rise above one hundred and three. Don't remove the chicks from the chamber until they

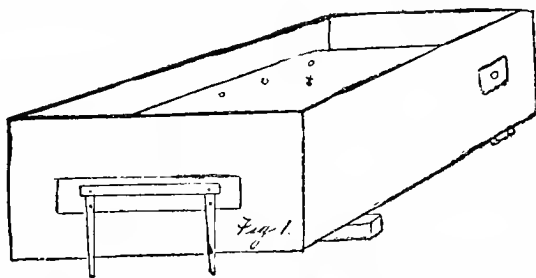

FIG 70: PLAN FOR HOMEMADE INCUBATOR

have been hatched at least twenty hours; then quickly place them in a brooder heated to one hundred. When you buy an incubator see that the egg tray fits the chamber, so that newly hatched chicks cannot possibly fall over its edges into the moisture pans below."

How to Make an Incubator—Scores of machines have been made according to the following description, and good success in hatching has resulted. This incubator requires closer or more frequent attention than do machines with a more elaborate system of heat regulation, but with care and experience first-rate hatches may be obtained.

Figure 70 gives a general idea of what is to be made. A side sectional view showing the internal arrangement and construction is shown in Figure 71. The egg drawer is at *e*, the heater box at *h*, the sawdust

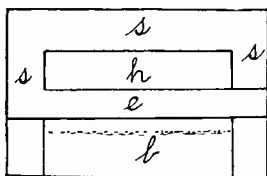

FIG 71: SECTION PLAN OF INCUBATOR

filling to retain heat at *s s s* and the ventilator box is at *b*, filled with sawdust up to the dotted line.

Use well-seasoned matched pine boards one inch in thickness for all parts except the sides and ends of the egg drawer, which should be a quarter of an inch heavier.

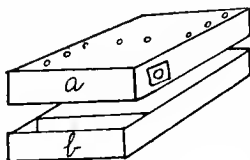

FIG 72: INCUBATOR DRAWER AND HEATER

The heater is made first and is shown at *a* in Figure 72. It is three feet by four feet and six inches high. It takes two boards six inches wide and four feet long for the sides; and two boards six inches wide and two feet ten inches long for the front and back; the top, being made of matched boards nailed on very

tightly, has eight holes bored in it. The center holes are for a three-eighths-inch bolt seven inches long, with a large flat head on one end and a thumbscrew on the other. The other holes are for six escape pipes, which are fifteen inches long and three-fourths of an inch in diameter. Bore three holes on each side three inches from the outside edges of the sides; the first three inches from the corner, the second fifteen inches from the corner, the third twenty-seven inches from the corner, as shown in Figure 72, *a*.

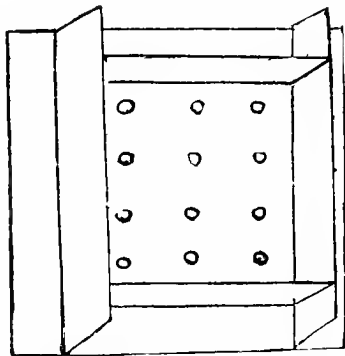

FIG 73: VENTILATOR BOX FOR INCUBATOR

Now cut two holes, eight inches from opposite corners (one is shown in the drawing), in the center of the sides and four inches in diameter; and over both the inside and outside tack stout pieces of tin containing round holes two and one-half inches in diameter. These holes are for the lamp pipes, and the tin protects the wood from fire. Directly under each of these holes inside, nail a piece of tin a foot square, putting it half an inch from the bottom, bending down the two corners not nailed half an inch. When the zinc is nailed

on, this will make two thicknesses, with half an inch air space, and will prevent overheating below the lamp pipes. Use stout zinc for covering the bottom, with a hole for the bolt in the center of it. Nail it on with double rows of lath nails, about an inch apart, and it will be air tight. Put the bolt in and tighten up the thumbscrew.

The drawer, Figure 72, *b*, is five inches deep in front, four feet nine inches long, and two feet eleven and one-half wide. After saving a space in front eight inches wide for sawdust, take a piece of heavy, coarse muslin or tow and stretch tightly over the bottom and fasten with tacks. Nail a board nine inches wide under the front space for sawdust, but cover the other parts with slats one inch square, nailing them on crosswise through the tow, and place them about an inch apart.

A very convenient and complete egg turner may be made by making a frame with beveled cross-slats. This should be three inches shorter than the inside measurement of the drawer, and just wide enough to slide nicely. The sides of the frame should be seven-eighths by three-eighths of an inch; the ends, seven-eighths square. The slats are seven-eighths of an inch high and one-half an inch across the bottom, and are one and seven-eighths inches apart at the top. It is well to put the slats two inches apart for extra large eggs or duck or turkey eggs. By moving or sliding this frame back and forth, the eggs turn very nicely.

The ventilator box, with the bottom of the incubator, is represented standing upright in Figure 73. The box proper is three by four feet, the same as the heater, but eight inches high. By noticing the drawing, it will be perceived that the bottom of the incubator is eight inches larger every way than the ventilator box, and that the same matched boards answer for both. The twelve half-inch holes are for

twelve tin pipes to furnish ventilation from below. These pipes are eight inches long. The sides of the ventilator box extend out even with the bottom of the incubator for the drawer to slide on.

Having made this, place the drawer on it, and the heater on the drawer, and fasten the heater and ventilator together with boards nailed on the sides and back. The boards should be one foot wide, and be nailed so as to allow the drawer to work nicely between the heater and ventilator. These boards on the sides must project the same at the front as do the sides of the ventilator. Next fit an eight-inch board over the front of the drawer, keeping it level with the zinc. This keeps the sawdust from falling into the drawer.

Now with the bottom as a guide, build the outer box for sawdust, making it nine inches higher than the top of the heater, and taking care to fit the front boards around the end of the drawer nicely. To allow the lamp pipes to enter, cut holes in the outer box the same as was done in the heater, but using tins on the outside only. Where the lamp pipes pass through the sawdust, a box for sand must be made of sufficient size to properly protect the sawdust. The tinsmith must make the lamp and escape pipes as stovepipe is made, but the ventilator pipes may be soldered, as they are in no danger of melting. The escape pipes must be cut off so as to come to a point, so that when they are pushed down and touch the zinc, only a small draft is allowed, and the draft cannot become closed.

The lamp pipes should be two and one-half inches in diameter, with elbows in them allowing the pipes to extend into the heater three inches at one end, and at the other end to fit a tin lamp chimney with an isinglass window in it one inch in diameter. This

isinglass window is to see the flame of the lamp and should be cut where the flame can be readily seen. A large fount lamp with a Number 2 burner is placed on a slide that can be pushed under the incubator (as shown in Figure 70), when removed for trimming.

The legs hold up the drawer when drawn out, and the handle is merely a crosspiece fastened to them. The legs extend three inches below the bottom of the incubator, and they just clear the floor when the incubator is placed on two pieces of scantling to allow air to pass up through the pipes in the ventilator box.

After setting the incubator in the place where it is to be used, put sand into the boxes around the lamp pipes, and put sawdust in the ventilator box up to within one inch of the top of the pipes; also in front of the drawer and all around the sides, and on top of the heater up to within an inch of the top of the escape pipes, being careful not to allow any sawdust to get in the pipes. Cover the sawdust with paper, allowing the pipes to be open.

You are now ready to light the lamps. Use head-light oil (one hundred and fifty degrees test), keep the lamps at a medium hight, and in a few days you will have the incubator thoroughly heated. By observing the two good thermometers in the front and back ends of the drawer, you can easily keep the temperature at one hundred and three degrees by turning the lamp screws up or down. When you have the machine under proper control, put the eggs in, and in about twelve hours they will be warm enough without turning up the lamps, and they will remain so unless the lamps are changed when filled and trimmed.

By trimming every other day, and filling daily, the temperature can easily be kept uniform by looking at the thermometers every six hours and turning the

lamps up or down. From one hundred and two degrees to one hundred and five degrees is the proper temperature. Good, reliable thermometers must be used and the bulbs should rest on eggs with the tops slightly elevated.

Egg Tester—Figure 74 represents a contrivance for testing the freshness or fertility of eggs, useful in

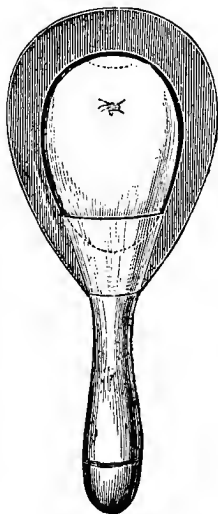

FIG 74: EGG TESTER

the household or to the poultry fancier. It consists of a small handle, with a cup in the end of it; around the cup is fastened a frame of sheet tin or stiff cardboard. This frame has a hole in the center, of the shape and size of an egg, and a strip of black ribbon or cloth is fastened around the frame, projecting a little beyond the inner edge. To test the egg, it is placed in the cup, so as to fill the space in the center

of the frame, the edge of the black cloth or ribbon fitting close to the shell. When the egg is held close to a bright light, the light passes through the egg, and shows a fresh or infertile one to be perfectly clear, while a fertile one that has been sat upon, or that has been in the incubator two days, will show the embryo, as in the engraving, as a dark cloudy spot.

Handling Eggs—They should be picked up twice a day in summer at least, and it is better to keep up the practice all the year round. They should be carefully assorted, putting in one class only large, clean-

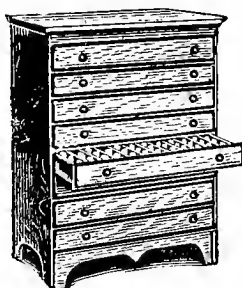

FIG 75: EGG CABINET

shelled eggs. Into the other basket should go all the very small ones, all the thin-shelled ones, all the poor-shaped ones, all with discolored shells. Some of the dirty ones may very likely be carefully washed and put with those of the best grade. For a grade of eggs selected like these and always to be depended upon, there should be no difficulty in finding a regular market at several cents per dozen above the average price. The few culls that remain can be sold to boarding houses or bakeshops, if offered in a strictly fresh state.

Eggs for hatching may be kept three or four weeks if properly stored. Figure 75 shows a cabinet for the purpose. The drawers are fitted with the pasteboard fillers from old egg cases, which may be bought for a few cents at the grocery stores. Turning the eggs is not essential if they are to be set within

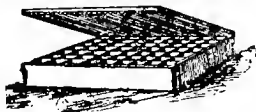

FIG 76: EGG CASE

two weeks. For turning, a lath cover must be made for each drawer so that drawer and eggs may be turned in one movement and replaced with the cover beneath. At next turning the whole is reversed. The drawers must be so planned to allow for cover if turning the eggs by rapid process is to be practiced.

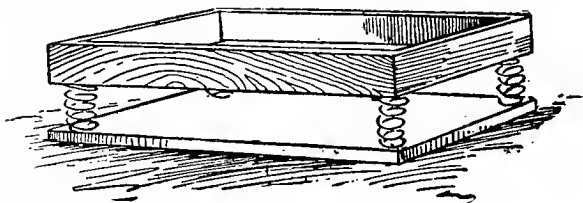

FIG 77: EGG CARRIER

Another plan for keeping choice eggs is shown in Figure 76. The eggs if kept long should be turned at least every other day, to keep them in good condition, and this is lots of work if done egg by egg. Make a box just shoal enough to hold one section of pasteboard fillers. Lay some soft papers beneath the fillers

and tack others (or a sheet of corrugated paper) to the under side of the lid. The whole box can then be gently turned over with one motion, and in a day or two turned back again. Shoal pasteboard boxes that would answer the purpose can often be obtained at dry goods stores.

Carrying and Shipping—Before shipping eggs for hatching, the first thing to decide upon is a method

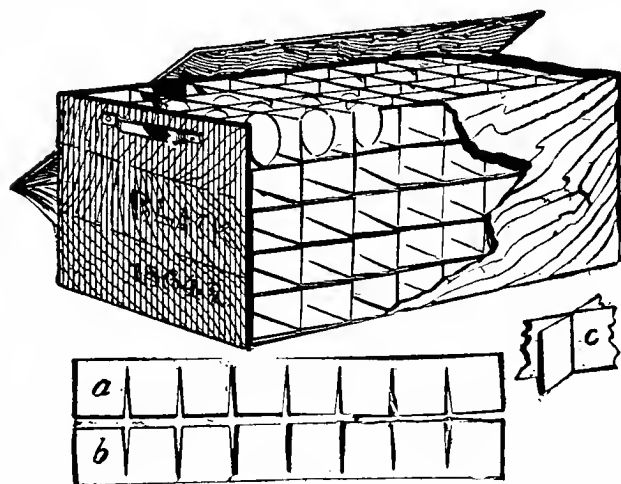

FIG 78: EGG SHIPPING CASE

of packing, so that they are likely to reach their destination in safety. There have been many forms of packages devised for transporting eggs, but the old-fashioned basket method is about the best of all. The small, flat-bottomed fruit basket can be purchased cheaply, and being light and conveniently handled is not so likely to be knocked around as a box would be; rough handling is apt to kill the germ or prove

detrimental to its keeping. The bottom of the basket should be lined with dry, soft hay, and each egg wrapped separately in paper and placed in the basket with the large end downward, so that they will not quite touch; fill in chaff or dry sawdust between each egg, then cover with another layer of hay; over all lay smoothly a stout piece of muslin the size of the top of the basket and sew on with strong twine, drawing firmly to prevent eggs moving about. Packed in this manner eggs may be sent long distances without being shaken sufficiently to injure their fertility.

When a basket of eggs is to be carried over a rough road, either the horse must be made to walk all the way, or broken eggs be carried back. Saw off the bottom of an empty grocery box and mount it above its cover by four small springs from the upholsterer's, or from a worn-out chair or couch. Set the basket of eggs in this (Figure 77) and it will ride safely over rough roads with the horse at a trot.

For shipping in large numbers, a cheap case is shown in Figure 78. Nail handles on a small shoe box. Cut pasteboard to fit together, as shown in the illustration. Fasten the slits well together by pressing the top piece crosswise into the bottom piece. Illustration shows the construction of the pasteboard slips and appearance when complete.

CHAPTER VIII

FROM INCUBATOR TO BROODER

Some style of mother is necessary to take care of the early hatched chicks, so the brooder and incubator go hand in hand. Both the pipe system, using hot water for heat, and a drum heated by a lamp from below, are used; each has its advocates and gives good results. Aside from the matter of cost there is little to choose between them. Up to within a few years, incubators and brooders were used only by fanciers and commercial poultry keepers, but of late they are being very generally adopted by farmers who raise from one hundred to five hundred chickens a year.

Warm the brooder pipes a day or two before the hatch is due. Take care not to bare the chickens in transferring them from incubator to brooder. Use large flat baskets for the purpose. Put a newspaper in the basket first, then a thick woolen shawl or old blanket under and over them. Take them rapidly from the basket, put them under the pipes and shut them in tightly for a time. Do not feed the chickens for twenty-four hours after hatching. Good food for the first week is cracker, ground in a bone mill quite coarse and mixed with as much milk as it will absorb, heated quite hot. It is not a bad plan to heat all the food for the first two weeks. After the first day or two teach them to drink milk. Grind broken crockery quite fine and put a little pile beside their food for grit. Use a smooth, clean board on which to spread their food and

clean the board after each meal. Get them out of doors the first week if possible during the midday sun. Give bits of onion or cabbage to keep them busy while out of doors. When they stop running or lose interest, take them in again.

After the first week give three feeds daily of shorts and corn meal scraped to a crumbly mass. In one feed put one-sixth beef scraps, in the other two feeds put onions or cabbage chopped fine and spread over the plates of dough. For other feeds during the day make a mound of sand, putting in with it meal to be scratched for and eaten as soon as light. Wheat, corn and barley, all cracked, are good for a feed at noon and the last feed at night. It is a good plan to store sods of grass for the first two hatches, as the earth is quite bare when they come out. Sow the yards and runs to rye for late hatches. The brooder must be cleaned out under the pipes every day, putting in clean sand. Clean out the entire pen when the brood is changed into another pen.

Very clear and practical directions are sent by L. Richards, who has used incubator and brooders with great success on his Massachusetts farm:

"The chicks are left in the incubator two days after they are hatched, then they are removed to the brooder, which is heated by a kerosene lamp in the rear, outside. The brooder is warmed by top heat, through tin pipes running on either side within, one in the middle and another across the front, all connected, of course, with two outlets in the rear portion. I have six brooders, each large enough for seventy-five chicks. The first week I keep the temperature between eighty degrees and ninety degrees. When two weeks old seventy-five degrees will answer, and at four or five weeks, seventy degrees. In the bottom of the brooder there is a platform slide resting on the lower one and covering it, on which the chicks rest.

After a few days I pull out the slides and remove the droppings, then re-cover with hayseed and replace them. They should afterward be cleaned every day. Have a coarse sand floor or ground for them to run on and pick to grind their food. The first week, if cold, I use outside of the brooder a small seventy-five degree oil stove or heater to warm the house for them, especially while they are out feeding.

“For the first two weeks they require a great deal of warmth, and I am convinced that the cause of death among so many small chicks is due to lack of warmth. I speak from experience. The same is true with chicks brooded by the hen. We have often found an apparently dead chicken, chilled outside, and brought it to life by warming it; in nine cases out of ten it will revive and thrive. When the small chicks are out feeding in the brooder house during the first week, watch them more or less and see that none get chilled. After the first week they will generally go in and under the brooder at their own option, and when the sun is out and shining through the glass they will crowd together in the sunshine, and during a very cold day they will get chilled even in the sun’s rays (unless the house is very warm) rather than go under the brooder where it is warmer. They like the sun. During the first week I have a fine wire shutter with which to close them in the brooder when they have been out long enough, and always at night for a week, and perhaps two, if cold. If not so restrained, they would get out too early in the morning, become chilled and die. After the first week or two I do not use it; let them go out and in at will. One other point should be mentioned and that is, I should advise one not to touch an incubator until he has raised chicks successfully by the hen. It is one thing to hatch chicks and quite another to raise them successfully.

“In regard to feed for chicks, which, of course, applies to chicks with the hen as well as those in the brooder, we give them the first day or two, when they are old enough to eat, cooked eggs chopped fine. Get the hen well filled with corn or some soft feed before feeding the egg to the chicks, otherwise the hungry hen will gobble it up. After this give them some baked Indian meal and flour bread mixed, chopped fine, and milk to drink.

“After the first week give them ground oats, cracked oats, cracked wheat and sifted cracked corn, boiled broken rice and white flour bread or graham bread. Milk if you have it, if not, water for the

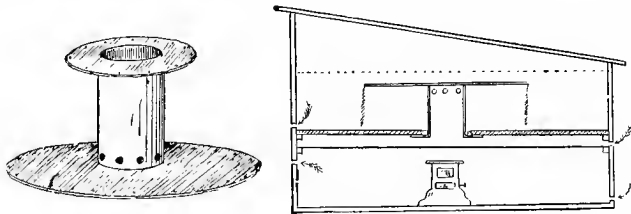

FIG 79: DIAGRAM OF BROODER WITH DRUM

brooder chicks. Give them meat scrap which contains ground bone, and also cut fresh bone. You can perhaps keep a small chick alive on cracked corn alone, the same as half the farmers do, but that is not what the man or woman wants who is raising chicks for profit and who desires to get three pound per pair chicks in ten, or, at the farthest, twelve weeks, and to do this you must work them for all they are worth. But do not feed on cracked corn alone. I assure you they get tired of it, the same as we would upon a diet of bread alone. Let them have free access to coarse sand or any kind of grit. Don't leave any holes open at night in your houses for rats to crawl through.”

An Improved Brooder—Figure 79 shows the lamp below a sheet of iron that securely shuts off the lamp chamber from the space above. (See also Figure 80.) Bed the sheet iron in white lead to make it air tight. Above the sheet iron is a floor of matched stuff, and in the center is a five-inch drum opening into the space between the floor and the sheet iron. Around the top of the drum are openings that let the hot air out into the brooder.

The top of the drum extends out for ten inches all around the drum and from the outer edge a flannel

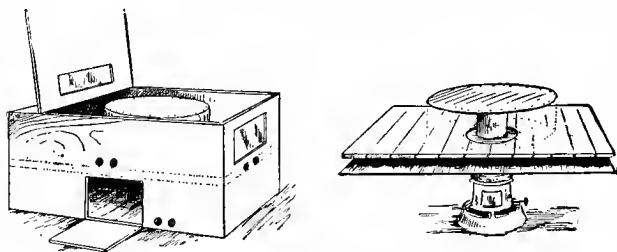

FIG 80: IMPROVED BROODER

curtain is hung, inclosing a circular space with the drum in the center. The curtain is "slashed" up every three inches. Within this curtain will be the warmest place in the brooder. It will always be warm in there. If it becomes too warm the chicks will go outside the curtain. The addition of this inclosed hover renders it practically impossible for the chickens to be chilled or overheated, and makes a very excellent brooder into one that cannot well be improved.

The dotted line (Figure 79) shows where the cover can be placed for an inside brooder. If it is to be used out of doors it must have a sloping cover.

Put two lights of glass either in the cover or on opposite sides.

Brooder for Fifty Chicks—The brooder used by Mr A. F. Stewart of Monmouth county, New Jersey, is shown in the diagram (Figure 81), being two and one-half by two and one-half by two feet, having canton flannel flaps around the heating drum, in which the young chicks can cuddle. The holes, *a a*, are for venti-

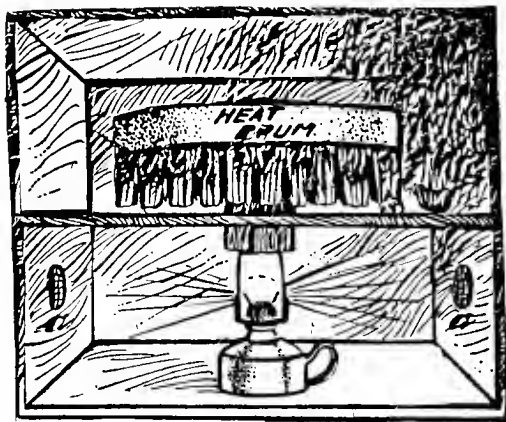

FIG 81: BROODER FOR FIFTY CHICKS

lation. About fifty chicks are confined in each pen or brooder. The feed of the young chicks for the first week or two is mainly stale wheat bread (wheat being preferred to rye), which can be bought cheap from the baker. This is broken up fine and wet with milk or water, milk if possible. After a few weeks the chicks are kept in small houses.

A Handy Little Brooder—Take a box three feet square and eighteen inches deep; remove top and bot-

tom. On this box (Figure 82) nail a square of zinc, tin or sheet iron, which will exactly cover it, as at *a a*. Nail on top of this zinc cover, around the outside edges, strips of board one inch square, cutting a space, *b b*, three-fourths of an inch wide, in center of each side. On these strips nail board cover or floor, *c c*. Bore in center of this cover a two-inch hole, *d*, inserting a two-inch zinc tube three inches long. For hover, *e*, take a board eighteen or twenty-four inches square, nail four legs four inches long to the four corners. Tack three-inch fringe or strip of felt or flannel around edges, slashing the same every three or four inches.

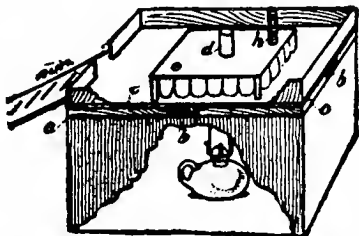

FIG 82: SMALL LAMP BROODER

A fence will be required around the top to keep chicks from falling off, also a cleated run for them to go up and down. Place a common lamp underneath this box to warm air in space, which is drawn in through spaces *b b* and passes up through tube and radiates out over chicks, keeping them constantly supplied with fresh air. Bore hole in hover and insert thermometer, *h*. Keep the temperature at one hundred the first few days, the second week lower to ninety, third week eighty or less is sufficient; do not keep them too warm.

Cheap Brooder—As a substitute for expensive brooders, the device illustrated in Figure 83 will make a good home for early hatched chicks. It is two and one-half feet square and about the same high in front, while behind it is enough shorter to give the shed roof a nice pitch. Nearly the entire front is glass, beneath which is a place for chicks to pass in and out. This can be closed when desired by a slide door as shown in the illustration.

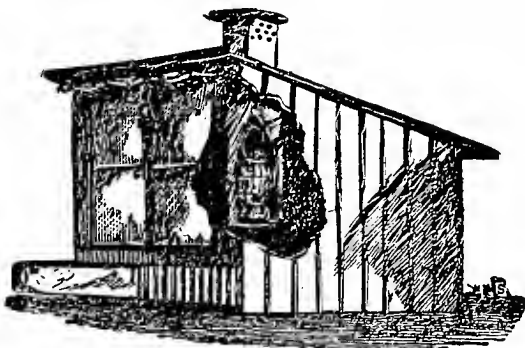

FIG 83: HOMEMADE BROODER

A curtain is let down over the sash during the night and rolled up out of the way in the daytime. It is warmed by a common barn lantern, which is held in position by a square box, which extends through the roof, and also serves as a ventilator. The cap of the ventilator is adjustable, permitting the lantern to be taken out and put in at pleasure. The ventilator is perforated at the base to permit the heat to radiate through the room, and also near the top to allow the gases from the burning oil to escape. The entire bottom is arranged to slide in and out as a drawer, so it

may be taken out and cleaned, which should be done every day. It costs but a dollar or so, according to material used.

The "Sure" Brooder—A small poultryman often wants a cheap and suitable brooder that he can make himself with little or no expense, as he cannot afford five to twenty-five dollars for a brooder. The one out-

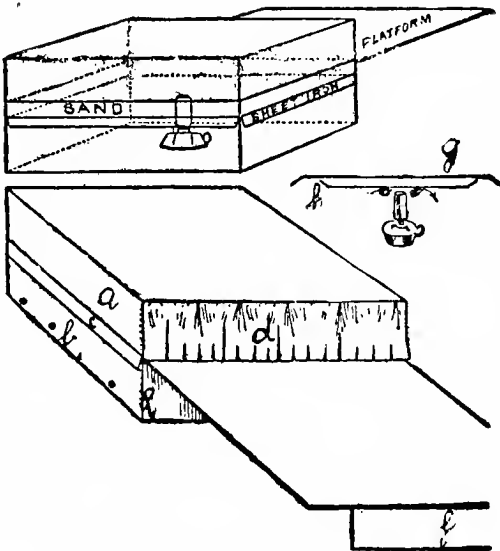

FIG 84: THE SURE BROODER

lined in Figure 84 can be made in an hour or two by any person at all expert with tools. A box three feet long by two and one-half feet broad and eighteen inches deep should be made of matched pine lumber. A tight floor of tin or sheet iron should be put in just below the letter *a* in the cut. This should support from one-half to one inch of sand, which will need re-

newing every week. The metal floor should project outside the box as shown by *c* and be nailed down firmly. This will prevent any odor from the lamp entering the chicken room, *a*. At *d* is the front of the brooder and it is made of a strip of heavy flannel or felt and hangs to the floor from the ceiling of the entrance to the little chamber. There should be small slits made in the flannel but not extending too far up, though every third or fourth cut may be longer than the others. This keeps out the cold and makes the room dark.

The platform *e* outside the brooder is two and one-half by three feet, which will be ample room until the chickens are a week old. It is hinged to the brooder and the board *f* is hinged to the platform so as to keep it level while the chickens are using it. When a larger room is required, *f* can be folded under *e*, and *e* becomes an incline to a larger pen. *b* is the lower part of the brooder in which a small hand lamp is placed to heat it and several inch auger holes should be bored in the sides of *b* to supply fresh air and enable the lamp to burn. *g* indicates the iron floor whose edges project and are nailed down. *h* is a smaller piece of metal attached to it underneath, and about half the size of the floor. It must not strike the floor at any point, but preserve an air space one-half inch between it and the floor, so as to take the first heat from the lamp and disperse it evenly over the floor that supports the sand on which the chickens stand. If this be omitted the lamp will make the sand floor hot in one spot and not warm enough in another. Too much heat is worse than cold for young chickens.

A window brooder is described as follows by F. J. Sheldon, Hartford county, Connecticut: "A box with a side or top wide enough to occupy a window, say three feet square and one and one-half feet deep, is

obtained. This is so arranged that a heater is made with a lamp and the chicks allowed a space on top. For the top of the box, or floor on which the chicks are kept, matched boards are best. A radiating space for hot air is made by tacking two-inch cleats inside of the box to the floor. To these should be fastened a sheet of galvanized iron which fits inside of the box quite snugly. This gives a heating chamber two inches high and three feet square. This chamber may be warmed by a common hand lamp, set on a shelf in the box directly under the center, about three inches being allowed between the lamp chimney and the iron. To allow a good circulation in the radiating chamber bore half-inch holes into it on all sides of the box; also bore one, with a one and one-half-inch auger, through the center of the floor. Make a door in the side of the box most convenient to put the lamp into. A chimney to afford an outlet for the hot air is necessary. This may be made of hard wood with a hole in it the same size as the hole in the floor and cut down to about two inches in length and as near round on the outside as your time may permit. This may be glued down with bits of tin in position over the hole.

“The cover over the chicks is generally made about six inches smaller all around than the floor, and is so framed that it will not warp if heated. Bore four holes, one in each corner, and get an old broom handle to fit into these holes. Cut the handles into four-inch lengths. These make the legs and may be raised or lowered according to the size of the chickens. When first out, the cover must be only one-half inch above the top of the chimney and stands with a piece of woolen cloth tacked on the sides. A wire fence about one and one-fourth feet high may be tacked around the top of the box. This will keep the birds in place and also protect them from rats, etc, if they are around.

Some may hesitate about putting fifty chicks in a brooder, but here are the first steps. The brooder is built and the lamp lit. Now fit a piece of newspaper carefully on the floor or top of brooder, and around the chimney. This done, cover the paper with dry sand that is formed of grit or fine stones about one-fourth inch thick. Place a thermometer on the sand near the chimney and place the cover on."

Large Hot Water Brooder—Figure 85 shows a box six inches deep, three feet wide and fifty feet long. Two-inch iron pipes are arranged as shown in the illus-

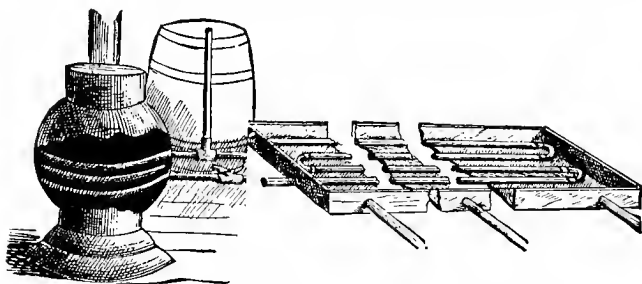

FIG 85: HEATER, WATER BARREL AND PIPING

tration, the top of the box being removed to show the interior. The hot water may be supplied by an ordinary stove "water back," or by a coil of pipe in a stove. This is heated by a piece of pipe one inch in diameter, coiled in a stove, holes being cut in the stove for the purpose of admitting pipes. The hot water flows out and the cold water flows in. The floor of the box is made close, with tongued and grooved boards. The cold air enters through tubes reaching to the outside of the building. It is heated by coming in contact with the pipes, and enters into the tubes on the top of the floor, which are two and a half inches high.

Another Homemade Brooder—This brooder has a heater four feet long, one foot wide and six inches high. The top is covered with zinc nailed on tightly. There is no bottom except over one-third of the back end. The front has a sliding door with a window to look at the lamp. The inside of the sides is lined with tin, and the chimney hole is one inch from the bottom in the middle of the back, and is for a tin pipe one and three-eighths inches in diameter. The heater is shown in

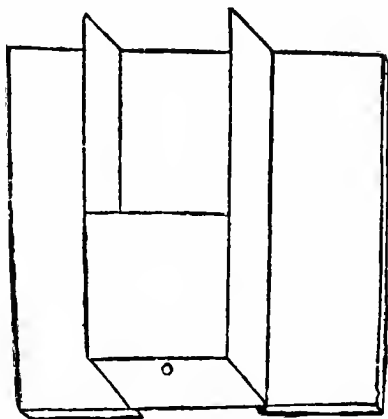

FIG 86: DIAGRAM OF BROODER

Figure 86, giving a bottom view without the sliding door in front, and with boards one foot wide nailed on the top through the zinc.

Figure 87 gives a top view of the same after strips two inches wide have been fitted in at each end of the zinc to make a level surface all around the edge. Next nail strips, also two inches wide, all around the edge, except at the corner opening one and one-half

inches wide to admit fresh air; *b* is a strip ten inches long nailed on to conduct the fresh air to the zinc.

Now if this is covered with matched boards there will be a chamber two inches deep over the zinc and one inch elsewhere. Bore a hole in the center for a pipe three inches long and one and one-eighth inches in diameter. Around this pipe and on this floor the chicks keep warm and sleep under a cover, also made of matched boards, two inches smaller every way than

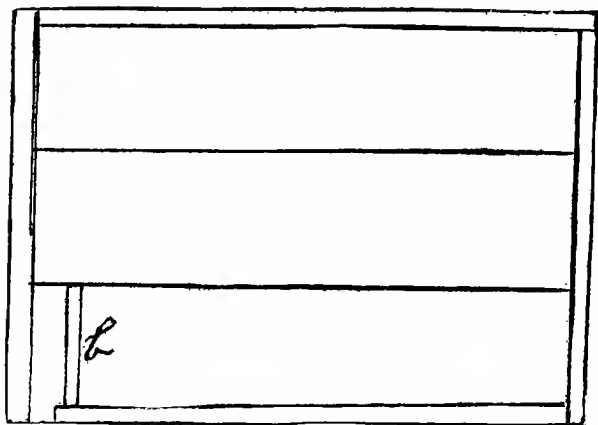

FIG 87: SECTION VIEW OF BROODER

the floor. This cover has four round legs which go through holes and raise and lower by means of nails, used as pegs in stay pieces which hold the matched boards together. Around the edge of the cover tack carpet or blanket cut in slits every four inches so that the chicks may run in and out. The blanket should be four inches wide and the cover kept two and one-half inches from the floor when the chicks are first put in the brooder. When the brooder is in operation, warm

air is thus constantly flowing over their backs and ventilation is perfect. A tin chimney twenty inches long will carry off the fumes from the lamp.

Put the brooder under a warm, sunny shed, and set it on the ground, or bank up nearly level with the floor and make a pit for the lamp with an open cover. Be careful not to cover the hole where the fresh air enters the brooder. Place the lamp as far under as you can reach, using straight tin chimneys with isinglass windows in them. The same kind of lamps and oil should be used as for an incubator. The lamp need not be turned up high, nor must the chimney be nearer the zinc than two inches; eighty degrees is warm

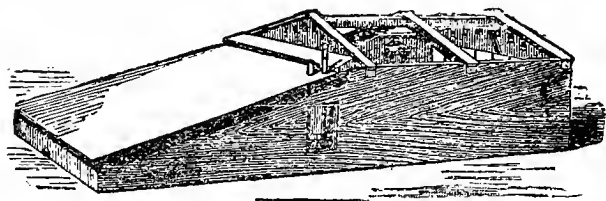

FIG 88: BROODER FOR MILD CLIMATE

enough for them. No thermometer need be used in the brooder. Keep dry sand on the floor and clean off the droppings every morning. Let their run be small at first and do not let them out when young in damp or stormy weather.

Warm Weather Brooder—A brooder which will answer very well for late-hatched chicks or for locations where the climate is mild, is that devised by a successful California poultryman, who writes:

“I have constructed a brooder (Figure 88), six feet across the front, four feet in depth and six feet in height. The walls are of common rough lumber and battened; the roof is made of shakes and has a sharp pitch each

way, the gables closed with grain sacks for better ventilation. There are set in the front three sash doors twenty-four by thirty inches each, and made to swing outward for convenience in getting to the chicks.

"About one-half of the interior is floored and sanded. Six inches below the sash doors a solid door is hung to admit of lighting the lamp, etc. There are three compartments, separated one from the other by means of wire cloth or netting, about eighteen inches high from front to rear, and situated in front of the mother, with height sufficient to permit the ready egress and ingress of the chicks. Such a house as described

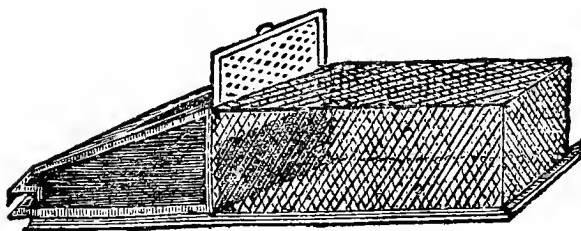

FIG 89: OUTDOOR BROODER AND RUN

can be built at a cost not exceeding six dollars and fifty cents. The material employed consists of one hundred and fifty feet of lumber, four pairs of strap hinges, three sashes, fifty shakes, and two pounds of nails. As soon as the chicks are dry I place them in this brooder, in the sun if it is shining brightly, if not, then they are placed with the mother, taking care to provide a shady retreat which the chicks will seek if it should become too warm."

A very convenient size is one that will accommodate fifty chickens until three months old, two feet wide and four feet long; the sides are twelve

inches high under the glass, sloping to three inches at the back; the cover of the back or inclined part should be movable, and lined with sheepskin or with pieces of flannel cut into strips three inches wide, and tacked to the under surface of the lid so as to hang down lengthwise with the lid; from the highest part of the lid should hang a curtain made of flannel all across the box, and to within half an inch of the floor; this keeps the cold air out of their roosting place. The front half of the brooder is covered with four panes of glass; this admits the sun. The black dots in each peak are intended to represent one-inch holes for ventilation.

An ordinary stone gallon jug (placed beneath the lid) filled with hot water four or five times a day, will furnish all the heat needed.

Figure 89 represents another artificial mother for outdoor use in mild weather, and a wire run for the chicks. It is very simple in its construction; it is made on the same principle as the mother previously described, excepting the bottom is separate from the body of the coop, which can be removed to clean. It is very important that it should be kept free from the droppings of the chicks, for if they are allowed to accumulate they will breed lice. If the weather should be too cold for the comfort of the chicks then a jug of hot water should be placed within the box; this will not be necessary unless very cold, as a large number of chicks huddled together will generate a considerable amount of heat.

CHAPTER IX

TRAPS FOR POULTRY PESTS

Rats are no doubt the prime nuisance in most poultry raising sections. They steal grain and eggs, disturb sitting hens and kill young chickens by wholesale. By reason of their numbers and boldness they usually give more trouble than the wild pests of the swamp and forest. To fight them with cats is to invite a remedy which may prove nearly as bad as the disease. A trained rat dog is the best policeman for pests of this kind, and he may be taught to drive off strange cats. He will in fact fight or at least give warning of any dangerous intruders except hawks. Rats often nest and burrow directly under chicken houses and coops. When the owner suspects anything of the kind let him call his dog and pry up the coop or tip it over, and Snip will do the rest.

A simple, but where rats are numerous, very effective trap is made by taking a large shallow box with the lid shut down and but one small hole in the side near the bottom. For this hole have a sliding lid which will stay open and can be shut suddenly. Place the box on the barn or stable floor, put some grain or other bait in it, and leave it for several days. Put everything else that is eatable as much out of the reach of rats as practicable. Renew the grain in the box if it is taken. Then when the rats have got used to the box and resort to it regularly for their feed, come up to it softly, shut down the sliding lid, take the box off into some open space, where the rats will have fair play, call the dogs and let the rats get away—if they can. Then

take back the box and proceed as before, using another bait or putting the box in another place as soon as you fail of success.

An old-style box trap with a modern improvement or two is a sure and secure rat catcher. Get a common box, remove the top and one side and put them together as at *e* (Figure 90), and fasten with a hinge as at *a*. Fasten a spool, *c*, in the end of a board, *b*, and nail it to the back of the box. Then bore a one-inch hole about six inches from bottom of box, and at *h* cut

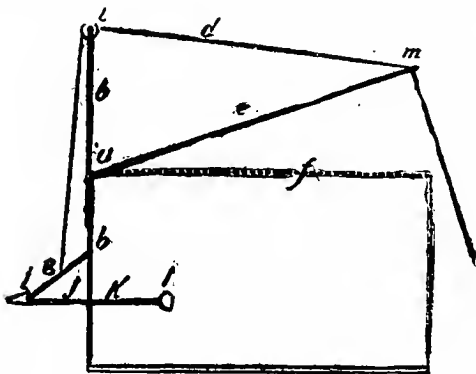

FIG 90: IMPROVED RAT TRAP

a notch in the outside of the end board. Sharpen stick, *g*, at each end. The stick, *l i*, should be twelve inches long, notched at *k*, so as to balance in the hole. The end *l* should be pointed, and the end *i* notched and pointed. Fasten a string at *m*, bring over the spool at *e* and down to *g*, and tie at middle of stick *g*. Have the string short enough so that when set the door will be wide open, about eight inches. Place bait of any kind on *l*. When a rabbit or other pest sniffles it he will dislodge stick, *g*, by moving it at *i*, and the

cover will drop. Sometimes a weight can be used on the cover to advantage.

Cat Trap—A slight modification of the common box trap, as in Figure 91, makes it the best kind of a cat trap. A robber cat in a trap is a desperate tartar to handle and if drowned while inside, no other cat will soon enter. To organize a quiet funeral, have a slide, *a*, just large enough for the prisoner to poke her head through. Then push down the slide and finish her catship with a mallet stroke.

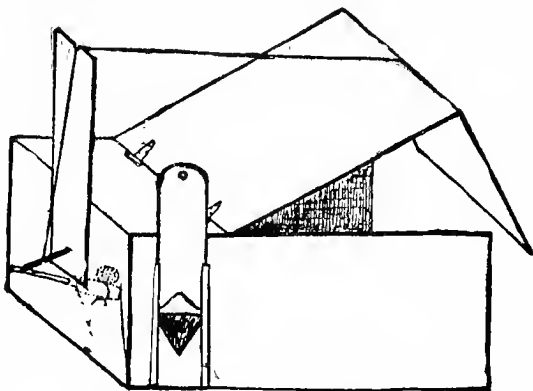

FIG 91: CAT TRAP

Trapping and Killing Skunks—These are a nuisance about a farmhouse or barnyard, and where they get into the habit of raiding the chicken yards, must be gotten rid of at any cost. Often they are allowed to make and occupy nests in the vicinity of the barn and house and remain undisturbed on account of the disagreeable consequences an interference would bring about. The average man would rather beard the lion in his den than risk an encounter with a skunk. A pair of these animals made their abode beneath the

floor of a neighbor's summer kitchen, and as the floor was not tight, got into the habit of coming into the room above. The farmer captured them by use of the trap shown in the illustration (Figure 92).

A small-sized dry goods box, not so large but it can be easily carried, is fixed with a trap door, which is attached to a lever connected with a trigger in such a manner that when sprung, the door will drop. The

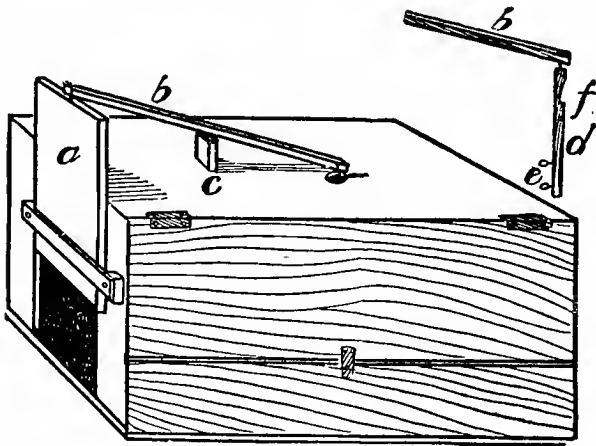

FIG 92: SKUNK TRAP

box can be carried with its captive to a safe distance, where the odor will not be disturbing, and the prisoner shot or dispatched by a trusty dog.

The illustration shows the trap ready set. The trap door, *a*, is attached to a lever, *b*, which rests on a fulcrum at *c*. The other end of the lever is fastened to the trigger, *d*. The trigger passes through the top of the box, the notch, *f*, catching on the edge of the hole in the box, which should be large enough to give

plenty of play. The trigger stick should be long enough to reach within an inch of the bottom of the box, where the bait, *c*, is fastened. A hinged door in the side of the box makes the last act easy—that of dispatching the entrapped animal. If the box is carried carefully, there is no danger of the skunk opening hostilities until immediate danger threatens him.

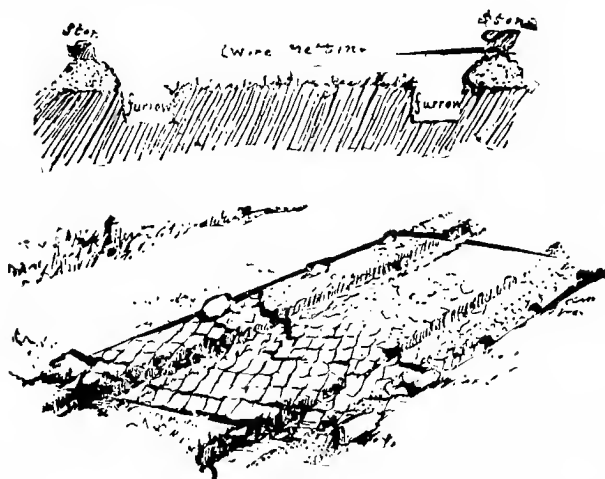

FIG 93: PROTECTION FROM HAWKS

A safe and quick way with skunks is narrated by A. H. Binney of Massachusetts, as follows: "I take an ordinary box trap and bait it with a chicken's head or piece of liver by tying it onto the spindle, but before doing that I drag the bait around on the ground, and every time drag it into the trap so as to give them a scent to follow. Then I dig a hole in the ground, two and one-half feet deep, about eighteen inches across, and now I am ready for the skunk. I am sure to have him the first morning. I then take trap and

drag it to the hole I have dug, lift the trap up and slide the skunk into the hole. I have my gun handy but do not have to hurry, as he is a clumsy animal and would have hard work to get out of the hole, if

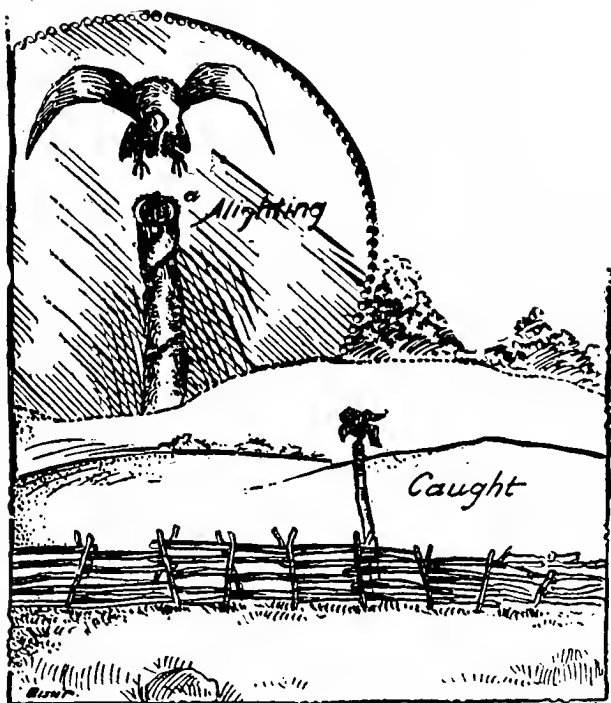

FIG 94: TRAPPING A HAWK

he ever could. I have a shovel handy and immediately after shooting him, cover him with dirt. There is not the least danger of getting any scent on the clothes from getting him out of the trap in this way."

Protection from Hawks—Where hawks abound, young chicks must be closely guarded. If shut up closely in pens, growth will be greatly retarded. A good plan under such circumstances is shown in the accompanying cut. Plow two furrows parallel to each other and just far enough apart so that the distance from the outside of each shall be just six feet. Make the furrows one hundred and fifty feet long. Stretch a roll of six-foot wire netting along the furrows, fastening the edges down with loose stones. This

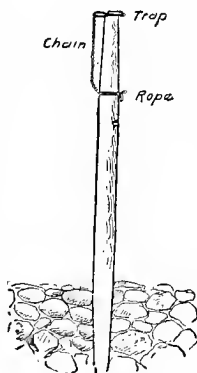

FIG 95: SETTING A HAWK TRAP

gives a long run on both grass ground and plowed land for the chicks, and hawks cannot molest them. The coop can be set at one end, the other end being stopped with sod. The plan is shown in Figure 93.

In Little Compton, Rhode Island, which town produces annually from thirty thousand to forty thousand chicks, a bounty of twenty-five cents per head is paid for hen and chicken hawks. The same sum is paid for crows per head, they being nearly as inimical

if not equally so to the career of the chicken. This bounty is usually voted at the town meeting. At times it has been left for the town council to fix the sum, never being more than twenty-five cents per head, and some years a lesser sum.

Various devices to prevent the near approach of the above-mentioned birds are noticed about here, among which may be mentioned the small windmill so arranged that at each revolution a rapid and noisy clapping is produced. Another arrangement quite generally in vogue is to erect long poles about the chicken yard, a stout cord extending from pole to pole at top, to which cord are appended multicolored strips of cloth. This method, while it prominently advertises the location of the tender morsel, is supposed to intimidate its wary foe.

For catching hawks, the only effective device seems to be a common steel jaw trap set where the bird is most likely to alight. A good location is on the top of a common fence rail or a long pole, set firmly in the ground. It is best located on some moderately high point in the middle of a field near the chicken lot, as indicated in Figure 94. In Figure 95 are shown details of arranging the trap.

CHAPTER X

THIRTY USEFUL DEVICES

A convenient inside arrangement which allows all common work to be done from the passageway is indicated by the plan, Figure 96. Drop doors enable the attendant to fill the dishes and troughs, get the eggs, clear off the droppings board, and even to take fowls from the roosts without going into the pens. The diagram shows also a cloth cover to be drawn in front of the roosts on cold nights.

A ventilator that can be opened and closed at the will of the attendant will give good results if given proper attention, and without attention no ventilator will give the best results. All ventilators that are in continuous operation either give too much ventilation during cold and windy weather or not enough during still, warm days. As a rule, they give too much ventilation at night and too little during the warm parts of the day. The one illustrated in Figure 97 can be readily controlled and is used by G. C. Watson of the Pennsylvania experiment station.

Ventilators are not needed in severe cold weather, but during the first warm days of early spring, and whenever the temperature rises above freezing during the winter months, some ventilation should be provided. Houses with single walls will become quite frosty on the inside during severe weather, which will cause considerable dampness whenever the temperature rises sufficiently to thaw out all the frost of the side walls and roof. At this time a ventilator is most needed. A ventilator in the highest part of the roof

that can be closed tightly by means of cords or chains answers the purpose admirably and may be constructed with little expense. The ease and convenience of operation are important points, and should not be

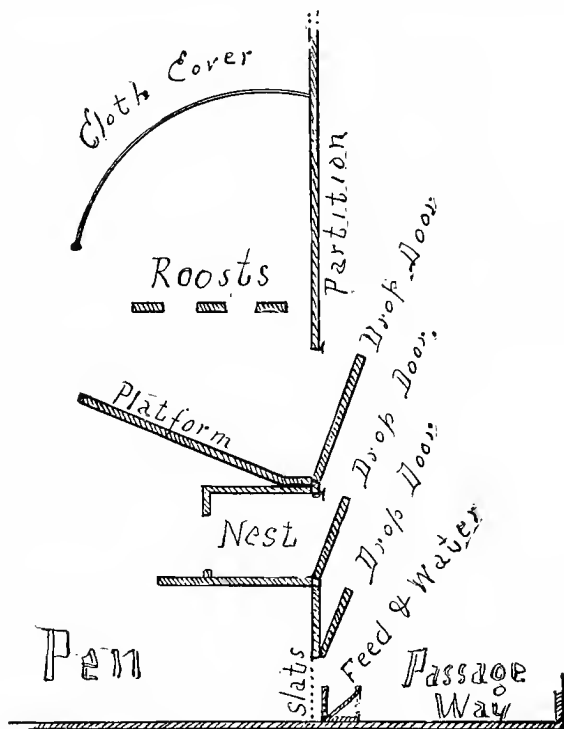

FIG 96: INTERIOR CONVENIENCES

neglected when the building is being constructed. It is a simple matter for the attendant to open or close a ventilator as he passes through the house if the appliances for operating it are within easy reach.

Pulleys—Figure 98 shows a screw pulley, sold at hardware stores very cheap, and useful about the poultry house for operating ventilators, small doors and windows and feed boxes.

Figure 99 shows a simple way of making pulleys for raising henhouse windows by a cord operated from a hallway, or for any other position about farm build-

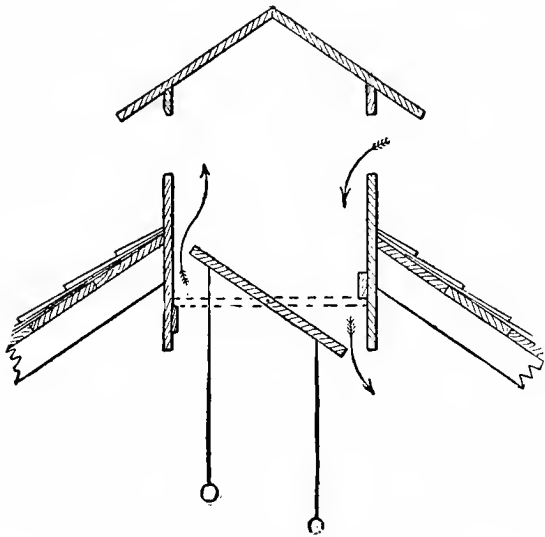

FIG 97: GOOD VENTILATION

ings where light pulleys are desired. An empty spool, from which the thread has been used, has a round plug driven through it, the ends projecting, as shown. Two screw eyes of the proper size slip over the ends, after being screwed into the wall or ceiling. Use small spools and long screw eyes.

Clean Houses—Useful implements for cleaning and renovating a poultry house appear in Figure 100.

The force pump should have nozzle and valves coarse enough for use in whitewashing. With rather thin whitewash and a pump, the interior of a lousy hen-house can be coated in a few minutes. Outside whitewashing can also be done in this way. A force pump is good for applying kerosene emulsion where lice,



FIG 98: SCREW PULLEY

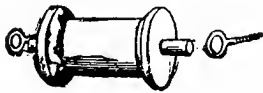

FIG 99: HOMEMADE PULLEY

nest bugs or fleas are very plenty. The emulsion is made by adding kerosene oil to soapsuds and shaking them together in a covered pail until they mix, or by pumping them a few times from one pail to another. For applying disinfecting solutions of sulphuric acid

and water, solutions of corrosive sublimate, etc, a good pump is also convenient. Brass pumps of this kind cost about five dollars each.

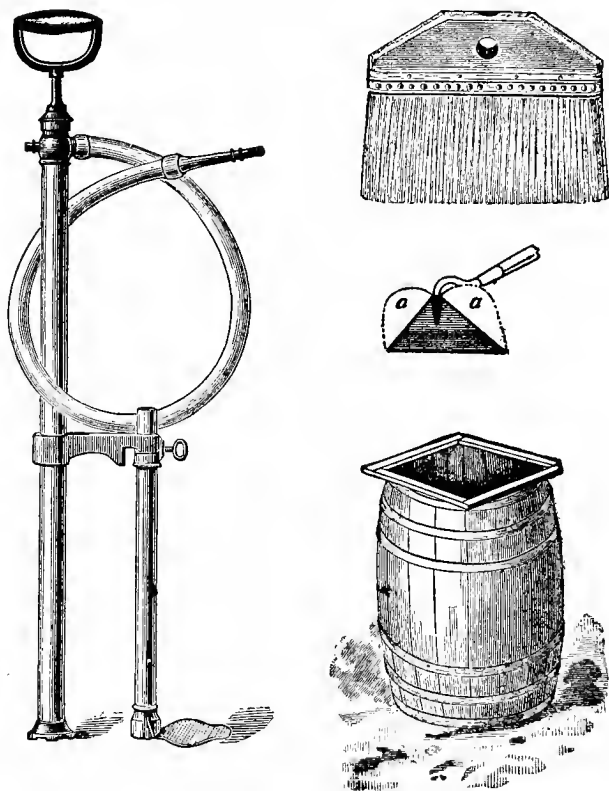

FIG 100: CONVENIENCES FOR INSIDE WORK

For careful application of whitewash, one of the brushes shown in Figure 100 is useful. It is of bristles outside and fiber within strong and durable. The

large size costs about seventy-five cents. It may be fitted with a homemade handle.

To clean poultry roosts, feed troughs, and for scraping trees, Figure 100 shows a handy implement. It is an old hoe with the edges, *a a*, cut as illustrated so as to make it of triangular shape. The blade should be sharpened occasionally to scrape easily. The points often come handy in loosening hard or sticky matter in the corners.

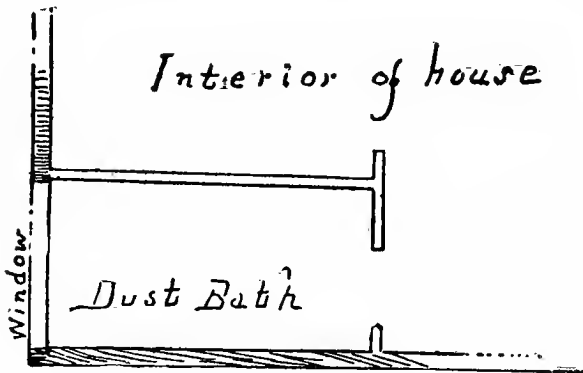

FIG 101: DUST BATH

In the lower corner of the illustration, Figure 100, is shown a barrel with roosts around the top, so that the greater part of the manure from the roosting fowls is caught in the barrel, where it gives no further trouble, except to add a little dry earth or coal ashes once in a while.

Dust Baths—Figure 101 shows a space boxed off as a dust bath in the sunniest spot in the house, just below a window. If the box is raised a foot or two from the floor, the floor space beneath will be available for the fowls or for nests. For a flock of twenty, a

bath box three by six feet is a good size. An old sink makes a fairly good receptacle. Fill with dust, ashes and a little sulphur, all perfectly dry, and the fowls will use all winter. The space above the dust bin can also be used as a scratching place or as a shelf for nests, by putting in a kind of platform. Thus we have three stories in use; earth floor, dust bath and

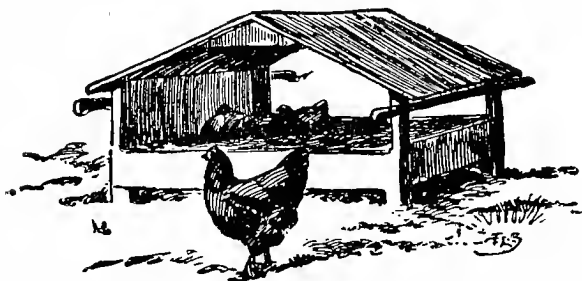

FIG 102: OUTSIDE DUST BATH

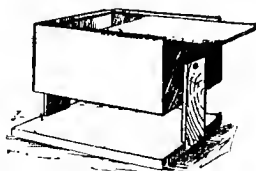

FIG 103: FOR DUSTING FOWLS

platform floor. An outdoor dust bath is shown in Figure 102.

To dust chickens by wholesale with any kind of insect powder, fix a small box with sliding cover, to revolve, as indicated in Figure 103. Put three or more chicks in the box, with a spoonful of powder, close the slide and revolve slowly and carefully three

or four times. There will be a great fluttering inside and the dust will fill the chicks' feathers very completely. Then replace these chicks with three others, and more of the insect powder.

Heating a House—For a brooder house, hot water systems have the advantages of economy of fuel,

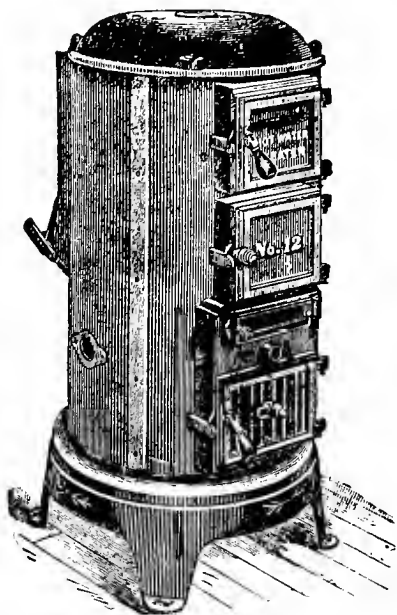

FIG 104: HEATER FOR POULTRY HOUSE

with safety and ease of control. The piping is larger and costs somewhat more than for steam. The style shown in Figure 104 is quoted by an agricultural supply company at eighteen dollars to eighty-four dollars, according to size, and including all piping,

valves and tank. Anybody can set up a heater, and it is almost as easy to operate as a coal stove. Steam heat has some advantages for a large plant carefully planned with all the buildings supplied from a large boiler. But for the great majority of establishments a hot water system is to be preferred.

Houses for layers are seldom heated, owing to the impression that the stock would become feeble and cold or roup increase. But the tests at the Utah

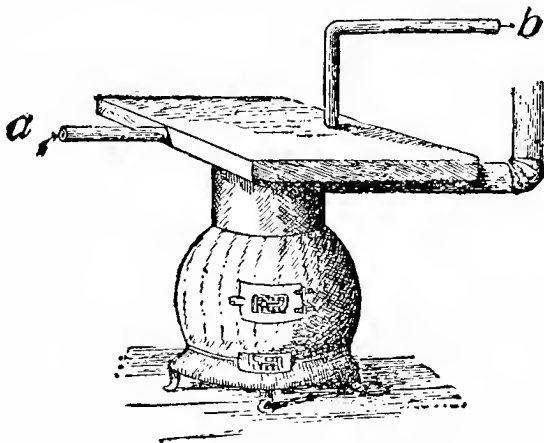

FIG 105: HEATER AND VENTILATOR

experiment farm have attracted much attention as tending to show that a moderate amount of heat may be profitable for mature fowls, decidedly increasing the egg yield. On estates where a greenhouse or brooder plant is located, there would be little trouble or expense in turning on a little heat in the henhouse during very cold days and nights.

Among the many plans in use for warming the poultry house, the heater illustrated in Figure 105

supplies heat and ventilation or a supply of fresh, warm air. Any kind of a flat top stove or even a kerosene stove will give sufficient heat. The size of the stove should depend on the size of the house, but forty degrees is a sufficient heat. The illustration shows a closed box a yard square and an inch deep, made of ordinary sheet iron. The box or heater is placed on a small stove, or if legs are attached to each corner of

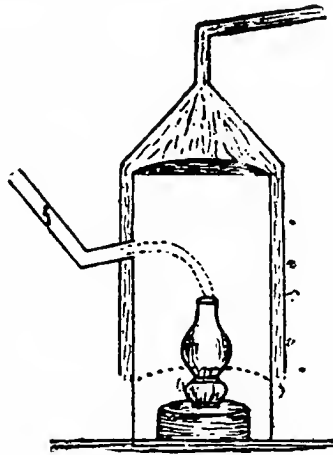

FIG 106: LAMP HEATER

the heater, a lamp may be placed under it. The cold air comes in at *a*, passes through the box, becoming heated, and emerges at the pipe *b*. The cold air pipe is one-half inch in diameter and the warm air pipe one inch. The pipe *a* should be long enough to extend through the walls to the outside, so as to bring in the pure air. No ventilators on the top of the building will be required, and the air will keep the house dry. Always bring the air in and discharge it near the roof,

as the birds will not then crowd or become lame as they will when the warmth is below them.

Oil is too costly for poultry house heating except on a small scale, or in a limited way. For small flocks of choice hens, the device shown in Figure 106 may help to secure more eggs and to save combs in zero weather. It is a cheap heater, by which the foul air is carried off through a smoke pipe, and the air

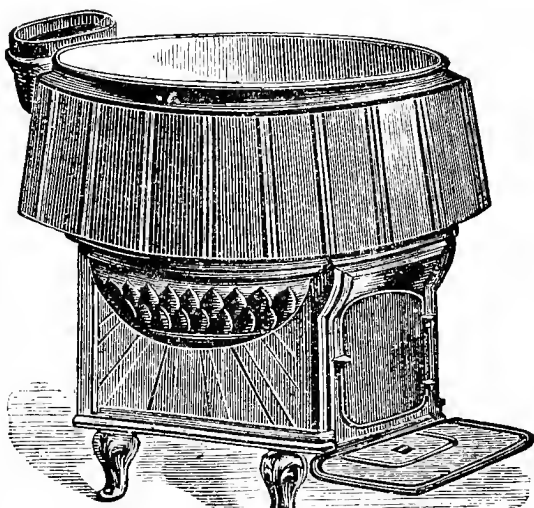

FIG 107: FEED COOKER

warmed around the heater, thus avoiding the odor from the burning oil. The heater was made at the tin shop and is of good sheet iron, but it would do to use old milk or oil cans if one has large ones to spare. The gas from the lamp passes out of the building through the pipe funnel, *f*. The outside shell is two inches larger in diameter than the inside one, allowing

the air to pass up, become heated and go out to warm the house. A few holes should be punched around the base of the heater as shown, to admit air for the lamp. A common incubator or brooder lamp is used.

Feed Cooker—Where much soft feed is used, a cooker and warmer is needed. A useful style appears in Figure 107. It can be had to burn coal or wood, and costs four dollars to twelve dollars, according to size. In this connection the feeder is advised to cook all refuse meat fed to fowls in order to kill any possible germs of disease. They sometimes get consumption

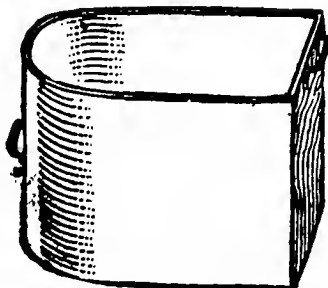

FIG 108: SMALL COOKER FOR STOVE

and bowel troubles by eating sickly raw meat. Cooked meat is also a better keeper than when raw.

Figure 108 represents a cheap feed cooker, which can be made by cutting an ordinary wash boiler in two in the middle, having an end soldered on and a handle attached near the top. Into this during the day throw all potato parings, vegetable parings and other matter from the kitchen. Add water and place on the stove after the evening meal is cooked and let it remain until the space is needed in the morning for cooking breakfast, when it is removed. After breakfast is cooked, it is again replaced and by the time the owner

is ready to feed the chickens, the whole mess is thoroughly cooked and is excellent for making a warm feed for laying hens. The cost is very slight and old boilers otherwise useless can be utilized.

Worm Box—An abundant supply of worms suitable for winter chicks can be bred without the bad odor caused when meat is used as a breeding sub-

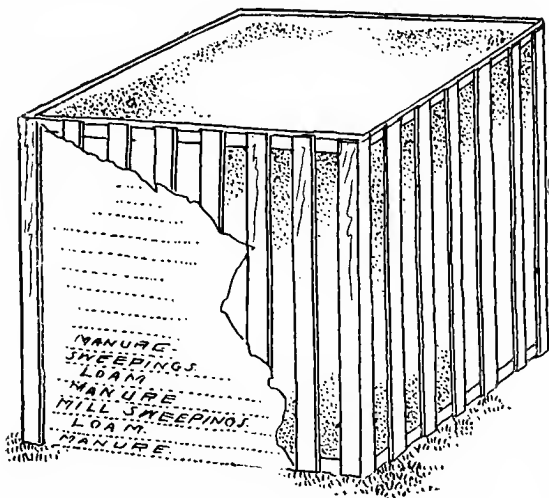

FIG 109: WORM BOX

stance, by use of the frame box and filling indicated in Figure 109. The larger it is made, the better it will work. Fill with six-inch layers, using horse manure, loam or garden soil, and the cheap mixture of meal and dirt which can be had of large grain dealers. Keep indoors in a warm, light cellar or similar location, and the worms will be bred whenever there are flies to lay the eggs. If earthworms are stored in this

box, they will live and thrive if watered occasionally, and can be used at convenience.

To Prevent Hens Scratching—Take any stout piece of cloth about six inches long and two and one-half inches wide, lap together around the hen's foot, as in Figure 110. This is sure to prevent scratching and will last all summer. A piece of bagging will answer. Do not fasten so tightly as to stop circulation. Use soft cord.

In this connection, C. W. Shorter, Chenango county, New York, writes: "My hens bothered us some by digging in the garden and flower beds until I fixed what I call a poke (Figure 110), and fastened it on their leg. It is made of a piece of white ash

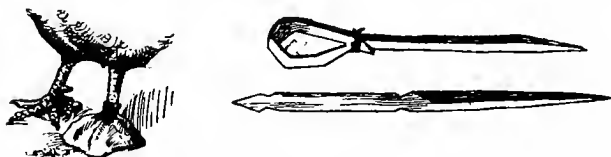

FIG 110: TO PREVENT SCRATCHING

about six or seven inches long, flattened at one end and sharpened on the other. The flat end is bent around the hen's leg and tied with some strong thread. It drags behind when they walk, but when they go to scratch, they sit down, and seem quite surprised. Heavy wire would furnish good ones, and are more easily made."

Shipping Crates for Fowls—The top strip on each side of crate (Figure 111 at the left of the illustration) should extend four inches at each end of crate, as no handles can be placed on the coop that will be quite so convenient. The bottom should be boarded, never stripped, as in the latter case the birds get their feet bruised and broken.

Most transportation companies will return shipping crates free of charge, and in this case it pays to have good, neat coops. Such coops should be made strong, but of light, thin material, lath for instance. Trapdoor in top, side strips up and down, not lengthwise. Wheat or other food in the bottom of a coop often hurts the sale of fowls if they are sold by weight. When coops are stripped up and down, then, when desirable, feed may be given the fowls in vessels placed outside the coop. Neat appearance helps to sell all products and is one of the essential factors in securing top-notch price.

More fowls are shipped by express in cloth coops in winter than at any other season. A cloth-covered

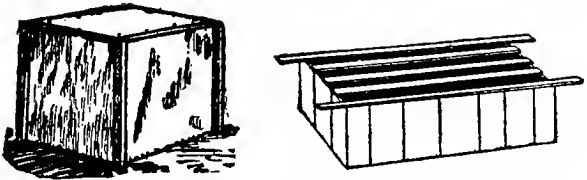

FIG III: SHIPPING CRATES

coop is scant protection to prevent frozen comb. Take the same coop, put cover pieces on outside the cloth cover, as suggested in the sketch at the right of Figure III, and over these stretch another covering of cloth, and we have an air space between that will protect the fowls from cold. Have a tight cover except the slit for the hand of the expressman, which will also afford ventilation. With plenty of chaff in the bottom to keep the feet warm, birds ought to be very comfortable in such quarters, even in very cold weather. For mild weather the crate shown at the right of Figure III is one of the best and is quickly made from a box or second-hand egg case.

For catching poultry, use a hook as in Figure 112. It is made from a rod three or four feet long with a bent wire at the end. The end of the rod should be ferruled or bound with fine wire. The fowl is looped by one foot and carefully drawn in the desired direction.

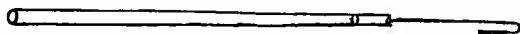

FIG 112: HOOK FOR CATCHING POULTRY

Exerciser for Ducks—Duck breeders often have trouble in securing fertile eggs because of lack of exercise for the breeding birds. The method described by H. H. Stoddard in the *New Egg Farm*, published

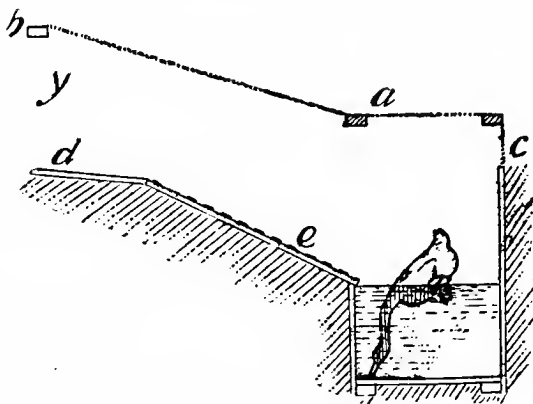

FIG 113: DUCK AT EXERCISE

by Orange Judd company, overcomes this obstacle by providing a series of swimming tanks under feed cylinders or feeding boards, as shown in Figure 113.

A ditch is cut and boarded at sides and bottom, *c* showing the original surface of the ground, *e* an

inclined plane of boards with lath tacked on to secure foothold, and *d* a platform with a slight slant for drainage. The feed cylinder is at *a*, and a yard or runway begins at *y*. If the location allows a shallow ditch, the approach, *e*, may be omitted. This tank may be two, three or four feet wide or even more, according to the supply of running water. For an extensive duck ranch the idea is to have the tank three hundred or four hundred feet long, divided by wire into sections for the accommodation of scores of fowls.

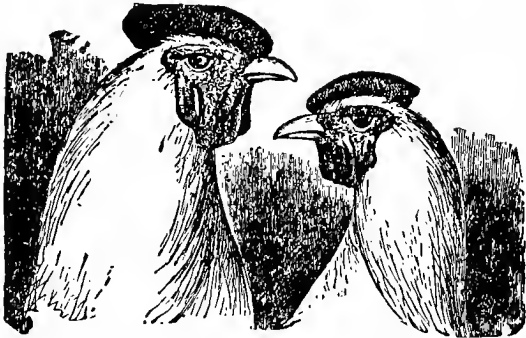

FIG 114: LEGHORNS WITH COMBS CUT

The ditch and the tank which lines it may be so constructed that the depth will be just sufficient to allow the ducks to assume the position shown in the illustration, being enabled with a little effort to reach the food which has been dropped from above into the tanks. While searching for the food, their necks and legs will be actively employed. The author describes a system of cylinders or feed boards which extend the whole length of the tank, and by striking with a hammer at one end food is dropped from the board or

cylinder into each tank. This operation, repeated several times a day by the attendant, provides ample exercise.

Cutting Wings—If a person cares to, it is possible to cut the wings when the chickens are so young that their flying ability will be effectually impaired for all time. This will often prove to be a great advantage, especially with fowls of the Leghorn, Hamburg and Minorca breeds. This is not difficult nor painful to the chick, if done at the right time, and consists simply in cutting the wing at the last joint; the portion cut

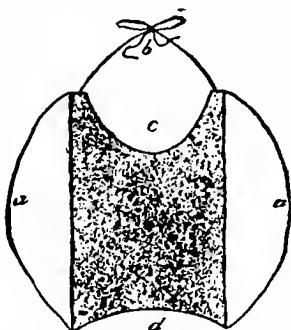

FIG 115: SHIELD FOR INJURED FOWLS

off is but a trifle when the chick is young, but when it is developed it makes quite a material difference in its wing power, so much so that it is a comparatively small matter to confine them, and so far as practicality is concerned, it does not impair their useful qualities in the least. If the work is done when the chicken is about ten or twelve days old, it is scarcely painful, and the chick soon recovers its usual activity.

Trimming Combs—The drawbacks of large combs and wattles are freezing in our northern states and the discomforts and strain resulting from carrying

so much weight on the head. It appears as though the circulation of blood in the head is somewhat affected by these excessive appendages, for it has been observed that a Leghorn having frequent spells of giddiness and staggering can sometimes be quickly and permanently cured by trimming the comb, and we would always recommend the trimming of both comb and wattles for both sexes when two-thirds grown, as in Figure 114, especially in view of freezing when zero weather occurs. Use shears or scissors instead of a knife so as to pinch the blood vessels and mitigate the flow of blood.



FIG 116: HOLDING A PIGEON

Shield for Injured Fowls—This blanket, made of burlap or bagging (Figure 115), is used to protect hens or turkeys injured on back or sides during breeding season. Narrow bands or soft cords at sides and front attach the shield to the fowl under the legs and in front of breast. Without such precaution, the wounds made by spurs or claws are constantly being reopened and become sometimes incurable.

To hold a pigeon firmly but without hurting it, take the bird as in Figure 116, the breast resting on the flat of the hand, so that the head is over the little finger, the legs between the first and second fingers and the thumb across the back of the bird. The wings are held closely by the palm and ends of fingers and the bird will seldom struggle or try to escape.

INDEX

	PAGE		PAGE
Balance for small mills	30	Exerciser	10
Barrel with roosts	105	Feed box, protected	2
Bone mills	26	slatted	2
Box trap, improved	92	cooker	110
Brooder, a cheap	82	Feeder, automatic for grains...	7
a handy	80	for chicks	3
a small lamp	81	for shell, bone and grit.....	3
an improved	79	Feeders, automatic	4
filling a	86	simple for shell grit	5
for fifty chicks	80	Feeding board	9
for warm weather	89	by clockwork	8
homemade	87	hopper, Bement's	3
hot water	91	pens for chicks	6
large hot water	86	Fodder cutter	29
operation of	89	Food chopper	28
the sure	83	Fountain, covered	14
window	84	for chicks	20
Brooders, various	75	for lamp	17
Cabinet for eggs	71	general purpose	21
Cat trap	94	non-freezing	19
Chickens, carrying young	75	oyster-can	23
feeding pens for	6	protected	13
feeding young	75, 78	warmer	18
roost for	43	winter	15
temperature for	76	Grit machine, powerful	33
to dust	106	pounder	31
Combs, trimming	117	Grundy's advice on hatching...	63
Cooker	110	Hawks, bounty for	98
small	111	protection from	98
Crates, shipping	113	trapping	99
Crockery, grinder for	31	Heater and ventilator	108
Door, between pens.....	45	for poultry house	107
combination	44	for water	16
requirements for	44	Homemade incubator	65
self-opening	46	Hook, poultry	115
Doors, drop	100	Houses, cleaning	102
Ducks, exerciser for	115	Incubator for farmers	61
nest for	60	problem, the	61
pool for	24	running an	62
Dust baths	105	starting an	69
Dropping boards	41	to make	64
Egg carrier	72	Incubators, Grundy on	63
case	72	regulating	63
tester	67	selecting an	61
turner	67	Injured fowls, protecting	118
Eggs, handling	71	Insect powder, to apply	106
keeping	72	Kerosene emulsion, to make....	103
storing	71	Lamp pipes	68
testing	62		
turning	63		

	PAGE		PAGE
Manure bin	42	Scratching, to prevent	113
Mill for green bones	27	Shell, feeder for	5
for grit	32	Shield for fowls	118
Nests and roost	57	Shipping case for eggs	73
dark	54	crates	113
for ducks	60	Skunk trap	91
model	51	to dispose of	96
movable	54	Stories, three, using.....	106
secure	53	Tank for water	12
simple	51	Tester for eggs	79
recording	55	Trap for cats	94
wire	54	for hawks	99
Passageway, convenient	100	for skunks	94
Pigeon, holding a	118	nests	55
Pulley, homemade	102	Trough, covered	2
Pulleys	102	protected	1
Pump for whitewashing	103	wire	1
Rats, trap for	92	Vegetable cutter	29
Roost and nest	59	Ventilation, when needed	100
a low	34	Ventilator, box	67
a model	34	convenient	100
for cold weather	38	Warm box	112
for heavy fowls	39	Waste of food	1
in oil pan	38	Water can, casing for	22
Roosting plan, a warm.....	38	dish, box for	23
room separate	40	dish, safe	22
Roosts and dropping boards....	47	for ducks	24
and manure bin	42	heater	16
cleaner for	105	supply plan of	11
cover for	105	Whitewashing, brush for	103
for chickens	43	with pump	103
improved	35	Window brooder	84
lice proof	36	Windows, double	49
on barrel	105	good	46
portable	34	warm	48
support	37	Wings, cutting	117

