

The Syntax of Tuki: A Cartographic Perspective

Edmond BILOA

To the memories of the following people:

- My mother, Madame Abah née Madeleine Ndouma Edoua, who passed away while I was writing this book. She made it possible for me to acquire Tuki by sending me to the village for the summer vacation when I was a kid.
- Osvaldo Jaeggli, who passed away while I was writing my Ph. D. dissertation at the University of Southern California in Los Angeles;
- To the people who have died of AIDS and were unjustly accused, along with their entourage, of being bisexual.

Foreword

The aim of this book is to provide a syntactic analysis of Tuki, a Bantu language of Cameroon, within the framework of the Principles and Parameters Theory. Wherever possible/necessary, some minimalist notions are appealed to. Overall, the theoretical framework is the cartographic approach to syntactic structures. The outline of the latter approach is proposed in the introduction to this book. Generative research on Tuki started in Biloa (1992) that was later published in 1995. The bulk of the data described and analyzed in Biloa (1992, 1995) is reanalyzed here in view of the new developments in the field (Kayne 1994; Rizzi 1997; Cinque 1999; Cinque 2002a; Belletti 2004b; Rizzi 2004a). And the results obtained are sometimes radically different from the previous ones.

Research conducted here has benefited from the help of many institutions and colleagues. As far as institutions are concerned, I would like to thank, for various forms of funding, the following:

- Agence Universitaire de la Francophonie;
- University of Yaounde I, Cameroon ;
- University of Ngaoundere, Cameroon;
- Madonna University, Nigeria.

The following colleagues, across the world, have been helpful:

-Marc Authier read through the chapter on “the cartography of the left periphery” and provided valuable comments, observations and remarks. He was also instrumental in sending me from the Pennsylvania State University papers, articles and books.

-Guglielmo Cinque was nice enough to send me all of his publications since the inception of the cartographic approach. I am grateful for his remarks and advice on chapters devoted to “The order of clausal functional heads”, “Adverbs”, “DP structure and Concord”, and “Adjectives and the split DP structure”.

-Ur Shlonsky also send me his publications and made important remarks on the chapter “The cartography of the left periphery.” I have benefited indirectly from Ur Shlonsky’s expertise since we are cosupervising a doctoral student from Cameroon at the University of Geneva.

-Christopher Laenzlinger and I have exchanged a great deal on the structure of DP and IP. In effect, my work has drawn inspiration from Laenzlinger’s (2005b) layered DP study and Laenzlinger’s (2010) *Elements of Comparative generative syntax*. Moreover, his remarks and observations on the chapter “Adjectives and the split-DP structure” have made it possible to recast some ideas and notions.

-Luigi Rizzi facilitated my access to the books published by the series Oxford Studies in Comparative Syntax of Oxford University Press, under the common heading *The*

Cartography of Syntactic Structures. He equally sent me his articles and gave me advice on various aspects of CP, IP structures and phases in Tuki.

In the same vein, I would like to thank Larry Hyman, Ken Safir, Mark Baker, Ngessimo Mutaka, Pius Tamanji, Samson Abangma, and Florence Tabe for sharing with me material from their personal libraries.

Finally, many of my graduate students have contributed, in one way or another, to the realization of this book: Paul Roger Bassong, Abdoulaye Laziz Nchare, Gaston Bessala Ndjana Biloa, Paul Fonkoua, Constantine Kouankem, Cyril Ondoua Engon, Laurence Ndiola Tsuata, Hermann Keupdjio Sidonie, Théodore Bebey...

Last but not least, I wish to acknowledge the support of my immediate family: my wife, Felicite Diam, and kids, Edmond Junior Biloa and Stacy-Murielle Djuri Biloa. To all, thanks a lot.

The Syntax of Tuki

Contents

Foreword

List of abbreviations and symbols

1 Introduction

1.1. The language: Tuki

1.2- Earlier descriptions of Tuki grammar

1.3- The classification of nouns

1.4. Types of nominal forms

2. The theory: the cartographic approach

2.0 Introduction

2.1. The starting point

2.2. Substitution vs adjunction

2.3. Cartography and minimalism

2.4. Current trends in the cartographic approach

2.5. The uniformity of syntactic structures

2.6. Conclusion

2 Phonetics and phonology

2.1 Vowels

2.2 Consonants

2.3. Syllable structure and phonotactic constraints

2.4. Syllable structure and morpheme structure

2.5. Tone

3 clause structure

3.1 Verb morphology

3.1.1 Tense and Aspect

3.1.2 Verbs

3.1.2.1 Verb prefixes

- 3.1.3 Reflexivization
- 3.1.4 Verb suffixes
- 3.1.5 Reciprocals
- 3.1.6 Causative verbs
- 3.1.7 Subject markers
- 3.1.8 Object markers
- 3.2 Basic word order
- 3.3 The internal structure of Infl [+ tense]
- 3.3.1 Word Order in Tensed Clauses
- 3.3.2 The Internal Structure of INFL [+ Tense]
- 3.3.2.1 Verb Structure
- 3.4 Well-formedness of a zero subject
- 3.4.1 The Resumption Test
- 3.4.2 The Emex Condition
- 3.4.3 AGR and Proper Government
- 3.4.4 That- Trace Effects in Tuki
- 3.5 WH- Movement
- 3.6 Predicate Cleft Constructions
- 3.7 Simple sentences
- 3.8 The complex sentence
- 3.8.1 Formal indicators of coordination
- 3.8.2 Formal indicators of subordination
- 3.9 Question formation
- 3.9.1 Dependent yes-no interrogative clause
- 3.10 Focalization
- 3.11 Relativization
- 3.12 Topicalization
- 3.13 Resumptive pronouns
- 3.14 Anaphora and binding

4 The order of clausal functional heads: tense, aspect, and modality in Tuki

Introduction

- 4.1 Tense
- 4.1.1 Past one (P₁)

- 4.1.2 Past two (P2)
- 4.1.3 Past three (P3)
- 4.1.4 Present (P₀)
- 4.1.5 The future one (F1)
- 4.1.6 The future two (F2)
- 4.2 Aspect
 - 4.2.1 The habitual aspect
 - 4.2.2 The retrospective aspect
 - 4.2.3 Continuative |roo| Terminative |dzú|
 - 4.2.4 The progressive aspect
 - 4.2.5 The semelrepetitive aspect
 - 4.2.6 The anterior aspect
 - 4.2.7 The incomplete and completive aspects
 - 4.2.8 The attenuative aspect
 - 4.2.9 The repetitive (iterative) aspect
 - 4.2.10 The quantitative aspect
- 4.3. Co-occurrence restrictions of tense and aspect
 - 4.3.1 T (Past) > Mode_{epistemic}
 - 4.3.2 Asp_{habitual} > Asp_{Anterior} > Asp_{completive}
 - 4.3.3 Asp_{Continuative} > Asp_{anterior}
 - 4.3.4 Asp_{terminative} > Asp_{anterior}
 - 4.3.5 Asp_{retrospective} > Asp_{perfect}
 - 4.3.6 Asp_{retrospective} > Asp_{progressive}
 - 4.3.7 Asp_{progressive} > Asp_{prospective}
 - 4.3.8 Asp_{progressive} > Asp_{semeliterative}
 - 4.3.9 Asp_{prospective} > Asp_{completive}
- 4.4 Modality
 - 4.5 The interpretation of modality
 - 4.5.1 Root modality
 - 4.5.2 Epistemic modality
- 4.6 The order of clausal functional heads in Tuki

5 Adverbs in Tuki: a cartographic perspective

INTRODUCTION

5.1 Outline of Tuki Morphosyntax

5.1.1 Guglielmo Cinque's hierarchy

5.2 The architecture of the clause

5.3 The relative order of Adverbial phrases

5.3.1 Lower AdvPs

5.3.2 "Higher" (sentence) AdvPs

5.3.3 "Lower" AdvPs in VP-final position

5.4 AdvP movement

5.5 Relativized Minimality with adverbs

5.6 Tuki adverbs and the structure of the left periphery

5.7 Circumstantial adverbials of "place, time, manner, etc."

5.8 Focusing and parenthetical uses of AdvPs

6 Null Subject, Identification and Proper Government

6.0 Introduction

6.1 INFL

6.1.1 Verb structure

6.1.2 INFL

6.1.3 Well-Formedness of a zero subject

6.1.3.1 The resumption test

6.1.3.2 The Emex condition

6.2 Morphological Uniformity and Identification

6.2.1 Morphological Uniformity in Tuki

6.2.2 Identification in Tuki

6.3 Concluding remarks

Appendix I: Free Inversion in Tuki

Appendix II: On nominative Assignment in Tuki

Appendix III: On expletives in Tuki

Notes

7 Null Objects in Tuki and the Pro-drop parameter

7.0 Introduction

- 7.1 Characteristics of Tuki null objects
- 7.2 Syntactic Islands
 - 7.2.1 The complex NP constraint
 - 7.2.2 The Sentential Subject Constraint
 - 7.2.3 Adjuncts
 - 7.2.4 The Wh-island Constraint
 - 7.2.5 The Doubly Filled COMP filter
 - 7.2.6 Parasitic gaps
 - 7.2.7 Summary
- 7.3 Tuki null objects as pro
 - 7.3.1 Full Pronominal Subject and Binding Theory
 - 7.3.2 Null Objects and Binding Theory
- 7.4 Null Object Identification in Tuki
- 7.5 Null Objects In Other Languages
- 7.6 Concluding Remarks

8. A-bar bound pro

- 8.1 Introduction
- 8.2 Tuki as a pro-drop Language
- 8.3 Resumptive pronouns
 - 8.3.1 Wh-questions
 - 8.3.2 Relativization
 - 8.3.2.1 Headed relative clauses
 - 8.3.2.2 Free relative clauses
- 8.4 Island Environment
- 8.5 Weak cross-over at S-structure
- 8.6 Anaphoric binding
- 8.7 Reconstruction and syntactic Movement
 - 8.7.1 Movement and variable binding in Japanese
 - 8.7.2 Movement and variable binding in Tuki
 - 8.7.3 Subjacency: Condition on Movement or representations?
 - 8.7.3.1 Subjacency in Tuki syntax
 - 8.7.3.2 Subjacency in Tuki logical form
 - 8.7.3.2.1 Scope properties of Wh-in-situ in Tuki
 - 8.7.3.2.2 Wh-phrases in-situ and subjacency
 - 8.7.3.3 Subjacency in Egyptian Arabic
 - 8.7.3.3.1 Argument Wh-operators

- 8.7.3.3.2 Adjunct-wh- operators
- 8.7.3.3.3 Topicalization
- 8.8 Coordination
 - 8.8.1 Clausal coordination
 - 8.8.2 NP coordination
- 8.9 Formal versus Semantic Variables
- 8.10 Linking Theory
- 8.11 The overt Pronoun Constraint in Tuki
- 8.12 Palauan
- 8.13 Concluding remarks

9 DP Structure and concord

- 9.1 Status and distribution of determiners
 - 9.1.2 Possessive determiners
 - 9.1.3 Demonstrative determiners
- 9.2 The distribution of the possessive determiner
- 9.3 The distribution of the demonstrative determiner
- 9.4 The internal constituency of the possessive determiner
- 9.5 More on the distribution of the demonstrative determiner
- 9.6 The distribution of locative reinforcers
- 9.7 The structure and derivation of the Tuki DP (with a demonstrative Det and)
 - a locative reinforcer
- 9.8 N + Poss Det + Dem Det = DP?
- 9.9 N + Dem Det + Poss Det = DP?
- 9.10 NP + Poss Det + Dem Det + Dem Det = DP?
- 9.11 The Tuki D-system and the split-DP structure
 - 9.11.1 An articulated nominal left periphery
 - 9.11.2 The nominal inflectional domain
 - 9.11.2.1 The order of noun modifiers
 - 9.11.2. Tuki postnominal adjectives and the structure of DP
 - 9.11.3 DP derivation and snowballing movement
 - 9.11.4 Focalization in DP

10 Adjectives and the split-DP structure

- 10.1 Adjectives
 - 10.1.1 Pure or prenominal adjectives
 - 10.1.2 Class 2 pure adjectives or postnominal adjectives

- 10.1.3 The interaction between prenominal and postnominal adjectives
- 10.2 Tuki adjective placement
- 10.3 Verbal adjectives

11. The cartography of the left periphery

- 11.1. The focus phrase (FP) in Tuki
 - 11.1.1.1 Structure of focus sentences
 - 11.1.1 Matrix wh-questions
 - 11.1.2 Embedded wh-questions
 - 11.1.4 Spec-Head Agreement
 - 11.1.5. Wh-questions *and* clause structure
 - 11.1.6 Origin of the Focus Marker
 - 11.1.7 Wh-questions as Focus Constructions
- 11.2 The Force Phrase (ForceP) in Tuki
- 11.3 Relativization
 - 11.3.1 Accessibility Hierarchy
 - 11.3.2 Relativization and Bounding theory
 - 11.3.3 The landing site of relativization
- 11.4 Topicalization in Tuki
- 11.5.1 The position of *ngi* "if "
- 11.5 The position Int(errogative) in Tuki
 - 11.5.2 The IntP in main clauses
- 11.6 The position ‘Mod (ifier) P (hrase)’ in Tuki
- Conclusion

12 Argument, adjuncts and Relativized Minimality

- 12.0. Introduction
- 12.1. Relativized Minimality
 - 12.1.1. Definitions
 - 12.1.2. The Referentiability Principle and the ECP
- 12.2. That-Trace Effects in Tuki
- 12.3. The syntax of Wh-in-situ in Tuki
 - 12.3.1. Movement to CP at LF?
 - 12.3.2. Simplex Clauses: Wh-In-Situ
 - 12.3.2.0. Simple Questions
 - 12.3.3. Multiple questions
 - 12.3.3.1. Arguments

- 12.3.3.2. Multiple questions with adjuncts
- 12.3.3.2. Double adjuncts questions
- 12.3.4. Wh-in-situ phrases in embedded contexts
- 12.3.5. Multiple Questions with Wh-in-situ
- 12.4. Wh-in-situ and the ECP
- 12.5. LF adjunction and Relativized Minimality
- 12.6. Superiority
- 12.7. Conclusion

13 Focus-V-Movement

- 13. 0. Introduction
- 13.1. The Tuki empirical Material
 - 13.1.1. Characteristics of the Focused Verb
 - 13.1.2. Can Any verb Be Focused?
 - 13.1.3. Characteristics of Focus-V-Movement Constructions
- 13.2. Focus-V-Movement
 - 13.2.0. Summary
 - 13.2.1. Wh-Movement as Substitution for Spec of FP
 - 13.2.1.1. Structure of Focus sentences
 - 13.2.1.2. Matrix Wh-Questions
 - 13.2.1.3. Embedded Wh-Questions
 - 13.2.1.4. Wh-Questions and Clause Structure
 - 13.2.2. Focus-V-Movement as substitution for Spec of FP
 - 13.2.3. The Morphological conversion Hypothesis
 - 13.2.4. The semantic hypothesis
 - 13.2.5. The Specifier Identity Condition
- 13.3. Extension of the Analysis: Basque
 - 13.3.1. Wh-Movement and Focus in Basque
 - 13.3.1.1. Interrogative and focal Operators
 - 13.3.1.2. Verb- Second Phenomenon
 - 13.3.1.3. Verb focalization
- 13.4. Chinese: LF Verb Movement to CP.
- 13.5. Yafei Li's Analysis
- 13.6. SIC, Case-Resistance Principle, Theta-Role-Resistance Principle
- 13.7. The A/A' and V/V' System
 - 13.7.1. Focus-V-Movement and the Empty Category Principle
 - 13.7.2. Focus-V-Movement and the No-Free-Affix Principle

14 Anaphora and Binding

14.1 Application of the binding theory in Tuki

14.2 Problems

14.3. Complete functional complex (CFC)

Notes

15 Bound variables

Introduction

15.1. Pronouns in Coreference and Bound Pronouns

15.1.1. Referential Pronouns

15.1.2. Bound Pronouns

15.1.2.1. Simplex Sentences

15.1.2.2 Embedded Context

15.1.2.3 Complex NPs

15.1.2.4 Simplex Noun Phrases

15.2. Minimality

15.2.1 Locality

15.2.2 Minimal Disjointness

15.2.3 Short distance anaphors

15.2.3.1 Reflexive verbs

15.2.3.2 Reciprocal verbs

15.3. Conclusion

Notes

References

Index

ABBREVIATIONS

Acc = Accusative
AGR = Agreement
AgrP= Agreement Phrase
Agr-S = Agreement-Subject (subject-verb agreement)
Appl = applicative
AspP = Aspect (ual) Phrase
COMP = Complementizer
CP = Complementizer Phrase
ECP = Empty Category Principle
EPP = Extended Projection Principle
FOC= Focus
ForceP= Force Phrase
FP = Focus Phrase
F1 = future tense one
Hab = Habitual
HLC = Head Licensing Condition
Int = Interrogative
IP = Inflectional Phrase
IntP= Interrogative Phrase
LCA = Linear Correspondence Axiom
Mod = Modifier
NP = Noun Phrase
NOM =Nominative
OM = Object Marker
OP = Operator
P1 = Past tense one
P2= Past tense two
PP = Prepositional Phrase
PPA = Principle of Projection Activation
Prog = Progressive SM= Subject Marker

Q = Question

QM = Question Morpheme

QUOT = Quotative

Rel = Relative

RelP= Relative Phrase

Spec = Specifier

TNS = Tense

Top = Topic

V = Vowel

TP = Tense Phrase

TopP = Topic Phrase

UG = Universal Grammar

VP= Verb Phrase

CHAPTER ONE

The language and the theory

1.1. The language: Tuki

Foreigners sometimes call TUKI Sanaga. Ewondo people, in particular, call this language ATI. But to the native speakers, it is TUKI.

TUKI is spoken in Cameroon. Studies on the classification of Cameroon languages show that the three linguistic families which cover Africa are represented in Cameroon.

The Tuki language belongs to one of these families: the NIGER KORDOFAN (Niger-Congo) linguistic family; subfamily: Benue Congo; branch: Bantoid; division: bantu; group: Sanaga A60. Tuki is spoken in the Central province of Cameroon, most specifically in the Lekie division and the Mbam and Kim division. It is used by 26,000 native speakers. They are located along the Sanaga river, north of Saa between Ombessa and Ntui, and in the bafia district and the Ngoro district.

In the next page, we provide a map of the main ethnic groups of Cameroon:

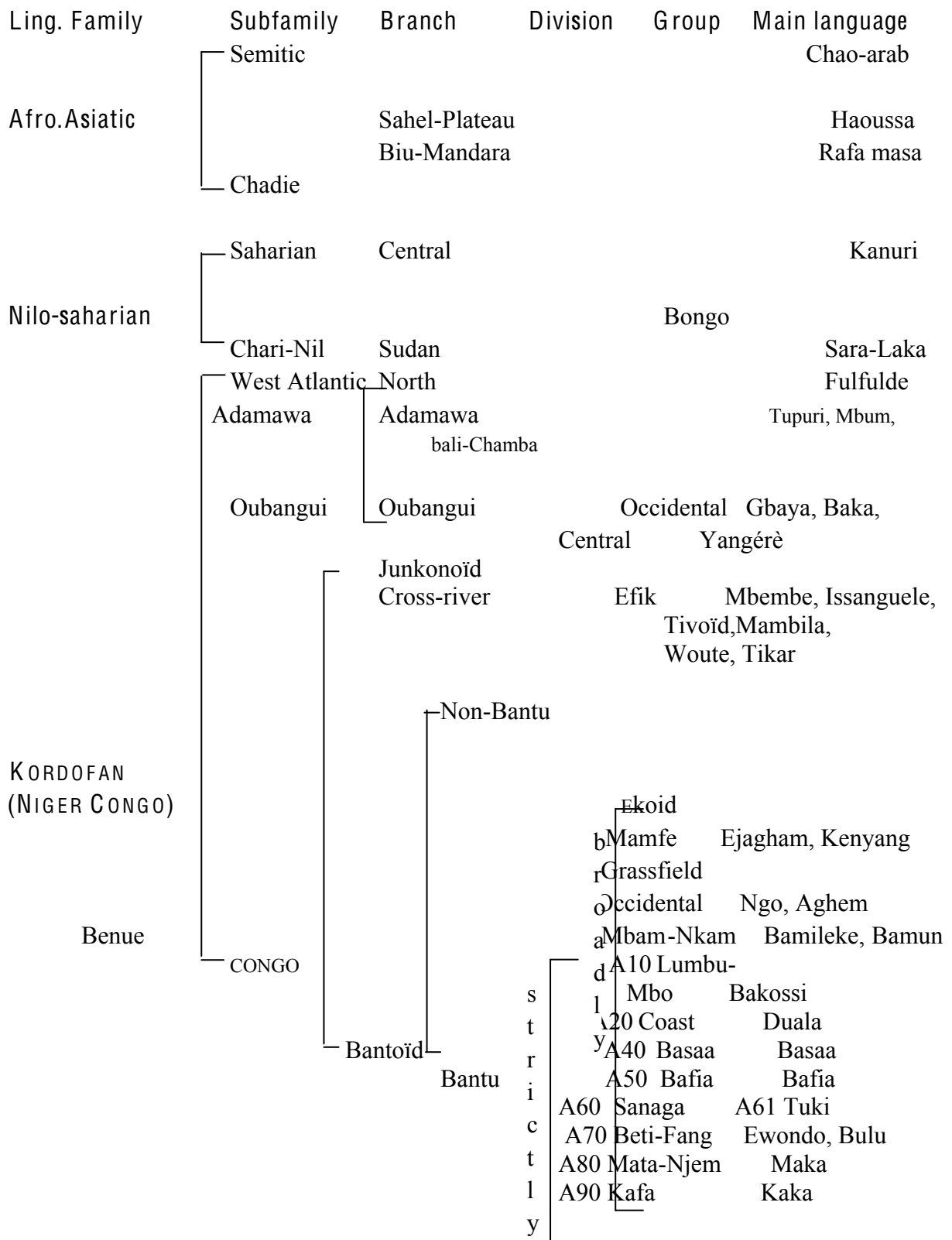

Source: l'Encyclopédie de la République Unie du Cameroun, Tome Premier: Le Milieu et les Hommes, pp. 42

Many linguistic classifications state that Tuki is composed of many dialects. Bryan (1959: 14-15) and Guthrie (1971) assign to all these dialects of Tuki the name Bati. But they do not refer specifically to Tuki.

Delafosse (1914) classifies the Tuki dialects into the Niger- Cameroon family, in the intermediary Sudan-Bantu group.

According to Tesson (1932), Tuki belongs to the Bat-Mbam group, in what he terms the “Bantu of Central Cameroon”.

Pedraza (1946), taking widely into account Seligman and Millous’ study, considers Tuki as belonging to the subgroup Fang just as Yambassa, Baso, Ngumba, Ntumu and Fong.

Bauman and Westermann (1967) and even Richardson (1956: 29) relate Tuki to what they term ‘Bafia-group’ and which comprises Fa?, Ngoro, Cinga, Yambassa, Sanaga, Mangisa. Richardson claims that “it is hard to say from evidence where Cinga ends and Sanaga begins. The Kombe speak like Tsinga, said our informant. There is a great similarity between Cinga and Ngoro.”

Lastly, Bryan and Guthrie range Tuki among Bantu languages of the group A60 denominated “Sanaga-Group” and propose the following classification:

A61: Ngoro

A62: Yambassa

A63: Mangisa

A64: Bacenga

A65: Bati

According to the Atlas Linguistique du Cameroon (1985), there are seven dialects of Tuki (Cf. The Ethnologue 2005):

A60: Sanaga group

A61: Tuki

- Tungoro (=Ngoro, Uki, Aki)
- Tukombe (=Kombe, Wakombe, Bakombe)
- Tonjo (= Bondjou or Bounjou, Bunju)
- Tocenga (= Batchenga, Tiki)
- Tutsingo (= Batsingo, Tsinga, Chinga)
- Tumblele (= (Ba)mbele, Mbere, Mbele, Bamblele, Mvele, Bamvele)
- Leti (native language of the Mangisa people)

A62: Yambassa

A62a: Gunu (Nugunu)

Gunu Nord (Ombessa)

Gunu Sud (Bokito)

A62b: Mmaalaa

A62c: Libye (Nulibye)

A62d: Yangben (Nokalonge)

A62e: Bongo

Out of these dialects of Tuki, six are spoken in the Mbam division, precisely in the district of Ntui (Tonjo, Tocenga, Tumbele), the district of Bafia (Tungoro) and in the Ngoro district (Tungoro). Only Leti is spoken in the lekie division. Leti, though being a variant of Tuki, is the native language of the Mangisa ethnic group who speaks on the other hand Njowi, a Beti-Fang dialect very similar to eton.

Sanaga or ati is the term used by the Beti people to designate the people along the Mbam and Sanaga rivers.

Native speakers of Tuki speak languages of neighboring villages. That is why there are cases of bilingualism or trilingualism due to the neighborhood of languages or to mixing of different ethnic groups. Furthermore, many Tuki speakers of the districts of Ombessa and Bafia speak fluently either Yambassa or Bafia.

1.2- Earlier descriptions of Tuki grammar

The first descriptive study on Tuki was a Master thesis (Mémoire présenté pour l'obtention du Diplôme d'Etudes Supérieures de lettres) at the University of Yaounde by Jean Jacques Marie Essono (1974). Essono's thesis is a phonological analysis of Tsinga (cinga), one of the dialects of Tuki.

In 1980, Essono wrote a manuscript on the derivational morphology of the language. At approximately the same period, Hyman (1980) published a paper on the noun classes of Bacenga, another dialect of Tuki.

In 1989, Biloa published a paper on "Tuki gaps..." in *Studies in the Linguistic sciences* (Vol. 19, N°2). In 1991, two papers were published by the same author in *Linguistics*: one on "Null subjects...", the other on "Anaphora and binding...". A Ph.D. dissertation on "the syntax of operator constructions in Tuki" was defended in 1992 at the University of Southern California in Los Angeles. By the same author.

In 1992, Hyman and Biloa published a paper on "Transparent Low Tone in Tuki" in Berkeley Linguistic society (BLS 18). A book, the title of which is *Functional categories and the syntax of Focus in Tuki* was published at Lincom Europa in 1995 by Biloa.

1.3- The classification of nouns

In Tuki as in most bantu languages, the noun consists of a prefix and a stem, as illustrated by the following Tuki examples:

Singular		Plural
Prefix+Stem		Prefix+Stem
mù - tù		và - tù
C11 stem		C11 stem
“person, man”		“ people, men”
b) o - ngurú		i - ngurú
C13 stem		C14 stem
“foot”		“feet”
c) i - sutu		mu - sutu
C15 stem		C16 stem
“belly”		“bellies”
d) i - kundá		vi - kundá
C17 stem		C18 stem
“bed”		“beds”

The nominal prefixes above are either singular or plural. The singular prefixes appear on the left while the plural ones are in the right column. However, not all classes exhibit singular/plural pairs of prefixes. For instance, classes 3, 6a, 8,9, 10,18, 9/13, 16/16a have only singular prefixes. For details, see the table of noun classes in Tuki below. In the Bantu Noun Prefix System, there is a total of 24 classes (see the table below). But not all the different classes are attested in one Bantu language.

The bantu Noun Prefix System

Class	*PB	Zulu	Setswana	Luganda	*PB/ Meeussen
1sg	mo-	um-	mo-	omu-	mu-
1a sg	∅	u-	∅-	∅-	
2PI	va-			Ava	ba-

2a Pl	va-			va	
2b Pl	Vɔ	oo-	bo-		
3 Sg	mo-	um-	mo-	omu-	mu-
4pl	me-	imi-	me-	emi-	mi-
5sg	le-	i-	le-	*e-	di-
6pl	ma-	ama-	ma-	ama-	ma-
7sg	ke-	isi-	se-	eki-	ki-
8pl	vi-			Evi-	bi-
8x pl	li-	izi-	li-		bi-
9 sg	ne-	iN-	N-	eN-	N-
10 pl	li-ne	iziN-	liN-	eN-	N-
11 sg	lo-	u-	lo-	olu-	lu-
12 sg	ka-			aka	ka-
13 pl	to-			otu-	tu-
14 sg/pl	vo-	uBu-	bo-	ovu-	bu-
15 neutre	ko-	uku-	xoo-	ku-	ku-
16 nt	pa-	pha-	fa-	wa-	pa-
17	ko-	ku-	xo-	ku-	ku-
18	mo-		mo-	mu-	mu-
19 sg/pl	pi-				fi-
20 sg	Go-			ogu-	gu-
21 sg	Gi-				zi-
22pl	Ga-			aga-	ga-
23nt	Ge-	e-, o-		e-	gi-
24	i-				i-

The above table from Mutaka and Tamanji (2000:151) provides two versions of the reconstructed proto-bantu nominal prefixes. The version in the left column was proposed by Welmers (1973), and the one in the right column was designed by Meussen (1963). The reflexes of these prefixes are attested by the nominal prefixes of Zulu, Setswana and Luganda. These prefixes are characterized as follow (for details see Mutaka and Tamanji (2000: 151-152)). The numbering of the noun classes was proposed by Bleek (1862) and Carl Meinhof (1899,1932). They consist of personal nouns, a few other animate nouns, rarely inanimates.

Classes 3 – 4 consist of names of trees and other plants or inanimate things.

Classes 5 – 6 include miscellaneous objects and also augmentatives.

Classes 7 – 8 also indicate the manner or the style of doing things.

Classes 9 – 10 include most animal names, inanimate nouns and a few personal nouns.

Class 11 includes objects that are generally thin and long objects; it also includes attenuatives and abstract things.

Class 12 – 13 include dominatives.

Class 14 is a plural class and it also includes nouns for abstract things.

Class 15 is the class prefix for verbal infinitives.

Class 16, 17 and 18 consist of locatives; these are not basic prefixes but they appear in the concordial system.

Class 19 is a class for diminutives: e.g. ki - kongo: mbéele ‘knife’; fi – mbéele ‘small knife’.

Classes 20 – 23 are rare. Class 20 is a class for augmentatives or diminutives. Class 21 is a class for augmentatives and pejoratives. Class 22 has been found only in Luganda and it forms its plural in class 20 or class 5. Class 23 is another locative which, in some languages, appears in combination with the prefix of many other classes.

Class 24 is locative found in Hima (Meussen 1967).

In Bantu languages, nouns are classified into various classes. At the minimum, nouns maintain bimorphemic structure. That is they have a nominal stem and the nominal prefix. Grammatically relevant information of gender and number is encoded by the prefix. In the following table, the full range of noun classes for Tuki is presented:

Table: Noun classes in Tuki

Class		Prefix		Subject marker		Object marker	
1	2	mu-	va-	a-	va-	mú-	wú-
3	4	o-	i-	o-	i-	N/A	N/A
3a	4a	∅	va-	∅-	va-		
5	6	i-	mu-	i-	mu-		
5	6a	∅	∅-	ma-	ma-		
7	8	i-	vi-	i-	vi-		
9	10	∅	∅-	i-	i-		
11	6a	∅	∅-	i-	i-		
11	13	n-	t-	nu-	to-		
				na-	tu-		

14	6a	wu-	ma-	o-	ma-
19	18	i-	mu-	i-	mu-
3		∅-		a-	
				o-	
6a		∅-		ma-	
8		∅-		vi-	
9		∅-		i-	
10		∅-		i-	
18		∅-		ma-	
5	13	a-	vi-	i-	
3	6	o-	a-	o-	
4	10/6a	i-	mu-	i-	
9	13	∅-	∅-	i-	
16	16a	∅-	∅-	o-	

In the above table, each of the classes has a specific class marker and a specific agreement marker which is a verbal prefix. This verbal prefix is always called the subject marker (SM). Its status and function will be extensively discussed in the chapter devoted to clause structure. Throughout the book, more information will be provided about noun classes wherever relevant.

1.4. Types of nominal forms

According to Mutaka and Tamanji (2000: 153), there are two types of nominal forms: the underived nouns and the derived nouns. An underived comes with its own prefix. Such a prefix may be called primary prefix. First, in Tuki, words like mu – tu (class 1) “person, man”; i – kara (class 19 “bird”, vi – toki (class 13) “threads”, o – tsó (class 3) “ear” consist of the primary prefix and a stem.

Mutaka and Tamanji indicate that the derived nouns are so called because they usually derive from verbs (they are called deverbatives). In Tuki, deverbatives are common as illustrated by the following examples:

Verbs	Deverbatives
a) o - nono- ó inf. stem FV “to work”	a) ma - nono- ó “work”
b) o - tir- a inf. stem FV “to write”	bi) vi - tir- a “writing” bii) vi - tir- ínó “manner of writing” biii) tir - ínó “manner of writing”
c) w - end- a inf. stem FV “to go”	c) ng - end- éno “manner of walking; act of going, leaving”
d) w - eng- a inf. stem FV “to do”	d) ng - eng- éno “manner or act of doing”
e) o - ny- á inf. stem FV “to eat”	e) nny - éno “act or manner of eating”
f) o - song- o inf. stem FV “to make love”	f) t - song- éno « act or manner of making love”
g) o- bang- a inf. stem FV “to cry”	g) m - bang- éno “act or manner of crying”
h) o - dzídžíy -a inf. stem FV “to cheat, to lie”	h) n - dzídžíy- éno “act of cheating, lying”
i) o - ndend- a inf. stem FV “to walk”	i) n- ndend- éno “manner or act of walking; behavior”
j) o- dzodzón- o inf. stem FV “to play”	j) n- dzodzón- éno “ act of playing”

k)o- ding- a inf. stem FV “to love, to like”	k)n- ding- éno “manner or act of loving”
l)o- bón- ó inf. stem FV “to run away, to flee”	l)m- bón- éno “act or manner of running away, fleeing”
m) w- ib- á inf. stem FV “to steal”	m)ng- ib- íno “manner or act of stealing”
n)o- dǎng- á inf. stem FV “to get lost”	n)n- dǎng- éno “manner of getting lost”
o)w- on- o inf. stem FV “to laugh”	o)ng- on- éno “act or manner of laughing”
p) o- bán- á inf. stem FV “to marry”	p)m- bán- éno “act or manner of marrying”
q) o- táng- á inf. stem FV “to share”	q)n- táng- ú “act or manner of sharing”
r)o- tát- á inf. stem FV “to feel, to touch”	r) tát- éno “act or manner of feeling, touching”
s) o- fów- á inf. stem FV “to build”	building” s)m- fów- éno “act or manner of
t)o- bow- a inf. stem FV “to harvest”	t)m- bow- éno “act or manner of harvesting”
u)o- sér- á	u) t- sér- éno “act or manner of

inf. stem FV “to sell”	selling”
v)w- aány- ó inf. stem FV “to drink”	v)ng- ány- éno “act or manner of “drinking”

As stated above, deverbatives are nouns that are derived from verbs. In Tuki, the process of deverbative formation is regulated by a few phonological rules. In most cases, deverbatives will have in word initial position one of these consonants: /n/, /m/, /ng/ or /t/. /n/ will occur before one of the following consonants: {d, t, n}. /m/ will show up before one of these bilabial plosives: {p, b}. And /ng/ will precede vowels. In other words, /n/, /m/ or /ng/ immediately precede the stem of the verb(s) in the deverbative(s). If the stem of the verb starts with the fricative /f/, the latter turns into bilabial plosive /p/ after /m/ in the deverbative. /t/ will precede the stem beginning with an alveolar fricative /s/ (as in *tsongénó* “act or manner of making love” or *tséréno* “act or manner of selling”) in the deverbative.

There are, however, a few puzzling cases that abide by neither of the above phonological rules:

- a) ononoó → manonoó
“to work” “work”
- r) otátá → táténó
“to feel, to touch” “act or manner of feeling, touching”

Normally, given what was said above deverbatives in (a) should have been *nnonooà and in (b)*ntaàteànoà. But that is not the case. For the time being, there is no explanation as to why this is so.

Most of the data illustrated seem to indicate that Tuki deverbatives end with *ENO* (or the allomorphic *INO* which is due to vowel harmony). There are a few exceptions to this morphological rule:

- a) ononoó → manonoo
b) otángá → ntángú
“to share” “act or manner of sharing”

If the morphological rules were applied strict sensu, the nominal forms should have been respectively *nnoneànoà and * ntangeànoà. These exceptions remain unexplained.

Reduplication, on the contrary, is scarce in Tuki:

mwaná mwaná “grand child”
child child

There are also very few instances in Tuki where one can have stem + stem nominals:

a) mwaná mútu
son person

“a person’s son”

b) mangádzú ókutu
child woman

“youngster/young woman”

c) inyá máabó
eater wine

“drunkard”

d) ifénda matúwa
repairer car

“mechanic”

e) ibaná mbwíi
thief goat

“goats’ thief”

f) asérá ngóo
seller chicken

“chicken’s seller”

I.5. Secondary prefixes

As argued by Mutaka and Tamanji (2000: 154), the secondary prefix provides information that is lexical and grammatical while the primary prefix gives to the nominal form its grammatical gender (class) and number (singular or plural).

In Tuki, the secondary prefix is prefixed to the primary prefix: the secondary prefix is /maa/. When it is prefixed to a nominal form, the resulting meaning is “small NP/DP”. For illustration, consider the following nouns:

a) mutu “person, man”

b) yendze “house”

c) nama “animal”

- d) mbwíi “goat”
- e) wandá “something”

Prefixation of /maa/ to the above nouns results in the following:

- a) maá- mutu “small man”
- b) maá- yěndze “small house”
- c) maá- nama “small animal”
- d) maá- mbwíi “small goat”
- e) maá- wandá “small thing”

There is another Tuki secondary prefix which changes the meaning of a noun into something like “worthless” or “no NP/DP”, /kaa/:

- a) kaá-mutu “worthless man; nobody”
- b) kaá-yendze “no house”
- c) kaá-nama “no animal”
- d) kaá- mbwíi “no goat”
- e) kaá- wandá “no thing, something that is not worth it”

Another Tuki secondary prefix that conveys both lexical and grammatical information is /wu/. When it is prefixed either to an adjective or a noun, the resulting entity which is a noun means “the state of X or being X”:

- a) nama (N) > wunama
“animal” “animality”
- b) vaádzú (N) > waádzu
“children” “childhood”
- c) aronó (Adj) > wuronó
“old” “old age”
- d) asaki (Adj) > wusaki (N)
“single” “singlehood”
- e) yeédzá (Adj) > weédzá (N)
“fool, stupid” “foolishness, stupidity”
- f) ombé (Adj) > wubé (N)
“bad, ugly” “badness, ugliness”
- g) angámí (Adj) > wangá (N)
“big” “bigness, being big”
- h) mbéré (N) > wumbéré (N)

- “friend” > “friendship”
- i) kórí (N) >wukórí (N)
 “slave” “slavery”
- j) osí (N) >wusí (N)
 “well, beautiful, nice” “wellbeing”
- k) mbákí (N) >wumbákí (N)
 “slave, servant” “slavery”
- l) mbítsú >wumbítsú
 “brother, sister” “brotherhood, sisterhood”

2. The theory: the cartographic approach

2.0 Introduction

Cartography is an appealing research program within the framework of Principles and Parameters of syntactic theory. It emerged and gained its name in a series of colloquia held in Italy in the late 90’s and became widely known through the publication of the first three volumes of the Oxford University series *The cartography of syntactic structures* (Belletti 2004, Cinque 2002, Rizzi 2004).

According to Rizzi and Cinque (2008), the cartography’s aim is to “draw maps as precise and detailed as possible of syntactic configurations” and its fundamental goal is the study of the richly articulated internal structure of phrases and clauses. Coming to the realization that syntactic structures are complex but very rich entities, some researchers thought that the study of such functional entities was a worthwhile endeavour, and that is why they set the goal of arriving at structural maps that could elegantly do justice to the internal complexity of syntactic structures. Overall, cartography has been prompted by the fact that syntactic structures exhibited are complex and very rich domains that need to be handled with care if one wants to do justice to syntactic layers such as the phrases and clauses.

2.1. The starting point

Cartography stems from the idea that inflectional morphology is distributed in the syntax. This view takes root in Chomsky’s 1957 *Syntactic structures* whereby the inflectional system of English is examined. According to Chomsky (1957), being elements of the syntactic computation, inflectional affixes are assumed to be subject to certain syntactic properties like local movement due to the complex distributional dependencies in the English auxiliary system: syntactic atoms can be thought of as elements that are not morphologically autonomous words; morphological well-formedness can be obtained by submitting such atoms to movement processes. These ideas were widely supported in the early age of generative grammar, and were multiplied with the advent of X-bar theory. All syntactic structures project a uniform subtree (Chomsky 1970), and functional categories are full-fledged syntactic atoms, capable of projecting their own phrasal categories (Chomsky 1986a).

From Chomsky (1957) to Chomsky (1986a), the backbone is that clauses should be formed by the articulation of lexical and functional elements, each projecting uniform subtrees according to the general laws of structure building mechanisms. Inflectional morphology provided direct morphological evidence illustrating the morphosyntactic components of the clause. Although the morphological richness is a superficial trait of variation among human languages, clauses should be formed by a constant system of functional heads in all languages, each projecting a subtree, occurring in a fixed syntactic hierarchy, irrespective of the actual morphological manifestation of the head.

With the advent of Chomsky's "Affix Hopping", Edmond's 1978 comparative analysis of the position of the verb in French and English and Pollock's 1989 Split-IP hypothesis, there is clear evidence that complex word order patterns could be reduced to uniform syntactic structures plus simple parameters having to do with the way in which affixation takes place. This line of analysis provided further support for a crosslinguistic variation within the framework of comparative linguistics. Among other things, the detailed study of the ordering of adverbial positions started to bear very directly on the analysis of the basic clausal structure, a trend that culminated in Cinque's (1999) book, which fully integrated morphological, syntactic as well as interpretative evidence in the exploration of the fine details of the clausal structure across languages. That phrases and clauses are uniformly structured and ordered for lexical and functional heads across languages stems from the fact that inflectional morphology is distributed in the syntax. This paved the way for the fine conception of syntactic structures that is assumed and validated in the realm of the cartographic approach.

2.2. Substitution vs Adjunction

The identification of heads positions in the clausal and phrasal structure provides a very appealing model for the morphology- syntax interface. The earmark of this relying in the positions occupied by phrases and computations involved in phrasal movement.

Two lines of analysis emerge: with respect to movement processes, Adjunction is opposed substitution. According to traditional views, phrasal movement can be either substitution to a specifier (A or A'-position) or phrasal adjunction. Adjunction was considered to be optional in nature as there was no apparent or explicit trigger: various movement to the clausal edge such as argument and adverb preposing to a position in between the overt complementizer and the subject were instances of phrasal adjunction to IP (Inflectional phrase). As of the late 1980s, economy principles started to gain ground and to play a central role in syntactic theory, leading to a conception of movement as a "last resort" strategy, applicable only when necessary to warrant well-formedness (Chomsky 1986b). This and other developments cast doubts on the adjunction process as a truly optional movement.

The ideas against phrasal adjunction go hand in hand with with the proposal of restrictive frameworks of phrase structure, such as Kayne's 1994 which runs counter to the possibility of phrasal adjunction (as an option formally distinct from specifier creation). The growing role of economy considerations within the minimalist program led researchers to pay more attention to the interpretative difference associated to preposing in terms of discourse-

informational properties. Such interpretative considerations invariably supported the view that no movement is really optional. Interpretative properties are associated to left-peripheral positions such as topicality, focus etc. Heads are said to be triggers or attractors in the sense that they are endowed with features that need to be interpreted. Some heads are null whereas some others are morphologically overt (Bilola 1992, 1995, 1997, Aboh 1998) and act as attractors, that is they attract phrases to local specifier positions. The ban on phrasal adjunction as the result of movement was extended to base-generated structures, with the major consequence of ruling out an adjunction analysis of adverbial positions in general. These significant developments in the syntactic landscape also offered formal support to the theory of adverbial positions in Cinque (1999), assuming adverbs to be licensed in specifier positions of dedicated heads of the inflectional system.

2.3. Cartography and minimalism

Cartography and minimalism are both theoretical approaches to syntactic structures of human languages even though they can also be applied to other research fields such as geography, mathematics, physics etc. While cartography has to do with the richness and complexity of syntactic structures, minimalism tries to simplify syntactic computations in terms of economy. In concrete terms, cartography is primarily concerned with the broad inventory of interpretable features by exploring the full representation of syntactic categories and by providing an impetus for detailed research into comparative morpho-syntax providing handy tools for expressing crosslinguistic variation and similarities. As mentioned in Cinque and Rizzi (2008), cartography endeavors “to draw maps as precise and detailed as possible of syntactic configurations”. The cornerstone of cartography lies in the study of functional categories, their number and their order (Shlonsky to appear).

Minimalism does not break away from the cartography enterprise although there exists a number of divergences between the two. As its name indicates, minimalism, as already mentioned, is economy-driven in that it tries as much as possible to reduce the number of principles that might hinder the process of language learning and acquisition. While cartography tends to multiply investigation within the arena of syntactic structures, minimalism aims at capturing the fundamental empirical results of syntactic theory through a set of descriptive tools which is substantially impoverished with respect to previous versions of the Principles and Parameters framework (Rizzi 2004: 6). Following Chomsky (1995) and subsequent work, syntactic structures become more and more minimized contrary to what prevailed some ten years back. The cartography enterprise seems to run counter to such an economy-driven approach because of the richness and multiplicity of syntactic representations. Overall despite of some apparent tensions between cartography and minimalism, it should be retained that none of them has reached the stage of a theory.

2.4. Current trends in the cartographic approach

Notwithstanding the fact that cartography takes its roots in most precious works in the history of the syntactic theory, it should however be known that cartography started gaining ground from Kayne’s 1994 *Antisymmetry of Syntax*.

The antisymmetry theory, as proposed by Kayne (1994), militates for a specifier – head-complement configuration within a projection and bans free/multiple adjunction and multiple specifiers as proposed in Chomsky (1995). The only possible configuration according to Kayne (1994) is the following:

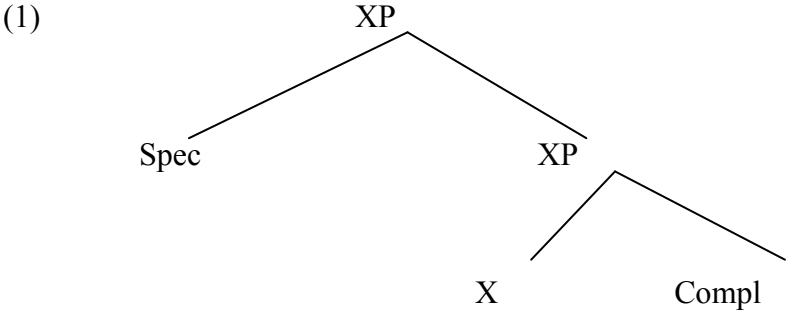

Two major ideas uphold the antisymmetry theory: the basic word order for all languages is SVO (Subject-Verb-Object) and modifiers must be specifiers.

That all languages display a basic SVO order or SOV requires a number of movement types for deriving the surface configurations.

Then came Rizzi’s 1997 split CP-Hypothesis and Laenzlinger’s 2005b layered DP.

In the rizzian system, the CP domain is full of functional heads, each with its own interpretative properties. According to Rizzi, the C-domain is delimited by two functional categories: Force (Chomsky 1995), denoting the illocutionary force or the clausal type (Cheng 1997) and Finiteness expressing a property related to tense and mood. Both topic and focus are substructures that explicitly signal certain discourse related properties along the following lines:

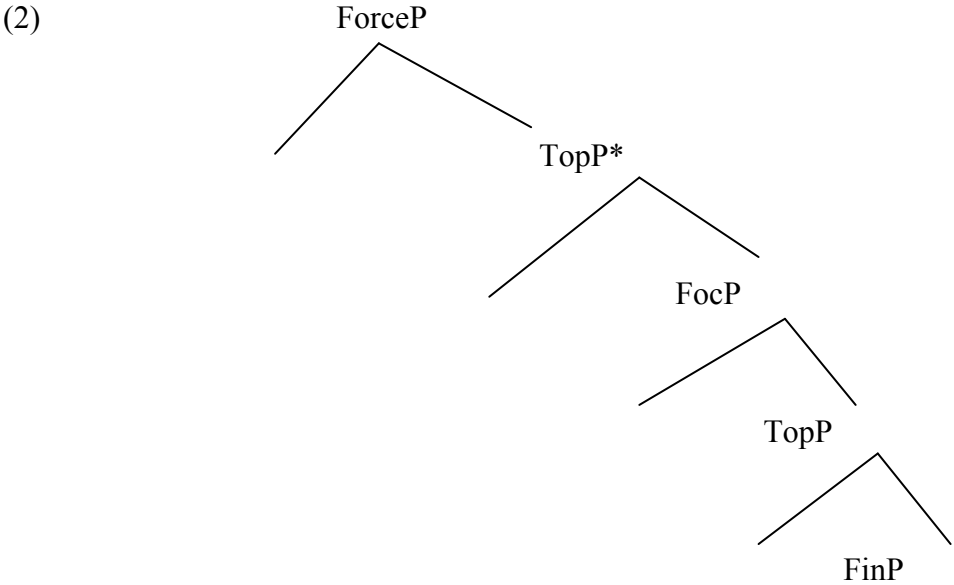

The phrase marker in (2) above shows that topic can be recursive whereas focus is consistent with the uniqueness principle (Rizzi 1997). While topic refers to old information

already mentioned in a previous discourse context, focus, on its part, refers to new information. (Radford 2004).

Based on Italian data, Rizzi (2001b) proposed another functional head called Int(errogative), which hosts the interrogative particle *se* “if” introduced in embedded yes/no questions. This interrogative particle is lower than the force marker *che* “that” as can be seen in Rizzi (2001b), and repeated here for expository reasons:

(3) FORCE...(TOP)*...INT (TOP*)...FOC (TOP*)...FIN...IP

Recall that *Fin* denotes finiteness; that is, it indicates whether a given verb is inflected for tense or not in a sentence. In Italian for instance, finiteness is phonetically realized as *di* (the equivalent of the preposition *for* in English) to indicate the finiteness status of a sentence (see Radford 2004).

In order to differentiate true topics i.e. referential expressions from other left-peripheral material denoting modification (adverbs and adverbials), Rizzi (2004b) proposed another functional projection with a null spell-out head called Modifier Phrase (ModP). This significant headway offered further support to Cinque (1999), assuming that adverbs be licensed in specifier positions of dedicated heads of the inflectional system (see also Rizzi 2004a). The cartographic approach is therefore viewed as being very instrumental in building up a typology of structural positions in the A’ system, by differentiating focus, topics (and other operators), and the left-peripheral adverbial adverbials.

In Laenzlinger (2005b), there is an internal DP projection called DetP or DefP in Puska’s and Ihsane (2001). This projection is paralleled with the clausal-layered structure in (2) and is made up of a number of functional projections for the DP-domain. The topmost external projections, which corresponds to Rizzi’s ForceP, is a deictic projection in Laenzlinger (2005 a, b)’s terms. In-between the two DPs, there are topic, focus and quantifiers projections. As can be seen in (3) below:

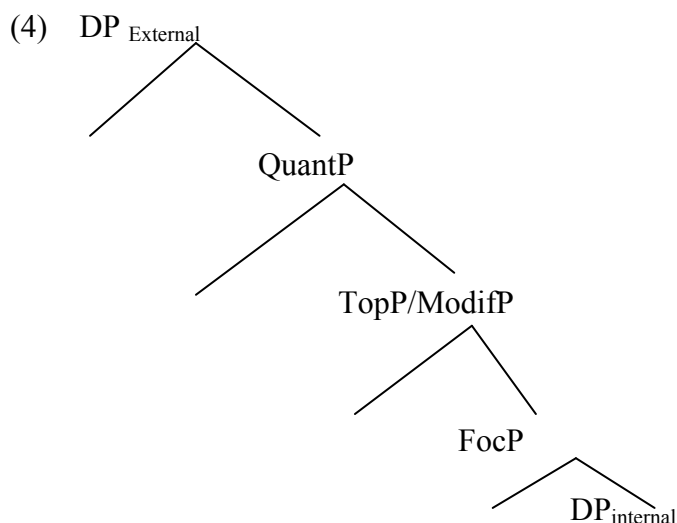

(4c)

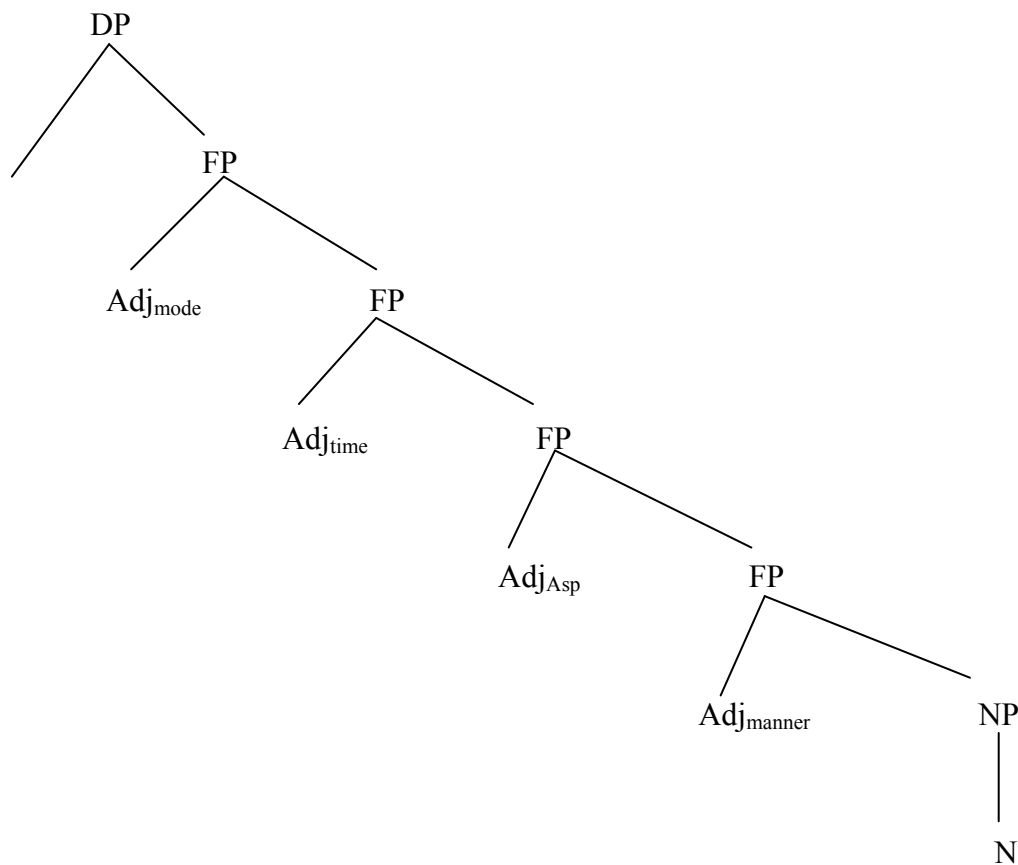

(5) Ordinal>Cardinal>Subjective

Comment>Evidential>Size>Length>Height>Speed>Depth>Width>Temperature>Wetness>Age>Shape>Color>Nationality>Origin>Material.

Following Sproat and Shi (1988), Cinque (2003, 2008) proposed a dual source for adjective within the noun phrase, by establishing the difference between direct modification of non-restrictive, non-intersective, modal etc. adjectives and indirect modification of restrictive, intersective, relative, etc. adjectives.

Cinque proposed that adjectives of the former class substitute for the specifier positions of (AP) of functional projections, whereas adjectives of the latter class are reduced to relative clauses along the lines of Alexiadou and Wilder (1998), Laenzlinger (2005b)'s proposal that attributive adjectives are specifiers of functional projections seems reliable for analyzing Tuki empirical material.

Cinque's (2010) analysis on adjectives attempts to derive the following generalizations:

- i- While APs in pre-nominal position in Romance are necessarily individual-level, nonrestrictive, modal, nonintersective, absolute, specificity-including, evaluative, rather than epistemic, and (plural) NP dependent...post-nominal APs in Germanic (when possible), generally exhibit the mirror-image order.

- ii- Post-nominal APs in Romance and pre-nominal in Germanic are systematically ambiguous.
- iii- The two pronominal readings of Germanic, and the two postnominal readings of Romance are ordered in a mirror-image fashion i.e. the AP in the outer position (leftmost in Germanic; rightmost in Romance) has the set of interpretations found (when that is possible), post nominally in Germanic, which derive, from a reduced relative clause source (for further details, see Cinque 2010).

2.5. The uniformity of syntactic structures

“Cartography is in line with the view that syntactic structures are uniform, locally simple and both necessarily and sufficient to represent the grammatical or functional information for semantic/ pragmatic” (Shlonsky, to appear). The basic idea is that phrases are endocentric in nature, that is, each phrase is a projection of a zero level category called a head which projects a maximal projection, an intermediate category (probably) and a specifier. This configuration, known as X-bar theory, has received much credit in the representation of syntactic structures. Adjunction and multiple specifiers for a single head have also received a good number of experiments, but have been proven inadequate due to the fact that they wrongly predict various ways of projecting syntactic structures. This approach has been banned to the advantage of substitution processes. In other words, instead of a multiple specifiers and an adjunction approach as advocated in Chomsky (1995), Kaynes’s (1994) antisymmetry, Cinque (1999) among other things that each phrase is a projection of a head word. So that, the core structural relations defined by X-bar theory seem to be sufficient to characterize syntactic structures.

2.6. Conclusion

In sum, cartography is a syntactic approach and is very promising and appealing as it enables researchers to draw syntactic maps as precise and detailed as possible. It scrutinizes the internal structure of functional categories in their richness and complexity by providing an elegant and satisfactory analysis of syntactic categories. Cartography is not opposed to minimalism in spite of some apparent tension that seems to cast doubt on the way they can both be handled.

CHAPTER TWO

Phonetics and Phonology

2.1 Vowels

Tuki distinguishes the following seven vowels: / i, e, ε, u, o, ɔ, a/

The table of surface contrastive vowels

i u
 e o
 ε ɔ
 a

	Initial position	Medial position	Final position
/i/	inɔ́ɔɔ “finger”	miná “blood”	matí “spit”
/e/		otémá “heart”	
/ε/		atété “bone”	asene “fight”
/u/		wurɔɔ “old age”	mutu “man, person”
/ɔ/	ɔɔɔɔ “to work”	nɔrí “rope, cord”	manó “disease”
/o/	osumbu “river”		
/a/	atoki “greed”	mána “sky, heaven”	pána “plate, dish”

2.2. Consonants

The consonant inventory is provided in the following table:

The table of surface contrastive consonants

p t k kp
 b d g
 mb nt nk
 f nd ng mgb

	v	ts	č
		dz	
		ndz	
		s	
m		n	ny
w		r	y
mbw			

In this work, the following orthographic conventions are adopted:

[ɲ] = ny: manya “food”

[ŋ] = ng: ngombɛ “canoo”

[ŋɡ] = ng : ngángú “luck, chance”

[tʃ] = c: cwí “fish”

[j] = y: yamúwa “wound, injury”

2.3. Syllable structure and phonotactic constraints

In this language, open and closed syllables alike are attested:

(1)

Open syllables

Closed syllables

Nû “I, me”

tsuk “quiet”

Ngo “lion”

Consonant clusters are allowed, but their behaviors are regulated by phonotactic constraints. The following syllable types are allowed in Tuki:

(2)

V é (interjection); o.nyá “to eat”

VV éé (that); oó “yes”

CV nû “I, me”; mi.tsi.nó “abandon”; ndzá.ná “forest”; i.mgbé.mé “lion”

CVV waá “year”; wɔ.tɔɔ “to agree”; máa.bɔ “wine”; wu.mbaa.na “to arrest”; o.ndzíí “seat”

CVC tsuk “quiet”

In Tuki, as in many bantu languages (cf. Nurse and Philippson 2003), a consonant can be made up of several segments (up to three in Tuki: /mb, mbw, nd, ts, dz, ndz, nk, ng, kp, mgb/). For instance, in the following word, *mbwá* “dog” the consonant is /mbw/. Now, what phonotactic constraints regulate syllable structure formation? In word initial position, more often than not, when the consonant is made up of three segments, the first segment must be the nasal /m/ or /n/: /mbw, mgb, ndz/ (examples include *mbwá* “dog (s)”, *mgbana* “whip”, *ndzámú* ‘meat’). So, informally speaking, within a three segment consonant, the first segment must be /m/ or /n/, the second one must be either /b/, /d/ or /g/, and the third one will be either /w/, /b/ or /z/.

In Tuki, there are 8 consonants that are made up of two segments: /mb, nt, nd, ts, dz, nk, ng, kp/. The two segments that make up these two consonants are distributed as follows:

(3)

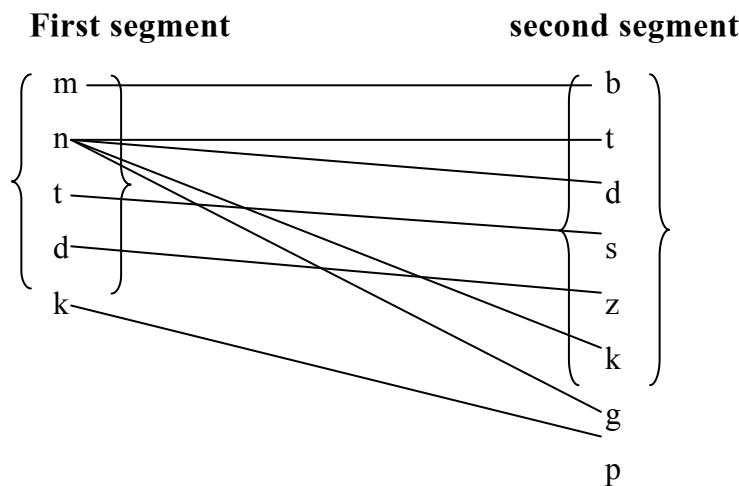

When a consonant contains two segments, this language prefers the nasals /m/ and /n/ to be the first segments: /mb, nt, nd, nk, ng/. The nasals are closely followed, in order of preference, by the alveolar and velar plosives respectively /t, d/ and /k/: /ts, dz/ and /kp/.

The consonants that contain two segments are called doubly articulated sounds (cf. Mutaka and Tamanji 2000: 46); These two researchers argue that “to explain the articulation of these doubly articulated sounds, one should bear in mind that this is the result of having different places of articulation in the vocal tract. [Based on] Sagey (1986a) Halle observed that, because of different places of articulation, there will be multiply articulated segments in languages.” This is illustrated by the following data from Tuki:

(4)

- Labial-nasal: /mb/, *mbasa* “corn”
- Corono-nasal: /nt/, *ntumu* “behavior”
- /nd/, *ndamba* “ball”

- Corono-velar: /nk/, *nkata* “examinations”
 /ng/, *ngagáá* “medicine man”
- Corono-alveolar: /ts/, *tsí* “earth”
 (affricates) /dz/, *odzomena* “to sit”

Bear in mind that the nasal and consonant sequences /mb, nt, nd, ng.../ are usually considered to be homorganic. Interestingly, those that are heterorganic such as /md, mk/ are not attested in the language.

2.4. Syllable structure and morpheme structure

Tuki words in general observe the phonotactic constraints of the language. Morphemes, however, can disregard this generalization. As argued by Mchombo (2004), “[...] in Bantu languages in general, there is non-isomorphism between the morphological organization of the verb stem and the syllable structure requirements.” In Tuki, the verb root or radical usually ends in a consonant that is followed by what is called a final vowel (FV). For illustration, consider the following verbs:

(5)

a. o- ding- a
 inf. stem FV
 love
 “to love/ like”

b.o- bang- a
 inf. stem FV
 cry
 “to cry”

c.w- ɔb- ɔ
 inf. stem FV
 cut/wound
 “to cut (a tree)/wound (somebody)”

The above data show that the final vowel is a separate morpheme, just as the infinitive marker that precedes the verb stem. In (c) above, |o| is transformed into a glide, [w], because it precedes a vowel, [ɔ]. The verb extensions, such as the causative, applicative, reciprocal, have a –VC- structure:

(6)

a. Mbárá a- bang- ey- a- ḿ Putá
Mbara SM cry CAUS FV Inc. Puta
“Mbara causes Puta to cry”

b. Mbárá a- ding- en- a- ḿ Putá mútu
Mbara SM loves APPL FV Inc. Puta man
“Mbara loves a man for Puta”
“Mbara seduces a man for Puta”

c. Mbárá na Putá va- ding- an- a- ḿ
Mbara and Puta SM love REC FV Inc.
“Mbara and Puta love each other”

d. Mbárá na Putá vó- b- ón- ɔ- ḿ
Mbara and Puta SM wound REC FV Inc.
“Mbara and Puta wound each other”

The verb extensions all have –VC- organization. Mchombo (2004:14) rightly points out that “when the final vowel is added then there is resyllabification, which restores conformity to the phonotactics of the language”. Furthermore, the (d) example above shows that vowel harmony can operate when the verb extension is affixed to the verb stem. As opposed to the (c) example where the reciprocal is |an|, in (d) it is |on|: the [a] has changed into [ɔ]. Bear in mind that the stem vowel here is [ɔ] (w-ɔb-ɔ). So it seems to be the case that vowel harmony spreads from the stem vowel to the vowel of the extension morpheme.

Having said above that the verbal extensions all have a – VC- structure, it follows that they are different from other markers that are prefixed to the verb stem; markers such as the subject markers, tense markers and aspect markers. The subject markers have a diverse structural organization: -C-, -V-, or –CV-, as illustrated by the following paradigm (the verb *odinga* “to love/ like” is conjugated in the present tense):

(7)

a. nû n- ding- a- ḿ
I SM love FV Inc.
“I love”

- b. mamú ó- ding- a- m´
 you SM love FV Inc.
 “you love”
- c. ómwéné a- ding- a- m´
 he/she SM love FV Inc.
 “he/she loves”
- d. vitsú tú- ding- a- m´
 we SM love FV Inc.
 “we love”
- e. vinú nu- ding- a- m´
 you SM love FV Inc.
 “you love”
- f. vámwéné va- ding- a- m
 they SM love FV Inc.
 “they love”

The tense markers all have a –CV- organization, as the following table shows:

	Tense markers	Syllable organization
Past tense one	mú	-CV-
Past tense two	má	-CV-
Past tense three	ma	-CV-
Future tense one	nû	-CV-
Future tense two	mú	-CV-

As for the aspect markers, they have –C-, -CV-, -CV.CV-, -CVV-, -VC- organizations, as evidenced by the following table:

	Aspect markers	Syllable organization
Incompletive aspect	m	-C
Habitual aspect	fû	-CV-
Retrospective aspect	rû	-CV-
Progressive aspect	kúú	-CV.CV-
Semelrepetitive or semeliterative aspect	dzoo or dzu	-CVV- -CV-
Anterior aspect	múú	-CV.CV-
Attenuative aspect	et	-VC-
Repetitive aspect	an	-VC-
Continuative aspect	róo	-CVV-
Cessative aspect	dzú	-CV-

In the next chapter, more details will be provided about the function and semantics of tense and aspect markers.

2.5. Tone

This section is an excerpt of Hyman and Biloa (1992:105-109). In this section, we present the basic properties of tone in the Kombe dialect of Tuki. Most of our discussion centers around the verbal tonology, which in many respects resembles that of the Tiv system, as described by Pulleyblank (1985).

On the surface, Tuki has H, L and downstepped ¹H tone. While HL falling tones do occur, LH rising tones are much rarer and appear never to occur on a single mora. As we shall discuss below, only vowels (henceforth “moras”) can carry tone in Tuki. Since there is a vowel length contrast in Tuki, CVV syllables count as two moras, while CV syllables count as one. There are no consonant clusters in Tuki other than NC sequence we will be treating below.

We begin by establishing that there are two tonal classes of infinitives in Tuki:

(8)

a. ò-mwà	“to shave”	b. ò-nyá	“to eat”
ò-byà	“to bring”	ò-fá	“to give”
ò-dĩngà	“to love”	ò-túmâ	“to send”
ò-gùrà	“to crush”	ò-dángâ	“to lose”
ò-ryàmànà	“to dream”	ò-bángénà	“to break”
ò-fùnùnà	“to wake up (tr)”	ò-báráfyà	“to forget”

In Tuki, only heavy syllables are of the type CVV. CVC and CV syllables count as one mora.

The forms in (8) begin with an infinitive prefix 0- and the stem is comprised of one, two or three stem syllables. They all end in an inflectional final vowel morpheme –a which we shall not separate from the base by a hyphen. All tones are L in (8a). By contrast, there are up to two H tones in the forms in (8b). To account for this opposition, we recognize an underlying L vs H opposition on verb roots, as in (9).

(9)

a.	-mw-	-by-	-ding-	-gur-	-ryaman-	-funun-
	L	L	L	L	L	L
b.	-ny-	-f-	-tum-	-dang-	-bangen-	-barafy-
	H	H	H	H	H	H

In the case of the L tone roots in (9a), the low tone links to the first vowel of the verb stem. Both the infinitive prefix 0- and any subsequent stem vowels receive L by default. In the case of the H tone roots in (9b), the stem tones are derived as in (10).

(10)

a.	-nya	-tuma	-bangena	
	H	H	H	UNDERLYING
b.	-nya	-tuma	-bangena	
	H	H	H	TONE LINKING
c.	-tuma	-bangena		
	∨	∨		
	H	H		H TONE SPREADING
d.			bangena	
			∨	

H L DEFAULT L TONE

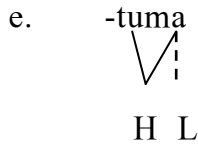

BOUNDARY L% TONE

As seen in (10a), these verb stems begin with an unlinked H tone attributable to their verb root. The unlinked H links to the first vowel of each verb stem in (10b), followed by the application in (10c) of the H tone spreading (HTS) rule in (11).

(11)

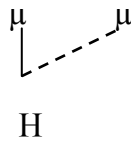

A H spreads onto a following mora. In (10d) default L tone is assigned in the one case where a mora remains toneless. Finally, in (10e), a L boundary tone (L%) links to a prepausal mora whose H tone is also linked to the penultimate mora, as in (12).

(12)

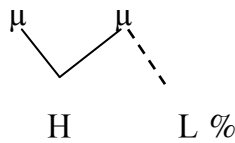

In all other cases, the prepausal L% is assumed to be present, but unable to link.

In Tuki, different verb forms may have either no tone other than on their root, as in the infinitive, or they may in addition have a H suffixal tone. A tense which falls into the latter category is the distant past (P3), exemplified in (13).

(13)

a. à-mà-mwà	“he shaved”	b. à- mà-nyá	“he ate”
à- mà-byà	“he brought”	à- mà-fá	“he gave”
à- mà- dingá	“he loved”	à- mà-túmâ	“he sent”
à- mà-gurá	“he crushed”	à- mà-dángâ	“he lost”
à- mà-ryàmàná	“he dreamed”	à- mà-bángénâ	“he broke”
à- mà-fùnùná	“he woke up (tr)”	à- mà-bárafyâ	“he forgot”

In (13a) we see that the L tone verb stems acquire a H on their second mora (M2). In the case of monosyllabic verb stems, the assignment of an M2 H tone creates a rising tone. If the underlying stems are /mu-a/ and /bi-a/, the M2 assignment simply precedes vowels coalescence. If, on the other hand, vowel coalescence applies first (with shortening), the M2 H is assigned to the one L tone mora that remains. The remaining forms in (13a) straightforwardly receive an M2 H tone which by HTS will spread to the following mora, if there is one. Again, the monosyllabic forms are unclear: either the suffixal H has been assigned to the M2 prior to vowel coalescence; or, if vowel coalescence applies first (along with vowel shortening), the suffixal H is simply assigned to the one mora that remains. Sample derivations are given in (14).

(14)

a.	dinga	ryamana	tuma	bangena	
	L	L	H	H	UNDERLYING
b.	dinga	ryamana	tuma	bangena	
	⋮	⋮	⋮	⋮	
	L	L	H	H	TONE LINKING
c.	dinga	ryamana	tuma	bangena	
	L H	L H	H H	H H	H ASSIGNMENT
d.	dinga	ryamana	tuma	bangena	
	⋮	⋮	⋮	⋮	
	L H	L H	H H	H H	M2 TONE LINKING
e.		ryamana		bangena	
		/		/	
		L H		H H	HTS
f.		ryamana		bangena	
		/ \		/ \	
		L H L		H H L	L% TONE

We have thus far established the rule of HTS which applies pervasively in Tuki. One additional feature of the Tuki tone system which frequently interacts with HTS is the downstepping of H tones. To illustrate downstep, we turn to the present tense, exemplified with the L tone subject prefix -**ǎ** ‘3rd person sg. human’ in (15).

(15)

a. à- mwà- ḿ	“s/he shaves”	b. à- nya- ḿ	“s/he eats”
à- byà- ḿ	“s/he brings”	à- fá- ḿ	“s/he gives”
à- dǐngà- ḿ	“s/he loves”	à- túmá- ḿ	“s/he sends”
à- gùrà- ḿ	“s/he crushes”	à- dǎngâ- ḿ	“s/he loses”
à- ryàmà- ḿ	“s/he dreams”	à- bǎngénà- ḿ	“s/he breaks”
à- fùnùnà- ḿ	“s/he wakes up (tr)”	à- bǎráfyà- ḿ	“s/he forgets”

This tense is marked by a suffix –m which is the only case of a tone prelinked to a consonant in the language. In (15) all of the verb tones are L except for the H tone of –m. In (15), the H of the verb root spreads to the right as we have already seen in the infinitive and past tense forms in (8) and (13) respectively. This is followed by the assignment of default L tone. The particularity of HTS in Tuki is that it spreads once. Sample derivations are given in (16).

(16)

a.	dinga	ryamana	tuma	bangena	
	L	L	H	H	UNDERLYING
b.	dinga	ryamana	tuma	bangena	
	⋮	⋮	⋮	⋮	
	L	L	H	H	tone linking
c.			tuma	bangena	
			⋮	⋮	
			H	H	HTS
d.	dinga	ryamana		bangena	
				∨	
	⋮	⋮		⋮	
	L L	L L L		H L	DEFAULT L
e.	dinga-m	ryamana-m	tuma-m	bangena-m	
	∨	∨	∨	∨	
	L H	L H	H H	H L H	Stratum2 suffixation

As seen, default L is assigned to all forms except for bimoraic *-tuma-*, where HTS has filled the only underspecified mora.

Now consider the corresponding present tense forms with the H tone subject prefix *-vá* ‘they’ :

(17)

a. <i>vá- mwà-¹m</i> “they shave”	b. <i>vá - nyá- m</i> “they eat”
<i>vá- byà- ¹m</i> “they bring”	<i>vá - fá- m</i> “they give”
<i>vá- dǐngà- m</i> “they love”	<i>vá - túmá- m</i> “they send”
<i>vá- gùrà- m</i> “they crushe”	<i>vá - dǎngá- m</i> “they lose”
<i>vá- ryàmànà- m</i> “they dream”	<i>vá - bǎngénà- m</i> “they break”
<i>vá- fùnùnà- m</i> “they wake up (tr)”	<i>vá - bǎráfyà- m</i> “they forget”

The H verb stems in (17) have exactly the same tone as those seen in (16b). In (17a), however, the H of the subject prefix *vá*-spreads onto the initial L mora of the L tone verb stems. In all forms the L is delinked. It thus should be clear that HTS can apply in one of the two ways indicated in (11): (i) within the stem, the H spreads onto a following toneless mora; (ii) outside the stem, the H spreads onto a following L mora, delinking that L. When the delinked L is immediately followed by a L, it has no effect. Where, however, the delinked L is immediately followed by a H, deriving the configuration in (18), the result is a H-¹H sequence, i.e. a H followed by a downstepped H, as attested in many African languages.

(18)

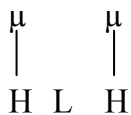

It is worth defending our view that the HTS is accompanied by the delinking of L. The alternative, that a HL contour automatically decontours when followed by another tone is falsified by data such as those from the near future (F1) tense in (19).

(19)

a. <i>à-nú- mwà-m</i> “he will shave”	b. <i>à- nû- nyá- m</i> “he will eat”
<i>à- nú-byà- m</i> “he will bring”	<i>à- nû-fá - m</i> “he will give”
<i>à- nú-dǐngà- m</i> “he will love”	<i>à- nû- túmá- m</i> “he will send”
<i>à- nú- gùrà- m</i> “he will crushe”	<i>à- nû-dǎngâ- m</i> “he will lose”
<i>à- nú- ryàmànà- m</i> “he will dream”	<i>à- nû-bǎngénà- m</i> “he will break”
<i>à- nú- fùnùnà- m</i> “he will wake up (tr)”	<i>à- nû- bǎráfyà- m</i> “he will forget”

This tense is marked by the prefix **-nû-**, which is underlyingly linked to a HL sequence. As seen in (19a), the L is “absorbed” into the following L by the contour simplification process in (20).

(20)

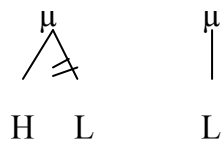

On the other hand, contour simplification does not take place in (19), where **-nû-** is followed by a H tone. We thus assume that contour simplification is not automatic in Tuki, but rather should be built into the HTS rule, as we have done.

2.6. Minimal pairs

The tones L and H are used in this language to distinguish minimal pairs. As the following numerous examples illustrate, the meanings of the words are differentiated by the distinctive use of tones.

(21)

- | | |
|---------|--|
| ò-mw- á | “to be heavy; to bake a cucumber cake” |
| ò-mw- à | “to shave” |

(22)

- | | |
|---------|------------------------------|
| ò-fw- á | “to shut off, to extinguish” |
| ò-fw- à | “to roast” |

(23)

- | | |
|-----------|-----------------------------|
| ò-táng- á | “to share” |
| ò-tàng- à | “to be wise or intelligent” |

(24)

- | | |
|----------|--------------------------|
| ò-sós- ó | “to suck” |
| ò-sòs- ò | “to search, to look for” |

(25)

- | | |
|----------|------------|
| ò-núm- á | “to bite” |
| ò-nùm- à | “to shine” |

(26)

- | | |
|--------|--------------|
| ò-n- ó | “to be sick” |
|--------|--------------|

ò-n- ò	“to throw”
(27)	
w-ùb-à	“to fail”
w-úb-á	“to hear, to listen”
(28)	
w-àt-à	“to deliver”
w-át-á	“to break into pieces”
(29)	
ò-nyòw-à	“to mix and press”
ò-nyów-á	“to be full”
(30)	
ò-fàf-à	“to remove, to tear off”
ò-fáf-á	“to be slim”
(31)	
ò-bàn-à	“to count”
ò-bán-á	“to marry, to wed”
(32)	
ò-tà-nà	“umbrella”
ò-tá-ná	“to take a rendez-vous, to promise”
(33)	
ò-fòw-à	“to rest”
ò-fów-á	“to build”
(34)	
ò-byàn-à	“to wear, to carry several times”
ò-byán-á	“to give birth”
(35)	
ò-sàk-ì	“to cut into pieces”
ò-sák-í	“to chat, to have a conversation”
(36)	
ò-ràm-à	“to pull”
ò-rám-á	“to load a gun; to ready a weapon”
(37)	
ò-gîr-à	“to be black”

ò-gír-á	“to wait (for)”
(38)	
ò-bàng-à	“to cry”
ò-báng-á	“to break”
(39)	
ò-yàn-à	“must/have to”
ò-yaàn-á	“to pay”
(40)	
ò-bàr-à	“to weed out, to clear a field”
ò-bár-á	“to pull out”
(41)	
ò-ny-à	“to paint”
ò-ny-á	“to eat”
(42)	
ò-tír-à	“to write”
ò-tír-à	“to wise, clean”
(43)	
Kùtù kùtù	“please, please”
Kútú	“c

CHAPTER THREE

Clause structure

Introduction

In this chapter, the structure of the Tuki clause is examined descriptively. This description will lay foundations for on-going discussions in subsequent chapters. More precisely, this chapter aims at taking a synoptic look, making a thematic survey of and familiarizing the reader with some of the major constructions attested in the language and that will be dealt with descriptively and theoretically in the following chapters: verb morphology, basic word order, the internal structure of inflexion, well-formedness of a zero subject, wh-movement, predicate cleft constructions, simple sentences, the complex sentence, question formation, focalization, relativization, topicalization, resumptive pronouns, anaphora and binding.

3.1. VERB MORPHOLOGY

3.1.1 Tense and Aspect

Feature Analysis and Restrictions

Comrie (1976) defines ‘tense’ as ‘a grammaticalized location in time’. Bearing in mind this definition, we note that Tuki contains six basic tenses: Past III (P3), Past II (2), Past I or Today past (P1), Present (PO), Future I (F1) and Future II (F2). We will devote a section to these tenses. We will briefly illustrate here the tenses mentioned above to give the reader a vague idea of what is going on in the following examples:

(1) Past II

Mbára a- ma- nyá mányá

Mbara SM P3 eat food

‘Mbara ate the food (some time ago)’

(2) Past II

Mbára a – má – nyá mányá idzó

Mbara SM P2 eat food yesterday

‘Mbara ate the food yesterday’

(3) Past I

Mbárá a- mu- nyá mányá íbisi

Mbara SM P1 eat foot morning

‘Mbara ate the food this morning’.

(4) Present

Kúré a- nyá- mí mányá

Tortoise SM eat incompl. food

‘The tortoise eats the food’.

(5) Future I

Kúré a- nú- nyá -mí mányá

Tortoise SM F1 eat incompl. food

‘The tortoise will eat the food’

(6) Future II

Kúré a- mú- nyá- mí mányá

Tortoise SM F2 eat incompl. Food

‘‘The tortoise will eat the food’’

Notice that P1, PO and F1 refer to actions occurring today. The tense system of Tuki seems to involve location in time: [past] [future], and [today]. Given below is the feature system of the Tuki.

Feature System

(7) Tenses

	P3	P2	P1	PO	F1	F2
Features						
[Past]	+	+	+	-	-	-
[Future]	-	-	-	-	+	+
[Today]	-	-	+	+	+	-

The above tableau reveals that the Tuki tense system requires the following co-occurrence constraints:

(8) if [+ Past], then [- Future]

(9) if [+ Future], then [-Past]

These two constraints can be collapsed into a single one:

(10) - [+ Past]

[+ Future]

The above negative redundancy condition prohibits the co-occurrence of [+ Past] and [+ Future]. But [-Past] and [-Future] can appear together. The present tense (P), for instance, is characterized as [- Future] [- past].

Up to now, we have said nothing about aspect in Tuki. How do tense and aspect interact in the language? The basic features of the aspectual system are [completive] and [habitual]. Chapter four is devoted to a detailed study of aspect in Tuki. Given below is a table characterizing the interaction between tense and aspect.

(11) Interaction of Tense and Aspect

	P3	P2	P1	PO	F1	F2
Tenses						
Features						
[Past]	+	+	+	-	-	-

[Future]	+	+	+	-	-	-
[Today]	+	+	+	-	-	-
[Completive]	+	+	+	-	-	-
[Habitual]	-	-	-	+	+	-

From the above table, we can derive the following constraints:

(12) if [+ completive], then [- habitual]

(13) if [+ habitual], then [- completive]

We can collapse (12) and (13) to obtain a condition stipulating that [+ completive] and [+ habitual] may never cooccur:

(14) – [+ completive]

[+ habitual]

However [- completive] and [- habitual] may occur. F2 is a combination of [- habitual] and [- completive].

So far, we have not touched on the topic of negation.

Every Tuki tense can virtually be modified by the feature [Negative]. That is to say, the feature Negative may show up with any of the feature combinations examined above:

(15) a. Mbárá a- má- kúsa mátúwa

Mbara SM P2 buy car

‘‘Mbara bought a car’’

b. Mbárá a- tá- má- kúsa mátúwa

Mbara SM Neg P2 buy car

‘‘Mbara did not buy a car’’

3.1.2. Verbs

In this section, we want to consider the structure of the verb in Tuki. This includes prefixes and suffixes.

3.1.2.1. Verb prefixes

Tuki infinitive verb prefixes at the surface level of representation are two ([o] and [w]):

- (16) a. Okpetá ‘to shoot’
 b. osongo ‘to make love’
- (17) a. wuba ‘to fail’
 b. wana ‘to share’

If we assume that there are two infinitive verb prefixes in Tuki, [o] and [w], what then determines their distribution? Consider the following lists of Tuki infinitive verbs which are o-initial and w- initial:

- (18) a. ofiya ‘to burn’
 b. otúmá ‘to send’
 c. obená ‘to hate’
 d. omándzúna ‘to break’
 e. onema ‘to plant’
- (19) a. wadza ‘to chew’
 b. wumbáana ‘to catch’
 c. wono ‘to laugh’
 d. wesá ‘to scratch’
 e. winá ‘to feel’

All o- initial verbs have consonant – initial roots, while w- prefixed verbs have vowel-initial roots. Apparently, [o] always appears before consonants, whereas [w] always shows up before vowels in Tuki verbs.

Let us assume that the prefix of all Tuki verbs is underlyingly /o/, and this /o/ undergoes glide formation every time it appears before a vowel- initial root. The variation in Tuki infinitive verb prefixes at the surface level of representation can be handled by the following phonological rule:

(20) Glide formation

V-----> C/[-----V

or

o-----> w/[-----V

3.1.3. Reflexivization

Virtually, any Tuki verb can become reflexive by prefixing to the root a morpheme / a-/ meaning ‘self’. Consider the following paradigm of verbs:

- (21) a. odinga ‘to love’
 b. obènà ‘to hate’
 c. obèmà ‘to stab’
 d. orùwà ‘to name’

If we prefix the reflexive morpheme / a- / to the root of the verbs in (21), they automatically become reflexive verbs:

- (22) a. waádínga ‘to love oneself’
 b. waábéna ‘to hate oneself’
 c. waábéma ‘to stab oneself’
 d. waárúwa ‘to name oneself’

The infinitive prefix / o-/ can occur with the verb in (21) :

- (23) a. owádínga ‘to love oneself’
 b. owábéna ‘to hate oneself’
 c. owábéma ‘to stab oneself’
 d. owárúwa ‘to name oneself’

Let us assume that the underlying representation of verbs cited in (23) are the following:

- (24) a. /odínga/ ‘to love’
 b. /obéna/ ‘to hate’
 c. /obéma/ ‘to stab’
 d. /orúwa/ ‘to name’

We have assumed that verb reflexivization in Tuki is done via prefixation of /a-/ to verb root. (25) shows the derivations of reflexive verbs presented in (23) and (24) :

- (25) a. o + a + díng + a -----> owádínga
 prefix refl. root final V.
 b. o + a + ben + a -----> owábéna
 c. o + a + bem + a-----> owábéma
 d. o + a + ruw + ruw + à -----> owárúwa

(23) and (24) seem to suggest that the infinitive prefix / o-/ is optional at surface structure. An optional rule will handle the case:

- (26) V ----->o/ [----- V

(26) Informally states that /o-/ may delete word initially before /w/.

Notice that the [w] shows up only in infinitives. This indicates that the reflexive is really /a/. Thus with the infinitive prefix being /o/, one gets /o/ + /a/ becoming /waa/ (with compensatory lengthening).

The [w] does not occur elsewhere. For instance, when the reflexive is preceded by a subject marker as in Mbara a a dingam ‘Mbara loves himself’, the [w] is persona non grata. Recall that owadinga is the equivalent of waadinga. In owadinga, /o/ is the infinitive prefix while /a/ is the reflexive. Thus /o+ a/ can become [owa-] by w- epenthesis or [waa-] by gliding + compensatory lengthening.

Let us now consider verbs with vowel- initial roots:

- (27) a. wuná ‘to kill’
 b. wená ‘to see’
 c. wobo ‘to wound’
 d. wodza ‘to purge’

To achieve reflexivization, let us prefix the morpheme /a- / to the root of each of the above verbs:

- (28) a. o + a + ún + a ----- > owáwúná
 prefix refl. Root final v ‘to kill oneself’
 b. o + a + ob + o ----- > owáwóbo
 ‘to wound oneself’
 c. o + a + én + a ----- > owáwéna
 ‘to see oneself’
 d. o + a + ódz + a ----- > owáwódza
 ‘to purge oneself’

Since the infinitive marker / o-/ is optional in reflexive verbs, the latter can occur without the former:

- (29) a. waáwúná ‘to kill oneself’
 b. waáwéná ‘to see oneself’
 c. waáwóbo ‘to wound oneself’

d. waáwódza ‘to purge oneself’

3.1.4. Verb suffixes

Two vowels qualify for the final position in Tuki infinitive verbs (/a/ and /o/):

(30) a. oráméya ‘to lick’

b. osaruna ‘to tear’

c. ogarima ‘to gamble’

(31) a. woto ‘to groan, moan’

b. orondo ‘to treat, to nurse’

c. okónó ‘to fold, to bend’

/a / and /o/ are the only vowels that you can find in final position of Tuki infinitive verbs.

We have already seen that the suffix /-m/ usually means incomplete aspect and that it occurs in the present tense in the future tense.

3.1.5. Reciprocals

There is another verb suffix / -na / which, when added to a certain class of verbs, conveys the meaning of the English anaphor ‘each other’. The morpheme /-na/ is added to the verb, thereby allowing this one to have the meaning of the reciprocal. Thus the verb ‘odingà’ which means ‘to love’ becomes, when /-na/ is suffixed, ‘odingàná’ ‘to love each other’. Those verbs which can become reciprocals require two thematic roles:

(32) Mbárá_i na Putá_j vá dǐngá-ná_{i + j} -m

Mbara and Puta SM love each other incompl.

‘Mbara and Puta love each other’

3.1.6. Causative verbs

Tuki has a suffix which triggers causative formation: /iy/. The suffix /iy/, when attached to the root of a verb (before the final vowel) makes the latter causative. After the

morphology has applied, there is a phonological rule which lowers / I / when it is preceded by a non-high vowel: / o / or / a / or / i / becomes [e] when the immediately preceding vowel is / a / or / o /. This is the rule:

(33) V -----> [- high] / V C
 + high [- low] - high
 - back + back

Rule (33) will apply to the forms in (34), while the forms in (35) undergo no phonological change after the morphology has applied.

- (34) a. obanga “to cry”
 b. wono “to laugh”
 c. obwándá “to turn”
 d. odanga “to get lost”

Causatives

- a. obangeya “to make cry”
 b. woneya “to make laugh”
 c. obwándéya ‘to make turn’
 d. odángéya ‘to make s.o. get lost’
- (35) a. oduma ‘to fall’
 b. opuma ‘to be clean’
 c. ogira ‘to be black’
 d. ogúná ‘to grow’

Causatives

- a. odumiya ‘to make fall’
 b. opumiya ‘to clean, to whiten’

c. ogiriya 'to blacken'

d. ogúniya 'to make grow'

3.1.7. Subject markers

The subject markers accompanying subjects are the following in Tuki:

(36) N- 1st pers. Singular

O- 2nd

a - 3rd

tu - 1st pers. pl.

nu – 2nd

va- 3rd

Since Tuki is a noun class language, subject markers agree in noun class with the subject (be it a nominal NP or a personal pronoun).

The following subject markers for all noun classes are used in expressions of the form: 'X + V...' where X is the logical subject and V the conjugated verb accompanying it. In each case, we provide to the left the 3rd person singular and 3rd person plural of subject markers, and to the right the singular and plural form of nouns that the subject may stand for.

(37) Class 1/2

3rd sg. a- mutu 'man'

3rd pl. vá- vatu 'men'

Class 3/4

3rd sg. o- onguru 'foot'

3rd pl. f- inguru 'feet'

Class 3a / 4a

3 rd sg.	a-	nkúnkúma	‘chief’
3 rd pl.	vá-	vankúnkúma	‘chiefs’

Class 5/6

3 rd sg.	nú-	isútú	‘belly’
3 rd pl.	mú-	musutu	‘bellies’

Class 5 / 6 a

3 rd sg. And pl.	má-	matí	‘saliva’
-----------------------------	-----	------	----------

Class 7/8

3 rd sg.	i-	ikundá	‘bed’
3 rd pl.	ví-	vikundá	‘beds’

Class 9 /10

3 rd sg.	i-	ndone	‘cow’
3 rd pl.	í-	ndone	‘cows’

Class 11 / 6 a

3 rd sg.	i-	pandu	‘place’
3 rd pl.	í-	pandu	‘places’

Class 11 /13

3 rd sg.	no-	nu-	noné	‘leaf’ / nùgwa	‘death’
3 rd pl.	tó-	tú-	toné	‘leafs/ tùgwa	‘deaths’

Class 14/ 6a

3 rd sg.	o-	wusí	‘day’
3 rd pl.	ma-	masí	‘days’

Class 19 / 18

3rd sg. i- ikara ‘mat’

3rd pl. mu- mukara ‘mats’

Class 3

3rd sg. a- or o- orese ‘rice’

Class 6 a onguná “sun”

3rd sg. ma- manonoó ‘work’

Class 8

vi- vita ‘war (s)’

vibufa ‘vegetable (s)’

Class 9

i- mutu ‘body’

Class 10

i- inwíi ‘smoke’

Class 18

ma- manó ‘disease (s)’

Exceptional genders

Class 5 / 13

3rd sg. i- toki ‘throat’

3rd pl. ví- vitoki ‘throats’

Class 3/6

3rd sg. o- otsó ‘ear’

3rd pl. í atsó ‘ears’

Class 4, 10/ 6 a

3 rd sg.	i-	ifoó	‘pot’
3 rd pl.	mú-	mufoó	‘pots’

Class 9/13

i- nyimá ‘back (s)’

Class 16/16 a

o- fúmú ‘place’

3.1.8. Object markers

Object markers in Tuki are only applicable to humans. Object markers for inanimates are expressed by zero morpheme. Object markers are given below with the corresponding English translation:

(37)	o	‘me’
	o	‘you’ (sg.)
	mu	‘him/ her’
	su	‘us’
	nu	‘you’ (pl.)
	wú	‘them’

Let us use the above object markers with the verb ‘otumä’ ‘to send’

(38)a.	.a!	túmámí	‘he / she sends me’
	b.	otúmámí	‘he / she sends you (s.g)’
	c.	amutúmámí	‘he / she sends him/her’
	d.	asūtúmámí	‘he / she sends us’
	e.	anūtúmámí	‘he / she sends you (pl.)’

f. awútúmámí ‘he / she sends them’

Notice that we have assumed that the first person singular object marker (translated as *mɛ*) is a low floating tone. This low floating tone lowers the floating high tone in / à ! túmámí / ‘ he/she sends me’. That is how we get the downstep in the construction.

Now consider the following verbs and their uses in the constructions exhibited in (39): obáná ‘to marry’, odùmà ‘to beat’, wùna ‘to kill’

(39) a. a ! mbánámí ‘he /she marries me’

b. a ! ndúmăm ‘he/ she beats me’

c. a ! ngúnámí ‘he/ she kills me’

In (39), the low floating tone now has a tone bearing unit which is a nasal. It seems to be the case that the nasal appears only before voiced consonants as evidenced in (39). Elsewhere, the low floating tone has no TBU (Tone Bearing Unit) and therefore stands for the object marker. Except in cases like / osùwà / ‘to wash’ where we have:

(40) atsuwámí

In (40), we can plausibly say that the first person singular object marker is /t/. Recall that in cases where the nasal / n/ functions as object marker. It can also function as a subject marker. For instance, let us transform (39) into (41):

(41) a. mbánámí ‘I marry’

b. ndumăm ‘I beat’

c. ngúnámí ‘I kill’

We can see that the nasal that functions as subject marker functions also as object marker. Similarly, if we compare (40) with (42):

(40) atsuwămí ‘he /she washes me’

(42) tsuwămí ‘I wash’

We notice that the segment which is the object marker is also the subject marker / t-/.

In sum, there are two positions, both of them are arguable. First, that the first person singular subject marker and the first person singular object marker are the same: N- ; that this nasal disappears before another nasal or a voiceless consonant. Second, that the object marker is a low floating tone which gets a tone bearing unit, namely a nasal before a voiced consonant. It makes little sense to posit a nasal insertion. So we have to go for the first position.

3.2. Basic Word Order

In Biloa (1992, 1995), it was argued that the basic word order of Tuki is SVO, as illustrated below:

- (43) Mbárá a- má- kútú- dingá Putá
 Mbárá SM P2 Prog love Puta
 “Mbara used to love Puta”

The direct object complement must occur after the verb and be adjacent to it. Although in some Bantu languages such as Chichewa (see Mchombo 2004: 9), the subject NP can either appear in preverbal position or be in postverbal position, in Tuki it is preferred in preverbal position:

- (44)? a- má- kútú- dingá Putá Mbárá
 SM P2 Prog love Puta Mbara

In spite of the fact that the above sentence is acceptable in certain discourse contexts (such as right dislocation of the subject NP), the direct object NP must necessarily occur after the verb. The subject cannot intervene between the two constituents:

- (45)* a- má- kútú- dingá Mbárá Putá
 SM P2 prog love subject Object

In Tuki, when the direct object complement is [+ human], its phi-features can be duplicated by an incorporated OM (Object Marker) inside the verb:

- (46) Mbárá a- má- kútú- mu- dingá Putá
 Mbara SM P2 Prog OM love Puta
 “ Mbara used to love Puta”

In (46), as in the other sentences above, the phi-features of the subject NP are duplicated by the agreement prefix concord (which is called here a S(ubject) M(arker)). As for the OM, it

occurs in (46) between the aspectual morpheme *kutu* and the verb *love*. Usually, it immediately precedes the verb. Although in Tuki the OM is overtly realized when the NP it refers to is [+ human], in other Bantu languages such as Chichewa and Kinande (Mchombo 2004; Mutaka 1995; Mutaka and Hyman 1990; Baker 2003) it can duplicate the phi- features of any animate NP.

In Biloa (1991a), it was indicated that thematic subjects can be freely omitted in Tuki. This language was therefore argued to be a null subject or a pro-drop language. In other words, an empty category called *pro* is licensed in Tuki thematic subject positions. So, if the NP subject Mbara is dropped in (43), the sentence would still be grammatical:

(47) *pro* a- má- kútú- dingá Putá
 SM P2 Prog- love Puta
 “He used to love Puta”

We will come back in details in a subsequent chapter to the null subject phenomenon in Tuki. Likewise, in Biloa (1992, 1995), Tuki thematic object positions were said to be freely droppable. Null objects were argued to be licensed in Tuki. For instance, given the appropriate discourse environment, in a sentence like (46), the direct object complement NP can be dropped:

(48) Mbárá a- má- kútú- mu- dingá *pro*
 Mbara SM P2 Prog OM love
 “Mbara used to love (her)”

More descriptive and analytical details will be provided later on about this construction. As a consequence of what is said above, a Tuki sentence may have no overt NPs, but be perfectly interpretable. The following construction is a case in point:

(49) *pro* a- má- kútú- mu- dingá *pro*
 SM P2 Prog OM love
 “He/she used to love him/her”

Coming back to the OM, in some Bantu languages (cf. Mchombo 2004:20), when the OM is present, the NP arguments can be freely ordered with respect to each other and with respect to the verbal unit. Not so in Tuki.

3.3. The internal structure of Infl[+ tense]

Let us now present more detailed information on the syntax of Tuki.

3.3.1. Word Order in Tensed Clauses

Tuki is a right branching language with a strict SVO word order. The only word order in derived constituent structure is also SVO:

- (50) a. Mbárá a- nóbám vǎdzu
Mbara SM beats children
'Mbara beats children'
- b. Vǎdzu vá- nóbám Mbárá
Children SM beat Mbara
'Children beat Mbara'

In a transitive construction two NPs have the grammatical relations "subject-of" and "object-of" the verb. We will posit that there is an agreement marker affixed to the verb; this agreement marker copies the noun class of the grammatical subject. Moreover, in most instances, the subject in Tuki precedes the verb while the object follows it. Even in cases where an object marker (direct object clitic) is affixed to the verb, the subject of the sentence and the subject marker always precede:

- (51) a. Mbárá a- dingám Putá
Mbara SM loves Puta
'Mbara loves Puta'
- b. Mbárá a- mu- dingám
Mbara SM OM. loves
'Mbara loves her'

Intransitive sentences are marked by the absence of an "object of" the verbs. There is just one-place predicate where the NP is "subject-of" the verb:

- (52) Mbióró a- má- gwá ídzó
Mbioro SM p2 die yesterday
'Mbioro died yesterday'

3.3.2. The Internal Structure of INFL [+ Tense]

Before we delve into the analysis of INFL in Tuki, let us briefly outline the structure of the Tuki verb.

3.3.2.1. Verb Structure

Consider the following sentence:

- (53)a. onúmútú wáa a- má-mú- bang- éy- a na tsawú
 Husband her SM P2 OM cry caus with Final V with whip
 ‘Her husband caused her to cry with whip’

In (53a) above, the verb is AMAMUBANGEYA “caused to cry”. It undoubtedly forms a complex morphological item, made of the following constituents: the subject marker (SM) (*a*)-, the tense marker (*ma*) -, the object marker (OM) (*mu*)- , the verb stem (*bang*), the causative morpheme (*ey*)-, and the final vowel (*a*)-. So the verb stem in (53 a) has the following linear structure:

- (53.b) (SM-) Tense- (OM-((verb stem)1-CAUS2) 3 Final V) 4

Bear in mind that the spot occupied by CAUS is reserved for any extension morpheme. So we might as well say that the second cycle in (53.b) can contain any extension morpheme (s). The deepest cycle contains the verb stem, and attached to it from left to right are the subject marker, the tense marker, the object marker, and the final vowel. Where would the negative marker fit in this picture?

- (54) a. Bob a - ta- má- mu- bang- éy- a
 Bob SM Neg P2 OM cry caus FV
 ‘Bob didn’t cause Mary to cry ’
 b. Bob a- ta- bang- éy- á Mary
 Bob SM Neg cry caus FV Mary
 ‘‘ Bob didn’t cause Mary to cry’’

The negation morpheme in Tuki always occurs before the verb stem. Tense and the object marker may occur between the negation morpheme and the verb stem (54a).

Chomsky (1981) indicates that the INFL node may be a collection of the features [+ Tense, [AGR]]. If INFL is [+Tense] , it will contain AGR, a node underlying subject verb agreement, consisting of the features person, gender and number.

Consider the following paradigm:

- (55) a. + tense , + person finite
 b. - tense , + person subjunctive
 c. + tense , - person participle
 d. - tense, - person infinitive

(55 a, b, and d) seem to be attested in Tuki . Finite verbs independently select categories of tense/ aspect:

- (62) a. Mbárá a – dingá -m vákútú

Mbara SM loves incomplete aspect women

'Mbara loves women'

b. Mbárá a - má - dingá vákútú

Mbara SM P2 love women

'Mbara loves women'

c. Mbárá a- bunganá -ní ee Putá a- nyá - m cwí

Mbara SM think asp. that Puta SM eat asp. fish

'Mbara thinks that Puta eats fish'

Verbs in the subjunctive form do not select tense / aspect but nevertheless show full obligatory agreement with the subject.

Subjunctive verbs will appear only in embedded contexts, where the infinitive is used in English:

(57) Putá a- dingám éé a- nyá ngo

Puta SM loves tha SM eat chicken

'Puta wants to eat chicken'

(55 c) seems to be non-existent in Tuki. Recall that in the language any [+ Tense] construction shows full obligatory agreement with the subject. Consequently the case cannot be attested in the language. Tuki, however, contains the combination of features exhibited in (55 c)

(58) o -dinga maábo i- mú tsémé

Infinitive marker love wine SM is sin

'To love wine is a sin'

The presence of the subject marker is obligatory in finite constructions. The SM agrees in noun class with the subject. We might as well call the subject marker 'AGR'. The object marker may occur only in tensed clauses. Object markers, which can refer only to humans, may be considered as clitics.

(59) a. Mbárá a- gírám Putá

Mbara SM wait Puta

'Mbara waits for Puta'

b. Mbárá a- mu gírám

Mbara SM OM waits

'Mbara waits for her'

We can now propose the structure of the [+ tense] INFL as embedded in the tree representation of (60).

- (60) Mbárá a- ta- má - mú- dingá
 Mbara SM Neg P2 OM love
 'Mbara did not love her'

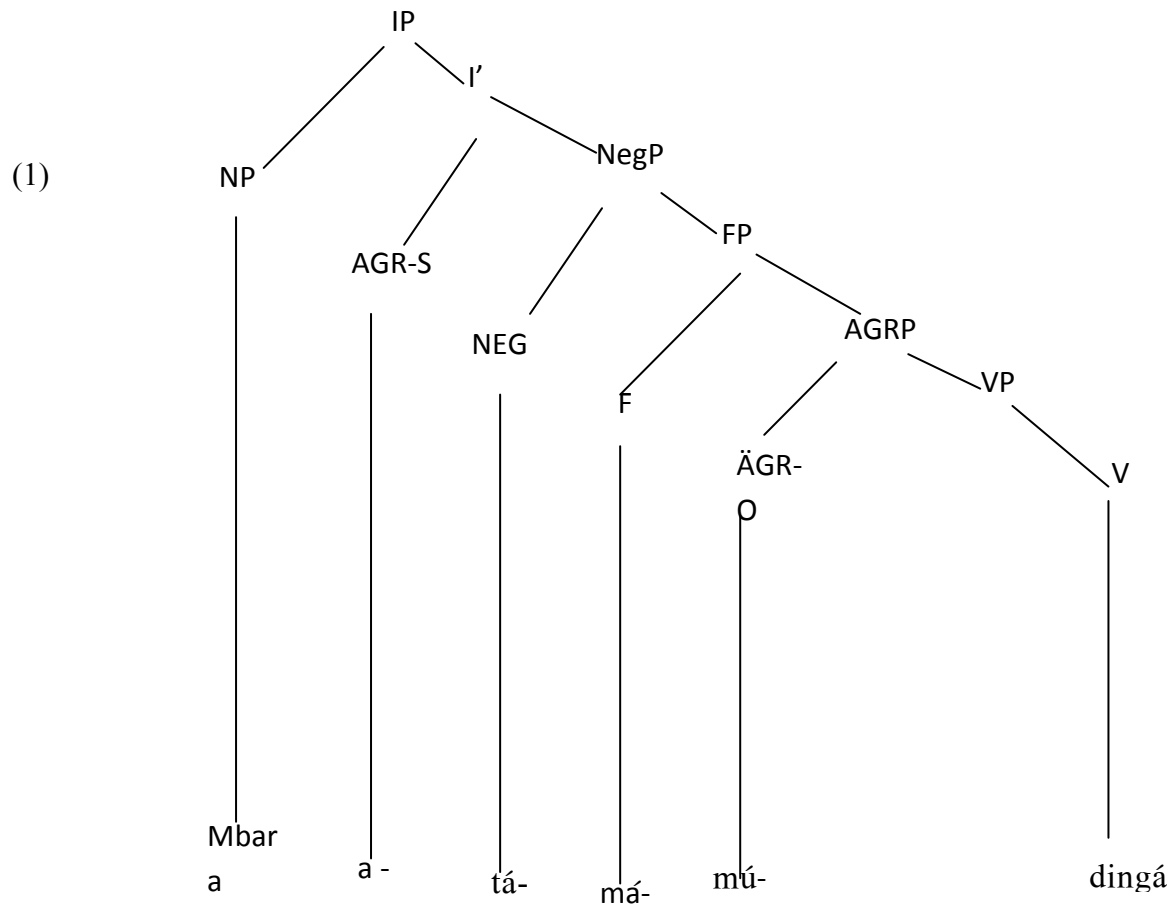

3.4. Well- formedness of a zero subject

In Tuki, the subject of a tensed sentence may remain unexpressed.

- (62) a. Mbárá a- bangámí
 M. SM cries

‘Mbara cries ‘

a'. pro a- bangámí

SM cries

‘‘He/she cries’’

- b. vǎdzu vá – bangámí

children SM cry

‘Children cry’

b’ . pro vá – bangám

SM cry

‘They cry’

But what evidence do we have, that allows us to assess that empty subject positions exist in Tuki. Can an empty subject position in Tuki act as an antecedent for the Binding conditions of Chomsky (1981)?

(63) Binding conditions

A) An anaphor is bound in its governing category

B) A pronoun is free in its governing category

C) A name is free

(64) a. Mbárá_i a- dingám omwámáte_i

Mbara SM loves himself

‘Mbara_i loves himself_i’

b.* Mbárá_i a - dingám omwéne_i

Mbara SM dingam him

‘Mbara_i loves him_i’

(65) a. Mbárá_i a- b(e) ée Putá a- má- éná omwéne_i

Mbara SM says that Puta SM P2 see him

‘Mbara_i says that Puta saw him_i’

b.* Mbárá_i a- b(e) ée Putá a- m(á) -éna omwámáte_i

Mbara_i says that Puta SM P2 see himself_i

c.* Mbárá_i a- b(e) ée Putá a- m(á) éna Mbárá_i

‘ * Mbara_i says that Puta saw Mbara_i ’

In (64a), the coreferent interpretation is allowed between *Mbárá* and *Omwámáte* ‘himself’. (64b) is excluded by principle c. (64c) is disqualified by principle B. (65a) is licit because principle B is respected, while (65b, c) are outlawed respectively by principles A and C. Now we have to ask the question whether the same pattern holds for Tuki when the subject is non- overt.

(66) a. [e]_i a - dingám omwámáte_i

SM loves him -/ herself

‘ he_i / she_i loves him- / herself_i ’

b. [e]_i a- b(e) ée Putá a-m(á) -éna omwámáte_i

SM says that Puta SM P2 see him- / herself
 ‘ *he_i /she_i says that Puta saw him- / herself_i ’

c. [e]_i a- b(e) ée Putá a- má- éna omwéne_i
 SM says that Puta SM P2 see him / her
 ‘ he_i/she_i says that Puta saw him_i / her_i ’

d. * [e]_i a- b(e) ée Putá a-m(á) -éna John_i
 SM says that Puta SM P2 see John
 ‘ he_i says that Puta saw John_i ’

(66) clearly illustrates that in Tuki a gap can act as an antecedent for the chomskyan binding conditions (63). We can use the same line of argumentation to determine the existence of an empty category subject in infinitive contexts in Tuki:

(67)a. Mbárá_i a - dingám [CP [IP PRO_i wono omwámáte_i]]
 Mbara SM loves to laugh himself
 ‘ Mbara likes to laugh at himself ’

b. * Mbárá_i a - dingám [CP [IP PRO_i ø- wono omwéne_i]]
 Mbara SM likes inf. marker laugh him
 ‘ * Mbara_i likes [CP [IP PRO_i to laugh him_i]] ’

c. * Mbárá_i a - dingám [CP [IP PRO_i o- wono Mbárá_i]]
 Mbara SM loves inf. laugh Mbara
 ‘ * Mbara_i likes [CP [IP PRO_i to laugh at Mbara_i]] ’

(68) Mbárá_i a- t- ũba wusí [CP[IP PRO_i wudza ée Putá a- benam
 Mbara SM Neg hear well tell that Puta SM hates

* omwámáte_i / ómwéné_i / * Mbárá_i
 himself him Mbara

“ Mbara does not feel fine telling that Puta hates himself /him/*Mbara”

(67) and (68) explicitly show that the empty category subject in infinitive contexts patterns like the empty category subject in tensed contexts with regard to Binding theory. The empty category subject encountered in tensed clauses is generally called *pro* whereas the empty subject of infinitives is called PRO (for the most standard assumptions on this matter see Chomsky (1982)). Rizzi (1982) has shown that *pro* can be interpreted as free or specific, but PRO may never have that interpretation except when it is controlled by some other NP. Thus in the following sentence:

(69) it is easy [CP [IP PRO to win]]

PRO is only interpreted as “arbitrary person or persons”. Although M. Suñer (1983) claims that pro can be interpreted as arbitrary, Jaeggli (1986) discusses clear-cut differences between PRO and pro. Jaeggli and Safir (1989) illustrate three sorts of diagnostics that may be used to determine whether a null subject is PRO or pro. We want to test some of these ideas against the Tuki empirical material.

3.4.1. The Resumption Test

PRO may not be a resumptive pronoun unless there is another bindee; pro can be a resumptive pronoun.

(70)

*[_{NP} mangádzu ódzu] [_{CP} odzu [_{IP} Mbárá a- t- ídzima [_{CP} ngí [_{IP}
 child this who Mbara SM neg know if
 -imú sese [_{CP} [_{IP} PRO o- tófa n(a) osa]]]]]
 it is easy inf. Marker wash in river

“* This is the child who Mbara does not know whether it was possible PRO
 to swim in the river”

(71)

[_{NP} mangádzu ódzu] [_{CP} odzu [_{IP} Mbárá a- t- ídzima [_{CP} ngí [_{IP}
 child this who Mbara SM neg know whether
 Putá á- yánam ó- bãná ómwéné]]]]
 Puta SM must inf. Maker marry him

“ This is the child who Mbara does not know whether Puta must marry him”

(70) above illustrates the inability of PRO to act as a resumptive pronoun. (71) shows that in Tuki an overt pronoun can serve as a resumptive pronoun. Can pro act as a resumptive pronoun in Tuki?

(72)

[_{NP} mutu ódzu] [_{CP} odzu_i [_{IP} Putá ídzímam [_{CP} vatu vaní [_{IP} vá-ta-díngá
 man this who Puta know men many SM Neg love
 okutu odzu [_{IP} [e] a- bãnam]]]]]
 woman who SM marry

‘This is the man whom Puta knows how many men do not like the woman whom (he)
 marries’

Notice that in (72) the operator odzu “who” has crossed two CPs; the fact that the sentence is grammatical implies that odzu may not have been extracted by Wh - movement. So the

subject gap coindexed with *oDZU* is probably an empty category functioning as a resumptive pronoun. Bear in mind that in Tuki overtly realized subject pronouns can alternate with null subjects (contra Biloa 1991). So when the language appeals to the resumptive strategy, it uses *pro* as a resumptive pronoun in subject position.

The interesting result, here, is that *PRO* as opposed to *pro*, cannot function as a resumptive pronoun in Tuki as evidenced by the illicitness of (70) above.

Jaeggli (1982: p.138, p. 173, fn. 9) has indicated that there is a contrast between *PRO* and *pro*: in a left dislocation construction, *PRO* may not act as a resumptive pronoun. The ungrammaticality of (73) clearly illustrates the point:

(73)

* Mbárá í- yákánam [_{CP} éé [_{IP} PRO o- fúma na tama]]

Mbara SM difficult that inf. Marker arrive in time

‘* Mbara_i it is difficult PRO_i to arrive on time’

pro can function as a resumptive pronoun in a left dislocation construction in Tuki:

Mbárá_i í- yákánam [_{CP} éé [_{IP} *pro* a - fúmá ná tama]]

Mbara SM difficult that SM arrive in time

‘(As for) Mbara_i it is difficult that he_i arrive on time’

Thus, we have established that the empty category in subject position of Tuki tensed clauses (*pro*) can function as a resumptive pronoun in a syntactic island, whereas *PRO* (the infinitive null subject) cannot function as a resumptive pronoun. So the resumption test makes a clear distinction between *pro* and *PRO* in Tuki.

3.4.2. The Emex Condition

It is well-known that virtually every language that allows null thematic subjects also allows null expletive subjects, though the reverse implication is not valid (cf. Safir (1985a, b) and Travis (1984)). If indeed Tuki is a null subject language, we should expect it to have null expletive subjects. The prediction is borne out:

(74)

a. *pro* a- m(u) - údza éé *pro* a- m(u) - umbăna cwí
SM P1 say that SM P1 catch fish

‘He/she said that he/she caught fish’

b. *pro* a-m(u) - údza éé *pro* í -fwanenam éé *pro* a- m(u) - úna náma
SM P1 say that SM appear that SM P1 kill animal

‘He/she said that it seems that he/she killed an animal’

PRO, in any language, cannot be an expletive. Thus in Tuki an expletive cannot be the null subject of an infinitive.

(75)

* pro i- mú sese o- mu -dere éé Putá a- nóm
 SM is easy inf. marker OM pray that Puta SM sick
 ` * It is easy to please him that Puta is sick`

To account for the ungrammaticality of sentences such as (75),

Safir (1985 a, b) devised a condition stipulating that empty expletive elements be governed:

(76) The Emex Condition

An empty category expletive must be governed.

Due to the PRO theorem, PRO cannot survive in a governed position. Thus, the Emex Condition enables us to draw the line between PRO and pro in Tuki.

Summarizing, we have shown above that pro as opposed to PRO can be a resumptive pronoun, an expletive in Tuki; last, but not least, pro unlike PRO may occur in a governed position. In any case, we have established that the empty category that appears in subject position of Tuki tensed clauses is pro.

3.4.3. AGR and Proper Government

In languages allowing the phenomenon of null subjects (for example, Greek, Hebrew, Italian and Spanish) the pronominal subject of a tensed sentence may be phonologically empty. In Tuki, contrary to what is claimed in Biloa (1991), there are pronominal subjects in the sense usually understood for the languages mentioned above:

(77) Italian

a. io parlo	` I talk '	b. parlo	(1st pers. Sg.)
tu parli	` you talk '	parli	(2 nd pers. Sg.)
lui parla	` he talks '	parla	(3rd pers. Sg.)
noi parliamo	` we talk '	parliamo	(1st pers. pl.)
voi parlate	` you talk '	parlate	(2 nd pers. pl.)
loro parlano	` they talk '	parlano	(3rd pers. pl.)

(78) Tuki : infinitive *onya* 'to eat'

Present tense

a. nyam	' I eat '	b. Nu	nyám	(1st pers. Sg.)
o-	nyám	' you eat '	mámu	o-nyám (2 nd pers. Sg.)
a-	nyám	' s/he eats '	omwéne	a – nyám (3rd pers. Sg.)
tu-	nyám	' we eats '	vítsu	tu- nyám (1st pers. pl.)

nu- nyám ‘you eats’ vínu ny- nyám (2nd pers. pl.)
 va- nyám ‘they eats’ vamwéne va- nyam (3rd pers. pl.)

It is well known that the verbal morphology appears to be rich enough to make the pronominal subjects in (77) recoverable semantically though they are phonologically empty. The paradigm exhibited in (78 b) shows that Tuki does have subject pronouns à la Italian. The language has strong pronouns. *O, a, tu, nu, va* are subject markers agreeing in noun class with the nominal subject. They therefore constitute AGR-S. (78 b) shows that their presence is compulsory for, when omitted, the resulting forms are ruled out. Recall that we indicated in the preceding subsection that all verbal forms in Tuki (apart from the infinitive) must be marked for AGR, a node underlying subject verb agreement, consisting of the features person, gender and number.

AGR-S being the head of IP (as in Chomsky 1988), we will argue that, if precisely AGR-S were not a proper governor in Tuki, we would end up with an ECP violation. We thus conclude that in Tuki AGR-S can properly govern the subject position. Notice that in this language, F does not have to be necessarily [+ tense] since subjunctive verbal forms, though bearing the features [- tense, + person], allow null subjects.

(79)

Mbárá; a- dínámí éé [e]_i a- bání ókutu
 Mbara SM loves that SM marry woman
 ‘Mbara wants to marry a woman’

The embedded verb in (79) *abana* is in the subjunctive form. But it still licences a commanding empty category in subject position.

It has been suggested by Riemsdijk and Williams (1986), following Chomsky (1981), that the agreement relation between AGR and the subject should be sanctioned by coindexation:

(79) NP_i [INFL [+ tns] AGR_i] INFL VP

(80) a. mútu a- nyám mbása
 cl.1man SM eat corn
 ‘The / a man eats corn’
 b. mbwíi i- nyám mbása
 cl.10 sheep SM eat corn
 ‘A sheep eats corn’

(81)a. * mútu i- nyám mbása
 b. * mbwíi a- nyám mbása

In (80), the subject markers *a* and *i* which represent AGR-S agree in noun class with the NPs *mútu* and *mbwíi* respectively. Any random assignment of subject markers to inappropriate NPs will automatically result in ungrammaticality (cf. (81)). In case the two NPs *mutu* and *mbwii* are not available in the sentence, but they are semantically recoverable in discourse, we will have well-formed empty categories in subject position:

- (82) a. [e]_i a_i -nyám mbása
 SM eats corn
 ‘he/she eats corn’
- b. [e]_i i_i -nyám mbása
 SM eats corn
 ‘It eats corn’

We may then assume, with Riemsdijk and Williams, that either AGR_i c-commands NP_i (cf. (79)) and hence can govern it , or that INFL “inherits” the subscript from AGR_i and acts as a proper governor whenever NP_i is not phonologically present. We have already adopted the assumption licensing the occurrence of null subjects without any ECP violation.

3.4.4. That- Trace Effects in Tuki

WH-elements in Tuki do not exhibit any subject / object asymmetry, therefore they are immune to COMP- trace effects:

(83)

- a. ǎndzu_i [IP Mbárá údzam [CP x_i éé [IP Dimá a- má-dínga x_i]]] ?
 who Mbara says that Dima SM P2 love
 ‘Who does Mbara say that Dima loved’

(84).

- a. ǎndzu_i [IP Mbárá údzam [CP x_i éé [IP x_i a- námbam cwí]]] ?
 who Mbara says that SM cooks fish
 ‘Who does Mbara say that cooks fish’
- b. Mutu ódzu_i nga- t- idzima ngí x_i a- nú- aram námbari
 man who SM Neg know if SM F2 come tomorrow
 ‘A man that I do not know if he come tomorrow’
- c. okutu ódzu_i nga - t- ídzíma até x_i a- m- údza
 woman who SM Neg know what SM P1 say

‘The woman who I don’t know what said’

The lack of COMP-trace effects in Tuki is expected under the assumption that the language is a null subject one. Since Perlmutter (1971), it has become customary to assume that pro-drop languages do not exhibit any subject-object asymmetries in cases of extraction across an overt complementizer. Thus Italian subjects are freely extractable across declarative and interrogative complementizers.

(85) (Rizzi) (1990) `s (94))

- a. Chi credi che abbia telefonato?
Who think that have telephone
‘Who do you think that has telephoned?’
- b. Un uomo che non so se ci potrà aiutare
‘a man that I don’t know if will be able to help us’
- c. L’uomo che non so che cosa abbia detto
‘The man who I don’t know what said’

Rizzi (1982 a, chapter 4) suggested that the property of free extraction of the subject over a phonetically realized complementizer is a consequence of the fact that free inversion of subject can occur in postverbal position:

(86) (Rizzi) `s (95))

- a. Credi che abbia telefonato Gianni
‘I think that has telephoned Gianni’
- c. non so se ci potrà aiutare Gianni
‘I don’t know if will be able to help us Gianni’
- c. non so che cosa abbia detto Gianni
‘I don’t know what said Gianni’

The idea that subjects are freely extractable across declarative and interrogative complementizers because the subject can be placed in postverbal position has been substantiated by an overwhelming bulk of empirical material (Rizzi 1982 a; Jaeggli 1982; Kenstowicz 1984; Safir 1985; Burzio 1986; Raposo 1988; Brandi and Cordin (1981, 1989)).

When the subject occurs in postverbal position in those languages that licence free inversion, it is adjoined to VP and the preverbal position is occupied by an expletive pro:

(87)

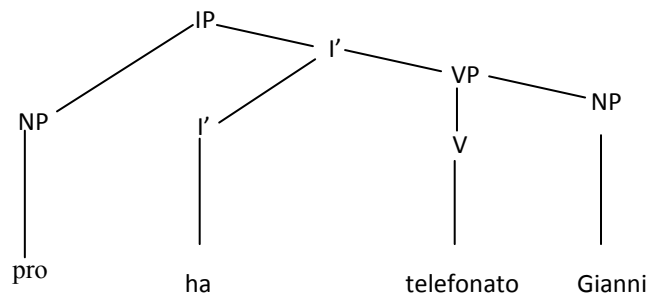

Rizzi assumes that the post verbal position is properly governed by AGR (Chomsky (1988) and Pollock (1989)). Consequently, a trace is well formed in this position in the case of subject extraction.

Coming back to Tuki, this language does not allow free inversion of the subject:

(88)

- a. * Nũ m- bungánam éé a- ma - gwa Putá
I SM think that SM P2 die Puta
'I think that Puta died '
- b. * Nũ nga- t- ídzima ngí a- fítim o- su - áka Isomo
I SM Neg know if SM CAN Inf. marker us help Isomo
'I don't know if Isomo can help'
- c. * Nũ nga -t- ídzima até á- m- údza Mbárá
I SM Neg know what SM P1 say Mbara
' I don't know what Mbara said'

Since free inversion of the subject is strictly disallowed in Tuki, it cannot be appealed to in order to explain free extraction of the subject across an overt complementizer. Recall that we said above that Tuki licenses *pro* in subject position because Agr-S is a proper governor in the language.

(89)

- a. Díma a- tá - a- kúsá mátúwa
Dima SM Neg P1 buy car
'Dima did not buy a car'
- b. *pro* a- tá- a- kúsá mátúwa
SM Neg P1 buy car
'He/ she did not buy a car'

The tree structure representation of (89b) is the following:

(90)

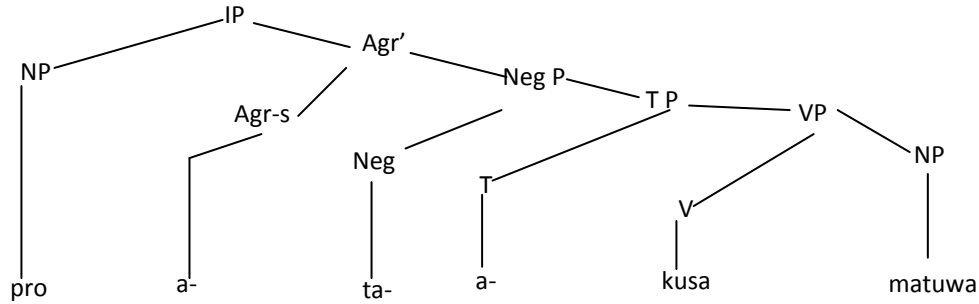

In (90), Agr-S case-governs *pro*; better still it properly head-governs *pro*, thereby licensing the occurrence of the latter empty category. Now we can appeal to this explanation to account for the free complementizers. We will say that Tuki is immune to comp-trace effects because the variable created by Agr-S. in Relativized Minimality terms, Agr-S properly runs counter to Rizzi's prediction that a trace must be head-governed "within the immediate projection of the head" that is governed by X within X'. In (90), we would expect Agr-S to head govern *pro* within Agr'. But this is clearly not the case since Agr-S head-governs the specifier position of IP. Notice, however, that Rizzi's predictions are not entirely wrong since it is borne out in the case of object extraction. Consider the phrase marker of (88):

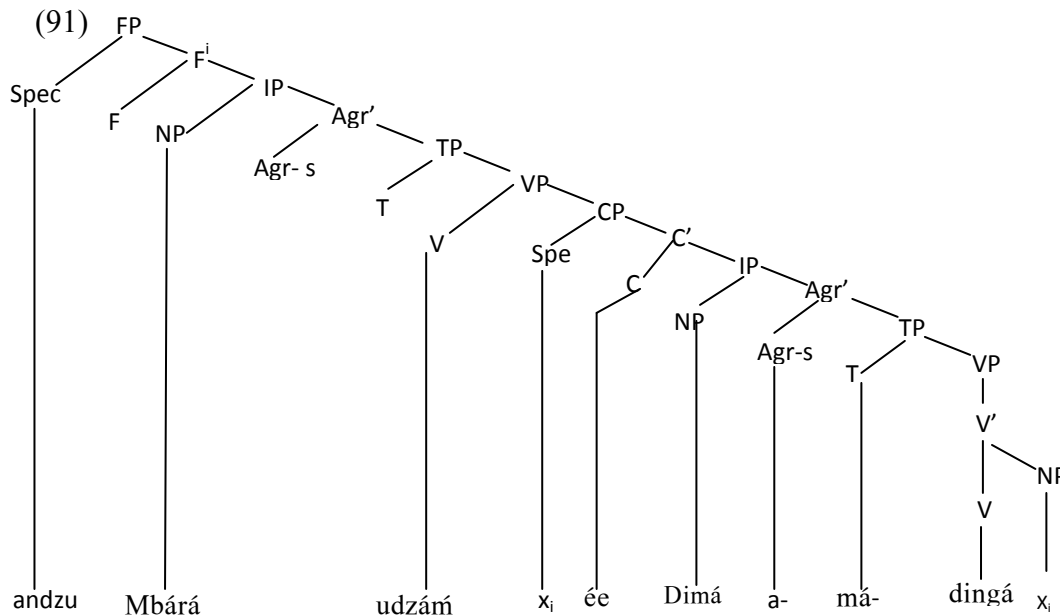

In (91), V properly head-governs the object NP within V'. Thus we have an asymmetry with respect to how head-government is achieved in this language in cases of subject extraction and object extraction: in one case X properly governs outside X', while in another case X properly governs within X'. This state of affairs is not entirely surprising since in the latter case V directly selects the object and therefore the object is an internal argument

whereas in the former case the specifier of IP is an external argument. It seems to be the case that the head-governments requirement on traces must take into account the fact that complements and specifiers differ in the way they are selected by their potential governor. It could be argued that the cases of subject extraction examined so far are ruled in because antecedent-government obtains through a sequence of government relation. Thus, in the following sentence:

(92)

ǎndzu_i o- bungánam [t'_i éé [t_i a- m- énda]]

who SM think that SM P1 go

‘Who do you think that left?’

andzu_i ‘who’ governs t'_i and the latter t_i since $\theta\theta$ ‘that’ does not hinder the c-command relation in structures such as the one

(93)

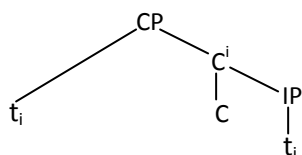

Bear in mind that the presence of $\theta\theta$ is compulsory in (92). Although antecedent –government seems to obtain in (92) because the c-command connection is not broken, there is no need to assume that it rescues (92). It seems to be the case that (92) would have been grammatical with or without antecedent-government obtaining. This is evidenced by the fact that in case of subject topicalization across an overt complementizer, although the c-command relation cannot be established and antecedent – government cannot obviously be appealed to, the construction is licit:

(94)

Isomó_i Nũ n-tsétsám ngí x_i a- má- kúsá nangá

Isomo I SM ask if SM P2 buy house

‘Isomo, I ask whether x_i bought a house’

(94) is uniquely salvaged by proper head-government of x_i by Agr-S.

More evidence that all extractions from subject position in this language are acceptable is provided by the following two constructions:

(95)

a. ǎndzu_i o- kambim ngí x_i a- fitĩm wúna ngo

who SM astonish if SM can kill panther

‘Who do you wonder whether can kill a panther?’

b. *ǎndzu_i o- kámbin ngí tu- bungánam éé x_i a- fitím wuná ngo*
who SM astonish if SM think that SM can kill panther

‘Who do you wonder whether we think that can kill a panther?’.

In the two examples provided above, Agr-s licenses the variable in subject position.

3.5 WH- Movement

Wh- questions, relative clauses and focus constructions are all instances of wh-movement. Examples of these constructions in Tuki are provided below:

(96)

a. *Ane_i Putá a- dingám ec_i.*

Who Puta SM loves

‘Who does Puta love?’

b. *Mutu ódzu_i Putá a- dingám ec_i*

man rel. Puta SM loves

‘The man (who) Puta loves...’

c. *i- mú mánya ámá_i Putá a- námbam ec_i*

It is food that Puta SM cook

‘It is the food that Puta cooks’.

The above examples illustrate short – distance wh-movement. Long wh- movement is also possible:

(97)

a. *Ane_i mamú ó- bungánam éé Putá a- dingám ec_i*

who you SM think that Puta SM loves

‘Who do you think that Puta loves?’

b. *mutu ódzu mamú o- bungánam éé Putá a- dingám ec*

Man rel. pro you SM think that Puta SM loves

‘The man you think that Puta loves’

c. *i- mú ínỹnyi idzı_i mamú o- bungánam éé Putá a- námbám ec_i*

it SM bird rel. you SM think that Puta SM cook

‘It is the bird you think that Puta cooks’

It is well known that the relation between the fronted phrase and its trace must obey the Subjacency condition of Chomsky (1973) which imposes strict locality condition on Move alpha. Thus we should expect the following sentences to be ungrammatical:

(98)

a. Ane_{[IP} mámú o- m(á) úba _{[NP} maru ama _{[CP} éé _{[IP} Putá a- dingám
 who you SM P2 hear story this that Puta SM loves.

‘*Who_i did you hear the story that Puta loves ec_i’

b. mutu ódzu _{[IP} mámú o- má úba _{[NP} maru ama _{[CP} ée _{[IP} Putá a- dingám ec
 man rel. Pro you SM P2 hear story this that Puta SM love
 a- nó m]]]]

SM sick

‘The man you heard the story that Puta loves is sick’

c.i- mú ínyínyi idzii mámú o- sesa ate Putá a- mu- fá ec
 It is bird rel. you SM ask what Puta SM P1 give ec

‘*It is the bird that you asked what Puta gave’

(98 a-b) violate the Complex Noun Phrase Constraint and (98 c) violates the Wh- Island Constraint. Yet all three constructions are grammatical. Why does this state of affairs obtain? We will argue in chapter six that movement is not involved in the constructions exhibited above and that the empty categories contained in those are non-overt resumptive pronouns. Thus the wh-phrases that appear fronted are base-generated. Resumptive pronouns may be phonetically realized or null in Tuki. However, there are no resumptive pronouns for [-human] NPs. Thus, while resumptive pronouns may occur in the following counterparts of (98), the position associated with the ec is a [-human] NP:

(99)

a. Ane_i _{[IP} mámú o- m(á)- úba _{(NP} maru ama _{[CP} éé _{[IP} Putá a- dingám
 who_i you SM P2 hear story this that Puta SM loves
 ómwéné_i]]]]

him

‘Who did you hear the story that Puta loves him?’

b. mutu odzu_i _{[IP} mámú o- m(á)- úba _{[NP} maru ama _{[CP} éé _{[IP} Putá a- dingám
 man rel. pro you SM P2 hear story this that Puta SM loves
 ómwéné_i a- nó m]]]].

him SM sick

‘The man you heard the story that Puta loves is sick’.

Thus, in this language, constructions involving resumptive pronoun binding do not seem to respect island constraints. Those involving adjunct movement (i.e. movement of items such as *where*) and pied-piping over islands strictly obey subadjacency. And it will be shown in chapter six that NP and IP are bounding nodes in Tuki.

3.5. Predicate Cleft Constructions

In Tuki predicate cleft constructions, the focused verb appears in clause initial position. The focused verb is accompanied by what we will call a focus marker. The clause itself retains a copy of the fronted verb:

(100)

a. o- nyá ówú vítsu tu- nyám cwí
 inf. eat FOC we SM eat fish

‘We ATE fish’.

b. o- nyá ówú ómwéne a- má - nyá orése
 inf. eat FOC he/she SM P2 eat rice

‘He/she ATE rice’

c. o- nyá ówú mámú o- nú nyám ndzámbu
 inf. eat FOC you SM F1 eat meat

‘You will EAT meat’

In the above example, focus is indicated by capital letters in the glosses. The fronted verb must be in the infinitive form and cannot carry inflectional morphology, nor can it be accompanied by complements of the verb.

(101)

a. o- námba ówú vakútu vá—má – námba víbufa idzó
 inf. cook FOC women SM P2 cook vegetables yesterday

‘Women COOKED vegetables yesterday’.

b. *vá – má- námba ówú vakútu va- má námba víbufa ídzo
 SM P2 cook FOC women SM P2 cook vegetables yesterday.

(102)

a. o- nyá ówú nũ ngu - nú- nyám cwí
 inf. eat FOC I SM F1 eat fish

b. *o- nyá cwí ówú nũ ngu- nú- nyám cwí
 inf. Eat fish FOC I SM F1 eat fish

In chapter five, we will discuss the properties of predicate cleft constructions in Tuki in detail. It will be argued that focus-v- movement shares a number of properties with wh-movement.

3.6. Simple sentences

This section of the chapter will descriptively deal with simple sentences, that is sentences consisting of only one clause.

The following clause structures loosely speaking are attested in the language:

(103) SVA

Putá a- mú ná kíísini
Putá SM is in kitchen
subject verb place Adjunct
“Putá is in the kitchen”

(104) SVC

Putá a- mú íyere
Putá SM is teacher
subject verb Complement
“Putá is a teacher”

(105) SVO

Mbárá a- dingám Putá
Mbara SM loves Putá
subject verb Object direct
“Mbara loves Putá”

(106) SVOA

Putá a- mu- wáa mányá ná tévére
Putá SM P1 put food on table
subject verb Object direct Adjunct place
“Putá put the food on the table”

(107) SVOC

Putá a- mu- síyá aneme wedzá
 Puta SM P1 rub husband foolishness
 subject verb Object direct Complement
 “Putá proved her husband a fool ”
 (108) SVOO

Putá a- má- fá Viróó móní
 Puta SM P2 give Viroo money
 Subject verb Object indirect Object direct
 “Putá gave money to Viroo”

(109) S V

Mangádzu a- kutu- bete
 child SM prog sleep
 Subject verb intransitive
 “The child is sleeping”

3.7. The complex sentence

Allan A. Glatthorn and Brenda C. Rosen (1990: 554) define a complex sentence as “a sentence that contains one main clause and one or more subordinate clause(s)”.

Coordination and subordination are two syntactic operations that are commonly used to derive complex sentences. Compare the coordination in (110) with the subordination in (111)

(110) Mbárá a- dingám Putá ka Putá tunu a- dingám Mbárá
 Mbara SM loves Puta and Puta too SM loves Mbara
 “Mbara loves Puta and Puta too loves Mbara”

(111) Mbárá a-dingám Putá asene Putá a- mú- dingám pro tunu
 Mbara SM loves Puta because Puta SM OM loves him too
 “Mbara loves Puta because Puta loves him too”

In (110), two main clauses or independent clauses have been coordinated; they have been linked by a coordinator, ka “and” in this case.

(110) is a complex sentence because it contains two clauses.

(111) is also a complex sentence that is made up of a main clause and a subordinate clause. A sentence like (111) is also called in traditional English grammar a superordinate clause.

Before one proceeds with this descriptive presentation of some aspects of Tuki clause structure, bear in mind that clausal coordination in this language does not operate like NP coordination.

For illustration, compare the following construction with the one above:

(112) Mbárá na Putá vá- dǐng- a- án- áń
 Mbara and Puta SM love FV Rec. Asp
 “Mbara and Puta love each other”

It appears that the coordinator for clausal coordination is *ka* while the one that is used for NP coordination is *na*. We will come back in details to the exact status of this element when we talk about resumptive pronouns.

3.8. Formal indicators of coordination

A number of words are used for coordination in Tuki, as indicated in the following table:

Tuki	English
Veda	But
Kee	Or
na; ka	And
Ku	So

The use of these coordinators is illustrated in the following sentences:

(113) Mbárá a- nóm *vedá* pro a- ta- dǐngá éé pro endá ná wáspita
 Mbara SM sick but he SM Neg love that goes to hospital
 “Mbara is sick but he does not want to go to the hospital”

(114) Ate Viróó a- mu- kúsa na mboo, aranga *kee* itutu?
 what Viroo SM P1 buy in market bicycle or motorcycle
 “What did Viroo buy at the market, a bicycle or a motorcycle ?”

(115) Mbárá a- benǎm víbí *ku* pro a- mu- kúsa ngáre éé pro a- wú-

Mbara SM hates thieves so he SM P1 buy gun that he SM OM kill

na adzé

with it

“Mbara hates thieves so he bought a gun so that he can kill them with”

The different uses of na and ka were respectively illustrated above for NP and clausal coordination.

3.8.2. Formal indicators of subordination

In English, in general, “subordination is marked by some indication contained in the subordinate rather than superordinate clause. Such a signal may be of a number of different kinds: it can be a subordinating conjunction; (wh-element; the item that; [...]. Especially in wh-items (where, when, etc), [one] can see a fusion of conjunction and pro adjunct” (Randolph Quirk and Sidney Greenbaum 2000:313).

The above statement by Quirk and Greenbaum seems to be true as far as Tuki is concerned, notably with respect to simple subordinators, the lexical complementizer, and wh- items.

Simple coordinators

Tuki	English
Amú	as, since
Asene	because
na nyimá owú éé	After
toó amú	although
Avandzée	Before
Ngí	If
ombárá odzú	Until

The lexical complementizer

Tuki	English
éé	That

Wh- words: Arguments

Tuki	English
Áné	Who
Ate	What

Wh- words: Referential adjuncts

Tuki	English
ni	When
táa/táné	Where

Wh- words: Non-referential adjuncts

Tuki	English
owáte	Why
twíí	How

Consider now the behavior of simple subordinators in the following sentences:

- (116) Vitsú tú- yánam wénda n(a) Isomo na wáspita *amú* pro a-nóm
 we SM must go with Isomo to hospital as/since SM sick
 “We must take Isomo to the hospital as/since he is sick”

- (117) Visimbi vi-mu-úmbana óngubi *asene* pro a- m(u)-iba mǒní wá íyere
 soldiers SM P1 catch thief because he SM P1 steal money of teacher
 “Soldiers arrested the thief because he stole the teacher’s money”

- (118) Vii ví- yánam o-nyá mányá avandzée ibinó í-kasi
 guests SM must INF eat food before dance SM begins
 “Guests must eat the food before the dance floor is opened”

íyere a sùkúru a- mu- sesa vǎdzu (éé) *ngí* vá-má- mána
 teacher of school SM P1 ask children that if/whether SM P2 finish

mánoo ama pro a- má- wú- fá pro
 work Rel. he SM P2 OM give them

“The teacher asked the children if/whether they finished the work they were given”

(119) nkúnkúma a- mu- dzăna watu a vídongo vya éé pro a- ta- nu- wu-
 chief SM P1 tell people of villages his that he SM Neg F1 OM
 faa pro vakárate a ngómane *ombara*
 give them letters of government limit
 ódzu pro va- ta- yaána tása
 that they SM Neg pay taxes

“The chief told his village people that he will not give them official documents until they pay taxes”

(120) vakrísten va-roo-endána na mísono *too amú* Pára w(a)adóngo a- má gwá
 christians SM Cont go to church even as priest of village SM P2 die
 “Christians still go to church although the village priest died”

(121) bisóbo a-mu-dza ee pro a-nú-túmam para ondye *na nyíma ówú éé*
 bishop SM P1 say that he SM F1 send priest other in back this that
 pára wa wucǒ a- má- gwá
 priest of front SM P2 die

“The bishop said that he would send another priest after the former one died”

The lexical complementizer éé “that” introduces embedded clauses. It is compulsory. Its presence is not optional, unlike its English counterpart:

(122) Mbára i- dzímám *(éé) ómwéné/pro a- timbám peyó
 Mbara SM knows that he SM possess intelligence
 “Mbara knows that he is intelligent”

3.9. Question formation

Tuki wh- items are involved in interrogative formation. As a matter of fact, question formation in this language makes use of two strategies: visible movement and wh-in- situ.

Genuine questions are formed by leaving the wh-operators at the base:

(123) Viróó a- kútu- sakí ná ané ?
 Viroo SM prog chat with who
 “Who is Viroo chatting with?”

(124) Másína a- má- námba ate idzó?
 Masina SM P2 cook what yesterday
 “What did Masina cook yesterday?”

(125) Vădzu a súkúru vá- nw- éndam n(á) iwaána ní
 children of school SM F1 go in vacation when

“When will school children take their vacation?”

(126) Mamú o- nú- tumbám iwáana roo táné/táa?

You SM F1 pass vacation your where

“Where will you spend your vacation?”

(127) Amú pro o- nóm pro o- te- enda na wáspita owate

Since/as you SM sick you SM Neg go to hospital why

“Why don’t you go to the hospital since you are sick?”

(128) pro vá- má- fenda mátuwa woo twii

they SM P2 repair car your how

“How did they fix your car?”

The above constructions are genuine wh-questions in this language. The visible movement strategy can be resorted to form also genuine wh-questions. When the wh-item is fronted, it is optionally followed by a focus marker. To us, the presence of the focus marker seems to indicate that wh- phrases are inherently focalized. A detail description and analysis of interrogatives will follow in the main text when a close look will be taken at the structure of the left periphery.

The following sentences are the counterparts of those illustrated above, except for the fact that wh- words have been raised here:

(129) ané (ódzú) Viróo a- kutu- sakí na á?

who Foc Viroo SM prog chat with resumptive pronoun

“Who is Viroo chatting with?”

(130) Ate (aye) Masina a- má- námbá ídzó?

what Foc Masina SM P2 cook yesterday

“What did Masina cook yesterday?”

(131) Ni (ówú) vǎdzu a súkúru vá- nw-éndám (ná) iwáaná?

when Foc children of school SM F1 go in vacation

“When will school children take their vacation?”

(132) Táa/táné (ówú) mamú ó- nú-tumbám iwáana róó?

where Foc you SM F1 pass vacation your?

“Where will you spend your vacation?”

(133) Owate (ówú) amú pro o- nóm, pro o- te- éndá ná wáspita?

why Foc as/since you SM sick you SM Neg go to hospital

“Why don’t you go to the hospital since you are sick?”

- (134) Twíi (ówú) pro va – má- fénda mátuwa woo
how (Foc) they SM P2 repair car you
“How did they fix your car?”

3.8.1. Dependent Yes/No interrogative phrases

Tuki yes/no questions are introduced by what is called a Q morpheme:

(135)

- a. Dimá a- má- kúsa akana mátuwa na Ndzámáne

Dima SM P2 buy big car in Germany

“Dima bought a big car in Germany”

- b. Yée Dimá a- má- kúsa akana mátuwá na Ndzámáne

Q Dima SM P2 buy big car in Germany

“Did Dima buy a big car in Germany?”

That above yes/no question can be embedded and dominated by the lexical complementizer *ee* “that”:

- (136) Viróó a-sésám[ée[yee[Dimá a- má-kúsa akana mátuwa na
Viroo SM asks that Q Dima SM P2 buy big car in
Ndzámáne]]]

Germany

“Viroo asks/wonders (if) Dima bought a big car in Germany”

Another morpheme that is used for forming yes/no questions is *aa*. It appears in clause final position:

- (137) Mbárá a- má- nyá cwí áa?
Mbara SM P2 eat fish Q

“Did Mbara eat fish?”

(138) Pára a- m(u) –una nóo natye míisono áa?

Priest SM P1 kill snake inside church Q

“Did the priest kill the snake inside the church?”

Semantically, the Q morpheme *áa* behaves like the other Q morpheme *yee*. Obviously, they occur in different positional configurations. Nonetheless, the two can co-occur inside the same clause (albeit in different syntactic locations):

(139) a. yee Mbára a- má- nyá cwí aa ?

Q Mbara SM P2 eat fish Q

“Did Mbara eat fish?”

b. yee Pára a- m(u) –una noo natye miisono aa?

Q Priest SM P1 kill snake inside church Q

“Did the priest kill the snake inside the church?”

There seems to be a slight semantic difference when both Q morphemes appear in the same clause as compared to when there is just one. More light will be shed on the syntactic behavior of these two elements along the way as the analysis proceeds.

3.9. Focalization

In Tuki, almost any element within the sentence can be brought into syntactic prominence or contrastive focus through a syntactic operation (or derivation) known as focalization or focusing. To illustrate this, consider the following sentence:

(140) Ndongta a- m(á)- enda na wáspita idzó n(i) ínguru

doctor SM P2 go to hospital yesterday with feet

“The doctor went to the hospital yesterday on foot”

In the above sentence, each one of the constituents (the subject NP, the verb, the PP, the adverbial phrase...) can be focalized (or focused) as the following sentences will show:

(141) a. Ndongta ódzú a- m(á)- énda na wáspita ídzó ní ínguru

doctor FOC SM P2 go to hospital yesterday with feet

“It is the doctor who went to the hospital yesterday on foot”

b. wenda ówú ndongta a- m(á)- énda na wáspita ídzo ní ínguru

go FOC doctor SM P2 go to hospital yesterday with feet

“The doctor WENT to the hospital yesterday on foot”

c. na wáspita ówú ndongta a- m(á)- énda ídzo ní ínguru

to hospital FOC doctor SM P2 go yesterday with feet

“It is to the hospital that the doctor went yesterday on foot”

d. ídzó ówú ndongta a- m(á)- énda ná wáspita ní ínguru

yesterday FOC doctor SM P2 go to hospital with feet

“It is yesterday that the doctor went to the hospital on foot”

e. ní ínguru ówú ndongta a- m(á)- énda na wáspita ídzo

with feet FOC doctor SM P2 go to hospital yesterday

“It is on foot that the doctor went to the hospital yesterday”

The above data amply show that all constituents, including the verb, can be focalized in this language. It will be demonstrated that this state of affairs has important implications for phrase structure for the representational and derivational nature of the grammar, assuming Rizzi (1997, 2001, 2004).

3.10 Reletivization

Overtly realized wh-items are not involved in Tuki relativization. Apart from the head of the NP, two other elements occur one after the other next to the [N, NP] position in the following sentence:

(142) *vatu ifúndu vá- fû- bánám vásya vakutu*

men many SM Asp marry beautiful women

“Many men often marry beautiful women”

The subject as well as the direct object complement can be relativized:

(143) a. *vatu ifúndu ava éé vá- fú- bánam vásya vakutu*

men many Agr-rel that SM Asp marry beautiful women

vá- tá- fú- fówá nangá

SM Neg Asp build house

“Many men who often marry beautiful women do not often build a house”

b. *vasya vákútu ava éé vatu ifúndu vá- fû- bánám*

beautiful women Agr-rel that men many SM Asp marry

vá- tá- fû- bete ná núba

SM Neg Asp sleep in marriage

“Beautiful women that many men often marry do not stay long in marriage”

In the two clauses above, the head noun is followed by *ava* and *éé* “that”. The latter element is optional in this specific case. *Ava* agrees in noun class with the head N. If the head N is different, an element identical in behavior and function to *ava* but differently morphologically shaped will show up:

(144) *kándá idzi éé vatú vá- má-gwána na wutyá i- má- bono*

monkeys Agr-rel that people SM P2 chase in farm SM P2 ran

“The monkeys that men chased away from the farm ran away”

Vakutu and *vatu* all belong to class 2, while *kanda* belongs to class 10. What we might call the relativizer (which is not a *wh*-item) will have a different form each time: *ava* and *idzi*.

The data seem to indicate that this language is devoid of wh-relatives. But what is the structure of Tuki relatives? How are they derived? The Tuki data will be checked against theories developed by Kayne (1994), Bianchi (1999, 2000), Aoun and Li (2003). The structure and derivation proposed therein might have to be revised.

3.11 Topicalization

Topicalization is attested in this language. For illustration, consider the following constructions:

(145) a. Mbárá a- mu- báruúma na mbééré wáa na mbóó idzó íbisi

Mbara SM P2 meet with friend his in market yesterday morning

“Mbara met his friend at the market yesterday morning”

b. mbééré wáa, Mbárá a-má-báruúma na á ná mbóó ídzó íbisi

friend his Mbara SM P2 meet with res.pro.in market yesterday morning

“His friend, Mbara met him at the market yesterday morning”

c. na mbóó, Mbárá a-má- báruma na mbééré wáá t tidzo íbisi

in market Mbara SM P2 meet with friend his yesterday morning

“At the market, Mbara met his friend yesterday morning”

d. idzó, Mbárá a- má- báruma na mbóó na mbéere waa íbisi

yesterday Mbara SM P2 meet in market with friend his morning

“Yesterday, Mbara met his friend at the market in the morning”

e. íbisi, Mbárá a- má- báruúma na mbééré wáa na mbóó idzó t

morning Mbara SM P2 meet with friend his in market yesterday

“In the morning, Mbara met his friend at the market yesterday”

In the sentences (141b-e), NP, PPs and modifiers have been topicalized. The trace (t) marks the spot from which the topic was extracted.

Baltin (1978), Lasnik and Saito (1984, 1992) have argued that topicalization is adjunction to the left boundary of IP. Biloa (1992, 1995) imitated these researchers by claiming that Tuki behaves like English. In this respect, (145e) would be assigned the following phrase marker:

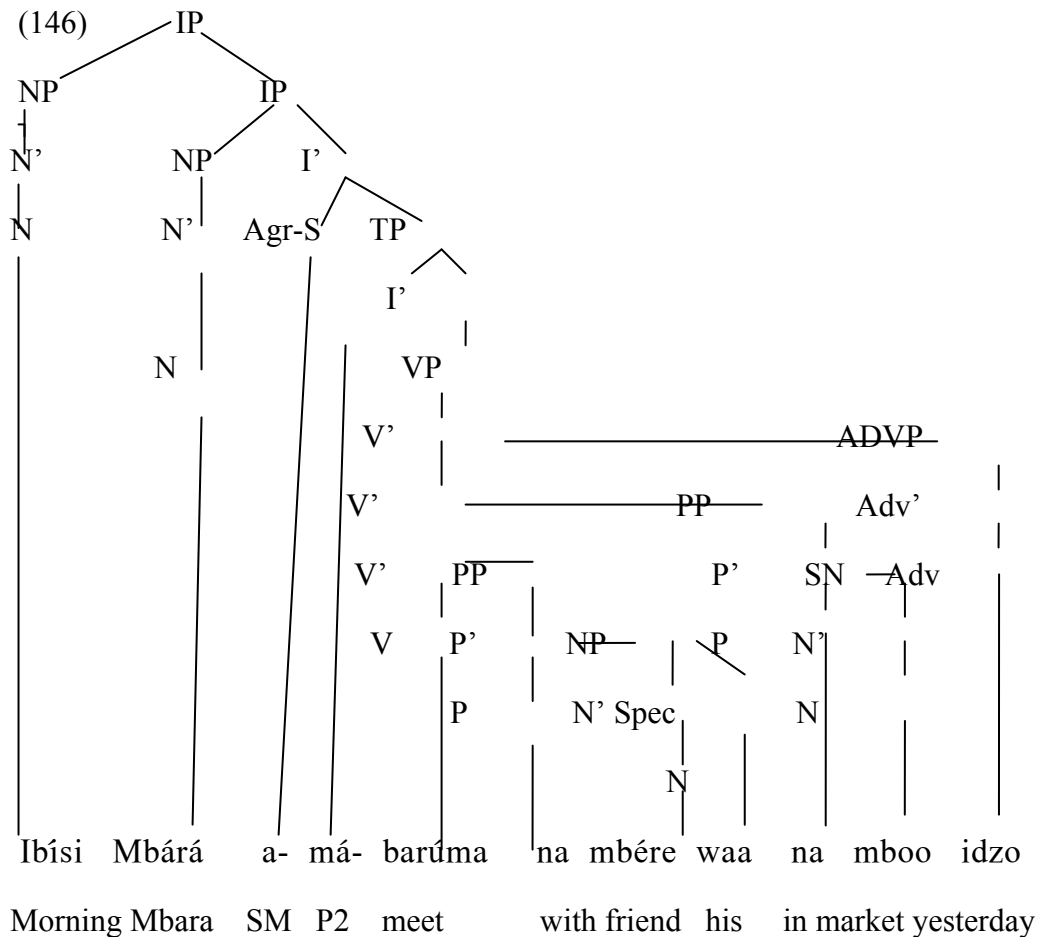

In the above phrase- marker, the topicalized NP *ibisi* “morning” is IP-adjointed à la Baltin, Lasnik and Saito. Contra the above position, Rizzi (1997) and Haegeman (2000) have demonstrated that topicalized constituents occupy the specifier position within a topic phrase. In subsequent chapters, it will be shown how the Tuki empirical material fares with respect to this latest proposal.

3.12 Resumptive pronouns

As indicated in Biloa (1990), resumptive pronouns are attested in Tuki. It is assumed with Peter Sells (1984_a, 1984_b, 1987) that resumptive pronouns are pronouns which appear in *wh*-movement constructions and which are directly bound by the operator, as in the following Tuki sentences:

(147) Biloa (1990, (7a, b, c))

a. mutu ódzú_i éé nu ngu –mu- d́ngam omwéne_i

man relativizer that I SM OM love him

“The man who I love him”

b. okutu ódzú_i éé nŭ ngu –mu- b́na na a_i / omwéne_i

woman relativizer that I SM P1 dance with her / she

“The woman who I dance with her”

c. mangádzu ódzú_i éé nŏsi wáá_i a- d́ngam Putá

child relaivizer that mother his SM loves Puta

“The child who his mother loves Puta”

In Biloa (1990:215), it was claimed that object pronouns in this language can refer only to NP’s bearing the feature [+ human], just like Object Markers (OMs). After much scrutiny, the above claim cannot be maintained, as evidenced by the following construction:

(148) ínŷinyi idzi_i éé nŭ n- d́ngam ímwéne_i

bird relativizer that I SM love it

“The bird that I love / like it”

Since bird is [- human], it has no OM (which we considered before to be pronouns, not anymore), but the strong pronoun ímwene “it” refers to that NP and agrees in noun class with it. As a matter of fact, the relativizer too agrees in noun class with ínŷinyi “bird”. In sum, contra Biloa (1990: 215), there can be overt subject resumptive pronouns just as there can be non overt ones.

In Tuki headed relative clauses, the head of the relative clause can be associated either with a resumptive pronoun or a variable:

(149)

a. [okutu] ódzú_i Mbárá a- má – mú- b́aná ómwéne_i

woman relativizer Mbara SM P2 OM marry her

“The woman whom Mbara married her”

b. [okutu] ódzú_i Mbárá a- má –mú- bání x_i

woman relativizer Mbara SM P2 OM marry

“The woman whom Mbara married ”

Relative clauses in Tuki are characterized by their lack of pied piping:

(150) [okutu] ódzú_i Mbárá a- n(á) –énda ma a_i na Púrasí

woman relativizer Mbara SM P2 go with her to Paris

“The woman with whom Mbara went to Paris ”

It is possible to relativize into an embedded relative clause and an embedded question. This seems to provide evidence that Complex Noun Phrase Constraint and Wh- Island Constraint violations (involving or not involving gaps) can be analyzed as resumptive pronoun binding cases and this explains why they can circumvent island violations:

(151) a. [okutu ódzú] [CP odzu_i [IP Mbárá i- dzímam [NP mutu [CP ódzú [IP a- má-

woman this relativizer Mbara SM knows man relativizer SM P2

mú- nóba omwene_i]]]]]]

OM beat her

‘The woman that Mbara knows the man who beat her’

b. [okutu ódzú [CP odzu_i [IP Mbárá i- dzímam [NP mutu [CP odzu [IP a-

woman this relativizer Mbara SM knows man relativiser SM

ma- mú- nóba x_i]]]]]]

P2 OM beat

“The woman whom Mbara knows the man who beat ”

(152)

a. [okutu ódzú] [CP odzu_i [IP Mbárá a- kábím [CP ǎndzu [IP a- má- mú-

woman this relativizer Mbara SM wonders relativizer SM P2 OM

beraána ómwéné_i]]]]]

all her

“The woman that Mbara wonders who called her ”

b. [okutu ódzú] [CP odzu_i [IP Mbárá a- kámbim [CP andzu[IP a- má-
woman this relativizer Mbara SM wonders relativizer SM P2
mu- bérana x_i]]]]]

OM call

“The woman that Mbara wonders who called ”

It will be argued in the main body of this work that gaps in Tuki should be analyzed as null resumptive pronouns which do not involve movement, on analogy with the full resumptive pronoun strategy available in the language. Evidence for this position is drawn from coordination facts and weak crossover effects in Tuki.

3.13 Anaphora and Binding

The Tuki facts seem to show that the domain for anaphor binding and the domain for pronominal non reference are not the same, although overlapping is sometimes possible (see Biloa 1991b). For illustration of the above claim, let us consider the following sentences:

(153)

a. vǎdzu_i vá- mu-tófa vǎmwámáte_i (ná) ósumbu

children SM P1 wash themselves in river

“The children_i wash themselves_i in the river”

b. vǎdzu_i vá- mu- dzá éé [vǎmwámáte_i va- nú-tófam (ná) ósumbu

children SM P1 say that themselves SM F1 wash in river

“*The children_i said that they would wash themselves_i in the river”

c.* vǎdzu_i vá- mu- dzá éé [nǔ ngu- mu- noba vǎmwámáte_i n(á) ósumbu]

children SM P1 say that I SM P1 beat themselves in river

“*The children said that I beat themselves in the river”

(154)

a. *[vatu_i vá- mu- w(ú)-éna pro_i/vámwéné_i]

men SM P1 OM see pro_i/them

“*The men_i saw pro_i/them_i”

b. vǎdzu_i vá- mu- dzá éé [pro/vámwámáte_i vá- nú- tófam (ná) ósumbu

children SM P1 say that pro_i they SM F1 wash in river

“The children say that pro_i/they_i would wash in the river”

c. vǎdzu_i vá- mu- dzá éé [Mbárá a- mu-wú- nóba pro_i/vamwéne_i n(á) osumbu]

children SM P1 say that Mbara SM P1 OM beat pro_i them in river

“The children said that Mbara beat pro_i/them_i in the river”

In (153a), the anaphor/reflexive *vamwamate* “themselves” behaves pretty much like its English counterpart in the same context: it is bound in a local domain and abides by principle A of the binding theory. In (153b), the anaphor *vamwamate* “themselves” is the subject of the embedded clause and is not bound inside it: the sentence is expected to be ungrammatical but it is not. Why? A solution will be provided in the chapter devoted to the treatment of anaphora. In (153c), the anaphor occurs again in the embedded clause and is in direct object position of the embedded verb. Once again, the reflexive *vamwamate* “themselves” is bound out of its local domain. But as expected, the sentence is ungrammatical. In (154a), the pronoun *vamwene* “them” is bound in its local domain, thereby violating principle B of the binding theory. A few remarks and observations are in order with respect to sentence (154a). In previous work (cf. Biloa 1991b:846), it was shown that *wu* (here specified as Object (M)arker)) was a pronominal corresponding to the English “them”. In fact, many researchers have argued about the pronominal status of the SM and OM (see Bresnan and Mchombo 1987; Mchombo 2004 and references cited therein). In Biloa (1992, 1995), it is extensively shown that the OM agrees in noun class with a direct object NP when the latter carries the features [+animte, +human]. In other words, when the direct object NP is non-human, no OM occurs inside the verb, which would tend to imply that the OM may be overt or covert.

Similarly, the direct object NP in Tuki may be overtly realized (by an NP or a full pronominal) or may be covert (in this case, as argued above, it is a null object called *pro*). So, to us and as far as Tuki is concerned, the SM and the OM are respectively subject and object agreement markers that are hosted by the verb.

Coming back to the data at hand, (154a-c) obey principle B which requires that pronouns be free in a local domain. So far, the local domain we have been talking about for an NP, be it an anaphor or a pronoun, is a clause. Now observe that a local domain for an NP can also be an NP:

(155)

a. *nũ- nga-ta-dingá* [ngedeno ra Mbára_i na wučo omwámáte_i]

I SM Neg love walking of Mbara in front himself

“I do not like Mbara’s behaviour toward himself”

b.* Mbára_i a- ta -dinga[ngedemo rame na wuco ómwámáte_i]

Mbara SM Neg love walking my in front himself

“Mbara does not like my behaviour toward himself”

(156)

a. **nũ ngu-m(u)-ena* [puta ra watu_i ra abu_i/vamwéné_i]

I SM P1 see pictures of men of them/themselves

“*I saw[the men’s_i pictures of them_i”

b. *watu_i vá- m(á)-ena*[puta rame rá abu_i/vamwene_i]

men SM P2 see pictures my of them

“The men_i saw [my pictures of them_i”

(157)

a. **nũ nga- m(á)-ena* [puta raa_i rá Mbara_i]

I SM P2 see pictures his of Mbara

“*I saw_i[his_i pictures of Mbara_i]

b. *pro_i/omwene_i a-m(á)-ena [puta rame rá Mbara_i]

he/she SM P2 see pictures my of Mbara

“*He_i/She_i saw [my pictures of Mbara_i]

In Tuki, as in several other languages (see Chomsky 1980, 1981 and Huang 1982), a possessive NP can either be an anaphor or a proximate pronoun:

(158)

a. Dima_i a-má-sera [tsonó ráa_i]

Dima SM P2 sell clothes his

“Dima sold his clothes”

b. Dima_i a-má-sera [tsonó ráamaté_i]

Dima SM P2 sell clothes his own

“Dima_i sold his own_i clothes”

So, it appears that in this language, sometimes, anaphors and pronouns are not mutually exclusive. The same position may be filled either by a pronoun (null or overt/strong, contrary to what is claimed in Biloa (1991b: 850):

(159)

a. Mbára_i a- b-[CP éé [pro_i/omwéné_i a- t- idzima [ngí[IP omwamate_i a- mú ongubi]]]]

Mbara SM say that he SM Neg knows if himself SM is thief

“Mbara_i says that he_i does not know whether himself_i is a thief”

b. Mbára_i a- b-[CP éé [pro_i/omwéné_i a- t- idzima [ngí[IP pro_i/omwene_i a- mú ongubi]]]]

Mbara SM say that he SM Neg knows if he SM is thief

“Mbara_i says that he_i does not know whether he_i is a thief”

Itv appears that in this language, the pronoun and the anaphor are mutually interchangeable without any resulting ungrammaticality, predicting therefore that the Nominative Island Condition (NIC) can be violated:

(160)

a. Mbárá_i a- nú-unám [_{NP} nyinyi[ídzí [éé [_{IP} ómwámáte_i a- nú-asíyám ná wútyá wáá]

Mbara SM F1 kill bird Rel. that himself SM F1 find/meet in farm his

“Mbara_i will kill the bird that himself_i will find in his farm”

b. Mbárá_i a-nú-unám [_{NP} inyinyi[ídzí [éé [_{IP} pro_i/omwene_i a- nú-asíyamí na wútyá wáá]

Mbara SM F1 kill bird Rel. that he SM F1 find/meet in farm his

“Mbara will kill the bird that he will find in his farm”

The above data and facts raise a number of problems that we will try to make an account of in the chapter dealing with anaphora and binding.

CHAPTER FOUR

The order of clausal functional heads Tense, Aspect, and Modality

4.1. Introduction

This chapter tries to determine the order of clausal functional heads in Tuki. Although this enterprise is independent of any considerations involving Adverbs and their relative order, it is theoretically closely related to issues in adverbial syntax because, as Cinque (1999, 2004) argued, "much as inflectional morphology, functional particles, and auxiliaries were at the time considered to be the overt manifestation, in head format, of the functional portion of the clause, Adverbs, [...], could be seen as the overt manifestation of the same functional distinctions in specified format. The main evidence for their belonging to the functional make-up of the clause was the observation that cross-linguistically the number and type of the different classes of adverbs and their relative order appears to exactly match the number, type and relative order of functional heads (cf. Cinque 1999, chapters 2,3 and 4)" (Cinque 2004, 683-684).

In Tuki, many clausal functional heads, as many as twelve, express notions that would normally be by adverbs. This seems to be a clue of their functional nature. Furthermore, many adverb classes are morphologically expressed by affixes: this explains certainly why aspect is so much affixal in this language. This situation is pretty much similar to what obtains elsewhere. Cinque (1999 : 213, fn. 79; 2004:685) reports "that in some languages (in Eskimo – Aleut languages, in the Sino-Tibetan languages Boro and Garo, and in the Uto-Aztecan language Chemehuevi) adverbs are for the most part expressed not as independent words but as bound morphemes, much as other functional morphemes are another indication, [...], of their functional character. In this connection, it is also significant that virtually every adverb class finds morphological expression as a suffix in some language (see Cinque, 1999 for several such examples, and Nilsen and Vinokurova, 2000 for an interesting proposal that unifies adverbs, affixes, and auxiliaries as verb raisers)".

This chapter is structured as follows. Sections 2 and 3 study respectively tense and aspect in Tuki. Co-occurrence restrictions of tense and aspect are considered in section 4; this section also looks at the evidence for the pairwise order of the different functional heads. Section 5 analyses modality, while section 6 attempts to interpret root and epistemic modalities. Section 7 proposes the overall order of clausal functional heads in Tuki.

4.2. Tense

Richards et al. (1985) consider tense to be the relationship between the form of the verb and the time of the action or state it describes. Since in English most tenses are marked by grammatical categories, Comrie (1986) defines tense as a “grammaticalised location in time”. In Tuki, tense is marked through the use of bound morphemes. Three past tenses, the present tense and two future tenses are attested in this Bantu language.

4.2.1 Past one (P₁)

The past tense one (P₁) is expressed by the morpheme /mu/ that indicates that the action occurred earlier in the day:

(1)

- a. o. ny- á
 Inf eat fv
 “to eat”

Atangana a – mu – ny – á cwí ibísi aye

Atangana SM P₁ eat FV fish morning this

b.

“Atangana ate fish this morning”

c. Atangana a - tó - o - ny - á

Atangana SM neg P₁ eat FV

cwi ibísi aye

fish morning this

“Atangana did not eat fish this morning “

(1a) exhibits the internal structure of the verb: /o/ is the infinitive marker, /ny/ is the root (also called base or stem) and /a/ is the final vowel (FV). (1c) shows that the negation marker is /to/ while the P₁ marker which is /mu/ turns into /o/ when it is preceded by /ta/ (negation marker)

4.2.2. Past two (P₂)

The past tense (P₂) is expressed by the morpheme /má/ that indicates that the action took place yesterday:

(2)

a. o - súw -a
inf wash FV

“to wash”

b. Ngono a - má -súw -a tsono ídzo
Ngono SM P2 wash FV clothes Yesterday

“Ngono washed clothes yesterday “

c. Ngono a - tá -á suw - a tsono ídzo
Ngono SM Neg P2 wash FV clothes yesterday

“Ngono did not wash clothes yesterday”.

As (2c) shows, the P2 morpheme /mà/ becomes /a/ when it is preceded by the negation marker /ta/

4.2.3. Past three (P3)

The past tense three is expressed by the morpheme /mà/ that indicates that the action occurred earlier than yesterday:

(3)

a. ò - bán - á
inf marry FV

« to marry, to wed »

b. Numongo a - ma - ben - a
Numongo SM p3 marry FV
agee wa were a - dzii ombwene
wife his when SM be young

“Numongo married his wife when he was a young man”

c. Numongo a -tá- má- băn- a agee wáá were a- dzíí ómbwéne
Numongo SM Neg p3 marry FV wife his when SM be young

“Numongo did not marry his wife when he was a young man”

4.2.4. Present (P₀)

The present tense is characterised by the absence of an overtly realised morpheme and by the occurrence at the end of the verb (after the final vowel) of an incompletive aspectual morpheme:

(4)

a. o - wǎn - a
inf sing FV
« to sing »

b. Bera a - wǎn- á - m osánu
Bera SM sing FV incomplete Song

c. Bera a- tá- wǎn- a – Ø osánu
Bera SM Neg sing FV Imperf. Song
"Bera does not sing a song"

Notice that the incomplete aspectual morpheme /m/ is absent from the verb form in (4c) due to the fact that the latter is negated and therefore the action expressed is viewed as complete. This explains why this morpheme occurs in the present tense and the two future tenses: the action expressed by the verb in these tenses is not over at the time of speaking.

4.2.5. The future one (F1)

The future tense one (F1) is expressed by the morpheme /nú/ that indicates that an action will occur later during the same day or tomorrow (latest). The incomplete aspectual marker /m/ closes off the verb:

(5)

a) o- námb- a
inf. cook FV
"to cook"

b) Pasa a- nú- námb- a- m
Pasa SM fl cook FV incomplete
Vibúfa anénga aye
Vegetables evening this

"Pasa will cook vegetables this evening"

c. Pasa a- tá- nú- námb- a vibúfa anénga aye
Pasa SM Neg fl cook FV vegetables evening this

"Pasa will not cook vegetables this evening"

4.3. The future two (F2)

The future tense two (F2) is expressed by the morpheme /mú/ that indicates that the action will take place after tomorrow. The incompletive aspectual marker/m/ occurs at the end of the tensed verb:

(6)

a. o- fow- á
inf. Build FV
"to build"

b. Bāba a- mú fów- á- m kíísini kóró isi amó
Father SM F2 build FV incompletive kitchen there day some
"Father will build a kitchen there some day"

c. Bāba a- tá- nú fów- a kíísini koro isi amó
Father SM Neg fl build FV kitchen there day some
"Father will not build a kitchen there some day"

In the two future tenses (as well as in the present tense), when the verb form is negated, the incompletive aspectual morpheme/m/ disappears. This seems to indicate that the completive aspectual morpheme is Ø, as the three past tenses discussed above clearly indicate.

4.3.Aspect

Cinque (1999, chapter 4, section 4.4) indicates that "two quite different things fall under the term "aspect", which are often, though not always, kept separate in the literature. One is the internal structure of the event, or situation, as lexically expressed by the predicate and its arguments: whether it has a beginning or end, internal stages, etc. Vendler's (1967) classical typology distinguishes among "activities" (*run, push a cart*), "states" (*know, desire*), "accomplishments" (*run a mile, build a house*), and "achievements" (*reach the top, find a wallet*).

The other refers to the particular way in which the speaker presents the event, or situation, through grammatical means: e.g., as terminated (through the perfect aspect: *John has run a mile*), as on- going 'through the progressive aspect: *John was running a mile*); as habitual (through the habitual aspect: *John used to run a mile*), etc."

To put it simply, aspect deals with the manner in which verbal action is experienced in terms of progression or completion. In other words, aspect is concerned with the duration of an action: complete or incomplete, perfective or imperfective (Mutaka 2000: 185).

In Tuki, aspect is marked by verbal affixes (infixes and suffixes). If most of the aspectual morphemes in Tuki are verbal infixes, two are suffixes (the completive and the incompletive aspects, respectively /ø/ and /m/ that occur in V final position, after the final vowel). The aspectual morphemes attested in this language are the following: the habitual aspect /fu/, the retrospective aspect /ru/, the progressive aspect /Kutu/, the semelrepetitive or semeliterative aspect /dzoo or /dzu/ (its form undergoing some allomorphy on the basis of the context of occurrence), the so called anterior aspect /munu/, the completive aspect /ø/, the incompletive aspect /m/, the attenuative aspect /et/, the repetitive aspect /an/ and the quantitative aspect that consists in reduplicating partially or totally the verb stem.

In the following lines, an attempt is made at defining each aspect as it relates specifically to the Tuki data and illustrating it with concrete examples.

4.3.1. The habitual aspect

Cinque (1999) quotes Comrie (1976 27f) who defines habitual aspect as describing " a situation which is characteristic of an extended period of time" [...], and explicitly distinguishes it from iterative or frequentative aspect, which indicates "the more repetition of a situation".

The habitual aspect expresses the notion of habit. It indicates that the action encoded by the verb is usually carried out. This aspect is expressed by the morpheme /fu/:

(7)

a. o - tír- a
inf write FV

"to write"

b. ngómane a- fu- tir- a- m vakárate na wutsóó
governor SM hab write FV Incompl. letters at night

"The governor usually writes letters at night "

c. ngómane a- tá- fu- tír- a
Governor SM Neg hab write FV
Vakárate ra wutsóó
Letters at night

"The governor does not usually write letters at night"

In the above examples (b-c), the tense marker is not overtly realized, as is normal with the present tense. It should, however, be borne in mind that most aspectual morphemes in

Tuki, apart from the perfective and imperfective ones, occur after the tense marker and precede the verb root, as illustrated by the following example:

(8)

a. o- rang- a
 inf read FV
 "to read"

b. Pára a nu- fu- rang - á- m
 priestSM fl hab read FV Incompletive

Karáte a Sambeibísi yíma
 Letter/book of god morning all
 "The priest will usually read the bible every morning"

c. Pára a - tá - nu - fu - rang - a
 Priest SM Neg fl hab read FV
 karáte a Sambe ibísi yíma
 Letter/book of god morning all
 "The priest will not usually read the bible every morning"

4.3.2. The retrospective aspect

The retrospective or momentaneous aspect expresses the notion that an action has just been completed (Louwerse, 1988, 63). It is encoded by the morpheme /ru/.

(9) o- gur- a
 Inf. press FV
 "to press"

b. Orómo a- ru- gur- a tsono
 Oromo SM RETRO press FV clothes
 "Oromo has just pressed clothes"

c. Orómo a- tá- ru- gur- a Tsono
 Oromo SM Neg RETRO press FV clothes
 "Oromo has not just pressed clothes"

The retrospective aspect describes an action that has just ended in the past. This explains why, although the verb is in the present tense, there is no incompletive aspectual marker (cf. (9b))

4.3.3. Continuative /roo/, Terminative /dzú/

The continuative aspect is encoded by the morpheme /roo/ that is translated in English by "still". It expresses the notion that the action is in progress and therefore has not come to an end; the action is continuing, hence its name. Haspelmath (1993, 145) indicates that "still" is related to continuative aspect and "no longer" seems related to terminative aspect. Cinque (1999) adds that, given the above, "we could take terminative and continuative to be two values (perhaps, marked and unmarked, respectively) of one and the same aspectual head". In Tuki, when the verb is in the affirmative form, the continuative aspect morpheme is /roo/. If the verb is negated, the morpheme becomes /dzú/, the terminative aspect morpheme:

(10)

a. Masina a- roo- rang- a karáte
Masina SM CONT read FV letter/book

"Masina is still reading the letter/book"

b. Massina a- tá- dzu- rang- a karáte
Masina Sm Neg TER read FV letter/book

"Massina is no longer reading the letter/book"

The terminative aspect is also called cessative aspect (Binnick 1991, 204; Frawley 1992, 321). Semantically, the continuative aspect is very close to the progressive aspect. But the morphemes that encode these two aspects are morphologically different /roo/ and /kutu/, on the other hand, the terminative aspect morpheme /dzú/ looks morphologically like one of the semelrepetitive aspect morphemes /dzù/, the other one being /dzoó/. However, semantically and morphosyntactically, the terminative and the semelrepetitive aspects behave differently, as we will see. The continuative and terminative aspects appear to be compatible only with completive forms of the verb.

4.3.4. The progressive aspect

The progressive aspect that is expressed by the morpheme /kutu/ indicates that the action is in progress:

(11)

a. o- fá- a
inf. clear FV

"To clear, weed out"

b. Isondo a- má- kutu- fá- a wutya
 Isondo SM P2 prog clear FV farm

"Isondo was clearing the farm"

c. Isondo a- tá- a - kutu- fá- a wutya
 Isondo SM Neg P2 prog clear FV farm

"Isondo was clearing the farm"

4.3.5. The semelrepetitive aspect

The semelrepetitive or the semeliterative aspect is encoded by the morphemes /dzoo/ or /dzu/. It indicates that the action expressed by the verb is iterative or is repeated a number of times. The form of the morpheme is dictated by the surrounding environment. It is semantically equivalent to the adverb *again*.

(12)

a. o- mu- a
 inf. shave FV

b. Aróno a mutu i- dzoo- mw- a nutongo náá
 old of man SM again shave FV Beard his

"The old man shaves his beard again"

c. Aróno a mutu i- mu- dzu- mw- a nutongo náá
 old of man SM P1 again shave FV Beard his

"The old man has again shaved his beard"

e. Arono a mutu i- tó- o- dzu mw- a mutongo naa
 old o man SM Neg P1 again shave FV beard his

"The old man has not shaved his beard again"

Notice that in sentence (11b), although the verb is in the present tense, the imperfective aspectual marker, /m/, is nowhere to be seen. This seems to mean that the latter is incompatible with the semelrepetitive aspectual morpheme /dzoo/. (11b, c, d, and e) show that this aspectual morpheme is subject to allomorphy, the details of which are beyond the scope of this enterprise.

4.3.6. The anterior aspect

Most linguists would associate the feature *anterior* with tense (cf. Cinque (1999)). But in Tuki, it seems to be the case that it should be linked to aspect because the morpheme

encoding it co-occurs with tense markers. And in this language, there is no instance where two tense markers co-occur.

The anterior aspect is materialized by the morpheme /munu/ that indicates that the action expressed by the verb has already been realized. As a matter of fact, this morpheme means *already*.

(13)

a.	o-	bún-	a			
	inf.	open	FAV			
b.	Mangádzu	a -	mu-	munu-	bún-	a
	Child	SM	P1	already open		FV
	karáte	wa	ísa			
	letter	of	father			

"The child has already opened his father's letter"

c.	Mangádzu	a-	tó-	o-	munu
	child	SM	Neg	P1	already
	bún-	a-	karáte	wa	ísa
	open	FV	letter	of	father

"The child has not get opened his father's letter"

4.3.7. The incomplete and completive aspects

The incomplete aspect, which is marked in Tuki by the suffix /m/, indicates that the action or situation portrayed by the verb is still in the making: it is either a habit or it is in progress; it has not yet been completed. The opposite of this aspect is the completive which is marked by a zero morpheme. The completive aspect expresses the notion of completion. It indicates that the action encoded by the verb has ended.

The completive aspectual morpheme /m/ occurs in the present tense (Po) and in the two future tenses (F1) and F2) if the verb is in the affirmative form. It disappears if the verb is negated.

(14)

a.	o-	ró	ó			
	inf.	poison	FV			
		"to poison"				
b.	Oróórógi	a-	ró-	ó-	m	mbéébeno wáá
	sorcerer	SM	poison	FV	incomplete	ennemi his

"The sorcerer poisons his enemy"

b. Oróórógi	a-	nú-	ró-	ó	m
sorcerer	SM	f1	poison	FV	Incompl.

"The sorcerer will poison his enemy (tomorrow)"

c. oróórógi	a-	mú	ró-	ó-	m
sorcerer	SM	f2	poison	FV	Incompl.

mbéébeno	wáá	isí	amó
enemy	his	day	some

"The sorcerer will poison his enemy one day"

(15)

a. oróórógi	a-	tá-	ró-	ó	mbéébeno	wáá
sorcerer	SM	Neg	poison	FV	enemy	his

"The sorcerer does not poison his enemy"

b. Oróórógi	a-	tá-	nú-	ró-	ó
sorcerer	SM	Neg	f1	poison	FV

mbéébeno	wáá	nambari
enemy	his	tomorrow

"the sorcerer will not poison his enemy tomorrow"

c. Oróórógi	a-	tá-	mú-	ró	ó-	
Sorcerer	SM	Neg	f2	poison	FV	Incompletive.

mbéébeno	wáá	isí	amó
Enemy	his	day	some

"The sorcerer will not poison his enemy some day"

So far, we have talked about Tuki aspectual morphemes that occur (respectively) after the agreement (SM), negation (Neg), and tense markers and precede the verb stem. However, there are other aspectual morphemes that occurs immediately after the verb stem and before the final vowel (FV). They include the attenuative, repetitive (iterative) and possibly the quantitative aspectual morphemes.

4.3.8. The attenuative aspect

The attenuative aspect indicates that the action encoded by the verb is less intense than it might have been had the alternative morpheme been absent. This marker can be suffixed to both transitive and intransitive verb stems.

(16)

- a. 0 - băng - a → 0 - bang - et - á
inf. cry FV inf. cry Att. FV
"to cry" "to cry a little bit"
- b. O - sos - o → o - sos - et - á
inf. suck FV inf. suck Att. FV
"to suck" "to suck a little bit"
- c. o - gúr - a → 0 - gor - et - á
inf. grind FV inf. gring Att. FV
"to grind" "to grind a little bit"

In (16 c), the quality of the vowel of the verb stem has changed ([u] has become [o] after affixation of the attenuative morpheme to the verb stem: a classical case of vowel harmony).

(17)

- a. Mbárá a - mu - báng - ét - a ara nǒsi a - mu - gw - á
Mbara SM P1 Cry Att. FV when mother SM P1 die
"Mbara cried a little bit when his/her mother died"
- b. Mbárá a - tó - o - báng - ét - a ara nǒsi a - mu - gw - á
Mbara SM Neg P1 Cry Att. FV When mother SM P1 die FV
"Mbara did not cry when his/her mother died"

4.3.9. The repetitive (iterative) aspect

The repetitive aspect that is expressed by the morpheme /an/ indicates that the action encoded by the verbs can be repeated. One can say that the affix / an/ has the meaning "several times", "time and again":

(18)

- a. W- aádum - a → w- aádum - an - a
inf. fall FV inf. fall Rep FV
"to fall down" "to fall down several times"
- b. o - ny - á → o - ny - án - a
inf. Eat FV inf. Eat REP FV
"to eat" "to eat several times"
- c. w- aány - o → w - aany - ón - o
inf. drink FV inf. drink REP FV

“to drink “	“to drink several times”
d. o – bet - e →	o – bet – én – e
inf. Sleep FV	inf. Sleep Rep FV
"to sleep "	"to sleep a lot or much"

(19)

a. vǎdzu	va-	mw [u]	- aádum – an – a	na	vítófo
children	SM	P1	fall	REP FV	in mud
"Children fell down in the mud"					

b. Vǎdzu	va-	tá	mw [u]	- aádum – an – a	na	vítófo
children	SM	Neg	P1	fall	REP FV	in mud
"Children did not fall down in the mud"						

Notice that in (17a, b, c, d) the vowel of the repetitive aspectual morpheme is identical to the final vowel: this looks like another case of vowel harmony.

4.3.10. The quantitative aspect

The quantitative aspect indicates that the action of the verb is intensified. It is encoded by reduplicating totally or partially the verb stem. This specific word formation process does not seem to be very productive in the language, as illustrated by the fact that there is only one example.

(20)

a.	o-	ny – á	→	O – ni	ny – á
	inf. Eat	FV		inf. Quant	Eat FV
	“to eat”			“to eat a lot or much”	
b.	vatu	va – níny -	á - m	n(a)	ibino
	people	SM	Quant eat	FV Incompl.	in feast
	“people eat a lot/ much during festivities”				
c.	Vatu	va - tá	- ní - ny	- á	n(a) ibíno
	people	SM	Neg	Quant eat	FV in feast
	"people do not eat a lot/much during festivities"				

After a presentational look at tense and aspect in Tuki, it is worth considering their co-occurrence restrictions and determining their order of occurrence.

4.4. Co-occurrence restrictions of tense and aspect

Before delving into the examination of the interaction between tense and aspect, let us talk briefly about modals. In Tuki, there seem to be two modal verbs:

(21)

- a. o – fít - í
 inf. can FV
 “can, to be able to “
- b. o – yán – á
 inf. must FV
 " must, to have to"

While these root modals cannot have aspectual morphemes affixed to them, they can be inflected for agreement, negation and tense. They also must select an infinitival complement:

(22)

- a. iyére a- yán – á – m o – yér – é
 teacher SM must FV Incompl. Inf. teach FV

vădzu tááng

Children Calculus

"The teacher must teach children calculus

- b. Vatu va – má – fít - í o – gwá
 people SM P2 Can FV inf. die

ífundu na adsidang wa ntsína

much in accident if train

"many people could have died in the train accident"

Having summarily discussed the status of root modals as regards, tense and aspect, let us concentrate on the interaction of tense and aspect. First of all, two tense markers cannot co-occur in Tuki, as it was said earlier:

(23)

- * Viróó a - má - nu - énd - á - m
 Viroo SM P2 F1 go FV Imperf.
 na mbóó ngi pro á- tím - a mbámá
 to market if SM P2 possess FV money
 “Viroo would go to the market if he had money”

Even if the sequence of tense markers in (23) above is reversed, the result will still be an ungrammatical sentence. So it appears that in this language only one tense marker is allowed

per clause (irrelevant details omitted). On the other hand, as we shall see, several combinations of aspectual morphemes (in a fixed order) are possible. Facts will clearly emerge as the demonstration proceeds.

The methodology adopted consists in considering “the evidence for the pairwise order of the different functional heads” (Cinque 1999). The resulting orders should, by transitivity, allow us to come up with “a single overall order of heads” for the Tuki language.

4.4.1. T (Past) > Mode_{epistemic}

Evidence for this order comes from the following examples:

(24)

a. Amina a - má - yǎn - o – fítí werd a n Duwára

Amina SM P2 must/FV Inf. can go FV to Douala

“Amina should have been able to go to Douala”

b. Purusu i – mu – yǎn – a urbǎn- a ongúbi omu

police SM P1 must FV inf. catch FV thief this

“The police should have caught this thief”

4.4.2. Asp_{habitual} > Asp_{Anterior} > Asp_{completive}

The anterior aspect goes hand in hand with the completive aspect (which is not overtly realized). Even when the anterior aspect is associated with one of the future tense markers (that should automatically induce an incompletive aspect), it is followed by the completive aspect:

(25)

Mbára a- nu - munu ny - á - ndóne

Mbara SM F1 ANT eat FV cow

“Mbara will have already eaten beef”

As (25) shows, despite the presence of F1, there is no incompletive aspect markers (/m/) due to the presence of the anterior aspect. This provides prima facie evidence

That Asp_{anterior} and Asp_{completive} constitute a happy couple.

There is also no doubt about the fact that the habitual aspect precedes the anterior/perfective aspects, as evidenced by the following construction:

(26)

Nyasa a - fu - munu - namb - á mbúngú

Nyasa SM hab ANT Cook FV cassava

“Nyasa has habitually cooked cassava already”

Before moving on to another order, notice that the incomplete marker is further away from the stem than the habitual marker in Tuki:

(27) Nyasa a - fu - ny - á - m mbúngú

Nyasa SM hab eat FV Incompl. cassava

“Nyasa habitually eats cassava”

In (27) above, the incomplete marker /m/ is separated from the stem by the final vowel /a/, whereas the habitual marker is next to the verb stem, although it is possible to have some other aspectual morphology intervene between the two.

4.4.3. $\text{Asp}_{\text{Continuative}} > \text{Asp}_{\text{anterior}}$

The following Tuki sentence provides evidence that the above order is attested in the language:

(28)

Ambáta a - róó - munu - ny - á kúrú

Ambata SM still already eat FV rat

CONT ANT

“Ambata is still already eating rat”

In the above grammatical sentence, the continuative aspect morpheme /roo/ must necessarily precede the anterior aspect morpheme. This is again prima facie evidence that the latter morpheme cannot be tense for, if it were, it would precede the continuative aspect morpheme.

4.4.4. $\text{Asp}_{\text{terminative}} > \text{Asp}_{\text{anterior}}$

The opposite of the continuative aspect morpheme is the terminative aspect morpheme, /dzú/, which also must precede the anterior aspect morpheme:

(29)

Ambáta a - tó [á] - o - dzu - munu ny - á kuru

Ambata SM Neg P1 TER ANT eat FV rat

“Ambata has no longer eaten rat already”

The above discussion has already established the evidence with respect to the above order.

The following illustrates its veracity:

(30)

Olwa o - munu - énd - a - o na miisono

Olwa SM ANT go FV compl.- to church

“Olwa has already gone to church”

In (28), after the final vowel of the verb is postulated the existence of a zero morpheme characteristic of the completive aspect which, in this sentence, is preceded, as expected, by the anterior aspect.

4.4.5. $\text{Asp}_{\text{retrospective}} > \text{Asp}_{\text{perfect}}$

This order is attested while the reverse is not

(31)

Nu ngu – má – rw – tóf – a – Ø na osúbú
 I SM P2 RETRO wash FV Compl.. in river

“I just bathed in the river”

The order $\text{Asp}_{\text{anterior}} > \text{Asp}_{\text{retrospective}}$ is not valid in this language:

(32)

* Nu ngu - munu - ru - bang - a
 I SM ANT RETRO Cry FV

4.4.6. $\text{Asp}_{\text{retrospective}} > \text{Asp}_{\text{progressive}}$

This order is ok in Tuki:

(33)

Nu ngu – ru - kutu - tiàr – a
 I SM RETRO prog. write FV

Karaàte aàme ibiàsi aàyeà

Book my morning this

"I have just been writing my book this morning"

4.4.7. $\text{Asp}_{\text{progressive}} > \text{Asp}_{\text{prospective}}$

It is impossible to check the validity of this order since Tuki is devoid of the prospective aspect marker.

4.4.8. $\text{Asp}_{\text{progressive}} > \text{Asp}_{\text{semeliterative}}$

This order is attested in the language:

(34)

Vaèùdzu va -kutu - dzu - dzodzoèùn - o ndaàmba
 Children SM prog again Play FV ball

“children are playing soccer again”

(35)

Ndongta a- maà- kutu- dzu- kuàs- a maàbaàruà
Doctor SM P2 prog. Again buy FV medicine
“the doctor was buying medicine again”

4.4.9. $\text{Asp}_{\text{prospective}}$ \triangleright $\text{Asp}_{\text{completive}}$

The prospective aspect is not attested in Tuki.

There are also instances in this language where at least three aspectual morphemes are affixed to the verb:

(36)

Paàra a - ru - kutu - dzu- any on - o biàya
Priest SM RETRO prog. again drink REP FV beer
“the priest has just been drinking beer again repeatedly”

(37)

Tsanu a - mu - munu- dzu- mem et - a owundu
Tsanu SM P1 Already again plant ATT FV peanuts agains
« Tsanu has already planted peanuts again a little bit”

(38)

a. Mapuri a – munu - kutu - nià – ny – àà aàkondo
Mapuri SM ANT prog QUAN eat FV plantain
“Mapuri has already been eating plantain a lot/much”

b. Mbusa a - roo - munu - kutu
Mbusa SM still already prog.
CONT ANT

dzu - fwa - tet - a kuru
Semelrepetitive roast ATT FV rat again

“Mbusa has already still been roasting rat again a little bit”

Notice that the repetitive and alternative aspectual morphemes occur stem finally, immediately before the final vowel, whereas the quantitative one immediately precedes the stem. This means that the order of clausal functional heads will end with the quantitative repetitive/alternative aspects, followed by the incomplete/completive aspect.

The above discussion should lead us to posit an order of clausal functional heads for Tuki, but we will postpone that until later when we have looked at modality.

4.5. Modality

Until now we have not talked so much about mood. Its presence might have been felt but it has not been touched upon in detail and systematically. It is the aim of this part of the endeavour to dissect the sequencing of modality on Tuki and study the sets of modal operators attested in the language: mood markers and so called modal auxiliaries. As far as mood markers are concerned, there are the marker of condition (*ngi* “if, whether”) and the marker of time adjunct clause (*ara* “when”). These two elements are exemplified in the following paradigm:

(39)

a. Ngi Dima i- b- a moni ame,
 if Dima SM steal SM money my
 Purusu I - nu - mu - umbaaàn - aà – m
 Police SM fl Om Catch FV Incompl.

“If Dima steals my money, the police will arrest him”

b. Ara mwána áme a- mú – ba- n - á- m okutu wáá, nu
 When child my SM F2 marry FV Incompl. woman his I
 ngu - mú mu - fá- m matuwa
 SM f2 OM offer FV Incompletive car

“When my son will marry his wife, I will offer him a car”

Ngí can also introduce indirect questions in embedded contexts:

(40)

Iyére a - mu - sés - a (ee) ngi vǎdzu a súkúru va- m(á) - énd –
 Teacher SM P1 Ask FV that whether children of school SM P2 Go
 a n(a) iwaána
 FV on vacation

"The teacher asked whether school children had gone on vacation"

The time adjunct clause operator, *ara*, can also occur in embedded contexts, but it can never introduce an embedded yes—no question, nor can it help form a (direct) matrix interrogative.

This (latter) role is devoted to the wh- item *ni* "when".

(41)

Nu ngu- nu- dzi- í- m awo
 I SM fl be FV Incompl. there
 ara bǎba a- dzu- m et- a na manoó
 when father SM REP Incompl. come FV from work

"I will be there when father comes back from work"

(42)

a. Iyére	a-	mu sés-	a (ée) ni	owu vǎdzu	a súkúru	va-	n(u)-
teacher	SM	P1 ask	FV that	when Foc	children of school	SM	fl
énd-	á-	m	n(a)	iwaána			
go	FV	Incompl.	on	vacation			

"The teacher asked when school children will go on vacation"

b. Ni owu Mbárá a- un-fów á- m yéndze gara wáá?

When Foc Mbara SM fl build FV Incompl. House his

"When will Mbara build his house?"

Moreover, the time adjunct clause operator, *ara* "when" can be directly selected by and be the complement of the lexical complementizer *ée* "that":

(43)

Pára	a-	mu-	dz-	a-	ée	ara					
Priest	SM	p1	say	FV	that	when					
bisóbo	a-	r-	á-	m,	i-	n-	i-	o-	mu-	dzǎn-	a
bishop	SM	come	FV Incompl	SM	must	FV	SM OM	tell	FV		

"The priest says that when the bishop arrives, you should tell him"

The different positions of *ée*, and *ni* in the sentence raise the questions of the structure of the left periphery in this language. In earlier works (Bilola 1992, 1995), it was argued that moved wh- words in interrogatives substitute for the specifier position of a functional focus phrase (FP), the head of which (F) is occupied by a so called focus marker, while the head of CP (C°) accommodates the lexical complementizer (*ée* "that"):

(44)

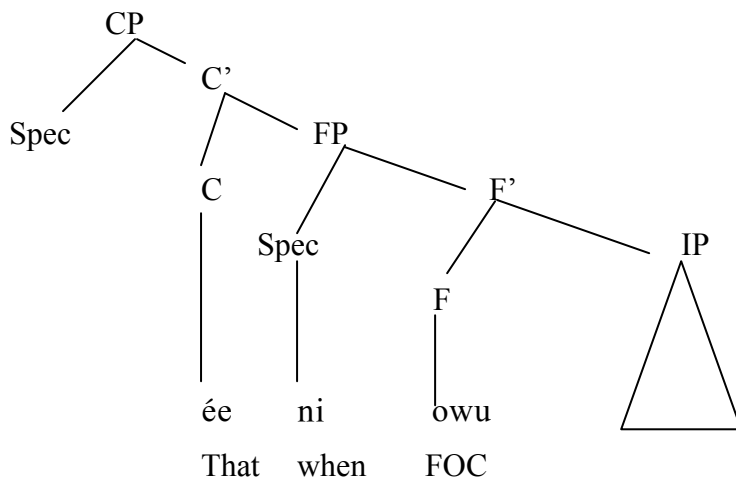

In recent work inspired by Rizzi (1997, 2004), it is indicated that *éé* "that" merges in the head of ForceP (Force°) and *ngi* "if, whether" is the head of IntP (Int°).

(45)

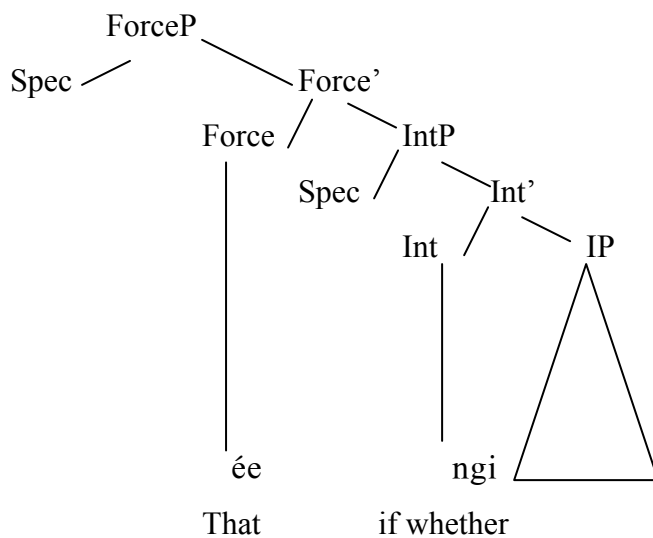

There remains the problem of *ara*: what position does it occupy in the phrase marker?

(46)

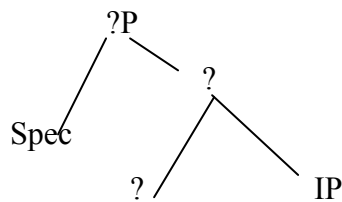

ForceP dominates the maximal projection that hosts *ara*; therefore ForceP is disqualified as a potential host. It can neither be FocP nor IntP, *ara* is not focalized and is not an interrogative operator. Let us tentatively assume that it merges in the spec position of Rizzi's (2004) Modifier Phrase (ModP), just like *tomorrow* or *recently* would:

(47)

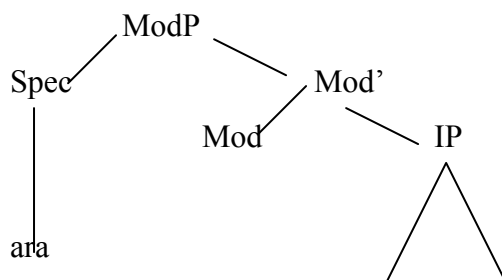

At the beginning of section 4, we briefly talked about root modals.

They are differently referred to in literature : Cinque (1999) terms them root modals, whereas Aboh and Nauze (2007) call them modal auxiliaries. As stated above in section 4, these modals include:

(48)

a. o- fit- í
 inf. can/may FV

"can /may"

b. o- yǎn – a
 Inf. must/have to FV

"must/have to"

(48a) encodes probability or ability/ capacity, while (48b) expresses strong deontic mood. For illustration, consider the following examples:

(49)

a. Atangana a- tá- fit- í o- kús a matúwa tété ódzu

Atangana SM Neg can/may FV inf. buy FV car since this

"Atangana can/may not buy a car now"

b. Atangana a- tá- yǎn- a- o- kús - a- matúwa tété ódzu

Atangana SM Neg must/have to FV inf. buy FV car since this

"Atangana must not buy a car now"

Negation in these two sentences precedes root modals. Moreover, these two modals combine with tense markers:

(50)

a. Atangana a- tá- má- fit- í

Atangana SM Neg p2 can/may FV

o- kús- a matúwa tamá máte

inf. Buy FV car time that

"Atangana could not buy a car at that time"

b. Atangana a- tá- má- yǎn- a

Atangana Sm Neg pz must/have to FV

o- kús- a- matúwa tamá máte

inf. buy FV car time that

"Atangana must not have bought a car at that time"

Similarly these root modals may co-occur with aspectual morphology; that is, aspect morphemes can be affixed to their stems, just as incomplete/completive morphemes can be suffixed to them:

(51)

a. Mbárá a- fít- í- m- o- kús- a matúwa omu
Mbara SM can FV Incompl. Inf. buy FV car that

"Mbara can buy that car"

b. Mbárá a- tá- fít- í- ø o- kús- a matúwa owu
Mbara SM Neg can FV Comp inf. buy FV car that

"Mbara cannot buy that car"

(52)

a. Mbárá a- yǎn- á- m o- kús- a matúwa omu
Mbara SM must FV Incomp. Inf. buy FV car that

"Mbara must buy that car"

b. Mbárá a- tá- yǎn- a- ø o- kús- a matúwa omu
Mbara SM Neg must FV Incompl. Inf. buy FV car that

"Mbara must not buy that car"

These sets of examples show that root modals can be inflected for incomplete /complete aspect.

(53)

Mbía a- fu- dzu- fít- í- m
Mbia SM hab again can FV Incompl.

o- root- a- werete
inf. climb FV tree

"Mbia can habitually climb the tree again"

(54)

Mbía a- ru- kutu- yǎn- a
Mbia SM Retro Prog. Must FV

w- énd - a na wáspita amu pro
inf. go FV to hospital as

a- no- m
SM sick Incompl.

"Mbia is just going to the hospital as he/she is sick"

In the above two sentences, the stem of each of the root modals is preceded by two aspectual morphemes. So there is overwhelming evidence that root modals can co-occur with tense and aspect:

(55)

a. Mápuri a- nu- dzoo- byán- á mwána ondyé
 Mapuri SM fl again give birth FV child other

"Mapuri will give birth to another child "

b. Mápuri a- dzoo- fít- í- o- byán- á mwána ondyé
 Mapuri SM again can FV inf. give birth FV child other

"Mapuri can give birth to another child again"

c. Mápuri a dzoo- yǎn- a o- byán- a- mwána ondyé
 Mapuri SM again must FV Inf. give birth FV child other

"Mapuri must give birth to another child again"

It is possible for the two root modals to co-occur side by side. Which order is attested?

(56)

a. Mápuri a- yǎn- á- m- o- fít- i
 Mapuri SM must FV Incompl. Inf. can FV
 o- byán- á- mwána ondyé
 inf. give birth FV child other

"Mapuri must be able to give birth to another child"

b.*Mápuri a- fít- í- m o- yǎn-
 Mapuri SM can FV Incompl. Inf. must
 a o- byán- á mwána ondyé
 FV inf. give birth FV child other

While the order *oyana o fiti* "must be able to" is OK, the reverse is not all that grammatical. The status quo is maintained when the semel-repetitive aspect /dzoo/"again" is affixed to the first occurring modal in the clause:

(57)

Mápuri a dzoo- yǎn- a o- fít
 Mapuri SM again must FV inf. can
 i o- byán- á mwána ondyé
 FV inf. give birth FV child other

"Mapuri again must be able to give birth to another child"

b.* Mápuri a- dzoo- fít- i
 Mapuri SM again can FV

o-	yǎn-	a-	o-	byán-	á
inf.	must	FV	inf.	Give birth	FV
mwána	ondyé				
child	other				

The above data seem to demonstrate that, underlyingly, *oyana* "must" precedes *ofiti* "can/be able to":

Mood [*oyana*, must] > Mood [*ofiti*, can]

Above, it was shown that root modals can co-occur with the past tense marker or the present tense marker and with aspect marker(s). It would be interesting to find out whether such co-occurrence is possible with the future.

(58)

a. Kunu	a-	nu-	yǎn	á-	m		
KunuSM	fl	must	FV	Incompl.			
o-	pet-	e	ofutu	raa	ara	pro	
inf.	close	FV	fl	her/his	when		
a-	gus-	a-	m				
SM	go out	FV	Incompl.				

"Kunu will have to close his/her door when he/she goes out"

b. Kunu	a-	nu-	fít-	í-m	w-	ar -	a-	n(a)	itutu	eéna
Kunu	SM	fl	can	FV	Incompl.	Inf.	come	FV	with	motorcycle here

"Kunu will be able to come with a motorcycle here"

Undoubtedly, the data show that the future tense marker and the deontic elements *ofiti* "can, be able to" and *oyana* "must, have to" can co-occur. This state of affairs seems to prove that "the deontic modal elements [that] somehow express irrealis with no further specification as to whether the event will actually take place or not" (Aboh and Nauze 2007) are not semantically incompatible with the future tense marker in Tuki.

At this stage of the investigation, one can say that the elements that have been identified so far, that is tense markers, aspect markers, deontic or root modals, all head maximal projections to the effect that tense markers head tense phrases (TP), aspectual markers aspect phrases (AspP) and modal verb phrases (VP). Given the above reasoning, sentence (36), repeated below as (59) could be assigned the following phrase marker (PM):

(59)

Pára	a- ru-	kutu-dzu-	any on-	o-	biya
Priest	SM RETRO	prog.	Again drink	REP FV	beer

"The priest has just been drinking beer again repeatedly"

(60)

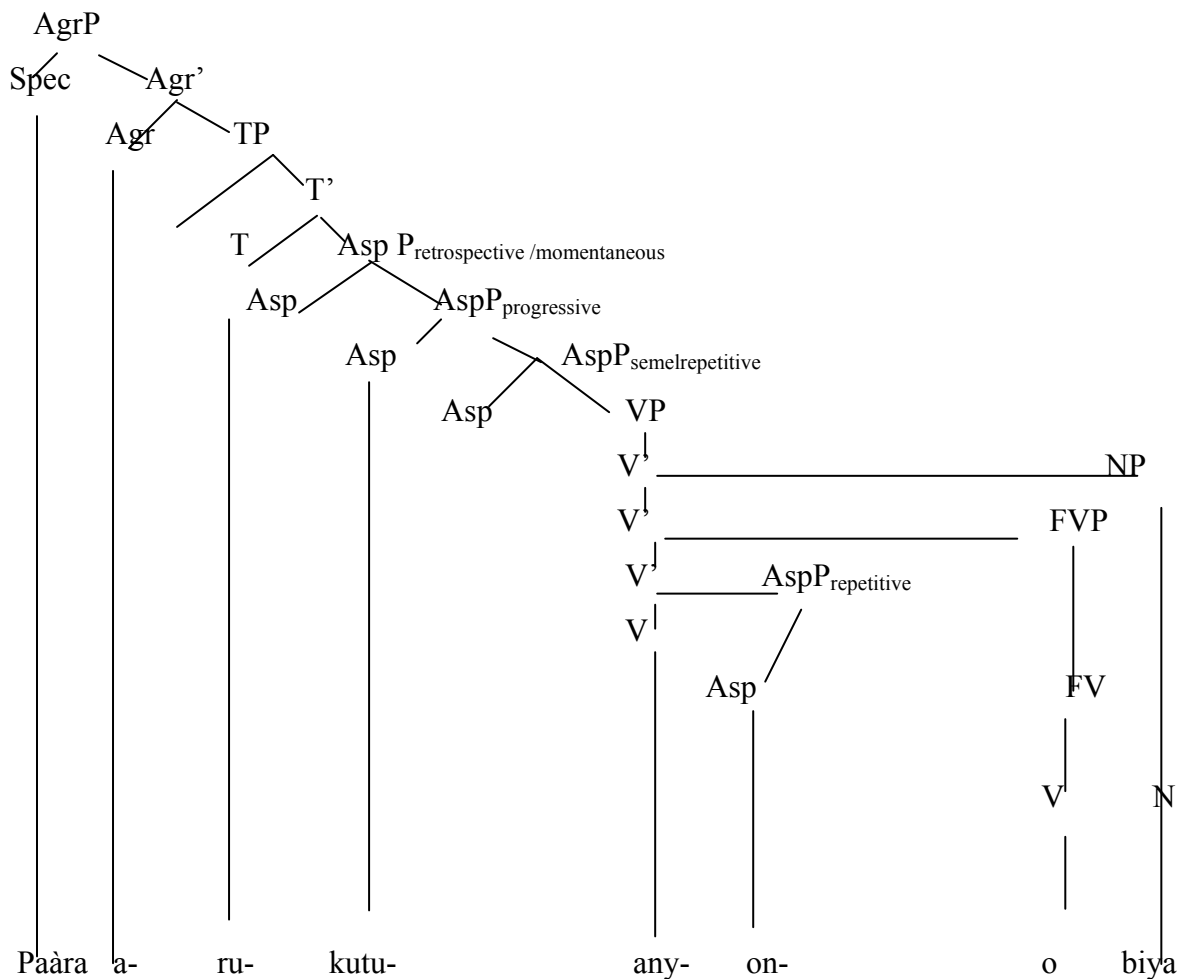

The final vowel has been tentatively assumed to head its own maximal projection (FVP), for homogeneity sake; not that there be a specific reason for that. The whole complex verbal unit *arukutudzuanyono* is obtained by application of head to head movement (raising) and adjunction from right to left. Since each head raises to the next one on its left until there is no (other) head to raise to, no syntactic condition is violated (the head Movement constraint, Travis (1984), Relativized Minimality (Rizzi 1990, 2004), Minimal Link Condition (Chomsky 1995)).

Modality has been extensively studied in "typologically different languages" (Aboh and Nauze 2007). Abraham (2001, 2002, 2007) argues that "modal verbs in languages like Germanic show a number of differences between deontic modals and epistemic modals" (quoted in Aboh and Nauze). Furthermore, Abraham (2001:12) indicates that "the most important differences are the following ones. (i) Counter to deontic modal verbs (DMV),

epistemic modal verbs (EMV) cannot occur in non-finite environments- i.e. no epistemic reading emerges in embedded constructions;

(ii) EMV cannot occur as full verbs;

(iii) EMV cannot surface in illocutions other than declaratives; and,

(iv), EMV do not take readings in perfective environments whereas DMV do". Moreover, Aboh and Nanze (2007) observe that in Germanic modal verbs are raising verbs that therefore involve modal verb raising which, in turn, may correlate with the fact that Germanic has V-to-I-to-C movement. None of the above seems to be true in Tuki, as it will become clearer as the discussion unfolds. Tuki is devoid of auxiliary verbs like *have* and *be* in English and French. The lexical verb does not move overtly like in French. And so called INFL- markers (tense, aspect, extension... etc) are insensitive to syntactic movement operations (interrogation, focalization, topicalisation...). The only instance where the verb seems to have undergone some kind of movement is in predicate clefting, what was called in Biloa (1992, 1995) Focus -V- movement:

(61)

a. Viróó a- má- díng- a- vakutu
 Viroo SM p2 love FV women
 "Viroo loved women"

b. o- díng- a owu Viróó a- má- díng- a vakutu
 inf. love FV FOC Viroo SM p2 love FV women
 "Viroo LOVED women"

In Tuki, the verb is focussed by having its infinitival copy appear in clause initial position. Biloa (1992, 1995) indicates that the verb, as well as raised wh-phrases, substitutes for the specifier of a functional maximal projection called Focus Phrase (FP then):

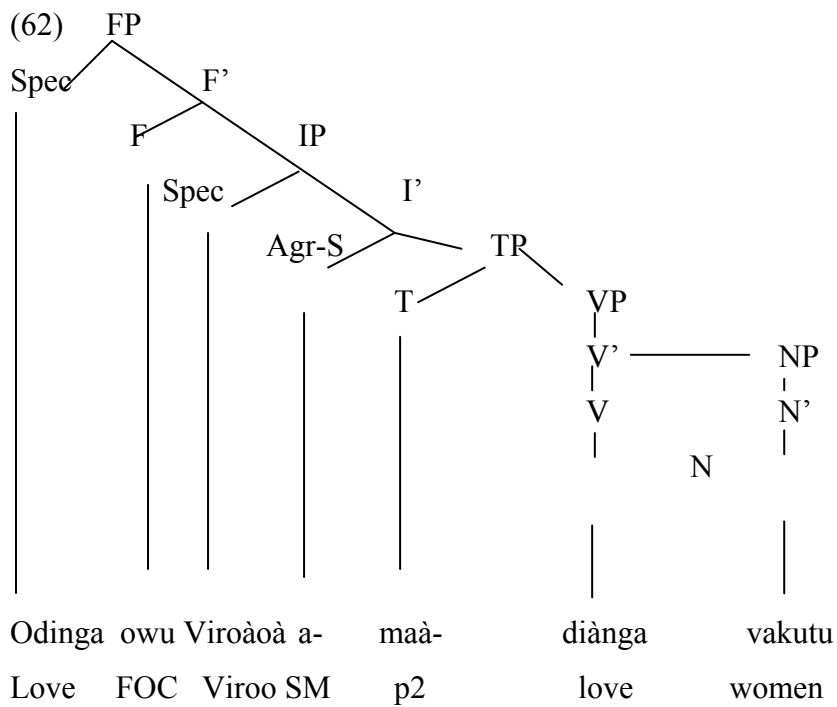

(63)
 a. Ané ódzu Viróó a- má- dínga ?
 who FOC Viroo SM p2 love
 "Who did Viroo love? "

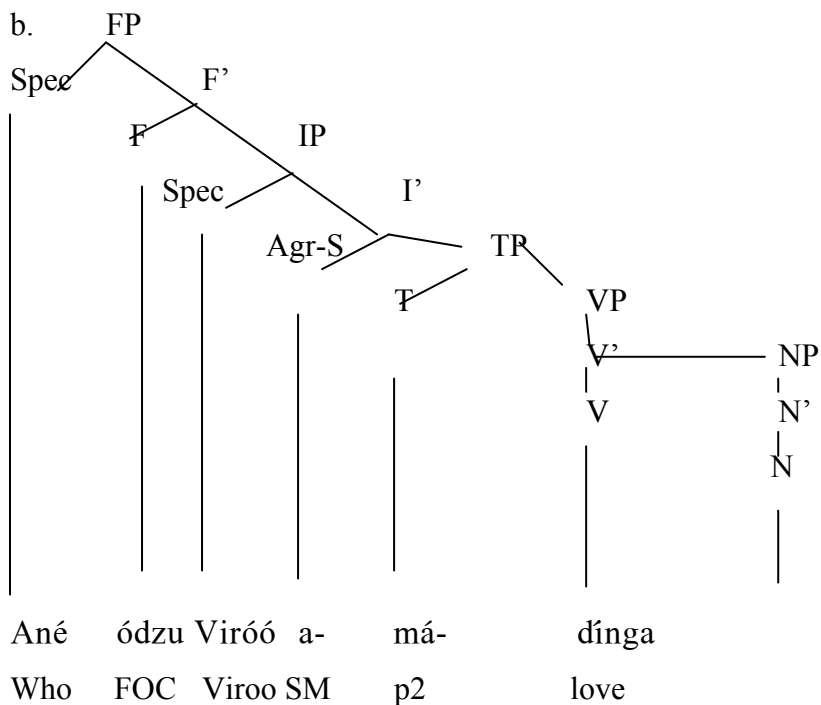

In Tuki, as in Gungbe (Aboh and Nauze 2007), counter to what obtains in Romance and Germanic (Rizzi 1997), focalization is possible in the main and embedded clauses.

(64)

Námbari	owu	nu	ng-	idzím	á-	m	ée
Tomorrow	FOC	I	SM	know	FV	Incompl.	That
Kunu	odzu		Varinga	a-	nu-	bán-	á- m
Kunu	FOC		Varinga	SM	fl	marry	FV Incompl.

"Tomorrow I know that it is Kunu whom Varinga will marry"

The above sentence contains two foci (one in the main clause, the other in the embedded clause) transgressing thereby the general ban on more than one focus per sentence.

Having made these clarifications, let us now focus on the meaning of modality.

4.6. The interpretation of modality

The following discussion draws inspiration from Aboh and Nauze (2007) whose work is based on the typology of modality introduced in van der Auwern and Plungian (1998) which draw a clear distinction between root and epistemic modality. Epistemic modality deals with knowledge (information, while root modality is about agents or actants of events. Among the wide range of different interpretations covered by root modality, there is the distinction between participant –internal and participant –external modality. Modals expressing the ability of an agent to perform a certain event are included in the participant-internal modality, whereas the participant-external modality is concerned with constraints that are imposed on the agent by external factors. Two kinds of participant –external types can be distinguished: deontic and goal-oriented modality. On the basis of Lyons (1977), Palmer (2001), Van der Auwera and Plungian (1998), Aboh and Nauze (2007), deontic modality is assumed to include both permissions and obligations. And interpretations such as preferences and norms are likely to be included in deontic modality (e.g., English *should* and *ought to*) (Aboh and Nauze 2007). On the other hand, goal-oriented modality relates to goals and the ways to achieve them. Aboh and Nauze propose a figure that represents their description of modality in Gungbe. Assume this representation of modality to be very similar to the one in Tuki, pending the discovery of major differences between the two languages.

(65) (Aboh and Nauze 2007, figure 1)

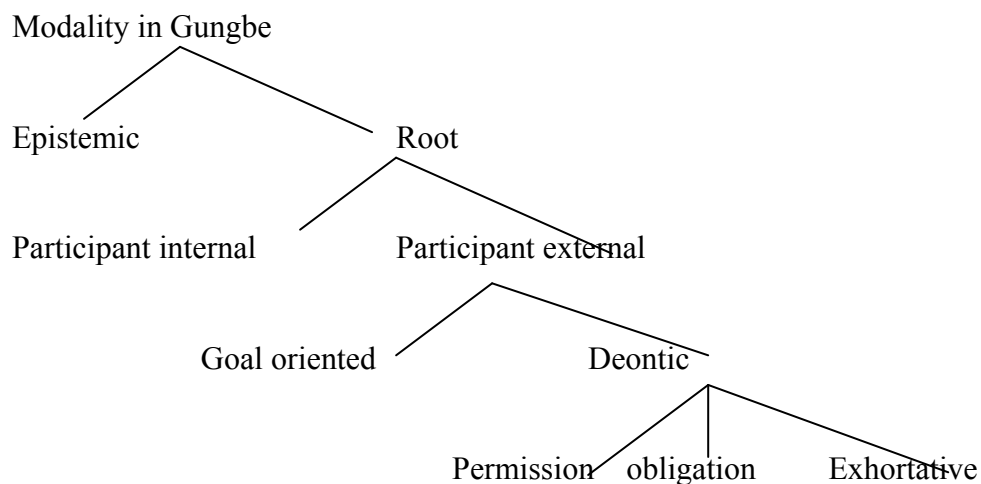

In this representation, *root* covers all branching modal meanings (i.e. participant internal/external, goal oriented, deontic) and *deontic* relates to permission, obligation and exhortative.

4.6.1. Root modality

As previously mentioned, Tuki has, among other phenomena, the following so called modal auxiliaries:

(66)

a. o- fít- i
 inf. Can/be able FV

"can/to be able to "

b. o- yǎn -a
 inf. must/have to FV

"Must /to have to"

They can also be called root modals. They can equally express participant – internal and participant- external modality. Similarly, *ofiti* "can/be able to" is ambiguous too since it can encode participant – external as well as epistemic modality and express ability:

(67)

a. Avena a- fít- í- m o- tsór- a matúwa
 Avena SM can FV Incompl. Inf drive FV car

"Avena can drive a car"

b. Avena a- fít- í- m o- dzii

Avena	SM	can	FV	Incompl.	Inf	be
r(a)	(y)	éndze,	amu	mwána	wáá	
in	house	as	child	his		
a-	ru-		dzet-	a	na	Ndzamane
SM	RETRO	come back	FV	from	Germany	

"Avena might be at home since his child just returned from Germany"

(67a) expresses Avena's ability to drive a car; (67b) encodes participant- external and epistemic modality.

Recall that the present tense in Tuki is always accompanied by the incomplete aspect morpheme /m/ which is suffixed to the verb. In the examples provided in (65), clauses in which the modal occurs in the present tense are interpreted in present time. As said above, when a verb in the present tense is negated, the incomplete aspect morpheme disappears, and the sentence therefore gets a default perfective reading:

(68)	Avena	a-	tá-	fít-	i-	o-	tsór-
	Avena	SM	Neg	can	FV	inf.	drive
	a		matúwa				
	FV		car				

"Avena can not drive a car"

The completive aspect marker in (68) is Ø (zero).

Ability can be expressed in the past tense:

(69)	Avena	a-	tá-	má-	fít-	i	o-	tsór-	a	matúwa	asene
	Avena	SM	Neg	P2	can	FV	inf.	drive	FV	car	because
	wurono		a-	má-	kutu-		mu	sásey-		a	
	Oldness		SM	p2	prog.		OM	bother			

"Avena could not drive a car because old age was bothering him"

Sometimes, participant –internal ability depends on participant –external circumstances. In the following example, for instance, Avena can not drive the car because the road is very slippery due to the overwhelming presence of the mud; the negative morpheme /ta/, that precedes and scopes over the root modal *ofiti*, indicates that the participant- internal ability is impaired:

(70)	Avena	a-	tá-	fít-	i	o-	tsór-
	Avena	SM	Neg	can	FV	inf.	drive

a matúwa amu vitófo vi- mu r(a) ondzóó atoo
 fv car as mud SM is on road too much

"Avena can not drive the /a car as there is too much mud on the road".

The external participant that prevents Avena from driving the/a car is the mud.

The deontic modal *oyana* "must /have to" is ambiguous too. It can encode goal oriented necessity or deontic necessity:

(71)

Vădzu va- yăn- á- m w- énd a
 Children SM must FV Incompl. Inf. go FV
 ra suàkuàru ibiàsi yima
 to school morning all

"Children must/ should go to school every morning".

It can also express participant –internal necessity (where the participant is not in control):

(72)

Vădzu a súkúru va- yă- á- m
 Children of school SM must FV Incompl..
 o- kús- a biya veda mutu
 inf. buy FV beer but man
 (a) ipátira a- mu- bārang- a
 of store SM p1 refuse FV

"School children have to buy beer but the storekeeper refused"

The above sentence means that school children wanted to buy beer in a store but the storekeeper refused to sell it to them.

In (70) and (71), the modal is conjugated in the present tense and is therefore in the imperfective aspect.

By now it is known that the two modals, *ofiti* and *oyana*, can express participant-external modality. In the following sentences, *ofiti* "can, be able to, may" can also be used to express permission:

(72)

a- Na puru rítsu, mutu a- fít- í- m
 inf. behaviour our man SM can FV Incompl.
 o- băn- a vakutu vábá too vatátu
 inf. marry FV women two even three

"According to our traditions, somebody can marry two women, even three"

b. Isomo a- nŏm poo a- fít- í- m
 Isomo SM sick he SM can FV Incompl..
 o- búk- i- manonóó
 inf. miss FV work

"If Isomo is sick, he may skip work"

In the next sentence, the modal *ofiti* expresses a goal-oriented interpretation:

(73) Ngi mamu o- dínga- á- m- ée- pro
 If you SM like SM imperf. That you
 o- bónd- a- ndongta, pro o- fít- í-
 SM become FV doctor you SM can FV
 m- w- énd- a n(a) adóngo a mitáng
 Incompl.. SM go SM to village of whites

"If you want to become a medical doctor, you may go to Europe"

Consider the following two sentences:

(74) Mutu ongíma a- yán- á- m
 Man all SM must FV Incompl..
 w- énd- a
 inf. go FV

"Everyone must go"

b. Mamu ée- w- éng a- súkúru a ndongta
 you that inf. do FV school of doctor
 bámbá, pro o- yán- á- m w- énd- a na Púrsi
 good you SM must FV Incompl. inf. go FV to Paris

"For you to attend a good medical school, you must go to Paris"

In (74 a) above, the modal *oyana* expresses the notion of participant –external deontic necessity whereas in (74b) the some modal encodes the notion of participant –external goal-oriented necessity.

Overall, the data analyzed so far seem to suggest that the modal *oyana* encodes a strong deontic interpretation. Although it does not necessarily do so. Sometimes, its use implies less of a requirement than a suggestion/an advice such as the following one provided by a mother to her son who is a college student:

(75)
 Tama adze pro o- tímb á- m
 Time this SM possess FV Incompl.

nkata, pro	o-	yán-	á-	m.	o-	bete-
exams	SM	must	FV	Incompl.	inf.	
men-	a-	kúúku				
Sleep	FV	early				

"When you have your exams to write, you should go to bed early [so as to rest]"

Whatever the case, it is important to bear in mind that the interpretation of modal verbs is context sensitive and a given reading may turn out to be weak or strong depending on the relationship between participants or the linguistic environment (for example, the presence or not of adverbs that could weaken or strengthen the argumentation).

Notice that the following sentence seems to have more than one interpretation:

(76)

Vădzu	a	súkúru	vima	va-	yán-	á-
Children	of	school	all	SM	must	FV
m	w-	ar-	a	n(a)	íkwaána	
Incompl.	Inf.	come	FV	to	meeting	

"All school children have to attend the meeting"

On one of the readings (which is the most predominant for us) the school children have the obligation to attend the meeting, i.e, they must attend the meeting. But if a teacher were to utter such a sentence to a course representative, then the latter could understand it to mean that he, the course representative, should ensure that all school children attend/come to the meeting. So sentence (76) shows that the onus of permission or obligation is not necessarily on the subject of a deontic modal sentence.

4.6.2. Epistemic modality

Apart from the inherent root readings that *ofiti* "can/may" and *oyana* " must /have to " can express, they are also capable of encoding an epistemic possibility interpretation that can be expressed by the modal *ofiti* and the necessity reading can be displayed by *oyana*₂ given the right surrounding environment. In the following sentence, Mingana has not been seen for quite some time and one of the participants suggests that she might have gone back to the village:

(77)

Mingana	a-	má-	fít-	i-	o-	munu-
Mingana	SM	p2	can	FV	inf.	ANT
et-	a-	n(a)	adongo			

go back FV to village

"Mingana may have already gone back to the village"

The modal *ofiti* is inflected for the past tense two (p2) and the following infinitival verb has been affixed the anterior aspect morpheme which means "already".

The following sentence describes the situation of a toddler who is learning to walk and one of the participants states that he can walk alone (on a short distance):

(78)

Mangádzu a- fit- í- m o- ndénd- a muka
Child SM can FV Incompl. inf. walk FV alone

"The child can walk alone"

Sentences (77) and (78) illustrate an epistemic possibility reading.

(74b) has shown above that *oyana* "must, have to" can express strong deontic mood. But given the appropriate context, it may also encode an epistemic interpretation:

(79)

Amu vyéndze a súkúru vi mu
As houses of school SM are
Pumban, iyére a- bungan- á- m
Clean teacher SM thinks FV Incompl.
ee vǎdzu va- fu- kutu- yán- á- m
That children SM hab prog. Must FV Incompl..
o- wu- fur- a- pro
inf. OM clean FV them

"Since the school classrooms are clear, the teacher thinks that children must have been cleaning them".

Partially summarizing, *oyana* can encode strong deontic modality (cf.

(49b)) as well as epistemic modality (cf. (79) above). Tuki modals *ofiti* and *oyana* are capable of displaying capacity and deontic modality, on the one hand, and epistemic modality, given the appropriate context, on the other hand.

4.7- The order of clausal functional heads in Tuki

Overall, the tense and aspect systems of Tuki have been studied hopefully thoroughly. The study has revealed that three past tenses, one present tense and three tenses are attested in the language. Tense and aspect are affixal in this Bantu language. As far as aspect is concerned, no less than twelve aspects were enumerated: habitual, retrospective, progressive,

semelrepetitive, anterior, continuative, terminative, repetitive, quantitative, alternative, completive and incompletive. Modality, too, was analyzed detailly. The evidence for the pairwise order of the different functional heads was considered. And by transitivity, these relative orders (should) suggest the following single overall order of functional heads in Tuki:

(80)

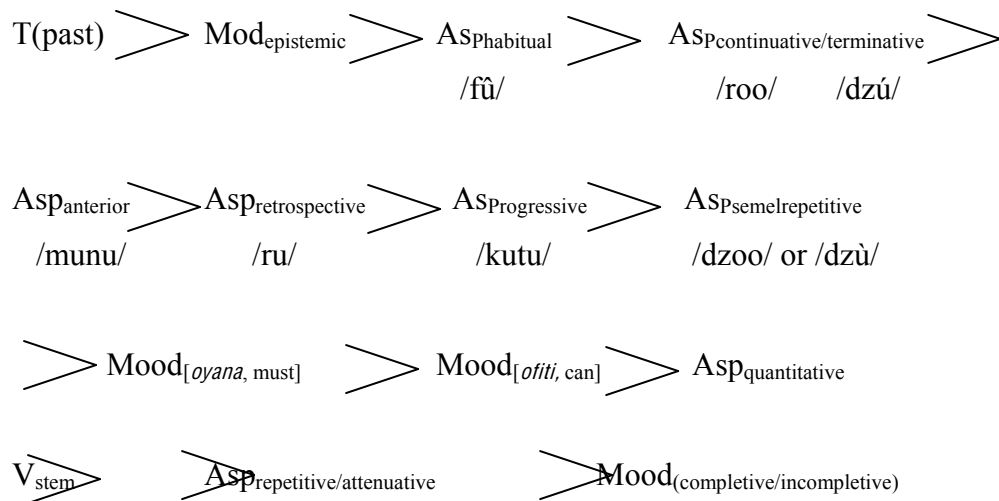

CHAPTER FIVE

Adverbs in Tuki: a cartographic perspective

Introduction

This chapter describes and analyzes the linear order of adverbs with special reference to Cinque's (1999) seminal work on adverbs and functional heads from a crosslinguistic perspective. It is argued that, if the linear order of "higher" (sentence) adverbs in Tuki corresponds to Cinque's hierarchy, the one for "lower" adverbs slightly diverges from the Italian linguist's proposal. Systematic differences between Indo-European languages such as English, French and Italian on the one hand and Tuki on the other one are highlighted.

The research is conducted within the framework of the feature based theory of adverb syntax (Alexiadou 1997, Cinque 1999, Laenzlinger 1996, 1998, 2000, 2004) in which adverbs merge as specifiers of clause-internal functional projections. As stated by Laenzlinger (2004), "within the feature-based theory, each class of adverbs[...] is confined to a simple position, which is identified as the specifier position of a corresponding semantically related functional projection. Such an approach readily fits in with the LCA (Kayne, 1994) conception of phrase structures, as advocated by Alexiadou (1997) and Cinque (1999). Specifiers are unique left-branching adjoined phrases. In Kayne's system multiple adjunction is banned, as well as right attachment of specifier. The only possible configuration is [Spec X° Compl]. Adverbs are adjoined specifiers attached to the left. Linearly they precede the head with which they are associated."

The chapter is structured as follows. Section 2 is a sketch of Tuki morphosyntax. Section 3 summarizes Cinque's (1999) findings. Section 4 is a discussion about the architecture of the clause and it surveys the different approaches to X-bar theory since the inception of the split-Infl Hypothesis (Pollock 1989, Chomsky 1991). In section 5, the relative order of AdvPs ("higher" (sentence) AdvPs and "lower" AdvPs) is thoroughly scrutinized in Tuki.

5.1 Outline of Tuki Morphosyntax

Most Bantu languages have an SVOX order (cf. Watters 1989; Mchombo 2004). Tuki is no exception and respects this word order typology. In a simple transitive clause, the

subject precedes the verb; the latter is followed by the direct object complement, as illustrated in the following sentence:

Okutu a- tá- má-kutu- námba cwí

woman SM Neg P2 Prog cook fish

“The woman was not cooking fish”

(For details about clause structure and word order, the reader is referred to the preceding chapter.)

Tuki is a typical affixal language. Verbs can be marked for agreement negation, tense, aspect, object marker (OM) and their argument structure can be affected by the so called extension morphemes that are productive in the language and are at the basis of the formation of the causative, the applicative constructions as well as reciprocalization. The agreement, negation, tense, aspect, object markers are prefixes because they always precede the verb stem, whereas extension morphemes are suffixed to the verb stem and occur before the final vowel. For illustration of the above explanations, consider the following sentences:

(2)

a) Mbárá a- fu – ny – á – m cwí

Mbara SM hab. eat FV Incomplete fish

“Mbara often eats fish’.

b) Mbárá a – tá – fu – ny – á cwí

Mbara SM Neg had eat FV fish

“Mbara does not often eat fish”.

In (2a), the Subject marker (SM) and the habitual aspectual morpheme precede the verb stem which is, in turn, followed by a final vowel (FV) and an incomplete aspectual morpheme. The latter morpheme indicates that the action expressed by the verb is incomplete. Sentence (2b) is a negation of sentence (2a): the verb morphology now comprises a negation marker /ta/ and the incomplete aspectual morpheme has disappeared, thereby implying that these two morphemes are in complementary distribution.

Inflectional prefixes (agreement, negation, tense, aspect), can be appended to the verb Item in combination with derivational suffixes (causative, applicative, reciprocalization, etc), albeit not in the same configuration. The following sentences are a case in point:

(3)

- a. Okutu waa a- nu – kutu – mu – námb – én – a- m Mbárá ndone
woman his SM fl prog. OM cook Asp. FV Incomplete Mbara cow
“His wife will be cooking beef for Mbara”
- b. Okutu woa a – ta – nu kutu – mu námb – én – á Mbárá ndone
- c. woman his SM Neg F1 prog. OM look APPL FV Mbara cow
“His wife will not be cooking beef for Mbara”.

5.1.1 Guglielmo Cinque’s hierarchy

Cinque (1999) argues that the linear order of adverbs and functional Heads cross-linguistically is much more systematic than previously assumed. More importantly, he suggests that there is a universal hierarchy of functional heads. Moreover, particular adverbs or functional elements always occupy specific positions in this hierarchy.

Cinque’s development of universal hierarchically organized functional projections in the clausal domain is based on three sources.

(4)

- a) Adverbs
- b) Bound – functional morphemes
- c) Free functional morphemes

On the basis of evidence from adverbs, Cinque (1999) proposes an elaborate articulation of INFL. In his own words, it is “at first sight, outrageously rich” functional clause structure (Cinque 1999: 106). He establishes a hierarchy of classes of adverbs based on the fact that certain adverbs necessarily precede others. For instance, in the following French data, the position of *déjà* “already” is examined in relation to *pas* and *plus*:

(5)

- a- Si tu n’as pas *déjà* mangé, tu peux le prendre
“If you have not already eaten, you can take it”
- b- *Si tu n’as *déjà pas* mangé, tu peux le prendre
“If you have already not eaten, you can take it”

(6)

a- A l'époque, il ne possédait *déjà plus* rien
"At the time, he did not possess already any longer anything"

b- * A l'époque, il ne possédait *plus déjà* rien.
"At the time, he did not possess any longer already anything"

From these examples, it appears that the following relative orders are attested: *pas* > *déjà* and *déjà* > *plus*. By transitivity, *pas* must be structurally higher than *plus*: *pas* > *plus*. But *pas* and *plus* normally cannot co-occur:

(7)

a- * Ils n'ont *pas plus pas plus* téléphoné
"They haven't not any longer telephoned"

b- * Ils n'ont *plus pas* téléphoné
"They haven't any longer not telephoned"

Although *pas* and *plus* cannot co-occur, a look at lexical infinitives (Pollock 1989) reveals that *pas* is structurally higher than *plus*:

(8)

a- Ne dormir plus

b- Ne plus dormir

(9)

a- *Ne dormir pas

b- Ne pas dormir

The following syntactic analysis captures the behavior of *pas* and *plus*

(10) [$\bar{}$ [pas $\bar{}$ [plus ... dormir]]]
 ↑ ↑ ↑
 X

Under this analysis, adverbs are maximal projections (XPs) rather than heads (X°). In (10), a lexical verb which is [- fin] can move to X° position(s).

Cinque argues for a fixed order hypothesis whereby a unique canonical order of AdvPs is attested. But there are apparent counter examples that show that certain adverbs can be inverted:

(11)

a. Il n'a *plus jamais* rien su d'elle

"He hasn't any longer ever learnt anything about her"

b. Il n'a *jamais plus* rien su d'elle

"He hasn't ever any longer learnt anything about her"

Once more, lexical infinitives prove useful in discriminating between the two orders: the infinitive may occur between *plus* and *jamais*, but it may, not show up between *jamais* and *plus*:

(12)

a- Il ne veut *plus* parler *jamais* d'elle

"He does't ever any longer want to speak about her"

b- * Il ne veut *jamais* parler *plus* d'elle

So while this order is Ok: *plus* > *jamais*, the following is ruled out : * *jamais* > *plus*. This state of affairs is accounted for by positing that *plus* is generated in the specifier position of a functional projection higher than the functional XP the specifier of which hosts *jamais*. Assuming with Rizzi (2004) that these two maximal functional projections are called Modifier phrases (ModPs) the behavior of these two adverbs, along with the movement of the lexical verb, can be captured by the following partial tree representation:

(13)

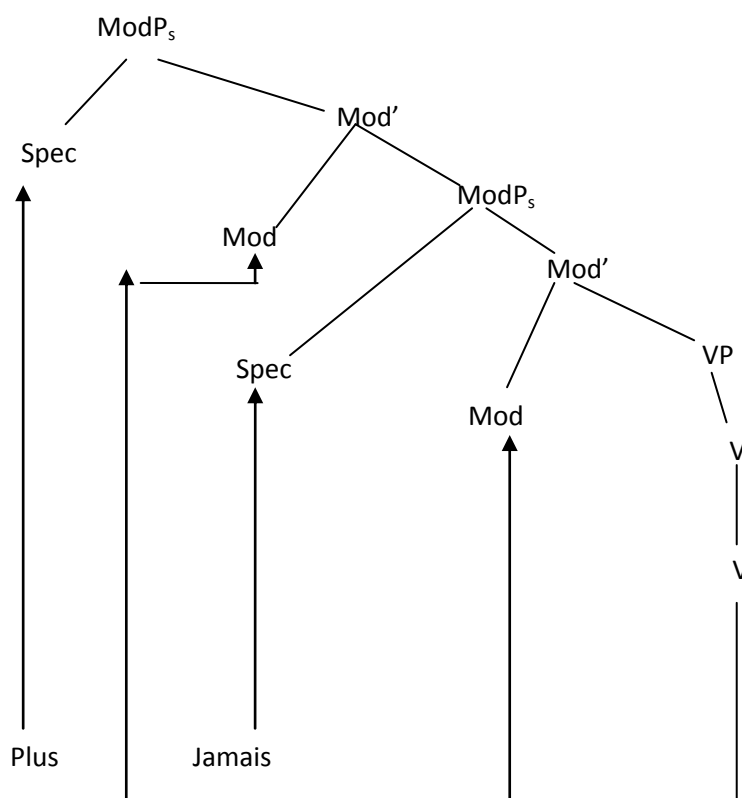

In this configuration, the infinitive may use only one of the heads of the ModP as a landing site, or even go lighter on the tree: this explains why the lexical infinitive may precede, come in between or follow *plus* and *jamais*. But when *jamais* precedes *plus*, none of these options is available. If *jamais* has to dominate *plus* it means that the former adverb has to raise to the specifier position of *plus*, thereby making it impossible for an infinitive to intervene between the two adverbs:

(14)

Il ne veut [*jamais*_i ; *plus*] t_i parler d'elle

"He doesn't want any longer ever to speak about her"

So the fact that *plus* and *jamais* can co occur does not imply a lack of hierarchy. In fact, these data show that these adverbs are positioned in the Spec of rigidly ordered functional projections.

The hierarchy of AdvPs proposed by Cinque (1999) is built on the basis of evidence from Romance (Italian and French).

Cinque argues that his hierarchy holds cross-linguistically. Data from of Germanic languages (English and Norwegian), a Slavic language (Bosnian/Serbo – Croatian), a Semitic language (Hebrew), a Sino-Tibetan language (Chinese), and Albanian lend support to Cinque's thesis.

However, as one moves from one language to another, one observes that Cinque supports that these variations are consistent with the rigidity of the hierarchy. English and Romance provide an example of apparent cross-linguistic variation in the ordering of adverbs: "while in Italian (Romance) (*non..*) *più* "(not) any longer" was seen to precede *sempre* "always", English would seem to show the opposite order (...) The appearance is however deceiving" (Cinque 1999: 33). It can be noted on observing the data that subversion is only possible in English when *always* precedes the verb and its complements, while *any longer* follows them. Subversion is impossible when these two adverbs (both) precede the verb and its complements:

(15)

John doesn't *always* win his games *any longer*

(16)

a- John doesn't *any longer always* win his games

b- *John doesn't *always any longer* win his games

“When both *always* and (*not...*) *any longer* appear before the verb, their order is just like the one found in Italian (Romance)” (Cinque 1999: 33). The status of sentence (15) can be explained by the raising of *always win his games*:

(17)

John doesn't [*always win his games*]_i any longer t_i

The careful analysis of the syntactic behavior of adverbs prompts Cinque to propose the following single, universal order of AdvPs:

(18)

Frankly> fortunately> allegedly> probably> once> then> perhaps> necessary> possibly> willingly> inevitably> cleverly> usually> again> often> quickly> already> no longer> still> always> just> soon> briefly> characteristically> almost> completely> tutto> well> fast/early>completely> again> often

Cinque (1999) locates each adverb “in the (unique) Spec positions of distinct maximal projections” (Cinque 1999: 44). The system put in place by Cinque is conceptually desirable because it is restrictive in allowing only specifiers by doing away with adjunction (cf. Cinque (1992; 1994) and Sportiche (1993)). Recall that a system is restrictive when it allows either adjunction or (substitution for) specifiers. A system that admits both options is less restrictive and undesirable. Moreover, since the rigid relative order of AdvPs is a consequence of this system; it is theoretically beneficial because AdvPs enter in a Spec/head agreement relation with a fixed order of functional heads. Under the adjunction hypothesis, no such relation is available. On the other hand, “the fact that AdvPs are arguably on left branches is something that would have to be stipulated under the adjunction hypothesis, while it follows under the location – in – Spec’ hypothesis”.

Drawing inspiration from phrase markers, Cinque positions one head position to the immediate left, and one to the immediate right of each AdvP on the basis of the observation of active past participle movement and finite verb movement in Italian. Adverbs do not block

this head-movement: This is prima facie evidence for their analysis as XPs (Relativized Minimality, Rizzi (1990)).

On close examination of a wide array of languages, Cinque (1999), abstracting away from AdvPs, determines the order of clausal functional heads by analyzing bound and free morphological inflection. The result obtained reveals the overt relative orders of clausal functional heads. And it is discovered that functional heads are universally organized in a single overall order.

One evidence of bound functional morphemes is provided by “non closing” agglutinating suffixes (ie. Suffixes which do not occur word finally, but rather allow further affixation onto themselves). Suffixes from Korean, Turkish, Una, Tauya and Chinese lead Cinque (1999) to derive the relative order of functional heads through application of the Mirror Principle. Through transitivity of the partial orders arrived at by studying these languages, Cinque (1999: 55) derives the following order:

(19)

Mood_{speechact}> Mood_{evaluative}> Mood_{evidential}> Mood_{epistemic}> T(past)>
T(Futur)> Mood_{root}> T(Anterior)> Aspect_{perfect}> Aspect_{progressive/} Aspect_{completive}> Voice (>V)

Another evidence of bound functional morphemes is given by bound inflectional (as opposed to agglutinating) suffixes from both head-initial and head final languages. On the one hand, “head-initial” languages such as English or Spanish “where no successive leftward movements of lower positions of the clause plausibly take place (Kayne 1994) (...) provide direct evidence for the relative order of the corresponding functional heads” (Cinque 1999:57).

It follows from the above that the order in (20) below is implied by the examples in (21):

(20) Tense > Aspect perfect > Aspect progressive > voice (V)

(21)

a- English: These books have *been being read* all year

b- Spanish: Esos libros *han leídos* todo el año.

If indeed there is a universal hierarchy of functional heads, then “head-final” languages which exhibit leftward movement of nonheads such as Hindi and German should

reflect the mirror image to the one attested in head-initial languages. As expected, the prediction is borne out:

(22)

- Hindi: Kis-ko raam-ne socaa ki siitaa-ne dekhaathaa(Mahajan, 1990: 39)

Who Raam thought that Sita See-ANT be-PAST

“Who did R. think that S. had seen?”

Raam ro Tii khaataa rahtaa thaa (Mahajan 1990, 78)

Raam bread eat PROG be-PAST

“R. used to keep on eating bread’

(23)

Dab er von der Bank angestellt worden sein muss

That he by the bank employed been have must

‘That he must have been employed by the bank’

The two different language types provide evidence of inflectional suffixes occurring in reversed orders. Cinque (1999: 58) therefore concludes that “head – final languages provide the same evidence as English (and Spanish) for the order of functional heads (...)”.

Creoles as well as many West African languages of the kwa group evince free functional morphemes. In these languages, the head below the particles cannot adjoin onto them or raise past them whereas this is common with bound functional morphemes. In view of the above, Cinque (1999: 58) concludes that in instances of head-initial” languages evincing particles, the latter “allow us to directly observe the order of functional heads. One such case is provided by Creole languages”.

It is widely known that in Creole languages the ordering of functional particles is Tense-Mood/modal-Aspect. (TMA markers). Cinque (1999: 59) says about the sequence of these markers that “Although in essence correct, this ordering is some what gross, and must be qualified. For one thing, various aspectual particles can co-occur, so that their relative order claims needs to be determined. Secondly, there are occasional claims in the literature for the order Modal > Tense rather than tense > Modal”. Data from Guyanese creole, Haitian

Creole, Sranam and Gungbe lead Cinque to retain this claim. In Guyanese Creole, for instance, aspectual particles can co-occur, as illustrated by the following examples:

(24)

Shi a aalweez/neva de a sing (Gibson 1986: 852f)

She HAB always/never DUR PROG sing

“She usually always/never keeps singing”

In view of these, the structure must make provision for different positions for Asp head positions.

The data from Guyanese Creole must also force one to postulate various positions for modals:

(25)

Jaa sjuda bin kyaan get fu gu (Gibson 1986: 585)

J. MD Depistemic PAST MODr MODr COMP go

“J. should not have been able to be allowed to go”

This example evinces different positions for epistemic versus root modals (ability > permission) relative to the position hosting tense: the epistemic modal precedes T°. This state of affairs brings about a refinement of the traditional analysis of TMA markers and a more articulate follows from it with different positions for accommodating different modal types. This structural distinction for varying sorts of modals is semantically motivated: epistemic modals are “concerned with the speak’s deductions or opinions” while root modals, “in contrast to epistemic (...) are strictly subject oriented. Volition, obligation, ability, or permission are properties attributed to an (animate/subject” (Cinque 1999: 79).

The evidence from “head-final” languages which make use of functional particles supports the structure of functional particles established on the basis of head-initial languages. In head-final languages, particles appear sentence finally: it is a mirror image order to the one attested in head-initial languages with particles.

Cinque (1999) combines the two relative orders and proposes a single overall order below:

(26)

Mood_{speech act} > Mood_{evaluative} > Mood_{evidential} > Mod_{epistemic} > T (Pas) >
T (Future) > Mood_{irrealis} > Mod_{necessity} > Mod_{possibility} > Mod_{volition} > Mod_{obligation} >
Mod_{ability/permission} > Asp_{habitual} > T(Anterior) > Asp_{perfect/imperfect} > Asp_{retrospective} >
Asp_{durative} > Asp_{generic/progressive} > Asp_{prospective} > Asp_{Completive} > Voice > Asp_{celerative}
> Asp_{completive}

Having established a hierarchy of AdvPs and one of functional heads, a comparison of the two hierarchies shows that they match semantically from left to right:

(27)

[*Frankly* Mood_{speech act} [*Fortunately* Mood_{evaluative} [*allegedly* Mood_{evidential}
[*probably* Mod_{epistemic} [*once* T(Past) [*then* T(Future) [*perhaps* Mood_{irrealis},
[*necessarily* Mod_{necessity} [*possibly* Mod_{possibility} [*willingly* Mod_{volition} [*inevitably*
Mod_{obligation} [*cleverly*, Mod_{ability/permission} [*Usually* Asp_{habitual} [*again* Asp_{repetitive(1)}
[*often* Asp_{frequentative(1)} [*quickly* Asp_{celerative(1)} [*already* T Anterior) [no longer
Asp_{terminative} [*still* Asp_{continuative} [*always* Asp_{perfect(?)} [*just* Asp_{retrospective} [*soon*
Asp_{proximative} [*briefly* Asp_{durative} [*characteristically (?)* [? Asp_{generic/progressive} [*almost*
Asp_{prospective} [*Completely* Asp_{completive(1)} [*tutto* Asp_{p/Competive} [*well* Voice [*fast/early*
Asp_{celerative(II)} [*completely* Asp_{scompletive} [*again* Asp_{repetitive(II)} [*often* Asp_{frequentative(II)}].

As a follow-up to the above hierarchy, Cinque (1999: 77) states that

“In many cases a transparent specifier/head relation between a certain adverb and the right-adjacent functional head is immediately recognizable. This makes it plausible to assume that such a relation should hold across the board, even in those cases where a functional head apparently finds no corresponding adverbs class to its left, or when an adverb class finds no corresponding appropriate functional head to its right (...) It could simply be that we have failed to recognize the existence of the relevant adverb class, or of the relevant functional head (...)”.

The Italian syntactician concludes that it is not surprising that individual languages comply with the above hierarchy. The latter is a fixed order determined by UG. It follows from this reasoning that all human languages should be compatible with his hierarchy. It

would therefore be interesting to find out how Tuki in particular and Bantu languages in general fare with respect to Cinque’s theory. Before it is done, let us digress a little bit and dissect the architecture of the clause (in Tuki), since that will have some bearing on the ensuing discussion.

5.2 The architecture of the clause

The Split-Infl Hypothesis

Generative grammar is structured into modules or subtheories. Each module accounts for specific aspects of the functioning of natural languages and provides explanations about linguistic computations and constraints on syntactic movements.

Modules include thematic theory, case theory, binding theory, bounding theory, empty categories and the Empty Category Principle (ECP), X-bar theory.

One of the tools usually appealed to in order to describe and analyze natural language sentences is the phrase marker (PM) or tree representation. In a nutshell, the phrase marker encodes the functions of the constituents that make up the sentence as well as it makes it possible to visualize the relations that obtain between elements and constituents of the sentence. The latter is made up of phrases or maximal projections and it is precisely X-bar theory that determines the structure of phrases. For this module, each phrase has a head which is either lexical or functional. Traditional linguists claim that all phrases are endocentric that is they are projections of a unique head X. The latter is a zero level projection (X^0).

Within a phrase, X-bar theory distinguishes three levels of projection: the maximal projection (XP/X''), the intermediate projection (X') and the head (X). Theoretically, X-bar theory should be able to accommodate all language types (Kayne 1994). Biloa and others (2004) have shown that it can handle head-initial languages as well as head-final languages:

(28)

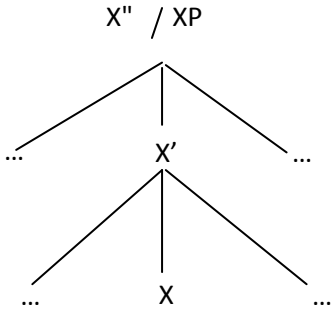

Bear in mind, however, that the Minimalist program (MP) has proposed to do away with the intermediate projection (X') so that all phrases be binary (the maximal projection and the head).

The application of X-bar theory has generated the head. The application of X-bar theory has generated the following sentential structure which comprises both lexical and functional categories (cf. Chomsky 1986):

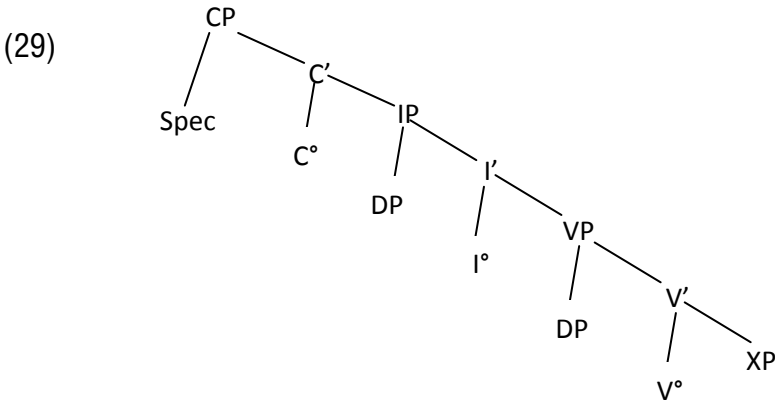

The above tree representation of a clause in a head-initial language has three layers: from bottom to top, there are the lexical layer (VP), the inflectional domain (IP), and the (left) periphery (CP) that connects the clause to either a higher clause or to the context.

The above sentential structure is a descendant of what used to be called the flat structure of the sentence:

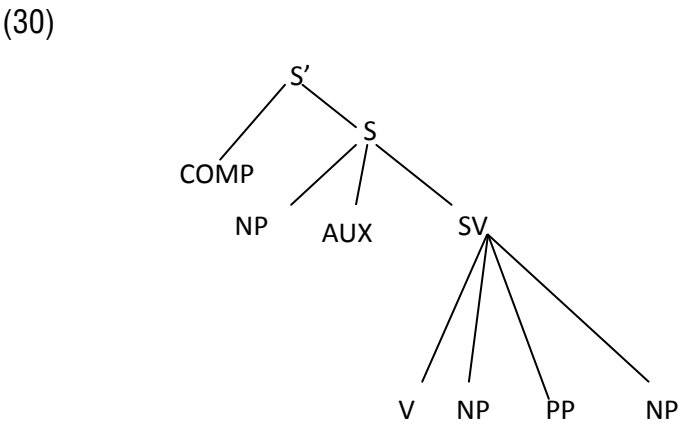

The structure of the clause in (29) will undergo, later on, some changes as well for conceptual and empirical reasons. Conceptually, the node I (Inflexion) had to host independent sets of features such as tense and agreement. Empirically, it was uneasy to account for word order

variations attested in French and English. For illustration, consider the morphological structure of French verbs of the first group (whose ending is -er). If the verb *dévor*er “eat up” is conjugated in three singular persons of the past tense imperfective (imparfait) and future tense (futur simple), one obtains the following paradigms.

(31) (Bilola 2004: 86, (8 a – b))

a)

Imparfait	SN	V(verbe)	T (temps)	Acc (cord)
	je	dévor-	-ai-	-s
	tu	dévor-	-ai-	-s
	il	dévor-	-ai-	-t
			Passé	Personne+nombre

b)

Futur Simple	SN	V(verbe)	T (temps)	Acc (cord)
	je	dévor-	-er-	-ai
	tu	dévor-	-er-	-as
	il	dévor-	-er-	-a
			Passé	Personne+nombre

The above paradigms indicate that agreement contains two types of morphological information: tense (T) and agreement markers (Agr). The latter encode person and number features.

Since Jean-Yves Pollok (1989)’s seminal article followed up by Chomsky (1991), the structure of the clause has become more articulated, elaborated and organized around the following functional projections: AgrP (Agreement Phrase), TP (Tense Phrase), NegP (Negation Phrase), AspP (Aspect phrase)...

The behavior of NegP is differential in French depending on the context. In simple tenses, Negation (*pas*) follows the verbs, whereas in compound tenses, negation precedes the verb. For illustration, consider the following sentences:

(32) (Bilola 2004:86, (9 a-b))

a. Jean ne dévorera pas de fruits

b. Jean n'a pas dévoré de fruits

How can we account for the fact in (a) negation (*pas*) appears after the verb while in ((b), negation (*pas*) precedes the verb ? Verb movement into Agr can explain it.

Assume that negation, before the verb moves, appears between INFL (tense and agreement) and V. at a certain level of representation, the verb raises above Neg. The following phrase marker encodes the movement of the verb into Agr.

(33) (Bilola 2004: 87, (10))

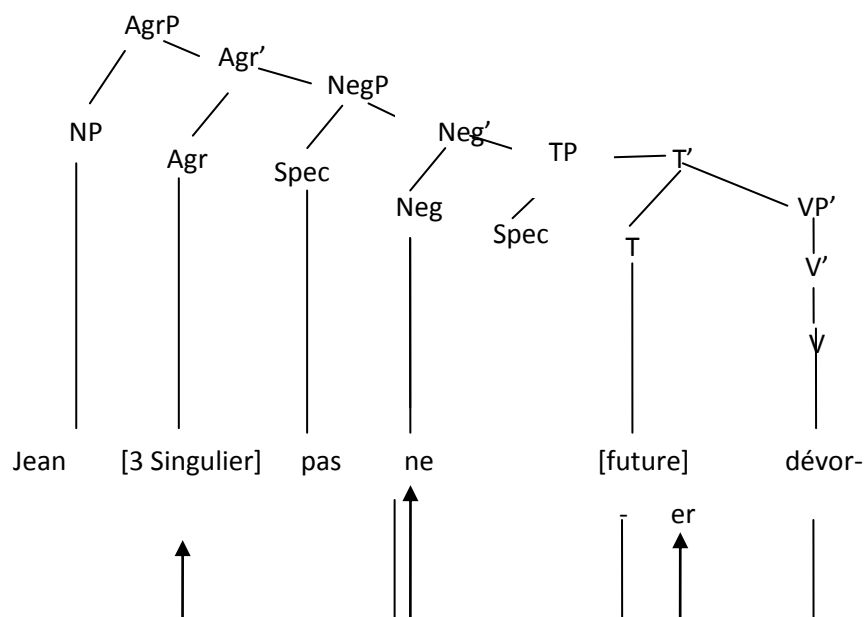

In (33), the verb *dévor*₋ raises to T(ense) to take the marker *-er*; then the resulting unit (after the affixation of *-er*) moves toward Negation (*ne*): thus is obtained the sequence *ne_dévor*₋; the latter climbs over the specifier position of NegP (which is *pas*) in order to finally land in Agr and pick up the marker *-a*. This latest episode of verb movement gives birth to the following sequence of constituents: *ne dévorera pas*. It is well known that in French negation is made up of two elements: one functions like a clitic (*ne*) and always precedes the verbs,

whether it is tensed or not; the other (*pas*) follows the finite verb in simple tenses and precedes the verb in compound tenses.

In sum, it is verb movement that accounts for word order, in sentences (32 a-b). Notice that the clause that was previously analyzed as IP (Chomsky 1986), as TP (Pollock 1989) has been decomposed to give birth to AgrP (Chomsky 1991). The structure of the clause is now more complex, articulated and elaborated. And the verb has been shown to take off from his original position and land in Agr after flying over Tense and Neg.

The structure of the sentence (34) below illustrates the derivation of sentence (32 b):

(34) (Bilola 2004: 88, (11))

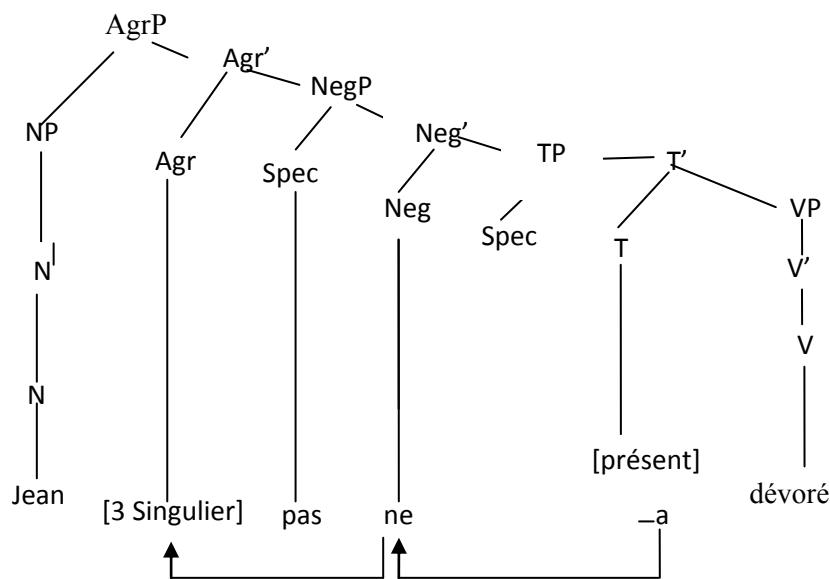

It appears that the more elaborated and articulated structure of the clause proposed by Chomsky and others, following pollock was designed as if they had in mind Bantu languages like Tuki. Consider for illustration the following Tuki sentence and its tree representation:

(35)

- a- Mbárá a - tá - má- mu - én - a Putá
 Mbara SM Neg P2 OM See FV Pute
 “Mbara did not see Puta”

b.

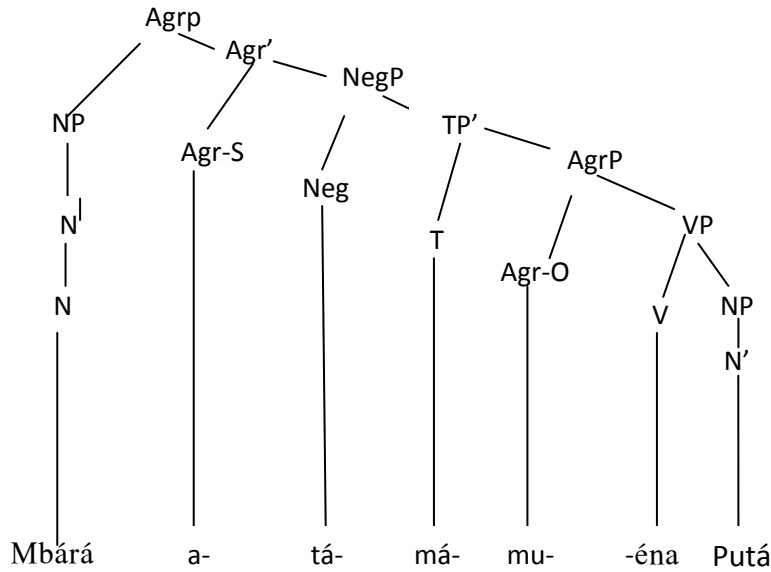

The above structure assumes Belletti (1990), Chomsky (1991). The latter states that Agr-S dominates tense (T), since Agr-S governs the subject in clauses where the verb is finite, thereby deriving subject-verb agreement. Furthermore, Chomsky indicates that there are two types of agreement between the verb and one NP: agreement with the subject (Agr-S) and agreement with the direct object (Agr-O).

Consider the following example from Italian provided by Belletti (1990):

- (36) Parl - et - ó
 Speak Tense Agreement

"I will speak" (order of affixes: T, future; AGR, 1 person singular).

Belletti (1990) indicates that "the respective order of tense and agreement features in the verbal morphology of Italian is the order T... AGR. We now have a simple but straightforward answer to the question concerning the respective order of T and AGR in the hierarchical tree structure of the clause: T must be lower than AGR. We then come to the conclusion that putting aside the possible existence of other (intervening) functional heads, the structure of the sentence in Italian as well as in the related languages is as [below]:

(37)

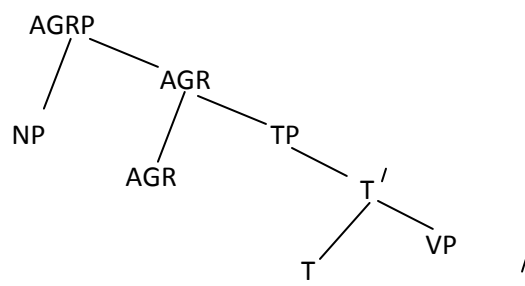

Recent research about clause structure has postulated the existence of several functional projections (Rizzi (1997, 2001, 2004), Cinque (1999), Bayer (2003)...). In the following lines, a careful observation of adverbs and functional heads in some Bantu languages under taken in order to check whether a hierarchy emerges and see how it is (in) compatible with that established by Cinque (1999).

5.3 The relative order of Adverbial phrases

Radford (1997: 419) defines an adverb as “a category of word which typically indicates manner (e. g. wait *patiently*) or degree (e. g. *exceedingly* patient). In English, most (but not all) adverbs end in *-ly* (cf. *quickly* – but also *almost*)”. Adverbs are formed differently from language. If in English, French and Italian adverbs end respectively in *-ly*, *-ment* and *-mente*, it is not so in many other languages, mentioned supra, there are many exceptions to the rule indicated above.

In Tuki, there is no clear rule of adverbs formation although many adverbs are attested in the language. Sometimes, the language appeals to adverbial PPs to express notions that are expressed in other languages by one morpheme – adverbs.

5.3.1 Lower AdvPs

In Tuki, most of the times, adverbs occur in post verbal positions. It is very difficult for an adverb or an adverbial PP to show up between the subject and the verb. Moreover, the language is agglutinative and there is therefore no provision for adverbs to occur between, let us say, an auxiliary verb and a lexical verb (as in French or Italian), just as there is no possibility for an AdvP to occur between two negative morphemes (like in French). However, one can observe that in this language the Neg marker *-ta* can interact with another functional morpheme that means *no longer*, *-dzu*:

(38) Mbárá - a - tá - dzu - nyá
 Mbara SM Neg not longer eat
 “Mbara no longer eats”

Many other functional morphemes such as the following *-dzo-* “again” are used in the language:

(39) Mbárá a - dzo - nyá - cwí

Mbara SM again eat fish

“Mbara is going to eat fish again”

We will come back later on to these phenomena when we will talk about the order of clausal functional heads.

For the time being, consider the fact that *tama ngima* which literally means “time all” and which literally meaning is *always* necessarily precedes *pe* “completely”:

(40)

a. Mbárá a - mu - nyá - manya táma
 Mbara SM P1 eat food time
 ngíma pe na kíísini
 all completely in kitchen

b.* Mbárá a - mu - nyá mánya pe
 Mbara SM P1 eat food completely
 táma ngíma na kíísini
 time all in kitchen

“Mbara has always completely eaten the food in the kitchen”

Apart from *tama ngima* “always”, *pe* “completely”, other AdvPs such as *wanda wima* “everything”, and manner adverbs such as *wusi* “well” and *wube* “badly” are attested in the language. *Wanda wima* literally means “thing all”. Now, with respect to their relative order, it appears that *wanda wima* “everything” must precede *wusi* “well” or *wube* “badly”:

(41)

a. Mbárá a - mú - dzá wánda wímá wúsi
 M. SM P1 say thing all well

“Mbara said/told everything well”

b.* Mbàrà a - mu - dzaà wusi waànda wiàma
 Mbara SM P1 say well thing all

“Mbara said/told everything well”

If *wanda wima* is either modified, coordinated or focussed, it can appear after *wusi*, as predicted by Kayne (1975), Lonzi (1991: 358ff), Cardinaletti and Starke (1994), Cinque (1999): (42).

a. Vădzu va - má - tífiy - a íyere wusi yóngosi wánda wimá
 children SM P2 show FV teacher well perhaps thing all

“Children showed well perhaps everything to the teacher”

b. Vădzu va - má - fá íyere wusi wánda
 children SM P2 give teacher well thing
 wimá kee itina (a wánda wimá)
 all or hall of thing all

“Children gave everything or half to the teacher well”

c. Vădzu va - mu - tífiy - a íyere wusi
 children SM P1 show FV teacher well
 WAàNDA WIMAà (focus)
 Thing all

“Children howedwell *Everything* to the teacher”

d. Vădzu va - mu - tífiya iyére wusi
 children SM P1 show teacher well
 wánda wimá na wánda wimá (focus)
 thing all and thing all

“Children showed well *Everything* to the teacher”

Notice that *wusi* too can be modified, coordinated or focussed (structurally or intonationally):

a. Vădzu va - má - tífiy -a íyere wándá wima wusi na wusi
 children SM P2 show FV teacher think all well and well

“children showed to the teacher everything really well”

b. Vădzu va - mu - dzăn - a íyere waànda wimaà WUSI

children SM P1 tell FV teacher thing all WELL

“ children told the teacher everything WELL”

c. wusi OWU vǎdzu va -mu -dzǎn - a íyere wánda wimá

well FOC children SM P1 tell FV teacher thing all

“It is well that children told the teacher every thing”

If the AdvPs *pε* “completely” *wanda wima* “everything” and *wusi* “well” appear in the same clause, what is their relative order? The order seems to be the following, as evidenced by the following data:

(44) wánda wimá > pε > wusi

Always Compl well

(45)

a. Mbárá a -mw[u] - éng- a wánda wina pε wusi

Mara SM P1 do FV thing all completely well

“Mbara did completely everything well”

b. * Mbárá a -mw [u] - énga pε wánda wimá wusi

Mabra SM P1 do completely thing all well

“Mbara did completely everything well”

Notice that *ítira* which seems to pattern with/like *pε* corroborates the above facts. It means either *half* or *partially*:

(46)

a. Nduma a- má- any - o ítira a bíya

Nduma SM P2 drink FV half of beer

“Nduma drank half a bottle of beer”

b. Nduma a- mu- fá íyere wánda wimá ítina wusi

Nduma SM P1 give teacher thing all partially well

“Nduma gave the teacher partially everything well”

An adverb like *muke* “only” belongs to the same class as Italian *solitamente di solito, abitualmente, usualmente, normalmente*, and French *habituellement, normalement, d’habitude, ordinairement*, etc. It can precede *wanda wima, pe*, and *wusi/wube*:

a. Ngura a - m(á) -éng a manó pe

Ngura SM P2 do FV work this only completely badly

“Ngura did only this work completely badly”

b. Ngura muká a - m(á) - éng - a Wánda wimá pe wusi

Ngura only SM P2 do FV thing all completely well

“Only Ngura did completely everything well”.

It should be borne in mind that there are contexts where *muka* functions like an adjective:

(48)

a. Ngura a-mu múka ra tumbá

Ngura SM is alone in bedroom

“Ngura is alone in the bedroom”

b. Ngura a- kutu -dzodzõn - o ndámba múka na sükúru

Ngura SM Prog. play FV ball alone in school

“Ngura is playing soccer alone in school”

That notwithstanding, the overall order of the adverbs studied so far seems to be the following:

Múka > wándá wimá > pe > wusi

“only” “everything” “completely” “well”

For the Romance languages described and analyzed by Cinque (1999) (Italian and French), the overall order of adverbs, at this stage of the study, was:

a. Solitamente > mica > già > più > silempre > completamente > tutte > bene

b. généralement > pas > déjà > plus > toujours > complètement > tout > bien

Tuki seems to have no adverbs equivalent to the Romance adverbs *mica/pas* > *già / déjà* > *più/plus*.

Rather these notions are expressed in the language through clausal functional heads, as evidenced by the following sentence.

(51)

Numongo a - too - mu - nu - dzw [u] éng -a wánda wimá pɛ wusi

Numongo SM Neg + 1 already no longer do FV thing all completely well

‘‘Numongo has not any longer always done completely everything well’’

We will come back in detail to the status and order of these clausal functional heads in a subsequent section.

Given the above, *tama ngima* ‘‘always’’ appears to be ordered between *muka* ‘‘only’’ and *wanda wima* ‘‘everything’’ on the hierarchy:

(52)

Muàka > *tama ngiàma* > *waànda wimaà* > pɛ > musì

‘‘only’’ ‘‘always’’ ‘‘everything’’ ‘‘completely’’ ‘‘well’’.

The adverbial PP *ka wanda* (literally *without (some) thing*) ‘‘nothing’’ can fill the same position as *wanda wina* ‘‘everything’’

(53)

a. Varinga a- mu- dzăna Vatu wánda wimá wusi

Varinga SM P1 tell FV people / bamba thing all well good

‘‘Varinga told people everything well/good’’.

b. Varinga a- mu- dzăna vatu ka wánda wusi

Varinga SM P1 tell FV people / baàmbaà without thing well good’’

“Varinga told people nothing well/good”

Notice that the meaning of the negative polarity item *nothing/ anything* can be generated if *wanda* ‘‘something’’ and the negative *manka* – *ta/-/too-* co-occur in the same clause:

(54)

Varinga a – tá – mu – dzăna vatu wánda wusi / bámbá

Varinga SM Neg P1 tell people Something well good

“Varinga did not tell people anything well / good”.

The adverbs *wusi* ‘‘well’’/ *wubε* ‘‘badly’’ seem to occupy the position usually fit.

for manner adverbs. It appears that measure adverbs too can occupy the same space:

(55)

a. ifúndu ‘‘much’’

b. *ikitíi* or *katitíi* ‘‘ little’’

(56)

a. Mangádzu a- mw[u] - íb – a wánda wina ifundu n(a) ipatika

child SM P 1 steal FV thing all much in shop

“The child stole everything much from the shop”

b. *Mangádzu a- mw [u] - íb a ifundu waànda wimaà n(a) ipaàtiàra

child SM P1 steal FV much thing all in shop

“The child stole everything much from the shop”.

Bear in mind, however, that *ifunda* can also function as the determiner of an NP:

(57)

a. Vădzu ifúndu va – mu - biná

children many SM P1 danced

‘‘Many children danced’’

b.

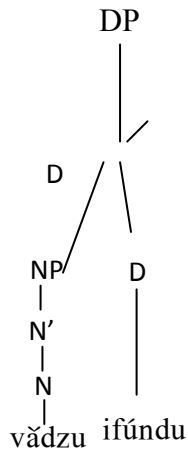

But in the following example, there seems to be no doubt that *ifunda* is an adverb as well:

(58)

Vǎdzu va - mu - biná ifúndu wusi na wusi

children SM P1 dance much well and well

‘‘children danced much very well’’

Moreover, the above example shows that *ifundi* ‘‘much’’ and *wusi* ‘‘well’’ do not occupy the same position, contra what was claimed above. More importantly, *wusi* may not precede *ifundu*, as the ungrammaticality of the following sentence demonstrates:

(59)

* Vǎdzu va- mu - biná wusi na wusi ifúndu ifundu

children SM P1 dance well and well much

‘‘children danced much very well’’

In view of the above, the following relative order of classes of AdvPs is postulated:

(60)

Muka > támá ngíma > wánda wimá > pε > ifúndu > wusi

‘only’ ‘always’ ‘everything’ ‘completely’ ‘much’ ‘well’

5.2. ‘Higher’ (sentence) AdvPs

In this section, attempts are made at answering the question whether sentence AdvPs respect a strict hierarchy.

Former classifications of higher AdvPs by Jackendoff (1972), Snear (1978), Bellert (1977) and Cinque (1999) will constitute the basis of this investigation:

(61)

a. Domain adverbs:

- na póró

with politics

‘Politically’

-na mbendó

with law

‘Legally’

b. Pragmatic adverbs:

- bébére

‘frankly, sincerely, honestly’

c. Evaluative adverbs:

-na ngangú

with luck

‘Luckily’

-na peyo

With intelligence

‘‘intelligently’’

-na vísángena

with joy

‘‘Happily’’

-na wusese

with awkwardness

‘‘Clumsily’’

Káá ngangú

without luck

‘‘Unluckily’’

d. Modal adverbs / epistemic adverbs

- kóó bukí

without falling

‘‘Certainly’’

Káá péte

without doubt

‘‘Undoubtedly’’

e. Yongósi

‘‘perhaps’’

The data illustrated above show that many of the so called higher AdvPs are in fact adverbial PP. But they behave like adverbs semantically and syntactically. Bellert (1977) and Cinque

(1999) argue that the adverbs of each category above are not members of the same class because they can co- occur in a certain order.

In the following examples, *Yongosi* ‘‘perhaps’’ precedes a ‘‘subject-orientated’’ adverbial PP like *na peyo* ‘‘intelligently’’ and a modal adverbial PP such as *kaa pete* ‘‘undoubtedly’’.

(62)

a. Masína a- nw [u] – otóó – m Yongósi na peyo ndebo ra nõsi

Masina SM F1 accept Inc. Asp perhaps with intelligence advice of mother

‘‘Masina will perhaps wisely accept her mother’s advice’’.

b.* Masína a- nw [u] - otóó - m na peyo yongosi ndebo ra nosi

Masina SM F1 accept Inc. Asp. with intelligence perhaps advice of mother

‘‘Masina will perhaps wisely accept her mother’s advice’’

(63)

a. Masína a- nw [u] - áká -m Vánábene Yongósi kóó bukí o- few - a

Masina SM F1 help Inc. Asp. Brothers perhaps without failing inf.build FV FOC

owu yendze

Foc house

‘‘Masina will certainly perhaps help her brothers build a house’’.

b.* Masína a- nw [u] - áká - m Vánábene kóó bukí Yongósi

Masina SM F1 help Inc. Asp. brothers without failing perhaps

O- fow - a owu yendze

Inf. Buil FV FOC house

‘‘Masina will certainly perhaps help her brothers build a house’’

Evaluative adverbial PPs like *na visangena* ‘‘happily’’ must precede modal adverbs such as *koo buki* ‘‘certainly’’:

(64)

a. Ndzoo a - mu - bárúm - a na

Ndzoo SM P1 meet FV with

Vámberé vaa na visangena

Friends his with joy

Kóó bukí na yěndze yáá

Without failing in house his

‘‘Ndzoo happily certainly met with his friends in his house’’

b.* Ndzoo a- mu - bárúm - a na

Ndzoo SM p1 meet FV with

Vámberé vaa Kóó bukí

friends his without failing

na visangera na gendze yaa

with joy in house his

‘‘Ndzoo happily certainly met with his friends in his house’’

(65)

a. na vísángena owu, káá pete

with joy FOC without doubt

Dima a- nw [u] - árá- m nambari

Dima SM f1 come Inc. tomorrow

“It is happily, undoubtedly, that Dima will come tomorrow”

b. *Káá pete owu, na vísángená

without doubt FOC with joy

Dimá a- nw [u] - árá- m

Dima SM f1 come Inc. Hsp.

Nambari

tomorrow

“It is undoubtedly, happily, that

Dima will come tomorrow ”

Pragmatic adverbs (also called “illocutionary” adverbs (Vendler 1984);

Or “speech act” adverbs (Roberts 1985) precede evaluative adverbs like *na sangena* “happily”:

(66)

a. bébére na vísángená nu n - dínká- m okutu omu

frankly with joy I SM love Inc. Asp woman this

“Frankly I happily love this woman”

b.* na vísángená bébére nu n- dínká m okutu omu

with joy frankly I SM love woman this

“Frankly I happily love this woman”

Given the above facts and reasoning, one should expect, by transitivity, pragmatic adverbs to precede “modal” adverbs and “subject – oriented ” adverbs. The prediction is borne out:

(67)

a. bébére, yǒngosi Mbárá a- nu –

frankly perhaps Mbara SM f1

bǎnam okutu omu (yǒngosi)

marry woman this

“Frankly, Mbara will perhaps marry this woman”

b.* yǒngosi, bébére Mbárá a- nu - bǎnam

perhaps frankly Mbara SM f1 marry

okutu omu

Woman this

There are adverbs, the distribution of which is not restricted. They are temporal adverbs anchored to speech time:

(68)

- Nambari “tomorrow”

- Wusúú “today”

- tété adzu “now”

(or adverbial PPs)

They precede “subject- oriented” adverbs such as *na peyo* “intelligently wisely” and *yongosi* “perhaps”.

(69)

Mbárá a- mw [u]- oto ndébo rá nõsi wusúú na peyo

Mbara SM p1 accept advice of Mother with intelligence

“Mbara has today wisely accepted her/his

Mother’s advice”

But they can also follow subject -oriented adverbs:

(70)

Mbárá a- mw [u] - otoo, ndébo ra nõsi na peyo wusúú

Mbara SM p1 accept advice of mother with intelligence today

“Mbara has today wisely accepted his/her mother’s advice

Although the latter sentence is acceptable, the former is preferred. In fact, it seems that *wusuu* and *na peyo* can be moved freely within the midfield (mittelfeld) and the postfield. (nachfeld):

(71)

a. Mbárá, wusúú, a- mu [u]- otoo

Mbara, today SM p1 accept

ndébo ra nõsi na peyo

Advice of mother with intelligence

“Mbara has today wisely accepted his/ her mother’s advice”

b. Mbárá a- mw [u]- otoo wusúú

Mbara SM p1 accept today

ndebo ra nõsi na peyo

advice of mother with intelligence

“Mbara has today wisely accepted

Her/his mother’s advice”

c. Mbárá a- mw [u]- otoo na

Mbara SM p1 accept with

peyo ndebo ra nŏsi wusúu

intelligence advice of mother today

“Mbara has today wisely accepted

Her/his mother’s advice”

With respect to the relative position of speech time adverbs (adverbial PPs) and *yongosi* ‘perhaps’, normally the former should precede the latter:

(72)

a. Mbárá a- mw [u]- etá tété odzu yŏngosi

Mbara SM p1 go back since this perhaps

“Mbara has now perhaps gone back”

b.* Mbárá a- mw [u]- etá yŏngosi tété odzu

Mbara SM p1 go back perhaps since this

“Mbara has now perhaps gone back”.

Speech time adverbs can either precede or follow modal, evaluative and pragmatic adverbs:

(73)

a. Vatu vá- n(u) - úbám andzará ra nkúnkúma koo buki wusúú

people SM f1 listen talks of chief without failing today

“People will certainly today listen to the chief’s speech”

b. Vatu va- n(u) - úbám andzará ra nkúnkúma wusúú koo buki

people SM f1 listen talks of chief today without failing

“people will certainly today listen to the chief’s speech”.

Bear in mind that the two AdvPs can equally be fronted, that is raised to clause initial position, without any resulting ungrammaticality.

(74)

a. Bébére tété odzu pára a- koránám Sambe miší míma

frankly since this priest SM prays god days all

“Frankly now the priest prays God every day”

b. tété odzu bebére pára a- koránám Sambe miší míma

since this frankly priest SM prays God days all

“Now frankly the priest prays God every day”

(75)

a. Na ngangú wusúú Kamerun a- nu -nobám Ndzamane na ndambá

with luck today Cameroon SM f1 beat Germany in ball

“Luckily today Cameroon will beat Germany in the soccer game”

b. Wusúú na ngangu Kamerun a- nu- nobám Ndzamane na ndambá

today with luck Cameroon SM f1 beat Germany in the soccer game”

“Today luckily Cameroon will beat Germany in the soccer game”

Speech time adverbs can also be topicalized, that is they can occupy the pre-field (Vorfeld) while the sentence adverbs reside either in the mittelfeld or in the post- field (Nachfeld), assuming the division of the clause in the following three domains slightly reformulated from Laenzlinger (2004):

(76)

Relative P > ForceP> FOC P > TopP> Fin P } Vorfeld

AgrP> ModP> NegP> TP> AspP1> AspP2 } MITTELFELD

> vP>VP } NACHFELD

(77)

a. Wusúú vatu vá- n(a)- ubám andzará ra nkúkúma kóó bukí

today people SM f1 listen talks of chief without failing

“Today, people will certainly listen to the chiefs talk”

b. Tété odzu Mbára a- mw [u] -éta yǒngosi

since this Mbara SM p1 Go back perhaps

“Now Mbara has perhaps gone back”

c. Nambári Mbára a- fítín o-băna Vákútú vabá na mbendó

tomorrow Mbara SM can Inf. marry Women two with law

“Tomorrow Mbara can legally wed two women”

Speech time adverbs seem to behave like domain adverbs that can also be topicalized and can dominate other sentence adverbs:

(78)

Na póró, bébére, vítsu tu- tá- fítí wénga wánda

with politics frankly we SM Neg can do thing

“politically, we cannot frankly do anything”

But it seems to be the case that any topicalised AdvP can dominate a domain adverb:

(79)

a. bébére, vítsu tu- tá- fítí wénga wánda na póró

frankly we SM Neg can do thing with politics

“Frankly, there is nothing we can do politically”

b. Káá pété, vibăna vi-tá- nyemé na póró

without doubt lies SM Neg be-good with politics

“Undoubtedly, lies are not politically good”

c. Tété odzu, ngománe a- n(u) – úryám matéyá n(a) ikpé ra

since this government SM f1 remove water from heads of

víibi ra póró

bandits with politics

“Now, the government is going to deal politically with thieves”

In view of the erratic behavior of domain adverbs (adverbial PPs) observed above, it may not be elegant to include them in any hierarchy.

Similarly, adverbs setting such as

(80)

a. *eéna* "here"

b. *naányá* "there"

c. *aáníi benébe* "very far"

d. *káá benébe* "very far"

without close/new

enjoy a freer casting in the sentential spectrum:

(81)

a. *eéna Mbárá a- nu - băna- m Okutu wáá na vísángena na miison o*

here Mbara SM f1 marry Inc. woman his with joy in church

n(a) adongo

of village

"Mbara will happily wed his will here in the village church"

b. *naanya biisobo a- nu- dwii – on Vatu koo buki sunda odzu a-va-m*

there bishop SM f1 baptize People without failing Sunday rel. SM comeInc.

"The bishop will certainly baptize people there next Sunday"

c. *aáníi Vakutu vá- nu- nemá- on mbásá yǒngósi na mań r(a)*

over there women SM f1 plant Inc. corn perhaps on top of

ongwene

mountain

"Over there women will perhaps plant corn on top of the mountain"

(82)

a. Mbárá a- nu - bǎna- m okutu wáá na vísángená eéna ra

Mbara SM f1 marry Inc. woman his with joy

miisono w(a) adongo

church of village

“Mbara will happily wed his wife here in the village church”

b. bíisobo a- nu- dwíí - m watu Kóó bukí naányá sundé odzu

bishop SM f1 baptize Inc. people without failing there Sunday rel.

a- rá- m

SM come Inc.

“The bishop will certainly baptize people there next week”

c. Vakutu va - nu- nemá - m mbásá yǒngósi aání na mana r(a)

women SM f1 plant Inc. corn perhaps over there on top of

ongwene

mountain

“Women will perhaps plant corn over there on top of the mountain”

Bébére > na vísángená > kóóbukí > tété odzu > yǒngósi > na peyo

“frankly” “happily” “certainly” “now” “perhaps” “intelligently”.

5.3.3 “Lower” AdvPs in VP-final position

In Tuki, AdvPs cannot occur in pre-VP position(s) unless they are focalized, topicalized or parentheticalized. More precisely, they cannot appear between the subject and the verb; but they can occur before (or precede) the subject in focus and topic position. For illustration, consider the following examples:

(84)

a.* Mbárá kóó bukí a- nu - bǎna-

Mbara without failing SM f1 marry

m ngonde ra nkúkúma

Inc. daughter of chief

“Mbara will certainly marry the chief’s daughter”

b.Mbárá, kóó bukí, a- nu- bǎna

Mbara without failing SM f1 marry

m ngonde ra nkúkúma

Inc. Daughter of chief

“Mbara will certainly marry the chief’s daughter”

(85)

1. *Putá yǒngósi a- nu- kusá itutu

Putá perhaps SM p1 buy motorcycle

raa na Ndzamane

her in Germany

“Putá has perhaps bought her motorcycle in Germany”

b.Putá, yǒngósi, a- mu- kusá itutu

Putá perhaps SM p1 buy motorcycle

“Putá has perhaps bought motorcycle in Germany”

In the above examples, the AdvP or the adverbial PP can appear in post-verbal position. We will come back shortly to this issue.

The following sentences show that the AdvP or the adverbial PP can be focalized or topicalized:

(86)

a. Kóó bukí owu Mbárá a- nu-

Without failing FOC Mbara SM f1

băn- á- mí ngonde ra nkúnkúma

Marry FV Inc. daughter of chief

“It is certain that Mbara will marry the chief’s daughter.

b. yǒngósi owu putá a- mu- kusá

perhaps FOC puta SM p1 buy

itutu raa na Ndzamane

motorcycle her in Germany

“It is perhaps a fact that Puta bought her bicycle in Germany”

(87)

a. Kóó bukí, Mbárá a- nu- bǎna-

without failing Mbara SM f1 marry

m ngonde ra nkukuma

Inc. Danghter of chief

“Cerainly Mbara will marry the chief’s daughter”

b. yǒngósi, Mbárá a- nu- bǎna- m

perhaps Mbara SM f1 marry Inc.

ngonde ra nkúnkúma

daughter of chief

“Perhaps Mbara will marry the chief’s daughter”

c. yǒngósi, Putá a- mu- kusá

perhaps Puta SM p1 buy

itutu raa na Ndzamane

motorcycle her in Germany

“perhaps Puta bought her motorcycle in Germany”

In Tuki, inside the VP, AdvPs or adverbial PPs can occur either after the complement(s) or before the complements:

(88)

a. Putá a- má- námb- a ngó na kíísini

Puta SM p2 cook FV hen in kitchen

Wusi

Well

“Puta cooked chicken in the kitchen well”

b. Mbárá a- mu- songo Putá na tumba fε

Mbara SM p1 fuck Puta in Bedroom again

“Mbara has fucked again Puta in the bedroom”

c. Mbárá a- tá- ibá matuwa

Mbara SM Neg steal car

tama ngima

time all

“Mbara does not always steal a car”

(89)

a. Putá a- má- namb- á wusi

Putá SM p2 cook FV well

ngo na kíisini

chicken in kitchen

“Putá cooked chicher well in the kitchen”

b. Mbárá- a- mu- songo fε Putá na tsumbá

Mbara SM p1 fuck again Putá in bedroom

“Mbara made love again to Putá in the bedroom”

c. Mbárá a- t(a)- ibá táma ngima matuwa

Mbara SM Neg steal time all car

“Mbara does not always steal a car”

So, more often than not, AdvPs or adverbial PPs can occur either before or after complements in Tuki. However, with a verb such as *o- fa* ‘to give’ that selects double object complements, the word order is rigid.

In the above paradigm, adverbs of setting can appear either before an evaluative adverbial PP, a modal adverbial PP *yongosi* ‘Perhaps’ or after them.

Abstracting therefore away from speech time adverbs, domain adverbs and adverbs of setting, the following relative order for the higher adverbs classes is obtained in Tuki: for double object complements, the word order is rigid:

bebere> na visangana> koo buki>tete odzu>yongosi> na peyo

“Frankly” “happily” “certainly” “now” “perhaps” “intelligently”

(90)

a. Mbárá a- má- fá Putá wánda wimá

Mbara SM p2 give Puta thing all

“Mbara gave Puta everything”

b. Mbárá a- má- tám- én - á Putá wánda wimá

Mbara SM p2 send APPL FV Puta thing all

“Mbara sent Puta everything”

(91)

a. * Mbárá a – má – fá wánda wimá Putá

Mbara SM p² give thing all Puta

b. * Mbárá a – má – tom – en – á wánda wimá Putá

Mbara SM p² send APPL FV thing all Puta

The verbs *o-fa* “to give” and *o-tome –na* “to send for” sequentially select the indirect object complement ; and that order is irreversible.

So called higher (sentence) Adv_s or Adverbial PP_s or Adverbial PPs can not normally occur in post-complement position :

(92)

a. * Nu nga – tá – dingá Putá bébére

I SM Neg love Puta frankly

“I do not love Puta frankly”

b. *Ndongta a - má - rondó manó ma Ndungu na ngangú

doctor SM p² cure illness of Ndungu with luck

“The doctor luckily cured Ndungu’s illness”

c. *Vădzu vá - nu-woro- m ntsina koo buki

children SM f1 take Inc train without failing

“Children will certainly take the train”

d. *Mbárá a - mu - wúbá Putá yǒngósi

Mbara SM p1 hit Puta perhaps

“Mbara hit perhaps Puta”

e. *Viróó a - mu -gira Putá na peyo

Viroo SM p1 wait for Puta with intelligence

“Viroo waits intelligently for Puta”

If the sentence AdvPs or adverbial PPs are deaccented, the sentences in which they occur will be grammatical:

(93)

a. Nu nga- tá- ðingá Putá, bébére

I SM Neg love Puta frankly

“I do not love Puta, frankly”

b*.Ndongta a- má- rondó mono ma Ndongu, na ngangú

doctor SM p2 cure illness of Ndongu with luck

“The doctor cured Ndungu’s illness, luckily”

c. Vǎdzu va- nu- woró- m ntsina, koo buki

children SM f1 take Inc. train without failing

“Children will take the train, certainly”

d. Mbárá a- mu - wubá Putá yǒngósi

Mbara SM p1 hit Put Perhaps

“Mbara hit Puta, perhaps”

e. Viroo a- mu- gira Putá, na peyo

Viroo SM p1 wait for Puta with intelligence

“Viroo waited for Puta, intelligently”

Just like in Italian, in this language ‘‘more than one deaccented sentence AdvP [or more than one adverbial PP] can appear after the constituent bearing the nuclear stress of the sentence (or a focus stress)’’ (Cinque 1999):

(94)

a. i- fwánerá- m ee mwáná itsu a- nu- endá- m n(a) adongo

SM resemble Inc. that child our SM f1 go Inc. to village

Ya mitangu na ngangu yǒngósi

of white too with luck perhaps

“It seems that our child will go to the white man’s country too, luckily, perhaps”

b. i- fwánéna- m ee mwáná itsu a- nu - endá n n(a) adongo

SM resemble Inc. that child our SM f1 go Inc. to village

Ya mitáng TUNU, yǒngósi, na ngangu

of white too perhaps with luck

(95)

a. Nu nga- tá- dingá MUTU Mo bebere, tama mo

I SM Neg love man some frankly time some

“I do not like anybody, frankly sometimes”

b. Nu nga- tá - dinga MUTU Mo, tama mo, bebere

The two deaccented AdvPs can occur in any order. Above, it was shown that speech time adverbs can occur among higher sentence AdvPs. They can also appear in post-complement position, even when they are not deaccented:

(96)

Pára a- ru- béraára Mbárá Tete odzu / wusuu / tama adze

Priest SM just called Mbara now / today / time this

“The priest just called Mbara now / today / at this moment”

Temporal adverbials behave pretty much like adverbs of setting in that they can occupy post-complements positions and they do not seem to be rigidly ordered (cf. Chomsky 1995: 333; Cinque 1999). They pattern, in this respect, with adverbial (PPs and adverbials of place, time, manner, means, reason, purpose, etc. (cf. Cinque 1999)).

In the following Tuki examples, several arrangements of constituents are licensed, which is not possible with higher sentence AdvPs or lower AdvPs.

(97)

a. Nu ngu- n(u) - endám ena íyere misí míma ná sukuru n(a) osya otemá

I SM f1 go see teachers days all in school with good heart

“I will go see the teacher every day in school in good faith”

b. Nu ngu - n(u) - endám ena íyere na sukuru mísí míma n(a) osya

I SM f1 go see teacher in school days all will good

Otemá

heart

c. Nu ngu - n(u) -endám ena íyere na sukuru n(a) osya otema mísí mímá

I SM f1 go see teacher in school with good heart days all

d. Nu ngu - n(u) - endám era íyere N(a) osya otema na sukuru mísí mímá

I SM f1 go see teacher with good heart in school days all

In this specific respect, the Tuki data behaves like the Italian empirical material described and analyzed by Cinque (1999). The following examples show that “when the lower pre-VP AdvPs [such as *fε* “again”] appear after the complements, they also follow all the (anordered) temporal, locative, manner, etc. adverbials, unless the latter are deaccented” (Cinque 1999):

(98)

a. Nu ngu - n(u)- endám ena íyere mísí mímá na sukuru n(a) osya

I SM f1 go see teacher days all in school with good

otema *Fε*

heart again

“I will go see the teacher every day in school in good faith again”

b. Nu ngu- n(u) - endám ena íyere mísí mímá na sukuru *Fε*, n(a) osya

I SM f1 go see teacher days all in school again with good

otema

heart

c. Nu ngu - n(u)- endám ená íyere FE, mísí míma, na sukuru, n(a) osya

I SM f1 go see teacher again day all in school with good

otema

heart

In partial conclusion, adverbs seem to be ordered in Tuki in the following way: an ordered sequence of higher (sentence) adverbs precedes an ordered sequence of lower adverbs that appear at the end of the VP bearing nuclear or focus stress. As opposed to the situation that obtains in Italian and in French, Tuki lower adverbs cannot occur in front of the VP, unless they are parentheticalized. More-over, speech time adverbials (or temporal adverbials), adverbs of setting and domain adverbs can occupy various VP- internal post- complement positions or any other clausal positions. They are unordered with respect to each other; they can either precede lower them when the latter are not focussed (or are deaccented, just like they can also follow deaccented higher sentence AdvPs or any deaccented material.

(99)

‘Higher’ (sentence) AdvPs > ‘Lower’ AdvPs > place, time, manrer, etc, adverbials> (focussed) ‘Lower’ AdvPs > deaccented material.

5.4. AdvP movement

Apparently several AdvPs can be fronted in Tuki. Adopting the structure of the left periphery proposed by Rizzi (1997), one can argue that one of the AdvPs substitutes for the Spec of the Foc (us) P(hrase) while the other substitutes for the Spec of the Top(ic) P(hrase). Cinque (1999) observes that certain ‘higher’ (sentence) AdvPs move to the COMP ‘space’ in French: *peut-être*, *quelques fois*, ‘epistemic modal’ AdvPs like *probablement*, *sans doute*, *certainement*, etc., and ‘evaluative’ AdvPs like *heureusement*, etc. Cinque quotes Sueur

(1978, 238) who notes contrasts like the following [...] ‘also from Sueur 1978, which showed that within the same ‘space’ ‘evaluative’ adverbs have to precede ‘epistemic modal ‘adverbs’:

(100)

a. Heureusement, sans doute que Pierre viendra

“Luckily undoubtedly Pierre will come “

b. *Sans doute, heureusement que Pierre viendra

“Undoubtedly luckily Pierre will come”

(101)

a. Heureusement que sans doute, Pierre viendra

“luckily that undoubtedly Pierre will come “

b. ?? Sans doute que heureusement, Pierre viendra

“Undoubtedly, luckily, Pierre will come”

In Tuki , two adverbial PPs can be topicalized, with the evaluative dominating the epistemic modal one:

(102)

a. na vísángena, káá pete, Dimá a- nw[u]- ará- m nambáří

with joy without doubt Dima SM f1 come Inc. tomorrow

“Luckily undoubtedly, Dima will come”

b. na vísangena owu, káá pete Dimá a- nw [u] ará - m nambáří

with joy FOC without doubt Dima SM f1 come Inc. tomorrow

“It is luckily and undoubtedly that Dima will come tomorrow”

In (102), both adverbial PPs *na visangena* “luckily” and *kaa pete* “undoubtedly” have been topicalized: they occupy the positions [Spec,TopP]:

(103)

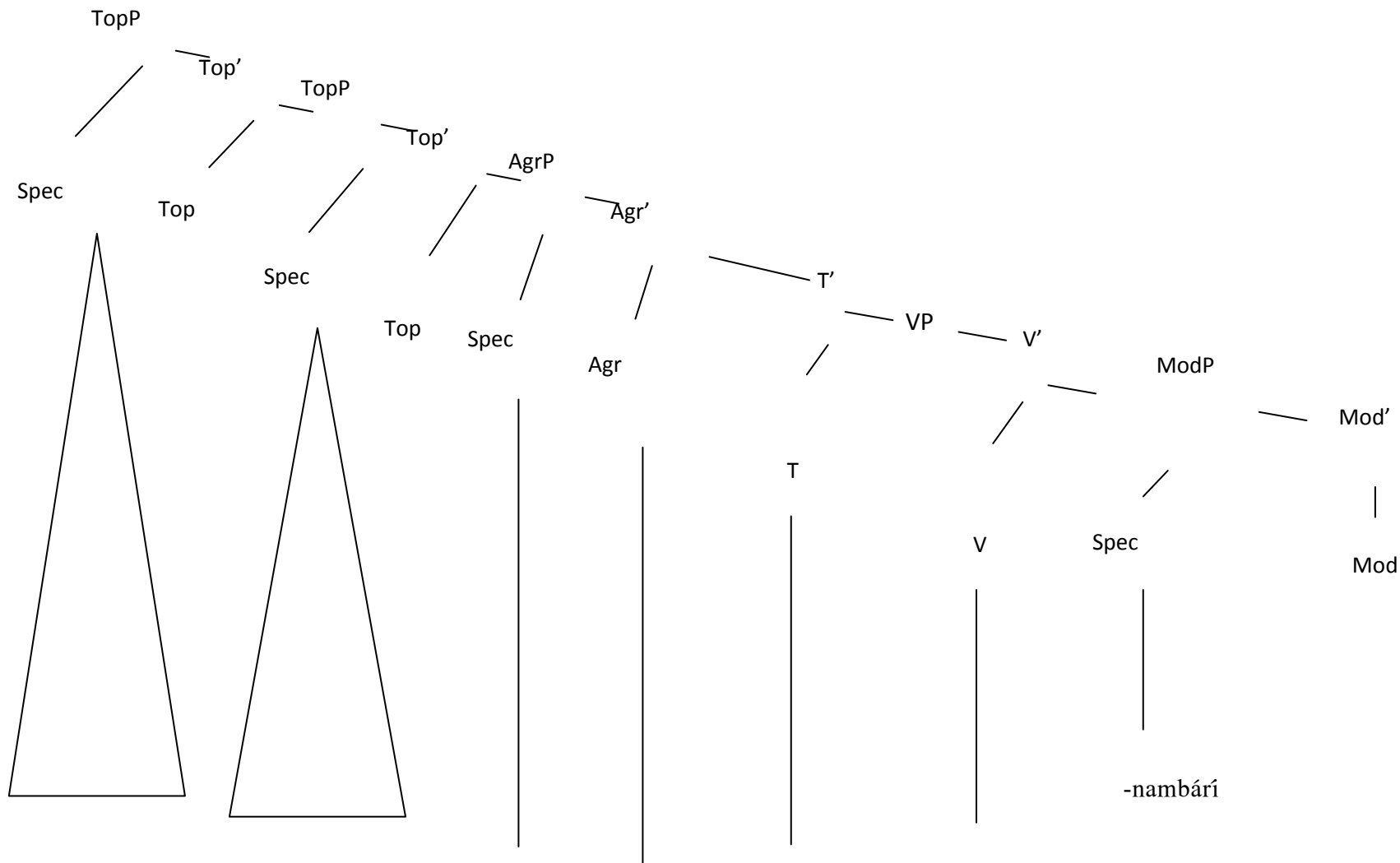

Na vísán-gena

Káá pete

Dimá

a-

-nw

-aram

-nambárí

The focalization and topicalization of adverbial PPs seem to indicate that the latter elements exhibit behaviour typical of wh- movement.

A number of works has concentrated on the raising of adverbs over their counterparts (Koster 1978, Cinque 1999, Rizzi 2004). In Dutch, Italian and French, there seems to be a ban against adverbs crossing, although this ban may not apply across the board. It would be interesting to find out what is going on in Tuki.

5.5 Relativized Minimality with adverbs

Consider the following examples:

(104)

a. Vǎdzu va- mú- suwá yěndze ya

children SM p1 wash house of

sukuru kóó bukí kimi

school without failing rapidly

“The children have certainly cleaned the classroom rapidly”

b. Vǎdzu va- mú - suwá yěndze

children SM p1 wash house

ya sakuru kóó bukí

of school without failing

“The children have certainly cleaned the house”

c. Vǎdzu va - mú- suwá yěndze

children SM p1 wash house

ya sukuru isimi

of school rapidly

“The children have rapidly cleaned the house”

In (a), the epistemic adverbial PP *koo buki* “certainly” licitly precedes the celerative adverb *isimi* “rapidly”. In the (b-c) sentences, each one of the AdvPs occurs alone. Any one of these AdvPs can be fronted, focused or topicalized:

(105)

a. Isimi, Vădzu va- mú - suwá yěndze ya sukuru

rapidly children SM wash house of school

“Rapidly, children cleaned the classroom”

b. Isimi owu vadzu va- mu- suwa yendze ya sukuru

rapidly FOC children SM p1 wash house of school

“It is rapidly that children cleaned the classroom”.

(106)

a. Kóó bukí, vădzu va- mu- suwá yěndze ya sukuru

without failing children SM p1 wash house of school

“Certainly, children cleaned the classroom”

b. Kóó bukí owu vădzu va- mu – zuwa yěndze ya sukuru

without failing FOC children SM p1 wash house of school

“It is certain that children cleaned the classroom”

But the celerative adverb *isimi* “rapidly” cannot be fronted across the epistemic adverbial PP *koo buki* “certainly”:

(107)

*Isimi, vǎdzu va- mu- suwá yěndze ya sukuru kóó bukí

Rapidly children SM p1 wash house of school without failing

“Rapidly, the children have certainly cleaned the classroom”

What obtains above is valid too as far as the behaviour of the manner AdvP *igeree* “slowly” is concerned. The following sentences show that *igeree* can be fronted, but not across the frequentative AdvP *tama mo* “sometimes”:

(108)

a. Abo a- fendá- ní mátuwa wáá tama mo igeree

Abo SM repair Inc. car time some slowly

“Abo sometimes repairs his car slowly”

b. Igeree, Abo a- fenda- m matuwa waa

slowly Abo SM repair Inc. car his

“Abo slowly repairs his car”

c.* Igeree, Abo a- fendá – ní mátuwa wáá tama mo

slowly Abo SM repairs Inc. car his time some

“Slowly, Abo sometimes repairs his car”

d. Táma mo, Abo a- fendá - ní mátuwa waa igeree

time some Abo SM repair Inc. car his slowly

“Sometimes, Abo slowly repairs his car”

So with regard to the ban against adverb crossing, Tuki patterns with Dutch and Italian (Koster 1978; Rizzi 2004). Similarly, just like French (Schlyter 1974), German (1999) and Italian (Rizzi 2004), Tuki circumvents the ban against adverb crossing by raising the faultive adverb to a focalized position:

(109) Igeree owu Abo a- fendá - m' mátuwa wáá táma mo

Slowly FOC Abo SM repair Inc. car his time some

"It is slowly that Abo sometimes repairs his car"

Moreover, in Tuki, just like in Italian, negation blocks adverb movement across a higher adverb, irrespective of whether the adverb is focalized or not:

(110)

a.*Igeree Abo a- tá- fend- á mátuwa wáá

slowly Abo SM Neg repair FV car his

"Slowly, Abo does not repair his car"

b. igeree owu Abo a- tá- fend- á mátuwa wáá

slowly FOC Abo SM Neg repair FV car his

"Slowly, Abo did not repair his car"

Furthermore, Rizzi (2004) indicates that "in special discourse contexts the 'no crossing effect' [...] disappears completely in Italian, even in the absence of focalization. This happens when the adverb has been mentioned in the immediately preceding discourse, a state of affairs that naturally arises, e.g., when a previous statement is corrected with a contrastive focus on some other constituent different from the adverbs" in Italian. Finally, "in this kind of contexts with a recent mention of the preposed adverb, even negation ceases to have an adverse effect on adverb movement". The same facts seem to obtain in Tuki:

(111)

A: Nu m- bungáná- m ee Abo a- mu - fend- á vámatuwa wáá

I SM think Inc.that Abo SM p1 repair FV cars his

Vabá isimi

two rapidly

“I think that Abo has rapidly repaired his two cars”

B: mbendo: isimi, Abo a- mu - fend- á mátuwa wáá omősi

no rapidly Abo SM p1 repair FV car his one

Kóó bukí _____, veda pro a – tá – o - fend – á odzumó

Without failing but SM Neg not yet repair FV other

“No, rapidly, Abo has certainly repaired one of his cars, but he has not yet repaired the other one”

(112)

Nu nga- má - búngan- á ee Abo a- má- fítí o- fend á

I SM p2 think FV that Abo SM p2 can inf. repair FV

Vámátuma amáá isimi, veda pro ndjan – ă- m o- dzar- a ee, isimi,

Cars these rapidly but must FV Inc. Inf. Say FV that rapidly

Pro a- tá- wu- fend- á

SM Neg OM repair FV

“I thought that Abo could rapidly repair These cars, but I must say that, rapidly, he did not repair then”

In view of the above, the movement of adverbs in Tuki is regulated by the following descriptive statements :

(113) (cf. Rizzi 2004)

a. Intervening adverbs make it impossible to raise a non- focal adverb to the front initial position of a clause.

b. The preposing of the adverb is possible if it is focussed.

- c. Negation blocks both simple adverbs preposing and preposing to a focus position.
- d. When the adverb is mentioned in the immediately preceding discourse context, its preposing is possible even if there is an intervening adverb or negation.

5.6 Tuki adverbs and the structure of the left periphery

Rizzi (1997, 2004) describes the left periphery of the clause as a structural zone defined by a system of functional heads and their projections along the following lines:

(114) Force Top * FOC Top* Fin IP

The system is delimited upward by force, the head expressing the clausal typing, the head of information which must be readily accessible to an external selector and downward by Finiteness, the head differentiating finite and non finite constructions” (Rizzi 2004). Tuki expresses the force head in finite clauses as *θθ* ‘that’:

(115)

Nu ng - dzímá - m ée Ngonó a timbá - m peyo

I SM know Inc. that Ngonó SM possess Inc. intelligence

“I know that Ngonó is intelligent”

Now consider the following sentence:

(116)

Nu m- bungáná - m ée nambari tsono idzi Ngonó a- nu - kusá- m

I SM think Inc. that tomorrow Clothes FOC Ngonó SM f1 buy Inc.

“I think that, tomorrow, it is clothes that Ngonó will buy”

The tree representation of the above sentence is the following:

(117)

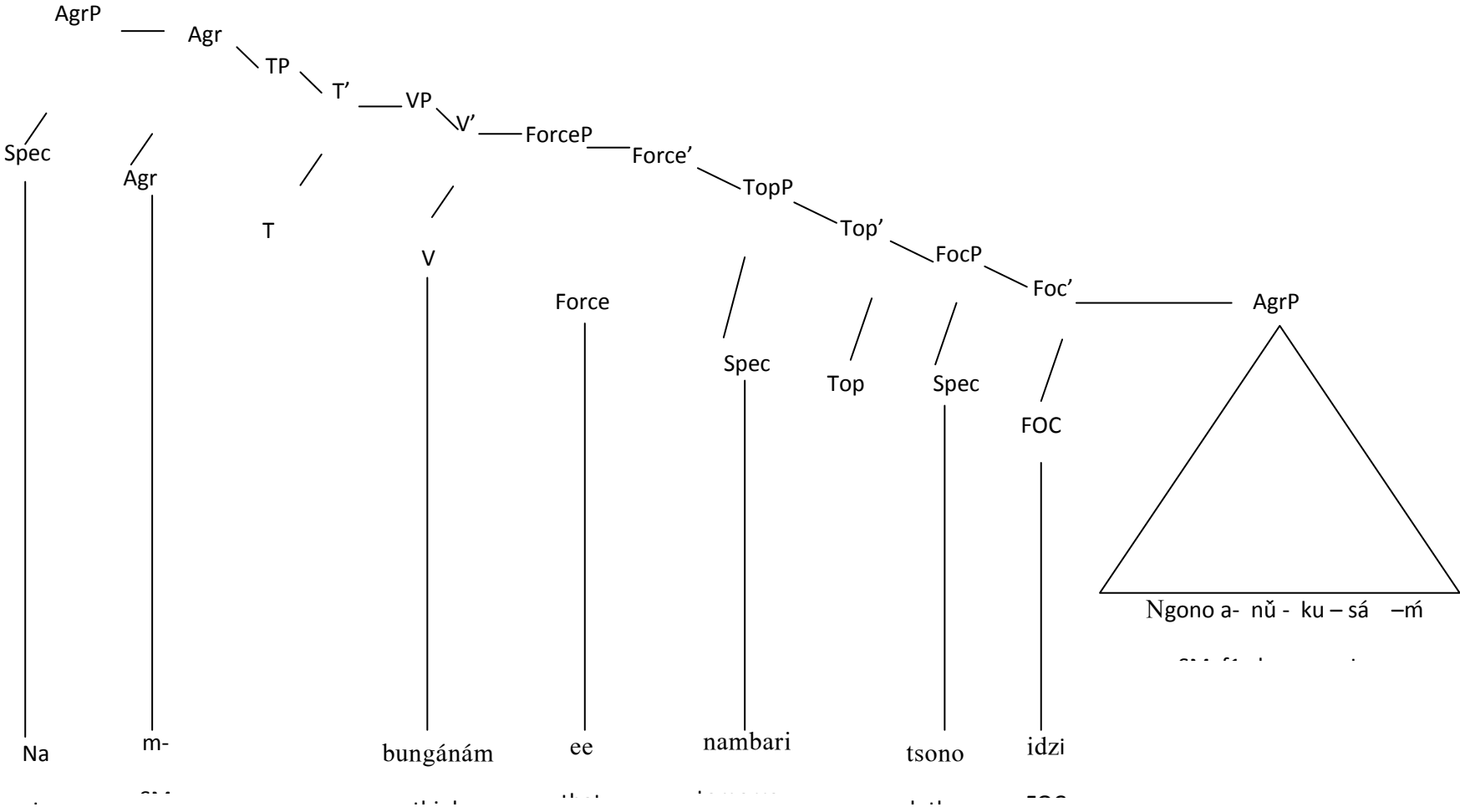

The question to ask is what position do left peripheral adverbs occupy in Tuki? Above, it was argued that adverbs can be topicalized and therefore occupy the specifier position of the topic phrase (TopP). But Rizzi (2004) shows that adverbs and topics do not exhibit a similar behaviour as far as raising to the left periphery is concerned. On the one hand, “ a preposed adverb seems to have something in common with a topic, the fact of being made prominent by movement to the left periphery, but it does not share with the topic the necessary connection to the background, whence its compatibility with ‘‘ what happened’’ contexts ‘‘ (Rizzi 2004).

On the other hand, “distributional properties also suggest that preposed adverbs normally fill positions distinct from topic positions’’ (Rizzi 2004). More over, ‘‘preposed adverbials, contrary to genuine topics [...], cannot naturally precede wh-elements in questions’’. It is true in Italian as well as in Tuki:

(118)

a. Isimi, nanga adze vagurá va - má - fowa

rapidly house FOC pygmies SM p2 build

“rapidly, it a house that pygmies built”

b.* isimi, ate (aye) vagurá va – má- fowa

rapidly what FOC pygmies SM P2 build

“Rapidly, what did pygmies build ?”

c. Isimi, nanga, vagurá va- má - fowa

rapidly house pygmies SM p2 build

“ rapidly, a house, pygmies built”

d. Putá, ate (aye) vagurá va- má- fow - én - a

Putá what FOC pygmies SM p2 build APPL FV

“Putá, what did pygmies build for”

The above data show that an adverb can precede a topic (as in (118 c)), but it cannot dominate a wh-word in an interrogative (as in (118 b)). A topic can precede a wh – phrase (as in (118 d)). It follows therefore that so called topicalized adverbs do not behave like genuine topics.

On the basis of the analysis of Italian and English data, Rizzi (2004) concludes that ‘only referential nominal expressions are natural topics, adverbs are not, so they cannot naturally occupy topic positions. [...] preposed adverbs can occupy at least three distinct structural positions in the left periphery. Normally, they occupy a dedicated position which is intonationally similar to a topic position, but differs from it in that the adverb position does not require a connection with the previous discourse context, cannot naturally precede Wh operators, does not give rise to any island effect, gives rise to anti-adjacency effects’.

It seems to be the case that the Tuki empirical material can be nicely accounted for in terms of Rizzi’s analysis. Following it therefore, assume that a (preposed) adverb substitutes for the specifier position of a modifier p(hrase), as tree- diagrammed by us in the following way:

(119)

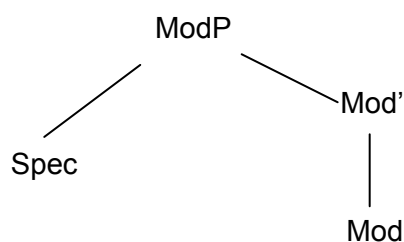

Above and here, Kayne’s (1994) proposal that intermediate projections be done away with is discarded for the time being. In Tuki, a celerative adverb can either remain in the Spec of its licensing IP- internal Mod head, or move to the Spec of the left peripheral Mod head, thus acquiring structural prominence:

(120)

a. Vakútu vá- mu - será mbasá ísími

women SM p1 sell corn rapidly

“Women have rapidly sold corn”

b.* Vakútu va- mu - será ísími mbasá

women SM p1 sell rapidly corn

c. Vakútu, ísími, vá- mu- será mbasá

women rapidly SM p1 sell corn

“women have rapidly sold corn”

(120 b) is ungrammatical, probably because the case adjacency requirement is not abided by. The occurrence of the adverb between the verb and the direct object complement prevents the former from assigning (accusative) case to the latter. (120 c) is grammatical only if the adverb is parentheticalized; otherwise the adverb cannot normally appear between the subject and the verb in Tuki:

(121)

* Vakútu ísími vá- mu- será mbasa

Women rapidly SM p1 sell corn

As stated above, the adverb can either raise to the Spec of the left peripheral Mod head in a topicalized fashion or to the Spec of the Foc(us) P(hrase).

(122)

a. ísími, Vakútu va- mu - será mbasá

rapidly women SM p1 sell corn

“Rapidly, women have sold corn”

b. ísími owu vakútu vá- mu - será mbasá

rapidly FOC women SM p1 sell corn

“it is rapidly that women have sold corn”

The tree representations of the two sentences above are the following:

(124) a.

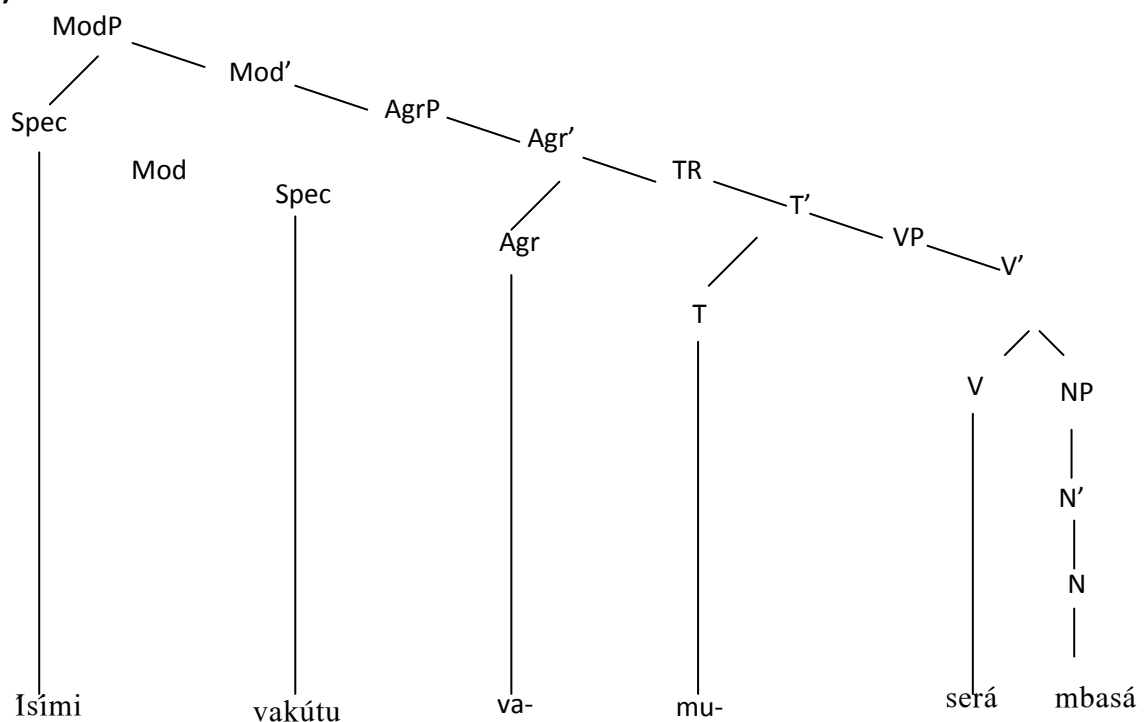

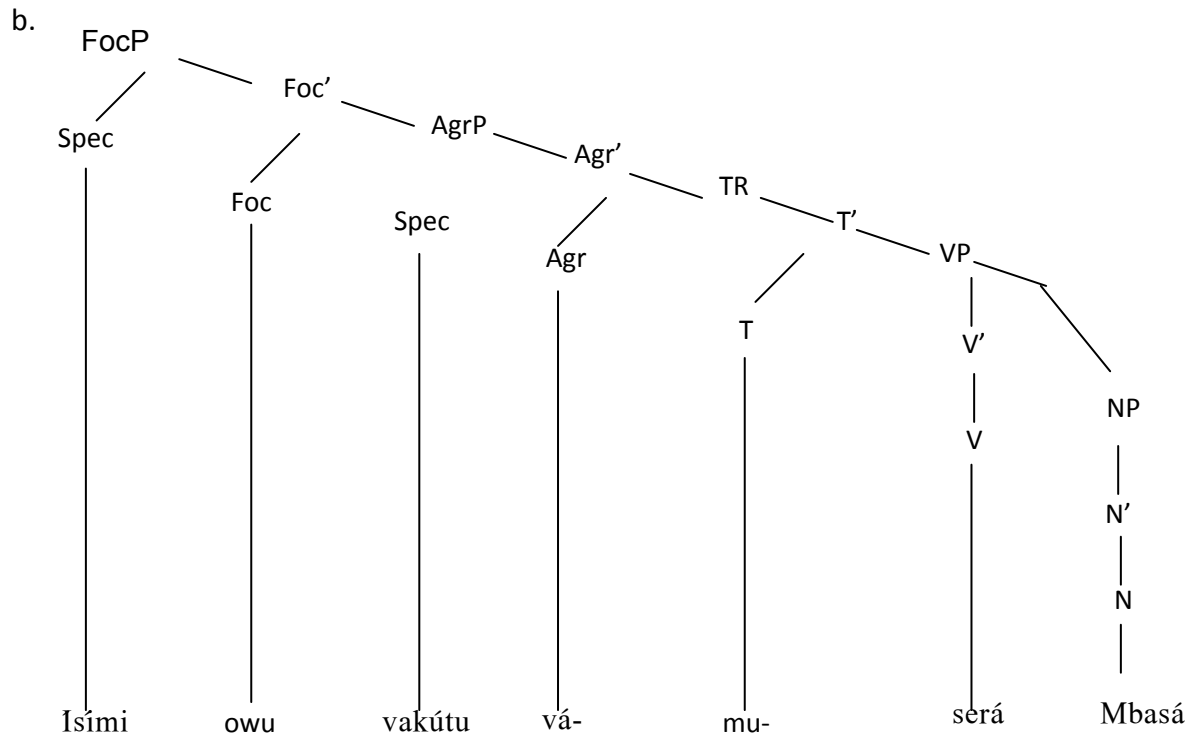

Above, it was argued that a preposed adverb cannot precede or dominate an extracted wh-phrase, which suggests that left peripheral ModP cannot dominate FocP since moved wh- items in Tuki interrogatives raise to [Spec, FocP]. But it was also seen that left peripheral ModP can dominate TopP. Given that the latter can dominate FocP, by transitivity ModP can dominate FocP. It was also shown that ModP can occur IP-internally. On the basis of the above observations, the C system in Tuki can espouse the following configuration:

(125)

ForceP > IntP > (ModP) > TopP > FP > ModP > FinP > AgrP

Cinque (2004: 703-704) argues that “there is another property which supports Rizzi’s discovery of a separate Modifier Phrase in the CP field which AdvP can access in addition to accessing Topical and FocusP: the existence of a whole class of AdvPs which can freely access the latter two positions but not the former. In Cinque (1999: section 5.1) it is noted that “lower adverbs” (from the negative AdvP *mica* downward) as opposed to all higher ones cannot precede the subject under normal conditions”. In agreement with the above, the following Tuki sentences demonstrate that the lower adverbs *pá* “completely”, *wusi* “well”, *wubá* “badly” and *kuku* “early” cannot be fronted:

(126)

a. Putá a- mu- nyá manyá ama na kíisini pε
 Puta SM P1 eat food of/that in kitchen completely
 “Puta completely ate the food that was in the kitchen”

b.* pε Putá a- mu- nyá manyá ama na kíisini
 completely Puta SM P1 eat food of/that in kitchen
 “completely Puta ate the food that was in the kitchen”

(127)

a.vǎdzu vá - mu - súwa yěndze a sukuru wusi
 children SM P1 wash house of school well
 “children washed the classroom well”

b.*wusi vǎdzu vá - mu - súwa yěndze a sukuru
 well children SM P1 wash house of school
 “ well children washed the classroom ”

(128)

a. Okará a- mu- fendá ntsína ra mátuwa wubε
 Okara SM P1 repair engine of car badly
 “Okala poorly/badly repaired the car’s engine”

b.* wubε Okará a- mu- fendá ntsína ra mátuwa
 badly Okara SM P1 repair engine of car
 “poorly/badly Okala repaired the car’s engine”

(129)

a.Avéna a- mu- fátana kúúku íbisi aye
 Avena SM P1 rise early morning this

“Avena got up early this morning”

b.* kúúku Avéna a- mu- fáténa íbísi aye
early Avena SM P1 rise morning this

“early Avena got up this morning”

The ungrammaticality of the (b) sentences above can be accounted for, if Cinque (2004) and Rizzi (2004) are right, by claiming that “such AdvPs (as opposed to all higher ones) cannot be moved to modifier in the CP field. The fact that they can (with some exceptions) appear in front of the subject if topicalized or focalized is then further evidence that topicalization and Focalisation should be kept distinct as Rizzi proposes, from Preposing to ModifierP” (Cinque, 2004: 704).

The Tuki facts discussed above seem to be similar to the French data studied by Laenzlinger (2004) who points out that “some adverbs in French are weak forms (*bien* “well”, *mal* “badly”, see Abeillé and Godard 2000) whose distribution is very constrained (e.g. *j’ai bien dormi* “I slept well” vs. ?? *J’ai dormi bien/ *bien, j’ai dormi*). They seem to be subject to an incorporation requirement, which distinguishes them from heavy adverbial forms.”

5.7. Circumstantial adverbials of “place, time, manner, etc.”

The class of adverbials considered in this subsection is sometimes called “circumstantial (cf. Ruwet 1968: 353; Lonzi 1991: 381; Fillmore, 1994; Cinque 1999, etc.). These adverbials follow the verb’s complements within the VP. According to Cinque, they comprise a varied selection of elements: place, time, manner, means, company, reason, purpose, etc.

Circumstantial adverbials ‘appear to differ from the adverb classes [such as the AdvPs] in not being rigidly ordered with respect to each other’ (cf. Cinque 1999 who quotes Chomsky 1995: 333). For illustration, reconsider the following examples that were analyzed earlier):

(130)

a. Nu ngu -nu -endám éna íyere na sukuru misí mímá na osyá ótemá

I SM fl go see teacher In school days all with good heart

“I will see the teacher in school every day with a good heart”

b. Nu ngu- nu- endám éna íyere na sukuru misí mímá na osyá ótemá

c. Nu ngu- nu - endám éra íyere na sukuru na osyá ótemá mísí mímá

d. Nu ngu- nu- endám éna íyere na osyá ótema na sukuru mísí mímá

The above examples clearly show that circumstantial adverbials can move around within a clause.

As opposed to AdvPs proper, circumstantial adverbials can be interchangeably in the scope of each other depending on their mutual structural relation. Consider, for example, the following two sentences:

(131)

a. Omwéne e- n- án- á- m pára mísí mímá ma sonde na míisono ondye

he/she SM see REP FV Inc. priest days all of week in church different

“he / she sees the priest every day of the week in a different church”

b. Omwéne e- n- án- á- m pára na míisono mímá wusi ondye wa sonde

he/she SM see REP FV Inc. priest in church all day different of week

“He/ she sees the priest in each church on a different day of the week”

In the first sentence above, the DP *míisono ondye* “a different church” is in the scope of *misi mima* “every day”. In the second sentence, the time adverbial containing a universal quantifier is in the scope of the place adverbial DP.

Similarly, the following two sentences prove that circumstantial adverbials are interchangeably in the scope of each other:

(132)

a. Omwéne a- m(á) -éna pára na míisono mímá na mbéré wáá ondye

he/ she SM p2 see priest in church all with friend his different

“he/she saw the priest in each church with a different friend”

b. Omwéne a- m(á) - éna pára na mbéré wáá ongíma na míisono ondye

he/she SM p2 see priest with friend his all in church different

“he / she saw the priest with each friend in a different church”

“Circumstantial adverbials also differ from AdvPs proper in that they are typically realized (with the partial exception of manner adverbials) in prepositional form [...] or in bare NP form [...]” (cf. Cinque 1999 who quotes Larson 1985, Stroik 1992):

(133)

a. Circumstantial adverbials in prepositional form:

-na kíísini “in the kitchen”

in kitchen

- na osya ótemá “with a good heart”

with good heart

- na mátuwa “with a car ”

with car

b. Circumstantial adverbials in bare NP form:

Wusúú matsóó matat “in three days”

today days three

- nambári
“tomorrow”

- éena
“here”

sonde a nyíma “the week after ”

week of back

As argued by Cinque (1999), circumstantial adverbials ‘’also appear to differ semantically from AdvP proper. While the latter are characteristically operators (functions mapping propositions to

propositions, or predicates to predicates), circumstantial adverbials can be seen (after Davidson 1967) as modifiers predicated of an underlying event variable”.

Moreover, in Italian AdvPs proper occupy pre-VP positions (not so in Tuki). But circumstantial adverbials cannot appear in pre-VP positions.

Five properties distinguish circumstantial adverbials from AdvPs. This prompts Cinque (1999) to suggest that the former deserves a separate treatment.

To the question “what is the structural position of circumstantial phases”. Cinque (1999) suggest, after reviewing a number of proposals (Chomsky 1995, Oystein, Nilsen...), that circumstantial adverbials occupy the Spec position of VP:

(134)

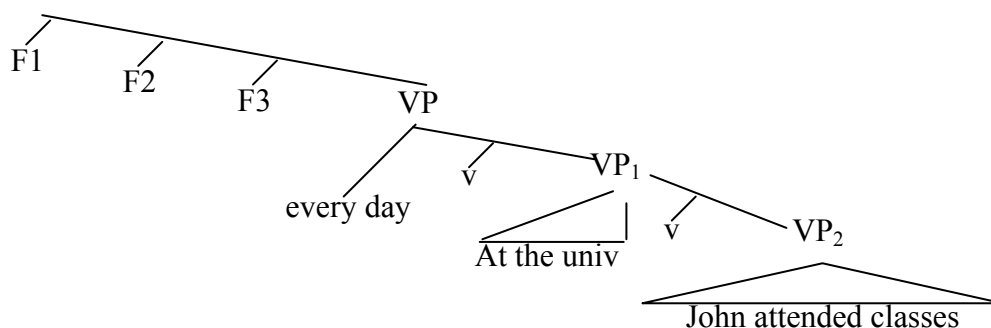

5.8 Focusing and parenthetical uses of AdvPs

In Tuki, certain adverbs can modify directly different types of constituents:

(135)

a. mbeng “only”

b. too “even”

(136)

a. Mbára a- dǐngá -m mbeng omwámáte

Mbara SM likes Inc. Only him/ herself

“Mbara likes only him/herself”

b. púrúsú í- má- nobá mbeng Putá

police SM p2 beat only Puta

“The police has beaten only Puta”

c. Aba a- mu- anyo rombo a biya Mbeng ítíra

Aba SM p1 drink bottle of Beer only half

“Aba has drunk a bottle of beer only partially”

From the above examples, it is obvious that *mbeng* can precede and modify DPs. However, it can also modify a verb or a VP by following it:

(137) Ara nǒsi a- mu- gwa íbisi, Numóngó a- kutu - banga mbang

When mother SM p1 die morning Numongo SM prog. Cry only

“When his mother died this morning, Numongo was only crying”

In any case, *mbeng* cannot precede the V. In any case, it has been shown above that an adverb cannot precede a VP in Tuki, nor can it occur between the subject and the VP.

Mbeng has the ability to modify a clausal projection:

(138)

Iyere u- dzá -m mbeng ee vǎdzu va- kutu- waána isawu na yǎndze ya sukuru

Teacher SM says Inc. only that Children SM prog. Sing songs in House of school

“The teacher says only that children are singing songs in the classroom.”

There seems to be some evidence that *mbeng* and the following phrase form a constituent since the latter can be raised to front initial position under clefting (or focus movement):

(138)

a. Mbioro a- dǐngá - m mbeng okutu wáá

Mbioro SM love Inc. only woman *his

“Mbioro loves only his wife”

b. Mbeng okutu wáá ódzú Mbioro a. dǐngá - m

only woman his FOC Mbioro SM loves Inc.

“It is only his wife that Mbioro loves”

But the same constituent is unable to undergo topicalization:

(139)

*Mbeng okutu wáá, Mbioro a- dǐngá- m

Only woman his Mbioro SM loves Inc.

Both the clefting and topicalization possibilities are open to a programmatic adverb like *bebere* ‘frankly’ and the following phrase:

(140)

a. bébére wandá máte, Iduwa a- ma- gwana agee

frankly thing this iduwa SM p2 chase wife

“Frankly for this reason, Iduwa sent away his wife”

b. bébére wandá máte owu Iduwa a- má- gwăna agee

frankly thing this FOC Iduwa SM p2 chase wife

“It is frankly for this reason that Iduwa sent away his wife”

c. I- mu na ngángú owu Isomo Adzu á- ma- sera mátuwa wáá

SM is with luck FOC Isomo Relativizer SM p2 sell car his

“It is luckily Isomo who sold his car”

In the last sentence (137 c), the evaluative adverbial PP *ngangu* ‘‘luckily’’ has been focalized.

More evidence that the so called focusing adverbs like *mbeng* form a constituent with the phrase following it (them) is provided by the following sentence in which the adverbs *fɛ* ‘‘again’’ intervenes between a verbs and a (light) object:

(141)

Mbotséré a- má - nya fɛ vabiya Vátátu

Mbotsere SM p2 drink again beers three

‘‘Mbotsere drank again three beers’’

The behavior of adverbs like *mbeng* in this subsection constitutes what Cinque (1999) calls an ‘‘instance of a ‘‘focusing’’ usage of the adverb’’. Cinque, basing his reasoning on Kayne’s (1994) ban on adjunction to a maximal projection, suggests that ‘‘focusing’’ adverbs be treated as heads taking their modifiers as complements (cf. Bayer 1996) since the ‘‘focusing’’ adverbs immediately precedes the phrase in focus. For illustration of the implementation of the above idea, consider the following examples:

(142)

a. Mbeng Onana odzu a- mú- kúsa itutu

only Onana FOC SM p2 buy motorcycle

‘‘it is only Onana who bought a motorcycle’’

b. Onana mbeng odzu a- má- kúsa Itutu

Onana only FOC SM p2 buy Motorcycle

‘‘it is only Onana who bought a motorcycle’’

(143)

a. Too Onana a- má- fowá yěndze

Even Onana SM p2 build house

‘‘Even Onana built a house’’

b. Onana tunu a- má - fowá yěndze

Onana too SM P2 build house

“Onana too built a house”

In the above two paradigms, the complements of *mbeng* ‘‘only’’ and *tunu* ‘‘too, also’’ raise to the Spec, across the heads occupied by the adverbs. The technical implementation of this idea phrase structure wise still needs to be worked out, though.

However, there is another adverb *muka* ‘‘only’’ that does not behave like *mbeng*:

(144)

a. *Muka Onana odzy a- má- kúsa itutu

only Onana FOC SM p2 buy motorcycle

b. Onana muka adzu a- má- kúsa Itutu

Onana only FOC SM p2 buy Motorcycle

“Onana only bought a motorcycle”

Cinque (1999) observes that, in Italian and English, ‘‘when they do not immediately precede the phrase in focus (e.g I only invited MARY), ‘‘focusing’’ adverbs appear not to behave as heads. Bayer’s (1996) discussion seems to corroborate this viewpoint.

Related to the above discussion is the fact that unexpectedly « higher » (sentence) AdvPs can occur after lower AdvPs in the following sentences because they exhibit a ‘‘focusing’’ usage:

(145)

a. Mbara a - má -nyá fe kóó bukí vabiya vatatu

Mbara SM P2 drink again without friling beers three

“Mbara drank certainly again three beers”

b. Mbárá a nobá - m tama ngima

Mbara SM Beat Inc. Time all

agee yóngǒsi na wuyo ikori

wife perhaps in front jealousy

“Mbara always beats his wife perhaps out of jealousy”

Fε « again » can be used too in a focalized manner :

(146) Mbára a - nu -ferem- en - a - m(fε) Puta ra Purasi (fε)agendo aba

Mbara Sm fl visit APPL FV Inc. Again Puta in Paris (again) times two

“Mbara will visit (again) Puta in Paris (again) twice”

Finally, “higher” (sentence) adverbs like *yongosi* “perhaps”, *bebere* “frankly” can show up after “lower” AdvPs if the latter are parentheticalized by “comma intonation”:

(147) Nu ngu - nũ - sosom ée pro kúsa

I SM F1 seek that buy

wanda wima, yongosi, na wuco owu ee kirisimes a- fuma

thing all perhaps in front of that Christmas SM arrives

“I will seek to buy everything, perhaps, before christmas time”

5. Conclusion

This chapter has thoroughly described and analyzed the behavior of AdvPs in Tuki, a Bantu language of Cameroon. More Precisely, It has determined the position(s) they occupy in the clausal structure and the overall order in which they occur. The order of lower AdvPs in Tuki is the following:

(148)

Muka > tama ngima > wanda wima > pε > ifundu > wusi

“only” “always” “everything” “completely” “much” “well”

Speech time adverbs, domain adverbs and adverbs of setting can move freely within the sentence. Consequently, they are not taken into account in the following hierarchy of higher adverb classes:

(149)

Bebere > na visangena > koo buki > tete odzu > yongosi > na peyo

“frankly” “happily” “certainly” “now” “perhaps” “intelligently”

An ordered sequence of higher (sentence) adverbs precedes an ordered sequence of lower adverbs that occur at the end of the VP bearing nuclear or focus stress. Moreover, Tuki lower adverbs cannot normally dominate VP, unless they are parentheticalized. In addition, while the linear order of “higher”

(sentence) adverbs in Tuki corresponds to Cinque's hierarchy, the one for "lower" adverbs is a little bit different.

As far as adverb movement is concerned, Tuki patterns with Dutch, French and Italian (Rizzi 2004; Koster 1978; Schlyter 1974):

- a non-focal adverb cannot be raised to the front initial position of a clause over an intervening adverb;
- an adverb can be preposed if it is focused;
- adverb preposing and preposing to a focus position are impossible over negation;
- adverb preposing over an intervening adverb or negation is possible when the adverb is mentioned in the immediately preceding discourse context. (Preposed) adverbs substitute for the specifier position of a Mod(ifier) P(hrase). The latter in Tuki can occur in the following positions: between IntP and TopP; between FP and FinP or in the post-complement position inside VP.

Circumstantial adverbials, as opposed to the other AdvPs, are not rigidly ordered with respect to each other. And they are realized either in prepositional form or in bare NP form. Semantically, they seem to behave as "modifiers predicated of an underlying event variable" (Cinque 1999). Syntactically, they are shown to occupy the Spec position of VP.

Finally, the paper examines focusing and parenthetical uses of AdvPs. Certain Tuki adverbs like *mbeng* "only" and *too* "even" can directly modify different types of constituents (and even clauses). Following Cinque (1999), it is argued that adverbs like *mbeng* "only" and *tunu* "too, also" should be treated like heads that take their modifies as complements (cf. Bayer 1996). The complements of *mbeng* and *tunu* raise to the Spec, across the heads occupied by the adverbs. But the question is : what is the maximal projection that hosts these elements? It could be Rizzi's Mod(ifier) P(hrase). The specifier position of the latter maximal projection can accommodate either AdvPs (or adverbs) or constituents that are focalized by moving to a phrase the head of which contains a focusing adverb.

CHAPTER SIX

Null Subjects, Identification and Proper Government

6.0. Introduction

Before we turn to the analysis of arguments and adjuncts in Tuki operator construction, we would like to examine the theoretical status of the empty categories that occur freely in subject position in this language. The status of null subjects in Tuki clauses is very important since null subjects apparently bear on the conditions of the LF extraction of *wh*-subject. Thus this chapter will have a considerable impact on the outcome of the next chapter. Universal Grammar is considered as a parametrized system in which core grammar is through a finite number of parameters. One of these is the so-called null subject or *pro*-drop parameter. Work by Jaeggli (1982), Rizzi (1982), and others has revealed that some features tend to cluster together and consistently with the null parameter. Tuki allows thematic null pronominal subjects:

- | | |
|----------------------|-----------------------|
| (1) a. Mbara a- nyam | b. <i>pro</i> a- nyam |
| Mbara SM eat | “he/she” SM eat |
| “Mbara eats” | “Mbara eats” |

Standard work in the field has suggested that inflectional system of *pro*-drop languages is rich enough to license the occurrence of null subject subjects (Chomsky 1982). Though the notion of inflectional richness may account for Chinese and Japanese which show no number person agreement (Huang 1982):

- | | |
|------------|--------------------|
| (2) Xihuan | “like” |
| (3) | |
| Yom-ru | “read-present” |
| Yom-ta | “read-past” |
| Yom-anai | “read-neg” |
| Yom-eba | “read-conditional” |
| Yom-oo | “read-imperative” |
| Yom-itai | “read-volitional” |
| Yom-are | “read-passive” |
| Yom-ase | “ read-causative” |

Following Jaeggli & Safir (1987), we argue that the licensing condition accounting for the lack of thematic null subjects is not rich agreement, but rather “morphological uniformity”:

(4)

Null subjects are permitted in all and only those languages which have morphological uniform inflectional paradigms.

(5) An inflectional paradigm P for a category K in a language L is morphologically uniform iff L has either only underived inflectional K-forms or only derived inflectional K-forms. Thus a language will allow null subjects if its verbal paradigm exhibits either *stem+affix* only. The Tuki inflectional paradigm is consistently *stem+affix*:

(6) o- + báng +a \longrightarrow obánga
 Inf. Stem+ Final Vowel “to cry”

Present

m	-báng-á-m	“I cry”	1.S
o	-báng-á-m	“you cry”	2.S
a	-báng-á-m	“ he/she cries”	3.S
tu	-báng-á-m	“we cry”	1.PL
nu	-báng-á-m	“you cry”	2.PL
va	-báng-á-m	“they cry”	3.PL

Our system needs a mechanism by which the content of a null pronoun can be recovered. The referential value of a null pronominal is identified in Tuki by an agreement prefix that case-governs the empty subject position:

(7) a. John a- watam b. Pro a- watam
 John Agr- cultivates pro Agr- cultivates
 “John cultivates” “he/she cultivates”

The identification condition is stated as follows:

(8) AGR can identify an empty category as (thematic) pro iff the category containing AGR case-governs the empty category. In this chapter we will provide evidence that the answer to the pro-drop dilemma is morphological uniformity in inflectional paradigms. This chapter is organized as follows: In section 1, the structure and the nature of INFL in the language are determined. Section 2 examines a recent proposal by Jaeggli & Safir (1989), which aims at eliminating the labels null subject or pro-drop, with respect to Tuki.

6.1. INFL

Before we delve into the analysis of INFL in Tuki, let us briefly outline the structure of the Tuki verb.

6.1.1. Verb Structure

Let us consider the following sentence:

(9) a. Onomutu waa a- ma- mu- bang-ey- a na tsawu
 husband her SM P2 OM cry Caus FV with whip
 “Her husband caused her”

In (9a) above, the verb is *AMAMUBANGEYA*. It undoubtedly forms a complex morphological item, made up of the following constituents: the subject marker (SM) *a-*; the tense marker *ma-*; the object marker (OM) *mu-*; the verb stem *bang-*; the causative morpheme *ey-*; and the final vowel (FV) *a-*. So, the verb stem in (9a) has the following linear structure:

(9) b. [SM-Tense-[OM-[[Verb stem]₁-Caus]₂]₃ Final vowel]₄

Bear in mind that the spot occupied by Caus- is reserved for any extension morpheme. So we might as well say that the second cycle in (9b) can contain any extension morpheme(s). The deepest cycle contains the verb stem, and attached to it from left to right are the subject marker, the tense marker, the object marker, and the final vowel. Where would the negation marker fit in this picture?

(10) a. Bob a- ta- ma- mu- bang-ey- a

Bob SM Neg P2 OM cry Caus FV

“Bob didn’t cause him/her to cry”

b. Bob a- ta- bang- ey- a Mary

Bob SM Neg- cry Caus FV Mary

“Bob didn’t cause Mary to cry”

The negation morpheme in Tuki always occurs before the verb stem. Tense and the object marker may occur between the negation marker and the verb stem (10a).

6.1.2. INFL

Chomsky (1981) indicates that the INFL node may be a collection of the features [+Tense, (AGR)]. If INFL is [+Tense], it will contain AGR, a node underlying subject verb agreement, consisting of the features person, gender and number. Let us consider the following paradigm:

- | | |
|-------------------------|-------------|
| (11) a. +tense, +person | finite |
| b. –tense, +person | subjunctive |
| c. +tense, -person | participle |
| d. –tense, -person | infinitive |

(11a, b, and d) seem to be attested in Tuki. Finite verbs independently select categories of tense/aspect:

(120) a. Mbára a- dingá- m vakutu

Mbara SM loves incomplete aspect women

“Mbara loves women”

b. Mbárá a- má- dingá vakutu

Mbara SM P2 love women

“Mbara loved women”

c. Mbárá a- bungána-m éé Putá a- nyá-m cwí

Mbara SM thinks Inc. that Puta SM eats Inc. fish

“Mbara thinks that Puta eats fish”

Verbs in the subjunctive form do not select tense/aspect but nevertheless show full obligatory agreement with the subject. Subject verbs will appear only in embedded contexts, where the infinitive is used in English:

(13) Putá a- dingám éé a- nyá ngo

Puta SM loves that SM eat chicken

“Children wants to eat chicken”

(11c) seems to be non-existent in Tuki. Recall that in the language, any [+tense] construction shows full obligatory agreement with the subject. Participles generally show no agreement with the subject. Consequently, the case cannot be attested in the language. Tuki, however, contains the combination of features exhibited in (11d).

(14) o- dingá mabó i- mu tsemé

Inf. love wine SM is sin

“To love wine is a sin”

The presence of the subject marker is obligatory in finite constructions. The SM agrees in noun with the subject. We might as well call the subject marker “AGR”. The object marker may occur only in tensed clauses. Object markers, which can refer only to humans, may be considered as clitics.

(15) a. Mbárá a-girám Putá

Mbara SM waits Puta

“Puta waits for Puta”

b. Mbárá a- mu-girám

Mbara SM OM waits

“ Mbara waits for her”

We can now propose the structure of the [+tense] INFL as embedded in the tree-diagram of

(16a).

(17)

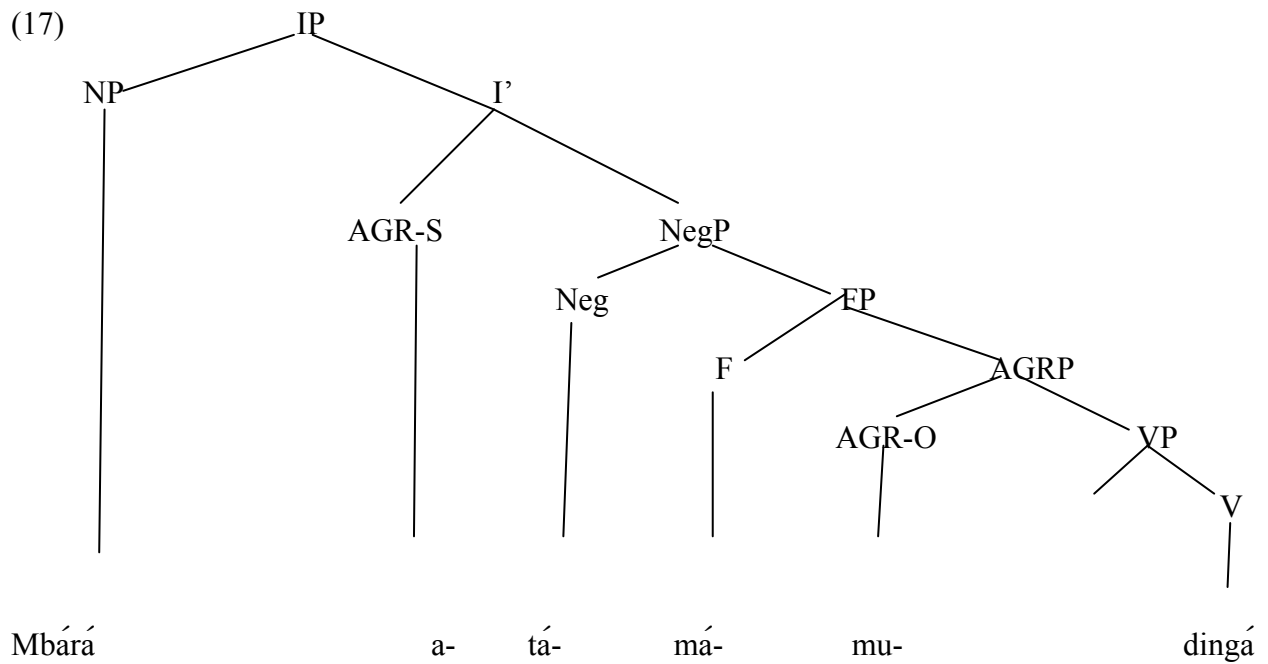

6.1.3. Well-formedness of a zero subject

In Tuki, the subject of a tensed sentence may remain unexpressed.

(18) a. Mbárá a- bangám

Mbara SM cry

“Mbara cries”

a'. pro a- bangám

pro SM cry

“He/She cries”

b. vǎdzu vá- bangám

children SM cry

“Children cry”

b'. pro va-bangam

pro SM cry

“They cry”

But what evidence, do we have, that allows us to assess that empty subject positions exist in Tuki. Can an empty subject position in Tuki act as an antecedent for the Binding Conditions of (Chomsky 1981)?

(19) *Binding Conditions*

A) An anaphor is bound in its governing category

B) A pronoun is free in its governing category

C) A name is free

(20) a. Mbárá a- dingam omwate

Mbara SM loves himself

“Mbara_i loves himself_i”

b. * Mbárá a- dingam Mbárá

Mbara SM loves Mbara

“Mbara_i loves Mbara_i”

c. * Mbárá a- mu- dingám

Mbara SM OM loves

“Mbara_i loves him_i”

(21) a. Mbárá_i a- b(e) éé Putá a- má- éna omwéne_i

Mbara SM says that Puta SM P2 see him

“Mbara_i says that Puta saw him_i”

b. *Mbárá_i a- b(e) éé Putá a- má- éna omwámáte_i

Mbara_i SM says that Puta SM P2 see himself_i

“*Mbara_i says that Puta saw himself_i”

c. * Mbárá_i a- b(e) éé Putá a- má- éna Mbara_i

Mbara SM says that Puta SM P2 see Mbara_i

“Mbara_i says that Puta saw Mbara_i”

In (20a), the coreferent interpretation is allowed between *Mbara* and *omwamate* “himself”. (20b) is excluded by principle C. (20c) is disqualified by Principle B. (21a) is licit because Principle B is respected, while (21b, c) are outlawed respectively by Principles A and C. Now, we have to ask the question whether the same pattern holds for Tuki when the subject is non-overt.

(22) a. [e]_i a- dingam omwene_i

SM loves him-/herself

“He_i/She_i loves him-/herself_i”

b. *[e]_i a- b(e) éé Putá a- má- éna omwámáte_i

*He/She SM says that Puta SM P2 see himself_i

c. [e]_i a- b(e) éé Putá a- má- éna omwéne_i

He/She SM says that Puta SM P2 see him/her_i

“He_i/She_i says that Puta saw him_i/her_i”

d. *. [e]_i a- b(e) éé Putá a- má- éna John_i

He/She SM says that Puta SM P2 see John_i

“He_i/She_i says that Puta saw John_i”

(22) clearly illustrates that in Tuki a gap can act as an antecedent for the Chomskyan Binding Conditions (19). We can use the same line of argumentation to determine the existence of an empty category subject in infinitive contexts in Tuki:

(23) a. Mbárá_i a- dingám [CP [IP PRO_i wono omwámáte_i]]

Mbara SM loves to laugh himself

“Mbara likes to laugh at himself”

b. *Mbárá_i a- dingám [CP [IP PRO_i o- wono omwéne_i]]

Mbara SM loves to Inf .laugh him

“* Mbara_i likes [CP [IP PRO_i to laugh at him_i]]”

c. *Mbárá_i a- dingám [CP [IP PRO_i o- wono Mbárá_i]]

Mbara SM loves to Inf .laugh Mbárá_i

“* Mbara_i likes [CP [IP PRO_i to laugh at Mbárá_i]]

(24) Mbara_i a- t- uba wusi [CP[IP PRO_i wudza ee Puta a-benam omwamate_i/omwene_i-/Mbara_i]]

Mbara SM Neg hear well tell that Puta SM hates himself/him/Mbara

“ Mbara does not feel fine telling that Puta hates*himself/him/*Mbara”

(23) and (24) explicitly show that the empty category subject in infinitive contexts patterns like the empty category subject in tensed contexts with regard to Binding Theory. The empty category subject encountered in tensed clauses is generally called *pro*, whereas the empty subject of infinitives is called *PRO* (for the most standard assumption on this matter see Chomsky (1982)). Rizzi (1982) has shown that *pro* can be interpreted as free or specific, but *PRO* may never have that interpretation except when it is controlled by some other NP. Thus, in the following sentence:

(25) It is easy [CP [IP PRO to win]]

PRO is only interpreted as “arbitrary person or persons”. Although M. Suner (1983) claims that *pro* can be interpreted as arbitrary, Jaeggli (1986) discusses clear-cut differences between *PRO* and *Pro*. Jaeggli and Safir (1989) illustrate three sorts of diagnostics that may be used to determine whether a null subject is *PRO* or *Pro*. We want to test some of these ideas against the Tuki empirical material.

6.1.3.1. The Resumption Test

PRO may not be a resumptive pronoun unless there is another bindee; *pro* can be a resumptive pronoun.

(26) *[Mángádzu ódzu] [CP ódzu [IP Mbárá a- t-ídzima [CP ngi [IP imu sésé[CP[IP PRO o-
 Child this who Mbárá SM Neg knows if is easy PRO Inf.
 tófa n(a) osá]]]]]]]]

wash in river

“*This is the child who Mbara does not know whether it was possible PRO to swim in the river”

(27) Mángádzu ódzu] [CP ódzu [IP Mbárá a- t-ídzima [CP ngi [IP Putá a- yanám o-mu băna]]]]
 child this who Mbárá SM Neg know whether Puta SM must him marry

“This is the child who Mbara does not know whether Puta must marry”

(26) above illustrates the inability of PRO to act as a resumptive pronoun. (27) shows that in Tuki an overt pronoun can serve as a resumptive pronoun. Can *pro* act as a resumptive pronoun in Tuki?

(28) [NP mutu ódzu] [CP odzu_i [IP Putá ídzimám [CP vatu vaní[IP va-tá- dínɡa okutu[CPodzu
 man this who Puta knows men how many SM Neg like woman who [IP [e]_i a-
 banám]]]]]]]]

SM marries

“This is the man whom Puta knows how many men do not like the woman who marries”

Notice that in (28), the operator *odzu* “who” has crossed two CPs; the fact that the sentence is grammatical implies that *odzu* may not have been extracted by wh-movement. So the subject gap coindexed with *odzu* “who” is probably an empty category functioning as a resumptive. Bear in mind that Tuki lacks overtly realized subject pronouns. So when the language appeals to the resumptive strategy, it uses *pro* as a resumptive pronoun in subject. The resumptive result, here, is that *PRO* as opposed to *pro*, cannot function as a resumptive pronoun in Tuki as evidenced by the illicitness of (26) above. Jaeggli (1982:138, 173, fn.9) has pointed out the same kind of contrast between *PRO* and *pro*: in a left dislocation construction, *PRO* may not act as a resumptive pronoun. The ungrammaticality of (29) clearly illustrates the point:

(29) *Mbará_i, i-yakanám [CP [IP PRO_i o- fuma na tama]]

Mbara SM difficult Inf. arrive in time

“ Mbara_i, it is difficult PRO_i to arrive on time”

Pro can function as a resumptive pronoun in a left-dislocation construction in Tuki:

(30) Mbara_i, i-yakanam [CP ee[IP pro_i a- fuma na tama]]

Mbara SM difficult that SM arrive in time

“ (A for)\Mbara_i ,it is difficult that he_i arrive on time”

Thus, we have established that the empty category in subject position of Tuki tensed clauses (pro) can function as a resumptive pronoun in syntactic islands, whereas *PRO*(the infinitive null subject) cannot function as a resumptive pronoun. So the resumption test makes a clear distinction between *pro* and *PRO* in Tuki.

6.1.3.2. The Emex Condition

It is well known that virtually every language that allows null thematic subjects also allows null expletive subjects, though the reverse implication is not valid (cf. Safir(1985a, b) and Travis (1984)). If indeed Tuki is a null subject language, we should expect it to have null expletive subjects . The prediction is borne out.

(31) a. pro a mu- údza éé pro a- m(u)- umbana cwí

SM P1 say that SM P1 catch fish

“He/She said that he/she caught fish”

b. . pro a mu- údza éé pro i-fwánenám éé pro a- m(u)- úna nama

SM P1 say that SM appears that SM P1 kill fish

“He/she said that it seems that he/she killed an animal”

PRO, in any language, cannot an expletive. Thus in Tuki, an expletive cannot be the null subject of an infinitive.

(32) *pro i- mu sese o- mu dere ee Puta a- nom

SM is easy Inf. him pray that Puta SM sick

“*It is easy to please him that Puta is sick”

To account for the ungrammaticality of sentences such as (32), Safir (1985a, b) devised a condition stipulating that empty expletive elements be governed:

(33) *The Emex Condition*

An empty category expletive must be governed.

Due to the *PRO* theorem, *PRO* cannot survive in a governed position. Thus, the Emex Condition enables us to draw the line between *PRO* and *pro* in Tuki. Summarizing, we have shown above that *pro* as opposed to *PRO* can be a resumptive pronoun, an expletive in Tuki; last, not least, *pro* unlike *PRO* may occur in governed position. In any case, we have established that the empty category that appears in subject position in Tuki tensed clauses is *pro*.

6.1.3.3. AGR and Proper Government

In languages allowing the phenomenon of null subjects (for example, Greek, Hebrew, Italian and Spanish) the pronominal subject of a tensed sentence may be phonologically empty. In Tuki, contrary to what is claimed in Biloa (1991), there are pronominal subjects in the sense usually understood for the languages mentioned above:

(34)	Italian	
a.	io parlo	“I talk\”
	tu parli	“you talk”
	lui parla	“he talks”
	noi parliamo	“we talk”
	voi parlate	“you talk”
	loro parlano	“they talk”
b.	parlo	(1 st pers.sg.)
	parli	(2 nd pers.sg.)
	parla	(3 rd pers.sg)
	parliamo	(1 st pers.pl)
	parlate	(2 nd pers.pl)
	parlano	(3 rd pers. Pl)

(35)	Tuki: infinitive o-nyám “to eat” (Simple Present tense)	
a.	nyám	“I eat” (1 st pers. Sg)
	o-nyám	“you eat” (2 nd pers. Sg)
	a-nyám	“he/she eats” (3 rd pers. Sg)
	tu-nyám	“we eat” (1 st pers. Pl)
	nu-nyám	“you nyam” (2 nd pers.pl)
	va nyám	“they eat” (3 rd pers. Pl)
b.	Nu nyam	
	mámú o-nyám	
	omwéne a-nyám	
	vítsu tu nyám	
	vínu nu nyám	
	vámwéne va-nyám	

It is well known that the verbal morphology appears to be rich enough to make the pronominal subjects in (34) recoverable semantically though phonologically empty. The paradigm exhibited in (35b) shows that Tuki does not *have* subject pronouns à la Italian. The language has strong pronouns: *o, a, tu, nu, va*, are subject markers agreeing in noun class with the nominal subject. They therefore constitute AGR-S. (35b) shows that their presence is compulsory, for, when omitted, the resulting forms are ruled out. Recall that we indicated in the previous section that all

verbal forms in Tuki (apart from the infinitive) must be marked for AGR, a node underlying subject verb agreement, consisting of the features person, gender and number.

AGR-S being the head of IP (as in Chomsky 1988), we will argue that it is precisely AGR-S which licenses null subjects in Tuki. For, if AGR-S were not a proper governor in Tuki, we would end up with an ECP violation. We thus conclude that in Tuki, AGR-S can properly govern the subject position. Notice that in this language, F does not have to be necessarily [+tense] since subjunctive verbal forms, though bearing the features [-tense, +person], allow null subjects.

(36) Mbára_i a- dingám éé [e]_i a-bána okutu

Mbara SM loves that SM marry woman

“Mbara wants to marry a woman”

The embedded verb in (36) *abana* is in the subjunctive form. But it still licenses a c-commanding empty category position. It has been suggested by Riemsdijk and Williams (1986), following Chomsky (1981), that the agreement relation between AGR and the subject should be sanctioned by co-indexation:

(37) NP_i[INFL[+tns] AGR_i]INFL VP

(37) presupposes as argued above that the AGR features (gender, number, and person) agreeing with the subject NP are realized on the verb. Tuki, like many Bantu languages, constitutes evidence that (37) is valid. Let us consider (38) and (39) below:

(38) a. mutu a-nyám mbása

Cl.1man SM eats corn

“The/a man eats corn”

b. mbwíi i-nyám mbása

Cl.10 sheep SM eat corn

“A sheep eats corn”

(39) a.* mutu i-nyám mbása

b. *mbwíi a-nyám mbása

In (38), the subject markers *a-* and *i-* which represent AGR-S agree in noun class with the NPs *mutu* “man” and *mbwíi* “sheep” respectively. Any random assignment of subject markers to inappropriate NPs will automatically result in ungrammaticality (cf. (39)). In case the two NPs *mutu* “man” and *mbwíi* “sheep” are not available in the sentence, but they are semantically recoverable in discourse, we will have well-formed empty categories in subject position:

(40) a. [e]_i a_i nyám mbása

SM eats corn

“He/she eats corn”

b. [e]_i i_i- nyám mbása

SM eats corn

“It eats corn”

We may then assume, with Riemsdijk and Williams, that either AGR_i c-commands NP_i (cf. (37)) and hence can govern it, or that INFL “inherits” the subscript from AGR_i and acts as a proper governor whenever NP_i is not phonologically present. We have already adopted the assumption that in Tuki AGR-S properly governs the subject position, thereby licensing the occurrence of null subjects without any ECP violation.

6.2. Morphological Uniformity and Identification

We have assumed in this chapter, following standard work in the field, that the inflectional system of pro-drop languages is rich enough to license the occurrence of null subjects. But because the notion of inflectional richness is difficult to characterize, linguists have ended up with more questions than answers. Among the many proposals that have been suggested for the resolution of the prop-drop dilemma, Jaeggli (1980, 1982) and Chomsky (1981) have indicated that null subjects are licensed in some languages by case and the absence of government. On the other hand, the content of the empty category in subject position must in some sense be recovered through an identification process which requires agreement with the features (person, number and gender) in INFL. Rizzi (1982, 1986) has argued that null subjects are licensed through government of some X^0 categories, whereas identification is done via binding. It was also proposed by Safir (1985) that identification could be determined by the presence or absence of a subject clitic, while licensing could require what he termed the NOM-drop Parameter (assignment or non-assignment of nominative case). Jaeggli and Safir (1989) offer a different treatment of the notions of licensing and identification. But first of all, they show that is not rich agreement that licenses the presence or absence of empty categories in subject position. It is well known that in languages like Italian and Spanish, more often than not, in a given tense, the inflectional paradigm distinguishes all six persons uniquely. Let us consider the following German paradigm (from Jaeggli and Safir 1987):

(41) (Ich) arbeit-e	“ I work”	1.s
(du) arbeit-est	“you work”	2.s
(er) arbeit-et	“he work”	3.s
(wir) arbeit-en	“we work”	1.pl
(ihr) arbeit-et	“you work”	2.pl
(Sie) arbeit-en	“they work”	3.pl

The verb above is inflected for person, number, tense and mood. Notice the 3s. and the 2pl. are identical. German does not allow thematic null subjects, but it allows null expletive subjects. We might be tempted to ascribe the absence of thematic null subjects to the fact that not all forms in the inflectional paradigm of German are distinct (as in Spanish or Italian). Jaeggli and Safir rightly point

out that the same situation obtains in Irish (two or more forms are identical), but Irish allows obligatory thematic null subjects when the verb is synthetic:

(42) cuir-im “I put” 1s. cuir-eann “you(sg.)/he/she/we/you(pl.)/they put”

Jaeggli & Safir (1989) conclude from these and other facts that any simple definition of inflectional “richness” is illusory. Japanese and Chinese shows no number-person agreement. Japanese verbal paradigms inflect for tense/mood/aspect and negation, but there is no person or number agreement. As for Chinese, it has no agreement.

(43) yom-ru “read-present”
 yom-ta “read-past”
 yom-anai “read-neg”
 yom-eba “read-conditional”
 yom-oo “read-imperative”
 yom-itai “read-volitional”
 yom-are “read-passive”
 yom-ase “read-causative”

(44) xihuan “like”

Jaeggli & Safir conclude that the licensing condition accounting for the lack of thematic null subjects is not rich agreement, but rather “morphological uniformity”. Their formulation of the licensing condition is stated in (45), while the definition of morphological uniformity is provided in (46).

(45) Null subjects are permitted in all and only those languages which have morphological uniform inflectional paradigms.

(46) *Morphological Uniformity:*

An inflectional paradigm P for a category K in a language L is morphologically uniform iff L has either only underived inflectional K-forms or only derived inflectional K-forms.

6.2.1. Morphological Uniformity in Tuki

In simpler terms, a language is morphologically uniform if its verbal paradigm exhibits either *stem+affix* or *stem* only. It is not morphologically uniform if it is mixed, that is if it exhibits *stem+affix* and *stem*. Given this definition, let us see whether Tuki is a morphologically uniform language.

(47) a. o- +banga \longrightarrow obanga “to cry”
 Infinitive marker stem

Present tense

m- banga-m “I cry” 1s.

o- bangá-m	“you cry”	2s.
a-bangá-m	“he/she cry”	3s.
tu-bangá-m	“we cry”	1pl.
nu-bangá-m	“you cry”	2pl.
va-bangá-m	“they cry”	3pl.

Past tense

nga-ma- bangá	“I cried”	1s.
o-ma- bangá	“you cried”	2s.
a-ma-bangá	“he/she cried”	3s.
tu-ma-bangá	“we cried”	1pl.
nu-ma-bangá	“you cried”	2pl.
va-ma-bangá	“they cried”	3pl.

b. o- + udza → wudza “to tell”

Infinitive marker+ stem

Present tense

ng-údzá	“I tell”	1s.
w-údzá	“you tell”	2s.
o-údzá	“he/she tell”	3s.
t-údzá	“we tell”	1pl.
n-údzá	“you tell”	2pl.
v-údzá	“they tell”	3pl.

Past tense

nga+ ma+ údzá → ngamúdzá “I told”

SM Past marker stem

nga-m-údzá	“I told”	1s.
o-m-údzá	“you told”	2s.
a-m-údzá	“he/she told”	3s.

tu-m- údza	“we told”	1pl.
nu-m- údza	“you told”	2pl.
va-m- údza	“they told”	3pl.

The above paradigms are all the way morphologically uniform. Verbal forms have this structure: stem+affix. It is however, important to notice that (47) does not exhaust the complete inflectional paradigm of Tuki. It simply shows that the language is morphologically uniform, and therefore satisfies one of the conditions of null subjecthood.

6.2.2. Identification in Tuki

The system devised by Jaeggli and Safir needs a mechanism by which the referential value of a null pronoun can be recovered.

(48) A thematic null subject must be identified.

Jaeggli & Safir assume that agreement affixes with relevant @-features are identifiers in null subject languages. These agreement features arguably are contained by INFL and they govern the subject position. The identification condition is stated as follows:

(49) *Identification by Agreement*

AGR can identify an empty category as (thematic) *pro* iff the category containing AGR case-governs the empty category.

(49) predicts that in Tuki, (50b) allows *pro* in subject position since INFL (the category containing AGR) case-governs it.

(50) a. Mbárá a-watám

M. SM cultivates

“Mbara cultivates”

b. *pro* a-watám

SM cultivates

“She/he cultivates”

Since in Tuki, agreement affixes are compulsory in verbal constructions (apart from infinitives), we assume that *pro* in subject position will always be identified.

6.3. Concluding Remarks

In this chapter, we have covered the following facts: (i) Tuki allows thematic null subjects since INFL can properly govern an empty category in subject position. (ii) Tuki is a morphologically uniform language given that its inflectional paradigm consistently displays structures of this form: stem+affix. Moreover, the Identification Condition proposed by Jaeggli & Safir (1987), which works perfectly with

regard to Tuki, subsume the idea that AGR-S properly governs a phonologically empty element in subject position in the language. How does Tuki shed new light on the topic discussed in this chapter? We have presented brand new facts pointing to the conclusion that morphological uniformity in inflectional paradigms is the cornerstone of the pro-drop property. This chapter thus provides new empirical evidence for Jaeggli and Safir's (1987) approach to the proper characterization of the null subject parameter.

Appendix I: Free Inversion in Tuki

In null subject languages, one generally finds the following cluster of properties:

- (i) Missing subject
EC van nyám kuru
SM eat rat
“they eat rat”
- (ii) Free inversion in simple sentences
Not available in Tuki
- (iii) “Long wh-movement” of subject
Okutu odzu_i ti- dzíma ni EC_i a- ma- byana ambasa
woman who Neg know when SM P2 give birth twins
“The woman who I do not know when she gave birth to twins”
- (iv) Empty resumptive pronoun in embedded clause
mbwá adzé_i tí- dzíma ándzu a- m- údza éé EC_i i- má numa mángádzu
dog which Neg know who SM P1 tell that SM P2 bite child
“The dog which I do not know who said that it bit a child”
- (v) Apparent violation of the *[that-t] filter
andzu_i Mbara a- bunganam ee EC_i a- n(u) -ram
who Mbara SM think that SM F1 come
“Who does Mbara think that will come?”

Tuki conspicuously lacks property (ii). Free inversion is not available in the language:

- (1) a. Mbara a- ma- no
M. SM P2 sick
“Mbara was sick”
b. *EC_i a- ma- no Mbara_i
SM P2 sick Mbara
“Mbara was sick”

French exhibits what has come to be known as stylistic inversion (Kayne & Pollock 1972):

- (2) a. *EC_i est parti Jean_i

Jean has left

b. Je ne sais pas quand EC_i est parti Jean_i

“I do not know when Jean left”

Stylistic inversion is not possible in Tuki either:

(3) *Tí- dzíma ni EC_i a-m- énda Mbára_i
Neg know when SM P1 go Mbara
“I do not know when Mbara left”

In French, subjunctive triggers stylistic inversion too; this option is non-existent in Tuki.

(4) a. Je doute que EC_i soit arrêté Jean_i
‘I doubt that Jean be arrested’
b. *Petanam ee EC_i a- dzii kumbane Mbára_i
“I doubt that Mbara be arrested”

It seems to be the case that post verbal subjects are not available in Tuki, though the phenomenon seems to be trivial in null subject and non-null subject languages alike:

(5) a. There is a man in the bathroom
b. Il est venu une belle femme
came a beautiful woman
“A beautiful woman came”

(6) a. mutu a-mu- na itófeno
man SM is in bathroom
“A man is in the bathroom”
b. osya okutu a- ma-ra
beautiful woman SM P2 come
“A beautiful woman came”

Work by Jaeggli (1982), Rizzi (1982) on Spanish and Italian has shown that three features generally show up in pro-drop languages:

(7) a. Phonologically null subject pronouns
b. Free inversion
c. No COMP-trace effects

It appears that (7a) is separate. (7b-c) do cluster, that is (7b) generally implies (7c). But (7c) does not necessarily imply (7b): Tuki is a case in point. The language exhibits no COMP-trace phenomena, but lacks free subject inversion.

Appendix II: On Nominative Case Assignment in Tuki

It has been argued that structures like (5a-c) above seem to require a “transmission convention”

(1) In the structure ...dummy_i...NP_i...

Where NP_i is co-indexed with and in the domain of dummy_i, copy the case of dummy_i on NP_i (Rizzi; 1982). The above convention seems to be inoperative in Tuki. This brings us to the question of how Nominative Case is assigned in Tuki. Koopman (1984) has indicated that nominative Case is assigned in the following configuration:

(2) NP is nominative if governed by and adjacent to [INFL^V]

(2) explains why sentences like those exhibited in (3) below are disqualified:

(3) a. *a má-gwa Mbárá

SM P2 die Mbara

“Mbara died”

b. *i- nu- wanám inyínyi

SM F1 sing bird

“The bird will sing”

Though the NPs *Mbara* and *inyínyi* “bird” are governed by the verbs *-gwa* “die” and *-wana* “sing”, they are neither governed by INFL, nor adjacent to it. Consider below the tree-structures of the grammatical sentences *Mbárá a- má-gwa* “Mbara died” and *inyínyi i- nu- wanám* “the bird will sing”.

(4)a.

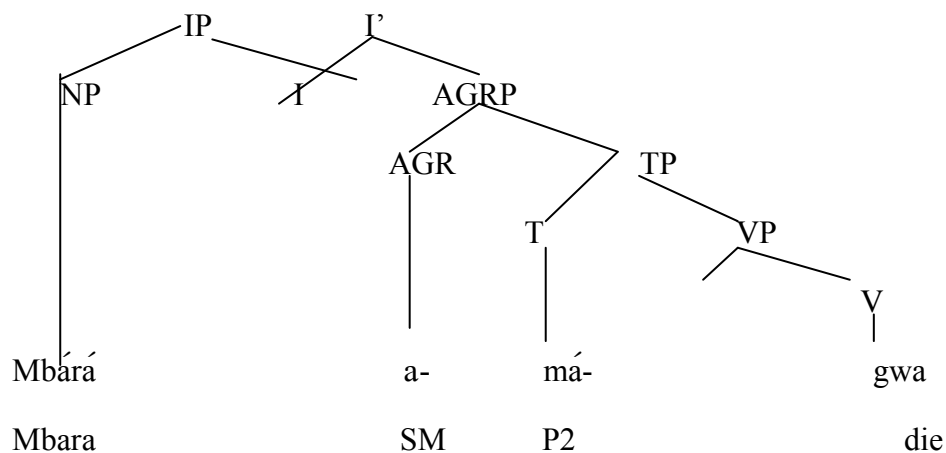

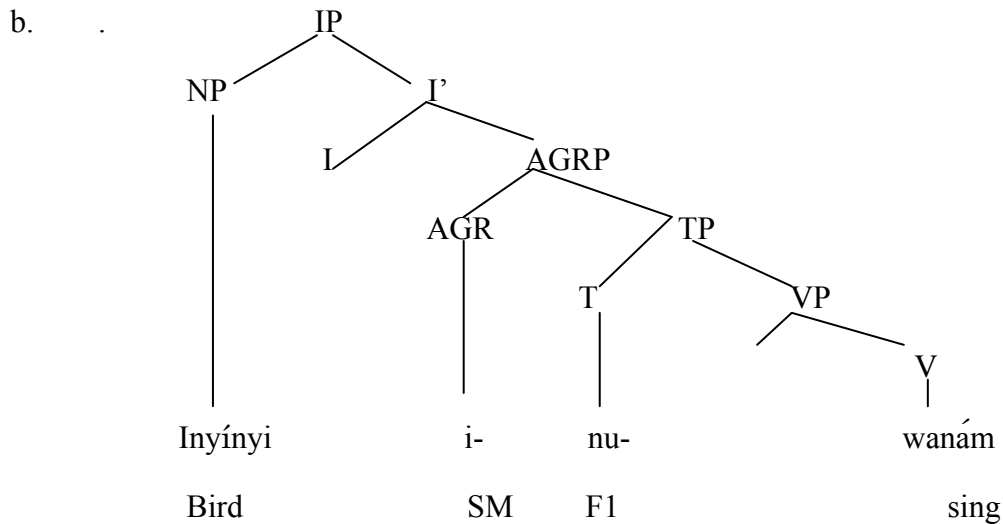

Notice that in (4a-b) above, the NPs *Mbárá* and *Inyínyi* “bird” are both governed and adjacent to INFL. The structures are therefore grammatical. Koopman’s formulation of nominative case assignment is different from Chomsky’s (1981):

(5) NP is nominative if governed by AGR.

(5) equally disqualifies (3a-b) and correctly predicts the grammaticality of (4a-b). As Koopman rightly points out, Chomsky’s configuration for nominative Case assignment is derived from languages in which AGR and Tense may be dissociated. For instance, the subjunctive in Tuki is tenseless, but it is obligatorily inflected for noun class (agreement with the subject).

(6) Putá a- dingám éé EC_i a-bwanda/(**bwandam*) nkúkúma

Putá SM loves that SM become chief

“Putá wants to become chief”

In Chomsky’s terminology, the embedded EC_i cannot be *PRO* since AGR, like Tense, is a governor. AGR being part of INFL, it is possible to argue that nominative case is assigned in Tuki by INFL. Koopman’s formulation for nominative Case assignment is valid for Tuki because it correctly predicts adjacency between the NP and INFL.

(7)a. **Mbárá isimi a- mu- nyá manyá*

M. quickly SM P1 eat food

“Mbara quickly ate the food”

b. *Mbárá a- mu- nyá manyá isimi*

M. SM P1 eat food quickly

“Mbara quickly ate the food”

(7) shows that a subject NP must necessarily be followed by INFL. Thus adjacency seems to be required between a nominative NP and INFL in Tuki.

Appendix III: On Expletive in Tuki

In this chapter, we have argued that Tuki was a null subject language since null subjects are both licensed and identified a la Jaeggli & Safir (1987). The morphological Uniformity approach predicts that expletive null subjects only need to meet the licensing condition. In other words, Identification is relevant for them. Therefore, licensing and Identification should be kept apart. Let us consider the following Tuki sentences:

(1)a. EC i- fwánenám éé Putá a- mu ongúbi

SM resembles that P. SM is thief

“It seems that Puta is a thief”

b. EC i- mu wedza owu o- tumám watu na wubi

SM is folly that SM send people to theft

“It is folly that sends people to theft”

c. EC i- saseyám Putá éé Mbárá a- mu-ba kata

SM annoys P. that M. SM P1 fail exam

“It annoys Puta that Mbara failed the exam”

Tuki seems to allow expletive null subjects, as evidenced by the sentence in (1). It is not the case that the subject has been postposed, since this option is disallowed in the language:

(2) *ee Putá a- mu óngúbi i- fwánenám

that Puta SM is thief SM resembles

Expletive null subjects are allowed above because they meet the requirement that null subjects be licensed only in languages that are morphologically uniform. Consider the inflectional paradigms of *o-fwanena* “to resemble” and *o-saseya* “to annoy”.

(3) a. o- + saseya \longrightarrow osaseya “to annoy”

Infinitive marker+stem

Present tense

nga-sáseyá-m	1s.	“I annoy”
o- sáseyá-m	2s.	“you annoy”
a- sáseyá-m	3s.	“he/she annoys”

tu- sáseyá-m	1pl.	“we annoy”
nu- sáseyá-m	2pl.	“you annoy”
va- sáseyá-m	3pl.	“they annoy”

b. 0- + fwanena → ofwanena “to resemble”

Infinitive marker +stem

Past tense

nga-pwanená	1s.	“I resemble” (f → p/#N—)
o-fwanená	2s.	“you resemble”
a- fwanená	3s.	“he/she resembles”

tu- fwanená	1pl.	“we resemble”
nu- fwanena	2pl.	“you resemble”
va- fwanená	3pl.	“they resemble”

The above paradigm is morphologically uniform, the licensing condition is met.

Weather verbs of the English type, with their expletives, are non-existent in Tuki:

(4)a . nubúra nu- suwám	b. mbábaraca i- bamám	c. ísina i-gitám
rain SM washes	thunder SM shouts	cold SM hits
“It rains”	“It is thundering”	“It is cold”

A particular lexical item is selected by weather verbs in Tuki, in place of an expletive as in other languages. In discourse, it is possible to have a null element in subject position of a weather verb, that is the referential value of the null subject can be recovered. But in Sentence Grammar, the following constructions are ungrammatical:

(5) a *EC nu- suwám	b. *EC i- bamám	c. *EC i-gitám
SM washes	SM shouts	SM hits
“It rains”	“It is thundering”	“It is cold”

The constructions in (5) are grammatical if the *rain*, *thunder* and *cold* have already been mentioned in discourse. Otherwise, they are disqualified.

NOTES

1. Ken Safir (1985) presents arguments that the properties we are alluding to are separate parameters.
2. In Tuki, a [-Tense]INFL still contains AGR as evidenced by the fact that subjunctive ([+person, -Tense]) verbal forms take a subject marker:

(i) Putá a- dingám éé énda (*endam) na ndzana
Putá SM love that go to forest
“Putá wants to go to the forest”

3. Marc Authier (personal communication) suggests that the subject marker (SM) in Tuki be considered as a pronominal subject clitic which doubles the subject as in a dialect of French described by Roberge (1987):

(i) Le cuisinier il est con “the cooker SM is stupid”

It may be suggested that subject markers in Tuki may be weak pronouns, in contrast to French and other languages which have strong pronouns.

4. Consider the following sentence:

(i) Mangádzu ódzu tsono adze EC a byám imu na viró
child who cloth that (he) SM wears is with dirt

(Lit: a child who the cloth that (he) is wearing is dirty)

The above construction is an illustration of Tuki relativization. If EC is produced by movement, then the above sentence should be ruled out by Bounding Theory. It therefore cannot be the case that EC is a trace of movement. We want then to say that EC is a resumptive pronoun even though it is not overt.

5. The same happens with subject clitics in the dialect of French mentioned in Roberge (1987):

(i) *Le jardinière elle est sortie
The gardener SM is out

This could be parallel to:

(ii) *[pro]_i a_i- nyám mbása
cl.10 SM eat corn

CHAPTER SEVEN

Null Objects and the pro-drop parameter

Introduction

Tuki allows empty categories in direct object position. The behavior of null objects in Tuki is far different from the behavior of syntactic traces which obey Bounding Theory. Null objects generally being of two types (pro or variable), it is plausible to suggest that in Tuki they are pro rather than variables.

In section 1, we determine the characteristics of Tuki null objects. In section 2, we provide arguments that null object constructions in Tuki are immune to Subjacency, thereby disqualifying any suggestion that they may be generated as syntactic variables resulting from the application of the rule Move Alpha. Constraints such as the Complex NP Constraint, the Sentential Subject Constraint, the Condition on Extraction Domain, the Doubly Filled COMP filter are systematically shown to be inoperative in Tuki object drop constructions. In section 3, we explore the possibility that null objects in Tuki sentences might be base-generated as pro. In section 4, we provide a unified account of subject pro and object pro. More specifically, we extend Jaeggli and Safir's (1989) analysis of the subject pro phenomenon to object pro. In section 5, we compare our analysis of Tuki object drop constructions to the studies of null object constructions in other languages.

7.1. Characteristics of Tuki null objects

Direct objects can be dropped in Tuki. However, the object drop phenomenon is subject to certain constraints in the language. For instance, a definite NP bearing the feature [+human] may be dropped only if an object marker (OM) occurs inside the verb:

(1)

- | | | | | | |
|----|------------------|----|-------|-----|-------|
| a. | Díma | a- | m(ú)- | éna | Mbárá |
| | Dima | SM | P1 | see | Mbara |
| | “Dima saw Mbara” | | | | |
| b. | Díma | a- | mú- | mú- | éna |
| | Dima | SM | P1 | OM | see |
| | “Dima saw him” | | | | |
| c. | * Díma | a- | m(u)- | éna | |
| | Dima | SM | P1 | see | |
| | “Dima saw” | | | | |

The verb *wéna* “to see” must be followed by a direct object NP above in order to meet the requirement of the Projection Principle (Chomsky (1981)). In (1a), *Mbara* is the internal argument of the predicate *a- m(ú)- éna* “saw”. In (1b), the object marker (OM) *mú* standing for *Mbárá* is the direct object of the verb; so the Projection Principle is satisfied in this case too. (1c) is ruled out, apparently because the predicate has no internal argument.

However, consider the following contexts:

(2)

- | | | | | | | |
|-------|-------|----|-------|-----|------|------|
| a. ye | Mbárá | a- | m(ú)- | éna | mbwá | ráme |
|-------|-------|----|-------|-----|------|------|

QM	Mbara	SM	P1	see	dog	my
----	-------	----	----	-----	-----	----

“Did Mbara see my dog?”

b. ee,	Mbárá	a-	m(u)-	éna
yes	Mbara	SM	P1	see

“Yes, Mbara saw”

(2b) is grammatical even though the verb has no direct object NP. Notice that the direct object NP that should occupy the empty internal argument position bears the feature [-human]. *Mbwá ráme* “my dog” in (2b) is a definite NP. If we compare (1c) and (2b), we come to the realization that [-human] definite object NPs can be dropped in Tuki, while [+human] definite direct object NPs cannot¹. Bear also in mind that [-human] NPs do not require object markers (OM). So, suppose that we are talking about my dog or a lion, there will not be an object marker inside the verb if the object is dropped. Thus compare (1b) and (3b).

(3)

a. Mbárá	a-	m(ú)-	úna	íngbeme
Mbara	SM	P1	kill	lion

“Mbara killed a/the lion”

b. Mbárá	a-	m(ú)-	úna
Mbara	SM	P1	kill

“Mbara killed/ Mbara killed it”

If a direct object is indefinite in some context, it can be dropped irrespective of whether it is [+human] or [-human].

(4)

a. ye	Mbárá	a-	mu-	kúsa	ikúnda
QM	Mbara	SM	P1	buy	bed

“Did Mbara buy a bed?”

b. ée	Mbárá	a-	mu-	kúsa
yes	Mbara	SM	P1	buy

“Yes Mbara bought it”

(5)

a. ye	Putá	a-	dingam	mutu
QM	Putá	SM	loves	man

“Does Puta love somebody/ a person?”

b. ée	Putá	a-	dingam
yes	Putá	SM	loves

“Yes Puta loves”

If a quantifier appears with the direct object NP, the omission of the NP of the quantified NP is optional:

(6)

a. ye	Mbárá	a-	m(u)-	ófa	tsóno imo
QM	Mbara	SM	P1	throw	clothes some

“Did Mbara throw away some clothes?”

b. ée	Mbárá	a-	m(ú)-	ófa
yes	Mbara	SM	P1	throw

“Yes, Mbara threw away”

c. ée Mbárá a- m(ú)- ófa imo
 ‘Yes, Mbara threw away some’

(7)

a. ye Putá a- benám vátu víma
 QM Puta SM hates men all

‘Does Puta hate all men’

b. ée Putá a- bená
 yes Puta SM hates

‘Yes Puta hates’

c. ée Putá a- benám vima
 yes Puta SM hates all

‘Yes Puta hates all’

The null object constructions exhibited above are not to be confused with sentences such as the following:

(8) Mbárá a- nyám
 Mbara SM eat

‘Mbara eats’

Following J. –Marc P. Authier (1987), we will assume that the verb *onyá* ‘to eat’ may or may not assign its internal theta role. The sentence in (8) simply means that the speaker lunched or dined.

Null elements occur in other constructions in Tuki which are similar to null object structures. These null elements appear across discourse and in the second conjunct of coordinate structures. In (9b) below which is the answer to (9a), the direct object NP and the PP are missing:

(9)

a. ye kúká a- mú- wáa manyá ná kísini
 QM cook SM P1 put food in kitchen

‘Did the cook put the food in the kitchen?’

b. ée a- mú- wáa
 yes SM P1 put

‘Yes, he put’

The null object construction in (9b) is similar to the following context:

(10)

a. ǎndzu a- mú- nyá manyá máme
 who SM P1 eat food my

‘Who ate my food’

b. Díma a- mú- nyá
 Dima SM P1 eat

‘Dima ate’

Raposo (1986) indicates that null object constructions do not allow the omission of PPs, but only the omission of certain direct object NPs in Portuguese. The same phenomenon seems to obtain in Tuki, as evidenced by the ungrammaticality of (11) below where the prepositional phrase is missing.

(11)

* kúká a- mú- wáa manyá _____
 cook SM P1 put food

‘The cook put the food’

The omission of the direct object NP and the PP in (9b) is determined by a linguistic context. Following Raposo, we claim that (9b) would be ruled out in the absence of a linguistic antecedent. In Tuki object drop constructions, the null object refers to an NP previously introduced in discourse or in the immediate preceding linguistic context. If the information supposed to be carried by the null object was not previously provided, the null object construction is illicit.

In partial conclusion, the object drop construction in Tuki is different from the unspecified object construction (*John ate=John lunched*) and from the other deletion processes such as the one exhibited in (9b). If we agree that object drop constructions in Tuki satisfy Chomsky's Projection Principle at some level, then we have to assume that there is an empty category in postverbal position in those constructions. But what type of empty category is it?

In the framework that we are assuming here, four kinds of empty categories are recognized. The four types, provided below, correspond to the four possible feature /value-combination:

- (12)
- a. [-a, -p] wh-trace (or variable)
 - b. [+a, -p] NP-trace
 - c. [-a, +p] pro (little or small)
 - d. [+a, +p] PRO (big PRO)

The empty category in Tuki object drop constructions cannot be PRO since the latter must always be ungoverned. It cannot be an NP-trace either. In (2b) for instance, the empty category cannot be bound to the only NP *Mbara* which is the subject of the sentence. We are thus left with only two logical possibilities. Our null element in Tuki null object sentences is either pro or wh-trace. Chomsky (1982) argues that pro is always interpreted as being definite in reference. Recall that it was argued above that Tuki allows a definite null element in direct object position.

Tuki also allows an indefinite null category in object position. If we adopt the view that this null element in object position is pro, then we are indirectly claiming that pro may be definite or indefinite in reference, in contrast to what Chomsky has observed. We will come back to this problem in a subsequent section.

If, on the contrary, the null category in Tuki object drop constructions is a wh-trace, then we have to assume that it is bound to an abstract wh-operator. Chomsky (1982), Huang (1982), and Raposo (1986) have all shown, one way or another, that an empty category can be bound to a non-overt operator in COMP.

Consider the following structure:

- (13)
- OP_i [Mbárá a- ma- íba x_i]
 Mbara SM P2 steal
 "Mbara stole"

We will assume, following Chomsky (1981, 1982), that a variable is an element locally A'-bound. Abstract operators moving at S-structure, they are expected to obey Bounding theory. It is therefore expected that null objects would not violate the Doubly Filled Comp filter (DFC).

7. 2. Syntactic Islands

7. 2.1. The complex NP constraint

Ross(1967) formulated the Complex NP Constraint (CNPC) as follows:

(14)

Complex NP Constraint (CNPC)

No element contained in an S dominated by an NP with a lexical head noun may be moved out of that NP by a transformation (Ross's (4.20)).

Let us imagine that in the following sentences, the subject matter is money:

(15)

a .Mbárá a- m(ú)- oséna EC_i na komboto ra tsúmba
 Mbara SM P1 hide in closet of bedroom
 “Mbara hid EC_i in the closet of the bedroom”

b.Mbárá a- mú- dzăna Díma éé engá ná Putá ee
 Mbárá SM P1 tell Dima that makes to Puta that
 o- séna EC_i ná komboto ra tsúmba
 SM hide in closet of bedroom
 “Mbara told Dima to order Puta to hide EC_i in the closet of the bedroom”

c. Mbára a- mú- dzăna purusú marú áma ée Díma a-
 Mbara SM P1 tell police story this that Dima SM
 m(u)- íba EC_i na komboto ra tsúmba
 P1 steal in closet of bedroom
 “Mbara told the police the story that Dima stole EC_i in the closet of the bedroom”

(15a) is a simplex sentence with a null object. In (15b) the null object occurs inside an embedded context. While in (15c), the null object appears in a clause – complement to a complex NP. Contrary to expectations, (15c) is grammatical, violating thereby the Complex NP Constraint.

(16)

a. okutu áme a- má- kúsa EC_i ídzo n(a) ipátira
 woman my SM p2 buy yesterday in store
 “my wife bought EC_i yesterday in the store”

b. okutu áme ódzu a- má- kúsa EC_i ídzo n(á) ipátira
 woman my who SM P2 buy yesterday in store

a- mu- niyo éé Putá
 SM P1 name that Puta
 “my wife who bought EC_i yesterday in the store is called Puta”

In (16b), the null object occurs in a relative clause. The construction is, however, grammatical.

7.2.2. The Sentencial Subject Constraint

Ross's Sentencial Subject Constraint applies to any element to be moved out of the island configuration:

(17)

Sentencial Subject Constraint (SSC)

No element dominated by an S may be moved out of that S if that node S is dominated by an NP which itself is immediately dominated by S (Ross's (4.254)).

Consider the following sentence where EC_i = *kanda* “belt”:

(18)

ée Mbárá a- bangám EC_i nŭ n-kámbín
 that Mbara SM cries I SM surprise
 “that Mbara needs EC_i surprises me”

(18) shows no subjacency effects. It does not therefore constitute prima facie evidence that the null object has traveled to COMP.

7.2.3. Adjuncts

Campos (1986) and Raposo (1986) indicate that in Spanish and European Portuguese respectively, no extraction is allowed from adjunct clauses with adverbial function. Belletti and Rizzi (1981) subsume this phenomenon under Bounding theory. Under these terms, a null object should not occur inside an adverbial clause;

Consider in this respect the following Tuki sentence in which EC_i = *manya* “food”:

(19)
 Mangádzu a- m(ú)- énda ná sukuru avan adze nŭsi
 Child SM P1 go to school before that mother
 wáá a- námbá EC_i wusí ná kísini
 his SM cook well in kitchen

“the child went to school before his mother cooked EC_i well in the kitchen”

(19) seems to be immune to Subjacency effects.

Huang (1982) has proposed a Condition on Extraction Domain (CED), by which a phrase may be extracted out of a domain only if that domain is properly governed:

(20)

Condition on Extraction Domain (CED)

A phrase A may be extracted out of a domain B only if B is properly governed.

Huang’s Condition on Extraction Domain is assumed to apply in the Syntactic component, but not at LF.

Consider now (21) below, where EC_i = *tikete* “tickets”, in view of the CED:

(21)

a. ye vínu nu- mú- kúsa tikete rá ndamba
 QM you SM p1 buy tickets of ball

“did you buy tickets for the ball game?”

b.ée, vítsu tu- mu- kúsa EC_i
 yes we SM p1 buy

“yes, we bought”

c. vítsu tu- m(u)- igăna na ndamba asene tu- mu- kúsa EC_i
 we SM p1 enter to ball because SM p1 buy

“we entered the ball game because we bought EC_i”

(21c) is licit, suggesting thereby that EC_i is not subject to the CED.

7.2.4. The Wh-island Constraint

Null object can occur inside wh-islands in Tuki. Consider the following object drop construction in which EC_i = *moni* “money” and EC_j = *yendze* “house”:

(22)

Mbárá i- dzímam [yéndze aye]_j Putá a- m(á)- íba EC_i awo EC_j
 Mbara SM knows house that Puta SM p2 steal in

“Mbara knows the house Puta stole EC_i in EC_j”

7.2.5. The Doubly Filled COMP Filter

In (23) and (24) below, the COMP position is filled with an overt operator. Assuming that there is an abstract operator binding a null object would force us to postulate a violation of the Doubly Filled COMP filter as formulated in (25).

(23)

Tane Mbárá a- kusám EC_i EC_j na wúc(ó) a mbwá ráá where
 Mbara SM buys in front of dog his
 “where does Mbara buy EC_i for his dog”

(24)

[mwána wáá ate]_j odzu Putá a- kos-en- á m EC_i EC_j
 child her what whom Puta SM buy Appl(for) FV Inc
 “for which of her children does Puta buy”

(25) Doubly Filled COMP filter (dfc)

*[_{COMP} X^{max} complementizer]_{COMP}

(where X^{max} and complementizer are both filled)

The fact that (23) and (24) are not illicit might be suggested to be an indication of the fact that the COMP position can be occupied by both the null operator and the overt wh-element, thereby violating the Doubly Filled COMP filter. It may be argued that (23) and (24) are grammatical simply because a non-overt operator in COMP in Tuki does not function as a trigger of the Doubly Filled COMP filter violation. But this would be an ad hoc proposal since it is well known that null operators create DFC violations.

7.2.6. Parasitic gaps

Comsky’s (1982) assumes that a parasitic gap in an adjunct clause is licensed by an S-structure variable left by wh-movement in the main clause. If null objects in Tuki are the result of Move alpha, then they should be able to license a parasitic gap in an adjunct clause. This prediction is borne out. Consider (26) below where EC_i = [ngó ráa]_i “his hen”:

(26)

Mbárá a- m(ú)- éna EC_i n(á) ondzóo k(o) órendza pg_i
 Mbara SM P1 see in road without recognize
 “mbara saw EC_i on the road without recognizing pg_i”

It has been shown by Sells (1984 b) that pronouns can license parasitic gaps. This could suggest that EC_i is a pronoun rather than an S-structure variable created by Move a.

7.2.7. Summary

Up to now, we have systematically considered the possibility that null objects in Tuki might be variables formed as a result of Move Alpha. If Tuki null objects were indeed variables at S-structure, they should be bound to an abstract operator in COMP, given that in the constructions analyzed there are no phonetically realized operators in the COMP position of the root of the clause. It is well known that variables formed as a result of wh-movement and bound by a wh-element in COMP are subject to Bounding Theory. An extensive discussion of the Tuki empirical material shows that the behavior of Tuki null objects does not parallel the behavior of traces bound by a Wh-phrase in COMP with regard

to subadjacency and the Doubly Filled COMP filter. If the Complex NP Constraint, The Sentential Subject Constraint, the wh-island Constraint and the Doubly Filled COMP filter are all instantiations of the general rule Move Alpha, and they are consistently violated by null objects in Tuki, then the latter may not be variables associated with a null operator in COMP.

7.3. Tuki null objects as pro

It seems to be the case that null objects in Tuki syntactically behave as base-generated pronouns³. This claim may account for the fact that they are blind to conditions following from Bounding Theory. recall that we have indicated at the outset of this paper that a [+human] definite direct object pronoun may be dropped only when there is an object marker incorporated into the governing verb, and that [-human] NPs do not have phonetically realized direct objects in Tuki are all base-generated at D-structure as pro. Then at S-structure, their object markers are phonetically realized if their linguistic or discourse antecedent is [+human].

(27)

- | | | | | | |
|----|-------------------------------|----|------------|-----------------|----------|
| a. | Mbárá | a- | bánám | Putá | nambari |
| | Mbara | SM | marries | Putá | tomorrow |
| | “Mbara marries Puta tomorrow” | | | | |
| b. | * Mbárá | a- | bánám | EC _i | nambari |
| | Mbara | SM | marries | EC _i | tomorrow |
| c. | Mbárá | a- | mu- bánám | | nambari |
| | Mbara | SM | OM marries | | tomorrow |
| | “Mbara marries her tomorrow” | | | | |

(27) is ungrammatical because the dropped object refers to a [+human] definite direct object NP. Consider next the D-structure representation of (27c) where pro = puta:

(28)

- | | | | | |
|-------|----|---------|-----|----------|
| Mbárá | a- | bánám | pro | nambari |
| Mbara | SM | marries | pro | tomorrow |

At S-structure pro in (28) will surface as *mú* “him/her” since its antecedent is [+human] (we will specify the exact status of *mú* as we proceed).

(29)

- | | | | | | | |
|----|-----------------------------------|------|----|-------|-----------------|-----|
| a. | ye | Díma | a- | benám | síkane | ame |
| | QM | Dima | SM | hates | cat | my |
| | “does Dima hate my cat” | | | | | |
| b. | ée | Díma | a- | benám | EC _i | |
| | yes | Dima | SM | hates | | |
| | “yes Dima hates EC _i ” | | | | | |

The D-structure representation of (29 b) is provided below:

(30)

- | | | | | |
|-----|------|----|-------|-----|
| ée | Díma | a- | benám | pro |
| yes | Dima | SM | hates | pro |

at S-structure pro in (30) will remain null object since its antecedent is [-human].

Raposo (1986), following Jaeggli (1982), has argued that the null object in European Portuguese starts out as PRO at D-structure, then at S-structure moves to COMP since by the PRO theorem, PRO may not be governed at S-structure. Raposo’s analysis is backed up by the fact that null objects in European Portuguese behave as syntactic variables obeying Subjacency. Null objects in Tuki being

disrespectful of island constraints, it is assumed here that they are base-generated and unassociated with an abstract operator in COMP. Moreover, Tuki null object constructions violate weak cross-over as evidenced below where $EC_i = mbííi rábu$ “their sheep”

(31)

Vamásá	váá	va-	m(á)-	éna	EC_i	ídzo	na	mboo
Owners	their	SM	p2	see		yesterday	in	market

“their owners saw EC_i yesterday in the market”

But what exactly forces us to posit that null objects in Tuki are pro. More precisely, is it possible for an empty object position to act as an antecedent for the Binding Conditions of Chomsky (1981)?

(32)

Binding Conditions

A) An anaphor is bound in its governing category

B) A pronoun is free in its governing category

C) A name is free

Before we try to establish that null objects can act as antecedents for Binding Conditions, recall that in the preceding chapter it was shown that a gap in subject position can function as the antecedent for the chomskyan Binding Conditions. This argued for the existence of an empty category subject in tensed clauses (pro) in Tuki. The same diagnostic was used to determine the existence of an empty category subject in infinitive contexts (PRO) in this language. Below we will establish that that full pronominal subjects and empty pronominal subjects pattern alike in regard to Binding Theory.

7.3.1. Full Pronominal Subject and Binding Theory

Consider the following sentences:

(38)

a. D _i ma	a-	benám	omwámáte
Dima	AGR	hates	himself

“Dima_i hates himself_i”

b. *D _i ma _i	a-	benám	D _i ma _i
------------------------------------	----	-------	--------------------------------

c. *D _i ma _i	a-	benám	ómwéné _i
------------------------------------	----	-------	---------------------

Dima	Agr	hates	him
------	-----	-------	-----

“Dima_i hates him_i”

(39)

a. D _i ma _i	a-	mu-	dza	ée	nóó	i-	má-	núma	ómwéne _i
Dima	AGR	p1	say	that	snake	AGR	p2	bite	him

“Dima said that a snake bit him”

b. *D _i ma _i	a-	mu-	dza	ée	nóó	i-	má-núma	ómwámáte _i
Dima	AGR	P1	say	that	snake	AGR	P2	bite himself

“Dima said that a snake bit him”

c. *D _i ma _i	a-	mu-	dza	ée	nóó	i-	má-	numa	D _i ma _i
Dima	AGR	p1	say	that	snake	AGR	p2	bite	Dima

“Dima said that a snake bit Dima”

In (38a), *omwámáte* “himself” corefers to *Mbara*. Principle C rules out (38b). Principle B disqualifies (38c). Principle B is respected in (39a), therefore the sentence is licit. Principles A and C respectively outlaw (39b, c). Now does the same pattern obtain when the subject is a full pronoun? Yes:

(40)

a. *ómwénéé* a- benám ómwámáte
 he/she AGR hates him-/herself
 “he_i/she_i hates him-/herself_i”

b. **omwénéé_i* a- mú- dza ée nóó i- má- númá *omwámáte_i* he/she
 AGR P1 say that snake AGR P2 bite himself
 “he_i/she_i said that a snake bit him-herself”

c. *omwénéé_i* a- mu- dza ée nóó i- má- numa *omwénéé_i*
 he/she AGR P1 say that snake AGR P2 bite him/her
 “he_i/she_i said that a snake bit him_i/her_i”

d. * *omwénéé_i* a- mu- dza ée nóó i- má- numa *Díma_i* he/she
 AGR P1 say that snake AGR P2 bite Dima
 “he_i said that a snake bit Dima”

The above paradigm shows that a phonetically realized pronoun can act as an antecedent for the chomskyan Binding Conditions.

Next we return to null objects.

7.3.2. Null Objects and Binding Theory

Although it is not easy to devise contexts in which a null category can be solely interpreted as a grammatical object for the purpose of testing Binding Theory, let us construct examples in which a null category is possibly interpreted as a null object. Assume that in the following examples, the theme is *imgbeme* “lion”:

(41)

a. *Mbárá* a- mú- éna EC_i ya- túf- i- a *imwámáte* ná *osumbu*
 Mbara SM P1 see AGR wash Appl FV itself in river
 “Mbara saw EC_i washing itself_i in the river”

b. **Mbárá* a- mú- éna EC_i yu- dzăna Putá ée vaná á náma
 Mbara SM P1 see AGR tell Puta that children of animal
 va- ta- dinga *imwámáte_i*
 AGR Neg love itself
 “Mbara saw EC_i telling Puta that small animals do not like itself_i”

c. *Mbárá* a- mú- úba EC_i údza ée vambere váá va- dingám EC_i
 Mbara AGR P1 hear say that friends its AGR love
 “Mbara heard EC_i say that its friends love EC_i”

d* *Mbárá* a- mú- éna EC_i údza ée nóó i- mú- númá *imgbeme_i*
 “Mbara saw EC_i say that snake bit lion_i”

In (a), Principle A and B are respected. (b) is ungrammatical because Principle A has been violated. Principle B rules in (c). Whereas Principle C rules out the (d) sentence.

Clearly the above paradigm shows that null objects pattern with null subjects with respect to Binding possibilities. In fact both null arguments pattern with phonetically realized NP's, validating thereby the existence of the former empty categories.

Now, having established the similarity between the null subjects and null objects in this language as far as Binding Theory is concerned, it would be nice to have a uniform account of the licensing and identification conditions governing the generation of both elements. In the preceding chapter, it was determined what licenses and identifies null subjects in Tuki. We will try to extend this analysis to null objects. Essentially it was argued that Tuki licenses null subjects because it has a morphological uniform inflectional paradigm. Verbal forms in this language have the structure: stem + affix. It was argued that AGR-S identifies the empty category in subject position of tensed clauses as *pro*.

Next we address the question of how *pro* in object position in Tuki is identified. As mentioned above, a uniform account of the occurrence of null subjects and null objects would be desirable. There seems to be an apparent correlation between the occurrence of *pro* subject and the possibility of *pro* object. It is well known that Italian and Brazilian Portuguese license null pronominal subjects. Rizzi (1986) and Farrell (1990) have shown respectively that Italian and Portuguese allow null pronominal objects. A unified account of both phenomena seem to be warranted.

7.4. Null Object Identification in Tuki

It seems to be the case that null objects in Tuki syntactically behaves as base-generated pronouns. This claim may account for the fact that they are bilind to conditions following from Bounding Theory. Recall that we have indicated at the outset of this work that a [+human] definite direct object may be dropped only when an object marker occurs inside the governing verb, and that [-human] NP's do not have phonetically realized direct objects. Let us revise this traditional claim and assume that what appears as a "human" direct object marker is simply the overt manifestation of AGR (Agr-O in Chomsky 1990)⁴. Evidence that this is so is provided by the following examples:

(42)

a. Mbárá a- má- mú_i- dínga Putá_i;
 Mbara AGR P2 AGR love Puta
 "Mbara loved Puta"

a'. Mbárá a- má- mú_i- dínga ómwéné_i;
 Mbara AGR P2 AGR love her
 "Mbara loved her"

b. Mbárá a- má- wú_i- noba vǎdzu_i;
 Mbara AGR P2 AGR beat children
 "Mbara beat the children"

b'. Mbárá a- má- wu_i- noba vǎmwéne_i;
 Mbara AGR P2 AGR beat them
 "Mbara beat them"

Notice that in (a') and (b') independent pronouns have replaced object NP's and the object markers are still contained by the verb. This constitute prima facie evidence that object markers are a manifestation of object-agreement, for if they were pronouns as generally assumed by "traditional" bantuists, then these sentences will be argued to contain two pronouns, an otherwise unmotivated assumption. We have sanctioned the agreement relation between the direct object NP's and Agr-O by coindexation (adapting to the Tuki data a suggestion of Chomsky (1981), Riemsdijk and Williams (1986)). When a direct object is dropped, what is traditionnaly called an object marker identifies the empty category in post-predicate position, much in the same way as Agr-S identifies the empty category that occurs in subject position of tensed clauses:

- (43)
- | | | | | | | |
|----|--------------------|-----|-----|------|-------|------------------|
| a. | Mbárá | a- | má- | mú;- | dínga | pro _i |
| | Mbara | AGR | P2 | AGR | love | |
| | "Mbara loved her" | | | | | |
| b. | Mbárá | a- | má- | wú;- | dínga | pro _i |
| | Mbara | AGR | P2 | AGR | love | |
| | "Mbara loved them" | | | | | |

This proposal provides evidence for views proposed in Chomsky (1990). Chomsky notes that there are two kinds of verb-NP agreement: with subject and object. Essentially following Pollock (1989), he indicates that there are two AGR elements: the subject-agreement element AGR-S and the object- agreement element AGR-O. Generally, AGR-O is close to V, and AGR-S close to the subject. Thus in the following sentence:

- (44)
- | | | | | | | |
|---------------------------|-----|-----|-----|-------|------|------|
| Mbárá | a- | tá- | má- | mú- | úna | Putá |
| Mbara | AGR | Neg | P2 | AGR-O | kill | Putá |
| "Mbara did not kill Puta" | | | | | | |

Mu is the AGR-O whereas *a* is the AGR-S. Chomsky assumes that AGR-S dominates Tense, since AGR governs the subject in finite clauses, thereby yielding subject-verb agreement. (45) is the tree structure representation of (44):

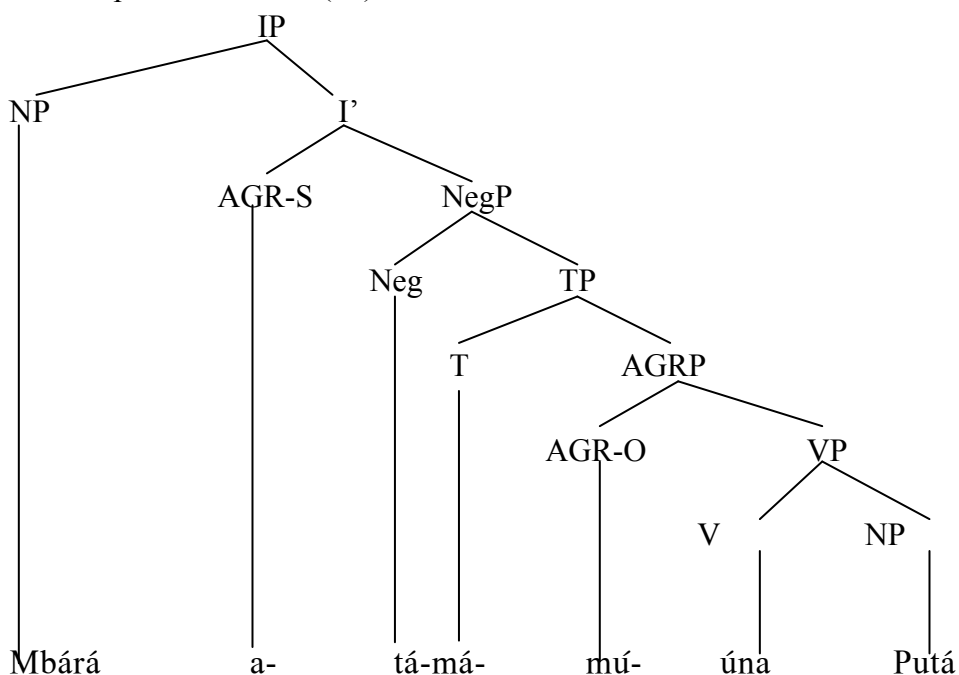

Although AGR-O is not phonetically realized when the direct object is [-human], it is fair to assume that it is nonetheless present. Otherwise, object pro will fail the identification test. The postulation of an invisible AGR-O is not ad hoc when one considers that invisible object clitics have been postulated for languages that do not display overtly realized objects clitics anywhere. It has been claimed by Safir (1985; pp. 466-467) that Japanese has identify object pro. Since Tuki exhibits AGR-O when the element referred to is [+human], the non-overt realization of AGR-O when the object is [-human] has to be a lower level language particular phenomenon.

Given the observed similarity between subject pro and object pro, let us assume that object pro is subject to all the conditions that regulate the generation of subject pro in Tuki. Thus Tuki allows object pro because it is a morphologically uniform language. If this proves to hold water, then our system needs a recoverability condition, general enough to encompass both subject and object pro:

(46)

A thematic null argument must be identified. Agreement affixes, as we have seen, will identify null arguments: AGR-S will identify subject pro while AGR-O will identify object pro.

7.5. Null Objects In Other Languages

In this section, we compare our analysis of Tuki object drop constructions to the analyses of null object constructions in other languages.

According to Raposo (1986), in European Portuguese, sentence (47) is grammatical, with no lexically realized direct object and no clitic present in the structure:

(47)

a Joana viu----- na TV ontem
 “ Jane saw-----on TV yesterday”

The D-structure representation of (47) is (48):

(48) [CP [IP a Joana viu PRO na TV ontem]]

Raposo assumes that the null object at D-structure is PRO. The latter, by the PRO theorem, must be ungoverned at S-structure. Therefore PRO has to leave the lexically governed direct object position and land on a non-theta position, since movement can only be from a theta to a non theta-position. The only available non-theta position in (48) is CP, where PRO becomes an abstract operator bound by a variable in direct object position at S-structure? Raposo suggests that null object sentences are “open sentences” predicated of the zero topic (Huang 1984) by a rule of Predication identical to the one proposed in Chomsky (1982) to account for the interpretation of relative clauses. Thus the S-structure representation of (48) is:

(49)

[_{TOP} e_i[_{CP} OP_j[_{IP} a Joana viu[e]_j na TV ontem]]

Chomsky’s rule of Predication will later match at LF’ the distinct indices at (49). Raposo then proposes a parameter based on the rule of Predication and differentiating null object languages from non null object languages. In the former languages, unlike the latter ones, the rule of Predication is open to Pragmatics (i.e. the null object refers to a topic in the preceding discourse or in the pragmatic context of the utterance).

(50)

Null Object Parameter (Raposo 1986)

The rule of Predication of the LF’ module of the grammar may (may not) refer to a pragmatic node.

Raposo's analysis crucially relies on the assumption that null objects in European Portuguese are formed as a result of the general rule Move Alpha, thereby motivating his rule of Predication approach. In our analysis of Tuki object drop constructions, there is no room for a rule of Predication. Null elements in object position are base generated and are immune to Bounding Theory effects. To advocate therefore the presence of a non-overt operator in COMP and the application of a rule of Predication in Tuki null object sentences seems implausible. Suffice it to simply say that the topic to which the null object refers lies somewhere in the preceding discourse.

All preceding analyses of null objects as syntactic variables make perfect sense, since null objects in the languages considered strictly obey Subjacency (Authier (1987), Campos (1986), Raposo (1986)). Tuki is not a case in point.

Huang (1984) has argued that the null object parameter

Could be subsumed under a general parameter labeled by Tsao (1977) "discourse-oriented vs. sentence-oriented".

Authier (1987), in view of Kinande, has convincingly indicated that Huang's proposal is illusory.

How does Huang's proposal, nevertheless, fare with regard to Tuki? According to Huang, discourse-oriented languages are characterized by three properties: "topic chaining" (Tsao, 1977), "topic prominence" (Li and Thompson, 1976a), and "discourse anaphora" (Yang, 1983).

Consider the following sentence:

(51)

[Kamerun, akaná adóngó][vakutu[e]nyemeno][osyá tsí [e]][ombee
 Cameroon big country women beautiful good land bad
 a máná [e]][vítsu tu- dingám[e]ífundu]
 of sky we SM love much

"Cameroon, a big country. (Its) women are beautiful. (Its) land is fertile. (Its) weather is bad. We love (it) much"

In (51), empty categories are bound across discourse, and they all refer to the topic *Kamerun* which is the leftmost antecedent of the anaphoric chain. Topic chaining, apparently, is available in Tuki. This may be due to the fact that pronouns expressing inalienable possession in Tuki may be null pronouns:

(52)

Mutu a- m(ú)- ara na yéndze yáme, ambóó [e] wutewute, ongwátá
 man SM P1 come to house my hands bound mouth
 [e] fwong, mbwá [e] ná nyímá [e]
 open dog in back

"a man came to my house, (his) hands attached, (his) mouth open, (his) dog behind (him)"

Chinese also allows pronouns to be null in cases of inalienable possession. In that respect, Chinese and Tuki are similar. However, unlike Chinese, topic prominence is not available in Tuki. So the equivalent of sentence (53) is ungrammatical in Tuki:

(53)

Neichang huo, xingkuì xiaofangduì lái de zao
 That fire fortunately fire-brigade come CP early
 "that fire, fortunately the fire brigade came early"

Tuki seems to exhibit discourse anaphora, the possibility of binding anaphors across discourse:

(54)

Speaker A: ye Mbárá ódzu a- mú- fá Putá; tsónó
 QM Mbara who SM P1 give Puta cloths
 “Is it Mbara who gave Puta; cloths
 Speaker B: mbéndo, omwámáte; a- mú- wóró
 no herself SM P1 take
 “no, herself took”

In (54), the reflexive *omwámáte* “herself” is bound by *Putá* in the preceding discourse. Thus Tuki shares with Chinese two of the three properties that are claimed by Huang to be characteristic of null object languages: topic chaining and discourse anaphora. We might be tempted to claim that topic chaining and discourse anaphora are the only properties that characterize null object languages.

(55)

Pro is governed by X^0_y

(55) states that pro is licensed by a governing head of type y . thus in null object languages such as Italian, Kinande, Portuguese or Tuki, V belongs to the licensing class. Rizzi concludes that the licensing class X^0_y is empty in non null object languages. To incorporate the idea that pro in subject position of null-subject languages is recovered through the rich agreement specification, Rizzi proposes the following:

(57)

Assign *arb* to the direct theta-role.

(57), unordered with respect to the Projection Principle, can apply both in the lexicon and in the syntax.

In Rizzi’s system, the null subject parameter and the null object parameter are conceived in similar fashion. A coindexed slot in the theta-grid of a verb in an object drop language is the analogue of a coindexed Agr under INFL in a subject drop language:

(58)

Pro_i Infl v pro_j
 Agr_i [theta]_j

The idea that a coindexed empty slot in the theta-grid of a verb identifies object pro in Italian but not in languages like English is utterly suspicious. It seems to us that it puts a heavy burden on the specifics of Italian verbs, should these specifics be shown to exist. Are there principled differences between Italian and English verbs? Rizzi fails to point out these.

Since there is independent evidence in Tuki that AGR-O (i.e. direct object agreement) occurs on the verb, one can reasonably infer that it is the presence of this AGR-O that identifies object pro in the language, pretty much in the same manner as AGR-S identifies subject pro. Given the otherwise similarities between Italian and Tuki with regard to subject pro, one might conjecture that Italian has an empty AGR-O node that identifies object pro. Further research on Italian is needed to test the veracity of this claim.

To accommodate the Tuki data, Rizzi’s system needs just optionalize the rule of arbitrary interpretation (57). Tuki, as we have seen, does not require its null objects to have an arbitrary reference. (57) would appropriately apply to a language like French which allows null objects to have arbitrary interpretation (see Authier (1987)). The analysis developed by Rizzi is appealing with regard to Tuki in that it does not rely heavily on the idea that null objects are associated with S-structure variables.

Peter Cole (1987) presents convincing arguments for null pronominal objects in Imbabura Quechua, Korean and Thai. He shows that empty objects in Imbabura Quechua are not variables, since they do not obey Strong Crossover:

(59)

a. juzi_i nin $\text{Marya } o_i$ juyanata
 Jose says Maria will love
 “ Jose_i says that Maria will love him_i ”

b. Juan_i munan Juzi o_i rijsichun
 Juan wants Jose know

Though subjacency applies to overt wh-movement in Imbabura Quechua, the distribution of null objects is immune to Bounding Theory.

(60)

a. *Relativization of element in relative clause (complex NP)*

*[[$\text{Juan} [[o_j o_i \text{japishka}] \text{sisakuna}_i] \text{gushta}_j$]] warmi_j juyallamari
 Juan picked flowers likes woman beautiful
 (“The woman that Juan likes the flowers that picked is beautiful”)

b. *Questioning element in conjoined NP*

* $\text{Pi- (ta)- } \text{taj}_i$ (kan) o_i $\text{mirkadu- } \text{pi}$ $\text{Marya- ta- rikurkangur}$
 (pash) who acc interrogative you market in Maria acc see
 (“whom did you see and Maria in the market?”)

Extraction from syntactic islands above results in ungrammaticality, whereas the occurrence of empty objects in nonsubjacent environments is licit in Imbabura Quechua.

(61)

a. *Null object in relative clause*

Juan_i $\text{yuyan[chay } [o_j \text{pay- } \text{ta}_i/o_i \text{rijsishka}] \text{runa}_j]$ $\text{mirkadu- } \text{pi}$ kashka- ta
 Juan thinks that he acc know man-acc market in was acc
 “Juan thinks that the man who knows him was in the market”

b. *Null object in conjoined NP*

Juan_i $\text{yuyan chay runa } \text{pay- } \text{ta}_i/ o_i$ $\text{Maria wan rikushka- ta}$
 Juan thinks that man he acc Mary and saw acc
 “Juan thinks that the man saw him and Mary”

Null objects in Imbabura Quechua are thus instances of pro rather than variables. Cole(1987) reports that the Imbabura Quechua empirical data are similar to Korean and Thai. In all three languages, violations of Principle C of the binding theory are illicit. But null complement objects in Korean and Thai can be coreferential with matrix arguments in unmarked contexts.

(62)

a. chelswu_i -ka [$\text{Yenghi - ka } o_j \text{hyeppakha- ess- ta}] \text{ko cwucangha- ess- ta}$
 Chelswu nom Yenghi - nom (him) threaten -past decl—comp claim past decl
 “ chelswu_i claims that Yenghi threatened him_i ”

b. John - un_i [$\text{Bill- i } o_i \text{cenhwaha- ess -ta}] \text{-nun sasil - ul acik moru -n-ta}$
 John top Bill nom call past decl fact acc yet not-know pres-decl

“John_i does not know the fact that Bill called o_i”

(63)

Thai

Nit_i book waa [Nuan hen o_i]

Nit speak say Nuan see

“Nit_i said that Nuan saw o_i”

Up to this point, we can say that Imbabura Quechua, Korean and Thai pattern exactly like Tuki in that they allow null objects which are instances of pro.

Citing also work done by Huang (1984) and Raposo (1986), Cole (1987) concludes that there are four types of languages with regard to null objects: (1) those like English that do not allow null objects of any type, (2) those like Mandarin and Portuguese that allow null variable objects but not null pronominal objects; (3) those like Imbabura Quechua that allow null pronominal objects; (4) those permitting both null pronominal and null variable objects; Tuki, obviously, belongs to the third category of null objects languages.

Huang (1984), as mentioned above, argues that the occurrence of null variable objects is contingent upon the existence of null topics as in (64).

(64)

Zhongguo, defang hen da, o [Zhongguo], renkou hen duo. O, tudi

China place very big china population very many land

hen feiwo. O, women dou hen xihuan

very fertile we all very like

“China, (its) land area is very large. (its) population is very big. (its) land is very fertile. We all like (it)”

Huang hypothesizes (correctly) that (64) allows phonologically empty topics because INFL is a proper governor in Chinese. Cole (1987) notes that Huang’s claim that INFL properly governs the topic and the subject in Mandarin Chinese makes three predictions that distinguish Mandarin from languages in which INFL is not a proper governor: (1) “Nongap topics” will occur; (2) Null topics will occur; (3) there will be no that-trace effects. From the above argumentation, Cole immediately assumes that a language will have null variable objects if INFL properly governs the topic. Tuki presents no evidence that Cole’s analysis is on the right track. Tuki exhibits no subject-object asymmetries; the subject position is properly governed by INFL (AGR-S):

(65)

a. *Well-formedness of null subjects*

a’. Mbárá a- rám

Mbara SM comes

“Mbara comes”

a’’. a- rám

SM comes

“he/she comes”

b. *complement object extraction*

ándzu Mbárá a- bungánám ée [e]_ia- m(ú)- éna Putá?

who Mbara SM thinks that SM P1 see Puta

“Who does Mbara think that [e]_i saw Puta?”

c. *Complement object extraction*

c' ándzu Mbára a- dingám o_i
 who Mbara SM loves
 “who_i does Puta love o_i”

c'. ándzu_i Mbára udzám éé Putá a- dingám o_i
 who Mbara say that Puta SM loves
 “Who_i does Mbara say that Puta loves o_i”

We have shown above that sentences like Chinese's (64) are well-formed in Tuki (see (51)). But in contrast to Mandarin Chinese, Korean and Thai, Tuki does not allow nongap topics. Thus, sentences like (66) are unavailable in the language.

(66)

a. *Nongap topic in Korean*

Enehak- un Chomsky -ka elyep -ta
 Linguistics -top Chomsky -nom difficult -decl
 “as for linguistics, Chomsky is hard to read”

b. *Nongap topic in Thai*

[let na [Nit book waa [Namtip hen Nuan law]]]
 Lek topic Nit speak say Namtip see Nuan already
 “As for Lek, Nit said that Namtip saw Nuam already”

Cole also makes the prediction that a language will have null variable objects if it exhibits: (1) nongap topics, (2) null topics, and (3) the absence of subject/ object asymmetries. Marc Authier (1989) indicates that French allows arbitrary null objects which are unselectively bound variables; however, French allows none of the above so called three characteristics of empty variable object languages.

(67) French

a. *Nongap topic*

(i) * Quant à la linguistique, Chomsky est difficile à lire
 As for the linguistics Chomsky is difficult to read

(ii)*Quant à Marc, Paul a dit que Pierre a vu Louise ce matin
 As for Marc Paul has said that Pierre has seen Louise this morning

b. *Null topics*

*la France_i ce pays est très beau. o_i, la population dépasse vingt
 The France this country is very beautiful the population is more than twenty
 millions d'habitants. o_i, la terre est fertile. o_i, nous aimons tous o_i
 millions inhabitants the earth is fertile we love all

“France, this country is very beautiful. Its population is more than twenty millions inhabitants. Its earth is fertile. We all love it”

c. *Subject/ Object asymmetry*

(i)*Qui penses – tu que o_i est parti
 Who think- you that is left

“*who_i do you think that o_i left”

(ii) Qui_i penses-tu que Marie va épouser o_i ?
Who think-you that Mary is going to marry

“who_i do you think that Mary is going to Marry o_i”

So, French is pretty much against Cole’s analysis.

Recall that Huang argues that the existence of null variable objects in a language is sanctioned by the existence of null topics. The possibility of null topics, in turn, is determined by whether INFL is a proper governor. Cole builds upon these observations to devise what he terms the *Infl government parameter* (IGP) according to which a language of which INFL is a proper governor will allow null variable objects, whereas INFL-is-not-a-proper governor-language will disallow null variables objects. The IGP is illusory since French allows empty variable objects (see Authier 1987), although its INFL is not a proper governor.

Moreover, Cole parameterizes Huang’s Generalized Control Rule (GCR) (1985) to the effect that it will apply to both pro and PRO in Mandarin Chinese, Portuguese and English, but that in Imbabura Quechua, Korean, and Thai it will apply only to PRO. Yet the need for a GCR in a theory of grammar is not evident in view of the new developments in the field. The GCR was devised to supplement, among other proposals, Jaeggli’s (1982) Identification Hypothesis according to which pro is licensed by the recoverability of its reference from the morphology of a governing element. Huang (1985) notes that the Identification approach makes wrong predictions with respect to the distribution of null subjects in Mandarin Chinese. Null subjects are allowed in Chinese although the latter lacks subject verb agreement, as exhibited in (68):

(68)
Zhangsan_i shuo o_i kanjianle Lisi
Zhangsan says he saw Lisi
“Zhangsan_i says that he saw Lisi”

Huang (1985) draws the conclusion that in substance there are two types of languages that allow pro subjects: (1) those completely devoid of subject-verb agreement (Mandarin Chinese); (2) and those invested with subject-verb agreement (Italian, Spanish, Tuki). Mixed languages that have an “impoverished” agreement system will disallow pro subjects (English). To account for the above facts, Huang devises a generalized theory of control according to which pro and PRO are subject to a Generalized Control Rule (for details see Huang (1985), (25)).

But recently, Jaeggli and Safir (1989) have shown that it is not rich agreement that licenses the presence or the absence of empty categories in subject position, but rather “morphological uniformity”.

It is easy to demonstrate that pro subject languages are accounted for by Jaeggli and Safir’s (1989) analysis (see also Biloa (1991) for an analysis of Tuki as a null subject language). So the GCR is dispreferred on grounds that it cannot account for the fact that it is not rich agreement or total lack of agreement which licenses null subjects (although AGR can be an identifier). However, the GCR predicts that object pro will not occur unless the identifying verb morphology is present.

7.6. Concluding Remarks

In this chapter, we have argued that null objects in Tuki sentences are base generated empty pronouns which are identified by AGR-O (just like pro is identified by AGR-S). Tuki null objects are immune to Bounding Theory, therefore their behavior does not parallel the behavior of syntactic variables which are not blind to islands. Previous analyses of null objects in Chinese, Kinande and

Portuguese may not consequently be valid for Tuki. Raposo's (1986) formulation of the null object parameter is not motivated in Tuki, casting thereby doubts on the relevance of that parameter. Huang's (1984) idea that the null object parameter be subsumed under a more general parameter called by Tsao (1977) "discourse-oriented vs. sentence-oriented" obtains mixed results in Tuki: while topic chaining and discourse anaphora are attested in the language, topic prominence is conspicuously missing. Work done by Authier (1987) in Kinande has revealed that only discourse anaphora is available in the latter language.

We have proposed a unification of the accounts of subject pro and object pro. We have suggested, for the most part on the basis of the Tuki data, that the licensing, recoverability and identification conditions for both empty categories are identical:

(A) *Licensing condition*

Argument pro's are permitted in all and only those languages which have morphological uniform inflectional paradigms;

(B) *Recoverability condition*

A thematic null argument must be identified.

(C) *Identification Condition*

AGR can identify an empty category as (thematic) pro if and only if the category containing AGR case-governs the empty category.

Notes

1. The same phenomenon seems to obtain in Brazilian Portuguese. Farrell (1990) indicates that it is unusual to refer to inanimate objects with a full pronoun in this language.
2. One might be inclined to think that subjacency is not respected in this language. However, that is not the case, as illustrated by the ungrammaticality of the following construction:

(i) *[ná ándzu]_i Isomo a- mú- úba máru ama [éé para a- ma dzára x_i]
 with who Isomo SM P1 hear story this that priest SM P2 talk
 "* with whom Isomo heard the story that the priest talked"

(i) is ruled out because the pied piping of the Wh-phrase *na ándzu* has taken place over an island (in this case a complex noun phrase).

3. It could be argued that the construction illustrated and discussed in section 2 are immune to Subjacency because the EC's are resumptive pronouns bound by an operator at some level. Having already argued against the presence of an invisible operator in the text, the remaining question is how can we distinguish, in a principled manner, resumptive pro from "ordinary" pro? It is well known that resumptive pronouns have to be bound by a wh-element (at S-structure or LF). It has been argued extensively that resumptive pronouns are (semantic or syntactic) variables. Non-resumptive pro's, on the other hand, cannot be interpreted as variables at any level. Although it has been suggested by Rizzi (1982) that resumptive pronouns are marginally acceptable in subject position within an island but are ruled out in object position in Italian, there is no evidence that identification by Infl is necessary for the licensing of resumptive pronouns in Tuki (for details see Biloa (1989). Thus, at least in Tuki, pro crucially differs from resumptive pro in that the former cannot be interpreted as a variable at any level. Moreover, while pro desperately needs an identifier (AGR or Infl), resumptive pro requires an A'-binder. This reasoning points to the fact that the EC's discussed in Tuki object drop constructions are

pro's because they have not been created by movement (Wh-movement or NP-movement) and therefore they are not variables (=resumptive pronouns); they are not PRO's since they are case-governed. More evidence that the data analyzed so far involve object-drop comes from the facts of backward anaphora. It is well-known that pronouns may precede their antecedents in some cases:

(i) Before he_i takes a picture, John_i always focuses the camera (Farrell's (1990, pp. 336))

In the following examples, null objects in Tuki precede their antecedents, as predicted:

a. Ngí mámú wa- dínga ée mámú o- námbé- n- a EC_i, nũ ngu-
 If you AGR love that you AGR cook Appl. FV I AGR
 nu- únám ndone;
 F1 kill cow

“if you want to cook EC_i for me, I will kill the cow”

b. Avan adze nũ n- kúsa EC_i na ípátira, nũ n- dingám ée
 Before that I AGR buy in store I AGR love that
 nu nga- féya [tsónó adze]_i
 I AGR try cloth this

“Before I buy EC_i in a shop, I want to try this cloth_i”

If null objects in Tuki are pronouns, the above facts follow straightforwardly.

4. It might be argued that object markers (OM) in Bantu languages should be treated like verbal object clitics in Romance languages. Rizzi (1982, p. 134) has proposed the following structure for verbal clitics:

(i)

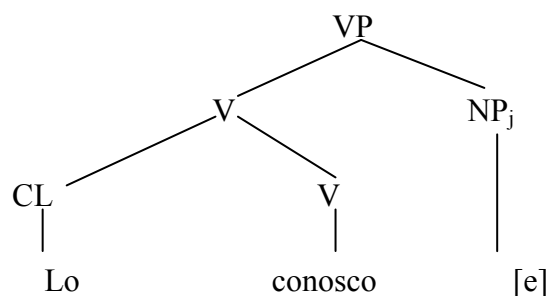

The above structure fails to shed light on why there are sentences such as the following if *mu* is a verbal object clitic, rather than object-agreement:

(ii)

Mbárá a- má- mú- dínga ómwéné
 Mbara SM P2 AGR love her
 “Mbara loved her”

CHAPTER EIGHT

A-bar bound pro

8.1 Introduction

This chapter reveals that gaps in Tuki WH-constructions should be analyzed as null resumptive pronouns rather than variables left by “Move Alpha”. In Tuki, the head of the wh-phrase can be associated with a gap or a resumptive pronoun. Generative Grammar analyzes the gapped examples as instances of “Move Alpha”, a general rule that prohibits movement from island environments. The fact that the resumptive pronoun strategy in Tuki violates Bounding Theory is expected under current assumptions in the field whereas such a violation is unexpected under a movement analysis of the gapped constructions in the language. However, Tuki consistently appears to violate island conditions such as the CNPC, the Wh-island, the CED, and the Sentential Subject Constraint. Moreover, coordination of a clause containing an overt resumptive pronoun and a clause containing a gap is possible. Furthermore, while resumptive pronouns fail to exhibit weak-crossover effects, gapped sentences also fail to exhibit weak-crossover effects, suggesting once again that these gaps are pronominals not wh-traces. All of this evidence and other facts corroborate this claim. In the next section, we introduce the reader to Tuki and claim that Tuki is a pro-drop language. In section 3, we establish the parallelism between gaps and resumptive pronouns in Tuki WH-constructions. In section 4, we provide evidence that the behavior of the gapped sentences is similar to the behavior of the sentences containing resumptive pronouns with respect to island constraints. Section 5 shows that overt resumptive pronouns as well as gaps do not exhibit weak-crossover effects (at S-structure). It is claimed in section 6 that resumptive pronouns license parasitic gaps in Tuki. The analysis of anaphoric binding in section 7 strengthens the idea that resumptive pronouns are syntactically bound in the language. Section 8 considers the correlation between movement and reconstruction with regard to Tuki. It is established that connectivity effects fail to obtain over wh-islands, suggesting thereby that the correlation between connectivity and wh-movement may be valid. Moreover, drawing on data from Tuki and Egyptian Arabic, it is posited that Subjacency is a condition on movement rather than a condition on output representations (Huang (1982), among other references); empirical arguments, as well as theory-internal ones, are presented to support that view. Section 9 examines two cases of coordination in the language, one of which appears to violate the Coordinate Structure Constraint (CSC) but in fact does not. In section 10 we show that Tuki exhibits weak crossover effects at LF, providing thereby further support that gaps in Tuki Wh-constructions are non-overt resumptive pronouns, which explains the non-existence of weak crossover effects at S-structure.

8.2 Tuki as a pro-drop language

Tuki is verb initial in VP; the basic word order is SVO:

(1)

a. Mbárá a- nobám vǎdzu
Mbara SM beat children

“Mbara beats children”

b. Vǎdzu va- nobám Mbárá
children SM beat Mbara

“Children beat Mbara”

Tuki is also a null subject language since it allows the subject position of finite clauses to be empty (Chomsky 1981, 1982; Jaeggli 1982; Rizzi 1982). Like many Bantu languages, Tuki is a noun –class language. Every noun in Tuki belongs to a noun-class which determines the agreement-prefix markers that the noun will control on verbs and modifiers including the subject marker (SM).

Consider (2) and (3) below:

(2)

a. vakutu vá -nyám mbúngu
class 1 woman SM eat cassava

“Women eat cassava”

b. ndóne í -nyám mbúngu
class 10 cows SM eat cassava

“Cows eat cassava”

(3)

a. *vakutu i-nyám mbúngu

b. *ndóne va-nyám mbúngu

In (2), the subject markers *va* and *í* which represent AGR in INFL agree in noun class with the NPs *vakutu* and *ndone* respectively. Any random assignment of subject markers to inappropriate NPs will automatically result in ungrammaticality (cf (3)). In case the two NPs *vakutu* and *ndone* are absent in the sentence, but they are recoverable metasyntactically, we will have empty categories in subject position:

(4)

a. [e]_i va_i- nyám mbúngu
SM eat cassava

“They eat cassava”

b. [e]_i i_i-nyám mbúngu

SM eat cassava

“They eat cassava”_Ù

Riemsdijk and Williams (1986), following Chomsky (1981), have suggested that the agreement relation between AGR and the subject should be sanctioned by coindexation:

(5)

NP_i [_{INFL} [+tns] AGR_i]_{INFL} VP

It is assumed in (5) that either AGR_i c-commands NP_i and can govern it, or that INFL “inherits” the subscript from AGR_i and acts as a proper governor whenever NP_i is not phonologically present. Whatever the assumption adopted, the empty category in subject position in Tuki is properly governed, consequently it does not violate the Empty Category Principle (ECP). The distribution of the class of phonologically empty arguments, of which *pro* (the empty pronoun) is a member, is constrained by the ECP (for details see Chomsky 1981;1982):

The Empty Category Principle (ECP):

[_{NP} e] must be properly governed.

Government: X governs Y if and only if:

(a) X c-commands Y, and

(b) X is an X^o, i.e. X is a member of the class {N, V, P, A, INFL}, and

(c) every maximal projection dominating Y dominates X.

Proper Government: X properly governs Y if and only if:

(a) X properly governs Y and X is lexical (N, V, A or P), or

(b) X Locally A'-binds Y.

Rizzi (1982) assumes that in a null subject language, the INFL node containing AGR can function as a lexical proper governor, thereby licensing the occurrence of empty categories in subject position. This assumption seems to be valid in Tuki as evidenced by the grammaticality of the following sentence:

(6) Andzu_i [IP mǎmú o-búngánam [CP x_i ée [IP x_i a- má-gwa]]]

who you SM think that SM P2 die

“Who do you think that died?”

In (6), the wh-element *andzu* “who” has been extracted from subject position over the lexical complementizer *éé* “that”. The fact that the construction is not ruled out by the ECP suggests that INFL properly governs the trace left in subject position. In a subsequent section, we will come back to the problem of the empty category in subject position in Tuki.

8.3 Resumptive Pronouns

The distribution of resumptive pronouns has always been the concern of linguistic investigation. Research in Generative Syntax reveals that the behaviour of resumptive pronouns is subject to cross-linguistic variation. Shlonsky (1992:443-466) shows that resumptive pronouns in Hebrew and Palestinian are used as a saving device i.e. they are appealed to as a last resort strategy, when wh-movement has failed to yield a grammatical output. In Tuki, things seem to be quite different in that resumptive pronouns are optional and exhibit no cross-over effects. Following Sells (1984a, 1984b, 1987), we will assume that resumptive pronouns are pronouns which appear in ‘Wh-movement’ constructions, and which are directly bound by the operator in such constructions, as in the following Tuki sentences:

(7)

a. mutu ódzu_i Nũ ngu- mú-dingám ómwéne_i
 man who I SM OM love him

“The man who I love him”

b. okutu ódzu_i nũ ngu-mu-bina ná a_i
 woman who I SM P1 dance with her

“The woman who I danced with her”

c. mánvádzu odzu_i nõsí wáa_i a-dingám Putá
 child who mother his SM love Puta

“The child who his mother loves Puta”

Let us now consider the following Hebrew and Palestinian examples from Shlonsky (1992)

(7') (Shlonsky,1992:444-5)

a. ha-çisû seû-raçiti (çoto)

the man that- (I) saw (him)

“The man that I saw”

b. ha-çisû seû- xasavti sê-(hu) melamed çanglit

the man that (You.F) (he) teaches English

“The man that you thought teaches English”

c. ha-çisû seû- xasavti çal-*(av)

the- man-that (I) thought about- (him)

“The man that I thought about”

Notice that in (7a), an object agreement marker (*mú*) agreeing with the object pronoun *ómwene* “him” occurs inside the verb. Object agreement markers are phonetically realized only when direct object NPs are [+human]. In other words, there are no object agreement markers for [-human] NPs. There seems to be similarity between Tuki data in (7) and Hebrew ones in (7') in that either a gap or a

resumptive pronoun can be used in relative clauses except for oblique cases where the presence of a gap is ruled out in Hebrew (7'c). In (7'c), preposition stranding is not allowed and there is an ECP violation in the sense that P⁰ is not a proper governor in Hebrew, therefore, the trace left by the movement of the object NP *ha-ǰisû* “man” fails to be properly governed. The only way this construction can be salvaged is through the use of a phonetically realised resumptive pronoun. The list of Tuki object agreement markers is provided below:

(8)

Tuki Object Pronouns	
Singular	Plural
n ‘me’	su ‘us’
o ‘you’	nu ‘you’
mu ‘him/her’	wu ‘them’

Tuki uses six independent pronouns in subject or direct object position:

(9)

Nũ	‘I, ‘me’
Mámú	‘you (sg.)
Ōmwéne	‘ he/she, him/her’
Vítsú	‘we, us’
Vinú	‘you’(pl.)
Vámwéne	‘they, them’

The above independent pronouns are also used as resumptive pronouns (cf.7a). After a preposition, the following items are used as (resumptive) pronouns (cf. 7b) instead of *Ōmwéne* ‘ he/she’ and *vámwéne* ‘they, them’. The other forms in (9) can be used after a preposition.

(10)

á	“ him/her”
abú	“them”

Some languages have resumptive pronouns and others do not. Tuki seems to have resumptive pronouns. Before we analyze resumptive pronouns in this language, it is necessary to define them. In attempting to define resumptive pronouns, we will rely on Sells’s (1984) which is the first major attempt to analyze them in Government-Binding theory (see also Chao and Sells 1983). Sells (1984) indicates that Ross (1967) observes that while relativization normally leaves a gap at the extraction site and is a ‘chopping’ rule, a dialect of English allows sentences such as the following:

- (11)
- a. I just saw a girl who Long John’s claim that *she* was a Venusian made all the headlines.
 - b. The only kind of car which I can never seem to get *its* carburetor adjusted right is them Stanley Steamers.

In the above sentences, the site for relativization is occupied by a pronoun (*italic*), and the examples are not derived by a ‘chopping’ rule, but a ‘copying’ rule (namely pronominalization). The corresponding sentences, when they contain gaps instead of pronouns, are ungrammatical:

(12)

- a. * I just saw a girl who Long John’s claim that—[e] was a Venusian made all the headlines’.
- b. *The only car of which I can never seem to get [e] (‘s) carburetor adjusted right is them Stanley Steamers.

Ross predicts the ungrammaticality of these examples. ‘Chopping’ rules are subject to movement constraints whereas ‘copying’ rules are not. Thus (12a) violates the Complex NP Constraint, and (12b) the Left Branch Constraint; therefore both constructions are ruled out.

Sells argues that the pronouns in (11) are not resumptive pronouns, although they are very similar to the pronouns in the Hebrew examples in (13), which appear to be prototypical examples of the ‘resumptive strategy’:

(13)

- a. ze ha is se oto ra iti etmol
 this - is the man that him I-saw yesterday
 “This is the man that I saw yesterday”
- b. ra iti et ha is se natati li et ha sefer se hu katav oto
 I-saw the man that you gave to-me the book that he wrote it.
 “I saw the man that you gave me the book he wrote”

In these Hebrew examples, the resumptive pronoun is inside an island; one would also expect the corresponding English sentences to be acceptable. But even in the dialect of English that accepts the examples in (11), the literal translation of (13a) is ungrammatical:

(14)

- *This is the man that I saw him yesterday.

What is the difference between English and Hebrew?

Sells argues that there is a systematic difference in the interpretation of the pronouns in the English examples in (11) and the Hebrew examples in (13).

Pronouns may be linked to their antecedents in (at least) two ways (see Partee (1975)). Thus, the following example is ambiguous:

(15)

- Only John likes the girl he is dancing with.

Even if the interpretation where *he* is understood as some individual other than *John*, (15) may still have two interpretations. In one interpretation, the pronoun *he* is interpreted as a variable bound to the

meaning of the NP *John* (16a). In the second interpretation, the pronoun *he* refers to the individual *John* (16b):

(16)

- a. Only John is an X such that X likes the girl that X is dancing with (bound variable).
- b. Only John is an X such that X likes the girl John is dancing with (referential).

Sells refers to the two interpretations represented above as ‘bound variable’ and ‘referential’ respectively. Gaps in restrictive relatives for example, are interpreted as bound variables. The interpretation of (17a) can be rendered as in (17b):

(17)

- a. The girl that Bill saw ———
- b. The girl X such that Bill saw X.

(17b) parallels the bound variable interpretation in (16a) above.

Sells indicates that a resumptive pronoun will appear in the kind of construction exhibited in (17a). That is, in languages with true resumptive pronouns, the pronoun is interpreted like a gap would be, i.e. as a bound variable. In languages devoid of true resumptive pronouns, the pronoun cannot be a bound variable, but it may receive some ‘other’ interpretation different from the interpretation that a gap would receive. Thus, Sells says that in the Hebrew constructions in (13) the pronouns are interpreted as bound variables, whereas in the English examples in (11) the interpretation of the pronouns is the ‘E-type’ interpretation as discussed by Evans (1980). This, however, does not mean that English does not allow pronouns to have the bound variable interpretation.

Consider the following sentences and suppose that (18b) is an acceptable example of a resumptive pronoun and compare this to (18a).

(18)

- a. Every man thinks that Mary likes him.
- b. Every man who Sue thinks that Mary likes him.

In (a), the pronoun is bound to *every man*, therefore may be interpreted as a bound variable. In (a), the pronoun is considered A-bound by *every man*, while in (b) the pronoun is bound by *who* which is in an A'-position, therefore the pronoun is A'-bound. Assuming that both sentences in (18) are instances of variable binding, Sells dubs the A-binding instance anaphoric binding and the A'-binding instance operator binding. Now, it is possible to determine the nature of resumptive pronouns. Notice that the constructions involving operator binding are claimed by Chomsky (1977) to be wh-movement constructions such as relative clauses, questions, topicalizations, clefts, etc. This means that syntactic

gaps (generated in these constructions) are interpreted as operator-bound variables. Sells argues that resumptive pronouns are interpreted as operator-bound variables. In partial conclusion, Sells claims that while all languages allow pronouns to be interpreted as anaphorically-bound variables, only some (those that have resumptive pronouns) allow them to be interpreted as operator-bound variables. Thus, Sells' claim is not that languages lacking resumptive pronouns lack the bound variable interpretation for pronouns in all constructions, but rather that these languages only allow for anaphoric binding.

Chao and Sells (1983), Sells (1984) show that pronouns in English (see the examples in (11)) are not interpreted as operator-bound variables. Thus in the following relative clauses in (19a) allows a gap or a pronoun, while (19b) disallows the pronoun:

(19)

a. I'd like to meet the linguist that Mary couldn't remember if she had seen —/him before.

b. I'd like to meet every linguist that Mary couldn't remember if she had seen — /*him before.

In (19) the head NP of the relative clause is the linguist, whereas in (19b) it is *every linguist*. In (19b), *him* cannot be an bound variable, i.e. it cannot be bound by the quantificational NP *every linguist*, although the gap can be interpreted as a bound variable. In (19a), *him* picks out some individual that happens to be the NP *the linguist*.

The interpretation between *him* and *the linguist* arises as the result of accidental coreference. In view of the contrast between (19a) and (19b), it appears that pronouns cannot be operator-bound in English whereas gaps can.

Chao and Sells (1983), Sells (1984) observe that while (20a), with the gap, seems to allow for an answer that includes more than one individual, (20b), while the pronoun, does not:

(20)

a. Which of the linguists do you think that if Mary marries — then everyone will be happy?

b. Which of the linguists do you think that if Mary marries then everyone will be happy?

(20a) seems to allow the answer “Dave, or Dan, or Don...”, while in (20b), the pronoun refers to some individual and is not bound by the wh-phrase in any direct way. Whereas the gap in (20a) may receive the bound variable interpretation, the pronoun in (20b) may not.

The third argument that Chao and Sells (1983) and Sells (1984) give to show that pronouns in English are not interpreted as operator-bound variables also involves questions. In the two answers shown in (21), the relational answer is contrasted with the ‘individual’ answer:

(21)

Which woman_i does no Englishman_j believe —_i will make a good wife?

—— the one his_j mother likes best (relational).

—— Saucy Sue (individual)

Chao and Sells indicate that in the relational interpretation, *no Englishman* takes scope over *which woman*, so that the answer varies with *each Englishman* that the question is evaluated with respect to. In the individual reading, *which woman* has widest scope, so that the answer is *a woman* constant across *all Englishmen*. In the relational and individual readings, the gap is interpreted as an operator-bound variable. Now, if the gap in question is replaced by a pronoun, the relational answer becomes inappropriate:

(22)

Which woman_i does no Englishman_j even wonder whether she_i will make a good wife?

———_i the one his_j mother likes best (relational).

——— Sancy Sue (individual).

The fact that the relational reading is ruled out suggests that *which woman* takes scope over *no Englishman* and the pronoun *she* picks up some individual *woman* in the external world.

Grosso, it seems to be the case that in English pronouns and gaps behave differently with respect to operator-binding. Gaps can be interpreted as operator-bound variables whereas pronouns cannot. Chao and Sells's proposal is that in languages endowed with the resumptive pronoun strategy, resumptive pronouns can be interpreted as gaps (i.e. as operator-bound variables), while in languages that lack the resumptive strategy pronouns may not be interpreted as gaps in wh-constructions.

Above, we saw that a language such as English shows a difference in interpretation between gaps and pronouns. However, a language such as Hebrew shows no difference in interpretation between gaps and pronouns, as illustrated by the following example:

(23)

Kol gever se Dina xosevet se hu ohevet Rina

every man that Dina thinks that he loves Rina

'Every man that Dina thinks loves Rina'

Notice that the pronoun version of the English (19b) is ungrammatical while the Hebrew (23) is grammatical. The grammaticality of (23) is expected if the pronoun *hu* in (23) is operator-bound (by the first *se*), and the pronoun is therefore behaving just like a gap would.

In Tuki too, there seems to be no difference in interpretation between gaps and pronouns:

(24)

a. [mutu óngima] ódzu_i Mbárá a- bungánám ée ómwéné_i a- mú-dingám Putá

man all who Mbara SM thinks that he SM OM loves Puta

'Every man that Mbara thinks that he loves Puta'

b. [mutu óngima] ódzu_i Mbárá a- bungánám ée ec_i a-mú-dingám Putá

man all who Mbara SM thinks that he SM OM loves Puta
 ‘Every man that Mbara thinks that loves Puta’

In contrast to the Tuki construction exhibited in (a) above, the English sentence exhibited in (19b) dislikes the use of a pronoun and prefers a gap. It appears from this little paradigm that in Tuki, pronouns behave like A'-bound gaps, whereas in English the opposite seems to obtain. This seems to suggest that resumptive pronouns are pronouns that are bound by an operator. And while Tuki licenses the use of resumptive pronouns, English does not. Following Sells (1984), we will adopt the following working definition of resumptive pronouns:

(25)

A resumptive pronoun is a pronoun that is interpreted as a bound variable whose antecedent is an operator. In other words, a resumptive pronoun is a pronoun that appears in wh-constructions and it receives the interpretation that a gap would normally receive. That is, a resumptive pronoun is a pronoun that is interpreted as a variable bound by an operator.

8.3.1 Wh-questions

Syntactic wh-movement in Tuki is optional. We are primarily concerned with wh-elements that are apparently moved from object position to A'-bar positions.

Consider the following questions:

(26)

a. *ándzu*_i [ĩngbéme y-unám ec_i]

who lion SM kill

‘Who does the lion kill?’

b. *ándzu*_i [ĩngbéme i—mú- nám omwéne_i/ ec_i]

who_i lion SM OM kill him_i

‘Who does the lion kill him?’

In (26), the wh-word *ándzu* ‘who’ which is [+human] can be associated either with a gap or a resumptive pronoun. In contrast, the wh-word *ǎte* ‘what’ which is [-human] can only be associated with an ec below:

(27)

*ǎte*_i [okutu a Mbárá a- nambám ec_i]

what woman of Mbara SM cook

‘What does Mbara’s wife cook?’

Notice that an alternation between an overt resumptive pronoun and a gap is possible in (26b). We will assume throughout that *mú-* is an object agreement marker which identifies a pro in argument position and that the possible gap (ec_i) in (26) and (27) is an instance of A'-bound pro. Before we

proceed, we would like to emphasize that the presence of an object marker is not required when an element in A'-position binds the direct object NP.

The contrast in behavior between *ándzu* 'who' and *áte* 'what' with respect to the generation of resumptive pronouns will become crucial when we look at island phenomena in Tuki in a subsequent section.

8.3.2. Relativization

8.3.2.1. Headed relative clauses

In Tuki headed relative clauses, the head of the relative clause can be associated either with a resumptive pronoun or an ec:

(28)

a. [Ókutu] odzu_i Mbárá a- má- mú-băna ómwéné_i
 woman whom Mbara SM P2 OM married her

'The woman whom Mbara married her'

b. [Okutu] ódzu_i Mbárá a- má-mu-băna ec_i
 woman whom Mbara SM P2 OM married

'The woman whom Mbara married'

It is possible to relativize into an embedded relative clause (29) and an embedded question (30). This constitutes palpable evidence that apparent CNPC violations (involving or not involving gaps) can be analyzed as resumptive pronoun binding cases, and therefore avoid being true island violations.

(29)

a. [Okutu odzu]_i [CPodzu_i [IPMbárá ĩ-dzímam [mutu [odzu a- ma-mú-nóbá ómwéné_i]]]]
 woman this whom Mbara SM knows man who SM P2 OM beat her

'The woman who Mbara knows the man who beat her'

b. [Ókutu ódzu]_i [CPodzu_i [IPMbárá ĩ-dzímam [NPmutu [CPodzu [IPa- má-mú-nóbá ec_i]]]]]]
 woman this whom Mbara SM knows man who SM P2 OM beat

'The woman whom Mbara knows the man who beat'

(30)

a. [Ókutu ódzu]_i [CPodzu_i [IPMbárá a-kambím [FPandzú [IPa-má-mú-beráana ómwéné_i]]]]
 woman this whom Mbara SM wonders who SM P2 OM call her

'The woman that Mbara wonders who called her'

b. [Ókutu ódzu]_i [CP odzu_i [IP Mbárá a-kambím [FP andzú [IPa-má- mú-berana ec_i]]]]
 woman this whom Mbara SM wonders who SM P2 OM call

‘The woman that Mbara wonders who called’

Notice that in the above constructions and in the subsequent ones, wh-question phrases and so called relative pronouns occupy different functional projections: extracted wh-words in content questions substitute to FP whereas wh-items in relative clauses land in RelP. This is in agreement with the system devised in chapter eleven. Assuming that the derivation of relative clauses is an instantiation of the Rule Move Alpha, Tuki relative clauses avoid being Subjacency violations because they are cases of resumptive pronoun binding:

(31)

a. [mutu<sub>[CPódzu_i[IPMbará a- m- údza<sub>[NP mǎru áamá<sub>[CPée<sub>[IP Putá a- m- úna ec_i]]]]]]]]]
man whom Mbara SM P2 tell story this that Puta SM P2 kill
‘The man who Mbara told the story that Puta killed’</sub></sub></sub></sub>

b. tévére<sub>[CPódzu_i[IP Mbará a- m- údza<sub>[NP mǎru áamá<sub>[CPée<sub>[IP Putá a- m(u)- ófa ec_i]]]]]]]]]
table which Mbara SM-P2 tell story this that Puta SM P1 throw
‘The table that Mbara told the story that Puta threw away’</sub></sub></sub></sub>

So the CNPC violations are avoided irrespective of whether the position relativized can be associated with a resumptive pronoun or a variable. In (31b) for instance, since *tévére* ‘table’ is [-human], the position it has vacated cannot be filled with a resumptive pronoun. Nevertheless, the position violates the CNPC without any ungrammaticality resulting. We will come back to the problem of island violations in the next section. We will assume that Tuki relative clauses have the following structure:

(32)

[NP [RelP_i [IP.... resumptive pronoun_i or [e]_i...]]] (for details see chapter 11)

The relation between the head (NP) and the operator in RelP is one of coindexing (Chomsky 1982).

8.3.2.2 Free Relatives

In free relatives as well as in other Tuki wh-constructions, the resumptive pronoun may appear only when the position associated with it carries the feature [+human]. Thus, if the relativized position is [-human], the resumptive pronoun may not appear. In other words, since there is no overt pro form for [-human] NP, thus the “relativized NP [-human]” position must be empty:

(33)

a. ate_i Mbárá a- dingám éé ómwéné a- kusa [e]_i i- diyám
what Mbara SM loves that he SM buys SM expensive
“What Mbara wants to buy is expensive”

b. Putá a- m(ú)-éna ate_i Mbárá a- dingám éé ómwéné a-kusa [e]_i
Putá SM P1 see what Mbara SM loves that he SM buys
‘Putá saw what Mbara wants to buy’

8.3.3. Summary of section 8.3.

In this section, we have seen that the head of the relative clause, when it is [+human], can be associated either with a resumptive pronoun or a gap. The resumptive pronoun may not appear if the head of the relative clause is [-human]. However, irrespective of the presence/absence of the resumptive pronoun, relativization in Tuki seems to constitute a case of resumptive pronoun binding since Subjacency is freely violated. Following most current generative analyses stemming from the work of Chomsky (1977, 1981, 1982), the gapped examples introduced above would be analyzed as instances of ‘Move Alpha’ leaving a variable (the trace left by wh-movement). Such an analysis disallows movement from island environments. While it is not surprising to find that the resumptive pronoun strategy illustrated above violates island constraints (Chomsky 1982, Georgopoulos 1985), the same result is unexpected under a variable analysis of the gapped examples. Nevertheless under the movement analysis, Tuki allows such apparent violations, as is illustrated in the next section again for the CNPC, the Wh-island Constraint, the Constraint on Extraction Domain (CED), and the Sentential Subject Constraint.

8.4 Island Environments

In this section, we consider the island environments in Tuki.

Chomsky (1977) has subsumed Ross’s (1967) island constraints under the Subjacency Condition. Subjacency prohibits movement from island configurations. For illustration, consider the following English construction:

(34)

*Here is the car which_i [_{IP} Betty does not know [_{NP} the car dealer [_{CP} who [_{IP} sold x_i]]]]

(35)

*It is my mother whom_i [_{IP} I do not know [_{CP} what_j [_{IP} my father gave x_i x_j]]]

(36)

*It is this food which_i before touching x_i, you must wash your hands.

(34) violates the complex NP constraint while (35) violates the Wh-Island constraint. (36) violates the Condition on Extraction Domain (Huang 1982) which has been subsumed by Subjacency (Chomsky 1986).

Now, consider the following Tuki sentences:

(37)

a. ĭ-mú[káráte ódzu] odzu_i [_{IP} nŭ ngi-ĩdzĩmam [_{NP} mutu [_{CP} odzu [_{IP} a-má-tomena ec_i ĭya
It is book this that I SM know man who SM P2 send mother
ame]]]]

my.

‘It is this book that I know the man who send...to my mother’

c. ĭ-mú[ĭya ame]odzu_i [_{IP} Nŭ nga-ti-ĩdzĩma [_{FP} áte [_{IP} ómwéné_i/ec_i a-nú-nambám
It is mother my who I SM Neg know what she/x SM F1 cook
anenga aye]]]

evening this

‘It is my mother whom I don’t know what (she) will cook this evening’

In (37a), the focused NP *káráte odzu* ‘this book’ is associated with an [ec] inside a relative clause. In (37b), the focused NP *ĭya ame* ‘my mother’ is associated with an [ec] over the wh-element *ate* ‘what’. If indeed extraction has occurred in the above constructions, one would expect them to violate Subjacency. However, the constructions are grammatical. The (a) sentence should violate the Complex Noun Phrase Constraint and the (b) sentence should violate the Wh-island constraint. In the following sentence, an [ec] occurs inside an adverbial clause:

(38)

i mú[manyá áamá]ama_i avan dze mámú o-timbíta ec_i, mámú o-yánám o-suwa amboo It-is food
this that before that you SM touch you SM must inf.marker wash hands

roo

your

‘It is this food that before you touch..., you must wash your hands’

(38) violates the CED (Huang 1982), and the data introduced so far appears to indicate that Tuki allows island violations. Tuki seems also to differ from other languages that violate certain island constraints. Rizzi (1982) shows that in Italian, it is possible to extract from embedded questions while extraction from relative clauses is strictly prohibited; Rizzi then claims that the bounding node in Italian is S’ (CP) rather than S (IP). Huang (1982) indicates that extraction from adjuncts is disallowed since they are not properly governed. Having just seen that Tuki violates the CNPC, the Wh-Island constraint

and the CED, it seems appropriate to suggest that gaps in Tuki should not be analyzed as variables left by ‘Move Alpha’, but rather as null resumptive pronouns which do not involve movement, on analogy with the full resumptive pronoun strategy illustrated in the examples above. Further evidence for a parallelism between gaps and full resumptive pronouns is provided by the fact that it is possible to conjoin a clause containing a full resumptive pronoun and a clause containing a gap:

(39)

[_{IP}Mbárá a-sésám[_{FP} ǎndzu_i[_{IP}Putá a- dingám ec_i ká[_{IP}Tsimi a mú-benám omwéné_i]]]]

Mbara SM asks who Puta SM loves then Tsimi SM OM hates him

‘Mbara asks who Puta loves and Tsimi hates him’

We assume that in the above sentence, the gap (ec_i) and the pronoun *ómwénéé* are A’-bound pronominals.

We will come back to coordination in section 8.

Assuming that apparent violations of Subjacency in Tuki do not involve trace-binding, it seems appropriate to elaborate on what a non-movement analysis of the constructions illustrated above would mean for the grammar. If indeed these constructions are not derived by wh-movement, how did the wh-phrases reach their surface structure positions? It is plausible to posit that wh-phrases are base-generated in FP and RelP in Tuki constructions involving resumptive pronoun binding. They are base-generated in FP position when the constructions that contain them are content questions. They are base-generated in RelP position when they occur in relative clauses. The possibility that wh-phrases can be base-generated in A’-position is raised in Chomsky (1982). If wh-items could move to FP in Tuki and leave traces that could optionally be spelled out as overt resumptive pronouns (as in Egyptian Arabic), we would expect the language to obey Bounding Theory. However, this is not the case. We conclude that wh-constructions examined so far involve resumptive pronoun binding and wh-phrases are base-generated in FP and RelP position.

8.5 Weak Crossover at S-structure

Overt resumptive pronouns do not exhibit weak crossover effects in Tuki.

(40)

a. ǎndzu_i [nǒsi wáá_i] [a- mú- dingám omwéné_i

who mother his SM OM loves him

‘Who does his mother loves him?’

b. ándzu_i [okutu [ódzu_j a- dingám ec]]a- mú- benam omwéné_i

who woman whom SM loves SM OM hates him

‘ Who does the woman whom he loves hates him?’

Likewise, sentences containing gaps fail to exhibit weak crossover effects, providing further evidence that these gaps are pronominals not variables. On the contrary, in Hebrew, the presence of a gap disqualifies the construction and therefore exhibits weak-cross over effects. Let us consider the following examples:

(41) Tuki

a. $\check{a}ndzu_i$ [n \check{o} si w \acute{a} \acute{a} $_i$] [a- m \acute{u} - d $\acute{i}ng\acute{a}m$ ec_i]
 who mother his SM OM loves

‘Who does his mother love?’

b. $\acute{a}ndzu_i$ [okutu [o $\acute{d}zu_j$ a- m \acute{u} -d $\acute{i}ng\acute{a}m$ ec_j]] a- mu-benam ec_i
 who woman whom SM OM loves SM OM hates

‘Who does the woman whom he loves hates?’

(41’) Hebrew

a. *? Ze ha-baxur $\check{S}e-$ yida $\check{f}ti$ ζ et ha-horim $\check{S}el-o_i$ $\check{S}e$ -ha-more yaxil t_i
 this the-guy that- (I) informed-Acc the parents of-him that the-teacher will flunk

‘‘This is the guy that I informed his parents that the teacher will flunk’’

b. Ze ha-baxur $\check{S}e-$ yida $\check{f}ti$ ζ et ha-horim $\check{S}el-o_i$ $\check{S}e$ -ha-more yaxil ζ oto $_i$

this the-guy that- (I) informed-Acc the parents of-him that the-teacher will flunk him $_i$

‘‘This is the guy that I informed his parents that the teacher will flunk him’’

The above constructions clearly show that Tuki, as opposed to Hebrew, does not exhibit WCO effects in relative clauses (41b vs 41’a) and in wh-movement even if there is no resumptive pronoun. WCO effects arise in Hebrew relative clauses in which the variable is a trace rather than a resumptive. Illicitness is only attained if there is a resumptive pronoun which stands as a variable or in a derivation in which the NP-internal possessive pronoun (*his* in *his parents*) is taken to be the bound variable and the second pronoun (*him*) is coreferential with *it* (41’b). With regard to the above data, we can contend that resumptive pronouns in Hebrew are used as a last resort strategy i.e. a strategy without which there is no grammaticality. (Shlonsky 1992: 443-448).

On analogy with their English counterparts, the sentences in (41a-b) should be ruled out by the Bijection Principle (Koopman and Sportiche 1982) or the Leftness Condition (Chomsky 1976; Higginbotham 1980):

(42)

The Bijection Principle (BP)

a. Weak half: A quantifier can bind only one variable (Violation results in semigrammaticality)

b. Strong half: A quantifier must bind a variable (Violation results in ungrammaticality)

The Leftness Condition states that a pronoun cannot be coindexed with a variable to its right. The fact that the constructions in (41) are licit seems to imply that the gaps are non-overt pronouns which may be phonetically realized when the position they are associated with is [+human]. Sentences such as (41) have important consequences for Safir's (1984, 1986) Parallelism Constraint on Operator Binding (PCOB):

(43)

Parallelism Constraint on Operator Binding (PCOB)

If one local A'-bindee of O is [a. lexical] and [b. pronominal], then all local bindees of O must be [a. lexical] or [b. pronominal].

Safir's constraint rules out constructions in which a single operator binds two variables, one of which is a trace and the other a pronominal. Since we have argued that gaps in the above weak crossover configurations are non-overt resumptive pronouns, it is plausible to suggest that all local A'-bindees of the operator *ǎndzu* 'who' are [+pronominal]. If this argumentation proves to be accurate, both types of Tuki bindee would bear the feature [+pronominal], although one is overt and the other may be phonetically unrealized. If we compare how the PCOB and the BP fare with regard to the Tuki facts discussed, it seems quite evident that the PCOB is more successful in handling them. We will show in section 10 the correlation between the absence of resumptive pronouns at LF and the occurrence of weak crossover effects at that level of representation. Since the PCOB, unlike the BP, is sensitive to the pronominal nature of the empty category corresponding to the wh-item in an A'-position at S-structure, it is better equipped to handle WCO facts in Tuki. The 'mixed' coordinations and weak crossover violations found in Tuki obtain in other languages. Sells (1984b) observes that the 'mixed' coordinations and weak crossover violations are possible with resumptive pronouns even in languages which have ec gaps, like Swedish and Hebrew. Consider for instance the following Hebrew conjoined structures (from Sells 1984):

(44)

a. ha' is sei rina [VP roca--]ve [VP ohevet oto_iyoter mikulam]

the man who Rina wants and loves him more than anyone

b.kol professor se_idani [VP roce le hazmin----] aval [VP lo maarix otoi maspik]

every professor who Dani wants to-invite but not esteems him enough

The above Hebrew constructions are similar to the Tuki empirical material in that there is an empty category in one conjunct and a resumptive pronoun in the other and Sells argues that the gaps in these

constructions are non-overt resumptive pronouns. Similar phenomena are observed in Palauan (see Georgopoulos 1983,1984, 1985 for details). It seems to be then the case that the basic resumptive pronoun facts of Tuki do not constitute an isolated case in linguistic theory.

8.6. Anaphoric Binding

The claim that resumptive pronouns are syntactically bound is further supported by the analysis of anaphoric binding in the language. In Tuki, a lexical anaphor cannot precede the NP with which it is coindexed, as illustrated by the ungrammaticality of the following sentence:

(45)

*[okutu wáámate;_i]_j udzám ée [e]_i Isómo_i a- ta- mú-dingá ómwéné_j
 woman his own says that he/Isomo SM Neg OM love her
 ‘[His own_i wife]_j says that {he_i/Isomo_i} does not love her_j’

In (45) the clause containing the antecedents *[e]/Isomo* is embedded within the clause containing the lexical anaphor *waamate* ‘herself’. Principle A of the Binding Theory (Chomsky 1981) presumably rules out (45) because the anaphoric NP *okutu waamate* ‘his own wife’ is not bound (inside its governing category (the embedded clause)). Irrespective of whether the antecedent is an NP or an empty pronominal, the sentence is illicit.

(46)

*vatu vá-kútú- dzará maru m(á) Isómo_i. [okutu wáámate]_j udzám ée [e]_i a-mú ómbee
 men SM Prog. talk story of Isomo woman his own says that he SM is bad of
 wá ónúmútú
 of husband

‘People were talking about Isomo_i’s problem. [His own_i wife]_j says that he is a bad husband’

In (46) a possible antecedent in the immediately preceding discourse cannot bind a reflexive in the immediately following discourse. However, clause-initial wh-constituents can contain lexical anaphors bound by a following antecedent, as evidenced by the following construction:

(47)

[_{FP}okutu wáámate_i ate]_j [_{IP}o-búngánám [_{CP}ée [_{IP}Isomo a-tá-dzu-mu-dingá omwéne_j/ec?]
 woman his own what SM think that Isomo SM Neg still OM love her
 ‘[Which of his own_i wife]_j you think that Isomo_i no longer loves her_j/ec?’

It could be assumed that binding in (47) is done before wh-movement. Now if we question the subject of the clause containing the lexical anaphor *waamate* ‘his own’ in (45), we obtain a grammatical sentence:

(48)

[okutu wáámate_i ate]_j udzǎm ée[IP Isomo a- ta- mú- dingá ómwéné_j/ec_j?
woman his own what says that Isomo SM Neg OM love her
“[Which of his own_i wives]_j says that Isomo_i does not love her_j/ec_j?”

It is worth comparing the ungrammatical (45) to the grammatical (48). In (48) the resumptive pronoun *ómwéné* ‘her’ or the gap is bound by an anaphor in an A-bar position, which is not the case for (45). The contrast between (45) and (48) is very significant. Above, it was suggested that Principle A of the Binding Theory rules out (45). Since the anaphor is not bound. The same reasoning could apply to (48) because in this construction too, the anaphor occurs in the matrix clause whereas its governing category is the embedded clause. But there is a significant difference between (45) and (48). The lexical anaphor in (48) is contained by a wh-constituent which A’-binds the resumptive pronoun or the gap, which is not the case in (45). Notice that the wh-constituent containing the lexical anaphor in (48) can be reconstructed into the embedded object position. After the reconstruction process, the lexical anaphor can be bound in its governing category. Thus, it could be argued that the binding relation between the NP *Isomo* and *okutu waamate* ‘his own wife’ was established prior to S-structure. At the latter level of representation, the wh-constituent *okutu wáámate ate* ‘which of his own wives’ A’-binds the resumptive pronoun or the gap. In (45), there is no wh-constituent involved, therefore the reconstruction process may not be appealed to. There is thus no way of having the lexical anaphor licitly bound in its governing category. Our argumentation entails that *okutu wáámate ate* ‘which of his own wives’ is located in the embedded object position at D-structure. If that is the case, then what occupies the matrix subject position? Given the Extended Projection Principle, sentences must have subjects at all levels of representation. We contend that this is not a problem for Tuki since it is a null subject language; that is, an empty category is possible in subject position at all levels of representation. Thus assume that in the D-structure of (48), the subject position, which is a theta-position, is occupied by an expletive *pro* (just like the expletive *pro* that occurs in Italian inversion construction) and the embedded object position is occupied by *okutu wáámate ate* ‘which of his own wives’. Notice that (47) and (48) enjoy the same status of grammaticality, showing that both the resumptive pronoun and the gap can be bound by an item in a non-theta position, and suggesting that the binding relationship between the wh-phrase and the resumptive pronoun/gap has taken place in the syntax. Thus in Tuki, since resumptive pronouns and gaps can be coindexed with a lexical anaphor located in a clause-initial wh-phrase, one can reach the conclusion that Tuki resumptive pronouns are syntactically bound at S-structure.

8.7 Reconstruction and Syntactic Movement

The rule of reconstruction at LF is used to account for binding properties and coreference. Thus reconstruction is appealed to in order to explain the grammaticality of sentences such as these (patterned after Engdahl, 1980)):

(49)

Which of his_i own records does every musician_i like? (Answer: his first one).

In (49) above the pronoun *his* is bound by its antecedent *every musician*, although the pronoun is not c-commanded by the quantifier at S-structure. Binding Theory requires that a pronoun be c-commanded by a quantifier at S-structure, otherwise a bound variable interpretation is disallowed, as evidenced by the illicitness of the following crossover examples:

(50)

a. * Her_i husband hates everyone_i

b. * He_i murdered every woman_i

To analyze sentences such as (50) most researchers assume that the pronoun is inside an A'-position, more specifically the phrase containing the pronoun has been moved to a non-theta position and is linked to a variable in the matrix VP:

(51)

[Which of his_i own records]_j [IP every musician[VP like x_j]]]

For various analyses of the above sentence, see Engdahl (1980), Higginbotham (1980), Weisler (1982). Notice that in (51) the variable x_j is c-commanded by the quantifier *every musician*. Now assume that the reconstruction process precedes the establishment of the c-command relation between the variable and the quantifier. When the phrase in A'-position in (51) is reconstructed to the position of the variable x_j at LF, the c-command requirement on bound pronouns and quantifiers is automatically respected. The sentences exhibited in (50) are ruled out because there is no syntactic binding and no process of reconstruction involved.

Hoji (1985a, 1985b), using the reconstruction analysis, analyses the Japanese *Wa-constructions* in terms of base-generation and syntactic movement. It should be borne in mind that Hoji used 'reconstruction' as a cover term for the phenomena under discussion, which typically involves syntactic movement. Now consider the following sentence:

(52)

John_j-wa[IP Mary-ga[VP---buta]]

(As for John, Mary hit him)

Hoji, following Saito (1985), argues that the *wa-construction* in Japanese are divided in two different ways (see also Saito (1985)). As for the ‘topic’ *wa-construction*, the dislocated phrase is base-generated and is co-indexed to an empty node in the matrix under an ‘aboutness’ relation. The ‘contrastive’ *wa-phrase* (requiring heavy stress in the case of NP topics) is derived by syntactic movement: the *wa-phrase* is fronted into a dislocated position. Since the two *wa-constructions* are derived differently, it is predicted by Hoji that the binding properties of anaphors and pronouns in both constructions would differ: the base-generated *wa-phrase* is not expected to reconstruct whereas the syntactically moved *wa-phrase* is expected to.

In the next subsection, a summary of Hoji’s analysis of variable binding in the *wa-construction* is presented. In the second subsection, we will consider reconstruction with regard to Tuki in order to decide whether syntactic movement is involved in Tuki reconstruction.

8.7.1 Movement and Variable Binding in Japanese

Consider the following *wa-constructions* discussed by Hoji (1985b):

(53)

*[_{NP}[_{IP} e_i sono mise-de hitome e mita] hito]_j-wa daremo_i-ga sukini natta]]
 that store at one glance saw person-topic everyone fell in love
 [As for [the person that he_i saw in that store]_j, everyone_i fell in love with him_j]

(54)

*[_{NP}[_{IP} e_i butta] hito]_j-wa dare_i-ga uttaeta no]
 hit person-topic who sued
 (As for[the person who hit him_i]_j who_i sued him_j)

The above sentences, as indicated, are ungrammatical since the binding between the quantifiers *daremo-ga* ‘everyone’ and *dare-ga* ‘who’ and their variables is illicit. If the *wa-phrases* are reconstructed inside the matrix, the sentences contrary to facts would be provided with a licit derivation. Hoji (1985b) therefore draws the conclusion that since the *wa-phrases* are not fronted by syntactic movement, they are not subject to reconstruction. The above two sentences are assigned the following structures. (55) is the structure of (53) while (56) represents (54):

(55)

[[...e_i...]_j-wa [IP QP-ga [VP e_j V]]

(56)

[IP [...e_i...]-wa_j[IP QP -ga [VP t_j V]]] (Hoji1985b)

e_i in (55) is understood as the empty pronominal which the topic phrase binds; t_j in (56) is a trace of movement. Hoji argues that there is a correlation between the choice of the trace or the empty pronominal with the availability or the unavailability of reconstruction effects: sentences exhibiting syntactic movement allow reconstruction whereas those exhibiting base-generation fail to do so. Consider the following two sentences:

(57)

a. *[NP Sono zibun_i nituite-no hon]_j-wa John_i-ga suteta]
 that self about book-topic John-topic threw away

(As for [that book about himself]_j, John threw it_j away)

b. [IP [NP Sono zibun_i nituite-no hon]-o]_j [John_i-ga [VP t_j suteta]]] (koto)
 that self about book-acc. threw away about

(That book about himself_i, John_i threw away)

In (57a) the *wa*-phrase is base-generated, reconstruction is therefore prohibited. In (57b), the *o*-phrase has been moved in syntax and reconstruction is possible. The *o*-phrase is lowered at LF into the position of its co-indexed trace before the c-command requirement applies. At LF after reconstruction, the lexical anaphor *zibun* is c-commanded by its antecedent *John-ga*

The following sentences illustrate an interesting contrast:

(58) NP-wa construction

Peking_j-wa John-ga [NP [IP e_i e_j yoku siteiru] hitoi-o Peking sagasiteru]
 Peking well knows person is looking for
 ‘As for Peking, John is looking for a person who knows (about) it well’

(59) PP-wa construction

*Pekin-ni-wa_j John-ga [NP [IP e_i e_j nandomo itta] hitoi-o sagasiteiru]
 Peking many times went person is looking for
 ‘To Peking, John is looking for a person who has been there often’

(60) O-construction

*Pekin-o_j [IP John-ga [NP[CP e_i t_j yoku sitteiru] hitoi]-o sagasiteiru.
 Peking well knows person is looking for
 ‘Peking, John is looking for a person who knows well’

Saito (1985) accounts for the ungrammaticality of (60) by claiming that the moved *o*-phrase has crossed NP and CP which are bounding nodes in Japanese. The ungrammaticality of (59) is explained also by appealing to Subjacency. (58) is licit although the NP-*wa* topic binds an empty node inside a syntactic island. There is no Subjacency violation in (58) since the construction is base-generated.

Kuno (1973) dubs the topic in the PP-*wa* construction ‘contrastive’. The topic in the PP-*wa construction* may be rendered as ‘not others but...’ or ‘at least...’. For Kuno, the NP-*wa*-topic is either ‘thematic’ and may be rendered as ‘as for...’ or contrastive. Hoji (1985b) indicates that NP-*wa topics* are assigned a contrastive reading with heavy stress on the *wa*-topic. For illustration, consider the following sentences:

(61) Minako-*wa*[Mamoru-*ga* butta]

Hit

(62) a. As for Minako, Mamoru hit (her)

b. Mamoru hit Minako (as opposed to other people)

(61) means (62a) with normal intonation whereas (61) means (62b) with heavy stress on the *wa*-topic. PP-*wa constructions*, on the other hand, can only receive a contrastive reading irrespective of stress assignment according to Hoji (1985):

(63) Pekin-*ni*-*wa* [John-*ga* itta]

Peking-topic went

‘John went to Peking (as opposed to other places.)’

Hoji (1985b) argues that fronted PP-*wa topics* are generated by movement (cf. Saito 1985) and receive a contrastive reading; constructions with initial NP-*wa topics*, however, are derived in two different ways: with heavy stress, they are fronted, receiving thereby contrastive readings, with normal intonation they are generated at the base being assigned thereby thematic readings. Since there seems to be a correlation between movement and reconstruction, it is expected that fronted NP-*wa*-topic with heavy stress and contrastive interpretation should be able to reconstruct. Recall the example (57a) (repeated here as (64) for convenience):

(64) [*NP Sono zibum_i nituite-no hon]_j-*wa* John_i-suteta

that self about book-topic John-nom threw away

‘As for [that book about himself]_j, John threw it away’

As indicated, the above sentence is ungrammatical with normal stress. Hoji (1985b) points out that the sentence becomes grammatical with heavy stress on the *wa*-phrase. Heavy intonation on the topic phrase explains the movement analysis of the grammatical version of (57a) or (64). On these terms, the grammatical version of (57a) or (64) is subject to reconstruction, suggesting thereby that the correlation between movement and reconstruction may be valid.

8.7.2. Movement and Variable Binding in Tuki

In this subsection we consider the correlation between movement and reconstruction with respect to Tuki. One natural conclusion that could be drawn from the discussion in the preceding sections about *wh*-constructions in Tuki is that those constructions do not involve movement. To see whether the

constructions under consideration involve movement, it is important to look at ‘reconstruction’ or ‘syntactic connectedness’. Let us consider the following sentences:

(65) mwána wáá; ate [okutu óngíma]; a-dingám?
 child her what woman every SM loves

‘Which of heri children does every womani love?’ (Answer: her first one).

A bound variable reading is allowed between *okutu óngíma* ‘every woman’ and *wáá* ‘her’ in the above sentence in spite of the fact that the antecedent does not c-command the bindee at S-structure. That the c-command requirement on bound variable reading must in general be respected is illustrated by the following ungrammatical sentences in Tuki (see also section 9).

(66) a. *[mwána wáá; a-benám [mutu óngíma];
 child his SM hates man every

‘*His child_i hates everyone_i’

b. * pro_i a- m(u)-úna [onumutu ongíma];

‘(she) SM P1 kill husband every’

‘*She_i killed every husband_i’

If the correlation between movement and reconstruction is valid as suggested in the previous subsection, then (64) is an instance of syntactic movement. The latter being subject to Bounding Theory, reconstruction in Tuki should be impossible out of island environments:

(67)

a. [mwána wáá; ate] [okutu óngíma] ootom máru ama éé visimbi ví- m(u)-úna
 child her what woman every agrees story this that police SM P1 kill

‘Which of heri children does every womani believe the story that soldiers killed?’

b. [mbwá ráá; ate] [mutu óngíma]; ídzimam táné Mbárá a- má-kusa
 dog his what man every knows where Mbara SM P2 buy

‘Which of his dogs does everyone know where Mbara bought’

(67a) is a violation of the Complex Noun Phrase Constraint whereas (67b) violates the Wh-island Constraint. These violations are accounted for if we simply assume that the resumptive pronoun strategy is operative in (67a-b). Thus the grammatical (67a) has the same status of acceptability as (68) below:

(68)

[mwána wáá; ate][okutu óngíma]ootom máru ama éé visimbi ví- m(ú)-mú-úna
 child her what woman every agrees story this that police SM P1 OM kill
 ómwéné_i

him

‘Which of her_i children does every woman_i believe the story that soldiers killed him?’

Note that in the above sentence, the resumptive pronoun *ómwéné* ‘him’ is ‘bound’ by the bindee of the quantifier phrase *okutu óngíma* ‘every woman’ namely *wáá* ‘her’. The island violation is therefore expected. In (67b) the noun phrase *mbwá ráá* ‘his dog’ is non-human, therefore it cannot be associated with a full resumptive pronoun (see section 3). The licitness of the sentence suggests that *ráá* ‘his’ is co-indexed with a null resumptive pronoun. Assuming then that the above constructions contain resumptive pronouns (null or overt), we can conclude that wh-phrases are base-generated in FP (focus phrase) position above (in the spirit of Chomsky 1982) and that these constructions are not derived via syntactic movement. But the question remains as to why the Tuki facts cannot be equated to the *wa-construction* in (52) above in Japanese? Recall that in Tuki, pronouns are co-indexed at S-structure. In the Japanese sentence (52), the *wa*-phrase is not fronted by Move Alpha but rather it is base-generated. The relationship that ‘links’ the *wa-phrase* and the gap in (52) is therefore an aboutness relationship. It seems to be the case that this aboutness relationship is sanctioned at a level beyond LF but not S-structure. This might tentatively explain some difference between Tuki and Japanese.

To sum up our discussion, the correlation between movement and syntactic connectedness seems to be at stake in view of the Tuki empirical material. Now, notice that in the constructions examined here, the supposedly extracted element was an argument. And resumptive pronouns (null or overt) occupy the extraction site in these constructions. We have assumed throughout that in A’-constructions involving resumptive pronouns, no syntactic movement is involved, rather wh-phrases are base-generated in clause-initial position. It is, however, possible to devise examples in which there has been genuine syntactic wh-movement. The following sentences are instances of short pied-piping and constitute genuine syntactic wh-movement.

- (69) a. [na mwana waa ate]_i okutu a-kutu- dzara x_i
to child her what woman SM Prog. talk
‘[To which of her child]_i a woman is talking x_i’
b. [na vána váá ate]_i Mbara a- má-náfena x_i
with children his what Mbara SM P2 fight
‘[With which of his children]_i Mbara fought x_i’

To verify that the above constructions are genuine wh-movement sentences, notice that pied-piping is impossible over a complex noun phrase and a wh-island:

(70)

- a. * $[na\ mwána\ wáá\ ate]_j [okutu\ ongíma]_i$ otaom maru ama éé visimbi ví- má-dzára x_j
to child her what woman every agrees story this that soldiers SM P2 talk
‘*To which of her_i children_j] does every woman_i believe the story that soldiers talked x_j ?’
- b. * $[na\ mwána\ wáá_i\ ate] [okutu\ ongíma]_i$ idzimám táné Mbárá a-má-náfena x_j
with child her what woman all knows where Mbara SM P2 fight
‘*[With which of her_i children_j] does every_i woman know where Mbara fought x_j ?’

The illicitness of the above constructions is accounted for under the assumption that syntactic wh-raising out of a complex noun phrase or a wh-island violates Subjacency. As stated above, if the alleged correlation between movement and reconstruction holds, reconstruction should be able to take place out of island environments. The above constructions seem to indicate that reconstruction is impossible out of island contexts, providing thereby evidence that the correlation between reconstruction and movement is valid.

Next we try to determine whether Subjacency is a condition on representations or a condition on movement. Before we do that, we determine the conditions under which Subjacency is not respected in Tuki and Egyptian Arabic, two languages that seem to use resumptive pronouns to circumvent bounding effects.

8.7.3. Subjacency: Condition on Movement or Representations?

8.7.3.1. Subjacency in Tuki Syntax

Above, it was argued that apparent violations of Bounding Theory in Tuki do not involve trace-binding but involve resumptive-pronoun-binding, and wh-phrases are base-generated in FP (Focus Phrase) position in those cases. In the following section, it is shown that Tuki constructions in which resumptive pronouns are not involved obey Subjacency. There are essentially two cases where Subjacency violations cannot be rescued due to the obligatory absence of resumptive pronouns (overt or non-overt): pied-piping structures and syntactic movement of adjuncts. Consider the following example:

(71)

$[IP\ Mbárá\ a-\ m(u)-\ údza]_{NP}\ maru\ ama\ [CP\ éé\ [IP\ Putá\ a-\ m(u)-\ údzara\ na\ ane]]_{FP}$
Mbara SM P1 tell story this that Puta SM P1 talk to who
‘Mbara told the story that Puta talked to who’

If we pied-pipe the prepositional phrase *na ane* ‘to whom’, the above sentence becomes ungrammatical:

(72)

* $[FP\ [na\ ane]_i] [IP\ Mbara\ a-\ m(u)-\ udza]_{NP}\ maru\ ama\ [CP\ ee\ [IP\ Puta\ a-\ m(u)-\ udzara\ x_i]]_{FP}]$
‘ $[FP\ [to\ whom]_i [IP\ Mbara\ told\ [NP\ the\ story\ [CP\ that\ [IP\ Puta\ talked\ x_i\]]]]$

The above sentence violates the CNPC. In this case, a resumptive pronoun is not available since the extracted element is a prepositional phrase. Notice that if the extracted element had been *ane* ‘who(m)’ only, then the presence of a resumptive pronoun would have been mandatory in order to salvage the sentence (preposition stranding is disallowed):

(73)

[_{FP}ane]_i[_{IP}Mbárá a- m(u)- údza[_{NP} maru ama[_{CP}éé[_{IP} Putá a- m(u)-údzara na*(a_i)]]]]
 *[_{FP} [na ane]_i [_{IP} Mbárá a-kambím [_{FP} ǎndzu [_{IP} a- má-dzara x_i]]]]

It is impossible to pied-pipe over a wh-island in Tuki:

(74)

to whom Mbara SM wonders who SM P2 talk
 ‘To whom_i Mbara wonders who talked x_i’s:

(74) is a wh-island violation. In view of (72) and (73), we can establish that NP and IP are in Tuki. The movement of adjuncts at S-structure exhibits Subjacency effects:

(75)

*[_{FP} táne_i [_{IP} Mbárá a- m(u)- éna [_{NP} manyá [_{CP} ama [_{IP} Putá a- mu- wáá x_i]]]]]
 Where Mbara SM P1 see food which Puta SM P1 put
 ‘Where did Mbara see the food which Puta put?’

The extraction of the adjunct *tane* ‘where’ out of a relative clause above violates Subjacency since the spot it has vacated cannot be interpreted as an empty resumptive pronoun. Thus the extraction of an adjunct and pied-piping over islands systematically respect Subjacency. Notice that pied-piping, in fact, is the extraction of the prepositional phrase. It is well-known that prepositional phrases (PPs), in most instances, behave like adjuncts. We can therefore generalize the two cases of Subjacency violations (adjunct extraction and pied-piping) and conclude that adjunct extraction over islands cannot violate Subjacency in this language.

8.7.3.2. Subjacency in Tuki Logical Form

Before it is shown that Bounding Theory obtains at LF in Tuki, let us consider the general properties of wh-in-situ in the language. It is well known that syntactically unmoved wh-phrases are subject to Move Alpha at LF (Huang 1982). Thus the constructions exhibited in (75) will have the LF representations in (76):

(76) a. Mbárá a-nyám ate?

Mbara SM eats what

- ‘Mbara eats what?’
 b. Mbárá endám tane?
 Mbara goes where
 ‘Mbara goes where?’
 (77) a. ate_i [Dimá a-nyám _i?]
 ‘what Dima SM eat
 ‘What does Dima eat?’
 b. tane_i [Dima endám x_i ?]
 where Dima goes
 ‘Where does Dima go?’

Notice that the LF representations in (77) have exactly the structures that the sentences in (76) would have if Move Alpha had applied at S-structure. Recall that Tuki has syntactic wh-movement. Thus the following examples are perfectly grammatical:

- (78) a. ate [Dima a-nyám?]
 what Dima SM eat
 ‘What does Dima eat?’
 b. tane [Dima endám]
 where Dima goes
 ‘Where does Dima go?’

Notice that the LF representations in (77) and the S-structure constructions in (78) are superficially similar: the traces which occupy an argument position are A'-bound by the wh-words in CP. The scope of extracted wh-elements at LF and in the Syntax is structurally defined as follows:

- (79) Alpha is in the scope of Beta if Beta c-commands Alpha.
 (80) X c-commands Y if and only if the first branching node dominating X dominates Y
 (Reinhart, 1976)

According to May and Higginbotham (1981), LF and S-structure differ in one fundamental respect. COMP at LF can be multiply filled because there exists at that level of representation a rule of absorption that has the effect of turning any number of operators into a single complex operator, thus complying with the condition on proper binding that basically requires empty categories to be c-commanded by their antecedents. After these preliminary remarks, let us now turn to the syntax of wh-in-situ in Tuki.

8.7.3.2.1. Scope properties of wh-in-situ in Tuki

The scope properties of wh-phrases in-situ will be discussed here given the assumption that they undergo Wh-movement at LF. Chomsky (1973) indicates that verbs subcategorize for either declarative or interrogative complement clauses. The comp node of the interrogative complement is thereby assigned by the syntactic feature [+wh] and the comp node of the declarative complement is assigned a [-wh]-feature. Now, consider the following Tuki sentences:

(81)

a. Putá a- mu- barafya o- námba ate?

Putá SM P1 forget inf.marker cook what

‘Putá forgot to cook what/‘What did Putá forget to cook?’

b. Putá a-dingám o-tófa táne?

Putá SM likes inf.wash where

‘Putá likes to swim where/ Where does Putá like to swim?’

c. Putá a- mu-sésá Mbárá ée ísa wáá a- m(u)- énda tané

Putá SM P1 ask Mbara that father his SM P1 go where

‘Putá asked Mbara his father went where/ Putá asked Mbara where his father went’

The sentence (81a) is ambiguous since the matrix verb *obarafya* ‘to forget’ can subcategorize for an interrogative or a non-interrogative complement. Assuming the LF Raising of *ate* ‘what’, the two interpretations of (81a) are readily available: *ate* ‘what’ can have a wide scope reading resulting in a direct question interpretation, or it can have a narrow scope interpretation resulting in an indirect question reading. (82a) and (82b) represent the two interpretations of (81a).

(82)

a. [áté_i + wh[Putá a mu- barafya[-wh[o- námba x_i?]]]]

b. [-wh [Putá a- mu-barafya [ate_i [o-namba x_i]]]]

(82b) can have only a direct question interpretation since the verb *o-dinga* ‘to like’ subcategorizes for a non-interrogative complement. Thus, in the following LF representation of (81b), *tane* ‘where’

Will be in the higher comp:

(83) [tane_i Putá a-dingám [-wh[o-tófa x_i]]]

(81b) could receive an answer like:

(84) Putá a-dingam o- tofa n(a) osa

Putá SM likes inf.marker wash in river

‘Putá likes to swim in the river’

In (81c), the matrix verb *osesa* ‘to ask’ subcategorizes for an interrogative complement, therefore *tane* ‘where’ can have only a narrow scope over the embedded clause as in the following LF representation:

(85) [-wh[Putá a mu-sésá Mbárá [táne_i + wh [ĩsa wáá a- mu-énda x_i]]]]

Thus, (81c) has an indirect reading interpretation. *Tane* ‘where’ cannot move to the matrix comp at LF since in that case the selectional requirements of the verb *osesa* ‘to like’ will not be satisfied. The following LF structure will be ruled out since the embedded Comp will not be filled by a [+wh] element:

(86)

[tane_i [Putá a- mu- sésá Mbárá [o- + wh[ĩsa wáá a- mu énda X_i]]]]

To account for the fact that the selectional needs of the verb *osesa* ‘to ask’ must be satisfied at LF above, one can stipulate that Aoun, Hornstein and Sportiche’s requirement that every [+wh] Comp be filled with a [+wh] item must be satisfied at LF too. We believe that May (1985) has argued that the above mentioned filter should apply at LF. We saw earlier that Aoun, Hornstein and Sportiche’s filter does not apply in Tuki and other languages at S-structure. The facts of sentence (81c) seem to indicate that if that filter does not apply at S-structure, it obligatorily applies at LF. So for languages like Tuki, Duala, let us adopt the following criterion (cf. May, 1985, Wahba, 1984) which would apply at LF.

(87) The Wh-Criterion

- a. Every [+wh] Comp must contain a wh-phrase.
- b. Every wh-phrase must move to a [+wh] Comp.

(87b) does not hold at S-structure in Tuki, it does hold at LF as we just saw. Notice that the subcategorization facts of (81) are almost identical to English facts:

(88)

- a. Betty forgot to cook what?
- b. What did Betty forget to cook?

(89)

- a. Where does Betty like to swim?
- b. *Betty likes where to swim?

(90)

- a. Betty asked Bill where his father went.
- b. *Where did Betty ask Bill his father went?

Wahba (1984) reports that the same facts obtain in Egyptian Arabic. Tuki seems to pattern pretty much with Egyptian Arabic: in both languages LF wh-Movement is a genuine strategy of question formation. This amounts to saying that wh-in-situ items are not as marginal as in languages like English

and French. It is therefore necessary to find out what differences might be between languages like French and English on the one hand and Tuki and Egyptian Arabic on the other hand. Let us consider the following questions in Egyptian Arabic and Tuki:

(91)

a. Mona nisit tiktib eeh?

Mona forgot to write what

‘What did Mona forget to write?’

b. Putá a- mu- barafya o-tira áté?’

Putá SM P1 forget to write what

‘What did Putá forget to write?’

In the above sentences, ‘what’ may have a narrow scope, that is, it can move to the empty embedded Comp at LF. In English, a wh-in-situ item may move to a [+wh] Comp only if that Comp is already filled by an element, as illustrated by the following examples from Wahba:

(92)

a. *John gave what to Mary (bad as a genuine question and good as an echo question)

b. Who gave what to Mary?

French patterns closely with English in this particular respect:

(93)

a. *Jean a offert quoi à Marie ?

Jean has offered what to Marie?

b. Qui a offert quoi à Marie?

Who has offered what to Marie?

The (a) sentences of (92-93) are disqualified because at LF, there is no [+wh] CP to host ‘what’ and ‘quoi’. The (b) sentences, however, are ruled in because the matrix CP can host at LF the surface structure wh-in-situ elements:

(94) LF representations

a. [who_i what_j [x_i gave x_j to Mary]]

b. [qui_i quoi_j [x_i a offert x_j à Marie]]

To account for the syntax of wh-in-situ elements in English and French, Aoun, Hornstein and Sportiche have a filter which we mentioned earlier and that we repeat here for convenience:

(95) *Comp unless it contains a [+wh] phrase

[+wh]

The above filter correctly disqualifies the following French and English examples:

(96)

a. *Je me demande Pierre est parti

- I Refl. ask Pierre is gone
 b *Je sais vous avez vu qui
 I know you have seen who

(97)

- a.* I wonder [+wh[John left]]
 b. *I know you saw whom

Aoun and his colleagues argue that languages that are devoid of Syntactic Wh-Movement (presumably Chinese, Japanese, Korean) are insensitive to the above filter. Thus wh-in-situ words in Chinese, for instance, raise to an unfilled CP at LF. Wahba shows that Egyptian Arabic and Ancash Quechua (Cole1982) exhibit Move Alpha at both S-structure and LF and they fail to obey the filter. We have just shown that in Tuki both S-structure and LF wh-movement are available to form content questions. To account for the superficial diversity that obtains among languages with respect to the validity of Aoun et al's filter, Wahba proposes two solutions that are not necessarily incompatible with one another:

- (i). parameterize Aoun et al's filter so that it would apply to some languages and not to others.
- (ii). Higginbotham and May's absorption rule that turns any number of wh-operators into a single complex operator to apply only to languages that marginally employ the wh-in-situ strategy.

Now, notice that those languages that seem to respect Aoun et al's filter are also those that marginally use the wh-in-situ strategy. It seems therefore appropriate to suggest that if the wh-in-situ strategy is a genuine one in a language, the latter language will be disrespectful of Aoun et al's filter and Higginbotham and May's rule of absorption.

8.7.3.2.2. Wh-phrases-in-situ and Subjacency

The relevant generalizations here are just like those in Chinese/Japanese as far as Subjacency effects go (Huang, 1982).

Observe the following question (see Baker, 1970 for the English material and Huang, 1982 for the Chinese facts):

(98)

- áné a-bungám [éé [táné [vítú tú-má-kúsa áté]]
 what SM remember that where we SM P2 buy what

'Who remembers where we bought what?' (o-bunga 'to remember' #obungana 'to think').

This sentence is ambiguous. It can be interpreted as a direct inquiry on the identity of the matrix subject *ane* ‘who’ forcing the pairing construal between *tane* ‘where’ and *ate* ‘what’. So interpreted, an appropriate answer to question (98) may be:

(99)

Putá a- bungám [éé [táne [vítú tu- má- kúsa áté]]

Putá SM remembers that where we SM P2 buy what

‘Putá remembers where we bought what’

Under the second interpretation, question (98) can be construed as an inquiry on the pairing between *ane* ‘who’ and the wh-element in-situ *ate* ‘what’ and (100) may be an appropriate answer:

(100)

Putá a- bungám [éé [táne [vítú tu- má- kúsa matúwa]]]

Putá SM remembers that where we SM P2 buy car

‘Putá remembers where we bought a car’

Notice that under the construal between ‘who’ and ‘what’ in (98), the latter wh-item moves to the matrix CP at the LF and thereby violates the Wh-island condition. So in this particular instance, Tuki seems to violate Subjacency at LF. This conclusion is corroborated by the fact that a wh-in-situ phrase can occur inside a relative clause in the language.

(101)

Putá i – dzimám [mángádzu[ódzú a- má- nóba áne]]

Putá SM knows child who SM P2 beat who

‘Who does Putá know the child who beat?’

In (101), *ane* ‘who’ can have a wide scope reading, thereby violating the CNPC. The Co-ordinate Structure Constraint seems to be violated too at LF in the language (see our discussion of coordination above):

(102)

Putá a- m- éna Isómo na áne

Putá SM P1 see Isomo and who

‘Putá saw Isomo and who?’

Since *ane* ‘who’ can have scope over the clause in (102) LF movement does not observe Subjacency above. Note that the referential adjunct *tane* ‘where’ behaves pretty much like an argument with respect to some scope possibilities. Referential adjuncts pattern with arguments with regard to their extraction possibility at LF.

(103)

o-sésám [éé [táne[Mvóngo a- má- sérá ate]]]

SM ask that where Mvóngo SM P2 sell what

‘You ask where Mvongo sold what?’

(104)

- a. ‘What is the thing x such that you ask where Mvongo sold x?’
- b. Where is the place x such that you ask what Mvongo sold at x place?’

(105)

o-sésám [éé [ni [Mvóngo a- má- sérá ate
SM ask that when Mvóngo SM P2 sell what

‘You ask when Mvongo sold what’

The following construals may be assigned to (105):

(106) a. ‘What is the thing X such that you ask when Mvongo sold X?’

b. ‘What is the time X such that you ask what Mvongo sold at X time?’

(107a) may be an appropriate answer for (103) whereas (107b) may be an appropriate answer for (105):

(107)

a. Nu Nt- sesám [éé [Mvongo] a- má- sérá até na Yáwúndu

I SM ask that Mvongo SM P2 sell what in Yaoundé

‘I ask what Mvongo sold in Yaoundé’

b. Nu Nt- sesám [éé [Mvóngo a- má- sérá até idzo]]

I SM ask that Mvóngo SM P2 sell what yesterday

‘I ask what Mvongo sold yesterday’

Moreover, like arguments, *tane* ‘where’ and *ni* ‘when’ can be embedded within a complex NP:

(108)

a. Ntsóno [ǐdzi [Putá a- má- kúsa tane]]] í- diyám?

clothes which Puta SM P2 buy where SM cost

‘Clothes that Puta bought where are expensive?’

b. [nama [adze[Isómo a- m(u)- úna ni]]] i- mú ndzu

animal that Isomo SM P1 kill when SM is elephant

‘The animal that Isomo killed when is elephant’

Now notice that the non-referential adjunct *owate* ‘why’ may not be embedded under a relative clause and have over scope the latter clause. Consequently, although the first two sentences below are grammatical, the third one is illicit:

(109)

a. Putá a- dingám [mutu [ódzu [a-benám Dimá owáte]]]

Putá SM loves man who SM hates Dima why

‘Why does Puta love the man who hates Dima?’

b. owáte Putá a- dingám [mutu [ódzu [a-benám Dimá?]]]

why Putá SM loves man who SM hates Dima

‘Why does Puta love the man who hates Dima?’

c. *Putá a-dingám [mutu [ódzú[owate[a-benám Dimá]]]]

Putá SM dingam man who why SM hates Dima

In the above sentences the non-referential adjunct *owate* ‘why’ cannot have a wide scope interpretation, this is plausible under the assumption it obeys the CNPC. It cannot be argued that the wide scope construal is ruled out by the ECP since the trace left by the adjunct *owate* ‘why’ fails to be properly governed by the verb; if that were the case we would expect sentences containing ‘where’ and ‘when’ to exhibit the same behavior since their traces are not governed by the verb either. However, this is not the case since these two non-referential adjuncts pattern with arguments. So crucially it has to be Subjacency that disqualifies the above constructions. This contention is again supported by the following examples:

(110)

a. o-sésám [éé[ěndzu [a- mu-sérá itutu owate]]]

SM ask that who SM P1 sell motorcycle why

“You ask who sold a motorcycle why?”= “Who is the person X such that you wonder why X sold a motorcycle?”

b. o-sésám [éé [ěndzu [a- mu- fénda itutu twí]]]

SM ask that who SM P1 repair motorcycle how

“You ask who repaired a motorcycle how?”= “Who is the person x such that you wonder how x repaired a motorcycle?”

Are the two sentences ambiguous? In other words, assuming that *andzu* “who” can have a wide scope interpretation, is it the case that the non-referential adjuncts *owate* “why” and *twí* “how” can be interpreted as having a matrix scope. These two sentences are not ambiguous: while the argument *andzu* “who” has a wide scope over the matrix clause. The adjuncts can only be interpreted as having narrow scope over the embedded clause. (110b) cannot mean “what is the manner x such that you ask who repaired a motorcycle for x in X manner?”. Similarly (110a) cannot be construed as “what is the reason x such that you ask who sold a motorcycle for x reason?”. Thus the above facts imply that non-referential adjuncts such as *owate* “why” and *twí* “how” obey the Wh-island Constraint and the

Complex Noun Phrase Constraint at LF. This is tantamount to saying that Tuki obeys Bounding Theory at LF.

In sum, we have now established that Tuki obeys Bounding Theory at both S-structure and LF. This situation is comparable to the Egyptian Arabic case. And unlike the English and French case where Subjacency effects are hardly visible at LF, the latter languages, however, do not form genuine content questions with *wh*-in-situ elements; that is, the syntax of *wh*-in-situ phrases is very constrained and marginal. For instance, English and French do not allow non-referential adjuncts to remain in-situ.

(111)

- a. *John left why?
- b. *Jean est parti pourquoi?

Jean left why

(112)

- a. *John repaired his car how?
- b. *Jean a réparé sa voiture comment?

“Jean has repaired his car how?”

Tuki allows non-referential arguments to remain in-situ quite freely:

(113)

- a. Mbárá a- m- énda owáte

Mbara SM P1 go why

“Why did Mbara leave?”

- b. Mbárá a- mu- fénda mátúwa wáá twíí

Mbara SM P1 make car his how

“How did Mbara repair his car?”

This raises interesting questions about how the Empty Category Principle (ECP) is respected in Tuki once the non-referential adjuncts *owate* “why” and *twíí* “how” undergo LF raising. We will come back to this issue later when we tackle the impact of the crosslinguistic diversity on the ECP. We contend that Tuki obeys Subjacency both in the Syntax and LF because question formation is a genuine strategy at these levels of representation (cf. also Egyptian Arabic and Ansash Quechua). This makes the interesting predictions that: (i.) a language in which the behavior of *wh*-items in-situ is marginal will not display Subjacency effects at LF; (ii) a language in which the syntax of *wh*-in-situ is the sole mode of content question formation will respect islands at LF. The first prediction is proven to be true by languages like English and French; and the second prediction is attested by Chinese (Fiengo, Huang, Lasnik, Reinhart; 1989), Japanese (Nishigaushi 1986; Pesetsky 1987) and Korean (Choe 1987).

8.7.3.3. Subjacency in Egyptian Arabic

Wahba (1984) shows that in Egyptian Arabic (EA), syntactic wh-questions, the question site is obligatorily marked with a co-indexed resumptive pronoun. She shows that the latter is syntactically bound to its antecedent via a wh-movement rule which observes Subjacency. Moreover, she claims that the wh-trace gets obligatorily spelled out as a resumptive pronoun at S-structure.

In analyzing wh-questions in EA, Wahba makes a distinction between nominal and nonnominal wh-operators in CP. Nominal wh-questions require the presence of the complementizer *illi* and a resumptive pronoun occupying the questioned site as in (114a); in nonnominal questions *illi* and a resumptive pronoun are conspicuously missing (114a):

(114)

a. [miin_i illi[mona darabit-uh_i]]

who that Mona hit-him

“Who did Mona hit?”

b. [ma’a miini [Ali xarag e_i]] ?

with whom Ali left

“With whom did Ali leave?”

In fact, what Wahba calls nominal and nonnominal wh-operators are simply arguments and adjuncts.

8.7.3.3.1. Argument Wh-operators

Argument wh-operator such as *miin* “who”, *?eeh* “what” and *anhi* NP “which NP” require the presence of both a resumptive pronoun in the question site and the complementizer *illi* “that” which immediately follows the argument wh-operator:

(115)

a. Miin_i illi Mona shaafit-uh_i?

who that Mona saw-him

“Who did Mona see?”

b.* Miini illi Mona shaafit e_i ?

who that Mona saw

c.* Miin_i (o) Mona shaafit-uh_i?

who Mona saw-him

(116)

a. Eehi illi Mona ?arit-uh?

what that Mona read-it

“What did Mona read?”

b.*Eeh_i illi Mona ?arit e_i ?

what that Mona read (e)

c. *Eeh_i (o) Mona ?arit-uh_i

what Mona read-it

(117)

a. Anni walad_i illi Mona shafit-uh_i?

which boy that Mona saw-him

“Which boy did Mona see?”

b. *Anhi waladi illi Mona shaafit e_i?

Which boy that Mona saw

c. * Anhi waladi (o) Mona shaafit-uh_i?

which boy Mona saw him

The ungrammaticality of the (b) sentences is due to the absence of a resumptive pronoun. Similarly, the (c) sentences are illicit because the complementizer *illi* “that” is missing. The EA data seem to indicate that if the wh-trace in wh-constructions occupies an argument, it is realized as a resumptive pronoun. If it occupies an adjunct position, it will be realized as a gap.

8.7.3.3.2. Adjunct Wh-operators

Wahba divides adjunct wh-operators into two groups:

(a) prepositional phrases such as *ma’a miin* “with whom”, *ala eeh* “on what” etc. and

(b) referential adjuncts such as *feen* “where”, and non-referential adjuncts such as *izzay* “how”, *leeh* “why” etc.

Recall that in wh-constructions involving the movement of an adjunct, the complementizer *illi* that is absent and the wh-trace cannot be realized as a resumptive pronoun:

(118)

a. Ma’a miin_i Mona raahit il-Qahirah e_i?

with whom Mona went to-Cairo (e)

“With whom Mona went to Cairo?”

b. *Ma’a miin_i Mona raahit-uhi il-Qahirah?

with whom Mona went to-Cairo

c. *Ma’a miin_i illi Mona raahit il-Qahirah e_i?

with whom that Mona went to-Cairo

(119)

a. Feen_i Mona raahit e_i?

where Mona went (e)

“Where did Mona go?”

b.* Feen_i Mona raahit-ha_i?

where Mona went-it

c.*Feen_i illi Mona raahit-e_i?

where that Mona went

Notice that a resumptive pronoun makes the above (b) sentences ungrammatical. The (c) sentences are illicit because of the occurrence of the complementizer *illi* “that”.

Summarizing, wh-constructions in EA have the following properties:

(a). the complementizer *illi* “that” occurs if the extracted wh-element is an argument; it is absent if the item being raised is an adjunct.

(b). the wh-trace is obligatorily realized as a resumptive pronoun if the element in CP is an argument; however, if the element in CP is an adjunct, the wh-trace necessarily remains an empty category.

8.7.3.3.3. Wh-constructions and the Subjacency Condition

Wahba argues that the relation between the argument wh-operator and the associated resumptive pronoun is subject to Bounding Theory in EA. Thus, in this language, neither the subject nor the object may be raised out of an indirect question:

(120)

a. *[anhi kitaabj illi [M. te'raf [miini illi[ei sara ?-uhj]]]]

which book that M. know who that stole-it

“*Which book does Mona know who stole?”

b. *[miini illi [Mona te'raf [feenj [huwwai raah ej]]]?

who that Mona knows where he went

“*Who does Mona know where he went?”

Notice that in the above constructions, the spot previously occupied by the questioned item is now occupied by a resumptive pronoun. Both sentences violate the Wh-island Constraint. Hence their illicitness. Similarly, when the Complex Noun Phrase Constraint (CNPC) is violated, the resulting sentences are ungrammatical, as illustrated below:

(121)

a. Ali sara? il-kitaab_i illi Mona iddat-uhi li-Nadia

Ali stole the-book that Mona gave-it to Nadia

“Ali stole the book that Mona gave to Nadia”

b. *Miin_i illi Ali sara? il-kitaabj illi Mona iddat-uhj li-ha_i

who that Ali stole the-book that M. gave-it to her

“*Who did Ali steal the book that Mona gave it to?”

Thus, there is overwhelming evidence that in EA the relationship between an extracted wh-item and its associated resumptive pronoun is identical to the relationship between a raised wh-phrase in English and its trace. The fact that wh-questions in EA cannot violate Subjacency suggests that the resumptive pronouns involved in those constructions are variables, much in the same way that the wh-traces in English are variables. And Wahba shows convincingly that resumptive pronouns in EA wh-questions are subject to Binding Theory Principle C (Chomsky, 1981). Incidentally, Tuki resumptive pronouns obey Principle C as well.

Summarizing, what has been said so far: in EA wh-questions traces left by S-structure extraction of wh-phrases are necessarily phonetically realized as resumptive pronouns and constitute additional support to Shlonsky’s (1992) idea that resumptive pronouns are used as a last resort strategy. The relationship between the fronted wh-phrases and their associated resumptive pronouns is constrained by Bounding Theory, providing thereby evidence that genuine movement is involved in EA wh-questions and that base-generation of wh-phrases in clause-initial position is not an option here.

Next, we turn to wh-constructions that do seem to involve base-generation of wh-phrases in clause-initial position (for details see Wahba, 1984). Resumptive pronouns do occur in these constructions and it will be claimed below that they are generated as ordinary pronominal elements which are co-indexed with their antecedents in CP via an LF interpretative rule (Wahba, 1984: 44).

8.7.3.3.3. Topicalization

In EA, topicalization is possible out of embedded questions and embedded relative clauses. Notice that the resumptive pronoun may occur in subject or object position:

(122)

a. il-raagil dah_i, M. tawaqqa’ it inn uxta-ha titgawwiz-uh_i

the-man this M. expected that sister-her to marry-him

“As for that man, Mona expected her sister to marry him”

b. il-raagil dah_i, M. iftakarit’t inn uxta-ha titgawwiz-uh_i

the-man this M. thought that sister-her to marry-him

“As for that man, Mona thought that her sister married him”

The following paradigm shows that topicalization out of indirect questions is free.

(123)

a. il-raagil dah_i M. ?aalit-li [feenj [huwwa ?aabil-ha_i e_i]]

the-man that M. told-me where he met-her

“As for that man, Mona told-me where he met her”

- b. il-raagil dah_i M. ?aalit-li [feenj [hiyya ?aabil-uh_i e_j]]
 the-man that M. told-me where she met-him
 “As for that man, M. told me she met him”

Similarly, topicalization out of relative clauses is licensed:

(124)

- a. il-beet dah_i baba ye’raf [il-raagil_j [illi[e_j bab-ah_i]]]
 the-house that father knows the-man who built it
 “As for that house, father knows the man who built it”
- b. il-bint di_i, A. ye’raf il-raagil_j [illi [hiyya_i itgawwizit-uh_j]]
 the-girl this A. knows the-man whom she- married-him
 “As for this girl, A. knows the man whom she married”

8.7.3.3.2. Relative Clauses

Relativization, as well as topicalization, violates island constraints.

(125)

- a. il-Bint_i illi Fariid ?aal [feenj [?aabil-hai e_j]]
 the girl that Fariid said where he met her
- b. . il-Bint_i illi Fariid ?aal [feenj [hiyya_i ?ablit-ha e_j]]
 the girl that Fariid said where she met him

(126)

- a. il-Maktabahi illi baba ? aabil [il-raagil_j [illi [e_j baba-hai]]
 the library that father met the-man who built-it
- b. il-Raagil_i illi baba ishtara [il-beet_j [huwwa_i bana-ah_j]]
 the man that father bought the house he built it

Thus, relativization and topicalization in EA are immune to Subjacency. Notice that resumptive pronouns in the latter constructions do not behave as those involved in *wh*-questions. Since they do not exhibit the behaviour of genuine *wh*-traces, it could be assumed that they are not variables. To account for their behaviour, Wahba adopts the analysis that Chomsky (1982) proposes for resumptive pronouns in left dislocation constructions in English. In this approach, the relationship between the *wh*-phrase and the resumptive pronoun is not subject to Bounding Theory. Both the *wh*-phrase and the resumptive pronoun are base-generated in their respective positions. Coindexation between the *wh*-phrase and the resumptive pronoun takes place through an LF interpretative rule of predication, rather than at S-structure. For illustration, consider the relative clause in (127); its LF representation is (127) and after the predication process has taken place, we obtain the LF’ representation in (127c):

(127)

a. il-raagil illi Mona darabit-uh

the man that Mona hit him

b. [il-raagil_j [illi (o)_i [Mona darabit-uh_i]]]

c. [il-raagil_i [illi (o)_i [Mona darabit-uh_i]]]

This analysis easily extends to topicalization.

Having established the conditions under which Subjacency is believed to be obeyed (or violated) in Tuki (i.e. extraction of adjuncts over islands violates Subjacency) and Egyptian Arabic (the relationship between the fronted *wh*-phrases and their associated resumptive pronouns is constrained by Bounding Theory), we turn to the question of whether Subjacency is a condition on representation or movement. Against the traditional view that Subjacency is a condition on movement, it has been argued by a number of syntacticians (Freidein,1978; Koster,1978; McDaniel,1989) that Subjacency is a condition on representation. Huang (1982) claims that there is empirical support for taking the traditional view. Chomsky (1982) indicates that certain *wh*-traces or variables may be base-generated when they are licensed by a *wh*-trace generated by movement. The base-generated variables appear to violate Subjacency if the latter term is understood as a condition on representations:

(128)

Here is the car which John bought (t) without ever driving (e)

(129)

Here is the car that everyone who has driven (e) will recommend (t) to.

In the above sentences, the parasitic gaps (e) and the real gap (t) are identified as variables since they are locally A'-bound. If Subjacency is a condition on output representations, it will incorrectly apply to these two variables (e) and (t). That is, this view will mistakenly claim that both base-generated variables and movement-derived variables are subject to Subjacency. This approach cannot obviously be correct as it is well-known that base-generated variables do not induce Bounding Theory violations effects. If Subjacency is understood as a condition on movement, it will apply only to variables derived by movement, predicting thereby that the two constructions above are grammatical since only one of the two variables is subject to Bounding Theory. Thus, we adopt the position that subjacency is a condition on Move Alpha.

Tuki seems to provide additional evidence for this view. Recall that in Tuki *wh*-constructions involving resumptive pronouns, the latter pronouns may be null or phonetically realized; in either case, it was argued that these pronouns are base-generated variables since they are syntactically A'-bound. Consider the following example in which the base-generated variable is non-overt:

(130)

ane_i Mbárá a-m(u)- úba [NP maru ama [CP éé [IP púrúsu i-má-nóba ec_i]]]]

who Mbara SM P1 hear story this that police SM P2 beat

“Who did Mbara hear the story that the police beat”

A representational view of Subjacency wrongly predicts that the above sentence is ungrammatical. Whereas the “movemental” approach says that the above example is not subject to Subjacency because the variable and the operator are both base-generated, that is, generated without regard to Bounding Theory. The Tuki data point to a fundamental weakness in the representational analysis of Subjacency, namely that it crucially fails to recognize that variables are different kinds. This reason easily applies to the EA empirical material. Recall that in this language, topicalization, relativization and content question formation obligatorily involve resumptive pronouns. However, only wh-questions respect Subjacency. A representational approach to Subjacency erroneously predicts that in all three constructions (topicalization, relativization and question formation), variables (i.e. A'-bound resumptive pronouns) are subject to Subjacency at S-structure. On the other hand, knowing that in topicalization and relativization, wh-phrases are base-generated in front-initial position, if Subjacency is interpreted as a “movemental” principle, then only the creation of variables occurring in EA wh-constructions (that involve genuine extraction) will exhibit bounding effects.

Another argument for construing Subjacency as a condition on movement comes from raising constructions (Huang, 1982:517). Huang notes that “if raising constructions are analyzed as involving S'-deletion as in Chomsky (1981), it is natural to assume that an intermediate trace immediately dominated by S' will also be deleted following the deletion of S', or there would be no appropriate place for the “floating” intermediate trace to be in. If so, the result of S'-deletion will violate Subjacency, as (131) shows:

(131)

Who_i [S did John believe [S (t_i) to have come]]?

There is some reason to believe that the trace (t_i) in (131) must be governed at SS (in order to satisfy the Case Filter at PF and the ECP at LF). Therefore, S'-deletion must apply at SS. This means that if Subjacency is construed as a condition on output representations, then it must be ordered to precede S'-deletion. But this is just a different way of saying that Subjacency is a condition of the rule of Move Alpha, which may apply throughout any stage in Syntax up to, but excluding, SS”. (Huang indicates that this point was separately made by Howard Lasnik). Thus, there seems to be enough evidence in favor of the view that Subjacency is a condition on movement.

8.8. Coordination

In a preceding section, we argued that it was possible to conjoin a clause with a gap and a clause with a resumptive pronoun in Tuki (cf. (39 above)), thereby showing that there exists a parallelism between gaps and resumptive pronouns in the language. Coordination is constrained crosslinguistically,

and we did not mean to imply that Tuki violates the Coordinate Structure Constraint (CSC). Ross (1967) defines conjuncts of coordinate structure as islands:

(132) *Coordinate Structure Constraint (CSC)*

In a coordinate structure, no conjunct may be moved, nor may any element contained in a conjunct be moved out of that conjunct. (Ross's (4. 84).

In this section, we will see that although Tuki allows Across-the-Board extraction, it does not violate the Coordinate Structure Constraint. We will also see problematic cases of coordination in the language that apparently show trespassing of the CSC. Tuki uses different elements for coordination depending on the nature of the conjuncts. For instance, NPs are conjoined with *na* "and" which can also function as a and preposition mean at, in, on, to, with; whereas clauses are conjoined with *ka* "then". First, we consider what we term clausal coordination.

8.8.1. Clausal Coordination

As predicted by the CSC, it is impossible to extract one constituent of a conjoined structure in Tuki.

(133)

*nũ- ngi-idzimám[_{NP} mutu [_{CP} ódzu_i[_{IP} Putá a-dingám ec_i ka [_{IP} Mbárá a- benám

I SM know man who Puta SM loves then Mbara SM hates

Dímá]]]]

Dima

"I know the man whom Puta loves and Mbara hates Dima"

However, Across-the-board extraction allows extraction from both conjuncts, provided that the affected elements in each conjunct be "identical"(see Williams1978, 36, (31)). Consider in this respect (134b);

(134)

a. nũ-ngi-idzimám[_{NP} mutu [_{CP} ódzu_i [_{IP}Putá a-dingám eci ka [_{IP} Mbárá a- benám

I SM know man who Puta SM loves then Mbara SM hates

eci]]]]

"I know the man whom Puta loves and Mbara hates"

b. nũ ngi-idzimám[_{NP} mutu [_{CP} ódzu_i[_{IP} Putá a- mu dingám ómwéné_i/ec_i o ka [_{IP} Mbárá

I SM know man who Puta SM OM loves him then Mbara

a- mú-benám ómwéné_i/ec_i]]]]

SM OM hates him

"I know the man whom Puta loves him/o and Mbara hates him/o"

(134a) is grammatical because the same extraction rule has applied in both conjuncts. Notice that in (134b), the two conjuncts are the two VPs and that in each case the trace left by the extracted element can be replaced by a resumptive pronoun. Assuming Williams's requirement that wh-movement must

apply across-the-board to an identical item in both conjuncts, then we have to conclude that wh-movement has affected both conjuncts in (134), and that the trace that is left behind is optionally spelled out as a resumptive pronoun. Given that the phonological realization of the trace cannot change its syntactic category in compliance with Williams's condition, both gaps and resumptive pronouns must be of the same syntactic category. That is they are both bound by the wh-word at S-structure. The optionality of resumptive pronouns pops up again in Hebrew as showed in Shlonsky (1992) but seems to have an alternative analysis. In fact, the analysis of Hebrew data reveals that the overt realization of resumptive pronouns depends to some extent on the morphology of the complementizer that dominates the structure at S-structure. Let us consider the following Hebrew and Palestinian examples drawn from Shlonsky (1992)

(134') Hebrew (Shlonsky 1992: 444-445)

a. ha- ζ isû seû-ra ζ iti (ζ oto)

the man that- (I) saw (him)

“The man that I saw”

b. ha- ζ isû seû- xasavti sê-(hu) melamed ζ anglit

the man that (You.F) (he) teaches English

“The man that you thought teaches English”

(134'') Palestinian (Shlonsky 1992:445)

c. l-bint ζ illi fakkarti fii-*(ha)

the-girl that (you. F) thought on-(her)

“The girl that you thought about”

d. l-bint ζ illi Šufti beet-*(ha) Palestinian, (Shlonsky, 1992:445)

the-girl that (you. F) saw house(-her)

“The girl whose house you saw”

Wherever a resumptive pronoun is mandatory in Palestinian, a gap is impossible contrary to Hebrew where both a gap and a resumptive pronoun seemingly overlap in their distribution. Shlonsky argues that there exist two types of non-distinct complementizers in Hebrew which condition in some way the distribution of resumptive pronouns. The first type of complementizer he labels $\check{S}_{e_{AS}}$, is basically identical with the Palestinian $\zeta illi$ “that” which selects an A-specifier. The second, labeled $\check{S}_{e_{A'}}$ selects an A'-specifier. So wherever the first complementizer is selected, a resumptive pronoun is mandatory whereas in case of the second being selected, wh-movement is not subject to SSC and may proceed freely from direct object, embedded subject, and embedded object position. With this borne in mind, it follows that the optionality of resumptive pronouns in Hebrew is rather an illusion created by the lack

of discrete morphological forms of the two complementizers. The difference between the above two languages relies on the morphological nature of the complementizers and their distribution.

We conclude here that Tuki does not violate the CSC, although it seems to violate consistently other island constraints in constructions containing resumptive pronouns. Georgopoulos (1985) observes the same behaviour in Palauan and concludes that the CSC is a constraint different in kind from other constraints subsuming Subjacency. Scandinavian languages too observe the CSC while many island constraints are violated (Engdahl and Ejerhed 1982).

8.8.2. NP Coordination

We will refer to coordination of the two NPs in Tuki as NP coordination. As pointed out above, Tuki uses for coordination of NPs *na* which sometimes functions as a comitative marker meaning in some contexts “with”:

(135)

Mbárá éndam na Putá na wáspita

Mbara goes with Puta to hospital

“Mbara goes with Puta to the hospital”

The facts that we are going to present will appear at first as violations of the Coordinate Structure Constraint; but in the end it will be shown that the CSC is not violated in Tuki.

Let us consider the following paradigm:

(136)

a. Mbárá a-m-una [Putá na Dimá]

Mbara SM P1 kill Puta and Dima

“Mbara killed Puta and Dima”

b. ǎndzu_i Mbárá a- m-úna ec_i na Dimá

who Mbara SM P1 kill and Dima

“Who did Mbara killed and Dima”

c. . ǎndzu_i Mbárá a-mu- mu-úna ómwéné_i na Dimá

who Mbara SM P1 OM kill her and Dima

“Who did Mbara her and Dima?”

d. ǎndzu_i Mbárá a- mu-úna Puta na a_i

who Mbara SM P1 kill Puta and he

“Who did Mbara kill Puta and him”

e.* ǎndzu_i Mbárá a- mu-úna Putá na ec_i

who Mbara SM P1 kill Puta and

“Who did Mbara kill Puta and” (P-stranding is disallowed)

Above, an element may be extracted out of a conjoined structure. But only the first conjunct may leave an empty category when it is extracted. When the second conjunct is extracted out of the conjoined NP, it must leave a phonetically realized proform which is incidentally the SM [a]. The sentence (136d) is accounted for below (cf. 140 (a,b)). On the other hand, a resumptive pronominal chain (i.e. *cli...ei*) can stand for the first conjunct when it is questioned, as illustrated in (136c). The same facts obtain with regard to the behaviour of coordinate structures in relativization and focus constructions: one of the conjuncts of a conjoined structure can be relativized or topicalized. In each case, a resumptive pronoun can replace the first conjunct, while the subject marker can replace the second conjunct.

(137) Relativization

a. [okutu ódzu] ódzu_i Mbárá a- má- mú- úna ómwéné_i na Putá
woman this whom M. SM P2 OM kill her and Puta

“This is the woman that Mbara killed her and Puta”

b. [okutu ódzu] ódzu_i Mbárá a- má- úna ec_i na Putá
woman this whom M. SM P2 kill her and Puta

“This is the woman that Mbara killed and Puta”

c. [okutu ódzu] ódzu_i Mbárá a- má- úna Dima na aⁱ / *0
woman this whom M. SM P2 kill Dima and her

“This is the woman that Mbara killed Dima and her”

(138) Focus Construction

a. i-mu [okutu ódzu] ódzu_i Mbárá a- mu mu- úna omwéne_i na Putá
it is woman this whom M. SM P1 OM kill her and Puta

“It is this woman that Mbara killed her and Puta”

b. i-mu [okutu ódzu] ódzu_i Mbárá a- mu mu- úna x_i na Putá
it is woman this whom M. SM P1 OM kill and Puta

“It is this woman that Mbara killed and Puta”

c. i-mu [okutu ódzu] ódzu_i Mbárá a- mu mu- úna Dima na a_i/*0
it is woman this whom M. SM P1 OM kill Dima and

“It is this woman that Mbara killed Dima and her”

It may appear that the first conjunct may occur in preposed position and be related to an [ec] in any of the constructions exhibited above, thereby violating the CSC. This fact may be very surprising in

view of the absence of reported cases of CSC transgression, even in languages that apparently violate Subjacency. It seems to be the case that coordination in Tuki, in particular coordination of NPs, functions differently from the one found in languages like English or French. Recall that the element used for coordination of NPs in Tuki is also a comitative marker. Suppose that the “connector” for Tuki NPs is in fact a comitative marker. Then an analysis of the above data would follow under the suggestions made by Schwarz (1987). Linda Schwarz reveals that to serve the semantic function of coordination, many languages (such as Russian, Polish, Bulgarian, Latvian and Tagalog) have a Comitative Coordination Structure for NP coordination as illustrated below:

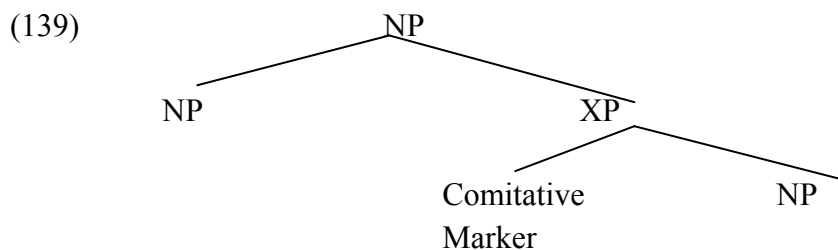

In (139) above, XP can be PP or NP, depending on whether the Comitative Marker is a lexical preposition or a Case-marker. XP in (139) is sometimes extraposable, or can be argued to be an independent constituent. If we adopt the structure in (139), then the empirical material in (136c-d) points out to the fact that the second conjunct with the connector *na* can be separated from the first conjunct. If that proves to be true, the connector and the second conjunct are a simple case of extraposition. This reasoning is corroborated by the fact that *na* and the second conjunct can be preposed in (136a) as illustrated below in (140):

- (140)
- na Dimá [Mbárá a- m-uná [Putá [XP]]
 and Dima Mbara SM P1 kill Puta
 “And Dima, Mbara killed Puta”

It appears that the connector *na* is a Comitative Marker which functions as a preposition (cf.(135)). The view that the comitative marker *na* is a preposition would explain why it is only the first conjunct of a coordinate structure which can be moved out and leave behind a trace (cf.(136)). Since the comitative marker *na* seems to be a preposition, movement of a second element of a coordinate structure is an instance of Preposition Stranding, a phenomenon which is strictly disallowed in Tuki. It appears that prepositions are not proper governors in Tuki. Let us consider (135) (repeated here for convenience) and (141):

- (141)
- Mbárá endám na Putá na wáspita

Mbara goes with Puta to hospital
 “Mbara goes with Puta to the hospital”
 (142)

- a. **ǎndzu_i* Mbárá endam na x_i na waspita
 who Mbara goes with to hospital
 “Who does Mbara go with to the hospital”
 b. *ǎndzu_i* Mbárá endam na á na waspita
 who Mbara goes with her to hospital
 “Who does Mbara go with her to the hospital”

(142a), as expected, becomes grammatical if a resumptive pronoun occupies the position (after the preposition) vacated by S-structure movement of *ǎndzu* “who” (cf. (142b)). Thus NP coordination in Tuki is simply a case of Comitative Coordination Structure which is very common among languages, rather than a violation of the Coordinate Structure Constraint. The connector *na* is a preposition-comitative marker which does not allow Preposition Stranding in the language.

8.9. Formal versus Semantic Variables

So far, we have argued that gaps in Tuki wh-constructions should be analyzed as null resumptive pronouns. These gaps get optionally phonologically realized when their A'-binders are [+human]. We also said that resumptive pronouns, null or overt, are “linked” to their A-bar antecedents at S-structure. It is generally assumed in generative grammar that A-bar bound pronominals are variables. More precisely, A-bar pronominals are semantic variables (cf. Higginbotham (1983: 409) as well as Koopman and Sportiche (1982/3, footnote 1, Hoji (1985:44) as opposed to formal variables which are defined as follows:

(143) Variables: A variable is an EC bound by an operator in an A'-position (“A variable is an A'-bound EC”).

For illustration, consider the following English sentences:

(144) Everyone_i loves his_i mother

The schematic S-structure and LF representations of (144) are given in (145) below:

- (145) a. S-structure: [Everyone_i] NP loves his_i mother
 b. LF: [IP [everyone] NP[IP t_i loves x_i mother]]

According to (143), (t) being an empty category is a variable, which is bound to everyone in (145). “His” in (145) is also bound to everyone, i.e. is construed as a variable bound to everyone, but it is not a variable since it is not an empty category. Adopting here the distinction between formal and semantic variable (see Higginbotham (1983), Koopman and Sportiche (1982/3) for details), we can say that resumptive pronouns (null or overt) in Tuki wh-constructions are semantic variables different in nature from formal variables. Recall that we argued above that resumptive pronouns do not exhibit weak cross-over effects in Tuki, and gaps were also shown to fail to exhibit such effects, suggesting that gaps and overt resumptive pronouns are not of the same kind. Since syntactically bound resumptive pronouns are semantic variables, we conclude that semantic variables do not exhibit weak crossover effects in Tuki at S-structure as illustrated once again in the following sentences:

(146)
ǎndzu_i ísa wáá a-mú-dingám ómwéné/ec_i
 who father his SM OM loves him/ec
 “Who does his father loves him/ec?”

Below we will present evidence that the distinction between semantic and formal variables is empirically motivated with regard to the weak crossover phenomena. In effect, we will show that formal variables exhibit weak crossover effects at LF in Tuki. Let us consider the following wh-in-situ construction:

(147)* *káráte ate údzam éé nõsi wáá_i a- dingám [mwána ate]_i?*

book what says that mother his SM loves child what

“Which book says that his mother loves which child?”

(147) is ungrammatical, which suggests that coindexing is not possible between pronouns and moved wh-words to their right. Let us consider the LF representation of (147):

(148) [*káráte ate*]_j [*mwána ate*]_i [*x_j údzam éé nõsi wáá_i a-dingám x_i*]

In (148) above, the variable x_i is to the right of *wáá_i* “his” and the sentence is ruled out by the Leftness Condition (or the Bijection Principle). As opposed to the previous cases where the weak crossover effects were nonexistent, in (148) wh-movement has taken place at LF. Since the variable left by movement of *mwána ate* “what child” cannot be spelled out as a resumptive pronoun, x_i is a formal variable. The latter being bound by a pronoun to its left disqualifies the construction. So, up to now, we have encountered two cases to which the Leftness Condition has reacted differently: on the one hand the interpretation of structures involving semantic variables bound at S-structure does not show weak crossover effects, on the other hand, the interpretation of structures involving formal variables bound at LF obeys the Leftness Condition.

Now what about the interpretation of quantifiers? Consider the following sentences with respect to the Leftness Condition:

(149)

a. **éé [e]_i a- mú yedza i- sáseyám [mutu óngíma]_i*

that he SM is mad SM annoys man every

“That he is mad annoys everyone”

a'. *éé [e]_i a- mú yedza i- sáseyám Isomo_i*

that he SM is mad SM annoys Isomo

“That he is mad annoys Isomo”

b. **íyere wáá_i a- dingám [mángádzu a sukuru óngíma]_i*

teacher his SM loves child of school every

“His teacher loves every student”

In both sentences above, a bound variable reading between the pronoun and the quantifier phrase is impossible. The LF representations for both sentences are:

(150)

a. [*mutu óngíma*]_i [*éé [e]_i a- mú yedza*] *i- sáseyám x_i*
man every that he SM is mad SM annoys

b. *mángádzu a sukuru óngíma*]_i [*íyere wáá_i a- dingám x_i*]
child of school every teacher his SM loves

In the above structures, pronouns are coindexed with formal variables to their right; the Leftness Condition disqualifies them consequently. This is again prima facie evidence that Tuki exhibits weak crossover effects only at LF.

In sum, we have seen in this section a contrast between variables created at S-structure and variables created at LF. We have argued that resumptive pronouns, null or overt, are semantic variables bound at S-structure by elements in an A-bar position; whereas formal variables are those created by LF-movement of wh-elements in-situ and quantifiers. Notice that there seems to be a correlation between

the presence of resumptive pronouns and the nonoccurrence of weak crossover effects. The absence of resumptive pronouns at LF, after the raising of quantified NPs and the movement of wh-items in-situ, inevitably triggers weak crossover effects. It is the above noted discrepancy between S-structure and LF which suggests that gaps in Tuki-wh-constructions are pro. That suggestion is supported by our previous claim that parasitic gaps are licensed by resumptive pronouns (overt or no-overt) at S-structure in Tuki, since pronouns are coindexed at S-structure in the language.

One significant contrast between Tuki and English is the contrast between the absence of weak crossover effects for S-structure variable-binding. This is a very interesting contrast. This could be related to Montalbetti's (1934) work on the binding of (null) pronouns by quantifiers in Spanish. Montalbetti's work is reported in Chomsky (1986b). In Spanish there are certain differences in interpretation between the null pronominal pro and its lexical counterpart:

(151)

- a. Muchos estudiantes piensan que ellos son inteligentes
many students think that they are intelligent (UNAMBIGUOUS)
- b. Muchos estudiantes piensan que pro son inteligentes (UNAMBIGUOUS)
many students think that pro are intelligent

The translation of the above Spanish sentences is the following: "Many students think that they are intelligent". The English sentence may have the interpretation below with *they* interpreted as a bound variable.

(153)

For many X, X thinks that X is intelligent.

Or (152) may be interpreted in such a way that *they* does not have a bound variable reading. (151) may have either one of the two readings. In contrast, (151a) is unambiguous, lacking the bound variable interpretation. The above facts do not obtain if a bound pronominal occurs between the quantifier expression and the overt pronoun:

(154) Overt Pronoun Constraint (OPC)

Overt pronouns cannot link to formal variables iff the alternation overt/+empty obtains.

Informally, the OPC claims that overt pronouns that are in contrastive distribution with empty ones cannot link to formal variables (that is QR- or Wh-traces).

8.10. Linking Theory

Before we proceed, we need to digress a little and introduce Linking Theory (for details see Higginbotham, (1983a; 1983b), or Montalbetti (1984)). The following summary of Linking Theory borrows heavily from Montalbetti's (1984) dissertation. Linking indicates a certain directional relation holding between two positions in a syntactic structure. Linking represents the assignment of the antecedence relation between two positions. Thus, the notion "antecedent of" is defined in terms of linking. In the following configuration, X and Y are positions linked in a certain structure E:

(156)

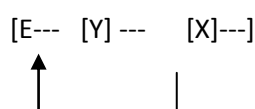

In (156), X is linked to Y in E. This can be expressed by: L (X,Y)E since the notion “antecedence of” is defined in terms of linking. L(X,Y)E in (156) can be interpreted as “Y” is an antecedent of X in E”. L(X,Y)E thereby may be A(Y,X)E. Thus L(inking) and A(ntecedence) can be related as follows:

(157) if L (X,Y)E then A(Y,X)E

Read: “if X is linked to Y in E, then Y is an antecedent of X in E”

Linking has three properties: (a) linking is a directional (i.e. asymmetric) relation: it establishes a relation from one position to another; (b) linking relates two positions in a given structure; and (c) linking is not a transitive relation: if X is linked to Y, and Y is linked to Z, then not X is linked to Z. The antecedence relation, however, is transitive. In the following configuration:

(158) [---[Z] --- [Y] --- [X] ---]

X is linked to Y, and Y is to Z, but since linking is not a transitive relation, X is not linked to Z. On the other hand, Y is an antecedent of X, and is an antecedent of Y, therefore, as antecedence is a transitive relation, Z is an antecedent of X. Moreover, while the antecedence relation is sensitive to the notion of c-command, linking is not. Below, (157 b, c) are two possible linkings of (159a):

(159) a. [--- [Y] --- [X] ---]

b. [--- [Y] --- [X] ---]

c. [--- [Y] --- [X] ---]

Assuming that Y c-commands X, (159c) is ruled out by a condition on the notion of antecedence, but not by linking since “backwards linking” is allowed (for details see Montalbetti 1984:34).

Higginbotham (1983a and b) indicates that linking applies between argument positions. Furthermore, linking is automatic for movement cases (syntactic movement (Wh-movement and NP movements) and LF movement (QR)). When movement is not involved, linking applies at S-structure and only between arguments. When movement occurs, linking is done at whichever level of representation movement took place (S-structure or LF). Let us consider the following examples:

(160a) a. [John] said that [he] ate a pumpkin.



b. [Who] did you see [t]

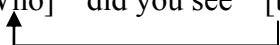

b'. [Everyone] [t] loves Mary

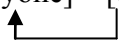

(160) is a case of non-movement linking. Linking has applied between arguments at S-structure. (160b and b') are cases of movement linking: (160b) is a case of syntactic wh-movement, therefore linking applied at S-structure; (160b') is a case of Quantifier Raising and linking applied at LF. In some cases, linking can apply between two argument positions at S-structure, then extends by movement at LF. For illustration, consider the following examples:

(161) a. [Many students] think [they] are intelligent (S-s.)

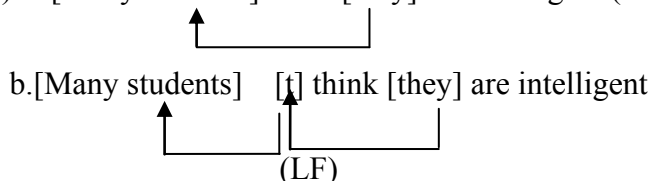

In (161a), linking has applied between two argument positions at S-structure. In (161b), QR took place at LF; thus they is now linked to the trace (left by the raising of many students.) which in turn is linked to the quantified NP. To summarize, linking is regulated by a number of formal properties and conditions:

(162) Properties of Linking (Montalbetti (1984:35))

- a. 'formal': (i) linking is directional (i.e. asymmetric);
 - (ii) linking relates two (and only two) positions in a given syntactic structure;
 - (iii) linking is intransitive.
- b. 'conditions': (i) the positions related through linking are argument positions;
 - (ii) linking is automatic under movement.

8.10.1. Some Principles of Grammar

Higginbotham (1983b) proposes a few principles of grammar which, in conjunction with Linking Theory, can account for referential dependencies:

(163) Montalbetti's ((8), p. 36)

- a. If X c-commands Y, then Y is not an antecedent of X.
- b. The interpretation of an expression is given in one and only one way.
- c. The interpretation of an item cannot be given in terms of that item itself. That is, an element cannot be dependent on itself: *D(X,X).
- d. If X and Y share an antecedent and Y c-commands X, then Y is an antecedent of X.

How do the above principles and Linking Theory apply to the following sentences?

(164) He saw John

The above sentence has two linking possibilities:

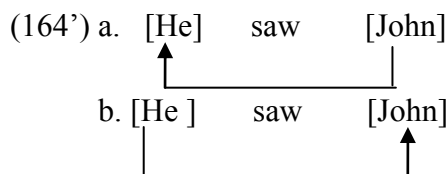

Recall principle (163b) (i.e. the interpretation of an expression is given in one and only one way) and given that names have inherent semantic content, (163b) can be turned into a theorem.

(165)- Names cannot have antecedents because they cannot be interpreted in more than one way.

- If they are interpreted in more than one way, principle (163b) would be violated. (164'a) is ruled out because *John* would be interpreted by itself and by *he*.

In (164'b), *John* is an antecedent of *he*. Moreover, *he* c-commands *John* and by (163a) ("if X c-commands Y then Y an antecedent of X") *John* cannot be an antecedent of *he*. Therefore the link (he, John) is ruled out and the whole sentence with the linking indicated is ungrammatical. Now, let us consider the following sentence:

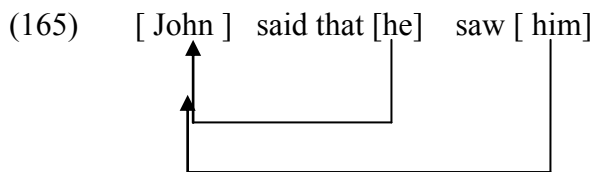

In (165), *he* and *him* are referentially dependent on *John*. (165) with the linking shown, will be interpreted as "John said that John saw John" (i.e. John said that John saw himself) which is not a possible interpretation of (165). (163d) could rule out (165). (163d) says that "if X and Y share an antecedent and Y c-commands X, then Y is an antecedent of X." Notice that in (165) both pronouns share an antecedent (*John*), and *he* c-commands *him*, therefore *he* is an antecedent of *him*. Another way of ruling out (165) is to appeal to condition B of Binding Theory as formulated in Higginbotham (1983a):

(166) Condition B: If A is a pronominal and B c-commands A in G(A), then B is not an antecedent of A.

The interaction of (163) and (166) rules out (165): according to (163), "he" is an antecedent of 'him', but according to (166) 'he' cannot be an antecedent of 'him' and this is a contradiction.

(163) alone does not rule out sentences. It helps interpret certain linking configurations and it has to be complemented by Condition B of Binding Theory. It is not the case that every sentence whose linkings are interpreted via (163) is ungrammatical. Thus, the following sentence is ungrammatical:

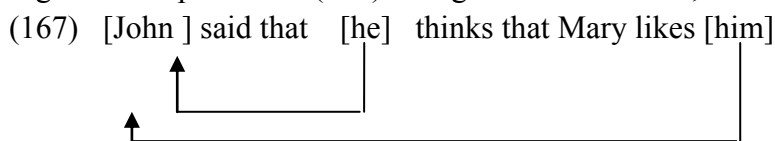

Montalbetti (1984: 40) departs from Higginbotham (1983a) and suggests that (163) is in fact a relinking convention. By the latter convention, structures like (165) and (167) are interpreted as if they were (168).

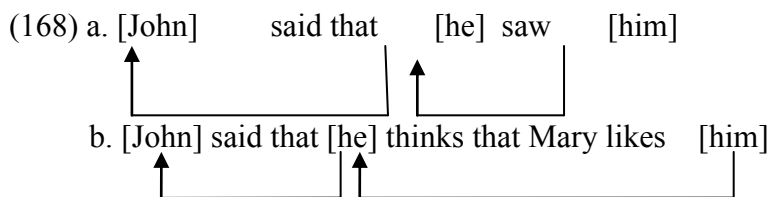

Thus, principles of grammar will apply to the sentences (168a, b) instead of (165, 167). The last principle proposed in (163), namely (163c), accounts for cases of circularity:

(169)

a. [A Picture of [it]]

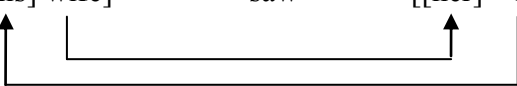

b. [[his] wife] saw [[her] husband]

The notion of dependence upon which principle (163c) relies is defined as follows:

(170) X is dependent on Y if:

- (i) Y is contained in an antecedent of X or
- (ii) for some Z, X is dependent on Z, and Z is dependent on Y.

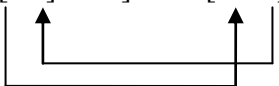
In (170), “is contained in” refers to reflexive: Y is always contained in Z if Y=Z. Thus, (163c) is expressed as *D(X, X) and D indicates the dependence relation. Consider, for example, (169a,b). In (169a), “it” is dependent on itself. For (169b) to be licit, at least three people have to be involved (instead of two as the linkings indicate). (169b) is in direct contrast with (171) below:

(171) [[his] wife] saw [John], [[her husband]]

To summarize: principles (163a-c) are part of the grammar and (163d) is a relinking convention.

8.11. The Overt Pronoun Constraint in Tuki

To account for the contrast between the absence of weak crossover effects for S-structure variable-binding and the presence of weak crossover effects for LF variable-binding, we will adopt and modify somewhat Montalbetti’s work on the binding of null pronouns by quantifiers in Spanish. Essentially, we will argue that formal variables cannot link to overt pronouns. First of all, we establish that the alternation overt/empty has an impact on quantifier and variable binding. We already know that Tuki has empty subject pronouns (referred to as *pro*). This language also has overt subject pronouns:

(172)

a. Present tense of *onyá* “to eat” (with pronouns)

(i) Nũ nyám “I eat”

I eat

(ii) mámú o- nyám “you eat”

You Agr- eat

(iii) ómwéné a-nyám “he/she eats

He/She Agr-eat

- (iv) Vítsú tu-nyám “we eat”
We Agr-eat
- (v) Vínú nu-nyám “you eat”
You Agr-eat
- (vi) Vámwéné va-nyám “They eat”
They Agr- eat

b. Present tense of *onyá* “to eat” (without pronouns)

- pro nyám “I eat”
- pro o-nyám “you eat”
- pro a-nyám “he/she eats”
- pro tu-nyám “we eat”
- pro nu-nyám “you eat”
- pro va-nyám “they eat”

As illustrated in (a) above, the overt subject pronouns in Tuki are:

(173) Tuki Overt Subject Pronouns		
Nũ	1 pers. Sg.	“I”
Mámú	2 pers. Sg.	“You”
Ómwéné	3 pers. Sg.	“he/she”
Vítsú	1 pers. pl.	“we”
Vítnú	2 pers. pl.	“you”
Vámwéné	3 pers, pl.	“they”

With this background information in mind, let us consider the following sentences:

(174)

- a. Vakutu ifundu vá-bungánám éé vámwéné vá-nyémém
Women many SM think that they SM beautiful
“Many women think that they are beautiful”
- b. Vakutu ifundu vá-bungánám éé pro vá-nyémém
Women many SM think that pro SM beautiful
“Many women think that they are beautiful”

(174b) is ambiguous between the coreferential and bound readings. (174a) is unambiguous: the pronoun can only be interpreted as coreferential, that is the pronoun in (174a) cannot be interpreted as a bound variable. The presence of an overt pronoun in (174a) versus its absence in (174b) may account for the contrast in interpretation between both sentences. The same contrast is observed in the following constructions that contain different quantifiers:

(175)

- a. Vakutu vamó va-bungánám éé vámwéné vá-nyémém

women some SM think that they SM beautiful

“Some women think that they are beautiful”

b. Vakutu vamó va-bungánám éé pro vá-nyémem

women some SM think that pro SM beautiful

“Some women think that they are beautiful”

(176)

a. vǎdzu vatatú va- mu- údza éé vámwéné vá- nú- éndam na sukuru
children three SM P1 say that they SM F1 go to school

“Three children said that they would go to school”

b. vǎdzu vatatú va- mu- údza éé pro vá- nú- éndam na sukuru
children three SM P1 say that pro SM F1 go to school

“Three children said that they would go to school”

Invariably the sentences containing an overt pronoun cannot be interpreted as containing a bound pronoun. However, the empty pronoun may have a bound reading. It seems to be the case that a quantifier expression may not bind an overt pronoun. If the antecedent of a pronoun is not a quantifier expression, the alternation overt/empty is invalid.

(177)

a. Putá a- bungánám éé omwéne a-nyémem

Putá SM thinks that she SM beautiful

“Putá thinks that she is beautiful”

b. Puta a- bungánám éé pro a-nyémem

Putá SM thinks that pro SM beautiful

“Putá thins that she is beautiful”

The two sentences in (177) have the same interpretation, confirming thereby that the alternation overt/empty pronoun matters only when the binder is a quantifier expression.

(178)

Vakutu ifundu vá-bungánám éé vanumutu vábú vá-nyémem

women many SM think that husbands their SM beautiful

“Many women think that their husbands are handsome”

In (178), the pronoun *vábú* “their” can be bound by the quantifier expression in the matrix clause. The same situation obtains in the following sentence:

(179)

Vakutu ifundu vá-dingam éé Tom Selleck a- dzará ná abu

women many SM love that Tom Selleck SM talk to them

“Many women want Tom Selleck to talk to them”

Once again, a quantifier expression binds the overt pronoun *abu* “them”. But notice that the pronouns in (178) and (179) occur in configurations where the alternation overt/empty pronoun may not obtain. In Tuki, empty objects of prepositions are disallowed; therefore a pronoun has to show up in (179). Similarly, empty possessives are allowed in Tuki only in the case of inalienable possession, (see example below) and since (178) is not such a case, the presence of the possessive pronoun is required. (178) and (179) suggest that an overt pronoun may not be bound by a quantifier expression when the overt/empty pronoun alternation obtains. Let us consider the following sentences:

(180)

a. *vakutu ifundu vá- mu- údza éé pro vá- bungánám éé vámwéné vá- nyemém*
women many SM P1 say that pro SM think that they SM beautiful
“Many women said that they think that they are beautiful”

b. *vakutu ifundu vá- mu- údza éé Puta a- bungánám éé vámwéné vá- nyemém*
women many SM P1 say that Puta SM think that they SM beautiful
“Many women said that Puta thinks that they are beautiful”

Assume that when the quantifier expression *vakutu ifundu* “many women” raises at LF, it leaves a variable. Adopting the Linking Theory as modified in Montalbetti’s (1984) dissertation, in (180), *pro* is linked to the variable left by LF movement of *vakutu ifundu* “many women” and the overt pronoun *vámwéné* “they” is in turn linked to *pro*. The latter empty category can be bound in (180). Surprisingly, the overt pronoun *vámwéné* “they” can also be bound in (180) and act as a bound variable. Now, notice that in (180) there is no *pro* intervening between the quantifier expression *vakutu ifundu* “many women” and the overt pronoun *vámwéné* “they”. This overt pronoun cannot be bound by the quantifier expression or its variable. Therefore, it cannot be interpreted as a bound variable. As pointed out by Montalbetti, the binding of an overt pronoun by a quantifier is not affected by the degree of embedding. An intermediate bound *pro* may, however, play an important role. Hence the contrast between (180a) and (180b). In this respect, consider the following sentence in which the overt pronoun is deeply embedded and separated from *pro* by a clause:

(181)

vakutu ifundu vá- mu- údza éé pro vá- bungánám éé Puta a- mu-uba éé vámwéné
women many SM P1 say that pro SM think that Puta SM P1 hear that they
va- nyemém
SM beautiful
“Many women said that they think that Puta heard that they are beautiful”

In (181) the overt pronoun *vámwéné* “they” can be bound. However, if we replace *pro* with a phonetically realized pronoun, the overt will not be bound. In view of facts such as these, it seems to be the case that for an overt pronoun to be bound, it has to be linked to a bound pronoun. Bound pronouns

(or semantic variables) should be distinguished from formal variables. Formal variables cannot license the bound interpretation of an overt pronoun as evidenced by the fact that in the following construction the overt pronoun cannot link to the variable created by LF movement of the quantifier expression:

(182)
 [vatu ifundu] x vá-bungánám éé vámwéne vá- timbám nguru
 men many SM think that they SM possess strength
 “Many people think that they are strong”

In (82) x is a formal variable (i.e. it is an empty category in an argument position linked to a lexical operator in an A-bar position (Montalbetti (1984:93)). The overt pronoun in (182) cannot have a bound reading. This provides evidence that a formal variable does not license the bound reading of an overt pronoun. To accommodate similar facts in Spanish, Montalbetti proposes the Overt Pronoun Constraint (repeated here for convenience).

(183) Overt Pronoun Constraint (OPC)
 Overt pronoun cannot link to formal variables iff the alternation overt/empty obtains.

Now, we are in a position to take up the contrast between the absence of weak crossover effects for S-structured variable-binding and the presence of weak crossover effects for LF variable-binding:

(184)
 a. ǎndzu_i nǎsi wáá_i a- dingám ec_i
 who mother his SM loves
 “Who does his mother loves?”
 b. ǎndzu_i nǎsi wáá_i a- dingám omwéne_i
 who mother his SM loves him
 “Who does his mother loves him?”

(184) above shows what we have already know: namely that WCO effects are nonexistent in Tuki at S-structure. In section 8, we have attributed this state of affairs to the fact that gaps in Tuki wh-constructions such as (184) are non-overt resumptive pronouns (and therefore semantic variables) rather than formal variables. This explains why (184), as opposed to its English equivalent, is grammatical. In (184b), the resumptive pronoun is phonetically realized. (184a-b) the same status of grammaticality. Now, why is the following sentence ungrammatical?

(185)
 *Nǎsi wáá_i a- dingám [mutu óngimá]_i
 mother his SM loves man every
 “His mother loves everyone”

At LF, the quantifier expression *mutu óngíma* “everyone” raises to sentence-initial position, deriving thereby the following representation:

(186)
 [mutu óngima]_i nǎsi wáá_i a- dingám x_i
 man every mother his SM loves
 “Everyone, his mother loves”

x_i is a formal variable created by the LF raising of the quantifier expression. Here a resumptive pronoun (or a semantic variable) may not occupy the spot vacated by *mutu óngíma* “everyone”. Descriptively, it appears that a formal variable may not bind a pronoun to its left (a prohibition which is reminiscent of the Leftness Condition (Chomsky (1977))). Adopting Linking Theory as developed in Montalbetti, it can be said that a formal variable may not link to a pronoun. Notice that in (185-6) the possessive pronoun is phonetically realized. What happens if the pronoun is non-overt? Surprisingly, when the pronoun is null, (185) becomes grammatical:

- (187)
 Nۆsi a- dingám mutu óngima
 mother SM loves man every
 “His mother loves everyone”

Recall that in cases of inalienable possession, the possessive pronoun may be dropped although it is semantically recoverable through discourse. The grammaticality of (187) suggests that an overt pronoun may not be bound by a formal variable. This situation is reminiscent of Montalbetti’s Overt Pronoun Constraint (OPC). To cover cases such as (185) and (187) (WCO effects at LF), let us add another clause to the OPC.

- (188) Overt Pronoun Constraint
- a. Overt pronouns cannot link to formal variables iff the alternation overt/empty obtains.
 - b. Formal variables cannot link to overt pronouns iff the alternation overt/empty obtains.

8.12. Palauan

Before we end this chapter, it would be interesting to contrast the results obtained here with those that have been reached in view of the research on languages such as Palauan (Georgopoulos (1985)) and English (Chomsky(1982)). Georgopoulos shows that in Palauan wh-constructions both gaps and overt pronouns are S-structure variables which interact with an agreement rule:

- (189) The Agreement Rule.

In the structural domain between an A-bar binder and its variable, the verb agrees with:

- a. the case of the clausal argument containing the variable, or
- b. the case of the variable.

Both pronouns and gaps may (co) occur as S-structure variables bound by the same antecedent in coordinate structures and other types of wh-constructions. As for the wh-phrases in A-bar positions, it is assumed that they are not base-generated in these positions, rather extracted by movement. It thus appears that Palauan patterns with Tuki with respect to the behaviour of resumptive pronouns in wh-constructions. One notable difference between Tuki and Palauan is the agreement rule which operates in the latter language but not in the former. In Palauan, A-bar binding has morphological as well semantic

consequences. Thus depending on whether the wh-item in A'-position has the grammatical function subject or object, the clause with a subject or object variable will take realis or irrealis morphology. In the following constructions (190), a subject is topic in (a), a non-subject in (b); in the former the verb is realis (R), and in the latter irrealis (IR):

(190)

a. Sensei_i[a omes er a rengalek---_i]

teacher R-IM-see P. children

“The teacher is looking at the children”

b. A rengalek_i [al- omes er tir_i sensei]

children IR-3 IM-see P them teacher

“The teacher is looking at the children”

Georgopoulos argues that the subject/non-subject distinction made by Palauan grammar can be described in terms of abstract Case: subjects are assigned Nominative Case and other grammatical functions receive some non-Nominative Case. To capture the effects of verb morphology on Palauan wh-constructions, she postulates an agreement rule referring to Case (see (188) above). The agreement facts displayed in Palauan wh-constructions do not obtain in Tuki. Tuki (and Palauan) differ(s) from English in that in the latter language, wh-phrases that are in A'-positions get there through movement, rather than being base-generated (as in the former languages); in the normal case, this movement necessarily leaves a gap that is co-indexed with its antecedent, the relationship between the gap and its antecedent in an A'-position is regulated by Bounding Theory; and the gap is properly governed(= antecedently governed or lexically governed). The distinction between Tuki and English leads one to the conclusion that wh-construction can be derived either through extraction or base-generation. Moreover, unlike what is claimed in Chomsky (1982) , it has been shown that resumptive pronouns in languages endowed with a genuine resumptive pronoun strategy can have the status of S-structure variables.

8.13. Concluding Remarks

In this chapter, we have shown that in Tuki, a focused NP or the head of the relative clause can be associated either with a resumptive pronoun or a gap. Tuki allowing violations of island constraints, we have claimed that gaps in Tuki should be analyzed as null resumptive pronouns which do not involve movement, on analogy with the full resumptive pronoun strategy available in the language. Further evidence for a parallelism between gaps and full resumptive was provided by the fact that it is possible to conjoin a clause containing a gap and a clause containing a resumptive pronoun. Full resumptive

pronouns as well as gaps do not exhibit weak crossover effects in Tuki; this constitutes further evidence that these gaps are pronominals.

We have also argued that in Tuki wh-constructions in which resumptive pronouns are involved, wh-phrases and relative pronouns are base-generated in FP and CP positions respectively. In the case of content question formation, it has to be the case that at least some wh-items substitute to the specifier position of FP via syntactic movement: items such as the non-referential and referential adjuncts “how”, “why”, “when”, “where” which are not generally associated with resumptive pronouns.

CHAPTER NINE

DP structure and concord

Introduction

Since Abney's (1987) seminal work, the interest in the internal structure of nominal constructions has grown considerably to the extent that at least three aspects of syntactic theory have undergone extensive and intensive investigation (Longobardi 2001). More precisely, word ordering within the composition of DP has attracted the researcher's attention. Cinque (1994) argues that these various orders can be accounted for in terms of a layered functional structure inside the DP. Scott (2002) and Laenzlinger (2005) amend Cinque's hierarchy of nominal functional projections. Similarly, several linguists such as Vangsnes (1999), Zamparelli (2000), Bruge (1996, 2002), Rijkhoff (2002), Cinque (2004, 2005), Borer (2005), Julien (2005), Svenonius (2008)...etc have attempted to expand the internal functional structure of DP. Specifically, Svenonius (2008) has argued that in principle, there are three different factors which can affect word order: the basic hierarchical structure, the order in which the function and the argument linearize when they combine, and movement. The first factor is generally taken to be invariant. Kayne (1994) has proposed essentially that the second factor is invariant as well, leaving movement as the only important factor in word order variation across languages. Precisely, the movement of the Noun (Phrase) will be argued to be the main reason for word order variation inside DP in Tuki.

Within the specific Bantu arena, Carstens (1991), Nkemnji (1995) and Tamanji (1999, 2000), Tamanji and Ndamsah (2004), Kouankem (2010) (the list is far from being exhaustive) have described and analysed the DP structure of Kiswahili, Nweh, Bafut, Limbum and Medumba respectively. This work draws inspiration from the previous investigations of the DP internal structure of natural languages. It specifically analyses the DP structure and concord in Tuki. The distribution of determiners (Poss and Dem) is examined as well as the pattern of agreement between them and the head N. Moreover, the occurrence of a so called locative reinforcer inside the DP generates some questions of which answers seem to be provided. Furthermore, an account of the apparent variation of word order(s) within the Tuki DP is proposed along the lines of Kayne's (1994) antisymmetric approach. On the basis of his definition of the notion of asymmetric c-command, Kayne's antisymmetric hypothesis stipulates a rigid specifier > head > complement order across languages. "According to this order, a head which appears in the structure to the left of its specifier must have raised to a head position asymmetrically c-commanding its trace and the specifier" (Bruge 1996, 2002). The theoretical framework adopted in this endeavour is inspired by Cinque's (1993, 1994) analysis according to which 'only the head noun moves to higher functional heads, while modifiers stay in their base positions unless they need to check some feature in a higher specifier' (Bruge 1996, 2002). In fact, it will be argued in this work that the NP moves to substitute for the specifier position of the DP in order to derive the attested word order.

Kayne's definition of asymmetric c-command refers exclusively to categories; segments are not allowed to take part into this relation.

"X c-commands Y iff X and Y are categories and X excludes Y and every category that dominates X dominates Y".

9.1 Status and distribution of determiners

Tuki possessive and demonstrative determiners can either precede or follow the head noun inside the DP, depending on the overall meaning assigned to the latter structure. But generally, determiners follow the noun thereby deriving the basic word order N-D. This word order can be changed into D-N in order to obtain a contrastive focus interpretation whereby the determiner is said to be focused. Moreover, a given noun can take two determiners in the following order: N – Possessive Determiner – Demonstrative Determiner. This latest word ordering may undergo a number of changes that are subject to semantic constraints. In principle, any one of the two determiners may be focused and may precede therefore the head N. Furthermore, a third determiner may follow the Poss and the Dem Dets giving birth to a construction ordered as follows N – Poss – Dem – Dem. The third determiner in the above structure seems to be a Dem that behaves like a presentative. Bearing in mind that there is also an adverbial locative reinforcer that co-occurs with the determiners, one has to wonder then how DP is structured in this language. The answer to this indirect question is provided as the work proceeds.

Before delving into the analysis per se, it is worth asking the question whether all types of determiners are attested in Tuki, apart from demonstratives and possessives. Such a question is by no means trivial.

Longobardi (2001) indicates that "certain languages are known to introduce the vast majority of their nominal structures by means of one (and often *at most* one) item taken from the (closed) classes of demonstratives, articles, possessives, quantifiers or cardinal numerals. These five classes, each with peculiarities of their own, are all roughly identified already in traditional grammar and can rather well be defined in relatively obvious semantic terms. As a first approximation, such classes, which, as noticed, normally seem to be mutually exclusive, are collected, precisely on these distributional grounds, under the hyperonymic grammatical category of *determiners* and, as far as their surface location is concerned, in recent works have been variously assigned to the head or specify position of a D projection.

Among other things, determiners seem to typically establish the definite/indefinite interpretation of the nominal and to often select between a mass or count reading of morphologically singular head nouns."

Tuki seems to be devoid of definite, indefinite and partitive articles. Thus there are no equivalents of the French definite articles *le, la, les*, indefinite articles, *un, une, des*, partitive articles *du, de la, de l', des*...etc, or English definite article *the*, indefinite article *a*.

The conditions of occurrence or omission of determiners have been discussed and sometimes parameterized in the scientific literature (Chomsky 1965; Abney 1987; Longobardi 1994, 1996, 2001; Bernstein 2001; Radford 2004). How does Tuki fare with respect to languages that appear to be similar? In particular, it has been argued that for languages that allow determinerless NPs, the latter cannot occur in argument functions. Why and how did researchers reach this conclusion? Longobardi (2001) summarizes the reasoning underlying that generalization as follows. “Languages superficially appear to differ heavily in the possibility of omitting an overt determiner. However, various constraints on omission have been identified in the recent past. A first principle and a very characteristic feature of the crosslinguistic pattern is that languages seem to distribute in a “subset “or inclusiveness hierarchy with respect to omission environments. In other words, we can review the best known language types in a sequence progressively enlarging the class of environments allowing superficially determinerless NPs.

The most restrictive type seems so far to be best instantiated by French, at least among Indo-European languages. The pattern of determiner omission in French appears close to justify an influential proposal originally made by Szabolcsi (1987), later adopted in Stowell (1989, 1991) and Longobardi (1994), namely that a D position (and its projection) is only necessary for *argument* nominals and may often be dispensable for *non-arguments*. Such a principle has been formulated in forms such as the following:

(1) DPs can be arguments, NPs cannot.

Since in Tuki it is difficult to establish the definite/indefinite interpretation of the nominal due to the chronic absence of the articles, how then to account for the grammatical status of the following sentences:

(2)

a. iyere a –mú –én –á vâdzú
 teacher SM P1 see FV children

“(The) teacher saw the children”

b. vâdzú vá -mú –én –á iyere
 Children SM P1 see FV teacher

“(The) children saw a/ the teacher”

Unless one argues that the D positions are not phonetically realized (though present) and that NPs are part of DPs, one would be hard pressed to show that NPs cannot be argument(s) in Tuki.

Tuki bare nouns and singulars

Tuki bare nouns can occur freely in argument positions.

(3)

a. Para a – mú –dw – ĩ okutu

priest SM P1 baptize FV woman

“The /a priest baptized the /a woman”

b. Iyere a – mú – ún –á imgbémé ná ndzáná

teacher SM P1 kill FV lion in forest

“The /a teacher killed a /the lion in the/a forest”

Moreover, Tuki bare nouns can receive an indefinite and a definite interpretation. The indefinite interpretation is either existential or generic.

(4)

Mutu a – tá – béy – á

man SM Neg bad FV

“Man is not bad”

The above sentence means *no man is bad*, i.e. in every human being, there is good and evil. Tuki bare nouns can equally be assigned an interpretation similar to the one that NPs in French receive when they are introduced by definite or partitive articles.

(5)

a. mĩríki má –mú –mán –a na kĩisini

milk SM P1 finish FV in kitchen

“Milk is finished in the kitchen”

b. Nû ngu –mú –ány –ó mĩríki na kĩisini

I SM P1 drink FV milk in kitchen

“I drank milk in the kitchen”

In the above sentence, in (a) particularly, the NPs *miriki* and *kiisini* can only receive a definite interpretation, although it is possible to force bare partitive reading into the grammatical subject of (a). *Miriki* has a partitive interpretation. Tuki bare nouns can also occur as kind –referring names, i.e. as referential or definite generics, in argument positions of kind -level (in Carlson’s 1977 sense) of *particular* or *episodic* sentences (Longobardi 2001).

(6)

ka’ká’a’ a –ma- ĩngân–a ná Áfrika ará vá -táng vá –ma–dzêt–á ná Ámerika
Cacao SM P2 enter FV in Africa when cl1 Whites SM P2 come back from America

“Cacao entered Africa when Whites came back from America”.

In environments similar to the above sentence, the French language would use an overt definite article.

(7) le cacao a ‘été’ introduit en Afrique quand les Blancs sont revenus d’Amérique.

With respect to determinerless NPs, Longobardi (2001) has proposed a rough hierarchy of inclusiveness ranking languages.

- (8) a. languages with no bare nouns.
- b. languages with *stricter* bare nouns
- c. languages with *freer* bare nouns.

In Tuki, contra what obtains in other languages, singular count common nouns can appear in argument function positions as well as in non –argument function positions.

(9)

yendze i – mú –fyân –a na ádongo yá íyére

House SM P1 burn FV in village of teacher

“A/the house caught fire in the teacher’s village”.

The prediction that in all these languages “singular count common nouns appear superficially determinerless only in non–argument function” may not hold in Tuki since the latter language “allows all types of determinerless argument nominals, including bare singulars, corresponding to either a definite or an indefinite interpretation of Western European languages” (Longobardi 2001). On the basis of the following generalization proposed by Crisma (1997) and rephrased by Longobardi (2001),

(10) No language exhibits any free variation between presence and absence of a determiner for nominal arguments.

Tuki is correctly predicted to be devoid of any definite or indefinite lexical article. It also follows from the same prediction, as illustrated above, that Tuki allows bare singulars as well as bare nouns. This language can now integrate the fuller hierarchy of inclusiveness ranking languages with respect to bare nouns and singulars suggested by Longobardi (2001).

(11)

- a. Languages with no bare nouns (French).
- b. Languages with *stricter* bare nouns (apparently the rest of Romance such as Spanish, Italian ...)
- c. Languages with *freer* bare nouns (English and perhaps most of Germanic).
- d. Languages with indefinite bare singulars (and only a definite lexical article such as Icelandic, Celtic, Hebrew...).
- e. Languages with ambiguous bare singulars (i.e. articleless languages such as Russian, Czech, Latin, *Tuki*...).

9.1.2 Possessive determiners

In Tuki, what we call the possessive determiner accompanies a noun or a noun phrase. When the substantive is recoverable from the (discourse) context, the determiner can be used alone and it refers to the precedingly used noun (phrase); in this case, it functions like a pronoun:

(12)

Putá a- ma´- namb- a cwí ráâ ídzó. Vedá, nû
 Putaù SM P2 Cook FV Fish Her Yesterday but I

nga- ta- namb- A Raáme
 SM Neg Cook FV my/mine

“Putá cooked her fish yesterday. But I did not cook mine”

The form of the possessive determiner is in agreement with the morphological class of the noun (phrase). In the following table, Tuki noun classes are illustrated with a few examples of nouns, possessive determiners (1st, 2nd and 3rd person singular, 1st, 2nd and 3rd person plural):

Noun class	Word list	Possessive determiners					
		1 st Sg	2 nd Sg	3 rd Sg	1 st Pl	2 nd Pl	3 rd Pl
1	Mutu “man”	ámè	Woó	waá	íítsú	íínú	Wíínú
2	Vatù “men, people”	vamè	Voó	vaá	viítsú	viínú	Vaábù
3	Ongurù “foot”	raámè	roó	raá	riítsú	riínú	raábù
4	inguru “feet”	rame	roó	raá	riítsú	riínú	rábu
3a	nkúkúmà “chief”	waámE	woó	waá	wiítsú	wiínú	raábu
4a	vankúkúma “chiefs”	vaámε	voó	vaá	vítsú	vínú	Vábu
5	isútù “belly”	raámε	roó	raá	niítsú	niínú	naábù
6	musútù “bellies”	mwaámε	mwoó	mwaá	mítsú	mínú	mwábu
5/6a	matí “saliva”	maámε	moó	maá	miítsú	miínú	mwaábù
7	ikúndá “bed”	yaámε	yoó	yaá	yíítsú	yíínú	yaábu
8	Vikúndá “beds”	vyaámε	vyoó	vyaá	vítsú	vínú	Vyábu
9/10	ndone “cow”	rámε(Sg) raámÉ(pl)	roo róo	raa ráa	riítsú ritsu	riínu riínú	raábu rábu
11	pandú “place”	rámε	róo	ráa	riítsú	riínù	rábu
6a	pandú “places”	raámε	róo	ráa	Rit su	riínú	raábu
11	noné “leaf”	naámε	nóo	náa	niítsú	niínu	naábu

	nugwá “death”	naáme	nóo	náa	níitsú	níinu	naábu
13	toné “leafs”	taáme	tóo	táa	títsu	tínú	tábu
	tugwá “deaths”	taáme	tóo	táa	títsu	tínú	tábu
14	Wusí “day”	waáme	wóo	wáa	wítsu	wínú	wábu
6a	Masí “days”	maáme	móo	máa	mítsu	mínú	mábu
18	ikara “mat”	yaáme	yóo	yáa	yítsu	yínú	yábu
19	Mukara “mats”	mwaáme	mwóo	mwáa	mwítsu	mwínu	mwábu
3	orese “rice”	aáme	wóo	wáa	wíitsu	wíínù	waábù
	ongúná “sun”	ràame	ròò	râa	rítsu	rínú	rábu
6a	Manono “work”	maáme	móo	máa	míitsu	míínù	maábu
8	vitá “war(s)” vibufa “vegetables”	vyaáme	vyóo	vyáa	viitsu	viínu	vyábu
9	Nútú “body”	raáme	róo	râa	riitsu	riínu	raábu
10	inwíí “smoke”	raáme	róo	râa	riitsu	riínu	raábu
18	Manó “disease”	maáme	móo	máa	míitsu	míínu	maábu
5	atoki “throat”	yaáme	yóo	yáa	yíitsu	yíínu	yaábu
13	Vitoki “throats”	vyaáme	vyóo	vyáa	Víitsu	viínu	Vyaábu
3	Otsó “ear”	raáme	róo	râa	riitsu	riínu	raábù
6	atsó “ears”	râme	róo	râa	rítsu	rínú	rábu
10	ifóó “pot”	raáme	róo	râa	rítsu	rínú	rábu
9/13	Nyimá “baks”	raáme(sg) râme (pl)	róo (sg) róo (pl)	râa (sg) râa (pl)	riitsu(sg) rítsu (pl)	rínú sg) rínú (pl)	raábu(sg) rábu (pl)
16/16a	Fumú “place”	waáme	wóo	wáa	wíitsu	wíínù	Waábu

9.1.3 Demonstrative determiners

What was said above of the possessive determiner is also valid for the demonstrative determiner. In the following table, Tuki noun classes are illustrated with a few examples of nouns and demonstrative determiners (pronouns) (near speaker (NS), and far from speaker and listener (FSL)):

Noun class	Word list	Demonstrative determiner	
		NS	FSL
1	mùtù “man”	Ódzù	Ódzíí
2	vàtù “men, people”	Ávà	Ávíí
3	òngùrù “foot”	Ódzù	Ódzíí
4	ìngùrù “feet”	àádzE	Aádzíí
3a	nkúkùmà “chief”	Ódzù	Ódzíí
4a	vànkúkùmà “chiefs”	Aávà	Aávíí
5	ìsútù “belly”	Íídzíí	Íídzíí
6	mùsútù “bellies”	Aámà	Aámíí
5/6a	màtí “saliva”	Aámà	Aámíí
7	ìkúndá “bed”	àáyE	Aáyíí
8	vìkúndá “beds”	Íívíí	Íívíí
9/10	ndònè “cow”	àádzE (sg) íídzíí (pl)	àádzíí (sg) íídzíí (pl)
11	pàndú “place”	àádzE	àádzíí
6a	pàndú “places”	íídzíí	íídzíí
11	nòné “leaf” nùgwá “death”	òónù àánè	Oónwíí àáníí
13	tòné “leafs” tùgwá “deaths”	íídzíí ?	Íídzíí ?
14	wùsí “day”	òówù	Oówíí
18	ìkàrà	íídzíí	Íídzíí

	“mat”		
19	mùkàrà “mats”	Aámà	Aámíí
3	òrèsè “rice” òngúná “ sun”	óódzú óódzú	Oódzwíí óódzwíí
6a	màsí “days” mànònò “work”	Aámà	Aámíí
8	vítá “war(s)” vìbùfà “vegetables”	ṭíví	ṭívíí
9	nútú “body”	àádzè	àádzíí
10	ṭínwíí “smoke”	ṭídzíí	ṭídzíí
18	mànó “disease”	Aámà	Aámíí
5	àtòkì “throat”	àáyE	Aáyíí
13	vítòkì “throats”	ṭíví	ṭívíí
3	òtsó “ear”	Oódzú	Oódzwíí
6	àtsó “ears”	àádzè	àádzíí
10	ṭífóó “pot”	ṭídzíí	ṭídzíí
9/13	nyĩmá “baks”	àádzè (sg) àdzè (pl)	àádzíí àdzíí

9.2 The distribution of the possessive determiner

In Tuki, the possessive determiner follows the noun it modifies and agrees with it in noun class:

(13)

a.

m-	utù	(w-)	Ámε
Cl1	Man	Agr	My

“my man”

b.

v-	Utu	v-	ámε
Cl2	Man	Agr	my

“my men”

(14)

a.

ò-	ngùrú	r-	àámè
Cl3	Foot	Agr	My

“my foot”

b.

i-	ngurú	r-	Aáme
Cl4	Feet	Agr	My

“my feet”

(15)

a.

∅	nkúkúmà	w-	Aáme
Cl3a	Chief	Agr	My

“my chief”

b.

va-	nkúkúmà	v-	Aáme
Cl4a	Chiefs	Agr	My

“my chiefs”

(16)

a.

ĩ	sutú	n-	Aáme
Cl5	belly	Agr	My

“my belly”

b.

Mù	sùtú	mw-	Aáme
Cl6	Belly	Agr	My

“my bellies”

(17)

a.

∅-	ikúnda	y-	Aáme
Cl7	bed	Agr	My

“my bed”

b.

v-	ìkúndà	y-	àámE
Cl8	bed	Agr	My

“my beds”

Notice that the possessive determiner carries a marker that agrees in (noun) class with the noun it modifies. It is made up of two morphemes: an agreement marker and a lexeme or a lexical morpheme ((a)áme).

More examples are provided below that confirm the N-D distribution in Tuki:

(18)

a.

n-	oné	n-	Aáme
Cl11	Leaf	Agr	My

“my leaf”

b.			
t-	òné	t-	àámè
Cl13	leaf	Agr	My
“my leafs”			
(19)			
a.			
w-	ùsí	w-	àámè
Cl14	Day	Agr	my
“my day”			
b.			
m-	así	m-	àámè
Cl16a	Day	Agr	My
“my days”			
(20)			
a.			
ĩ-	kara	y-	Aámè
Cl18	Mat	Agr	My
“my mat”			
b.			
mù-	kara	mw-	aámè
Cl19	Mat	Agr	My
“my mats”			
(21)			
a.			
à-	toki	y-	Aámè
Cl15	Throat	Agr	My
“my throat”			
b.			
vĩ-	tòkĩ	vy-	àámè
Cl13	Throat	Agr	my
“my throats”			

The above examples all exhibit singular and plural genders. However, not all Tuki nouns display such pairs. Below are a few examples:

(22)

a.			
∅-	fùmú	w-	àámè
Cl16/16a	Place	Agr	my
“my place”			
b.			
∅-	inwíí	r-	aámè
Cl10	Smoke	Agr	My
“my smoke”			

c.			
∅-	Nútú	r-	àámε
Cl9	Body	Agr	My
	“my body”		
d.			
∅-	òrèsè	∅-	àámε
Cl3	Rice	Agr	My
	“my rice”		
e.			
∅-	Màtí	m-	aámε
Cl5/6a	Saliva	Agr	My
	“my saliva”		

The data displayed above show that the head noun in this language precedes the possessive determiner and the latter agrees in class with the former. In the next section, a look is taken at the casting of demonstrative determiners in Tuki.

9.3 The distribution of the demonstrative determiner

The demonstrative determiner follows the head noun and agrees with it in noun class, as illustrated by the following examples:

(23)

a.			
∅-		mùtù	ódzù (Near speaker)
Cl1		Man	This
	“this man”		

b.

∅-	Mùt	ódzwĩ (Far from speaker and listener)
ù		
Cl1	Man	That
	“that man”	

(24)

a.			
∅-	vátù	àvá (NS)	
Cl2	Men	These	
	“these men”		

b.

∅-	vátù	àví (FSL)
Cl2	Men	Those
	“those men”	

(25)

a.			
∅-	Ngùrù	ódzù (NS)	
Cl3	Foot	this	
“this foot”			
b.			
∅-	Ngùrù	ódzwíí (FSL)	
Cl3	Foot	that	
“that foot”			
(26)			
a.			
ĩ-	Ngùrú	àádze (NS)	
Cl4	Feet	these	
“these feet”			
b.			
ĩ-	Ngùrú	aádzíí (FSL)	
Cl4	Feet	those	
“those feet”			
(27)			
a.			
∅-	nkúkùmà	ódzù (NS)	
Cl3a	Chief	this	
“this chief”			
b.			
∅-	nkúkùmà	ódzwíí (FSL)	
Cl3	Chief	that	
“that chief”			
(28)			
a.			
va-	nkúkùmà	àává (NS)	
Cl4a	Chief	these	
“these chiefs”			
b.			
va-	nkúkùmà	àávíí (FSL)	
Cl4a	Chief	Those	
“those chiefs”			
(29)			
a.			
ĩ-	sùtù	ĩídzi (NS)	
Cl5	Belly	This	
“this belly”			
b.			

ĩ-	Sùtù	ĩdzíí(FSL)	
Cl5	Belly	That	
“that belly”			
(30)			
a.			
mu-		sùtù	àámà (NS)
Cl6		Belly	These
“these bellies”			
b.			
mu-	sùtù	aámíí (FSL)	
Cl6	Belly	those	
“those bellies”			
(31)			
a.			
ĩ-	kúndá	àáyè (NS)	
Cl7	Bed	this	
“this bed”			
b.			
ĩ-	kúndá	àáyíí (FSL)	
Cl7	Bed	That	
“that bed”			
(32)			
a.			
vĩ-	Kúndá	íívĩ (NS)	
Cl8	Bed	these	
“these beds”			
b.			
vĩ-	Kúndá	ĩívíí(NS)	
Cl8	Bed	those	
“those beds”			

The above data clearly show that in Tuki the noun precedes the demonstrative determiner and the latter agrees in noun class with the former.

9.4 The internal constituency of the possessive determiner

It has been argued that the possessive determiner pretty much behaves like a lexical genitive. Kouankem (2010) has shown that both the possessive determiner and the lexical genitive provoke very similar tonal changes. From the above, it follows that the two items have an identical structure and that “the possessive determiner is in a genitive phrase generated in the same position as other genitives

containing full lexical genitives” (Kouankem 2010). This line of reasoning seems to draw support from the Tuki empirical material. In effect, if we consider the following constructions:

(33)
 Mwánà W Putá
 a
 Child Of Puta
 “Putá’s child”

(34)
 mwánà wámè or mwánà áme
 child my child my
 “My child”

One gets the impression that the possessive determiner is made up of the genitive marker *wa* “of” and its complement, the personal pronoun. The argumentation becomes stronger if the following constructions are considered:

(35)
 mwánà wĩtsù or mwánà ĩĩtsù
 child our child our
 “Our child”

(36)
 Vĩtsú tu- rang- á- m karátè
 we SM read FV Inc. book/letter
 “We read the book/letter”

Obviously, *wiètsuà* is a merger of *wa* “of” and the pronoun *iètsuà* “we”. So *wiètsuà* actually means “of us” and as (35) shows, the genitive marker (*wa*) sometimes can be abstract and not phonologically realised and in that case it is probably the dropping of the genitive marker that causes the lengthening of the first vowel of the pronoun [i]. If this reasoning is correct, then it is the following structure that generates the possessive determiner:

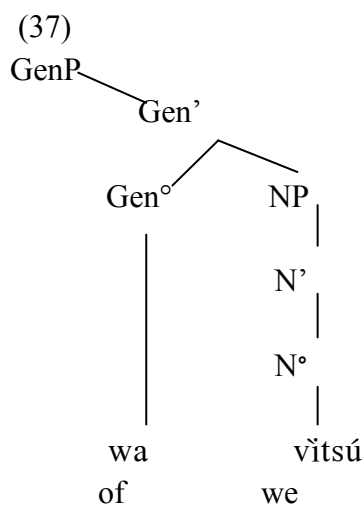

After cliticization of the pronoun *viətsuà* “we” into *wa* “of”, *wiətsuà* is derived, followed by the dropping of [w] and the lengthening of the following [i]:

a. Cliticization of *vĩtsú* “we” into *wa* “of” (*wa* + *vĩtsu*)

b. Obtention of *wĩtsú* “our”

wa + *vĩtsu* → *wĩtsú*

c. Dropping of [w] → *ĩtsú*

[w] → \emptyset / # ___

d. lengthening of [i] → *ĩĩtsú*

[i] → [+long] / # ___

So, according to the above, the possessive determiner is generated inside a GenP. Consequently, example (35) is generated in the following manner:

(38)

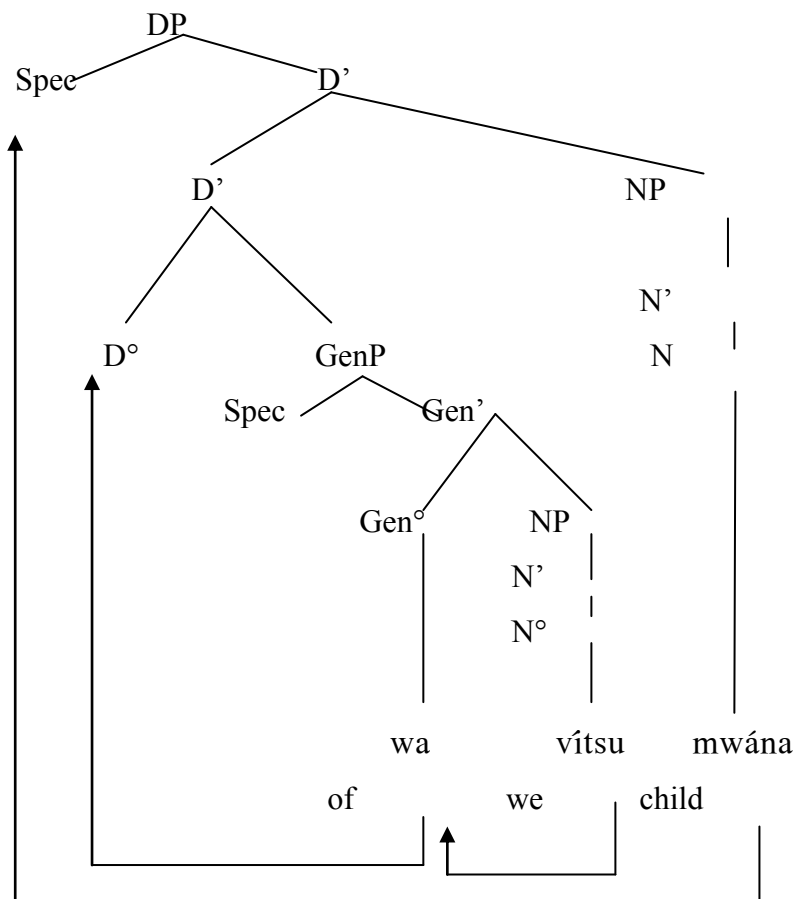

As the arrows on the phrase marker indicate, the pronoun (N°) *viətsu* raises and cliticizes on the genitive marker (Gen°) and lands in D° . The movement of the NP containing the head noun into the specifier position of DP ([Spec, DP]) is motivated by the fact that it must check therein the number-class features on the possessive determiner in the configuration of Spec-Head agreement à la Chomsky (1986, 1995). Notice that at the end of the derivation, the

resulting construction is the one in (35) where the word order is N-D. However, in some cases, the possessive determiner may precede the head noun:

(39)

a. v-	Ámɛ	v-	anà
Agr	My	Cl2	children
“My children”			

b. r-	Áámɛ	o-	nguru
Agr	My	Cl3	foot
“My foot”			

c. w-	Áámɛ	∅-	Nkúkúma
Agr	My	Cl3a	Chief
“My chief”			

d. mw-	Áámɛ	mu-	Sutu
Agr	My	Cl6	Belly
“My bellies”			

e. y-	Áámɛ	∅-	ikúnda
Agr	My	Cl7	bed
“My bed”			

In the above examples, the possessive determiner precedes the noun. So the word order in this case is D-N. The semantic interpretation of these constructions is such that the emphasis is on the determiner. So, for instance, (39a) means *MY children*, not somebody’s else ones, definitely!! These examples, therefore, are cases of contrastive focus. On the basis of Biloa (1992, 1995), Tamanji (1999), Rizzi (1997), Kouankem (2010), let us project a focus phrase (FocP) above DP:

(40)

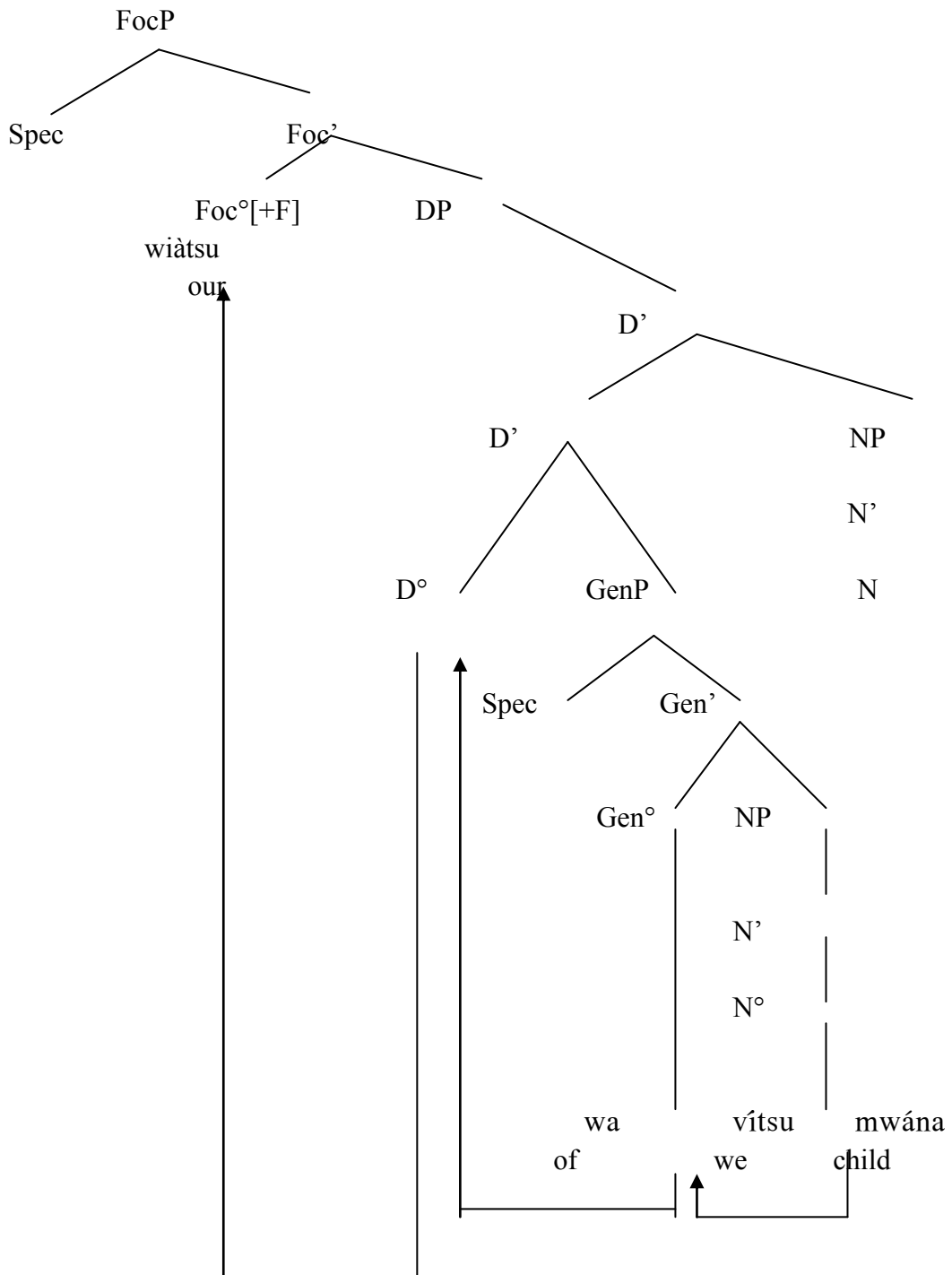

Foc° is endowed with a strong focus feature ([+F]). It is the latter feature that lures the possessive determiner from D° to Foc°. Remember that the NP *mwána* raises and substitutes for the specifier position of DP. When the possessive determiner moves from D° to Foc° (which position dominates the [Spec, DP] position), the resulting word order is D-N. The possessive determiner raises from D° to Foc° to check the +Foc feature. This accounts for the derivation of the constructions exhibited in (39a-e).

9.5 More on the distribution of the demonstrative determiner

As shown earlier, Tuki exhibits two types of demonstratives determiner: one demonstrative determiner means *this* (near speaker = NS) and the other one means *that* (far from speaker and listener = FSL). Both determiners follow the noun and agree with it in noun class. The following examples illustrate the distribution of the NS demonstrative determiner type:

(41)

a. m̀t̀t̀	<i>ódz̀</i>
Cl1 man	this
“this man”	
b. ing̀r̀	<i>áàdz̀</i>
Cl4 feet	these
“these feet”	
c. vank̀k̀m̀	<i>áàv̀</i>
Cl4 chiefs	these
“these chiefs”	
d. m̀s̀t̀	<i>áàm̀</i>
Cl6 bellies	these
“these bellies”	
e. ìk̀nda	<i>áaỳ</i>
Cl7 bed	this
“this bed”	
f. noné	<i>óonu</i>
Cl11 leaf	this
“this leaf”	
g. wusí	<i>óowu</i>
Cl14 day	This
“this day”	
h. òr̀s̀	<i>ódz̀</i>
Cl7 rice	This
“this rice”	
i. v̀t̀	<i>ìv̀</i>
Cl8 war	This
“this war”	

j. ñfóó	<i>ñidzi</i>
Cl7 pot	His
“this pot”	

In the following examples, the distribution of FSL demonstrative determiners type is illustrated with nouns from 10 classes that were used above to illustrate NS demonstrative determiners:

(42)

a. m̀t̀t̀	<i>Odzwíí</i>
Cl1 man	That
“that man”	

b. ñngúr̀	<i>àdzíí</i>
Cl4 feet	those
“those feet”	

c. vankúkùm̀	<i>áàvíí</i>
Cl4 chiefs	those
“those chiefs”	

d. m̀s̀t̀t̀	<i>òmwíí</i>
Cl6 bellies	those
“those bellies”	

e. ñkúnda	<i>áàvíí</i>
Cl7 bed	that
“that bed”	

f. ǹné	<i>ó̀nwíí</i>
Cl11 leaf	that
“that leaf”	

g. ẁsí	<i>ó̀wíí</i>
Cl14 day	this
“this day”	

h. òr̀s̀	<i>ó̀dzwíí</i>
Cl7 rice	this
“this rice”	

i. vita	<i>íivíí</i>
Cl8 war	this
“this war”	

j.

ĩfóó ãdzíí

Cl7 pot this

“this pot”

FSL demonstrative determiners, just like their NS counterparts, agree in class with the head noun. In the above examples, both types of demonstrative determiners follow the head noun. In a context of a contrastive focus reading, both NS and FSL demonstrative determiners can precede the noun. Agreement still obtains between the determiner and the head noun. (43) NS demonstrative determiner:

a. ódzù mùtù

This Cl1 man

“this man”

b. áadzɛ ingúru

These Cl4 feet

“these feet”

c. áàvà vankúkùmà

These Cl4 chiefs

“these chiefs”

d. áàmà mùsùtù

These Cl6 bellies

“these bellies”

e. áàyɛ ãkúnda

This Cl7 bed

“this bed”

(44) FSL demonstrative determiners:

a. ódzwíí Mùtù

That Cl1 man

“that man”

b. áàdzíí ãngúrù

Those Cl4 feet

“those feet”

c. áàvíí vankúkùmà

Those C14 chiefs
 “those chiefs”

d. *òmwíí* mùsùtù
 Those C16 bellies
 “those bellies”

e. *áàyíí* ìkúnda
 That C17 bed
 “that bed”

In view of the above facts, it appears that determiners can either precede or follow nouns, depending on the context of occurrence. We will come back to the derivation of these different word orders inside the Tuki DP. For the time being, let us talk about other particles that can co-occur with a demonstrative determiner.

9.6 The distribution of locative reinforcers

A locative reinforcer in Bantu languages indicates the location of a given object with respect to the positions of the speaker and the listener. In Tuki, there seems to be five locative reinforcers: *eenaè*, *aèniàìè*, *naànyaè*, *kaàaàbeèneè*, *beeèbeè*. The following table displays their different meanings and specifies their positions towards the speaker and/or the hearer:

Locative reinforcers

<i>Èèná</i>	Here	near speaker
<i>Beebè</i>	Near	near speaker and listener
<i>Aníí</i>	There	far from speaker and listener
<i>Nánya</i>	over there	very far from listener and speaker
<i>Káábènébè</i>	Far	further from speaker and listener

The above locative reinforcers can occur with demonstrative determiners, not with possessive determiners. As noted above, demonstrative and possessive determiners can occur either in prenominal or in postnominal position. But locative reinforcers occur only in postnominal position. Moreover, while demonstrative and possessive determiners agree in noun class with the head noun, locative reinforcers are invariable. Furthermore, while the presence of the demonstrative determiner is compulsory, the presence of the locative reinforcer is optional.

(45)

a. *òkútù* ódzù eèná
 C11 woman This here
 “this woman here” (near speaker)

b. òkútù Òdzù beèbè
 Cl1 woman This Near
 “this woman near (us)” (near speaker and listener)

c. námà áàdzε iníi
 Cl10 animal this there
 “this animal there (us)” (far speaker and listener)

d. ñnyínyĩ ñĩdzí Nánya
 Cl15 bird this over there
 “this bird over there (us)” (very far from speaker and listener)

e. ìkúndà Ààyε Káábènébè
 Cl17 bed This Far
 “this bed far” (further from speaker and listener)

Notice that NS (near speaker) demonstrative determiners can co-occur with any of the five locative determiners. Not so with FSL (far from speaker and listener) demonstrative determiners. Only *aèniàì* (there), *naànya* (over there) and *kaàaàbeènébèè* (very far) can co-occur with the latter, as the following paradigm shows:

(46)
 a. o`kútù ódzwíí *eenà
 Cl1 woman That Here
 “that woman here”

b. o`kútù ódzwíí *beèbè
 Cl1 woman That Near
 “that woman near”

c. ø-námà áàdzíí Aníi
 Cl10 animal That There
 “that animal there ”

d. ñ-yínyĩ ñĩdzíí nánya
 Cl15 bird That over there
 “that bird over there”

e. ø- ìkúndà Àáyíí Káábènébè
 Cl17 bed That Far
 “that bed far”

Having described the distribution of locative reinforcers in Tuki when they occur inside a DP containing a demonstrative determiner and a locative reinforcer, let us now talk about the structure of

DP when it specifically contains these two particles. Moreover, let us proceed by answering the question: How is the Tuki DP derived?

9.7 The structure and derivation of the Tuki DP (with a demonstrative Det and a locative reinforcer)

Under standard assumptions, DP is a projection of a (demonstrative) determiner. The question now is what position does the locative reinforcer occupy. It seems to behave like an adverbial adjunct; that is it is right-adjoined to the DP. It provides information about the entity the interlocutors are talking about and the distance between the interlocutors and the entity, and the location of the entity. Assume with Rizzi (2004) that this adverbial is hosted by ModP.

Given the above, we can now attempt to answer the following question: What is the structure of the Tuki DP in the following construction (cf. (44a))?

- (47)
- | | | |
|-----------|------|------|
| a. òkútù | Ódzù | Eenà |
| CI1 woman | This | Here |
- “this woman here” (near speaker)

(47) contains three words: the noun, the demonstrative determiner and the adverbial locative reinforcer. The phrase marker to be assigned to (47) should represent a merge order of the demonstrative, noun and locative reinforcer that is such that the correct word order attested in ordinary contexts can be derived. Assume that the tree representation in (47) represents such a merge order:

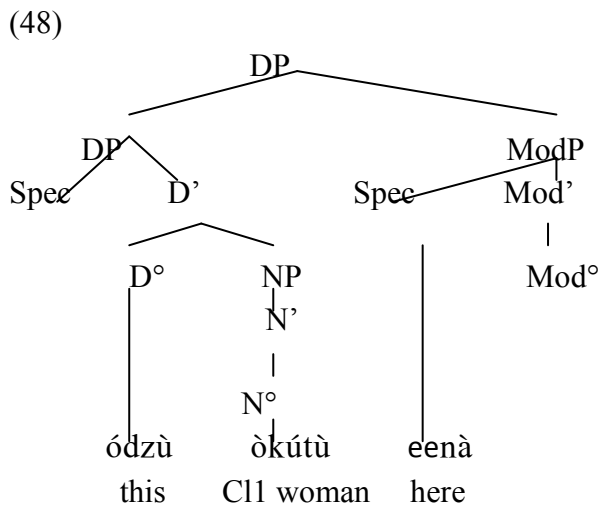

The word order on this tree representation is not the correct one attested in ordinary contexts. The correct word order is N-D-Mod (Adv). To derive it, the noun must move to a higher position. The only available one is [Spec, DP] since D° is already occupied by the demonstrative determiner.

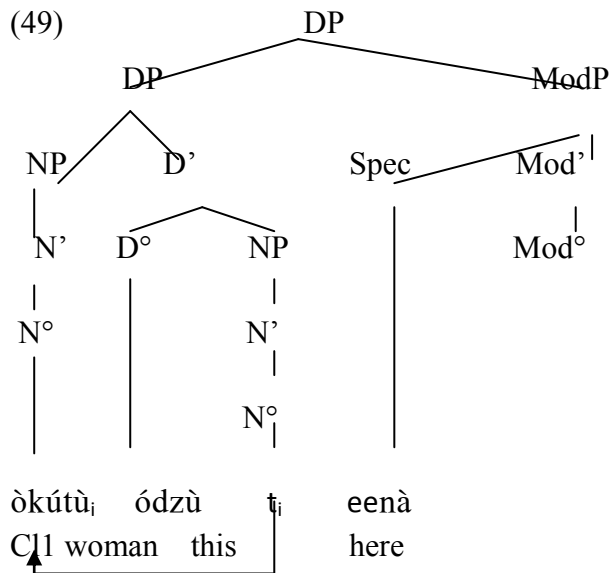

The movement of the noun from NP to [Spec, DP] in (49) makes it possible to derive the word order N-D-Mod *òkútù* (N) - *ódzù* (Det) - *eènà* (Mod). Recall that in this construction, the head noun and the determiner agree in noun class. (49) can account for the concord facts between the head noun and the demonstrative determiner: it is a typical case of Spec-Head Agreement.

Recall that it was said above that it so happens that the demonstrative determiner, just like the possessive determiner, can precede the head noun (cf. (48)-(49)), in the context of a contrastive focus reading. To derive this interpretation, it is argued that the demonstrative determiner, just like the possessive determiner, moves from D° to Foc°, for the construction to have a contrastive focus reading:

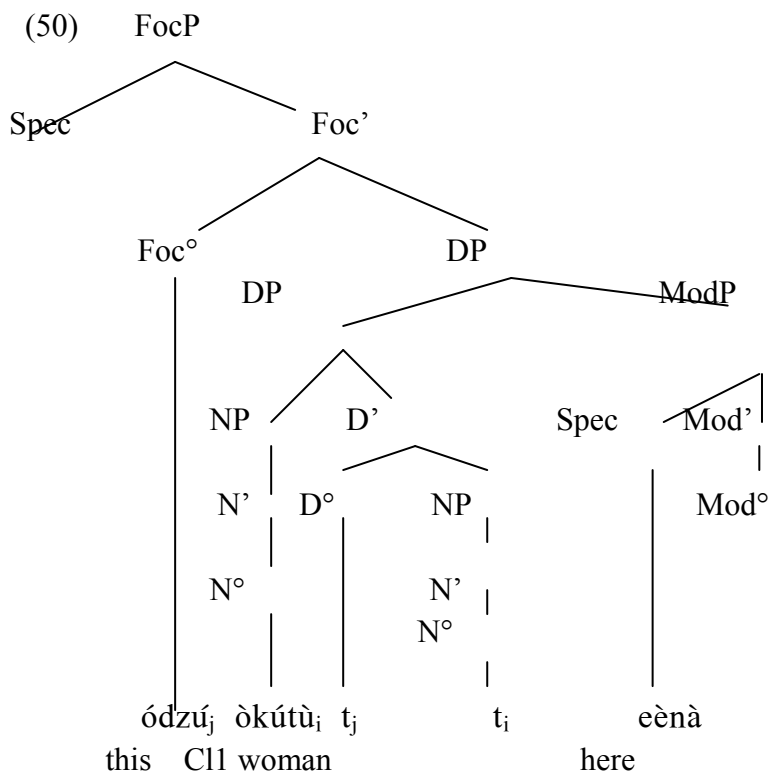

In (50), there are two raising operations that are all motivated by the need to check features. The number and class/gender agreement features in D° are checked by the raising of NP to the [Spec, DP] position. On the other hand, the focus feature on Foc° is checked by the raising of the demonstrative determiner to Foc°. These two raising operations make it possible to derive the contrastive focus surface word order *ódzù òkútù eènà*. “this woman here, not just any other woman”.

9.8 N + Poss Det + Dem Det = DP?

In Tuki, more than one determiner may modify the noun. These determiners agree in class with the noun:

(51)

a.mwaná	w-	ámε	ódzù
Cl1 child	Agr	my	This
“this child of mine”			

b. mù-	Sùtù	mw-	áámε	òòmú
Cl6	Bellies	Agr	My	these
“these bellies of mine”				

Notice that in both examples, the possessive determiner always precedes the demonstrative determiner. When both determiners follow the head noun, it is impossible for the demonstrative to precede the possessive, as the following examples show:

(52)

a.* mwaná	ódzù	w-	ámε
Cl1 child	This	Agr	my
“this child of mine”			

b.* mù-	Sùtù	òòmú	mw-	áámε
Cl6	Bellies	these	Agr	my
“these bellies of mine”				

Notice that the adverbial locative reinforcer can co-occur with the two determiners:

(53)

a. mwánà	w-	ámε	(ódzù eènà)
Cl1 child	Agr	my	This here
“this child of mine (here)”			

b.mù-	Sùtù	mw-	áámε	òòmú(eènà)
Cl6	Bellies	Agr	My	these here

“these bellies of mine (here)”

In view of the above, it appears that the DP is linearly structured as follows: N-Poss-Dem-Adv. The question now is: how is this word order derived? To answer this question, consider the following phrase marker:

(54)

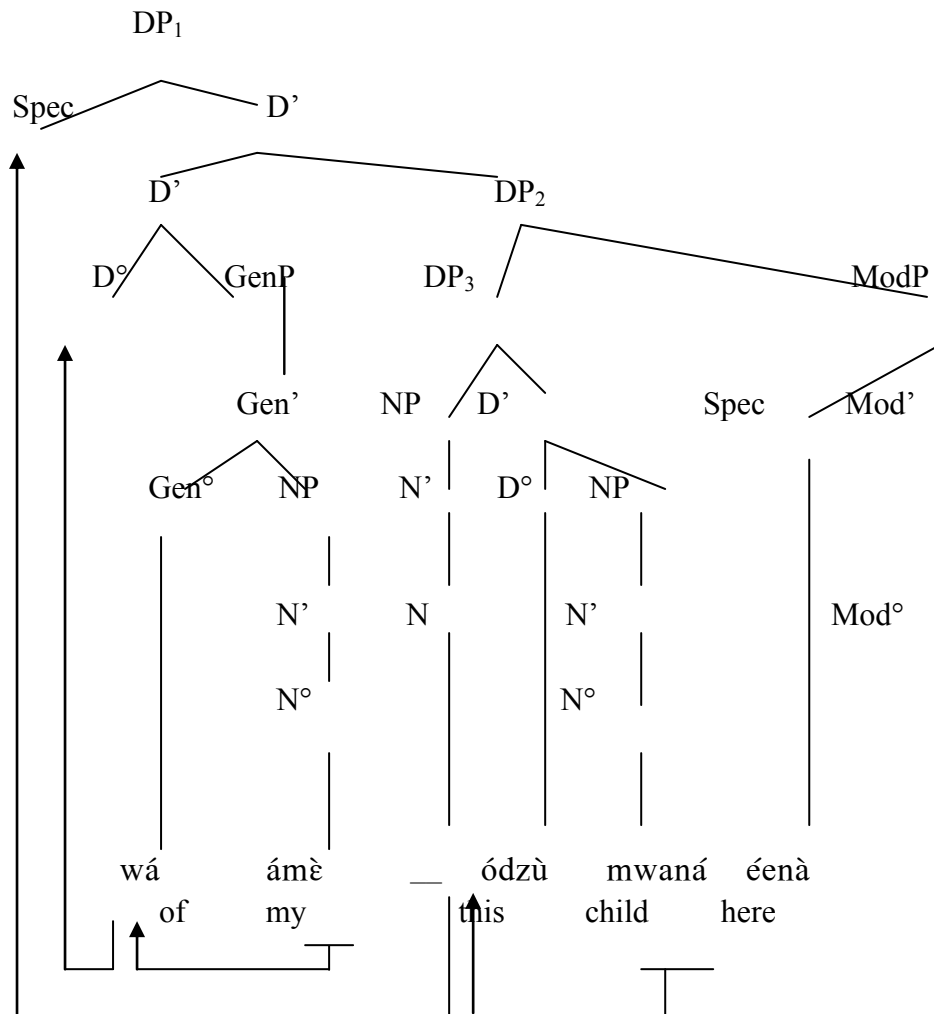

In (54), the noun *mwaànaè* raises from its position to the [Spec, DP₃] position. From the latter position, it moves to the specifier position of DP₁. As for the two determiners, the demonstrative is hosted by D°, the head of DP₃, while the possessive is generated inside GenP and raised to D°, the head of DP₁.

The tree representation (54) makes a number of predictions about the possible word orders that are likely to be attested in Tuki when the DP contains a head noun, a possessive and a demonstrative determiners.

In (54), when the noun *mwaànaè* moves to the specifier of DP₃, it may stop therein permanently, thereby deriving the following word order: Poss-N-Dem-Adv. The latter word order is indeed attested in the language:

(55)
wáámɛ mwaná ódzú __ éenà
my child this here

“this child of mine”

In (55), the raising of *mwánà* has stopped midway and the construction is licit, as evidenced by the fact that the following sentence enjoys a grammatical status:

(56)
[_{DP}wáámɛ Mwaná ódzú eènà]_{DP} à- nǒm. fība
My Child This Here SM sick fever

“this child of mine is suffering from fever”

One might be tempted to think that in (55) or (56) the possessive determiner *waààmèè* has been focalized, thereby preceding the head noun *mwánà* in the following manner:

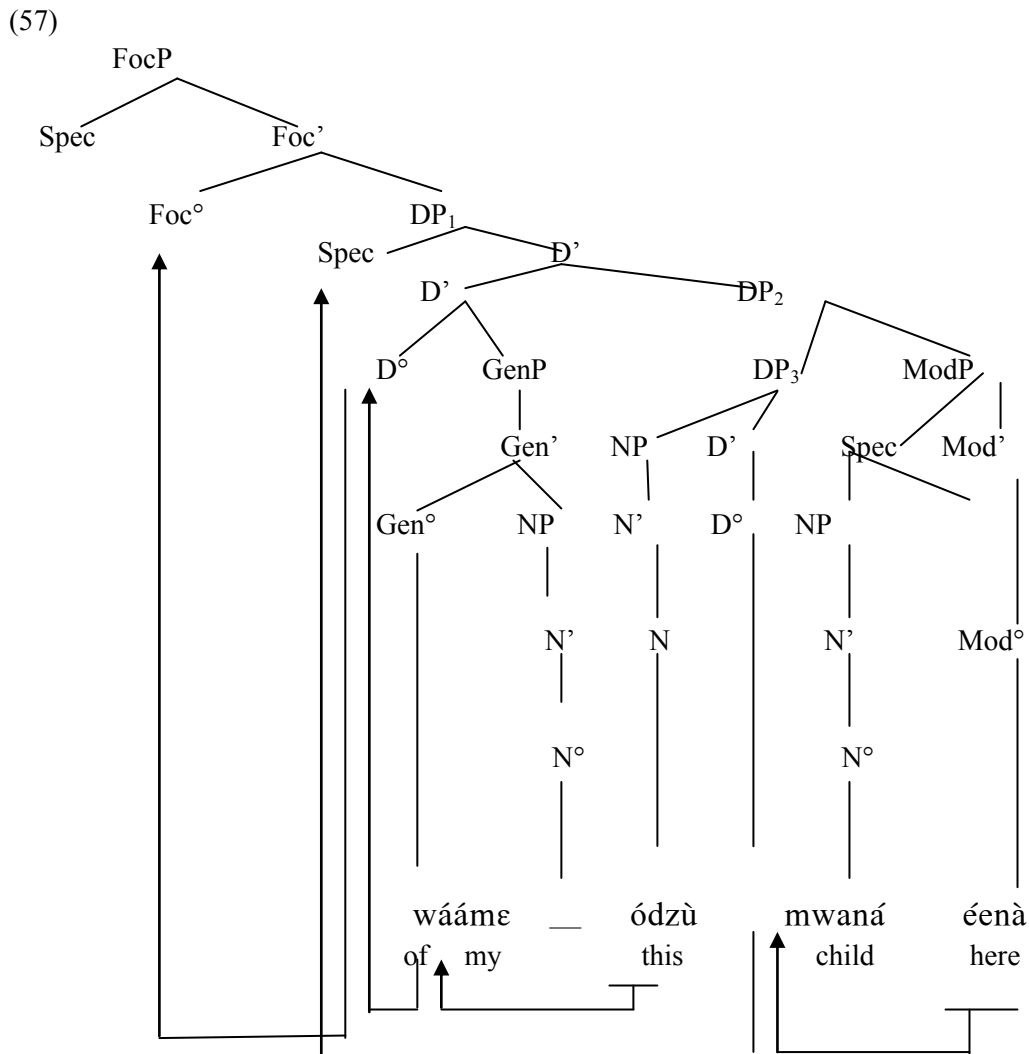

In effect, a contrastive focus interpretation is obtained by raising the possessive determiner to Foc°, and the resulting word order looks like the one illustrated in (55)/ (56).

Notice that in a DP like the one we have been talking about, the noun *mwaànaè* can be focalized in the manner illustrated in (b) below:

(58)

a. mwaná	wámè	ódzù	eenà
Child	My	This	here
“ this child of mine ”			

b. mwaná	ódzù	Wámè	ódzù	(eènà)
Cl1 child	Foc	My	This	here
“ it is this child of mine ”				

In sentence (b), the noun *mwánà* has been focalized, which explains why it is followed by what is called a focus element / word or a focalizer. Obviously, when the N is focused, the possessive determiner can no longer be focused, since two items cannot be focalized at the same time. When the Poss Det is focused, it raises to be hosted by Foc° ; when the N is focussed it raises to the [Spec, FocP] position while the focalizer *ódzù* that is base-generated occupies Foc° . This is tantamount to saying that Foc° cannot be doubly filled: this explains why only either the N or the Poss Det can be focalized.

Coming back to (58b), how is it derived? To answer this question, consider the following tree representation:

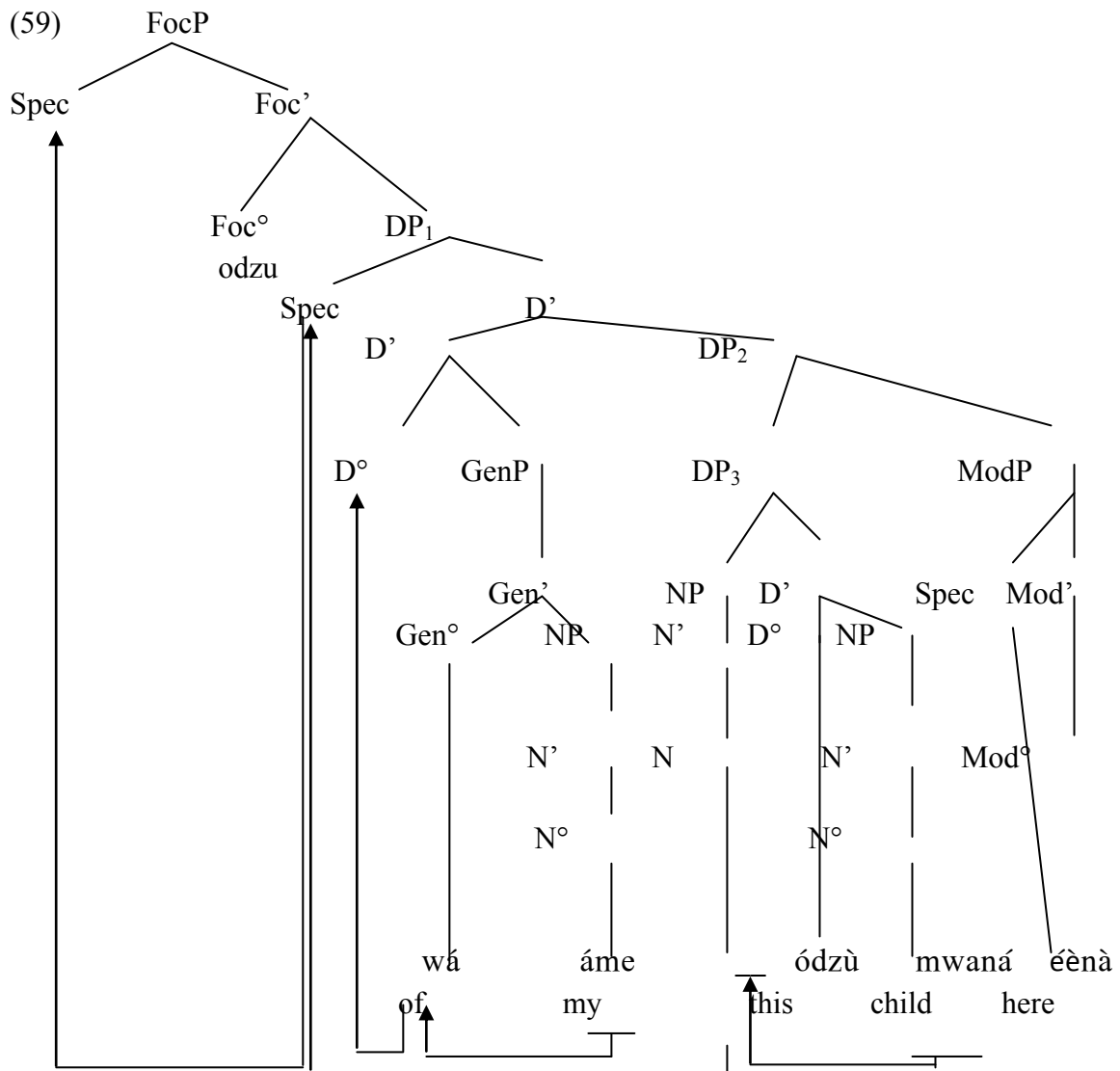

In (59), the N *mwaná* moves from its base position to the Spec of DP₃ from where it raises to the Spec of DP₁. From the latter position, it travels to the Spec of FocP, which agrees in noun class with the base-generated focalizer in Foc°. Notice that there is homophony between the focus word *ódzú* and the demonstrative determiner *ódzú*. Both elements sound alike, but they fulfill different functions, as shown in the following sentence:

(60)

í-	mú	Mútù	ódzù ódzù	à-	má-	bán-	à	òkútù
SM	is	Man	this relativize	SM	P2	marry	FV	woman
ódzù	odzu	a-	mu	i-	yèrè			
Foc	demonstra	SM	to be	Cl5	teach			
	tive				er			

“ It is this man who married this woman who is teacher”

(60) shows that *ódzù* can be either a demonstrative determiner or a relativizer. It was shown that it can also function as a focalizer. So it is a multifunctional element.

Returning to (59a), the N *mwánà* (child) and the Poss Det *wámè* (my) can form a single unit that, in turn, can be focalized, to derive thereby the following DP:

(61)

b. <i>mwaná</i>	<i>wáme</i>	<i>ódzù</i>	<i>ódzù</i>	<i>eènà</i>
Cl1 child	my	Foc	this	here
“ MY child of mine ”				

The presence of Foc (*ódzù*) after the NP *mwánà wáme* (my child) is an indication that the latter has been focalized. To understand how (61) is derived, take a look back at the tree representation in (59): the head of DP₁, D°, is occupied by *waáme* (my), while the Spec of DP₁ hosts *mwánà* (child); the N *mwánà* and the Poss Det *wáme* are focalized and raised to [Spec, FocP] and Foc° base-generates the Foc marker *ódzù*.

Now, let us consider another possible word order in Tuki.

9.9 N + Dem Det + Poss Det = DP?

In Tuki, it is also possible to have the following word order inside DP:

(62)

a. <i>mwaná</i>	<i>Ódzù</i>	<i>wámè</i>	<i>eènà</i>
child	This	My	Here
“ this child of mine ”			

b. <i>ĩ-kàrà</i>	<i>Ídžĩ</i>	<i>ràámè</i>	<i>eènà</i>
Cl18 mat	This	my	Here
“ this mat of mine ”			

As was the case with the NP containing the possessive determiner, in (60) the NP containing the Dem Det can also be focused:

(63)

a. <i>mwánà</i>	<i>ódzù</i>	<i>ódzù</i>	<i>wámè</i>	<i>eènà</i>
Child	this	Foc	My	here
“ THIS CHILD of mine ”				

b. <i>ĩ-kàrà</i>	<i>ĩdžĩ</i>	<i>ĩdžĩ</i>	<i>ràámè</i>	<i>eènà</i>
Cl18 mat	this	Foc	My	here
“ THIS MAT of mine ”				

The derivation of these two sets of sentences should proceed as in the preceding section. (62b), therefore, would be derived as follows:

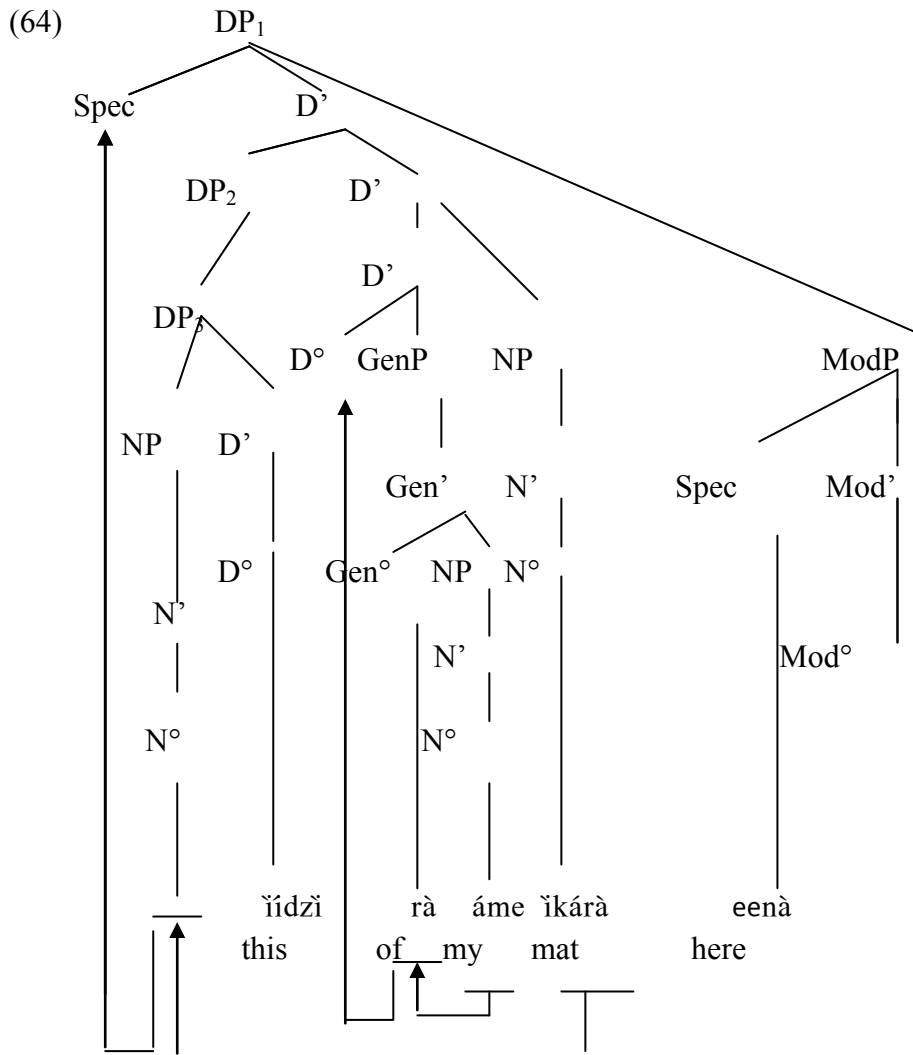

In (64), the Poss Det *raáme* (my) is generated inside GenP and raises to D°. The Dem Det *ïèiàdzìè* (this) is hosted by D° of DP₃. As for the head noun *ikára* (mat), inside DP₁, it moves from the lower NP, to the highest NP each time being hosted by N°, and finally lands in the Spec of DP₁, thereby deriving the word order N- Dem Det- Poss Det- ModP.

In (63b), the NP *ikára ïdzì* (this mat) is focussed inside DP. This means that in (64) a FocP is going to dominate DP₁: the Spec of FocP will host the NP *ikára ïdzì* while the Foc marker *ïdzì* will be base-generated in Foc°. The rest of the empirical facts in (64) will remain unchanged. The following partial phrase marker captures the above facts:

(65)

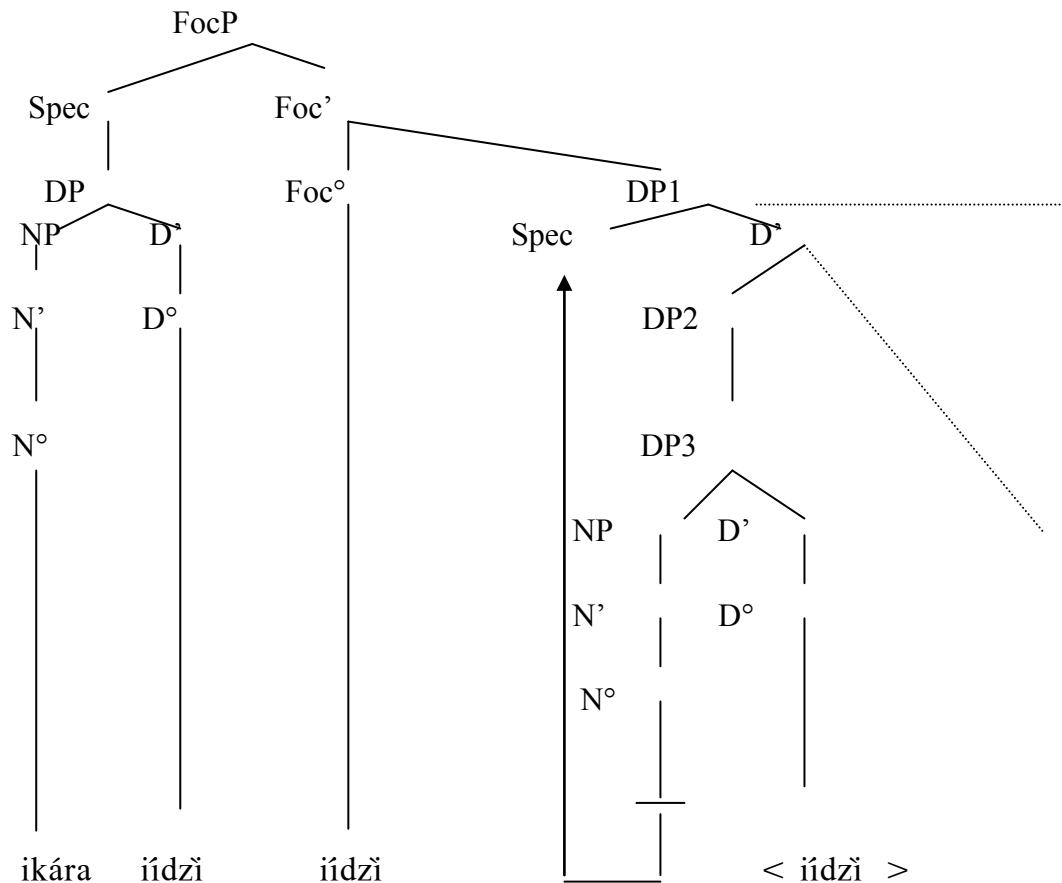

As previously stated, there is homophony between the Dem Det and the Foc marker. It simply stems from agreement: on the one hand between the head N and its determiner, and, on the other hand, between the specifier of the focus phrase ([Spec, FocP]) and its head (Foc°).

9.10 NP + Poss Det + Dem Det + Dem Det = DP?

The following word order is equally attested in the language:

(66)

a. nwaná wâme odzú dzu
child try this this”

b. manyá mâme ama má
Food my this this

“This is this food of mine”

c. ‘inyĩnyĩ râme ídžĩ dži
Bird my his this

“This is this bird of mine”

First, consider, in this paradigm, the morphological behavior of the third determiner. It seems to be a truncated reduplicated form of the second determiner. Second, syntactically, this third determiner can occur alone after the head

(67)

a. mwaná dzu
 Child this

“This is the Child”

b. manyá má
 food this

“This is the food”

c. inyinyĩ dźĩ
 bird this

“this is the Bird”

But, unlike the other two determiners that were previously talked about at length, this one cannot be focused, that is it cannot be preposed to the head N

(68)

a. * dzu mwana
 this child.

b. *ma manya

c. *dzi inyinyi

Semantically, it behaves like a presentative, that is it introduces the head N to some participant(s) in discourse. Coming back to the construction that seemingly contains three determiners, can their order vary or is it rigidly fixed? It seems to be the case that the orders can only be what it is in

(66) above, as illustrated by the following paradigm:

(69)

a. *inyinyi idzi rame dzi
 Bird this my this

b. *inyinyiidzi idzi rame
 Bird this this my

c. *inyinyi dzi rame idzi
 Bird this my this

d. *inyinyi dzi idzi rame
 Bird this this my

e. *inyinyi rame dzi idzi
 Bird my this this

Having discussed lengthily about the status and distribution of three post nominal determiners, one can start wondering how to derive a construction such as (66a).

If it is assumed that it is a DP, then how is it derived? Bear in mind that in (66), the adverbial locative reinforcer can co-occur with the three determiners.

(70)

Mwaná wâme odzú dzú éená

Child my this this here

“This is the Child mine”

To illustrate the derivation of (70), consider the following phrase marker.

(71)

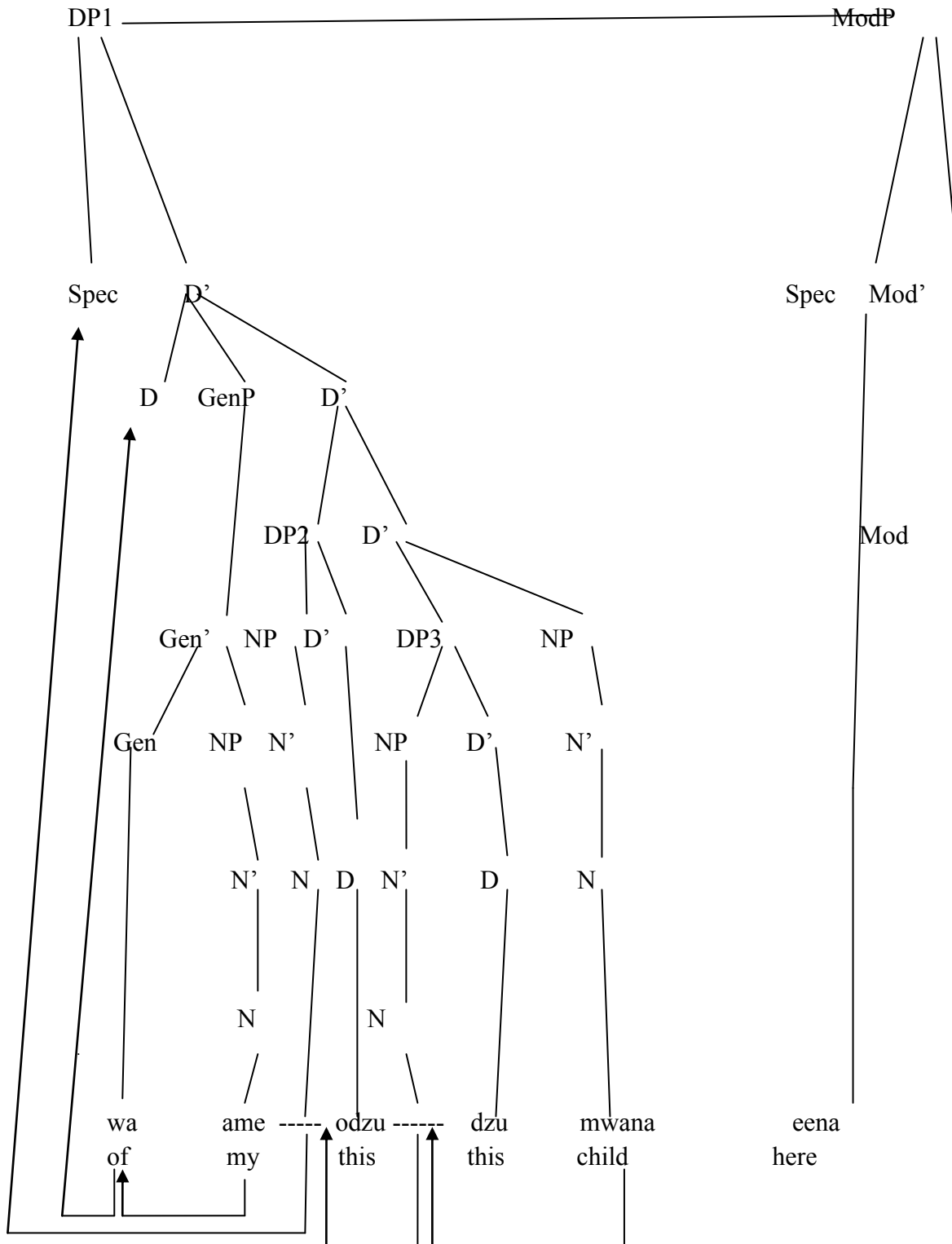

(71) displays the derivation of the DP illustrated in (70). The adverbial locative reinforcer, *eena*, is right –adjoined to DP1. The head N, *mwana*, is positioned after the three determiners from which position it will raise in order to derive the order N –Poss Det –Dem Det –Dem Det, as correctly

predicted by Kayne (1994) and Cinque (1993, 1994). But this upward movement is programmed to have stopped over in the Specs of the two intermediate DPs (DP2 and DP3), as illustrated in the tree representation (71) that this derivation is legitimate stems from the fact that indeed, at PF, the *N mwana* can occupy any one of the two spec positions, without any ungrammaticality resulting, albeit with the construction having slightly different readings. As a matter of fact the two constructions below, although grammatical, can be differently interpreted:

(72)

- a. $[_{DP1}[_{GenP} \text{wǎm}\epsilon \text{ [DP2} \text{ mwaná} \text{ } \text{ódzú}[_{DP3} \text{---dzú}[_{NP} \text{---}[_{ModP} \text{ ééna}]]]]]]]$
 my child this this here
- b. $[_{DP1}[_{GenP} \text{wǎm}\epsilon \text{ [DP2} \text{ ---ódzú}[_{DP3} \text{mwaná} \text{ } \text{dzu}[_{NP} \text{---}[_{ModP} \text{ ééna}]]]]]]]$
 my this child this here

(72a) and (72b) do not have the same meaning. (72a) means “this child of mine” whereas (72b) means “the one that is my child”. There is therefore a slight difference in interpretation between the two. But suffice it to know that the derivation in (71) is not illegitimate and that (72a-b) lend credence to it.

In the DP containing the head N followed by three determiners and a locative reinforcer, it is possible for the head N to be focalized, thereby generating the following construction:

(73)

- Mwaná ódzú wǎme ódzú dzú ééna
 child Foc my this this here
 “It is this Child that is mine”

When a noun is focused in Tuki it is followed by a focus word or a focalizer (FOC), the later agrees in class with the focalized item, much in the same way as determiners do. This might explain homophony observed between the (FOC) item and the Dem Dets, as illustrated once more by the following example:

(74)

- Mbwá ádzé ráme ádzé dze ééna
 cl10 dog FOC my this this here
 “It is this Dog that is mine”

The derivation of (74) will proceed as follows:

(75)

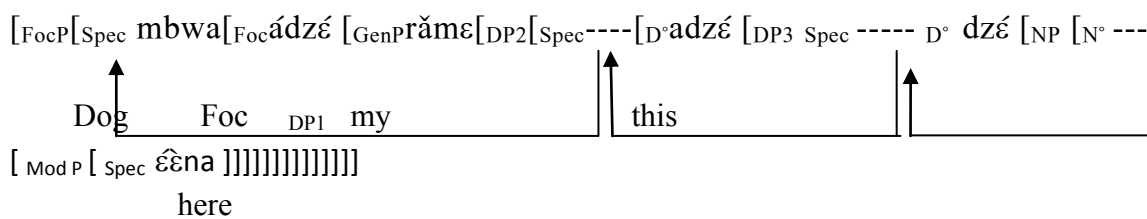

Partially summarizing, it has been shown above that inside a DP a head N can be followed by three determiners in this order

N –Poss Def –Dem Def –Dem Def –ModP. It has been argued that the above word order is obtained by the leftward raising of the NP to the specifier position of DP over the determiners.

In the lines that follow, a more elegant analysis of the Tuki facts is proposed, based on the split-DP structure and snowballing movement.

9.11 The Tuki D-system and the split-DP structure

The scientific literature points to the fact that the category D^0 is an “Infl-like” or “Comp-like” element of the nominal system. This is so because certain nominal features that are contained therein are licensed through Spec-head relationship or checking mechanism à la Chomsky (1995) (Abney 1987; Szabolcsi 1987, 1994; Grimshaw 1991; Carstens 1991, 2000; Ritter 1991, 1995; Siloni 1991, 1996, 1997; Bernstein 1991, 1993, 1997, 2001a, b; Koopman 1993, 2000a; Cardinaletti 1994; Giusti 1994; Cinque 1994, 1996; Longobardi 1994, 2001; Zribi-Hertz and Hanne 1995; Kinyalolo 1991, 1995 ; Brugè 1996 ; Campbell 1996 ; Cardinaletti and Starke 1999 ; Panagiotidis 2000 ; Aboh 2002, 2004 ; Laenzlinger 2005 ; Leu 2008).

As evidenced by the on-going discussion, Tuki seems to support the split-DP hypothesis since the components of the nominal left periphery are manifested inside the DP.

9.11.1 An articulated nominal left periphery

The Tuki noun phrases may contain a noun, a numeral, a possessive determiner, a demonstrative determiner, a locative reinforcer. The modifiers of the noun constitute the inflectional domain:

(76)

Para a- mu dwí va-kutu va-tátú vame aava ééna
Priest SM P1 baptize cl2 women cl2 three my these here

“The priest baptized these three women of mine”

In the above sentence, the numeral adjective, the possessive determiner and the demonstrative determiner are manifestation of the category Determiner in Tuki. Given the split-DP hypothesis, the number, the possessive and the demonstrative determiners are the expressions of distinct projections, NumP, PossP and DemP respectively (Abney 1987; Ritter 1991, 1992, 1995; Carstens 1991, 1997,

2000; Siloni 1991, 1996, 1997; Giusti 1994; Cinque 1994, 1996; Aboh 1996a, 1999, 2002, 2004 ; Panagiotidis 2000; Laenzlinger 2005 ; Leu 2008). As indicated by Aboh (2004: 81), since Num^o is the interface between the nominal left periphery and the inflectional domain, it encodes features that agree with those expressed in the nominal inflectional system. Aboh correctly predicts the concord effects borne by the NP, NumP, PossP and DemP in Tuki. (For apparently similar facts in other languages, see Alexiadou and Wilder 1998; Carstens 2000).

In Tuki, agreement is overtly realized on the NP and the inflectional domain. In other words, the NP agrees in noun class with its modifiers:

(77)

Okutu ame a- má- sumbá m-aráté m-atátú m-aáme aama
 Woman my SM P2 cut cl6a trees cl6a three cl6a my cl6a these
 “My wife cut these three trees of mine”

In (76) and (77), the NPs *vakutu* “women” and *marate* “trees” agree in noun with the inflectional domain that is made up of the modifiers (the numeral adjective, the possessive determiner and the demonstrative determiner). In particular, the example (77) shows that Num^o bears some agreement features in Tuki, just as determiners do. The following paradigm clearly evidences it:

(78)

a. i-ngúru i-tátú
 cl4 feet cl4 three
 “Three feet”

b. manó matátú
 cl18 diseases three
 “Three diseases”

c. vitate vitatu
 cl13 cockerels cl13 three
 “Three cockerels”

d. munyínyí mutátú
 cl6a birds cl6a three
 “Three birds”

e. atsó átátú
 cl6 ears cl6 three
 “Three ears”

The above examples show that the numeral adjective agrees in class (gender and number) with the head noun. Assuming that the numeral adjective is hosted by NumP, it follows that Num^o bears some agreement features.

Returning to sentence (76), one wonders what is the structure of the NP *vakutu*

vatátú vâme aáva ééna “these three women of mine” (cf. (76))? More precisely, how is it derived? Given Kayne’s (1994) universal hypothesis that all languages are of the type specifier-head-complement, for the head noun *vakutu* to be in NP-initial position means that it merged into that position by movement. Assume that the universal base order is the following on the basis of previous works (Hawkins 1983; Abney 1987; Szabolcsi 1987, 1994; Carstens 1991, 2000; Cardinaletti 1994; Kinyalolo 1991, 1995; Ritter 1991, 1992, 1995; Siloni 1991, 1996, 1997; Brousseau and Lumsden 1992; Kayne 1994; Cinque 1994, 1996; Brugè 1996; Giusti 1997; Laenzlinger 2005; Aboh 2004):

(79) (Aboh 2004: 93, (31))

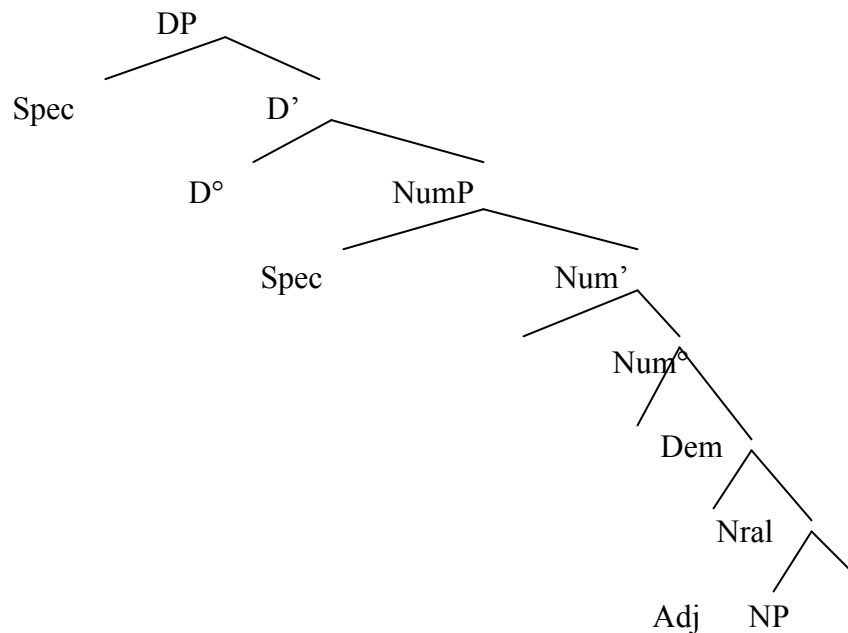

Obviously, the tree structure (79) will have to be adapted to suit the Tuki empirical material. Until that is done, a discussion about the content of the nominal inflectional domain is in order.

9.11.2 The nominal inflectional domain

In Tuki, the modifiers follow the noun in this order: noun-adjective-numeral-possessive-demonstrative-locative reinforcer. This order appears to be the preferred one although others to which I shall return are possible (see the next chapter about Tuki adjective placement):

(80)

Mbárá	a-	má-	nobá	vakutu oki	vatátú	vaá	aáva	eéna
Mbara	SM	P2	beat	women	Tuki	three	his	these here

“Mbara beat these three women of his”

The Tuki data as illustrated by (80) run counter Hawkins’(1983) prediction about the universal (word) order and Kayne’s (1994) Spec-head-complement universal hypothesis. This, once again, begs the question of how NPs in this language are derived

9.11.2. 1 The order of noun modifiers

Hawkins(1983:2) indicates that languages use modifying expressions “either consistently before or consistently after modified elements or heads.” For example, in a language like Japanese, the word order of which is SOV, the direct object immediately precedes the verb; and the genitive, the adjective and the relative clause also precede the modified noun. In SVO languages, like Tuki, the verb immediately precedes the direct object complement; and the modifying genitive, the adjective, and the relative clause follow the modified noun. However, it should be borne in mind that in Tuki some adjectives are always pronominal (see the next chapter for details). As opposed to SOV languages that are postpositional, SVO languages are prepositional. The following Tuki data illustrate the case of SVO languages:

(81)

a. Arángá yá Víróó
 bicycle of Viroo
 “Viroo’s bicycle”

b. matúwa búútutu
 car red
 “A red car”

c. okutu odzu a- tsorá-m itutu
 woman relativized SM drive Inc. motorcycle
 “The woman who is riding a motorcycle”

d. Mangadzu a- mu- [na sukuru]
 child SM is in school
 “The child is in school”

Hawkins (1983) studied more than 350 typologically different languages and came up with four major patterns that characterize languages with regard to the sequencing of modifiers (e.g. numeral, adjective, demonstrative) in noun phrases (see also Aboh 2004: 91-92):

(82) *A: 3 modifiers on the left/0 on the right:*

Dem-Nral-Adj-N(e.g., Mandarin, English, Finnish, Hungarian)

B: 2 modifiers on the left/ 1 on the right:

(i) Dem-Nral-N –Adj (e.g., French, Italian),

(ii) *Dem- Adj-N-Num (no example),

(iii)*Nral- Adj-N-Dem (no example)

C: 1 modifier on the left/2 on the right:

(i) Dem-N-Adj-Nral (e.g. Kabardian, Warao),

(ii) Nral-N-Adj-Dem (e.g., Basque, Maori, Welsh, Vietnamese, etc.),

(iii)*Adj-N-Nral-Dem (no example)

D: 0 modifier on the left/ 3 on the right:

N-Adj-Nral-Dem (e.g., Selepet, Yoruba)

The starred word orders above are not attested and they are disqualified by Hawkins's (1983) Universals (V) and (VI) which are based on the following empirical observations (see Aboh 2004: 92):

(83)

V. If a language has noun before demonstrative, then it has noun before adjective; i.e. , N Dem \Rightarrow NA (equivalently: AN \Rightarrow Dem N).

VI. If a language has noun before numeral, then it has noun before adjective; i.e., N Nral \Rightarrow NA (equivalently: AN \Rightarrow Nral N).

On the basis of the above observations, Hawkins (1983: 120-121) reformulates Greenberg's (1966: 87) universal hypothesis describing word sequencing in NPs:

(84)

When any or all of the modifiers (demonstrative, numeral, and descriptive adjective) precede the noun, they (i.e. those that do precede) are always found in that order. For those that follow, no predications are made, though the most frequent order is the mirror image of the order for preceding modifiers. In no case does the adjective precede the head when the demonstrative or numeral follows.

As indicated by Aboh (2004: 92), it follows from Hawkins' reasoning "that two major patterns are found in languages. The sequence in (A) corresponds to languages where modifiers precede the noun and the relative order adopted is demonstrative– numeral-adjective-noun. Sequence (D), on the other hand, represents the preferred order in languages where the modifiers follow. Observe that in the latter case, the order, noun – adjective – numeral – demonstrative, mirrors that in sequence A, where the modifiers precede."

Above, I said that some adjectives precede the head noun whereas others do follow it, depending on the type of adjective. Moreover, in constructions where the possessive determiner and the demonstrative determiner co-occur, in normal circumstances, the possessive should precede the demonstrative:

(85)

a. akáná á okutu amε odzú
big CON woman my this
"This big woman of mine"

b.* akáná á okutu odzú áme
 big CON woman this my

(85b) is ruled out because the demonstrative precedes the possessive. Bear in mind that the two determiners do not have to co-occur:

(86)

a. okutu áme
 woman my
 “My woman/ wife”

b. okutu ódzú
 woman this
 “This woman”

The next chapter is devoted to adjective positioning in this language. For the time being, consider the fact that when the adjective follows the head noun in Tuki, the latter language respects the word order illustrated by the sequence in (D), as the following noun phrase clearly shows:

(87)

Virángá	búútútu	vitátu	vyame	iivi
N	Adj	Nral	Poss	Dem
bicycles	red	three	my	these

“These three red bicycles of mine”

If the universal base order represented in (79) is correct, assuming Kayne’s (1994) universal hypothesis that all languages abide by sequence (A) (Dem-Nral-Adj-N), then underlyingly the noun phrase illustrated in (87) could be tree-structurally represented as follows:

(88)

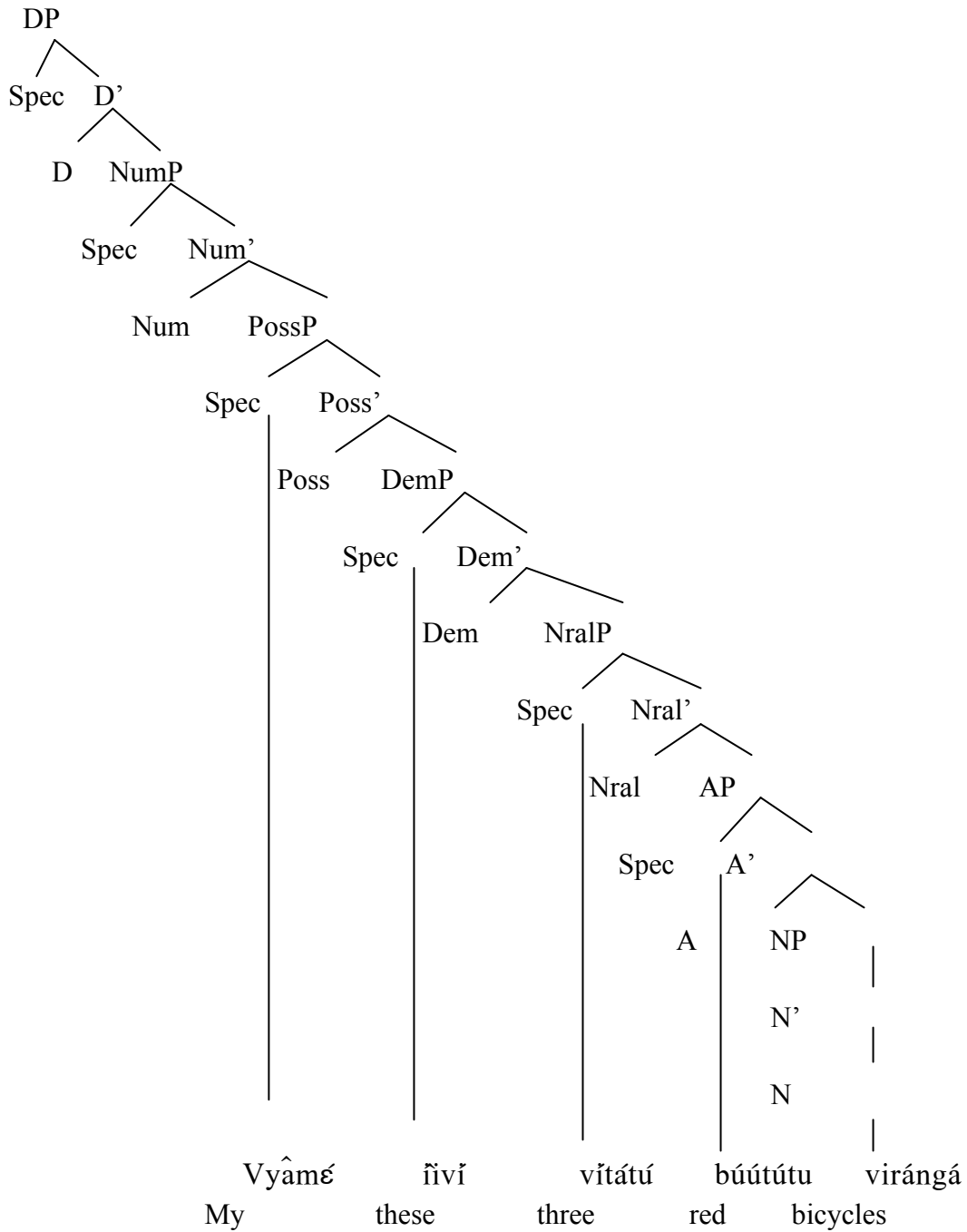

Given (88), how do we obtain the word order attested in (87)? More precisely, how do we account for the word order in (87)? One solution that immediately crosses one's mind is to posit that the NP *virángá* "bicycles" moves to the position [Spec, DP] via the position [Spec, NumP] to check the features under the heads Num° and D°. Though the end result of such a derivation is grammatical:

(89)

virángá	Vyame	iivi	vitatu	búútútu
Bicycles	My	these	three	red

"These three red bicycles of mine"

it is not what was looked for. It only shows that the order N-Poss-Dem-Nral-Adj is also attested in this language. Since the NP crosses four specifier positions ([spec, AP]), [Spec, NralP], [Spec, DemP] and [Spec, PossP]), it implies that none of them can block its raising.

The other alternative consists in arguing that the extended NP-complement moves cyclically to the position [Spec, DP] via [Spec, NumP] to check the features under Num° and D°. In other words, it is the (whole) base order in (88) that would land in the specifier position of DP. If that is theoretically possible, no such word order is attested in this language. So this option is empirically ruled out. One is back to square one: from what type(s) of movement does the order N-Adj-Nral-Poss-Dem in Tuki result? To understand what is going on, consider the following representation:

(90)

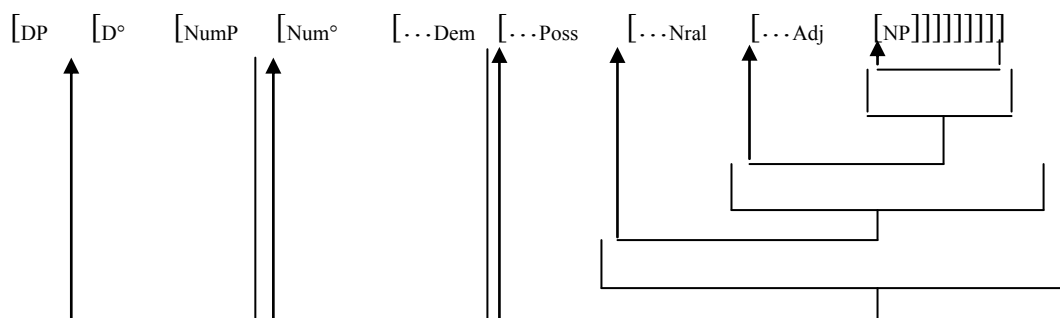

Cyclic movement (II) Snowballing movement (I)

In (90), the NP raises to the left of the adjective, deriving the complex unit noun-adjective (*viránga búútútu* “red bicycles”). The latter complex unit then raises to the left of the numeral thereby giving birth to the three worded unit *viránga búútútu vitatu* “three red bicycles.” The latter phrase moves to the left of the possessive to produce the phrase noun-adjective-numeral-possessive, which then raises to the left of the demonstrative in order to form the unit noun-adjective-numeral-possessive-demonstrative, the NP as it appears at PF. After this snowballing movement (step I), the resulting phrase moves cyclically to [spec, NumP] and [Spec, DP]. The first step of the derivation (90) is called snowballing movement (Aboh 2004; Laenzlinger 2005). It is the “successive movement of bigger chunks[...]within the nominal inflectional system, due to formal licensing conditions of the noun head” (Aboh 2004: 93).

The derivation in (90) illustrates a phrase structure representation that is slightly different from the one in (88). In (90), the DemP dominates and precedes the PossP whereas in (88), it is the reverse order. Had the order in (88) been considered for the derivation in (90), the resulting form would have been such that the demonstrative would have erroneously preceded the possessive. Consequently, the base order represented in (88) should be rephrased as follows:

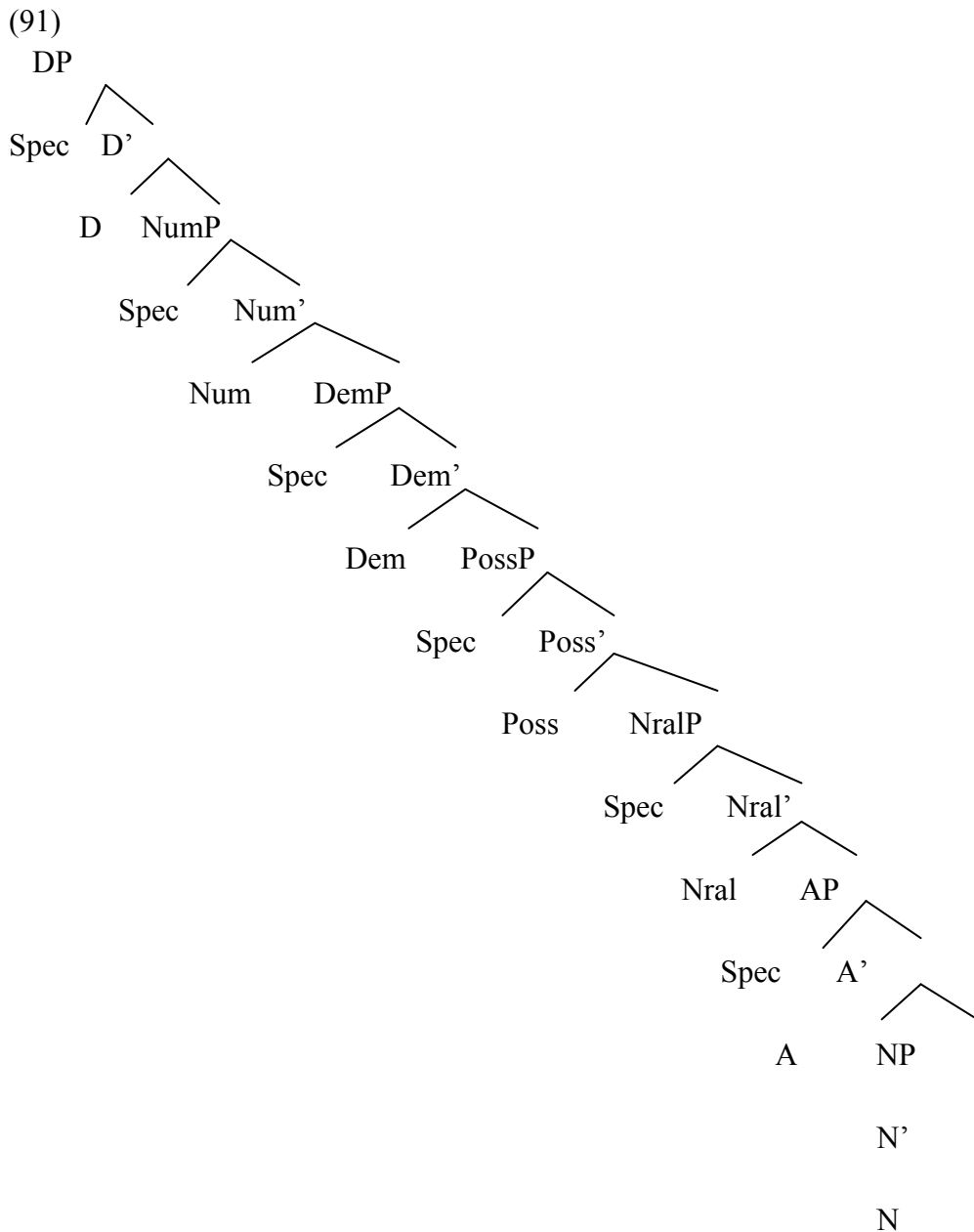

If this is indeed the universal base order from which all Tuki DP-structures should be derived, then how do we account for the word order illustrated by sentence (89) and which is grammatical. In the latter NP, the head noun precedes the possessive which, in turn, dominates the determiner. Since (89) is licit, its derivation should be the following:

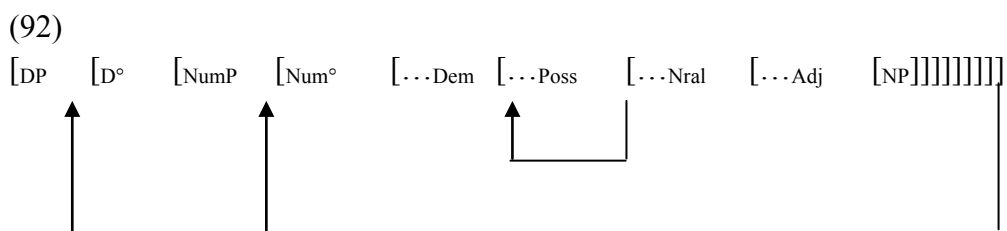

In (92), the NP raises to the position [Spec, DP] via the position [Spec, NumP] to check the features under the heads Num° and D°. The possessive moves to the left of the determiner (over the latter).

Observe that these two raising operations do not result in any ungrammaticality, thereby indicating that the intermediate specifier positions that are occupied do not block movement of that kind. This constitutes prima facie theory internal evidence that the possessive, the demonstrative, the numeral and the adjective in (89) all occupy specifier positions of their respective maximal projections. In other words, they are all maximal projections that are hosted by the specifier position of a projection within the nominal inflectional domain (Valois 1991; Bernstein 1993, 1997, 2001a, b; Cardinaletti 1994; Giusti 1994, 1997; Longobardi 1994, 2001; Brugè 1996; Carstens 2000; Aboh 2004; Laenzlinger 2005; Cinque 1994, 2010). For Cinque, adjectives (1994, 2010), just like adverbs (1999) substitute for the specifier positions of their maximal projections. Comparing the Romance postnominal adjectives to the German pronominal ones, Cinque (1994) argues that this dichotomy cannot be derived from a head versus maximal projection asymmetry. Assuming the Head Movement Constraint (Travis 1984), it is undesirable to claim that German adjectives are heads that block N-movement, whereas since the Romance ones are maximal projections, they cannot prevent the noun from raising. Cinque therefore proposes that the Romance and the Germanic adjectives are all maximal projections that merge into a specifier position. In fact, adjective placement in the two languages can be explained by the fact that in Romance the noun moves to a head position located between N and D, but in Germanic N-raising is barred. Giusti (1994, 1997) also indicates that demonstratives and certain numerals are maximal projections that merge in the specifier position of a functional projection called an agreement projection. Given these reasonings, a sequence of agreement projections (AgrP) is projected between DP and NP in the nominal inflectional system (Rizzi 1990; Cinque 1994, 1996; Aboh 2004; Laenzlinger 2005). This state of affairs is represented in (93b) derived from (93a):

(93)

a. vámbéré	aáme	ááva	vaaba	fítiti
friends	my	these	two	black

“These two black friends of mine”

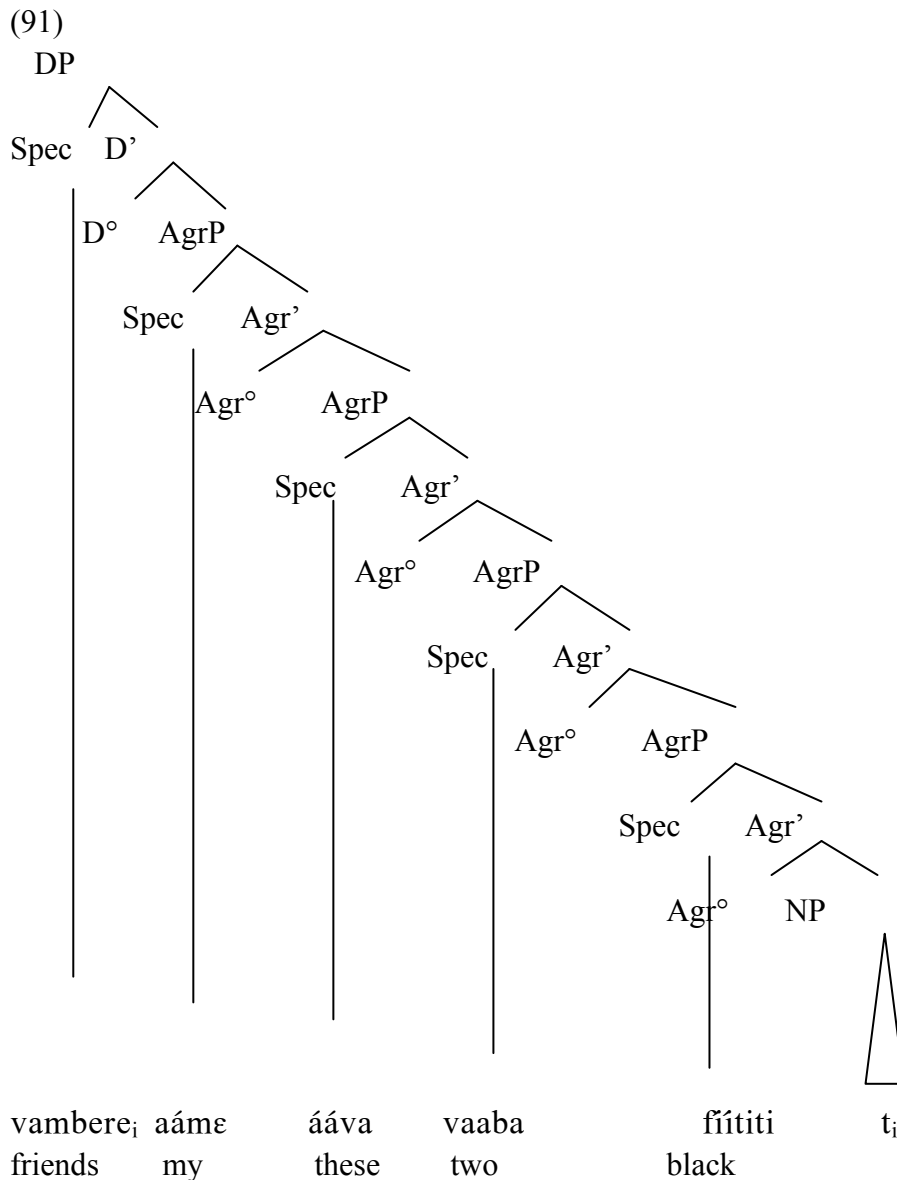

In (93b), the NP raises from its embedded position to the [Spec, DP] position with no stop over at any of the intermediate specifiers. Such a movement apparently, does not violate minimality since the construction converges. This is no surprise as it has been argued that noun modifying elements do not trigger minimality effects with regard to noun raising (Grosu 1988; Dobrovie Sorin 1994; Giusti 1994, 1997; Cinque 1994; Longobardi 1994, 2001; Brugè 1996; Bernstein 1997, 2001a,b; Aboh 2004). The phrase marker in (93b) implies that PossP, DemP, NralP and AP are considered to be agreement projections. Cardinaletti (1993), Giusti (1994), Cinque (1994), Aboh (2004) drew a similar conclusion (cf. Abney 1987; Szabolcsi 1987, 1994; Carstens 1991, 1997; Ritter 1991, 1992; Siloni 1991, 1996, 1997; Brousseau and Lumsden (1992; Koopman 1993, 2000a; Bernstein 1993, 2001; Longobardi 1994, 2001; Giusti and Leko 1995; kinyalolo 1995; Brugè 1996...etc). The movement illustrated in (93b) does not trigger relativized minimality effects because nominal modifiers (here a possessive, a demonstrative, a numeral and an adjective) realize an agreement position which is an A-position that cannot logically block the movement of an item to an A-bar position (Assuming that the Spec of DP is

of that nature). This entails that an A-bar chain formation cannot be blocked by intervening A-positions in terms of Rizzi (1990). Following Rizzi (2001), Aboh (2004) argues that “specifier positions are licensed if and only if they share certain features with the corresponding heads”. Rizzi(2001: 101) indicates that the “typology of position reduces to the clustering of features into natural classes”. It follows from the above that relativized minimality effects are triggered only within classes of the same features. The nominal modifiers (i.e., possessives, demonstratives, numerals, adjectives) substitute for the specifier positions of heads bearing certain “modifier features”. Following Aboh (2004), let us call them [+ modifier] features. The latter features should be distinguished from those borne by the [Spec, DP] position which hosts in (93) the NP. Assuming that [Spec, DP] share n-features (n standing for nominal), then the intervening [+modifier] positions, [Spec, PossP], [Spec, DemP], cannot generate minimality effects if some [+nominal] constituent crosses them on the way to DP (Roberts 2001; Ura 2001; Rizzi 2001; Aboh 2004).

9.11.2.2 Tuki postnominal adjectives and the structure of DP

It has been said above that in Tuki some adjectives can precede the head noun while other can follow it. Let us talk, for the time being, about postnominal adjectives. For illustration, consider the following constructions:

(94)

a. mbwá fíítiti
 dog(s) black
 “Black dogs”

b. mbwá fíítiti ngangεno
 dog(s) black big
 “Big black dogs”

c. mbwá fíítiti iibi iidzi
 dog(s) black two these
 “These two big black dogs”

(95)

a. vamatúwa búútútu
 cars red
 “Red cars”

b. vamatúwa búútútu nyemeno
 cars red beautiful
 “Beautiful red cars”

c. vamatúwa	búútútu	vaaba	aava
cars	red	two	these

“These two red cars”

This is what happens in (94) and (95). In (a), the noun precedes the adjective. In (b) the noun which is modified by two adjectives precedes the latter. In (c), a demonstrative determiner occurs after the numeral adjective and the order of words in the sentence is noun-adjective-numeral-demonstrative determiner. This word order exactly corresponds to Jack Hawkins (1983)’s observation that in some languages 0 modifier occurs on the left of the head noun and 3 modifiers occur on the right of the noun (Yoruba and Gungbe are examples of such cases) (see Aboh 2004: 101). While Tuki, in this respect, seems to syntactically behave like Yoruba and Gungbe, the adjective and the numeral can switch places without any ungrammaticality resulting:

(96)

a. mbwá	fíítiti	iibi	iidzi
dog(s)	black	two	these

“These two black dogs”

b. mbwá	ĩibi	fíítiti	iidzi
dog(s)	two	black	these

“These two black dogs”

(97)

a. vamatúwa	búútútu	vaába	áavá
cars	red	two	these

“These two red cars”

b. vamatúwa	váába	búútútu	áavá
cars	two	red	these

“These two red cars”

(96) and (97) clearly show that the adjective and the numeral can trade places and therefore the following word order is also allowed inside the Tuki DP: noun-numeral-adjective-demonstrative, aside from this one which is also attested, as indicated above: noun- adjective-numeral-demonstrative. The question of theoretical relevance is how the Tuki constructions containing adjectives are derived. Above, it was argued that the noun modifiers such as the possessive, the demonstrative, the numeral merge to the specifier position of their respective functional projections. Assume that the same reasoning is extended to adjectives following Giusti (1994, 1997), Aboh (2004), Laenzlinger (2005), Cinque (1994, 1996, 2010). On the

(102)

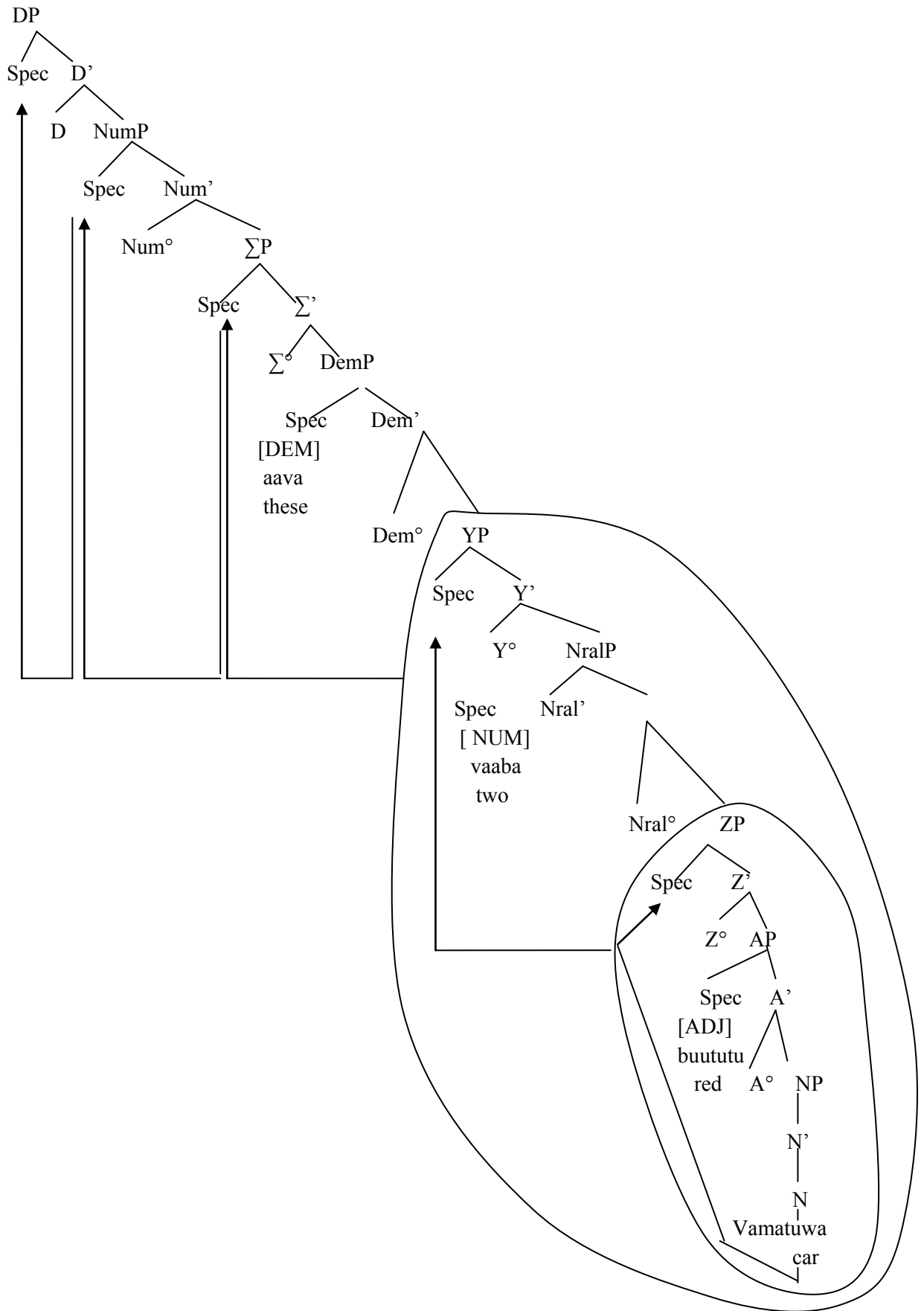

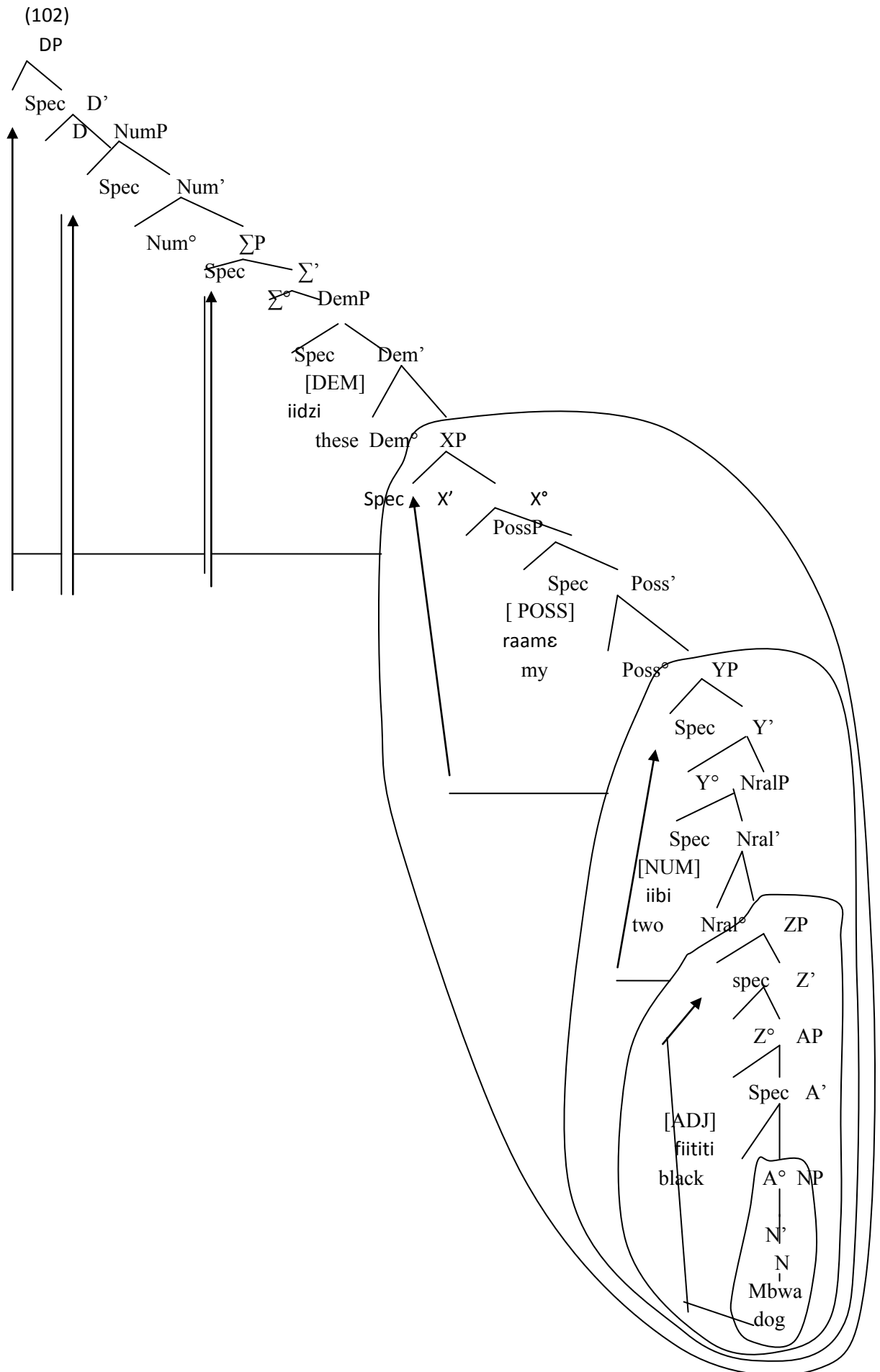

In (102), under snowballing movement, the whole NP moves to the left of the adjective. Then the phrase noun-adjective raises to the left of the numeral. Subsequently, the phrase noun-adjective-numeral moves to the left of the demonstrative, thereby giving birth to the phrase noun-adjective-numeral-demonstrative which stops over at [Spec, NumP] on its way up to [Spec, DP]. Snowballing movement applies in a roll up fashion. That is each time a given phrase moves above another phrase, the former linearly precedes the latter and the two form a new phrase that moves up above a new phrase...etc. In (102), snowballing raising has applied in two steps:

- i. Step I: the phrase noun-adjective raises to [Spec, YP] via [Spec, ZP];
- ii. Step II: the resulting phrase noun-adjective-numeral moves to [Spec, Σ P]

After these two steps that make up snowballing movement, Σ P moves successively in [Spec, NumP] and [Spec, DP].

In (103), the whole NP raises to the left of the adjective in [Spec, ZP] in order to give birth to the phrase noun-adjective. The latter phrase moves above the numeral (to its left) in [spec, YP] (step I of snowballing movement) giving birth to the phrase noun-adjective-numeral. Then this phrase raises up to [Spec, XP], above and to the left of the possessive (step II of snowballing movement), thereby deriving the phrase noun-adjective-numeral-possessive. Subsequently, this phrase moves to the left of the demonstrative in [Spec, Σ P] (step III of snowballing movement) and the resulting phrase is noun-adjective-numeral-possessive-demonstrative. Successive raisings to [Spec, NumP] and [Spec, DP] occur after snowballing movement

9.11.4 Focalization in DP

Remember that in Tuki the demonstrative determiner or the possessive determiner can precede the head noun in the context of a contrastive focus reading. For illustration and case of exposition reconsider the following examples:

(104)

a. ongúru rááme
 foot my
 “My foot”

b. rááme ongúru
 my foot
 “My foot”

(105)

a. okutu oàdzuà
 woman this

“this woman”

b. ódzú okutu
 this woman
 “This woman”

The (b) examples above are cases of contrastive focus reading. The derivation of the (a) examples follows straightforwardly from what was just argued. That is the NP raises from its base position and merges to the Spec of DP via the Spec of NumP, in the following manner:

(106)

a. [DP [D° [NumP [Num° [PossP [Poss°[NP]]]]]]]

The diagram shows a nested structure: [DP [D° [NumP [Num° [PossP [Poss°[NP]]]]]]]. An arrow points from the NP to Num°, and another arrow points from Num° to D°.

b. [DP [D° [NumP [Num° [DemP [Dem°[NP]]]]]]]

The diagram shows a nested structure: [DP [D° [NumP [Num° [DemP [Dem°[NP]]]]]]]. An arrow points from the NP to Dem°, and another arrow points from Dem° to D°.

Recall that above in section 7, in order to account for the contrastive focus interpretation, it was argued that the demonstrative determiner or the possessive determiner raises from D° to Foc°. That proposal cannot be maintained in view of the fact that it has now been indicated that all nominal modifiers, including the demonstrative and the possessive, occupy the Spec position of their respective distinct functional projections. More concretely, if the demonstrative and the possessive substitute for the Spec position of DemP and PossP respectively, it is logically sound to say that they merge into the specifier position of the FocP, rather than Foc°. So from now on, it is argued that for a given construction to have a contrastive focus reading, either the demonstrative or the possessive moves to the [Spec, FocP] position:

(107)

a. [FocP [Foc° [DP [D° [NumP [Num° [PossP [Poss°[NP]]]]]]]]]

The diagram shows a nested structure: [FocP [Foc° [DP [D° [NumP [Num° [PossP [Poss°[NP]]]]]]]]]. An arrow points from the NP to Poss°, and another arrow points from Poss° to Foc°.

b. [FocP [Foc° [DP [D° [NumP [Num° [DemP [Dem°[NP]]]]]]]]]

The diagram shows a nested structure: [FocP [Foc° [DP [D° [NumP [Num° [DemP [Dem°[NP]]]]]]]]]. An arrow points from the NP to Dem°, and another arrow points from Dem° to Foc°.

Recall as well that in Tuki a possessive and a demonstrative can occur inside an NP:

(108)

Yěndze yááme ayé
 House my this
 “This house of mine”

In this case, any one of the so called determiners can be focalized, but not both:

(109)

a. yááme yěndze ayé
my House this

“This house of MINE”

b. ayé yěndze yááme
this house my

“THIS house of mine”

(110)

a.* yááme ayé yěndze
my this house

b.* ayé yááme yěndze
this my House

(110) illustrates the so called universal ban on double foci in a single clause. In (109), when one of the determiners is focused, it moves to the specifier position of the FocP as illustrated in (107) above.

CONCLUSION

This chapter discusses the syntax of noun phrase in Tuki. It starts by observing that this language is devoid of articles. Its bare nouns can occur freely in argument positions and can receive an indefinite and a definite interpretation, the indefinite interpretation being existential or generic. Moreover, they can be assigned an interpretation similar to the one that NPs in French receive when they are introduced by definite or partitive articles. Furthermore, they can also occur as Kind-referring names i.e. as referential or definite generics, in argument positions of Kind-level (in Carlson’s 1977 sense) of particular or episodic sentences (Longobardi 2001). It seems then to be the case that Tuki is articleless language with ambiguous bare singulars.

The chapter proceeds by showing that a Tuki noun phrase may contain a noun, a numeral, a possessive determiner, a demonstrative determiner and a locative reinforcer. The language therefore portrays an articulated nominal left periphery. On the basis of the split-DP hypothesis, it is postulated that the number, the possessive and the demonstrative determiners

are the expressions of distinct projections, NumP, PossP and DemP respectively (Abney 1987; Ritter 1991, 1992, 1995; Carstens 1991, 1997, 2000; Siloni 1991, 1996, 1997; Giusti 1994; Cinque 1994, 1996; Aboh 1996 a, 1999, 2002, 2004; Panagiotidis 2010; Laenzlinger 2005; Leu 2008). Nominal modifiers such as numerals, possessives, demonstratives and adjectives are said to merge into the specifier positions of the distinct functional projection within the nominal inflectional domain (Cinque 1994, 1999, 2010). They behave like adverbs (Cinque 1999). And adjectives (Cinque 2010) that are argued to be maximal projections licensed in the specifier positions of functional projections. Following Aboh (2004), Num^o being the interface between the nominal left periphery and the inflectional domain, it encodes features that agree with those expressed in the nominal inflectional domain. As expected, NP, NumP, PossP and DemP in Tuki bear concord effects, i.e. the NP agrees in noun class with its modifiers. In this language, elements within the Noun phrase are linearized in such a way that the head noun occurs in structure – initial position. Given Kayne’s (1994) universal hypothesis that all languages are of the type specifier – head – complement, for the head noun to be front initial entails that it raised into that position by movement. I therefore argue that the Tuki nominal system is derived by cyclic and snowballing movement (after Aboh 2004; Laenzlinger 2005). Snowballing movement is the “successive movement of bigger chunks [...] within the nominal inflectional system, due to formal licensing conditions of the noun head” (Aboh 2004: 93). It is triggered by the strong nominal features of the nominal inflectional head. In the Romance languages like French and Italian, to derive the DP, the head noun is extracted from the host projection. In Tuki, such extraction is impossible. In fact, snowballing movement raises the head of the projection and sends it to dominate the next highest maximal projection. The derived sequence is then piedpiped to the next higher specifier position and so on and so forth. The movement thus proceeds by raising successive bigger chunks until it reaches the [Spec, Σ P] position wherefrom the latest derived sequence of projections departs in order to stop over at the next higher specifier projection [Spec, NumP], before finally landing in [Spec, DP]. The two raising operations from [Spec, Σ P] to [Spec, NumP] and from [Spec, NumP] and from [Spec, NumP] to [Spec, DP] are cyclic.

CHAPTER TEN

Adjectives and the split - DP structure

Introduction

This chapter examines adjectival ordering restrictions in Tuki by arguing, after Gary – John Scott (1998, 2002), ‘‘that adjectival distribution follows the pattern of adverbial distribution along the lines of Cinque’s Universal Hierarchy of Clausal Functional Projections (Cinque, 1999: 106)’’. In this perspective, adjectives are specifiers of functional projections (see also Laenzlinger (2005)).

As pointed out by Scott (1998, 2002), the extension of Cinque’s thesis to adjectival projections is motivated by a number of reasons. If, as indicated by Valois (1991), ‘‘the structure of DP is essentially parallel to that of CP’’, and ‘‘NP is the nominal counterpart of VP, and DP is the nominal counterpart of CP’’, it follows that FPs being associated with the clause, it is logical for FPs to equally be associated with the DP. Since adverbs, that are the sentential counterparts of adjectives, are hosted by FPs, adjectives can similarly be expected to be hosted by FPs. Cinque (1994), who was among the first to propose this notion, provided conceptual and empirical reasons for the view that adjectives substitute for the specifier positions of distinct functional projections (see also Cinque 2005, 2010). The latter viewpoint was later substantiated by Scott (1998, 2002) along the following lines:

1. The linear ordering of each stacked adjective can be viewed as a direct mapping from the hierarchical ordering of the FP with which it is associated.
2. Why does there seem to be a limit to the number of adjectives found within the DP (according to Cinque 1994, 96, apparently not exceeding six or seven’)? A priori there need be no such limit and, indeed, the adjunction hypothesis would predict that no such limit exists. The generation – in – Spec analysis at least in part predicts why: the number of adjectives is limited by the semantic possibilities for modification of the number of projections found between D and NP.
3. A theory allowing only Spec – Head relationships could presumably be said to be more ‘‘minimalist’’ in spirit than one that countenances both specifiers and adjuncts.
4. Within the traditional adjunction hypothesis, the fact that APs appear to the left of their head has to be specifically stipulated in the phrase structure rules (and, of course, the existence of multiple Specs is allowed), whereas Kayne’s (1994) antisymmetric view of syntax predicts there is always one single specifier per projection and that specifier must be

left – branching – thus, under the present assumptions, Kayne’s abstract theory receives further empirical support.

5. An analysis in which adjectives are the specifiers of FPs associated with their respective semantic classes leads to a tighter, more articulated correspondence between universal semantic properties and the syntax than in the recursive adjunction approach.

6. Cinque’s (1994) N – raising account suggests independent evidence that FPs exist within the DPs between DP and NP.

7. In many languages, stacked adjectives display case and phi-features, so within a minimalist view of syntax (Chomsky 1995a), adjectives can only be in Spec positions: the Spec – Head relationship is the only structural configuration where they can get their features ‘checked’ and erased since only specifiers are within the checking domain of a head; adjuncts are not.

8. (tentatively) FPs are projected from closed lexical classes (e.g. determiners, pronouns and classifiers); if adjectives are semantically related to the functional heads of the various FPs in the Spec of which they find themselves generated, then we might expect some ‘adjectival’ interpretation or function to sometimes be realized as a closed class item. In some languages, at least, this does indeed seem to be the case.

9. Finally, if [Adjectival Ordering Restrictions] AOR are a direct and overt manifestation of the ordering of FPs, then conjectures as to the psycholinguistic motivation for AOR need not be posed: AOR fall out as a direct consequence of UG.’’

Laenzlinger (2005: 645) indicates that ‘attributive adjectives (the so-called ‘adjectifs épithètes’ in French) function as noun modifiers. They are satellites of the nominal head occurring in the DP- internal position.’’ In Tuki, attributive adjectives can be placed before the noun:

(i)

a. akáná a yëndze

big CON house

‘big house’

b. ósyá a okutu

nice/beautiful CON woman

‘nice/beautiful woman’

c. arónó a mutu

old CON man

‘old man’

When the adjective precedes the noun in this language, a so-called connective marker occurs between the adjective and the N. We will return shortly to the status of this connective.

In Tuki, some attributive adjectives can occur after the noun:

(ii)

a. mbwá búútutu

dog red

‘‘a red dog’’

b. matúwa fíítiti

car black

‘‘ a black car’’

c. okutu oki

woman Tuki

‘‘a Tuki woman’’

Bear in mind that in this language adjectives do not appear randomly before or after the N. Basically, there are adjectives that are prenominal while others are postnominal. More details to follow.

Adjectives can be stacked either way in Tuki, either before the noun or thereafter:

(iii)

vikáná vasyá vitína a vakutu

big nice short CON women

‘‘ big nice short women’’

(iv)

okutu oki fíítiti ntimbí

woman tuki black naked

‘‘ A Tuki black naked woman’’

The adjective ordering in (iv) is simply the mirror image of English whereby the natural order of adjectives would be, according to Cinque personal communication (pc) ‘‘a naked black Tuki woman’’. In Tuki, prenominal adjectives follow the order [form/shape>quality>size] as in (iii) above, a hierarchical order which runs counter to the so-called universal order [quality>size>form/shape] that is attested in Germanic languages among others. More interestingly, up to six adjectives can be stacked inside a single DP; three on each side of the head N:

(v)

váná vasyá virafa a vakutu váyawúndu fíítiti mbúbúwa

small nice tall CON women Ewondo black poor

ava eéna

these here

‘‘these small nice tall women that are Ewondo, black and poor’’

How are the different constructions involving attributive adjectives derived? This work attempts to provide a plausible answer to the above question

1. Adjectives

1.1. Pure or prenominal adjectives

Class 1 pure adjectives

Class 1 pure adjectives seem to agree in class with the noun they modify or attribute qualities to, they are also preposed to the noun. For illustration, consider the following examples:

(1)

- | | | |
|------------------|------|-----------|
| a. ósyá | a | o - kutu |
| nice | CON | Cl1 woman |
| "nice woman" | | |
| b. Ombεε | a | okutu |
| bad | CON | woman |
| "bad woman" | | |
| c. Itĩna | (y)a | okutu |
| Short | CON | woman |
| "Short woman" | | |
| d. Akáná | a | okutu |
| tall/big | CON | woman |
| "tall/big woman" | | |
| e. arónó | a | okutu |
| old | CON | woman |
| "old woman" | | |
| f. Ikuti | a | nama |
| dried | CON | animal |
| "dried meat" | | |

g. Yédza	a	okutu
mad	CON	woman
"mad/crazy woman"		

Now, consider the plural forms of the above examples:

(2)

a. Vásyá	a	vá - kutu
nice	CON	Cl2 women
" nice women"		

b. Vabεε	a	vákutu
bad	CON	women
"bad women"		

c. Vitína	a	vákutu
short	CON	women
"short women"		

d. Vikáná	a	vákutu
tall/big	CON	women
"tall/big women"		

e. Virono	a	vakutu
old	CON	women
"old women"		

f. Vikúti	a	nama
dried	CON	animal (s)
"dried meat"		

g. Vyédza	a	vakutu
mad	CON	women
"mad/crazy women"		

The plural forms of the examples illustrated so far tend to confirm the idea that what is considered as adjectives agrees with the noun being modified. The statement made at the outset of this work about class 1 pure adjectives would need to be requalified because some of the morphemes (not all) called adjectives so far can also function as nouns: for example, *yedza* means either "a fool" (N) or "mad/crazy" (A). But one thing is certain. In a DP like (1g)

Yédza	a	okutu
Mad	CON	woman

The first morpheme *yedza* is the qualifier whereas *okutu* is the qualified. Whatever the case in no way can the NP *okutu* "woman" be considered an adjective or a qualifier. This would be an indication that calling class 1 pure adjectives the first morphemes in the example pairs provided above might not be inadequate.

Notice that, in both paradigms (1) and (2), there appears between the adjectives and the nouns a morpheme /a/ that can be called a connective. It is a kind of linker between the adjectives and the nouns.

In order to lay emphasis on the attribute of a noun, class 1 pure adjectives can be reduplicated.

Adjective reduplication is not specific to Tuki, further evidences are found in Creoles (Laenzlinger, pc), and it is postulated that while the reduplicated form is hosted in the head of the adjective phrase, the first form is hosted in the specifier position of the same phrase. The following data exhibit some instances of adjective reduplication in Tuki:

(3)

- | | | | | | | |
|----|-------------------------|-------|-----|--------|------|------|
| a. | Ósyá | ósyá | a | okutu | ódzú | εένα |
| | nice | nice | CON | woman | this | here |
| | "This very nice woman" | | | | | |
| b. | Yédza | yédza | a | okutu | áyé | εένα |
| | mad | mad | CON | woman | this | here |
| | "This very crazy woman" | | | | | |
| c. | arónó | arónó | a | mutu | ódzú | εένα |
| | old | old | CON | man | this | here |
| | "This very old man" | | | | | |
| d. | ikuti | ikuti | a | nama | áyé | εένα |
| | dried | dried | CON | animal | this | here |

"This very dried meat"

There are several proposals in the scientific literature regarding "the nature of the DP- internal adjectival positions" (Laenzlinger 2005:645-649). Two alternative hypotheses have been put forth for adjective positioning: (i) the adjunction- based approach (Sproat and Shih, 1988, 1991; Bernstein, 1991; Lamarche, 1991; Valois, 1991) and (ii) The specifier- based approach (Crisma, 1990; Cinque, 1994, 2005, 2010; Scott, 1998, 2002). Laenzlinger (2000, 2005) argues, with respect to adverbs and adjectives, that "the specifier- based analysis is more compatible with checking theory than the adjunction-based analysis. Following Chomsky's (1995) checking theory, the licensing of semantic features – that is to say scope properties- can be expressed in terms of feature checking done in specific configurations. According to Chomsky's (1995) definition of checking domain, there are two configurations that hold for feature checking: Spec- head and head- head. Adjunction of a head to a head leads to a legitimate checking configuration, but adjunction to XP does not give rise to a possible checking relation between the adjoined element and X^o". Moreover, "since adjunction is an intrinsically unordered operation (Laenzlinger, 1998:73; 2005: 652), it cannot explain the hierarchical order of adjectives exhibited in (4) below (see Laenzlinger, 2005:651, (15)):

(4)

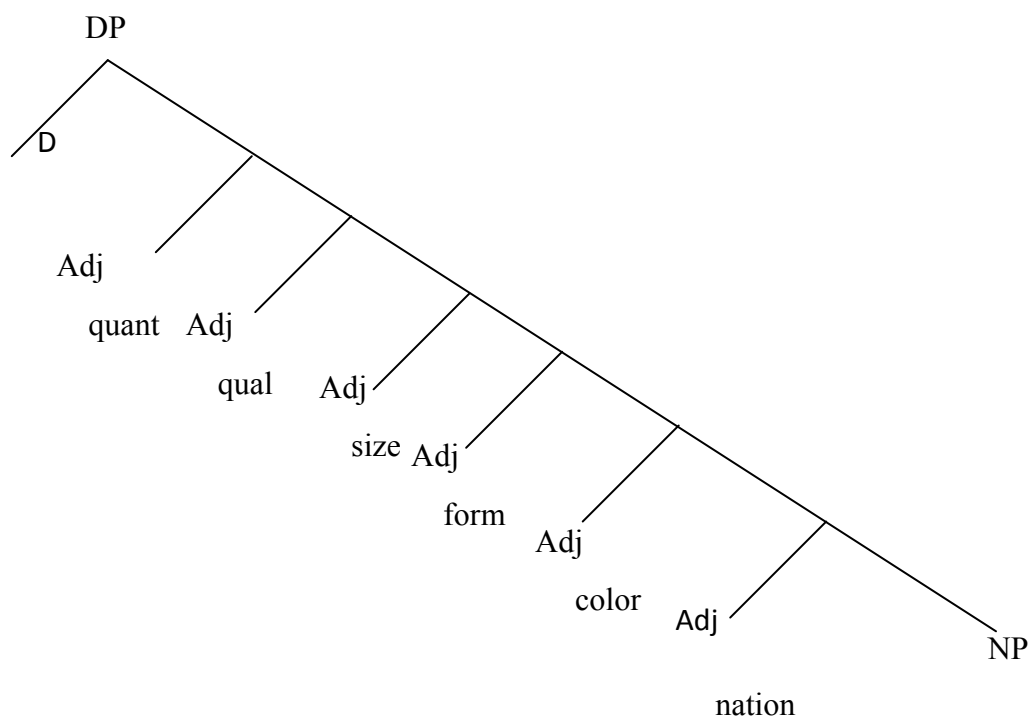

The specifier- based analysis can account for the above hierarchy of adjectives if two basic assumptions are followed. "First, the adjective- related specifier is unique in a given projection (against Chomsky, 1995 Multiple Specifier Hypothesis); second, there are as many adjective-related functional

projections as there are adjectives occurring between the determiner and the noun" (Laenzlinger 2005: 652). The following phrase marker captures the above facts.

(5) (See Cinque 1994; Laenzlinger 2005:653 (16))

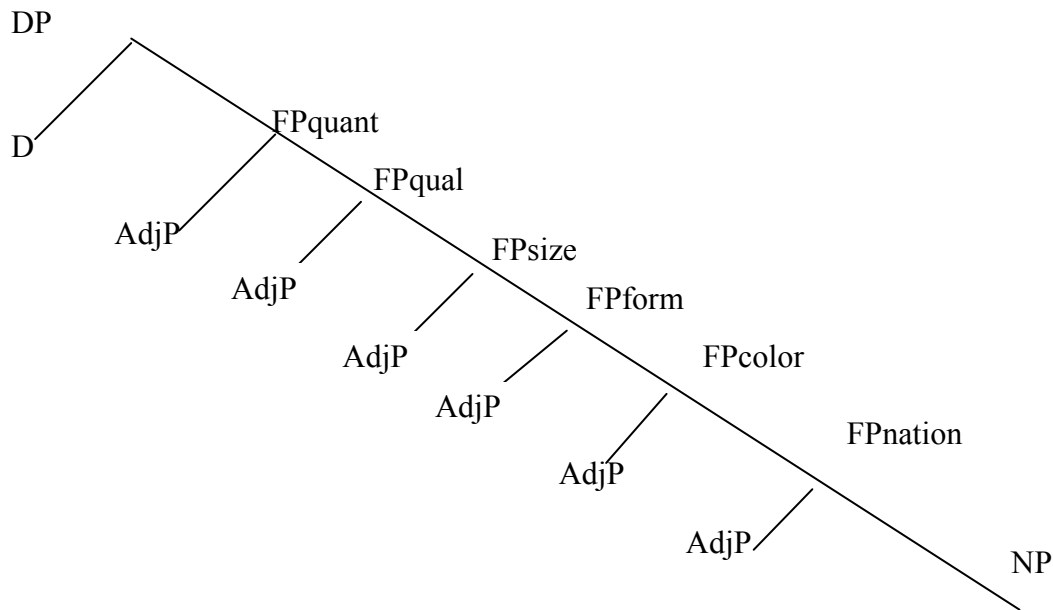

In this system, "adjectives are merged as the specifier of their corresponding FP categories" (Laenzlinger).

On the basis of the above argumentation, how can we account for the derivation of the following nominal construction?

(6)

Vá-	syá	a	vá-	kutu	ava	εéna
Cl2	nice	CON	Cl2	women	these	here

"These nice women"

In (6), the adjective precedes the N and agrees with it in class. A connective occurs between the two. The post nominal determiner also agrees in noun class with the head N and the locative reinforcer closes off the nominal construction. The derivation proposed for (6) is diagrammatically represented in (7) below:

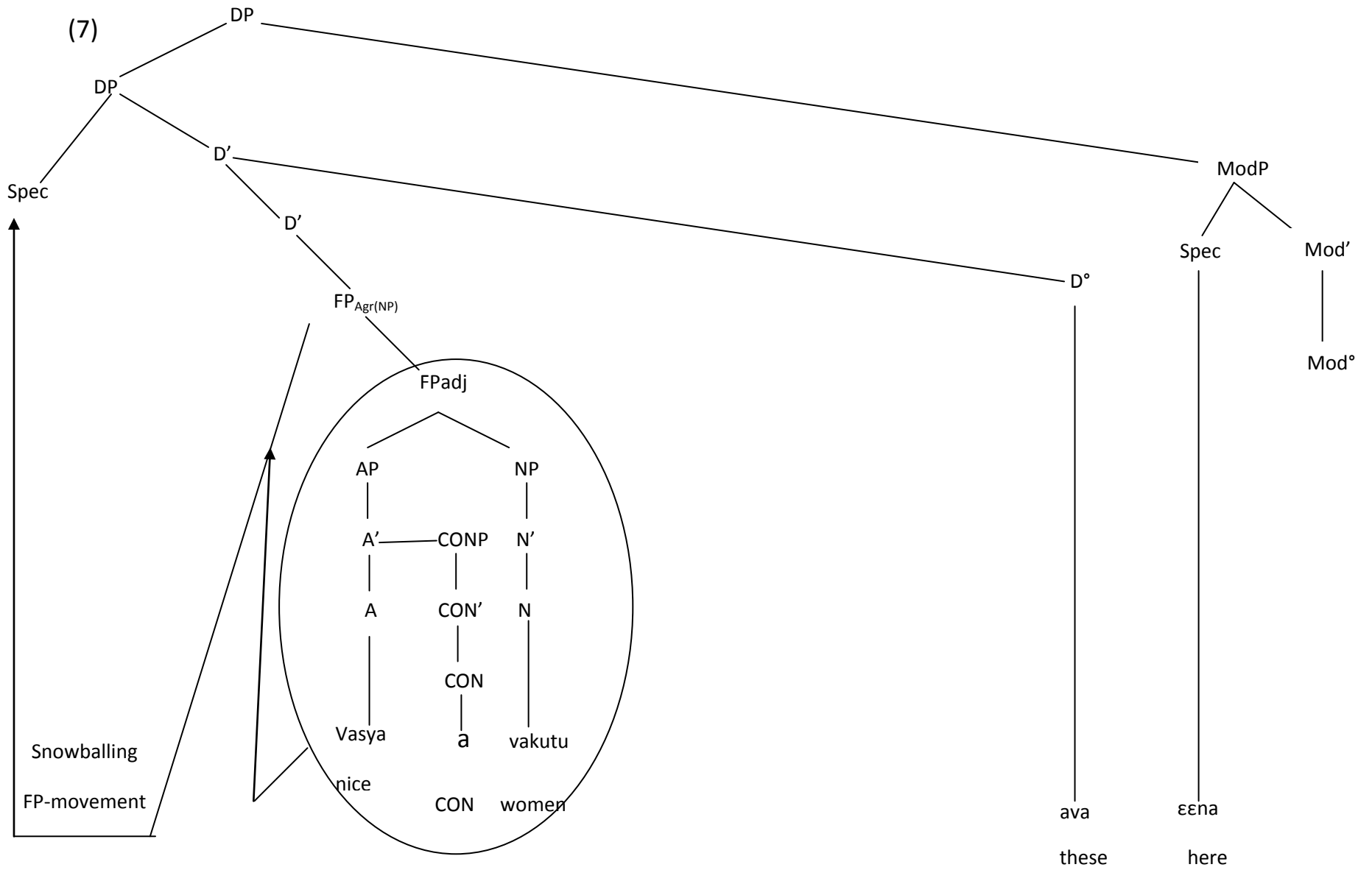

(7) adopts a phrasal movement approach, i.e. an NP-movement analysis whereby the adjective and the noun (FPadj) raise to the specifier position of FPAgr(NP). The NP alone cannot move to that position because it would precede the adjective and the resulting word order would not be appropriate. The whole FPadj has to climb up to the specifier position of FPAgr(NP) because the noun and the adjective agree in noun class, i.e. they must have access to a position wherefrom their number and gender features must be checked. Furthermore, the agreement features of the noun (number and gender) must be overtly checked within the DP-domain.

In (7), after the raising of FPadj to the Spec of FPAgr(NP), it moves from the latter position to the Spec of DP by snowballing FP-movement. This movement is justified by the fact that not only is there strong agreement between the noun and the adjective, but there is also agreement between these two elements and the determiner. The adjective and the noun being hosted by the specifier of DP, Spec-head agreement can obtain between *vasya vakutu* "nice women" and D° *ava* "these". It is therefore the checking of the agreement features on Spec and D° that justifies the raising of the NP and the AP to the relevant agreement positions. The snowballing FP-movement illustrated in (7) is some kind of pied-piping movement which is constrained to a one-step move within NP in Tuki (like in French, cf. Laenzlinger 2005:662). But we will return to this statement shortly. Consider now the nominal expression below:

(8)

Osyá	itíná	a	okutu	ódzú	ééna
Nice	short	CON	woman	this	here

"This nice short woman"

The two adjectives in (8) precede the N. The latter agrees with the two adjectives and the determiner in gender and number (i.e. in noun class). Given this background information, what is the derivation for (8)? First, the adjective and the NP contained in FPadj raise to the Spec of FPAgr. The latter projection is dominated by FPadj which hosts the other adjective (*osya* "nice"). Then, this FPadj and the dominated FPAgr move to the Spec of the higher FPAgr by snowballing FP-movement (see how Aboh 2003 formalized this kind of pied-piping in Gungbe and Laenzlinger 2005 in the analysis of French adjective ordering). Finally, the complex unit in the [Spec, FPAgr] position takes off there and lands in the Spec of DP wherefrom by Spec-head agreement, the adjectives, the N and the determiner in D° will all share gender and number features. The strong agreement relationship holding between the adjectives, the head noun and the demonstrative determiner can be accounted for along these

lines. If this line of reasoning is true, it means that pied-piping movement with snowballing effects cannot be limited to a one-step move within NP in Tuki, contra what was said above with regard to the derivation for (6). On the other hand, the two adjectives that precede the noun in (8) should be realized in a mirror image order with regard to the left-to-right sequence of their corresponding functional projections on the following phrase marker that illustrates the complete derivation for (8):

(9)

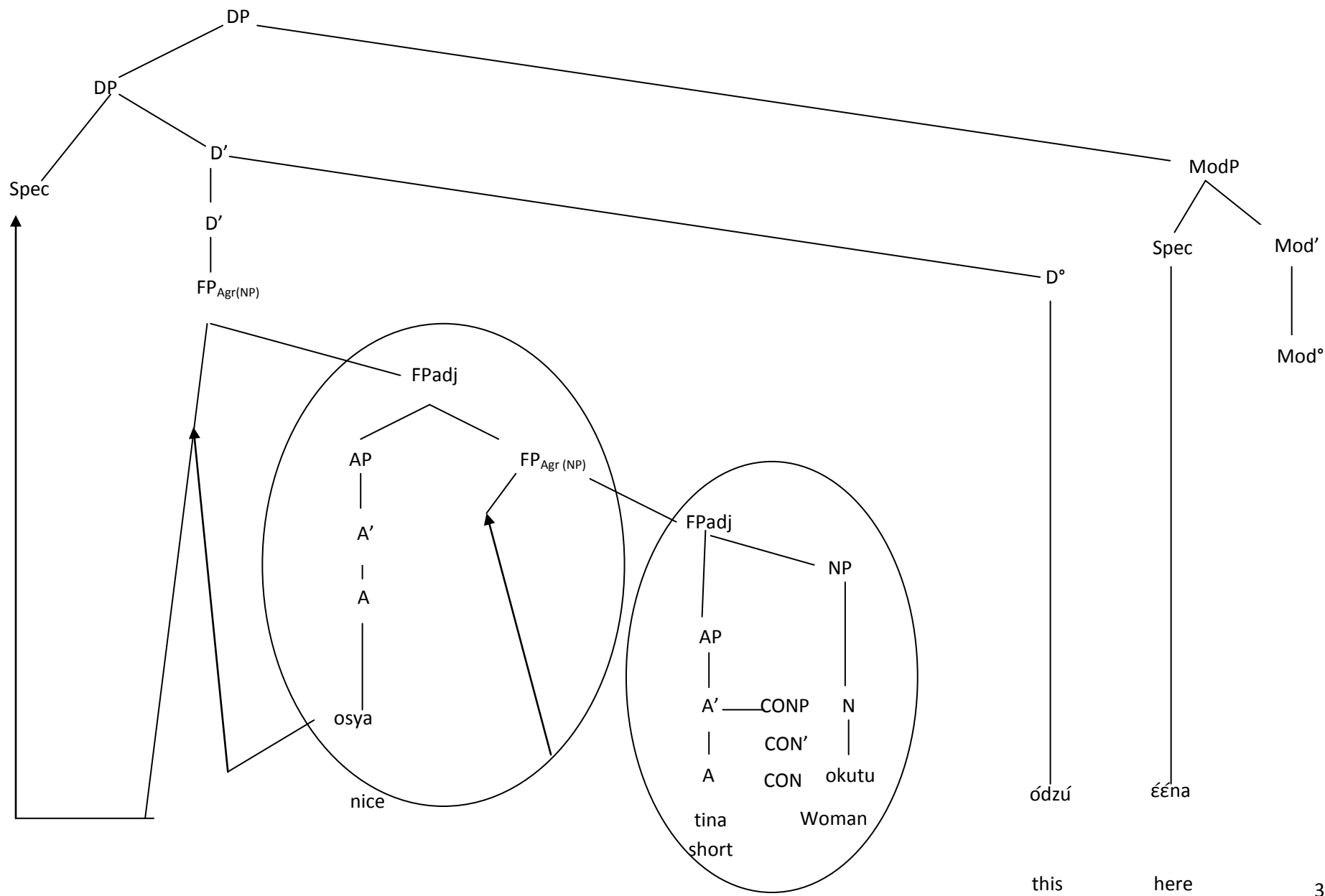

If the two adjectives were realized in a mirror image order with respect to the left-to-right sequence of their corresponding functional projections in the above tree representation, that is if they were lined up in this order:

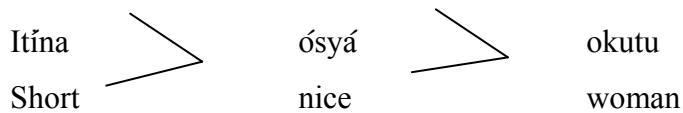

The derivation would be hard pressed to come up with the attested word order:

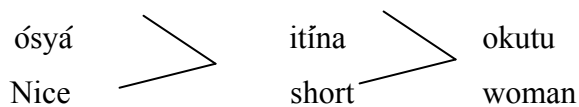

So crucially, in order to obtain the correct derivation, it is important to linearize the (prenominal) adjectives in the way they occur at PF unless some other strategy is devised to obtain the desired result.

The nominal expression just described and analysed contains two prenominal adjectives. Let us now consider one that has three prenominal adjectives:

(10)

Vĩ-kana	vá-	syá	v-	ítína	a-	vá-	kutu	ava	ééna
Cl2big	Cl2	nice	Cl2	short	CON	Cl2	women	these	here

"These big nice short women"

In (10) above, three adjectives precede the head noun which belongs to the noun class 2 (the plural of class 1). The adjectives all carry the nominal class 2 prefix which is a clear indication that they agree in noun class with the head noun. Similarly, the determiner agrees with the head N.

The nominal construction in (10) is derived just like the one in (6). The FPadj containing the most embedded adjective and the head N raises to the [Spec, FPAgr(NP)] position wherefrom, in association with the AP in the intermediate FPadj, it moves to the Spec of the intermediate FPAgr(NP). Then the content of the latter position, coupled with the AP in the Spec of the dominating FPadj, goes to land in the Spec of the highest FPAgr(NP) which from the resulting complex unit will finally travel to the spec of DP. The content of the latter position will henceforth be in an agreement relationship with the determiner in D° through the perennial Spec-head agreement connection. The complete derivation for (10) is provided in (11) below:

(11)

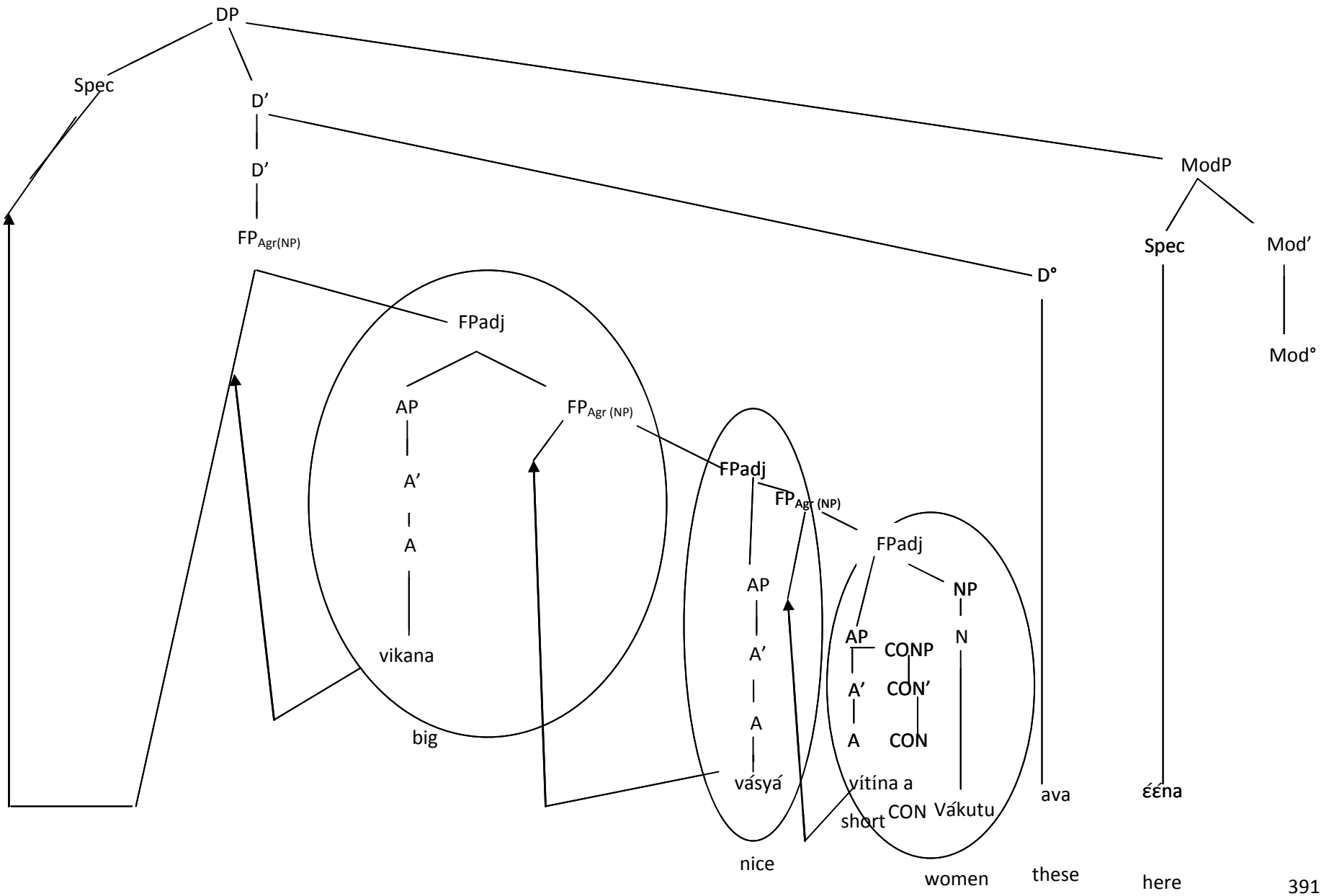

Notice that in the above tree structure representation, the snowballing FP movement has applied in three steps. We will return to this phenomenon shortly, but a more striking issue is that there is a rigid word order as far as the position of the prenominal adjectives within the DP layer is concerned. More concretely, if it is suggested for instance, by Cinque (pc) that snowballing movement should reverse the order of merged elements like in (Aboh 2003, Cinque 2005), the Tuki empirical material does not accommodate this line of analysis, because there is no mirror image order in Tuki due to the fact that the adjectives in (11) above are always prenominal in Tuki, and any random assignment of these adjectives in relation to the noun leads to illicitness.

In the following nominal construction, there are four adjectives that precede the head noun:

(12)

Víkana	vásyá	vítína	vyédza
Big	nice	short	crazy

a	vakutu	ava	ééna
CON	women	these	here

"These big nice short crazy women"

The construction in (12) has basically the same properties as the ones in (6) and (10); there is strong agreement between the head N, the adjectives and the determiner. Its derivation will therefore proceed below as in

(11):

(13)

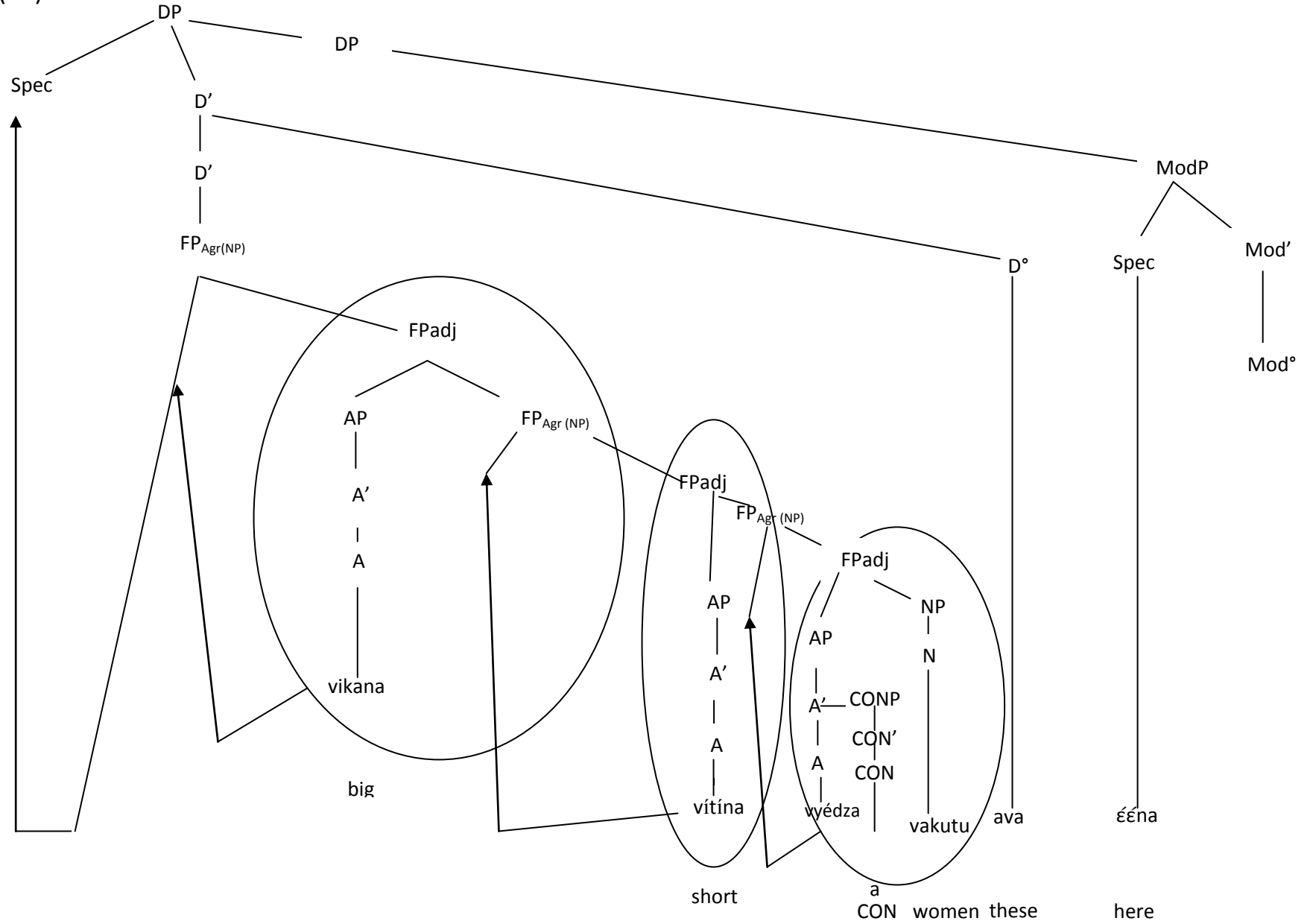

In (13), the snowballing FP-movement is a four step affair. So it seems to be the case that Tuki, like Hebrew (Shlonsky 2000, Laenzlinger 2005:663), can display multiple snowballing effects. Moreover, as in the other cases ((7) and (11)), it is shown that Tuki experiences FP-raising and snowballing FP-movement and the latter appears to be unrestricted, especially with respect to pre-nominal adjective ordering. So far we have talked about pre-nominal adjectives that show agreement with the noun they modify. In the next section, we will talk about adjectives that occur postnominally and that do not show concord with the N they modify.

1.2. Class 2 pure adjectives or postnominal adjectives

All color adjectives and some others are positioned after the noun:

(14)

a. tsónó búútutu
 cloth(es) red
 "Red cloth(es)"

b. mutu fítiti
 man black
 "Black man"

c. yěndze púú
 House white
 "white house"

d. páná sasáá
 plate empty
 "empty plate"

e. Waspíta tos
 hospital full
 "full hospital"

f. Wundi pèteri
 window close
 "close window"

Moreover, they do not show any overtly realized agreement with the noun they modify. In (15) below, despite the fact that the examples in (14) have been pluralized, the adjectives are invariant:

(15)

a. tsónó búútutu

clothes red

“red clothes”

(the form of the word *clothes* is the same for singular and plural)

b. Vatu fítiti

men black

“black men”

c. Vyéndze púú

houses white

“white houses”

d. Vapáná sásáá

Plates empty

“empty plates”

e. Váwaspíta tos

hospitals full

“full hospitals”

f. Váwúndí pétéri

windows close

“close windows”

The above paradigm clearly shows that postnominal adjectives do not agree with Ns. However, the determiners that follow the adjectives display the agreement with the Ns (singular or plural):

(16) Singular forms

a. tsónó búútutu adze

cloth rouge this

“this red cloth”

b. Yéndze púú áyé

house white this

“this white house”

d. pána sasáá adze

plate empty this
“this empty plate”

e. Waspíta tos ódzú

Hospital full this
“this full hospital”

f. Wúndi pétéri ódzú

window close this
“this closed window”

(17) Plural forms

a. Tsónó búútutu ǐdzi

clothes red these
“these red clothes”

b. Vátú fítiti ává

men black these
“these black men”

c. Vyéndze púú íivi

houses white these
“these white houses”

d. Vapána sasáá áva

Plates empty these
“these empty plates”

e. Váwaspíta tos ava

hospitals full these
“these full hospitals”

f. Váwúndí pétéri ava

windows close these
“these close windows”

The above data clearly show that there is strong agreement between the noun and the determiner. This information will become more relevant when we talk about the derivation of some nominal constructions.

Given the above, how many postnominal adjectives can occur inside a DP in Tuki? At most three, it appears:

(18)

a. Mbára a-timb- á-m̄ yěndze fíititi kíítitíí na kongo ra mááng

Mbara SM owns FV Inc. house black small in near of ocean

“Mbara owns a small black house next to the ocean”

b. Matúwa tchunang sasáá mwang ódzú ééna

car yellow empty open this here

“This yellow empty open car”

c. Okutu oki fíititi ntimbi ódzú ééna

woman Tuki black naked this here

“This Tuki black naked woman”

How can we account for the behaviour of Tuki postnominal adjectives? It is customary in linguistic theory to believe that postnominal adjectives occur in a right-adjoined position (Laenzlinger 2005: 647):

(19)

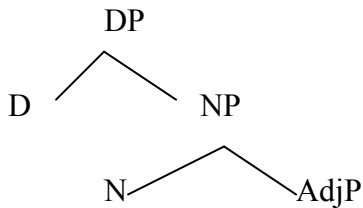

Postnominal adjectives

According to Kayne’s (1994) antisymmetry theory (the Linear Correspondence Axiom), only complements can be right-attached. It follows from this framework that postnominal adjuncts cannot be right attached or cannot occur in a right-hand position. They are rather merged as the left specifier of NP or some higher functional projection. They occur in postnominal position because the noun has moved leftward. The noun can therefore raise as a head. This approach has been adopted by Bernstein (1991), Laenzlinger (2005) within the framework of a spec-head analysis of adjective licensing. Cinque (1999) and Laenzlinger (1999) have extended this approach to adverbs.

(20) (Laenzlinger 2005: 647, (5))

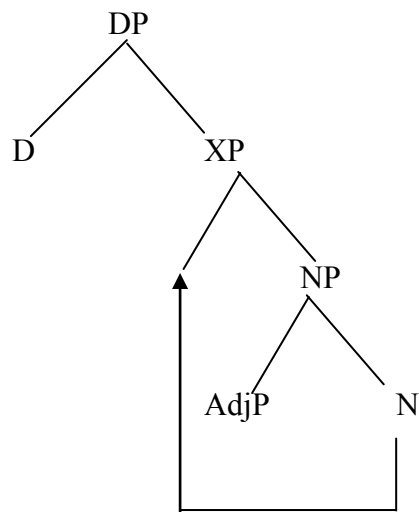

Postnominal adjectives

To analyse the Tuki postnominal adjectives data, we will adopt the noun raising analysis and amend it or fine tune it wherever possible. Consider now the derivation of (16a) repeated for convenience as

(21) Tsónó búútutu ádzé
 Cloth red this
 "This red cloth"

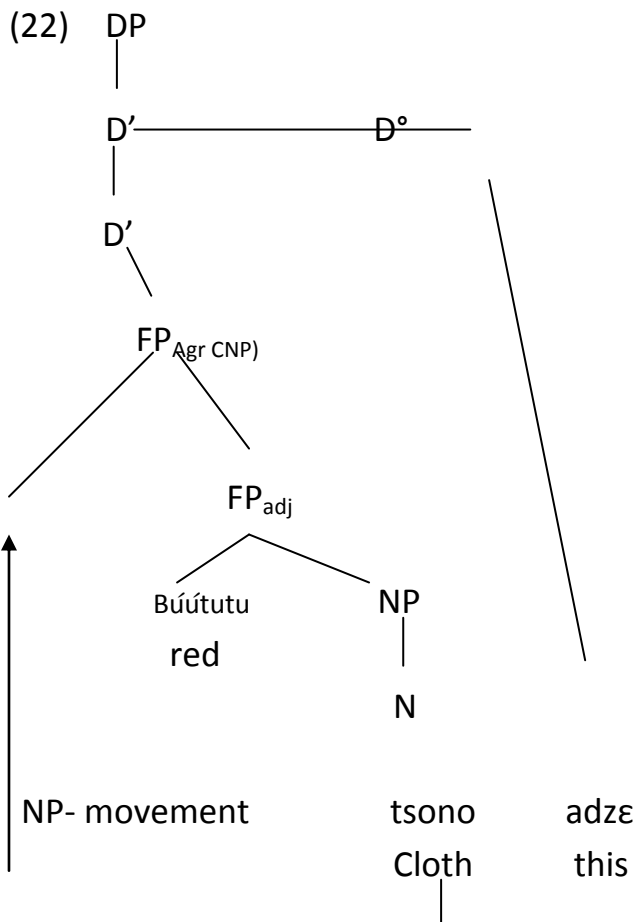

In (22), the noun moves as an NP-Projection to the Spec of FP_{Agr} which from it can check its number and gender features. It is the movement illustrated in (22) that explains the word order attested in the language: N-Adj Det (cf. (21)).

As previously shown, a noun in Tuki can precede one, two or three adjectives:

(23)

a. yëndze fiititi kiititii

house black small

“a small black house”

b. Okutu okí fiititi ntímbí

woman Tuki black naked

“a Tuki black naked woman”

The derivation of (23a) will proceed as in (22): the NP will raise above the two adjectives (in their related functional projections) successive cyclically (by observing a stop over at the intermediate $FP_{Agr(NP)}$), and in the long run, we end up with the mirror image of English “a small black house”. This mirror image effect is a result of NP-movement in a cyclical fashion. The derivation is represented as follows:

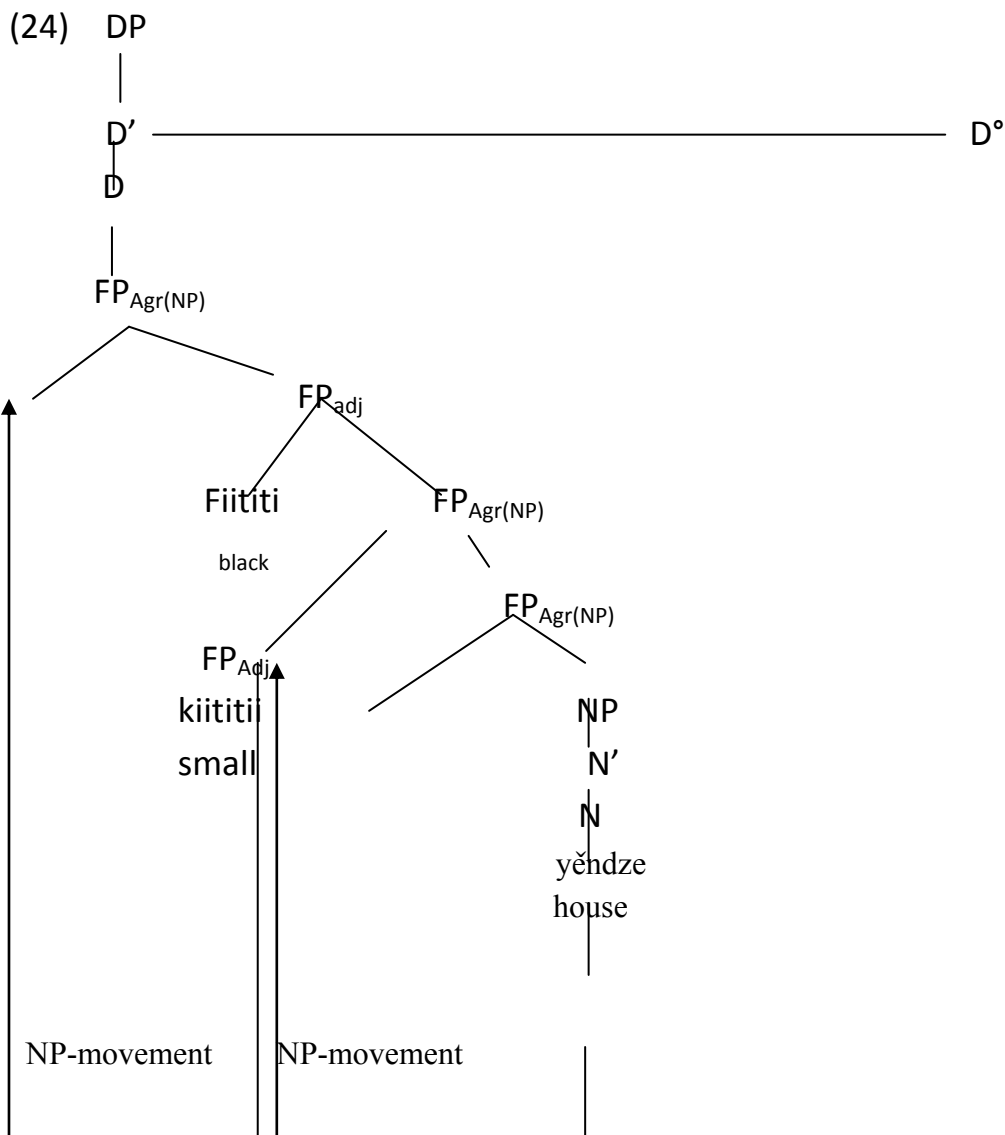

(24) illustrates the successive cyclic raising of a maximal projection into the spec of $FP_{Agr(NP)}$. Only maximal projections can be hosted by specs. It is therefore not possible to say that it is N that moves in (24).

Now what about the derivation of nominal constructions that contain these postnominal adjectives such as (18b-c)? The latter structures are repeated below for convenience:

(25)

- a. matúwa tchunáng sasáá mwáng ódzú ééna
 car yellow empty open this here
 “This yellow empty open car”
- b. okutu oki fítiti ntímbí ódzú ééna
 woman Tuki black naked this here

“This Tuki black naked woman”

In these two examples, the last adjectives seem to behave like predicates. They can only occur in a postnominal position and they must occur on the right of other postnominal adjectival modifiers:

(26)

- a. Okutu ongíma ntímbí
 woman all/every naked
 “all women naked/every woman naked”
- b. * Okutu ntímbí ongíma
 woman naked all/every
- c. * ntímbí okutu ongíma
 naked woman all/every

(27)

- a. yěndze yíma mwáng
 house all/every open
 “all houses open/every house open”
- b. * mwáng yěndze yíma
 open house all/every

Following Laenzlinger (2005: 670), the structural analysis of these predicates is assumed to be a predicate projection, Pred P. The latter projection hosts these predicates in the nominal construction. “Although the position of a predicate is linearly on the right of the position of a postnominal adjective”:

(28) Okutu okí ongíma ntímbí

 Woman Tuki all/every naked

 “All Tuki women naked /every Tuki woman naked”

Laenzlinger “assume[s] that the predicative projection is higher than the projection with which the adjective merges as its specifier”:

(29)

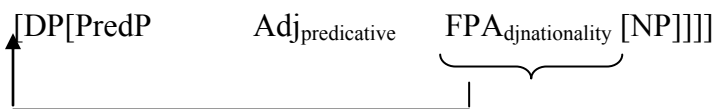

it seems that in a sequence of three postnominal adjectival modifiers, the right-most adjective functions as a secondary predicate in the following configuration:

(30) [N Adj Adj Pred_{adj}]

If that is the case, in the example (25b) repeated for convenience as

(31) Okutu okí fítiti ntímí ódzú ééna

Woman Tuki black naked this here

“This Tuki black naked woman”

Ntímí functions as a secondary predicate. That being the case, how is the configuration (30) derived? The relationship that obtains between the components of the configuration is one of precedence:

(32) N > Adj2 > Adj3 > Adj1Pred

Okutu okí fítiti ntímí

Woman Tuki black naked

The following phrase marker illustrates the way sentence (31) is derived:

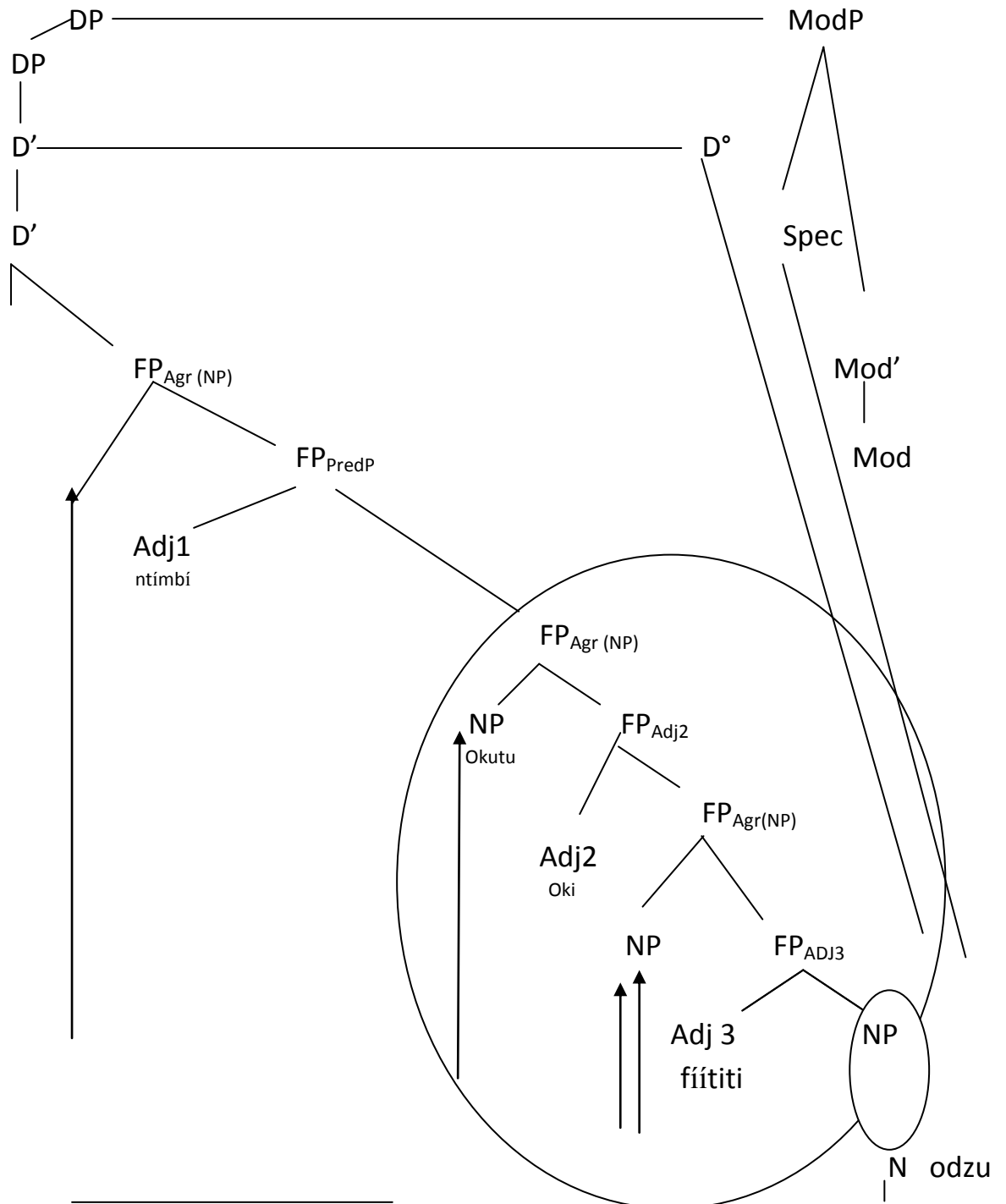

In (33), NP raises successively cyclically twice in order to obtain the NP *okutu_oki fiititi* “Tuki black woman”. Then the latter NP is pied piped by snowballing FP- movement to the specifier position of the highest $FP_{Agr}(NP)$ to obtain *okutu oki fiititi ntimbi* “Tuki black naked woman”. The adjective 1, that functions like a predicate, is merged as the specifier of a predicative projection, FP_{PredP} .

1.3. The interaction between prenominal and postnominal adjectives

It happens that in Tuki a given NP can be modified by both prenominal and postnominal adjectives. The following paradigm illustrates three cases: in the first one, an adjective occurs on each side of the NP; in the second, two adjectives occur on each side of the NP, and in the last one, the NP is flanked by three adjectives on each side.

(34)

- a. ósyá a okutu ngéréno
nice CON woman reddish
“a nice light-skinned woman”
- b. Vasyá vírono a vakutu vakí fítiti
nice old CON women Tuki black
“nice old women that are Tuki and black”
- c. Víkana vasyá vítína a vakutu vakí fítiti nyeménó ava eena
big nice Short CON women Tuki black beautiful these here
“These big nice short women that are Tuki, black and beautiful”

The data in (34c) show that apart from the adjective of nationality *vakí* “Tuki”, post nominal adjectives do not exhibit overt agreement with the head noun. this also. Again, the adjectives ordering in (34c) exhibit some kind of structural equilibrium within the DP layer in such a way that the number of the adjectives at the left edge of the noun *vakutu* “woman” equals to the number of the adjectives at the right edge of the same noun. This, therefore, seems to accommodate the French data provided to us by Laenzlinger (pc) “de nombreuses belles petites voitures rouges Italiennes invendues”. The English translations are just an approximation of the original meanings of the Tuki nominal constructions. The question of theoretical relevance is how are these examples derived. The following tree representations will start to provide an answer:

(35)

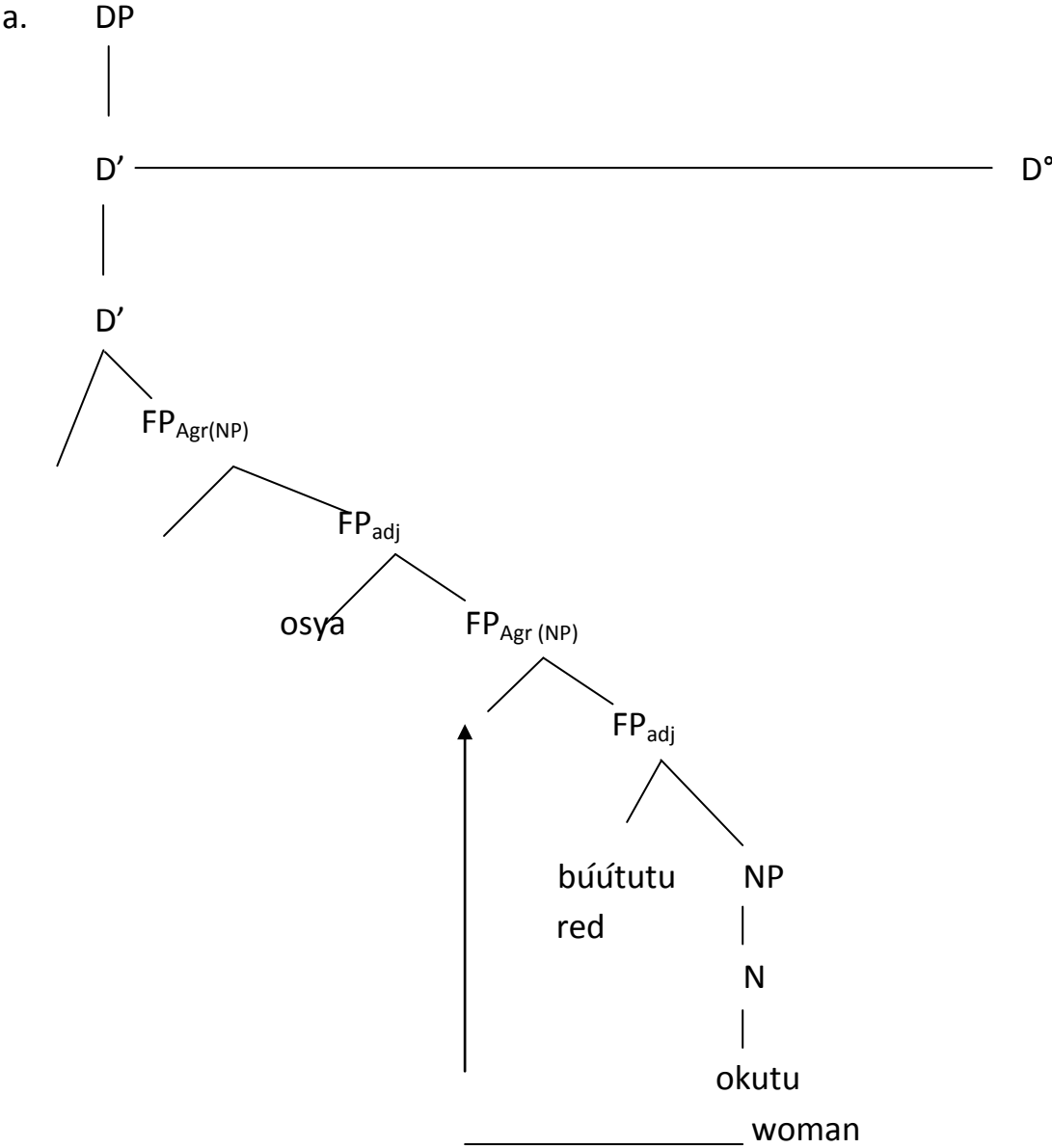

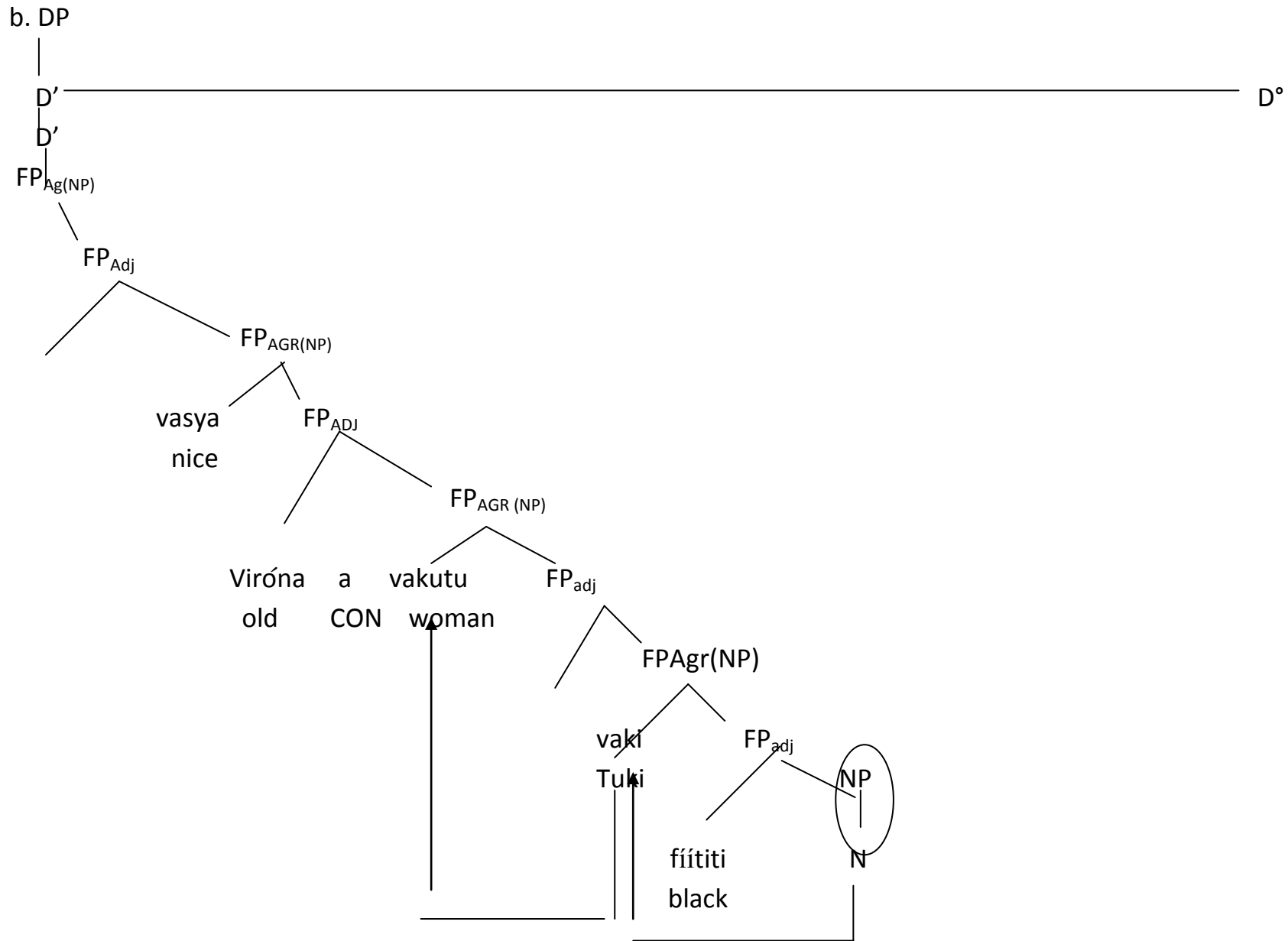

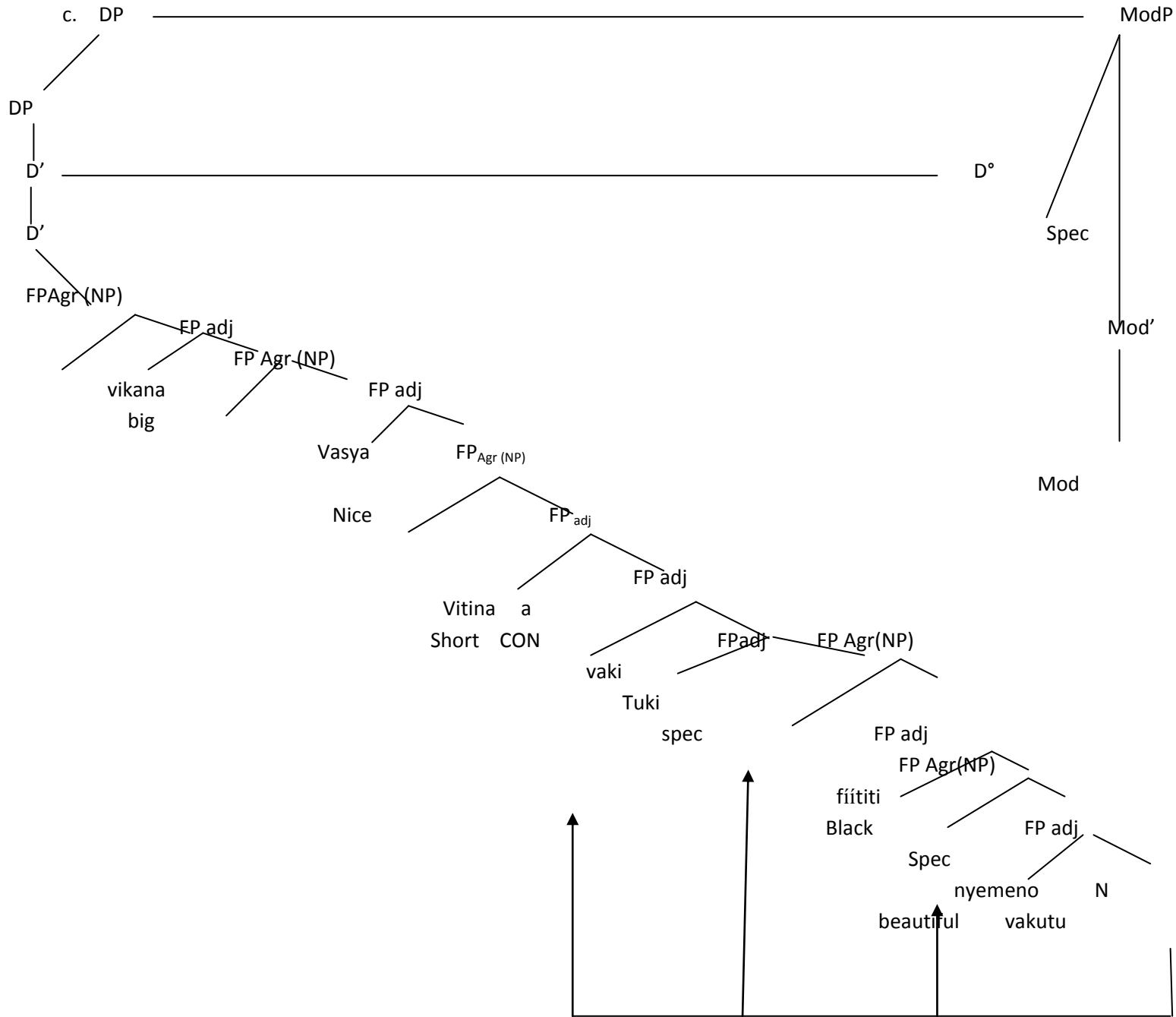

In each of the above phrase markers, the NP moves to the Spec of the highest $FP_{Agr(NP)}$ that is immediately dominated by FP_{adj} , the Spec of which hosts a prenominal adjective. So the $FP_{Agr(NP)}$ that immediately dominates the host of the raised NP cannot accommodate the latter. If the raised NP were to go beyond the last indicated stop, it would occur before an adjective that is intrinsically prenominal, which is illicit. Notice that in (35 b-c), NP raising has applied successive cyclically, as expected.

2. Tuki adjective placement

So far it has been argued that some adjectives are prenominal while others are postnominal. Thus, on the basis of the data described and analyzed until now, it appears that the following classes of adjectives linearly precede the noun:

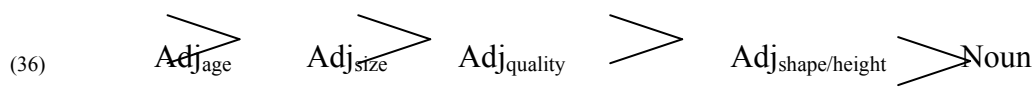

And the following classes of adjectives linearly follow the noun:

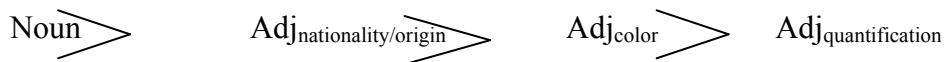

Overall, the placement of prenominal and postnominal Tuki adjectives gives way to the following typology and classification of adjectives occurring in their canonical sequential order:

(38)

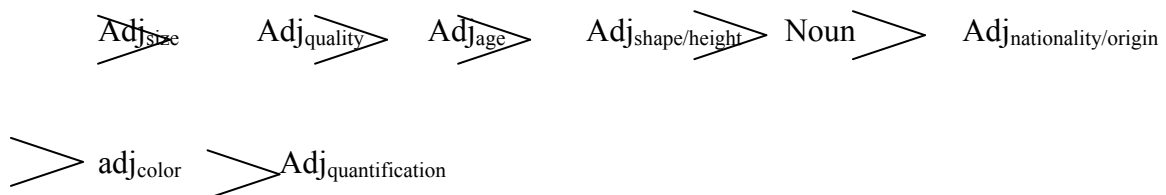

The classification in (36) is illustrated by the following example:

(39)

a. Víkana vásyá vitína a vakutu
 big nice short Con women

“Big nice short women”

b. víkana vásyá vírono a vakutu
 big nice old CON women

“big nice old women”

While the one in (37) is illustrated as follows:

(40)

Vakutu vakí fítiti ifúndu

Women Tuki black many

“many black Tuki women”

The demonstrative determiner and the locative reinforcer can follow the quantifier ifundu “many” in (40):

(41)

Vakutu vakí fítiti ifúndu ava éna

women tuki black many these here

“These many black Tuki women”

The demonstrative determiner and the locative reinforcer can be added to the typology provided in (38) as follows:

(42) Adj_{SIZE} > Adj_{quality} > Adj_{age} > Adj_{shape/height} > Noun > Adj_{nationality/origin} > adj_{color} > Adj_{quantification} > Determiner > Locative reinforcer

Scott (1998, 2002), on the basis of Kingsbury and Wellman (1986), Hinton and Mansden (1985), has shown that the category SIZE can be split into at least two more categories HEIGHT And WIDTH, with HEIGHT preceding WIDTH. Scott argued that the FP SizeP could be further split into the following functional phrases:

LengthP > HeightP > WidthP > WeightP.

Dixon (1982, 24) having suggested that SPEED should be considered a separate adjectival semantic class, Scott proposed a further refinement to the category cline:

LengthP > HeightP > SpeedP > WidthP > WeightP. I will not discuss the above categories and their ordering restrictions, any longer, here.

The adjectival sequential ordering displayed in (42) can be expressed, following Laenzlinger (2005), in terms of a hierarchy of positions associated with distinct classes of adjectives. In a Tuki DP, the head N can both be preceded and/or followed by adjectives (prenominal and postnominal). In the following phrase marker, the adjectives are positioned in such a way that their top- down hierarchy of merging corresponds to their left-to-right ordering:

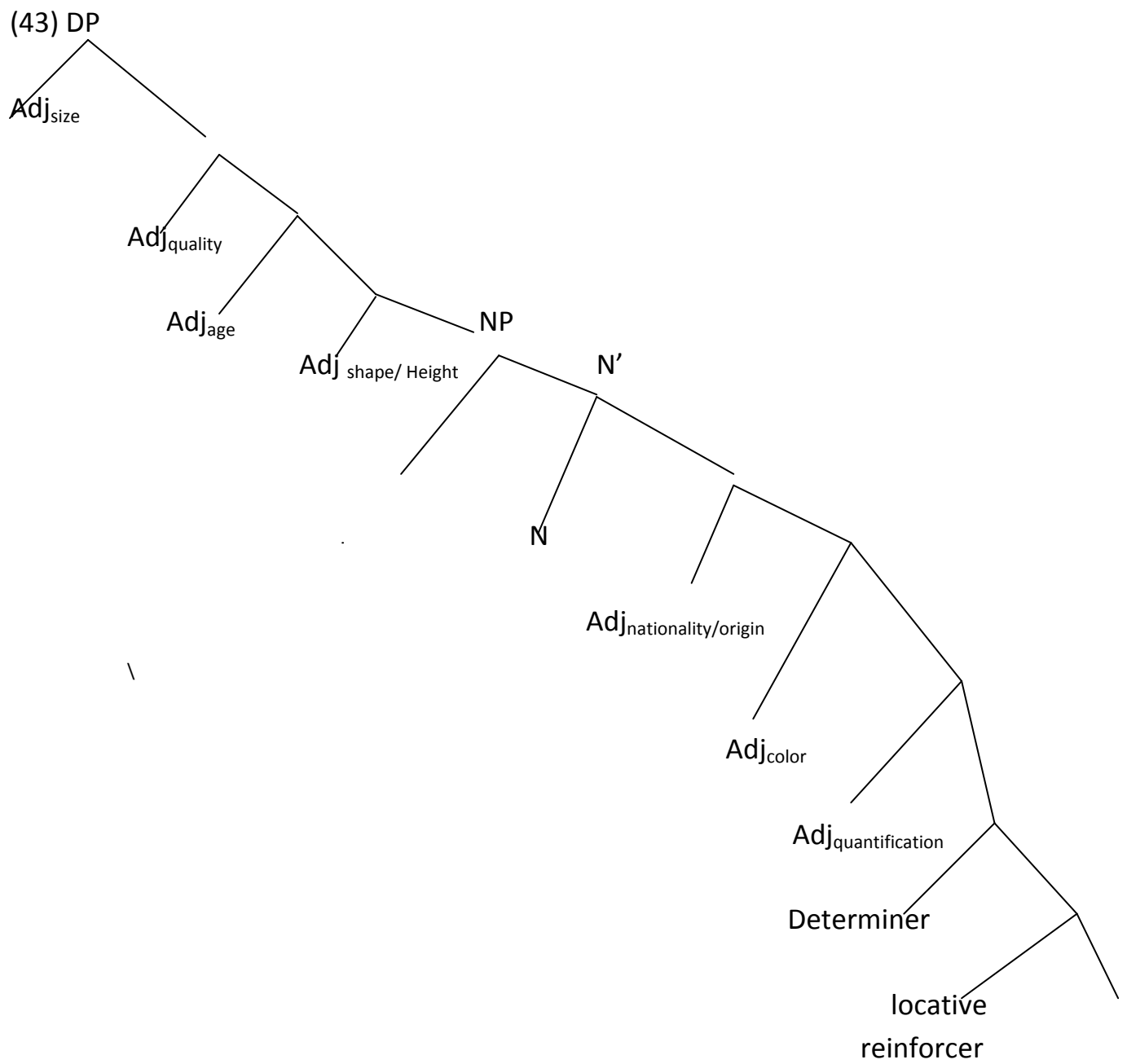

3. Verbal adjectives

Verbal adjectives are derived from verbs, as illustrated by the following examples:

(43)

a. Verbs

1. ogura ‘to grin’
2. osuwa ‘to wash’
3. onámbá ‘to cook’
4. oféndá ‘to repair’
5. obuna ‘to open’
6. opéťé ‘to close’
7. onyémé ‘to be beautiful’
8. opuma ‘to shine’

1. gorénó ‘ground’
2. tsówenó ‘washed’
3. námbenó ‘cooked’
4. féndenó ‘repaired’
5. bunárí ‘opened’
6. Péťéfi ‘closed’
7. nyémenó ‘beautiful’
8. pomeno ‘shining’

The above list is far from being exhaustive. Verbal adjectives are also attributive. They occur postnominally and do not agree in noun class (class/number) with the noun(s) they modify:

(44)

a. yěndze tsówenó
house washed
‘a washed/clean house’

b. Manyá námbenó
food cooked
‘cooked food’

c. owúndu gorénó
peanuts ground
‘ground peanuts’

d. tsónó gorénó
clothes pressed
‘pressed clothes’

e. ikunda féndéno
bed repair

‘‘repaired bed’’

f. okutu nyéméno

woman beautiful

‘‘beautiful woman’’

h. ofútú bunari

door opened

‘‘opened door’’

Verbal adjectives are formed by suffixing the morpheme /no/ or /ri/ to the verb stem. The quality of the final vowel (FV) undergoes some changes in features when the affix is /no/ : it is a typical case of vowel harmony. No such changes occur when the suffix is /ri/.

As previously stated, verbal adjectives behave like postnominal attributive adjectives, and similarly they do not show class/number agreement with the noun(s) they modify. That being the case, a DP containing a postnominal verbal adjective should be derived in similar manner illustrated in (22) above:

(45)

a.okutu nyéméno ódzú

woman beautiful this

‘‘this beautiful woman’’

b.

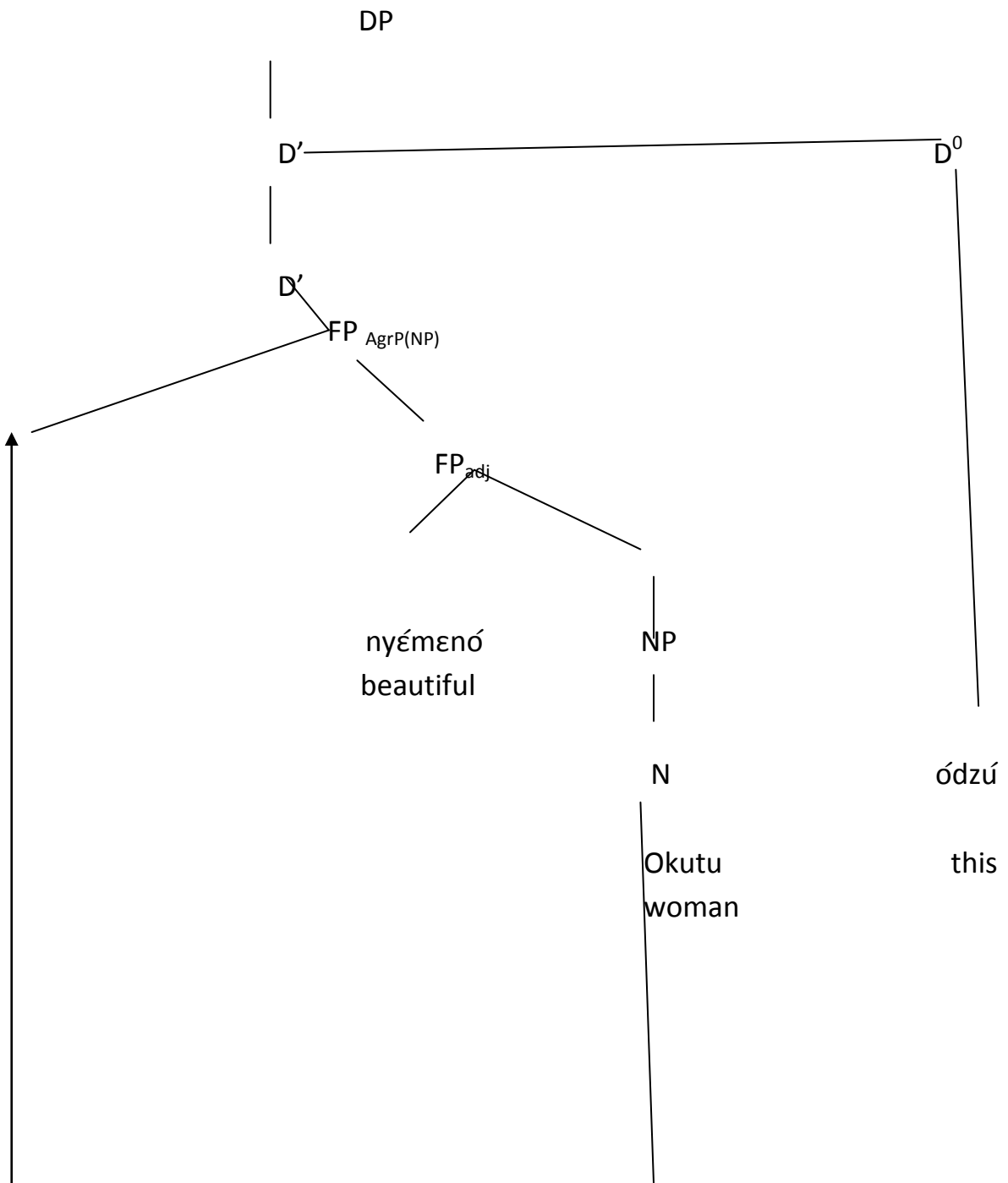

NP- movement

In (45b), the noun moves as an NP-projection to the Spec of FP_{Agr} wherefrom it can check its number and gender features. It is the raising of NP that accounts for the word order N-Adj-Det attested in the language.

Conclusion

In Tuki, some adjectives are prenominal while others are postnominal. A DP in this language can contain up to six adjectives, three on each side of the head N. Following other proposals in the scientific literature (Cinque (1994, 2010), Scott (1998, 2002), Laenzlinger (2005)), it has been argued that adjectives substitute for the specifier positions of these semantically associated projections. It has been said that the noun raises as a NP to a functional agreement position (called FP_{NP}). Moreover, the movement of the NP to the specifier of the closest functional agreement projection, $FP_{Agr(NP)}$, produces a snowballing FP movement. The latter raising operation takes place cyclically and lands in the specifier position of an agreement projection since in this language the head N agrees in noun class (number and gender) with the determiner(s) and its adjective(s).

The study of the placement of prenominal and postnominal Tuki adjectives has suggested the following typology and classification of adjectives occurring in their canonical sequential order:

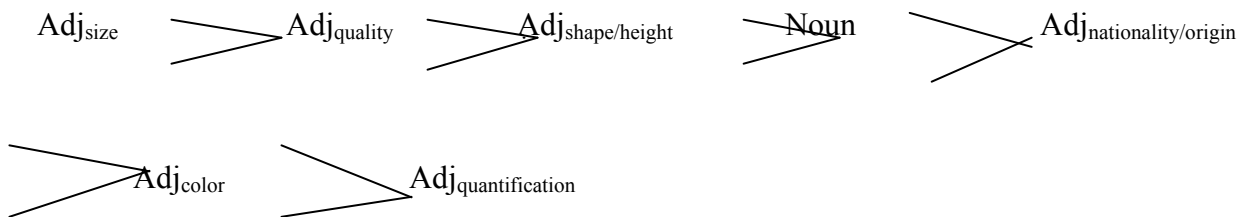

CHAPTER ELEVEN

The cartography of the left periphery

Introduction

Cinque and Rizzi (2008:42) define the cartography of syntactic structures as “the attempt to draw maps as precise and detailed as possible of syntactic configurations [...] it is a research topic asking the question: what are the right structural maps for natural language syntax?” In conformity with the above theoretical framework, this paper scans the cartography of the left periphery in Tuki, a Bantu language spoken in Cameroon and previously studied by Biloa (1989, 1990, 1991 a-b, 1992, 1995). It is argued that in this language question formation substitutes *wh*-phrases for the specifier position of a headed constituent focus phrase (called FP). Moreover, it appears that there is a maximal projection that dominates Force Phrase (ForceP) and that hosts a null operator and an agreeing word in Tuki relatives: this maximal projection is called a Relative Phrase (RelP). Furthermore, following Rizzi (1997) and Haegeman (2000), Tuki topicalized constituents are said to substitute for the specifier position of Topic Phrase ([Spec, TopP]). Since Tuki yes-no questions in matrix and embedded contexts are introduced by a QM (question morpheme), it is posited that this special morphological marker is hosted by a position Int(errogative) (cf. Aboh (1998), Rizzi (2001 b)), while the null question operator à la Grimshaw (1993) and Roberts (1993) occupies Spec-IntP. The head of this Int(errogative) Phrase can be occupied as well by *ngi* “if”. Another Q morpheme, *aa*, which occurs clause finally, is said to be able to occupy Int^o. It can either induce a yes/no question interpretation or be a Q particle (à la Japanese or Korean). Finally, Tuki preposed and IP-internal adverbs are argued to fill the Spec position of a dedicated head called Mod (ifier) (Rizzi 2004b).

1. The focus phrase (FP) in Tuki

Evidence is provided that in Tuki, *wh*- items move to the specifier position of a headed constituent focus phrase. This section is organized as follows. In subsection one, the structure of focus sentences is discussed. Subection two provides the structure of matrix *wh*-questions, while in subsection three it is shown how embedded *wh*-questions are formed in the language. In subsection four, it is argued that in Tuki *wh*-questions the choice of the focus word varies with the choice of the *wh*-word, suggesting that an agreement relation obtains between them. Subsection five claims that there is a phrasal constituent between CP and IP called F(ocus)

P(hrase). Subsection six addresses the issues of the origin of what is called the focus word. Subsection seven proposes a unified account of focus sentences and wh-questions.

1.1 Structure of focus sentences

Focus constructions in Tuki are characterized by the appearance of the *marker odzu* (depending on the noun class agreement with the focused element) after the focused constituent:

(1)

a. Abongo a- ma- kos- en- a agee waa yendze idzo

Abongo SM p2 buy appl (for) FV wife his house yesterday

'Abongo bought his wife a house yesterday'

b. Abongo odzu a- ma- kos- en- a agee waa yendze idzo

Abongo FOC SM P2 buy appl (for) FV wife his house yesterday

'It is Abongo who bought his wife a house yesterday'

c. yendze aye Abongo a- ma- kos- en- a agee waa idzo

house FOC Abongo SM P2 buy appl (for) FV wife his yesterday

'It is a house that Abongo bought for his wife yesterday'

d. agee waa odzu Abongo a- ma- kos- en- a yendze idzo

Wife his FOC Abongo SM P2 buy appl (for) FV house yesterday

'It is his wife that Abongo bought a house yesterday'

e. idzo owu Abongo a- ma- kos- en- a agee waa yendze

Yesterday FOC Abongo SM P2 buy appl(for) FV wife his yendze

'It is yesterday that Abongo bought his wife a house'

Notice that in Tuki any constituent of the sentence except the verb (in the examples provided here) can be focuses and can appear in pre-FOC position. In view of the examples illustrated above, we observe that focus sentences in Tuki have the following schematic structure (the identity of ?P and ? will be specified as I proceed):

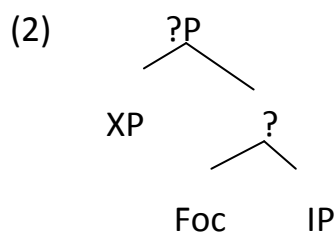

XP stands for the focused element whereas the focus word is **odzu** in (1b) above.

In the next section, it is shown that the structure of matrix wh-questions is very similar to the structure of focus sentences in Tuki.

1.2 Matrix wh-questions

Essentially, Tuki has the following wh-phrases

(3) Arguments

Andzu (ane odzu) 'who'

Ate 'what'

(4) Referential Adjuncts

ni 'when'

tane 'where'

(5) Non-Referential Adjuncts

twi 'how'

owate 'why'

For a principled distinction between referential and non-referential adjuncts, see Aoun (1986).

Wh-movement in Tuki is optional. The questioned constituent may remain in situ or move to pre-IP position:

(6) Wh-phrases in situ

a. Puta a- dingam ane

Puta SM loves who

'Puta loves who'

b. Puta O- endam n(a) adongo ni

Puta SM does to village when

'When does Puta go to the village?'

(7) Clause initial position

a. andzu Puta a-dingam

who Puta SM loves

'Who does Puta love?'

b. ni Puta O-endam n(a) adongo

when Puta SM goes to village

‘When does Puta go to the village?’

Bear in mind that *andzu* is the shorthand form of *ane + odzu*. Now notice that a focus word can appear with wh-items when movement occurs in the syntax:

(8) a. ane odzu Puta a- nu- banam

Who Foc Puta SM f1 marry

‘Who will Puta wed?’

b. ate aye Puta a- ma- namba

what FOC Puta SM P2 cook

‘What did Puta cook?’

c. ni owu Puta O- endam n(a) adongo

When FOC Puta SM goes to village

‘When does Puta go to the village?’

d. Owate owu Puta a- m(a)- iba moni

why FOC Puta SM P2 steal money

‘Why did Puta steal the money?’

There is evidence that the focus word that occurs with wh-words is the same element that shows up when a non wh-word is focused. Consider for instance the following sentences:

(9) a. Dima odzu Puta a- nu- banam

Dima FOC Puta SM fi marry

‘It is Dina that puta will wed’

b. adzakassa aye Puta a- ma- namba

donkey FOC Puta SM P2 cook

'It is the donkey that Puta cooked'

c. nambari owu Puta O- endam n(a) adongo

tomorrow FOC Puta SM goes to village

'It is tomorrow that Puta goes to the village'

d. [na wuco wa atoki] owu Puta a- m(a)- iba moni

in front of throat FOC puta SM p2 steal money

'It is out of greed that Puta stole the money'.

If we compare the above constructions with those in which a wh-item has been fronted, the only difference is the occurrence of wh-items in the latter and the occurrence of 'ordinary' noun phrases in the former sentences. Everything else being equal, it seems then to be the case that matrix wh-questions in Tuki exhibit a structure similar to focused sentences. When movement occurs at s-structure, tuki matrix wh-questions are formed:

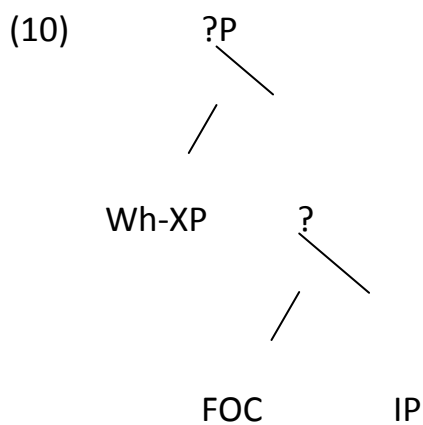

Foc above represents the **Focus word**. Bear also in mind that the focus word necessarily agrees in noun class with the focused element (wh-item or not). We will attempt to formalize this agreement relation in section 4. Next, we turn to embedded wh-questions in Tuki.

1.3 Embedded wh-questions

In Tuki embedded questions are introduced as complements of verbs like **wudza** ‘tell’ say’, **obungana** ‘think, believe’, **osesa** ‘ask’ ,**widzima** ‘know’. The wh-item in an embedded question can be either what Baker (1970) calls the yes-no particle *ngi* ‘if’ ‘whether’ or one of the wh-words illustrated above.

(11)

a. Puta a- t- idzima ngi aneme waa a- nu- aram nambari

Puta SM Neg know whether husband her SM f1 come tomorrow

‘Puta does not know whether her husband will come tomorrow’

b. Mbara a- sesam mwana waa ee ni a- nu – suwam tsono raa

Mbara SM asks child his that when SM f1 wash clothes his

‘Mbara asks his child when he will wash his clothes’

Tuki has a lexical complementizer **ee** ‘that’: it appears in pre-IP position of clauses introduced by the verbs shown above. The presence of **ee** is compulsory, unlike its English counterpart. The constructions illustrated below (in (12) and (13)) are not instances of direct quotation:

(12) a. Mbara a- m(u)- udza *(ee) Puta a- nu- nambam cwi

Mbara SM P1 say that Puta SM f1 cook fish

'Mbara said that Puta would cook fish'

b. iyere a- dingam *(ee) vadzu va sukuru vaa va- yere

teacher SM loves that children of school his SM teach

'The teacher wants his students to study'

Now notice that a focus word can also occur in a Tuki indirect question:

(13)

a. Mbara a- sesam [ee [ane [odzu [Puta a- m(a)- ena]]]]

Mbara SM asks that who FOC Puta SM p2 see

'Mbara asks who Puta Saw'

b. Mbara a- sesam [ee [ate aye [Puta a- mu- kusa]]]]

Mbara SM asks that what FOC Puta SM p1 buy

'Mbara asks what Puta bought'

c. Mbara a- sesam [ee [ni [owu [Puta a- nu- fowam yendze yaa]]]]

Mbara SM asks that when FOC Puta SM f1 build house her

'Mbara asks when Puta will build her house'

d. Mbara a- sesam [ee [owate [owu [Puta a- nobam mwana waa]]]]

Mbara SM asks that why FOC Puta SM beats child her

'Mbara asks why Puta beats her child'

The examples exhibited above suggest that Tuki embedded questions are formed:

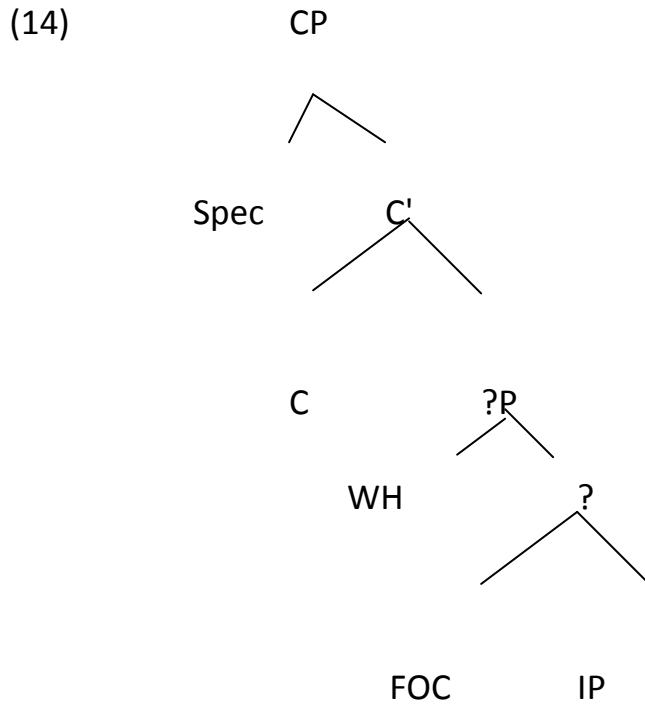

In the section that follows, we address the issue of the agreement relation that obtains between the fronted wh-word and the focus word.

1.4 Spec-Head Agreement

In Tuki wh-questions, the morphological features of the focus word are crucially dependent upon the choice of the wh-element. This suggests that an agreement relation holds between the wh-element and the focus item. Before we formalize this agreement phenomenon, let us briefly describe the facts.

In this language, a wh-question can have two items in pre-IP position as shown below:

(15) a. ane_i (odzu) Mbara a- dingam x_i

Who FOC Mbara SM loves

'Who does mbara love?'

b. ate_i (aye_i) Puta a- nambam x_i

What FOC Puta SM cook

'What does Puta cook?'

It appears that the so called CP position in Tuki may contain the following two sets of elements:

(16) ane 'who'----- odzu

ate 'what' ----- aye

ni 'when' -----owu

tane 'where' ----- owu

twi 'how' ----- owu

owate'why' ----- owu

It is not the case that random selection of elements from the two sets of items (above) will automatically give a correct Tuki wh-question. It is strictly the case that the choice of the optimal element (from the second set) is predetermined by the choice of the compulsory element, which in turn must agree in features with the former. Bear in mind that Tuki is a noun-class language. This is tantamount to saying that the moved wh-word and the potential element accompanying it must agree in noun class. The occurrence restriction obtaining between the wh-word and the Foc element extends to the

focussed item and FOC combination. That is the focussed item and the FOC word agree in noun class as well. It should also be borne in mind that the optional element can show up in a wh-question only when there has been movement, never when the wh-item remains in situ, as illustrated below:

(17) a. Mbara a- dingam ane (*odzu)

Mbara SM loves who

'Who does Mbara love?'

b. Puta a- nambam ate (*aye)

Putu SM cooks what

'What does Puta cook?'

c. Dima a- mu- noba agee waa owate (*owu)

Dima SM P1 beat wife his why

'Why did Dima beat his wife?'

To formalize the agreement relation between a moved wh-phrase and a focus word, let us introduce the notion of SPEC-Head Agreement from Chomsky (1986:24). Chomsky (1986:27) indicates that C and its specifier, I and its specifier share certain features. Chomsky further argues that extracted wh-phrases substitute to the specifier position of CP. Let us assume that syntactically moved wh-phrases in Tuki substitute to the specifier position of a maximal projection, let us call it ?P (the exact identity of which will be specified as we proceed); moreover assume that the focus word is the head of ?P. Given this crucial assumption, the agreement phenomenon holding between a moved wh-word and a focus word is a case of SPEC-HEAD Agreement. Following

Carstens and Kinyalolo (1989), we propose that cases of SPEC-Head agreement (wh-agreement, subject agreement and object agreement) be handled by the SPEC-Head Agreement hypothesis:

(18) SPEC-HEAD AGREEMENT HYPOTHESIS

The @-features of [SPEC, a] are spelled out on a.

The above hypothesis will ensure that in Tuki wh-questions, a focus word (a) will copy the @-features of the moved wh-item (SPEC).

In terms of the AFFECT criterion (Haegeman 1995), both focus and interrogative operators must be in a Spec- X^0 agreement with a head bearing the feature [+ foc/wh], and vice versa, with the relevant head being the focus marker in Tuki. In the latter language, focus and interrogative constructions show that the Spec- X^0 relation must be established between the operator [+foc, + wh] and the X^0 (*odzu*, *adze* or *owu...* etc), equally being assigned the features [+foc, + wh] (see also Durrleman 2005: 113-157).

Tuki provides evidence for the directionality implied in (18) in that agreement copying proceeds from left to right, that is it is the element in Spec that necessarily assigns its features to FOC (and not versa).

Notice that our analysis predicts that long distance wh-movement would leave agreeing Focus words in intermediate FPs.

That is precisely what happens:

(19) a. Puta a- mu- dza ee vadzu va- mu- enda na ndzana

Puta SM p1 say that children SM p1 go to forest

'Puta said that children went to the forest'

b. Tane owu Puta a- mu- dza ee (owu) vadzu va- mu- enda?

Where FOC Puta SM P1 Say that FOC children SM p1 go

'Where did Puta say that children went?'

c. ane (odzu) mamu obunganam ee (odzu) Mbara idzimam ee (odzu) Puta

who Foc you think that Foc Mbara knows that Foc Puta

a- nu-banam

SM F1 marry

"who do you you think that Mbara knows Puta will marry?"

(b) an (c) constitute evidence that there is a functional projection between CP and IP. For if there were one maximal projection, **ee** and **owu** would be in complementary distribution, as in Germanic languages where there is a complementary distribution between V-movement to C and the presence of a lexical complementizer (see den Besten (1977) and Koopman (1984)). The optionality of the agreeing Focus word in the (b) sentence is plausible in view of the fact that the same optionality obtains in matrix contexts.

In terms of Chomsky's (2000, 2001) system, which makes use of Agree, valuation and phases, one could say that the agreeing focus head is a reflex of EPP (since it does not occur in the absence of overt movement) and also lexicalizes the Agree relation between it and the wh-element. Moreover, the Tuki data, as illustrated (19b-c), suggest that the Focus Phrase (FP) is a phase in this language. The agreeing focus head left behind at intermediate landing sites imply that (long-distance) wh-movement involves the raising of the wh-

expression through intermediate [Spec,FP] positions: a phase-based theory of syntax would predict exactly that state of affairs (see Felser 2001; Nunes 2001; Thornton 1995; Guasti, Thornton and Wexler 1995; Alison Henry 1995; McCloskey 2001; Chung 1994; Cole 1982; Saddy 1991; Cole and Hermon 2000; Kayne 1994; Bejar and Massam 1999; Radford 2004 for seemingly similar facts in other languages). So the Focus Phrase (FP) is a phase in Tuki, just as CP is a phase in English, Irish, Chamorro, Afrikaans, Frisian, Romani, German (see Radford 2004:289-319 and references cited therein).

Radford (2004:228) suggests that a fundamental principle of UG is a Locality Principle which requires all grammatical operation to be local. On the basis of the probe-goal terminology introduced by Chomsky, the Locality Principle can be interpreted as meaning that all grammatical operations involve relation between a probe goal and a local goal (- which is sufficiently “close” to the probe. Wondering why probe-goal relations must be local, Chomsky (2001:13) indicates that “the P, G relation must be local” in order “to minimise search” (i.e in order to ensure that a minimal amount of searching will enable a probe to find an appropriate goal). He claims that locality is forced by the need to “minimize search”. Radford (2004:228) explains that search should be minimized for processing reasons: the Language Faculty can only process limited amounts of structure at one time-and, more specifically, can only hold a limited amount of structure in its “active memory” (Chomsky 1999:9). A “reduction of computational burden” is made possible if “the derivation of EXP[ressions] proceeds by *phase*” (Chomsky 1999:9). In other words, syntactic structures should be built up *one phase* at a time. For Chomsky (2001:14), “phases should be as small as possible, to minimise memory”. Phases are “propositional” and include CPs. The latter maximal projections are phases

because CP represents a complete clausal complex (including a specification of *force*) (see also Radford 2004:228, 289-314).

From the above reasoning, it follows that movement should be local and propositional. More specifically, the relation between a probe and a goal should be local and propositional. This easily explain why-movement in Tuki is successive-cyclic, and why the F(ocus) P(hrase) in this language is a phase: at each intermediate FP, a Foc marker can appear, there by indicating that a wh-phrase in transit momentarily did stop there.

Now, refocalizing our attention on the agreement that obtains between a raised wh-phrase and a so-called focus marker (Foc). That relation can be formally characterized in terms of probe and goal:

(20)

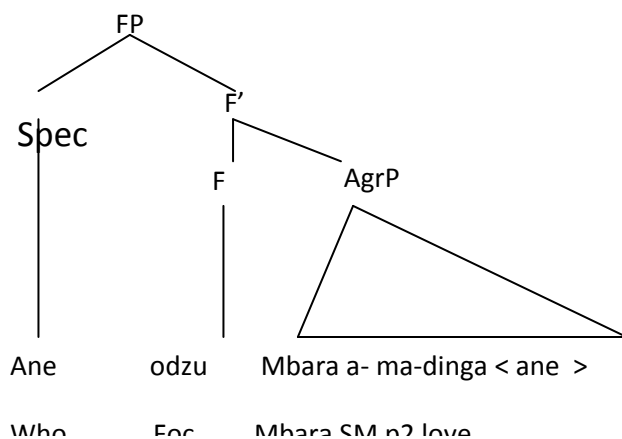

According to Chomsky (1999:4), “Probe and Goal must both be active for Agree to apply”. Moreover, the MIT scientist argues that a constituent α (whether Probe or Goal) is *active* only if α contains one or more *uninterpretable* features. That is why uninterpretable features are viewed by chain as being at the core of the system. More precisely, the presence of uninterpretable features on a constituent makes it active and hence able to serve as a probe or goal and play a

part in feature copying feature, valuation and feature deletion (Radford 2004: 218-249):

(21) Feature copying (Radford, 2004:222) if α is valued for some feature [F] and β is unvalued for [F] and if β agrees with α , the feature-valued for [F] on *alpha* is copied onto *beta*

(22) Feature visibility convention (Radford 2004:225)

Any uninterpretable feature deleted in the syntax is invisible to the semantic component, but remains visible in the syntactic component and in the PF component.

(23) Feature Deletion (Radford 2004:225)

A \emptyset -complete α deletes any uninterpretable person/number/case feature(s) carried by a matching β .

The theoretical put in place, let us reconsider the Tuki sentence *ane odzu Mbara a-ma-dinga* < ane > “who did Mbara love?” *Ane* “who” is endowed with the features [3 Pers], [Sg Num]. *Ane* can serve as a probe because it is the highest head in the structure and it is active by virtue of its uninterpretable phi-features. The focus marker (Foc), *odzu*, carries the features [u-Pers] and [u-Num] *odzu* can serve as goal for *ane* because of its uninterpretable phi-features. The features of *odzu* are unvalued at this point because they are going to be valued via agreement with *ane*. So *odzu* enters the derivation carrying the features [u-Pers, u Num]

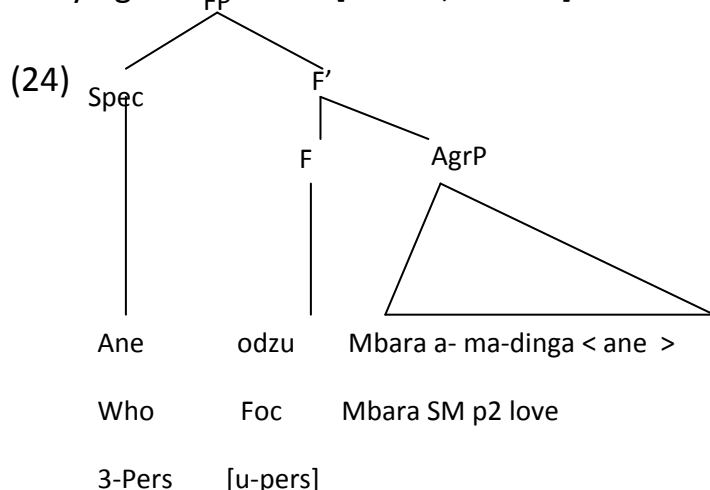

Feature copying can now apply to value the unvalued phi-features on *odzu* as third-person singular (via agreement with *ane*):

(25)

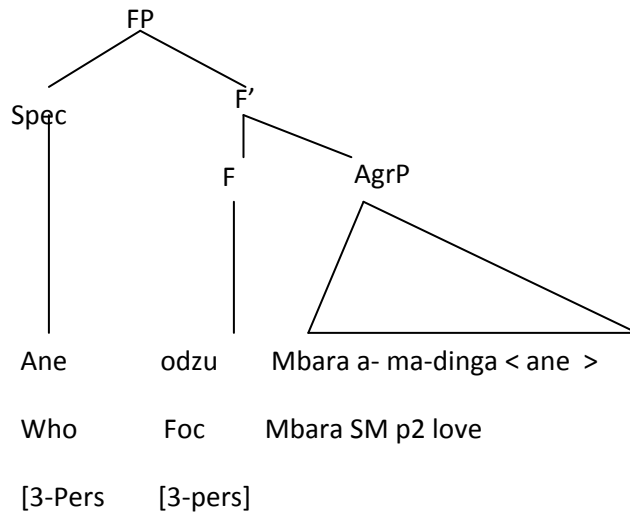

Feature Deletion can apply to delete the uninterpretable phi-features of *odzu* (in the following tree representation). The operator *ane* “who” behaving like a nominal, its, person/number features enter the derivation

(26)

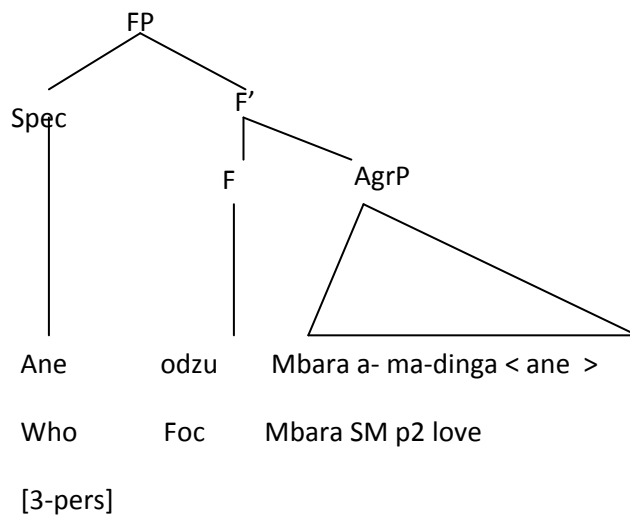

In summary, Probe and Goal being active, Agree has applied between *ane* and *odzu*. As expected all unvalued features have been valued and all uninterpreted features deleted.

In the next section, we turn to the issue of clause structure. More specifically, given the observations made in the previous sections, what is the sentential structure of Tuki wh-questions?

1.5. Wh-questions *and* clause structure

Up to now, we have argued that:

- (i) Focus sentences have the linear structure XP Focus word IP.
- (ii) Wh-questions are formed Wh-XP (Focus word) IP, when movement occurs in the syntax.
- (iii) Embedded questions are formed that WH (Focus word) IP.
- (iv) The choice of the moved wh-element determines the choice of the focus word, indicating that an agreement relation holds between them.

Taking (i-iv) into account, the structure of questions in Tuki would appear to be:

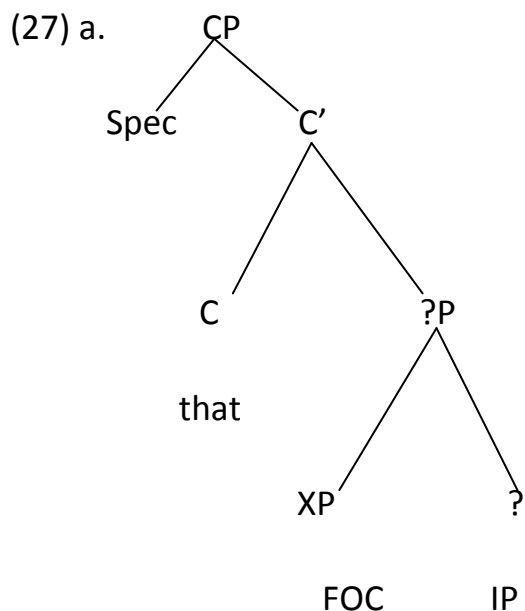

We need to specify right away the exact status of ?P, ?P being the projection of a (covert) focus word, is reasonably analyzed as a F(ocus) P(hrase).

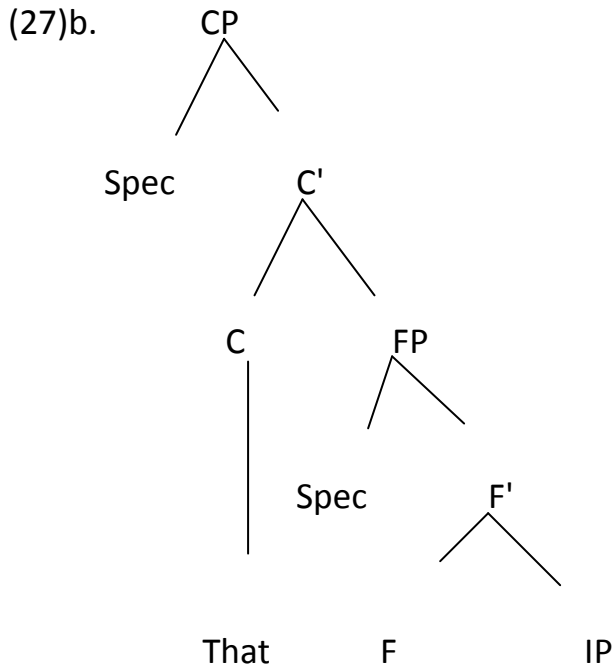

The above structure makes the explicit claim that wh-movement in Tuki is substitution to a headed constituent focus phrase. To corroborate its validity, it may be useful to demonstrate that Move alpha in this language cannot possibly be an adjunction operation. Consider the fact that only one wh-element can be fronted in Tuki:

(28) a. Mbara a- sesam [ee Puta a- fam ane ate]]

Mbara SM asks that Puta SM gives who what

‘Mbara asks that Puta gives who what’

b. Mbara a- sesam [ee [ane [Puta a- fam ate]]]

Mbara SM asks that who Puta SM gives what

‘Mbara asks who Puta gives what?’

c. Mbara a- sesam [ee [ate [Puta a- fam ane]]]

Mbara SM asks that what Puta SM gives who]]]

‘Mbara asks what Puta gives who’

d. *Mbara a-sesam [ee [ate_j [ane_i [Puta a- fam x_i x_j]]]]

‘Mbara SM asks [that [what_j [who_i [Putā gives x_i x_j]]]]

e. *Mbara a- sesam [ee [ane_i [ate_j [Putā a- fam x_i x_j]]]

‘Mbara asks [that [who_i [what_j [Putā gives x_i x_j]]]]’

So only one wh-word can be moved to clause initial position. This result does not follow from the theory of adjunction, which basically licenses multiple adjunction. It is reported, for instance, by Rudin (1988) that Polish and Serbo-Croatian among other languages allow multiple adjunction of wh-phrases (to IP).

This state of affairs constitutes evidence that Move alpha in Tuki is not adjunction but substitution. It should be noted that English topicalisation, under the adjunction analysis, does not allow multiple adjunction either (Hoji (p.c;)). Moreover, the impossibility in Tuki of more than one element moving to pre-FOC position is not limited to wh-phrases only, it covers focus constructions in general. This observation mirrors the parallelism between wh-questions and focus constructions.

Having drawn the conclusion that Move alpha in Tuki is substitution, what is the structural representation of the questions exhibited in the preceding sections (some of which are repeated below for ease of exposition)?

(29) ane odzu Mbara a- dingam

who FOC Mbara SM loves

‘who does Mbara love’

(30) a. Mbara a- sesam [ee [ate [aye [Putā a- ma kusa]]]]

Mbara SM asks that what FOC Putā SM p2 buy

‘Mbara asks what Puta bought’

b. Mbara a- kambim [ee [owate [owu [Puta a- nobam aneme]]]]

Mbara SM astonish that why FOC Puta SM beats husband

‘Mbara wonders why Puta beats her husband’

Analysing the above Tuki wh-questions as movement into headed constituent focus phrases, we obtain the following structured construction:

(31) [_{FP}[_{Spec} ane [_F' [_F odzu [_{IP} Mbara a- dingam]]]]

(32)a. Mbara a- sesam [_{CP} ee [_{FP} [_{Spec} ate [_F' [_F aye [_{IP} Puta a- ma- kusa]]]]]]]]

b. Mbara a-kambim [_{CP} ee [_{FP} [_{Spec} owate [_F' [_F owu [_{IP} Puta a- nobam-aneme]]]]]]]]

In sum, so far we have argued that there is a phrasal constituent (FP) between CP and IP in Tuki.

1.6 Origin of the Focus Marker

We have indicated that the focus marker that agrees with extracted wh-phrases occurs only when there has been syntactic movement (as illustrated in the following paradigm (33) below, repeated here for convenience):

(33) a. ane odzu Puta a- nu- banam

Who FOC Puta SM f1 marry

‘Who will Puta wed?’

b. ate aye Puta a- ma- namba

what FOC Puta SM P2 cook

‘What did puta cook?’

c. ni owu Puta O- endam n(a) adongo

When FOC Puta SM goes to village

‘When does Puta go to the village?’

d. Owate owu Puta a- m(a)- iba moni

why FOC Puta SM P2 steal money

‘Why did Puta steal the money?’

In this section, we will attempt to account for the origin of the focus marker when extraction occurs. We will assume that the focus word is an overt realisation of an (Abstract) F morpheme similar to Chomsky’s (1988/1991) assumption about the presence of a Q morpheme in English interrogatives. Thus, the focus word is base-generated in the head position of FP bearing agreement features as the result of Spec-head coindexation with the focussed phrase in the specifier position. Other languages which have syntactic focus-movement, there seem to corroborate the position that the focus word is base-generated in FP. In languages which have syntactic focus-movement, there seems to be requirement that the head position of FP (that is F) be filled obligatorily if the specifier position is occupied by a focus phrase. In Hungarian and modern Greek, it is the verbal head that moves to F while in Berber it is a complementizer *ay-* that occupies the F position and attracts the verb to it due to its affixal nature. Given that in Tuki there is an independent element which is used as a focus word, it would seem only natural to base-generate it under the F category as an overt manifestation of the F morpheme.

1.7 Wh-questions as Focus Constructions

The similarities between focus sentences and wh-questions strongly argue not only for a uniform account of the two construction types but also for a semantic relation between them. The semantic relation between wh-questions and focussing constructions has been discussed in the literature (see for instance Myers (1971), Heny (1971) and Rochemont (1986); for a discussion of the relation between focus and relativisation see Schachter (1971) and Takizala (1972). Takizala argues that a wh-question involves the same presuppositional structure as a focusing construction. Compare, for example, sentences (34) (focus) and (35) (wh-question) below (Takizala's (79) and (80)):

(34) It was/wasn't Kipese that bought a chair = Presupposed 'Someone bought a chair'

Asserted: 'That person is Kipese'

(35) Who bought a chair? = Presupposed 'Someone bought a chair'

Querried 'That person is who?'

The semantic structure seems to be the same although the performative involved is different in both constructions (declare for focus, request for a wh-question). The Tuki and Duala facts lend considerable support to the above analysis. Several proposals have been put forward in order to formalize the semantic connection between wh-questions and focusing constructions (Whitney (1984), Culicover and Wilkins (1984), Horvath (1986), Rochemont (1986), Rochemont and Culicover (1990). We will briefly review some of these proposals and choose the one that aptly accounts for the material discussed here.

Whitney (1984) argues that all constructions involving movement to an A-bar position should be analyzed as obligatory focusing constructions in terms of her A-bar Focus principle (Whitney (1984, 191)):

(36) A-bar Focus principle

If Alpha results from adjunction to an A-bar position, then alpha is necessary focused.

Whitney's analysis could not easily accommodate the Tuki data on wh-questions and cleft constructions, since the relevant Tuki constructions do not involve adjunction.

Culicover and Wilkins (1984) and Rochemont (1986) indicate that the focus effect is associated with the occurrence or raising of a phrase in a universally identified focus host in the clause. This focus host is a VP adjoined position. Rochemont (1986) proposed the Cleft Focus Principle:

(37) Cleft Focus Principle

In the S-structure [V...a...V...a...], where:

- (i) one occurrence of a = e,
- (ii) V governs a, and
- (iii) a is not theta-marked by V (V = be), a is a contrastive Focus

Since Tuki wh-questions and cleft constructions are not cases of adjunction to VP, we suggest that the configuration proposed above is inadequate.

Following Rochemont (1986) who suggests that a cleft focused phrase appears at S-structure in a subcategorized position but is not theta-marked in

that position by the governing head, Rochemont and Culicover (1990) propose the Focus principle:

(38) The Focus principle

a is a structural focus if

(i) a = NP, CP, PP

(ii) there is a B = X₀ such that B canonically governs a and a is neither case-marked nor theta-marked by B.

(iii) B is not excluded by any t, t = xⁱⁱⁱ, that dominates a.

By 'structural focus', the authors mean 'a focused phrase that is identified as a focus by virtue of its appearing in a specific position in a given construction...' 'Canonical government' refers to the canonical government configuration of Kayne (1983).

Recall that in Tuki wh-questions and cleft constructions, the foci occur in clause initial position where they are governed by FOC but not canonically. The Tuki data thus pose a problem for (31 ii) and the Focus Principle. According to Horvath (1986), FOCUS is a syntactic feature assigned under adjacency. She defines FOCUS as follows:

(39) In a configuration [...α...β...] or [...β ... α ...], α is x⁰, α assigns a syntactic feature gamma] to β if:

(a) α governs β and

(b) α and β are adjacent

In (39), β would be assigned FOCUS by α, much in the same way as FOC assigns FOCUS to wh-items in Tuki. Let us assume that, in order to be

interpreted as a non-echo question, a wh-question word must receive the feature FOCUS at the appropriate level of representation, call it [+ gamma] from either Infl or V (see Kinyalolo 1991 for the same line of reasoning):

(40) A wh-phrase must be gamma-marked by a phonetically realized head. In view of (40), consider the following Tuki question and its tree structure representation:

(41) a. Ate aye Puta a- ma- kutu- namba

What FOC Puta SM P2 Prog cook

'What was Puta cooking?'

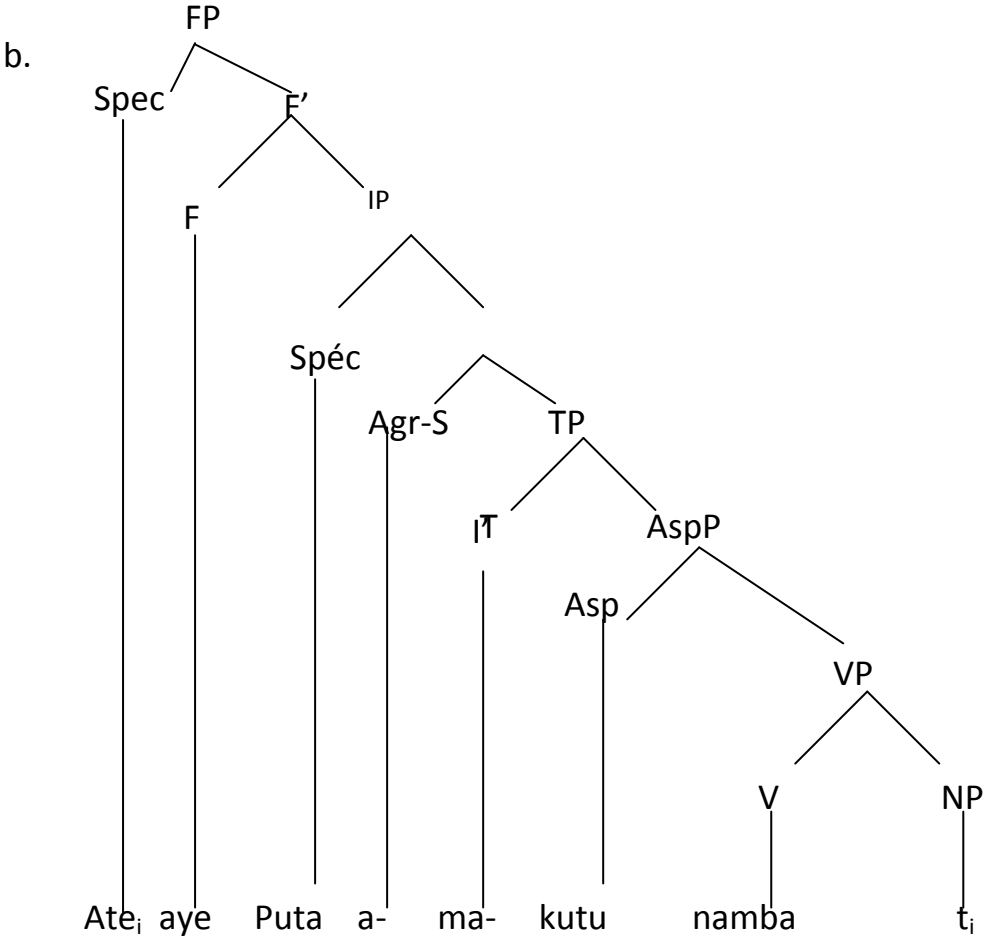

In (41b) the focus word *aye* is the head that gamma-marks the *wh*-item *ate*. We can account for the occurrence of a focus word in (41) by stating that an agreeing focus word in F of FP assigns the feature FOCUS to Spec of FP (under government and adjacency).

But notice that the focus word is optional in Tuki *wh*-questions. Thus (41a) could be rendered as:

(42) *ate Puta a- ma- kutu- namba*

What Puta SM p2 prog cook

‘What was Puta cooking?’

The optionality of the focus word in Tuki *wh*-questions entails that an overt FOCUS assigner does not have to be phonetically realized. If it proves to be true that some sort of vacuous agreement obtains between an empty head and an extracted *wh*-phrase in Tuki, then we have to reformulate (40) as follows:

(43) A *wh*-phrase must be gamma-marked by an agreeing head.

(44) captures the idea that although SPEC-Head agreement is compulsory in *wh*-questions, an agreeing head does not have to be overtly realized (we elaborate more on this matter below).

Unlike the situation that obtains in Tuki *wh*-questions, the presence of the focus word is compulsory in cleft constructions. Thus in the following sentences, the focus words may not be omitted (if the sentence has to be interpreted as a cleft construction):

(45) a. *Puta odzu Isomo a- fu- nobam*

Puta FOC Isomo SM hab beat

'It is Puta that Isomo usually beats'

b. Nama adze Puta a- fu- nyam

animal FOC Puta SM hab eat

'It is an animal that Puta usually eats'.

Notice that SPEC-Head agreement obtains between the focused NPs (Puta class 1) and *nama* (class 10) and the focus words (*odzu* and *adze*). Now why is the focus word optional in Tuki wh-questions and required in cleft constructions? It could be conjectured that a wh-question is by definition a focus construction, thus irrespective of whether there is a FOCUS assigner or not, a wh-item in a wh-question will be interpreted as the focus of the construction. The same reasoning does not apply to ordinary NPs. In the sentences exhibited in (46), should the focus words be dropped, the sentences would be interpreted as topicalized constructions:

(47) a. Puta Isomo a- fu- nobam

Puta Isomo SM hab beat

'Puta Isomo usually beats'

b. Nama Puta a- fu- nyam

animal Puta SM hab eat

'An animal Puta usually eats'

In order to account for the adjacency requirement between the verb and the focus/wh-phrase in the relevant Hungarian constructions, Brody (1990) suggested that the feature [+f] be assigned to Spec of FP. As far as Tuki is

concerned, although the presence of a focus word in the case of preposed wh-phrases is optional, we have assumed that wh-phrases in Tuki are inherently [+f], thus the presence of a focus word is not required. In the case of [+f, – wh] – phrases, however, [+f] assignment is obligatory, hence the obligatory presence of the focus word.

Apart from the fact that the focus word may not be omitted from cleft constructions while it may in wh-questions, there are other differences between these two constructions. A number of syntacticians (cf Heggie (1988), Radford (1988)) among others assume that cleft sentences have the following schematic form:

(48) [it be XP CP]

Thus, the following English sentences are typical cleft sentences:

(49) a. It is Bob [who Betty loves]

b. It is Bob [that Betty loves]

c. It is Bob [O Betty loves]

It is fairly obvious that English cleft sentences differ from English questions such as (41):

(50) who does Betty love?

(51) has the following schematic structure:

(52) [CP IP]

(48) and (52) differ in that the copula is conspicuously missing in the latter structure. But the copula may not be the real culprit for the ungrammaticality of the following sentence:

(53) *it is who (that) Betty loves?

The illicitness of (53) may be accounted for by two facts:

a) *wh*-in-situ elements are not licensed in English, except in echo questions and multiple interrogation; b) inversion is normal in *wh*-questions except when the subject is questioned. In (53), *who* is not in situ per se, but in effect it occurs in situ inside the predicate. The validity of this reasoning is supported by the following sentence:

(54) who is it ---that Betty loves?

Notice that in (54) **who** has moved from the post-predicate position to the clause-initial position, triggering inversion in the process. Thus, partial movement of *who* and absence of subject-verb inversion help explain the ungrammaticality of (53).

In sum, although *wh*-questions and cleft constructions share the same presupposition structure, they do not have the same sentential structure in English. One may expect to find a language in which both *wh*-questions and cleft constructions share the same presuppositional structure as well as the same sentential structure. Tuki seems to be the language in point. Consider the following sentences:

(55)

a. i-mu Viroo odzu Ndjimi a- dingam

It-is Viroo FOC Ndjimi SM loves

'It is Viroo that Ndjimi loves'

b. i-mu ane odzu Ndjimi a- dingam

It-is who FOC Ndjimi SM loves

'Its is who that Ndjimi loves'

In (a), the direct object NP *Viroo* has been focussed; whereas in (b) it is the wh-element *ane* 'who' that has been focussed. Notice that (55b) is the exact equivalent of the English (53), and unlike the latter sentence, (55b) is grammatical. It seems to be the case that both (55a) and (55b) have the same sentential structure:

(56) [i-mu XP CP IP]

More precisely, the two sentences are structured as follows:

(57)

a. [i- mu_{[FP[Spec Viroo [F' [F odzu [CP O [IP Ndjimi a- dingam]]]]]]]]]}

b. [i- mu [FP[Spec ane [F' [F odzu [CP O [IP Ndjimi a-dingam]]]]]]]]

Why do we postulate the existence of a CP node above? In some dialects of Tuki, although the construction is somewhat marginal, it is possible to have the lexical complementizer *ee* 'that' in these sentences:

(58)

a.i-mu Viroo odzu ee Ndjimi a- dingam

b i-mu ane odzu ee Ndjimi a- dingam

(We will further discuss *ee* 'that' in the next section with respect to relativization). Interestingly enough, the copula *i-ma* 'it is' can be dropped

freely in the above cleft constructions. Thus the two sentences in (45) can be rendered as:

(59) a. Viroo odzu Ndjimi a- dingam

Viroo FOC Ndjimi SM loves

'It is Viroo that Ndjimi loves'

b. Ane odzu Ndjimi a- dingam

Who FOC Ndjimi SM loves

a. 'It is who that Ndjimi loves?'

b. 'Who does Ndjimi love?'

Notice that (59b) is ambiguous between a cleft construction in which a *wh*-word has been focussed and a simple content *wh*-question. This ambiguity stems from the fact that in questions *wh*-items are always focussed, much in the same way as ordinary NPs are focussed in cleft constructions. The semantic parallelism between cleft and *wh*-questions is mirrored by the morphological as well as syntactic parallelism. Meaning put aside, (59a) and (59b) seem to share the same sentential structure, providing thereby *prima facie* evidence that cleft constructions and content *wh*-questions are virtually similar in this language.

A question of theoretical relevance is: why does the copula seem to drop freely in cleft constructions and *wh*-constructions? It seems to be the case that the overt manifestation of agreement in this language has something to do with it. In the following cleft constructions, the focus word agrees in noun class with the focussed NP, the parentheses indicate that the copula is optional:

(60)

a. (i-mu) Dima odzu Puta a- dingam

it-is Dima FOC Puta SM loves

'It is Dima that Puta loves'

b. (i-mu) cwi adze Puta a-nambam

fish FOC Puta SM cooks

'It is fish that Puta cooks'

c. (i-mu) inwii idzii Puta a-mu- bono na kiisini

some FOC Puta SM p1 run away in kitchen

'It is smoke that Puta ran away from in the kitchen'

d. (i-mu) manya ama mbwa i-nyam

Food FOC dog SM eats

'It the food that the dog eats'

e. (i-ma-dzii) yendze aye Dima a- ma- kutu-fowa

P2 be house FOC Dima SM P2 prog. build

'It was a house that Dima was building'

In the above paradigm, the focussed NP obligatorily agrees with the focus (FOC) word. And incidentally, the copula can be dropped. This suggests that the focus (FOC) word alone can help the speaker determine that the construction is a cleft. In a sense, the presence of the agreeing focus word helps recover the deletion of the copula. This line of reasoning makes the prediction that in a language that does not exhibit overt agreement between the focused NP and a focus word (if any), the copula may not be dropped. The prediction is borne out in English:

(61)

a. it is John (that/0) Betty loves

b. It's a porsche (that/0) Mary bought

It is may not be omitted in (61) above because if it were, there would be no way of determining that the construction is a cleft. Our account of why the copula drop in clefts seem to be a functional rather than a syntactic explanation. However, it is not an ad hoc explanation in view of the fact that it has been claimed by many linguists that overt (rich) agreement licenses the dropping of the pronominal subjects in some languages (Rizzi 1982), Jaeggli (1982), Jaeggli and Safir (1989) among others). Thus, since Tuki has rich agreement, it seems natural to claim that the copula can be dropped in this language because AGR can help recover the content of the copula. Now, if this reasoning is true, why does the copula drop in wh-clefts (even when the FOC position is empty?) One could argue that even when AGR is not overtly manifested in FOC, its optionality may be a sufficient clue that the construction is a cleft. One has to recognize, however, that this line of reasoning is stipulative. In the next section, after we analyse relative clause formation in Tuki, it will be argued that relativization differs from cleft formation although both constructions look alike in some respects.

2.The Force Phrase (ForceP) in Tuki

It was established above on the basis of Biloa (1992, 1995) that there is a phrasal projection between CP and IP, called F(ocus) P(hrase) in Tuki. The description and analysis of Greek, Hungarian and Arabic by Agouraki (1990), Brody (1990), Tsimpli (1990) and Ouhalla (1992) led these researchers to the same conclusion.

Rizzi (1997, 2001b, 2003) suggests that CP should make way for a number of different projections: this analysis has come to be known as **the split CP hypothesis**. Rizzi indicates precisely that complementizers should be analyzed as Force markers heading a ForceP (=Force Phrase) Projection because complementizers contribute in specifying whether a clause is declarative, interrogative, imperative, exclamative, relative or comparative in force. In other words, the ForceP projection encodes the illocutionary force of a given sentence, e.g. interrogative or declarative. Rizzi also claims that focused constituents should be analysed as contained within a separate FOC (= Focus) Phrase headed by a Foc constituent (= Focus marker).

As for the existence of a Force phrase as far as the Tuki language is concerned, consider the following. Above, it was argued that Tuki has a lexical complementizer *ee* “that” that appears in pre-IP of clause introduced by verbs such as *wudza* “tell, say”, *Obungana* “think, believe”, *osesa* “ask”, *widzima* “know” The presence of *ee* is compulsory in the constructions illustrated above in (12 a-b) and repeated below:

(62) (Bilola 1995:54)

a. Mbara a- m(u) – udza *(ee) Puta a- mu- namba cwi

Mbara SM P1 say that Puta SM f1 cook fish

‘Mbara said that Puta would cook fish’

b. iyere a- dingam *(ee) vadzu va sukuru vaa va-yere

teacher SM loves that children of school his SM teach/learn

‘The teacher wants his students to study’

Given Rizzi's proposal, the sentence (12a) would have the tree structure shown below

(62) a'.

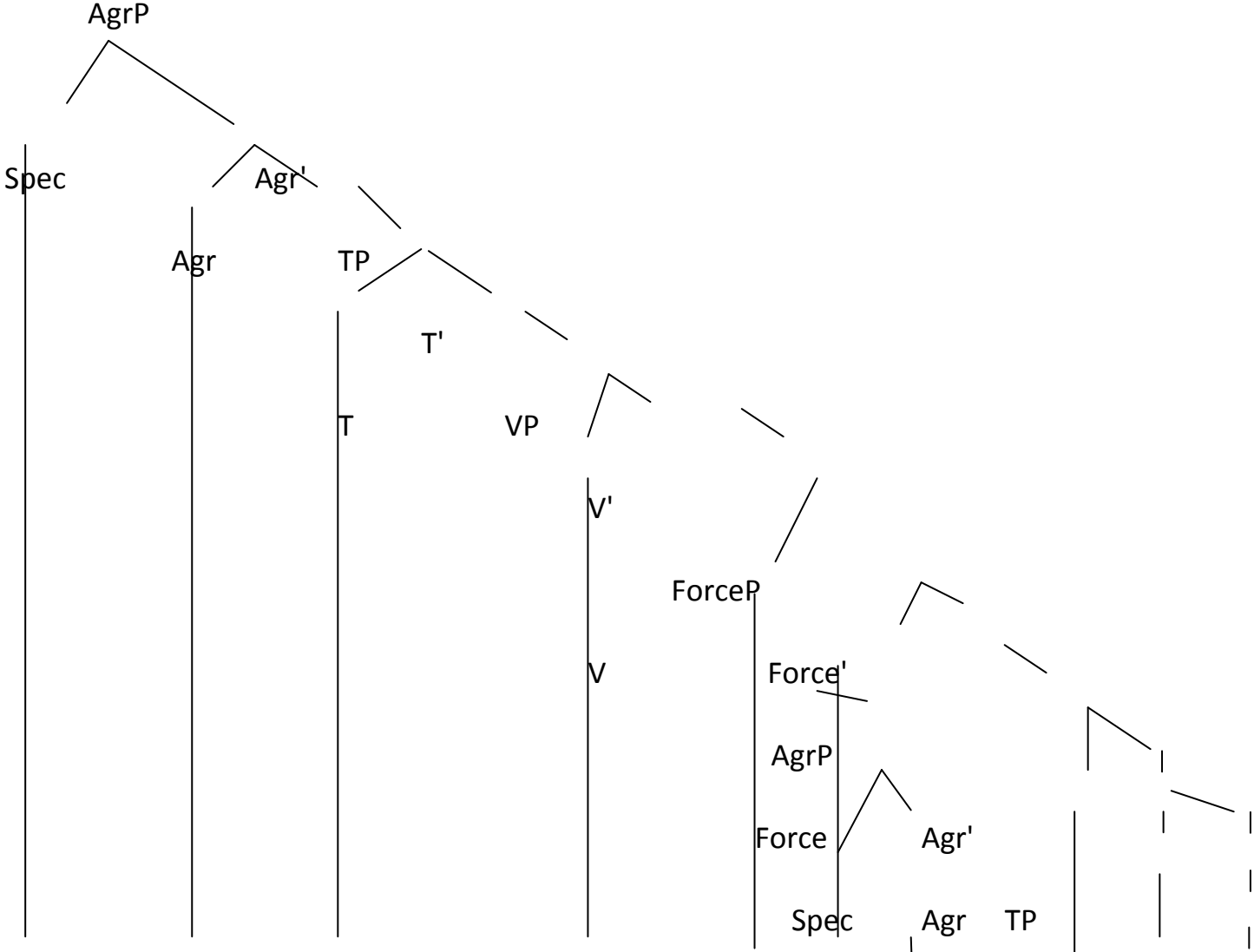

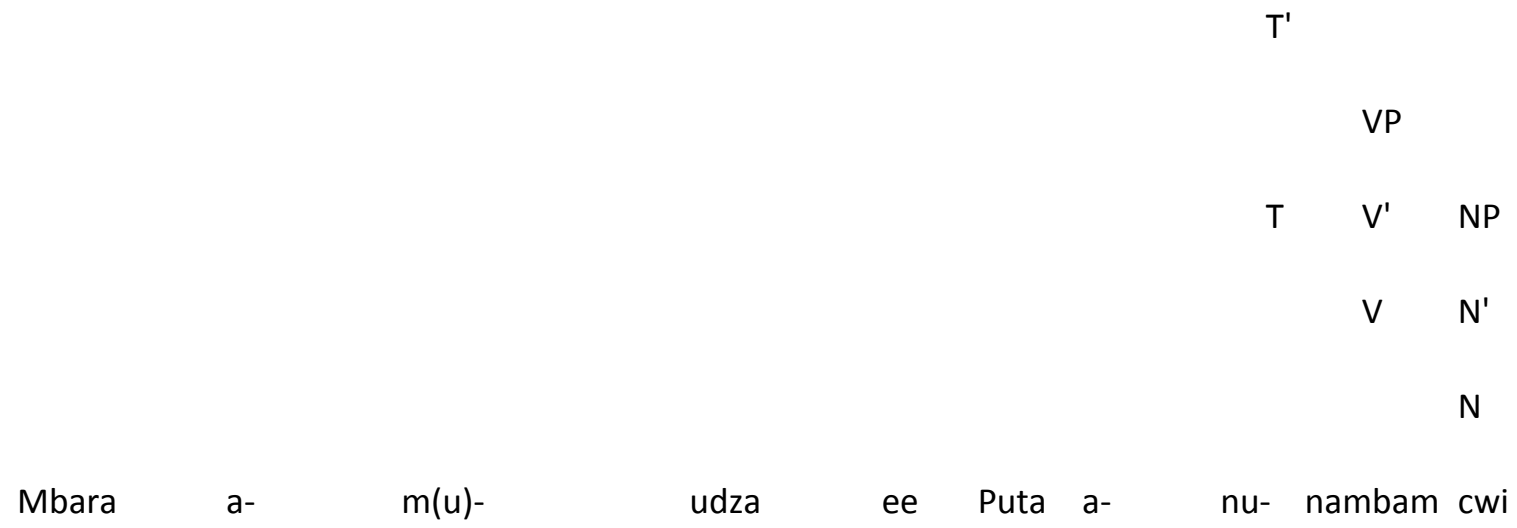

In (62 a'), the head of ForceP is occupied by the lexical complementizer ee "that"

Above, it was shown that Tuki indirect questions are introduced by the lexical complementizer ee "that":

(63) (Bilola 1995:54)

a. Mbara a- sesam [ee [ane [odzu [Putā a- m(a) –ena]]]]

Mbara SM asks that who FOC Putā SM p2 see

'Mbara asks who Putā saw'

b. Mbara a- sesam [ee [ate [aye [Putā a- mu- kusa]]]]

Mbara SM asks that what FOC Putā SM P1 buy

'Mbara asks what Putā bought'

c. Mbara a- sesam [ee [ni [owu [Putā a- nu- fowam yendze yaa]]]]

Mbara SM asks that when FOC Putā SM F1 build house her

'Mbara asks when Putā will build her house'

d. Mbara a- sesam [ee [owate [owu [Putā a- nobam mwana waa]]]]

Mbara SM asks that why FOC Putā SM beats child her

'Mbara asks why Putā beats her child'

The bracketed complement clause in (63a) would have the following tree representation:

(64)

ForceP

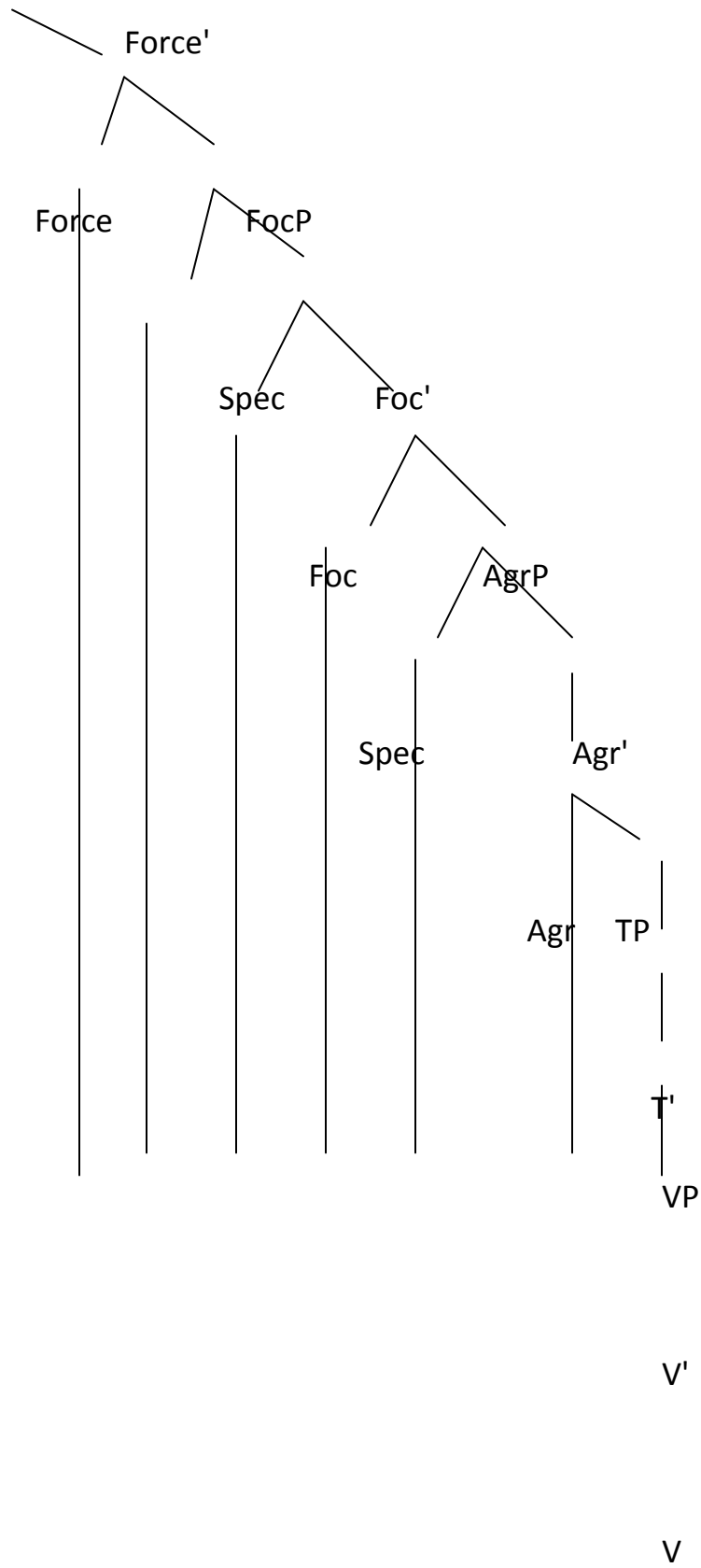

ee ane odzu Puta a- m(a)- ena

Having established that the lexical complementizer *ee* “that” occupies the head of the Force phrase, [Force, ForceP], the question arises as to whether the position [Spec, ForceP] can be occupied. If yes, what element(s) can occupy it? To provide answers to these questions, consider the behaviour of relativization in this language.

3. Relativization

It was argued in a previous section that the landing site for question formation in Tuki (and Duala) is the specifier position of a headed constituent focus phrase (FP). It would be very interesting to see what the landing site of a movement process such as relativization is. In this section, we turn to that task. First, we show positions that can be relativized in Tuki.

3.1. Accessibility Hierarchy

Keenan and Comrie (1977) proposed a crosslinguistically valid hierarchy with respect to relativization:

Subject Direct object Indirect object of Pre- or postposition Possessor. It seems to be the case that the Accessibility Hierarchy proposed by Keenan and Comrie is not falsified in Tuki since all positions can be relativized:

(65) a. Subject

Okutu odzu a- nyam kuru a- mu ongubi

Woman who SM eats rat SM is thief

'the woman who eats rat is a thief'

b. Object

mbwa adze Kunu a- mu- kusa i- mu puu

dog that Kunu SM p1 buy SM is white

'the dog that kunu bought is white'

c. Indirect object

mangazu odzu n- dzaram na a a- mu mwana nkunkuma

child that SM talk to res. pro. is son chief

'the child that I talk to is the chief's son'

d. Possessor

Okutu ame odzu tsono raa ongubi a- m- iba a- kutu- banga

Woman my whom clothes her thief SM p2 steal SM prog. cry

'My wife, whose clothes the thief stole, was crying'

3.2. Relativization and Bounding theory

First, it is necessary to see whether Tuki relative clause formation is an instance of Move Alpha. We will argue that relativization in this language moves wh-items to some position (to be determined later). Consider the following sentences:

(66)

a. Mutu odzu; Nu nga- m(a-) uba ee Puta a- ma- bana x; a- ma- gwa

man who I SM P2 hear that Puta SM p2 marry SM P2 die

‘the man who I heard that Puta married died’

b. *fumu owu tane_i Nu nga- m(a-) uba maru ama ee Puta a-

place this where I SM p2 hear story this that Puta SM

ma- bana aneme waa x_i o -mu kabenebe

p2 marry husband her SM is far

‘the place where I heard the story that Puta married her husband is far away’

c. mangadzu okutu odzu odzu_i Isomo a- bunganam ee Dima i-

Child woman this who Isomo SM thinks that Dima SM

dzimam wusi ee isa waa a- nu- gwanam x_i na yendze

Knows well that father her SM f1 chase in house

‘This is the girl whom Isomo thinks that Dima knows for sure that her father will kick out of the house’

d. *nambari owu ni_i Isomo a- bunganam ee Dima i-dzimam

tomorrow this when Isomo SM thinks that Dima SM knows

maru ama ee visimbi vi- nu- umbanam viibi x_i

story this that police SM f1 catch thieves

‘This is tomorrow when Isomo thinks that Dima knows the story

that the police will arrest the thieves’

Sentences (66a) and (66b,c) constitute evidence that relativization in this language is an unbounded process since the relativized constituents have raised over several clauses, thereby apparently transgressing the Specified Subject Condition (SSC) and the Nominative Island condition (NIC). However, the Examples (66b) and (66d) are illicit. Notice that the latter sentences are in violation of the Complex Noun Phrase Constraint (CNPC) and thus prove that relative clauses in this language obey subjacency¹.

Bear in mind, though, that Tuki exhibits relative clause constructions and other *wh*-movement structures which seem to violate Bounding Theory due to the presence of resumptive pronouns. In Biloa (1990), I show facts that confirm the movement analysis of Tuki relativization. More precisely, it is argued that in cases of pied piping and extraction of adjuncts over relatives, the subjacency condition is always violated. Moreover, relativization over islands in those cases is also strictly disallowed, providing thereby *prima facie* evidence that Tuki relativization involves movement.

3.3 The landing site of relativization

¹ References to NIC, SSC, CNPC etc., will occur throughout the book, and while they feel dated they are very important descriptive tools. In a sense, they represent the shift of focus from rules to principles in the formulation of general constraints on transformations. Since Ross (1967), syntactic analyses aimed at discovering rules characterizing constructions and generalizations. Among the generalizations that survived the passing of time are the Complex Noun phrase Constraints, the *Wh*-island Constraint and the notion of “islands”. Some of these generalizations were later unified under more abstract principles such as subjacency and opacity (the Tensed S condition, the Specified Subject Condition, the Nominative Island Condition) (among other references, see Chomsky 1973, 1976, 1980, 1986). The unification of these generalizations drove Linguistic theory toward abstract theorems and principles and steered it away from “data-driven sorts of generalizations across descriptive rules that characterized much of earlier research” (Safir 1985). However while there has been a complete shift from specific rules encoding constructions to general principles, the shadow of Ross’s earlier work still looms large over today’s scholarship. In *Barriers* (1986), Chomsky in his attempt to redefine subjacency constantly refers to the Subject Condition and the Adjunct Condition (page 31), the Complex Noun Phrase Condition (page 34), the *wh*-Island violations (page 38). Chomsky’s numerous references to these dated terms is a reflection of the fact that they are indispensable descriptive devices. In this paper, we will continue to use them whenever the need arises.

Since we have previously argued that extracted wh-phrases in Tuki content question formation land in Spec of FP, the null hypothesis would be that the same phenomenon obtains in relativization, much in the same way that CP in English hosts both wh-items of question formation and those of relativization.

The situation is not easy to sort in Tuki given the homophony that is sometimes observed both in wh-questions and relative clauses. Consider for instance the following three constructions:

(67) a. ane odzu Puta a- dingam?

Who FOC Puta SM loves

'who does Puta love?'

b. Mbara a- sesam [ee [ane odzu [Put a- dingam]]]

Mbara SM asks that who FOC Puta SM loves

'Mbara aks who Puta loves?'

c. Iyere odzu a- ma- tira karate a- nom

teacher FOC SM P2 write book SM sick

'The teacher who wrote a book is sick'

According to our analysis, wh-phrases move to the specifier of a focus phrase (FP). So (67a) and (67b) have the following phrase-markers (irrelevant details omitted):

(68)

a.

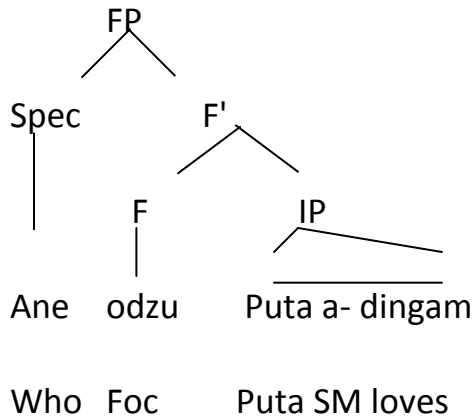

b.

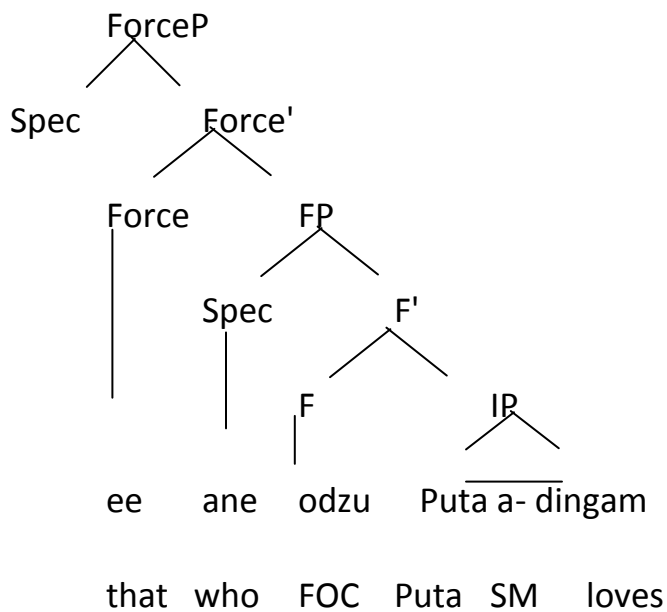

The CP position holds lexical complementizers (that) and yes-no question particles (whether, if).

Now what is the structure of (68c)? Notice that what could be termed in traditional grammar a relative pronoun (odzu) is homophonous with the head of FP (odzu) in (68). The homophony could reasonably be argued to constitute evidence that the landing site of wh-Movement applying in the Tuki relative

clause is the FP node, that is the FOC odzu in (a) and (b) and the so-called relative pronoun odzu in (57c) are one and the same element, namely FOC. Thus a sentence like (57c) would have the following phrase marker:

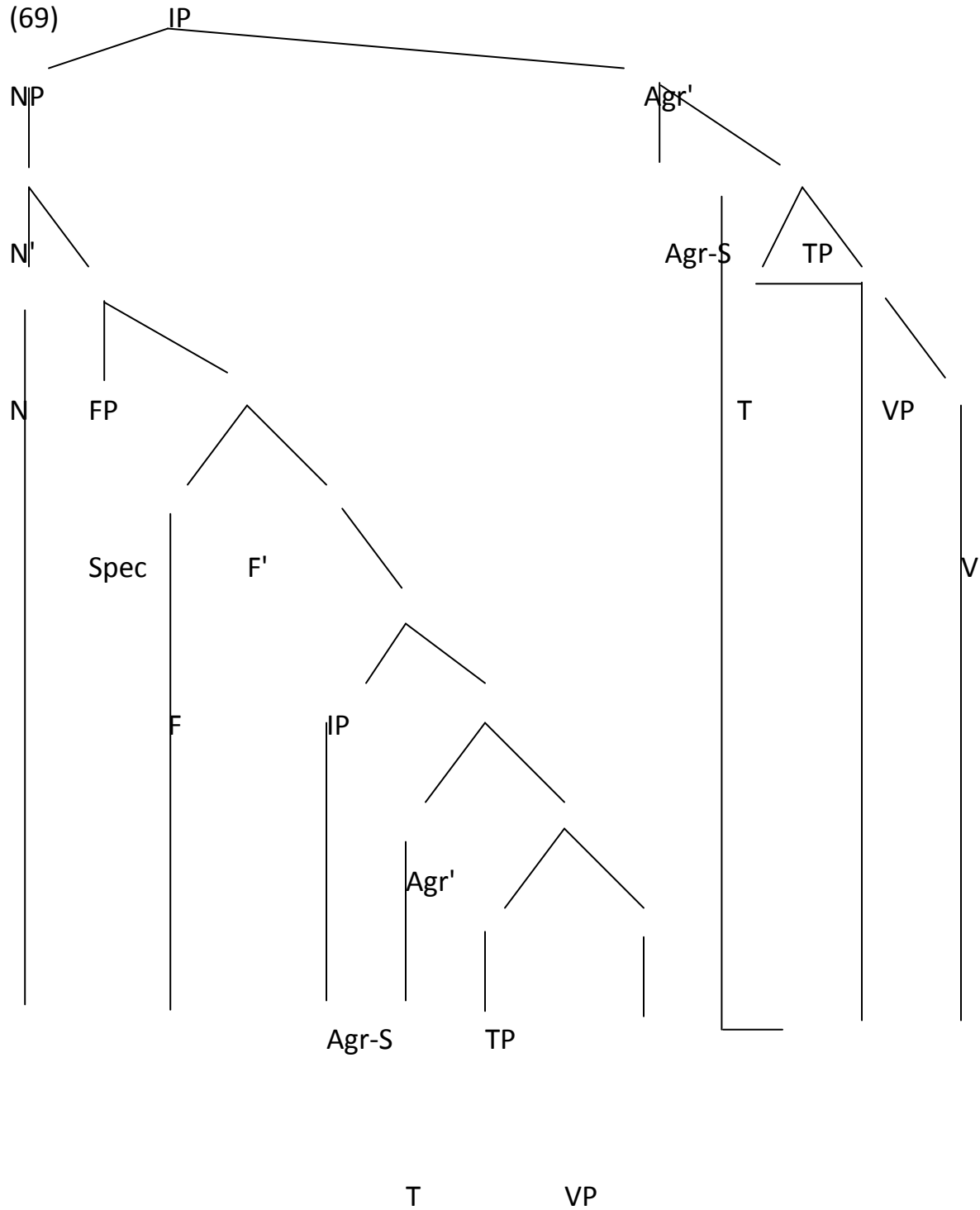

V NP

iyere odzu a- ma- tira karate a- o-
nom

Based on the morphological correspondence between the *odzu* found in relative clauses and that encountered in wh-questions:

(70)

a. Ane odzu Puta a- dingam

Who FOC Puta SM loves

'Who does Puta love?'

b. iyere odzu a- ma- tira karate a- nom

teacher FOC SM P2 write book SM sick

'The teacher who wrote a book is sick'

This would mean that relativization in Tuki involves the movement of a null operator to the specifier position of the Focus phrase. This null operator would agree with the element in F° , **odzu** above. Since Tuki is a noun class language, the two elements in FP (the specifier and the head F°) agree with the head Noun (which is the antecedent of the null operator). But there seems to be some reason (s) to believe that relative operators in Tuki occupy a position higher than the Focus phrase. Consider the following sentence:

(71)

iyere odzu mbwa adze i – ma – numa a- ma -gwa

teacher Agr -marker dog Foc SM P2 bite SM p2 die

“The teacher whom it is the dog that bite (him) died”

In this sentence, the relative empty operator, the antecedent of which is *teacher* agrees with *odzu*, precedes and dominates the focused NP *dog*. This seems to be prima facie evidence for Rizzi’s suggestion that “relative operators occupy the highest specifier position, the spec of Force”. That being the case, the phrase marker of the above sentence should be the following:

(72)

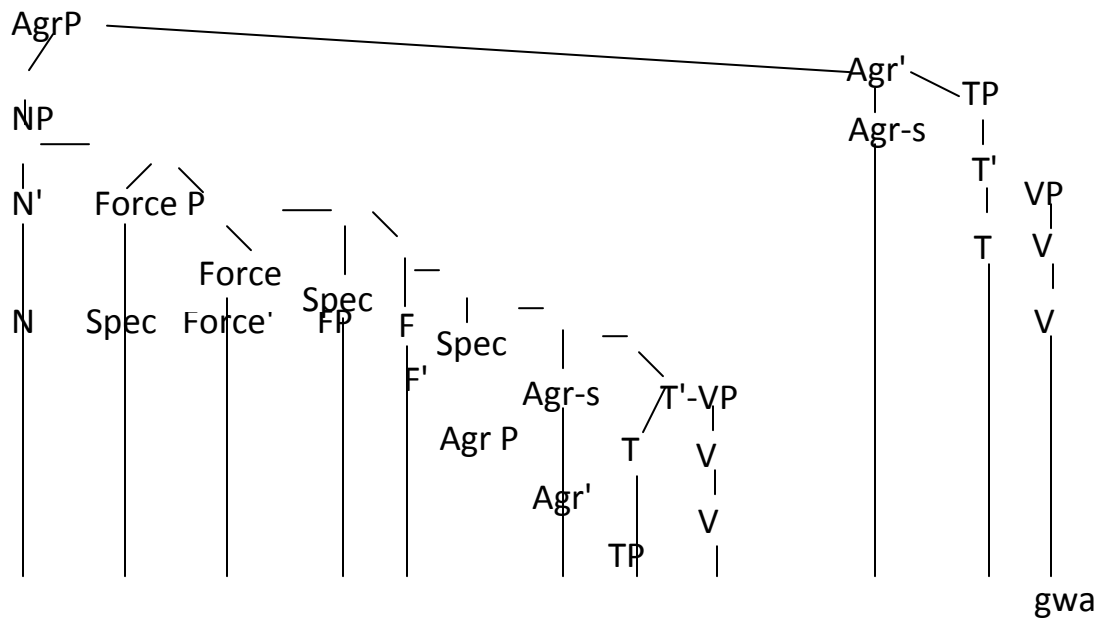

lyere DP odzu mbwa adze i- ma- numa a- ma

In the above phrase marker, the empty relative operator the antecedent of which is the head of NP, *iyere* “teacher”, occupies the specifier position of ForceP whereas the head of ForceP is occupied by the agreeing marker *odzu*. The ForceP position dominates the FP position whose specifier position hosts the focused NP *mbwa* “dog” and its head F contains the Foc marker *adze*. This tree representation shows that in this language ForceP precedes and dominates FP.

But more Tuki data seem to cast doubt on the validity of the above tree representation. Consider the following construction:

(73) mangadzu okutu [odzu [ee [Isomo a- ma- songo a

[child woman FOC that Isomo SM p2 make love to SM

timbam [bomo]]]]]

possess pregnancy

‘The girl whom Isomo made love to is pregnant’.

In the above construction, a lexical complementizer *ce* “that” surprisingly occurs after the agreeing relative marker *odzu*. Notice that the occurrence of the lexical complementizer in this position is not required. Thus the sentence below, (74), is semantically equivalent to (73) above:

(74) (Biloa 1995:75, (61))

mangadzu okutu [odzu [ee [Isomo a- ma- songo a

[a- child woman FOC that Isomo SM p2 make love to SM

timbam [bomo]]]]]

possess pregnancy

Moreover the lexical complementizer may appear after an agreeing relative word irrespective of the grammatical function borne by the category that is being relativized:

(75) (Bilola 1995:75, (62))

a. Nu nga – ma- baruma na mutu [odzu [(ee) [endam na adongo]]

I SM p2 meet with man FOC that goes to village

‘I met the man who is going to the village’.

b. Okutu ame [odzu [(ee) [tsono raa [ongubi a- m(a)- iba a kutu- banga

[woman my who that clothes her thief SM p2 steal SM progressive cry]]]]

‘My wife whose clothes were stolen by a thief is crying’.

What new structures could we assign the relative clauses exhibited above? Especially as there appears to be a conflict between **ee** and the agreeing relative word since both compete for the same position, namely [Force, ForceP]. Remember that it was argued above that the lexical complementizer **ee** “that” occupies the head of ForceP.

Assuming that indeed the head of ForceP should host the lexical complementizer, the Tuki data seem to suggest that a position higher than ForceP

should accommodate the null relative operator and the agreeing relative item. If that is the case, then Tuki relative clauses should be tree- represented as follows:

(76)

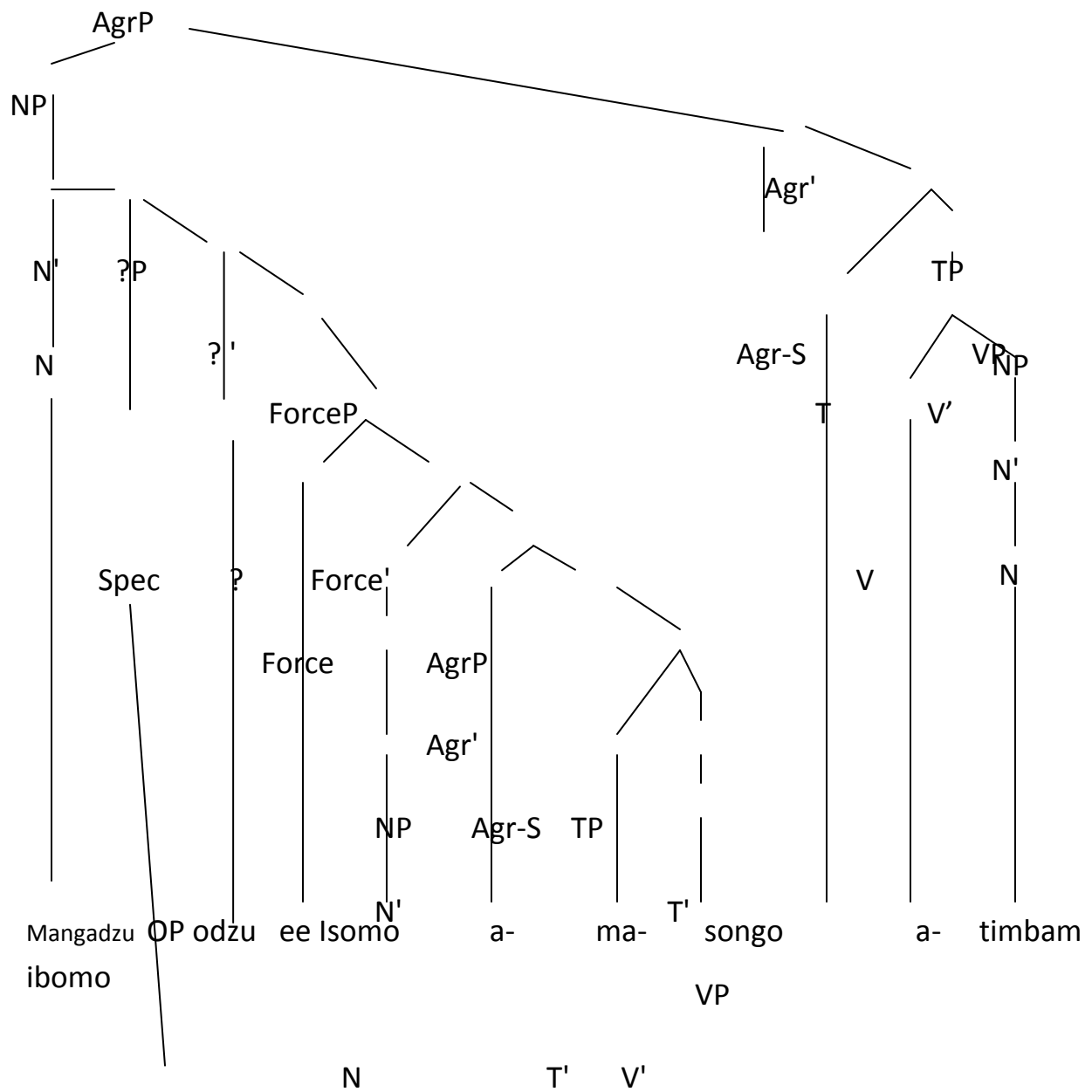

In the above phrase marker, the identity of the maximal projection that hosts the empty relative operator and the agreeing relative marker is not specified. The exact status of **?P** needs to be specified right away. **?P**, being the projection of an agreeing relative marker, can **reasonably** be analyzed as a Rel(ative) P(hrase). Why not? After all, Rizzi has proposed that CP be split into maximal projections such as Top(ic) P(hrase), Foc(us) P(hrase), Int(errogative) P(hrase)...

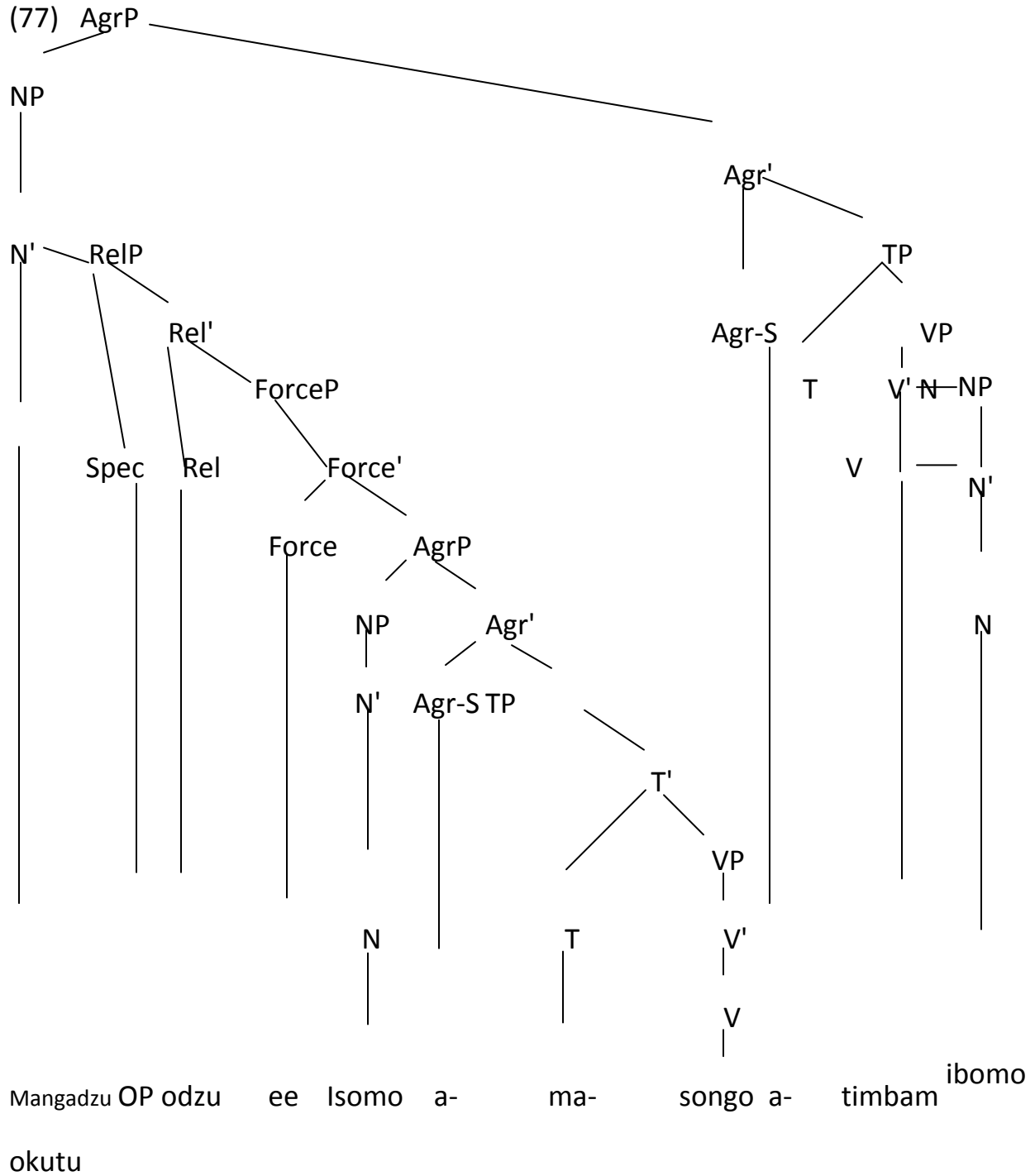

The tree representation proposed above in order to accommodate the Tuki empirical material seems not to offend any principle or condition of UG. Precisely, the standard X-bar Convention and the Structure Preserving Hypothesis are not

violated. Moreover, Baker's (1989) Head Licensing Condition (HLC) that essentially requires that every head be traced up to a (single) maximal projection is respected since the agreeing relative marker *odzu* heads the maximal projection proposed, the Rel(ative) P(hrase). Furthermore, Koopman's (1996, 2005) PPA (Principle of Projection Activation) comes out unscathed when faced with the Tuki data:

(78) Principle of Projection Activation (Koopman 1996) (PPA)

A Projection is interpretable iff it is associated with lexical material at some stage in the derivation.

The PPA is not violated since the head of the proposed Rel(ative) P(hrase) contains an agreeing relative marker, *odzu*.

Koopman (2005) indicates that "the PPA prevents representations with truly empty projections (where neither Spec, nor head contains a lexical item or a trace) and forces movement". Molded in the standard Minimalism terminology, the PPA would read as follows:

(79) (Koopman's (2005), (11))

Functional heads are strong

Overt material must be linearized. [...] the distribution of overt lexical items over these huge universal structures is determined by some version of LCA (Linear Correspondence Axiom (Kayne 1994)).

(80) (Koopman's (2005), (12))

Modified LCA has as consequence that no Spec and head position can simultaneously contain overt lexical material.

Certainly, as we have seen, this modification of LCA cannot be valid as far as the Tuki data are concerned since the [Spec, FP] and [F, FP] positions are both lexically filled. But given that the PPA requires that all projections be activated by lexical material (i.e all functional heads are strong), and this condition is met as shown above, one wonders how the RelP is licensed in Tuki. The RelP is preceded and dominated by the [N, NP] position *mangadzu okutu* “young woman”. The [Spec, RelP] position is filled by a null operator the antecedent of which is *mangadzu okutu*. Licensing is therefore plausible. In partial conclusion, what is the structure of Tuki relatives? It seems to be the case that relativization in this language involves the movement of an abstract operator to a position higher than Force Phrase (ForceP), a position that is also higher than the landing site of wh-question formation ([Spec, FP]). This viewpoint would nicely account for constructions such as the following grammatical sentence:

- (81) mutu odzu ee ane odzu a- dingam a- nom
 man Relative that who FOC SM loves SM sick
 agreeing
 marker

"The man that who loves is sick?"

The above sentence would be assigned the following phrase-marker (irrelevant details omitted):

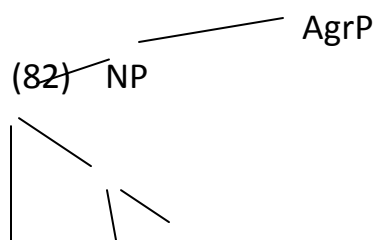

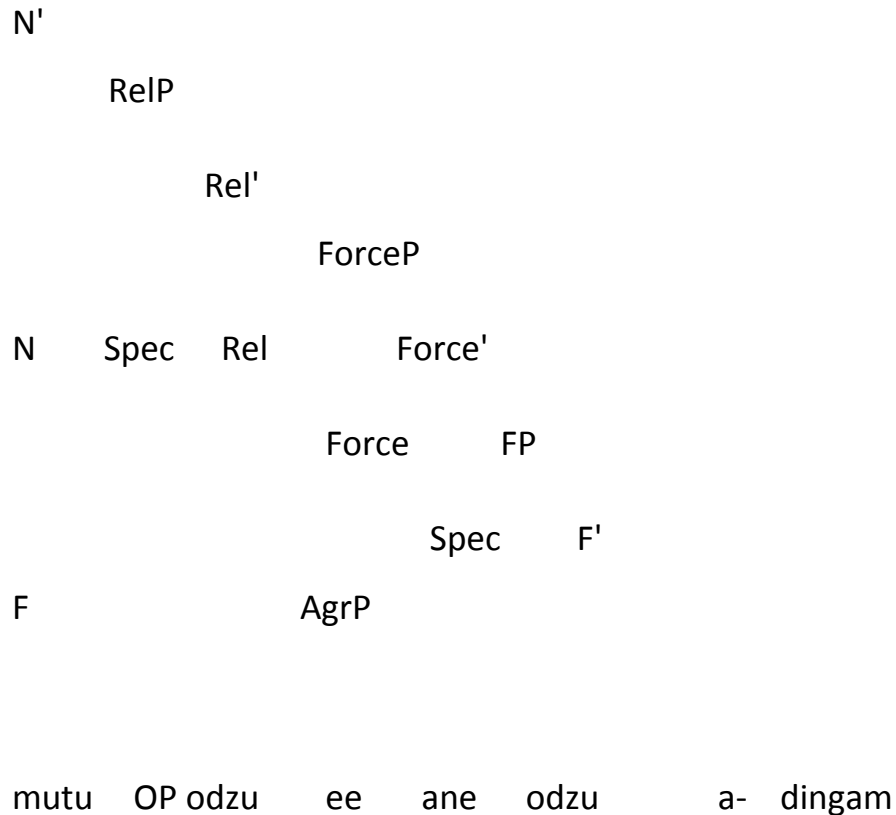

As argued in Biloa (1992, 1995), the above phrase-marker is surprising in that it assumes that in this language relativisation and content question formation are movements to two different positions. In well-known languages such as English and French, relativisation and question formation raise wh-elements to the same position. The question one has to ask is the following: is Tuki a special case of Universal Grammar? The answer seems to be negative. It has been indicated by Horvath (1986) that the landing site of relativisation in Hungarian is COMP whereas the landing site of wh-question formation is a position inside VP. Thus in view of the Hungarian facts, the Tuki data are no longer surprising.

Recall that Rizzi (1997: 289) suggests that "relative operators occupy the highest specifier position, the Spec of Force". Rizzi takes this stand on the basis of the English and Italian facts. With respect to the Tuki empirical material, it is

suggested here that in relatives a null operator substitutes for the specifier position of a high phrase called Rel(ative) P(hrase), the head of which hosts a relative agreeing marker.

The above derivation and structure of Tuki relativization has not taken into account the recent developments in generative grammar with respect to head initial relative constructions (Kayne 1994, Bianchi 1999, 2000 a-b, Aoun and Li 2003). After an extensive survey of work related to relativization, Aoun and Li (2003:117) arrive at the conclusion according to which: “both the head-raising analysis (31a) and the operator movement analysis (the matching analysis, (31b) are needed to derive relative constructions”. Recall that historically two lines of research have been pursued with regard to the study of English relative constructions: the promotion analysis and the matching analysis.

According to the promotion analysis, the head of a relative clause can be interpreted as if it is in the gap position inside the relative clause (reconstruction effects) (Aoun and Li, 2003:97). In other words, the head is moved from within the relative clause: what came to be known as the promotion analysis (Schachter 1973, Vergnaud 1974). Since the publication of Kayne’s (1994), *The Antisymmetry of syntax*, this analysis has been revived. Kayne’s approach to word order and phrase structures disqualifies right-adjunction structures in the grammar of natural languages. Kayne (1994) and Bianchi (1999, 2000 a-b) essentially argue that relatives involve the following Head movement process and complementation structure:

(83) The promotion analysis:

[_{DP} D [_{CP} NP/_{DP}_i [_C [_{TP}... t_i...]]]]

b. Head base-generation/operator movement: the Head is base-generated in its surface position and interpreted with the relative clause via a wh operator movement to the spec of the relative CP, that is the trace in the relative clause is derived by operator movement. Aoun and Li indicate that the Head raising approach (promotion analysis) involves non-wh-relatives, while the operator movement approach (matching analysis) concerns wh-relatives. From their study (p.114), the following generalizations emerge:

(87)

a. Non-wh-relatives exhibit reconstruction effects; that is, the Head can be derived by movement from the position where it is interpreted to its surface position.

b. wh-relatives do not exhibit reconstruction effects; that is, the Head is not derived by movement from the position where it is not interpreted to its surface position. It is base-generated in its surface position.

Given the above typology à la Aoun and Li, within the class of restrictive relatives, there are two types of relative constructions: wh-relatives and non-wh-relatives. Accordingly, both a Head-raising analysis and operator analysis are needed. Moreover, the conjunction facts show that a relative construction, either a wh-relative or a non-wh-relative, must be projected as a DP (Aoun and Li, 2003:118). Furthermore, a complementation structure, such as the one developed by Bianchi (1999), who refines Kayne's (1994) proposal, can accommodate both Head-raising and operator movement.

In the Head-raising approach (promotion analysis of a non-wh-relative), the Head DP, with empty D, is raised to the peripheral position of the CP. In other words, a non-wh-relative is structured and derived as follows:

(88) $[_{DP} D[_{CP} DP_i[C[_{IP}\dots t_i\dots]]]]$

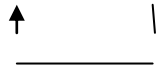

(89) $[_{DP} the[_{CP}[_{DP} \emptyset picture]_i[C' that[_{IP}\dots Bill liked t_i]]]]$

Kayne argues that relative constructions containing wh-phrases are derived in the same fashion. He also indicates that a wh-relative is derived in two steps: first, a wh-phrase is raised to the Spec of CP; second, the NP is raised to the Spec of the wh-phrase:

(90) $[_{DP} [_D the] [_{CP} [_{DP} boy_i[who t_i]] [_{C'} [_{IP} I like]]]]]$

According to Bianchi, the NP is not raised to the Spec of the wh-phrase. It is rather raised to the Spec of a higher projection, assuming Rizzi's (1997) Split-CP analysis:

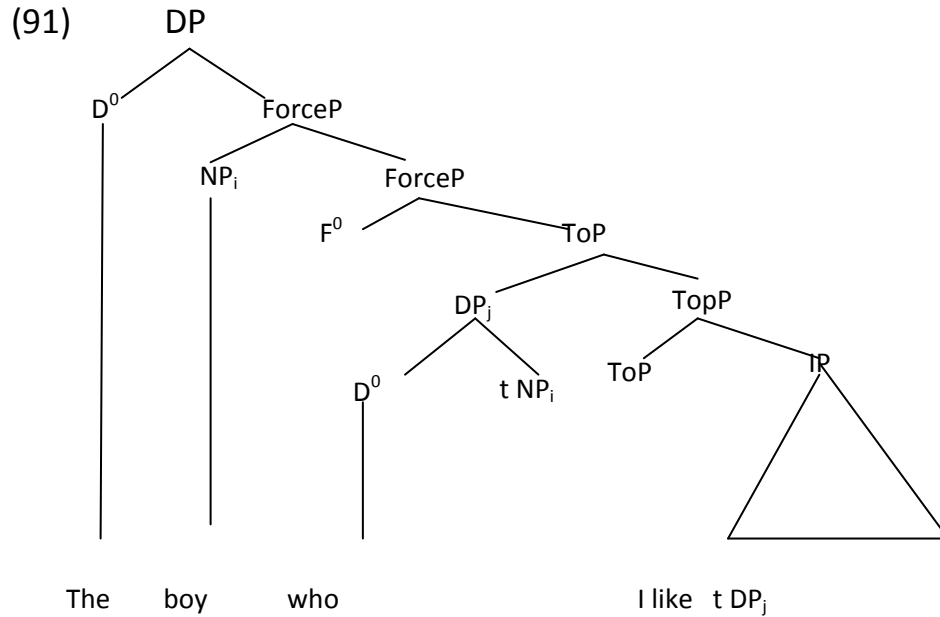

Aoun and Li observe that, for Kayne’s and Bianchi’s analyses, “a relative clause with a *who* phrase is derived by base-generating [who NP] in the argument position. The phrase [who NP] is moved from within the relative IP to the Spec of a Topic projection that is complement to a Force projection. The NP of the phrase [who NP] undergoes further movement: it moves from inside the DP occupying the Spec of TopP to the Spec of ForceP” (pp.119-120). After highlighting a number of assumptions that should be dispensed with in Kayne’s and Bianchi’s analyses, Aoun and Li attempt to refine them by proposing that the Spec of TopP is occupied by the *wh*-word *who*, *why*, *where*, *when*, *which*, and so on. They argue that their proposal falls in line with Chomsky’s (1977b) suggestion that relativisation is derived by the movement of a *wh*-operator to (the Spec of) Comp. “the *wh*-word is an operator predicated of the Head NP in the Spec of ForceP position. [...] in contrast to the structure [above (91)] where the NP in the Spec of ForceP is moved from within the DP in the Spec of TopP, [they] suggest that the NP is *not* moved from within the *wh*-phrase. If it is not moved to the Spec of ForceP, it must be base-generated there. Accordingly, it is base-generated in the Spec of ForceP and

a wh-operator occupies the Spec of TopP. The NP is the Head of the relative construction and enters into either a predication relation with the wh-operator or an agreement relation (see Chomsky 1977b; Safir 1986; Browning 1987)” (Aoun and Li 2003:121-122). On the basis of the above comments, Aoun and Li propose that English has two restrictive relative structures:

(92) Operator movement (wh-relatives)

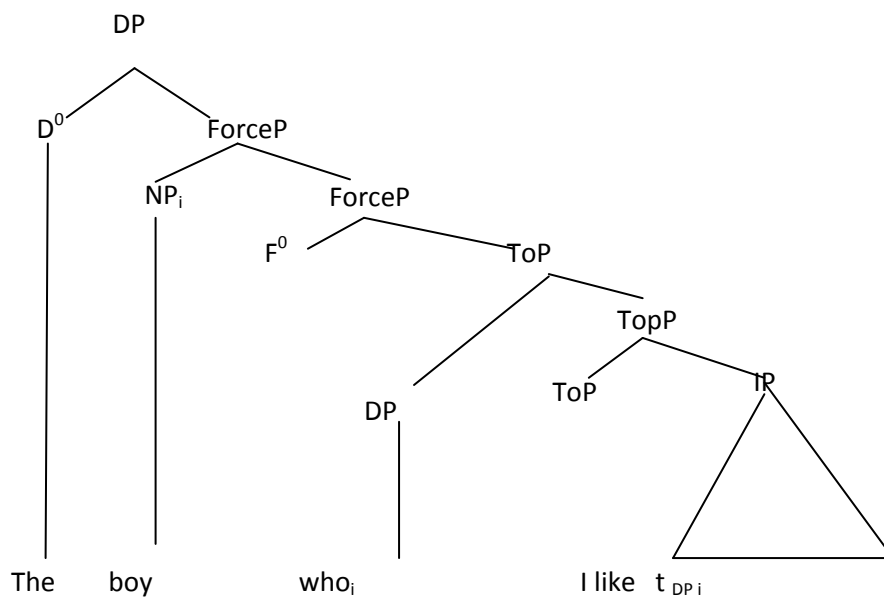

(93) Head-raising (non-wh-relative)

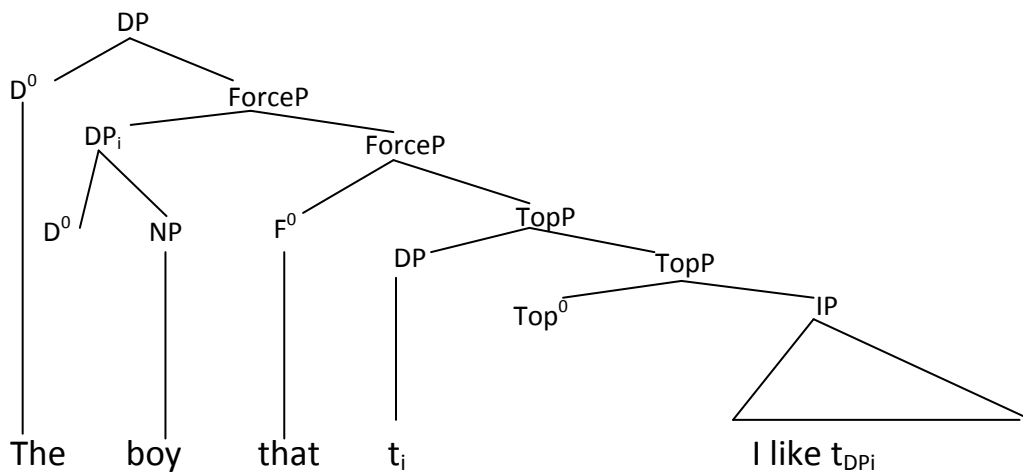

Coming back to Tuki, how can the above theoretical apparatus elaborated by Aoun and Li be extended so as to elegantly accommodate its empirical material? Bearing in mind that Tuki has neither definite nor indefinite articles such as the/a consider the following sentence:

(94) mwana ame odzu ee nu n-dingam

child my rel.marker that I SM love

“My child that I loves”

That seems to be the sole relativization strategy available in this language. Thus it appears that there are no wh-relatives; that is no relatives with one these wh-items:

(95) ane “who”

ate “what, which”

owate “why”

twii “how”

ni “when”

tane “where”

That being the case, it seems to be that Tuki relative clauses are derived by Head raising. Assuming with Bianchi (1999), Aoun and Li (2003) that wh-relatives and non-wh-relatives alike are projected as DP, the above Tuki relative clause (94) will be structured and derived as follows:

(96)

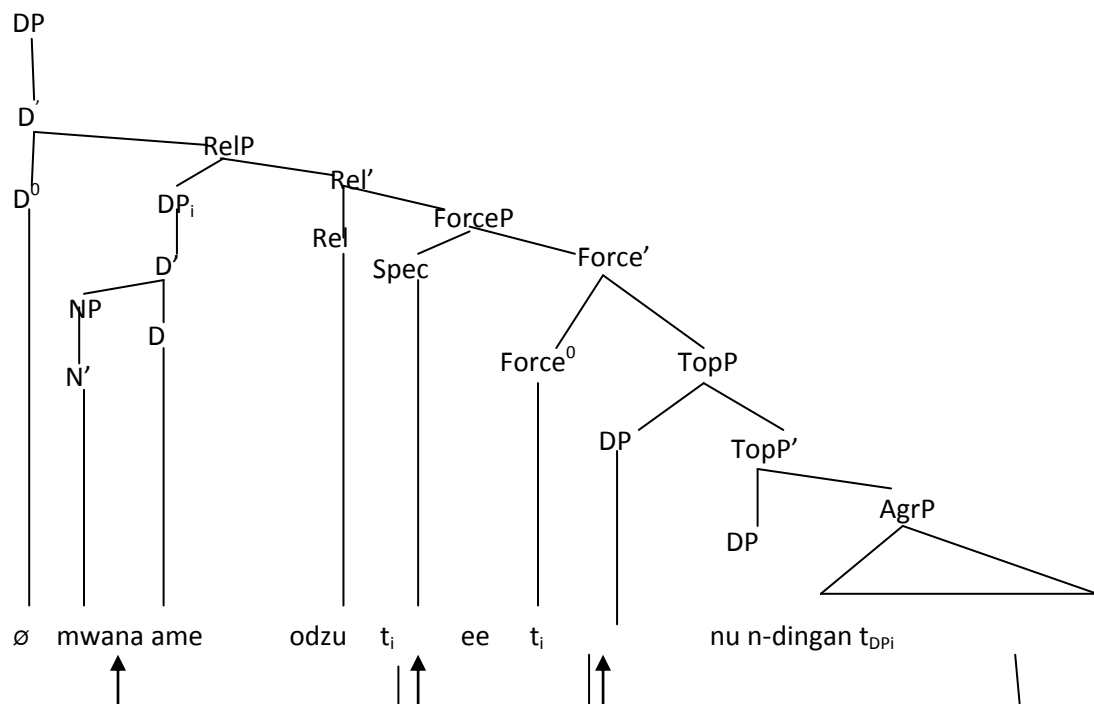

The above structure and derivation proposed for Tuki restrictive relatives makes it possible to dispense with the empty operator analysis proposed earlier here. Recall that in the null operator analysis, the null operator is encoded in a predication or agreement relation between the Head nominal and the operator. In fact, there is a so called matching relationship between the Head nominal and the null operator. The latter also agrees in noun class with the relative marker that was argued to occupy the Head of RelP. The null operator is licensed in the spec of RelP by the matching relationship between the Head nominal and the null operator.

Now, based on works by Bianchi (1999), Aoun and Li (2003), it is argued that the Head nominal is hosted by DP. The latter DP originates from an argument position inside AgrP (= IP); it is raised to the Spec of ForceP and finally lands in the spec of RelP where it agrees in noun class with the head of RelP, a classic case of Spec-

Head agreement. The head of ForceP is filled by the lexical complementizer *ee*. Its presence cannot prevent the Spec of ForceP to serve as an escape hatch for a transiting DP en route to the Spec of RelP, its final destination.

Having dispensed with the matching strategy for relativisation in Tuki and having argued for a promotion one, it is predicted that reconstruction effects are attested in Tuki relatives since they are indicative of promotion. More precisely, Tuki relatives should exhibit quantifier scope interaction inside the clause, indicating thereby reconstruction. That is exactly what happens as evidenced by the following Tuki construction:

(96)

Nu nga-ma-beraana vino viibi ivi ee ndongta ongima a-nu-random

I SM P2 call sick two agreeing marker that doctor every SM F1 cure

“I called the two patients every doctor will cure”

The above Tuki construction is ambiguous. It means either:

a. All the doctors plan to cure the SAME two patients

or

c. Each doctor will cure a different group of two patients (i.e I called more than two patients).

If reconstruction effects are indicative of promotion, the the strategy available for Tuki relativization is Head-raising (promotion). There is no need to dwell so much the structure and derivation of restrictive relative clauses in Tuki since it was not intended to be the main focus of this enterprise.

In previous works (Bilola 1992, 1995), the generalization reached seems to be that with regard to wh-movement (relativization, question formation and topicalization), the landing site of operators varies from language to language. In Hungarian (Horvath 1986: 49), any topicalized phrase in a relative clause will necessarily follow the relative wh-phrase in linear order, and any topicalized phrase in a wh-question will necessarily precede the interrogative wh-phrase. In English, as suggested by Rizzi (1997) (see also Radford 2004:253-262), CP can be split into a number of distinct projections (including a Force Phrase, a Topic Phrase and a Focus Phrase) in structures containing a topicalized and/or focalized constituent:

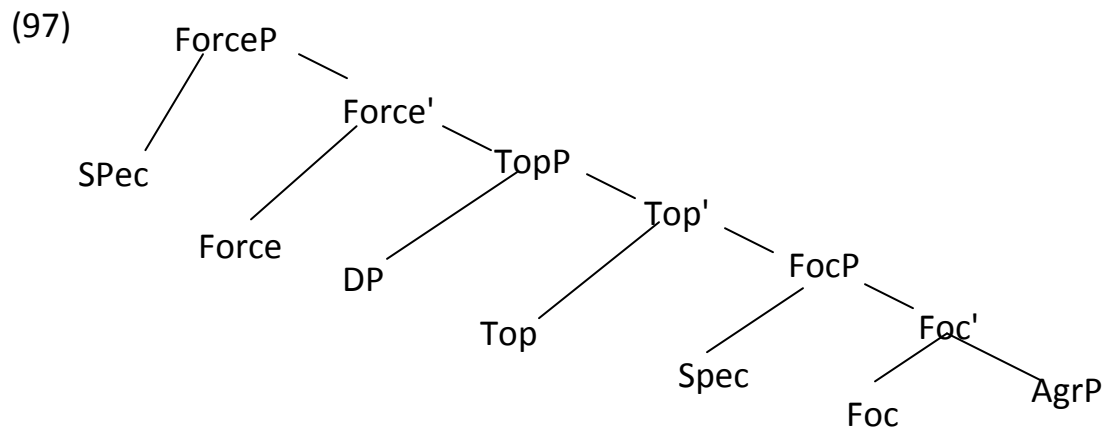

The above discussion leads to the following question: what is the structure of topicalization in Tuki?

4. Topicalization

It has been argued by Baltin (1978), Lasnik and Saito (1984, 1992) that topicalization in English is adjunction to the left boundary of IP. Bilola (1992, 1995) followed suit by claiming that Tuki behaves like English.

Rizzi (1997) and Haegeman (2000) argue that just as focussed constituents occupy the specifier position within a Focus Phrase, similarly topicalized constituents occupy the specifier position within a topic phrase. If that is the case, we might as well argue that in Tuki topicalized constituents substitute for the specifier position of Topic Phrase ([Spec, TopP]). To illustrate how this works, consider the following sentences:

(98)

a. Mbara a- mu- batiya Puta na kiisini

Mbara a- P1 greet Puta in kitchen

"Mbara greeted Puta in the kitchen"

b. Puta_i, Mbara a- mu- batiya x_i na kiisini

Puta Mbara SM p1 greet in kitchen

"Puta, Mbara greeted (her) in the kitchen"

c. [na kiisini]_i, Mbara a- mu-

in kitchen Mbara SMp1

batiya Puta x_i

greet Puta

"In the kitchen, Mbara greeted Puta"

In sentence (b), the direct object complement *Puta* has been topicalized (and fronted), whereas in sentence (c), it is the PP *na kiisini* that has been topicalized. The tree representations of the last two sentences are the following:

(99)

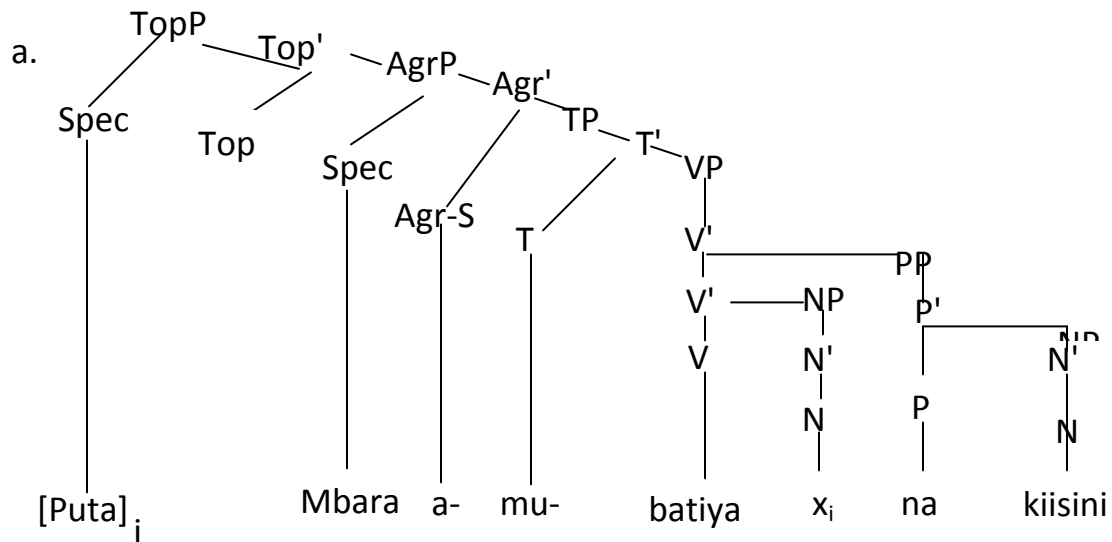

b.

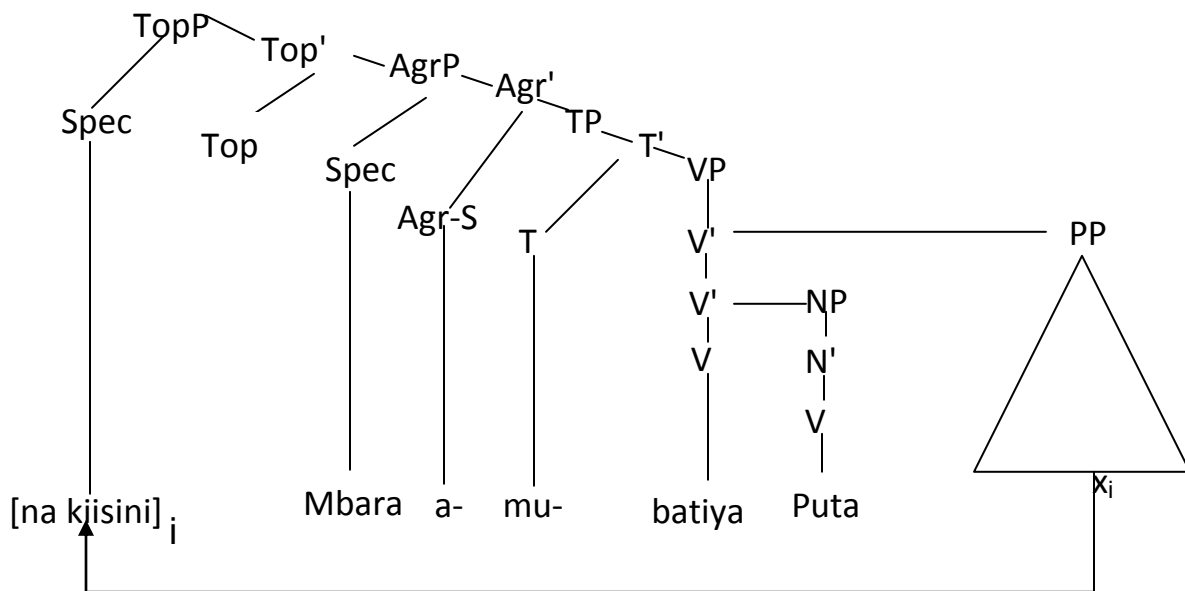

Tuki topicalization can be characterized by the recursion of topics. In other words, it is possible to have several topics in the left periphery of the clause:

(100) waa owii, tama adze, vadzu va adongo, visangena n(a) otema, n(a) ibino,

year that time this children of village, joy in heart at feast

nkunkuma a-nu- wu- tefaanam

chief SM f1 OM invite

“ that year, at this time, the village children, with joy in their hearts, to a party, the chief will invite (them)”

So topic recursion happens to be a characteristic of Tuki wh-movement. This explains why the left periphery of the above example is linearly structured as follows:

(101) Topic recursion in Tuki

TopP >TopP >TopP > TopP >TopP > AgrP

What happens in Tuki when topicalization cooccurs with relativization or wh-question? To answer this question, consider the following data:

(102) Relative clauses (Bilola 1995:81, (74))

a. [Okutu [odzu]_i [ForceP ee] [TopP na tsumba]_j

Relp that in bedroom

aneme waa a- mu- tuma x_i x_j

husband her SM P1 send

"The woman who (m) to the bedroom her husband sent ..."

b. * okutu [na tsumba]_j [RelP odzu]

woman in bedroom who(m)

[_{ForceP} ee] aneme waa
 that husband her
 a- mu- tuma x_i x_j
 SM P1 send

(103) Wh-question (Biloa 1995:81, (75))

a. [_{FP} ane odzu]_i [_{TopP} na tumba]_j
 who Foc in bedroom

aneme waa a- mu- tuma x_i x_j
 husband her SM P1 send

"Who to the bedroom did her husband send?"

b. * [_{TopP} na tumba]_j [_{FP} ane odzu]_i
 in bedroom who Foc

aneme waa a- mu- tuma x_i x_j
 husband her SM P1 send

Having argued above that topicalization is substitution for the specifier position of TopP, the two (a) sentences above would have the following phrase-markers:

(104) a. NP

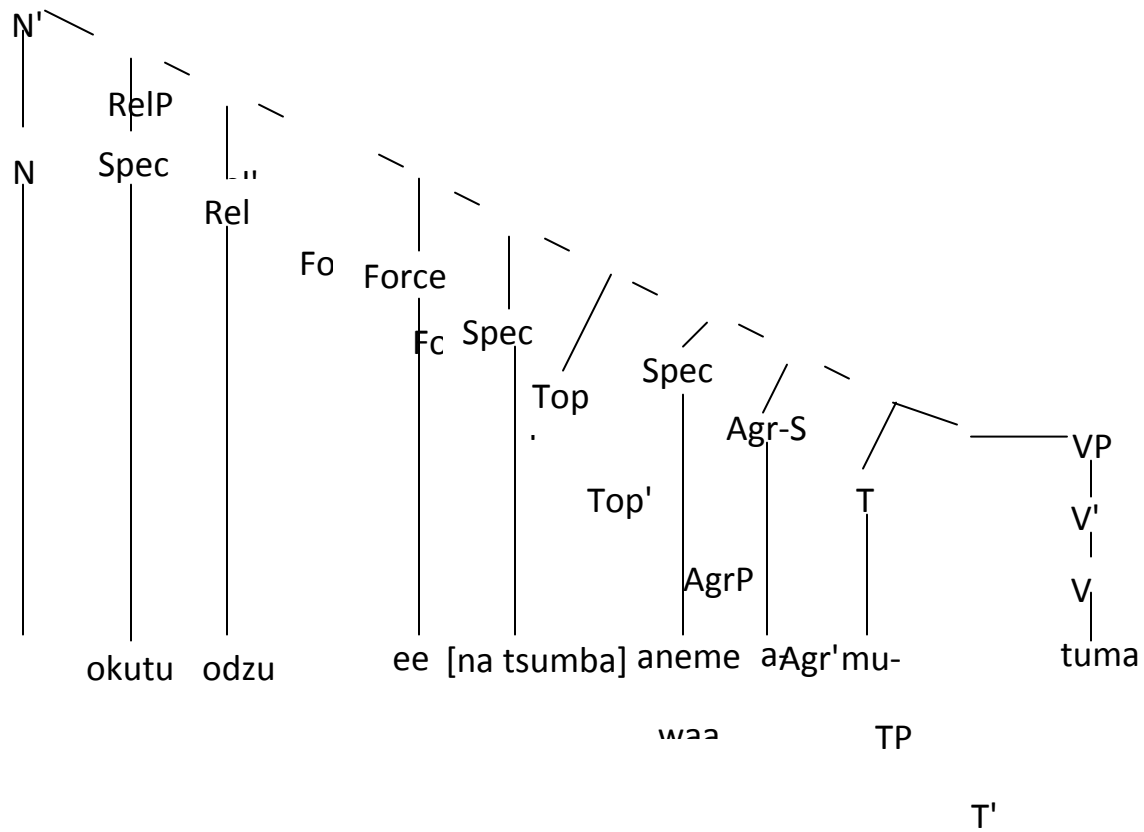

b.

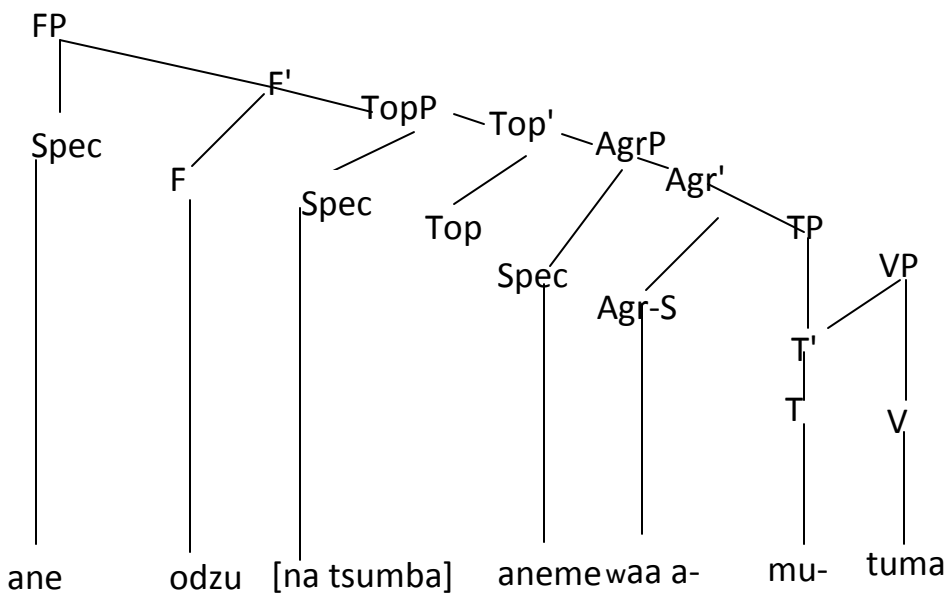

Why are the two (b) sentences above ungrammatical? It seems to be the case that the variables born out of the raising of the PP **na tsumba** “in the bedroom”

are not properly governed; more precisely, antecedent-government fails in this case because there are potential antecedent governors intervening between the real antecedents and the variables. So both sentences violate either the Empty Category principle (ECP) (Chomsky 1981) or Relativized Minimality (Rizzi 1990, 2001 a). I will not elaborate further on this issue as it is not the main concern of this endeavour. The two (b) sentences above show clearly that TopP cannot dominate FP in this language, nor can it dominate RelP. So on the basis of positional evidence presented so far, the CP system in this language has the following structure:

(105) RelP > ForceP > FP > TopP > AgrP

To show that these four different kinds of positions (RelP, ForceP, FP, TopP) can overtly appear in Tuki sentences, consider the following:

(106) (Biloa (1995:82, (77))

aneme	waa	a-	mu-	tuma	okutu	na tumba
husband	her	SM	P1	send	woman	to bedroom
ibisi	aye					
morning	this					

“Her husband sent the woman to the bedroom this morning”

Now if *okutu* is relativized, *na tumba* topicalized, and *ibisi aye* questioned, the following construction is obtained.

(107) (Biloa 1995:82, (78))

[RelP okutu_i odzu [ForceP ee [FP ni_k owu

	Woman	who	agreeing marker	that	when	Foc
	[_{TopP} na tsumba _j		[_{AgRP} aneme waa			
	To bedroom		husband	her		
a-	mu-	tuma-	x _i	x _j	x _k]]]]]	
SM	P1	send				

"the woman who, when, to the bedroom did her husband send ? "

The grammaticality of the above sentence is proof that three raising processes can occur in the same clause as long as these operations do not move phrases to the same position:

(108) (Bilola 1995: 82, (79))

* Ane _i	odzu	ni _j	owu	aneme	waa
Who	FOC	when	FOC	husband	her
a-	mu-	tuma-	na	tsumba	x _j x _j
SM	P1	send	to	bedroom	

In the sentence above, (84), *ane* and *ni* presumably raised to the same position, hence the ungrammaticality of the construction.

As clearly noted above, Tuki exhibits constructions in which a relative and an interrogative wh- element have been fronted:

(109) (Bilua 1995: 82, (80))

Putu a- dingam [_{RelP} mutu_i odzu [_{ForceP} éé [_{FP} ane_j odzu [AgrP x_i

Putu SM loves man who agreeing head that who FOC

a- benam x_j]]]]

SM hate

"Whom does Putu like the man who hates?"

This sentence constitutes evidence that relativization differs from content question-formation in that the former process is wh-movement to a higher position termed [Spec, RelP], while the latter process involves the merge of the wh- item in the Spec of the Focus Phrase (FP), lower respectively than RelP and ForceP.

Assuming that the relative null operator (OP) lands in Spec of RelP) and that the extracted wh-element merges in the Spec of FP, the above sentence is assigned the following phrase-marker (irrelevant details omitted):

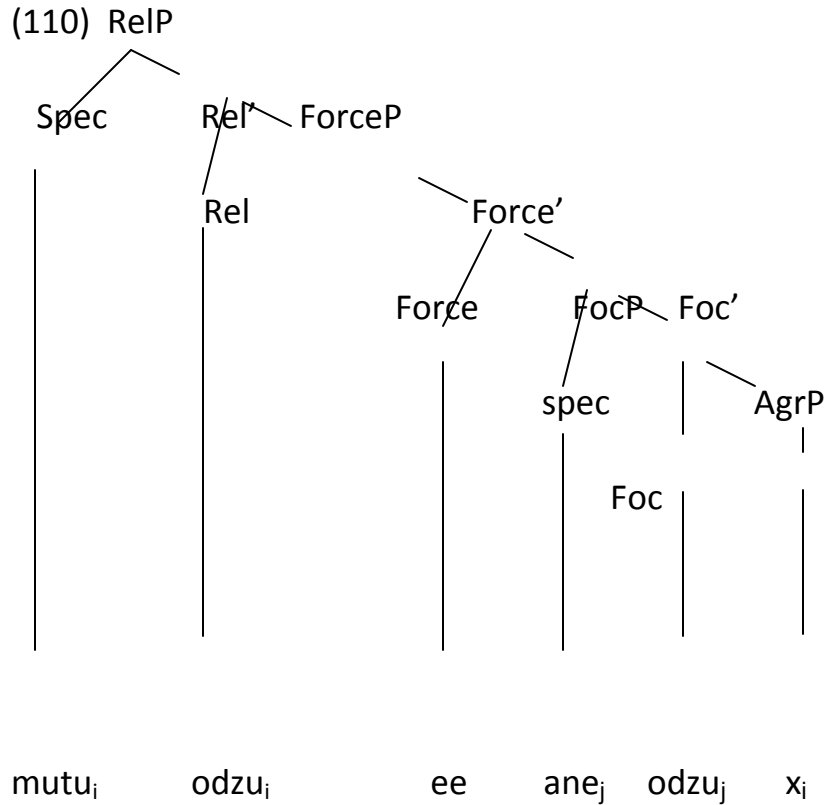

Notice that the relative null operator (OP) agrees in noun class with the antecedent *mutu* "man". The above sentence raises some questions: how is the ECP satisfied for subject extraction? Assume that Infl is a proper governor in Tuki. The language allows empty categories in subject position and does not exhibit that trace effects:

(111) (Bilola 1995 :83, (82))

- a. Mbara a- nyam cwi
 Mabra SM eats fish
 "Mbara eats fish"
- b. pro a- nyam cwi
 SM eats fish

"he/she eats fish"

(112) (Bilola 1995:84, (83))

andzu_i mamu o- mu- dzu ee x_i

Who you SM P1 say that

a- ma- namba vibufa

SM P2 Cook vegetables

"Who did you say that cooked vegetables?"

(For details on extraction possibilities in Tuki, see Bilola (1989 and 1991)).

5. The position Int(errogative) in Tuki

So far it has been argued that in this Bantu language of Cameroon, the left periphery of the clause is structured as follows:

(113) RelP >ForceP >FP>TopP>AgrP

Until proven otherwise, it seems to be the case that FP precedes and dominates TopP, unlike the Italian case where TopP can precede and follow simultaneously FP (Rizzi 2001 b).

11.1. The position of *ngi* "if "

In Tuki, embedded yes/no questions are introduced by *ngi* "if". *Ng* and the lexical complementizer *ee* share a few positional properties. The two elements can cooccur with a focalized phrase which must follow them (the focussed PP is followed by the focus marker *owu*):

(114) Viroo a- bunganam ee na tsumba

Viroo SM things that in bedroom

owu Mbara a- ma- batiya Puta

Foc Mbara SM P2 greet Puta

"Viroo things that it is in the bedroom that Mbara greeted Puta"

b. *Viroo a- bunganam na tsumba

Viroo SM things in bedroom

owu ee Mbara a- ma- batiya Puta

Foc that Mbara SM p2 greet Puta

(115)

a. Viroo a- sesam (ee) ngi

Viroo SM asks that if

na tsumba owu Mbara a- ma- batiya Puta

In bedroom Foc Mbara SM p2 greet Puta

"Viroo wonders if it is in the bedroom that Mbara greeted Puta"

b.* Viroo a- sesam na tsumba

Viroo SM asks in bedroom

owu (ee) ngi Mbara a- ma- batiya Puta

Foc (that) if Mbara SM p2 greet Puta

In Tuki, ee "that" can only be followed by a topic:

(116)

a. Viroo a- bunganam ee na tsumba
Viroo SM thinks that in bedroom
Mbara a- ma- batiya Puta
Mbara SM p2 greet Puta

"Viroo thinks that in the bedroom, Mbara greeted Puta"

b. * Viroo a- bunganam na tsumba
Viroo SM thinks in bedroom
ee Mbara a- ma- batiya Puta
that Mbara SM p2 greet Puta

Similarly, *ngi* "if" must necessarily precede a topic in this language:

(117)

a. Viroo a- t(a)-idzima ngi, na tsumba,
Viroo SM Neg know if in bedroom
Mbara a- ma- batiya Puta
Mbara SM pz greet Puta

"Viroo does not know if, in the bedroom, Mbara greeted Puta"

b.* Viroo a- (ta)- idzima, na tsumba,
Viroo SM Neg know in bedroom
ngi Mbara a- ma- batiya Puta
If Mbara SM p2 greet Puta

If the above (a) sentences are grammatical, the (b) sentences sound awkward. The data seem to suggest that *ee* and *ngi* are in complementary distribution in the same configuration. That is, when and where one occurs, the other should not and vice versa. However, that is not the case since the sequence *ee ngi* "that if " is allowed in the language, as the following sentence clearly illustrates it:

(118)

Viroo	a-	sesam	ee	ngi	Mbara
Viroo	SM	asks	that	if	Mbara
a-	ma-	kusa	matuwa		
SM	p2	buy	car		

"Viroo asks if Mbara bought a car"

The above sentence clearly shows that *ee* and *ngi* occupy two distinct positions just like *que* and *si* in Italian (cf. Rizzi 2001b who quotes Plann (1982) and Sűner (1994)). Having argued that *ee* "that" is hosted by the head of the ForceP position, assume with Aboh (1998) and Rizzi (2001b) that there is a position called Int(errogative) P(hrase) that is dominated by ForceP. As far as the Tuki empirical material is concerned, *ngi* occupies the head of IntP. Furthermore, IntP is preceded by ForceP and can be either followed by a Focus Phrase (FP) and a TopP or vice versa:

(119)

a. Mbara	a-	sesam	[_{ForceP} ee	[_{IntP} ngi
Mbara	SM	asks	that	if

[_{FP} na tsumba owu [_{TopP} idzo [_{AgrP}
 in bedroom FOC yesterday
 Dima a- ma- batiya Puta]]]]
 Dima SM p2 greet Puta

"Mbara asks if it was in the bedroom yesterday

That Dima greeted Puta"

b. Mbara a- sesam [_{ForceP} ee [_{IntP} ngi
 Mbara SM asks that if

[_{TopP} idzo [_{FP} na tsumba owu [_{AgrP} Dima
 yesterday in bedroom FOC Dima
 a- ma- batiya Puta]]]]]
 SM p2 greet Puta

"Mbara asks if yesterday it was in the bedroom that Dima greeted Puta"

It is important to bear in mind that the presence of *ee* "that" in the above sentences is optional whereas it is compulsory in embedded declarative contexts such as the following:

(120) Viroo i-dzimam *(ee) Mbara a- nu-
 Viroo SM knows that Mbara SM f1
 banam Puta
 Marry Puta

"Viroo knows that Mbara will marry Puta"

Also important to bear in mind is the fact that the main verb in the sentences, despite the presence of *ee* "that" selects for an indirect question (see Biloa 1995: 85-88, for a discussion on selectional restrictions in such contexts). Moreover, as the (a-b) sentences indicate, either of the following two positional sequences is allowed in the language:

- (121) a. ForceP >IntP >FP> TopP
 b. ForceP >IntP >TopP>FP

The data above clearly show that *ngi* can cooccur with either a lower focus or a lower topic or with both. But *wh-* items in main questions cannot cooccur with a focus, whatever the order of occurrence:

(122)

a. Puta a- ma- fa Tsimi mbama
 Puta SM p2 give Tsimi money
 "Puta gave Tsimi money"

b. Ane_i odzu Puta a- ma- fa x_i mbama
 Who Foc puta SM p2 give money
 "Who did Puta give money?"

c. *Ane_i odzu ate_j aye Puta a- ma- fa x_i x_j
 who Foc what Foc Puta SM p2 give

d.* Ate_j aye ane_i odzu Puta a- ma-
 what Foc who POC Puta SM P2

fa

give $x_i x_j$

e.* Ane_i odzu mbama_j idzii Puta a- ma- fa x_i x_j
who Foc money Foc Puta SM p2 give

In Biloa (1992, 1995), it is argued that only one wh-element can be fronted in Tuki. In so doing, it occupies the [Spec, FP] position which cannot be occupied by two extracted wh-elements. Similarly, only one focalized constituent can be hosted by this position, not two. Nor can one focussed constituent and one fronted wh-item be accommodated by the same position.

Wh- elements in embedded clauses pattern with wh-elements in main contexts, as already shown by Biloa (1995:59, (21)) :

(123) (Biloa 1995:59, (21))

a. Mbara a- sesam [ee Puta a- fam ane ate]]

Mbara SM asks that Puta SM gives who what

“Mbara asks that Puta gives who what”

b. Mbara a- sesam [ee [ane [Puta a- fam ate]]]

Mbara SM asks that who Puta SM gives what

“Mbara asks who Puta gives what”

c. Mbara a- sesam [ee [ate [Puta a- fam ane]]]

Mbara SM asks that what Puta SM gives who

“ Mbara asks that Puta gives who ”

d. *Mbara a- sesam [ee [ate_j [ane_i [Puta a- fam ane x_i x_j]]]]

“ Mbara a- asks [that [what_j [who_i [Puta gives x_i x_j]]]]”

e. *Mbara a- sesam [ee [ane_i [ate_j [Puta a- fam ane x_i x_j]]]]

‘Mbara a- asks [that [who_j [what_i [Puta gives x_i x_j]]]]’

Now what about the interaction between a wh-phrase and a focalized constituent in embedded clauses?

(124)

a. Viroo a- sesam [_{Force} ee [_{AgrP}

Viroo SM asks that

Puta a- ma- fa Tsimi ate]]

Puta SM p2 give Tsimi what

"Viroo asks what Puta gave Tsimi"

b. Viroo a- sesam [_{ForceP} ee [_{FP}

Viroo SM asks that

Tsimi odzu [_{AgrP} Puta a- ma-

Tsimi FOC Puta SM p2

fa ate]]]

give what

c. Viroo a- sesam [ForceP ee

 Viroo SM asks that

[_{FP} ate aye [_{AgrP} Puta a- ma-

 What FOC Puta SM p2

fa Tsimi]]]

give Tsimi

d.* Viroo a- sesam [_{ForceP} ee

 Viroo SM asks that

[_{FP} Tsimi odzu [_{WhP} ate aye

 Tsimi FOC what Foc

[_{AgrP} Puta a- ma- fa]]]]

 Puta SM p2 give

e.* Viroo a- sesam [_{ForceP} ee

Viroo SM asks that
 [WhP ate aye [FP Tsimi odzu
 what FOC Tsimi Foc
 [AgrP Puta a- ma- fa]]]]

Puta SM p2 give

In embedded contexts as well, only one constituent (a wh- phrase or a focussed phrase) can be fronted. The ungrammaticality of the last two sentences seems to suggest that the wh-phrase and the focalized constituent compete for the same landing position which appears to be [Spec, FP] (as suggested in Biloa 1992, 1995).

Partially summarizing, the following orderings of functional categories are attested in Tuki embedded clauses:

(125)

- a. ForceP >IntP> FP>TopP
- b. ForceP> IntP> TopP >FP

11.2. The IntP in main clauses

In Tuki, yes/no questions are introduced by a special morphological marker:

(126)

a. Mbara a- mu- banam Puta

Mbara SM F2 marry Puta

"Mbara will marry Puta"

b. yee Mbara a- mu- banam Puta

QM Mbara SM F2 marry Puta

"Will Mbara marry Puta? "

c. Tsimi a- sesam ee yee Mbara

Tsimi SM asks that QM Mbara

a- mu- banam Puta

SM f2 marry Puta

"Tsimi wonders whether Mbara will marry Puta"

d. Tsimi a- sesam (ee) ngi Mbara a-

Tsimi SM asks that if Mbara SM

nu- banamPuta

F1 marry Puta

"Tsimi wonders whether Mbara will marry Puta"

The above paradigm shows that Tuki yes/no questions in matrix and embedded contexts can be introduced by a special morphological marker which I have termed a question morpheme (QM). In the pre-Rizzi (1997)'s framework, questions are CPs headed by a C which carries [TNS, WH, EPP] features. Following standard assumptions and accordingly, wh-questions as well as yes-no questions are CPs containing an interrogative specifier. Grimshaw (1993) and Roberts (1993) suggest that yes/no questions contain a null question operator which is directly generated in the [Spec, CP] position: this operator is therein generated by merge rather than by movement.

Adopting Rizzi's split CP hypothesis while preserving Grimshaw and Roberts suggestions, the Tuki QM *yee* is going to be hosted by Int and the null question operator will occupy Spec-IntP:

(127)

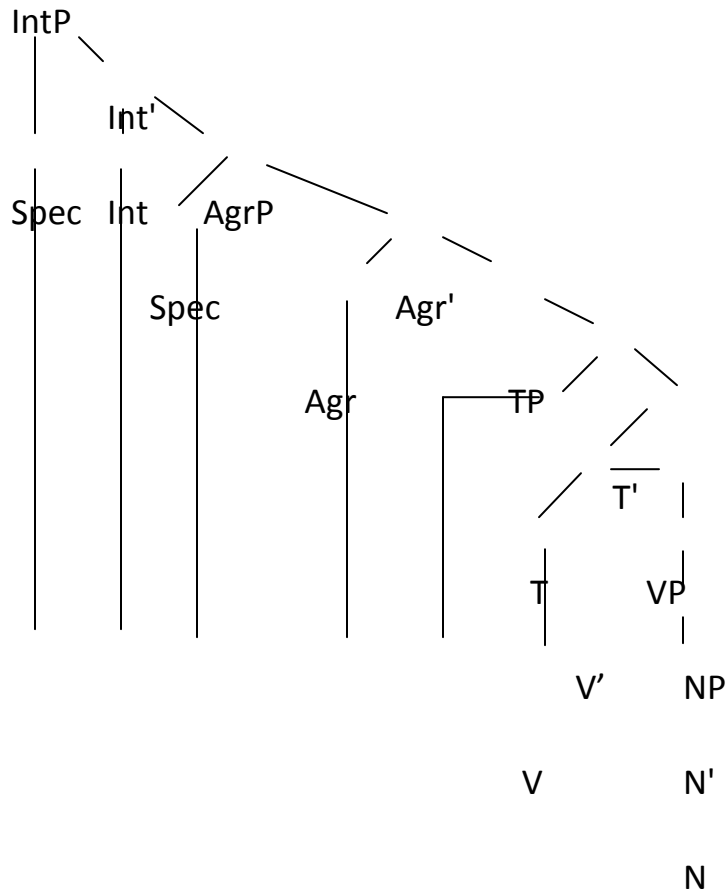

OP yee Mbara a- nu- banam Puta

The (c-d) sentences seem to indicate that *yee* (QM) and *ngi* "if" are in complementary distribution. *ngi* introduces an indirect question and the latter does not require the presence of the QM. As for the Spec of IntP, it is filled by a null operator in main and embedded yes/no questions.

On the other hand, Tuki yes/no questions formation may allow the presence of another morpheme, *aa*, at the end of the clause:

(128)

Mbara a- nu- banam Puta aa?

Mbara SM f1 marry Puta Q

“will Mbara marry Puta?”

(129)

Viroo a- dingam moni aa?

Viroo SM loves money Q

“ Does Viroo like money?”

It can be observed from the above sentences that the presence of the morpheme *aa* turns a clause into a yes/no question in this language. This morpheme seems to play the role of what is called above the Q morpheme *yee*. But while each one of them seems to fulfil the role and function of a Q morpheme (compare (103) with (104a)), it is surprisingly the case that both can appear in the same clause, with the yes/no question interpretation still obtaining:

(130)

a. *yee* Mbara a- nu- banam Puta aa

Q Mbara SM f1 marry Puta Q?

“ Will Mbara marry Puta?”

b. *Yee* Viroo a- dingam moni aa?

Q Viroo SM loves money Q

“Does Viroo like money?”

Thus, each one of these morphemes, *yee* or *aa*, can help form a yes/no question; and both can simultaneously occur in a yes/no question without the latter’s meaning being altered.

While phenomena such as these might appear surprising, they are very common in some Bantu languages. For example, in Bulu or Ewondo, both Bantu languages spoken in the central and southern regions of Cameroon, two question morphemes, very similar in behaviour to the Tuki ones, can appear in the same sentence:

(131)

a. ye wa wok dzom ma dzo nga

Q you listen thing I say Q

“Do you listen to what I say?”

“Do you understand what I am saying?”

b. ye wa wok dzom ma dzo?

Q

c. wa wok dzom ma dzo nga?

Q

d. nga wa wok dzom ma dzo?

Q

In the Bulu data illustrated above (131 a, b, c), each one of the Q morphemes can occur alone (131 b-c) or both can simultaneously show up, one at the beginning, the other in clause-final position. In (131 d), *nga*, surprisingly, is seen in the left periphery of the clause. Here comes in the difference between Tuki and Bulu. How does *nga* wind up inside the left peripheral material in this language? We will shy away from the Bulu empirical material and concentrate on Tuki where this type of behaviour is not exhibited.

Focussing on the cartographic approach, what position does *aa* occupy in the Tuki phrase marker? It has been argued above that *yee* fills the head of IntP, Int°. Since *yee* and *aa* seem to play and fulfil the same role and function, wouldn't it be plausible to assume that *aa* occupies the same position inside IntP. If that is the case, when both Q markers occur, the phrase marker will end up with two IntP projections, one in clause-initial position with the other in clause-final position. Is this state of affairs possible in the cartographic approach? In previous studies (Rizzi 1997, 2001b), the approach made provision for topic recursion and a left peripheral Mod projection in conjunction with an IP-internal Mod projection. It is therefore not implausible for a PM to project clause-initially and clause-finally an IntP:

(132)

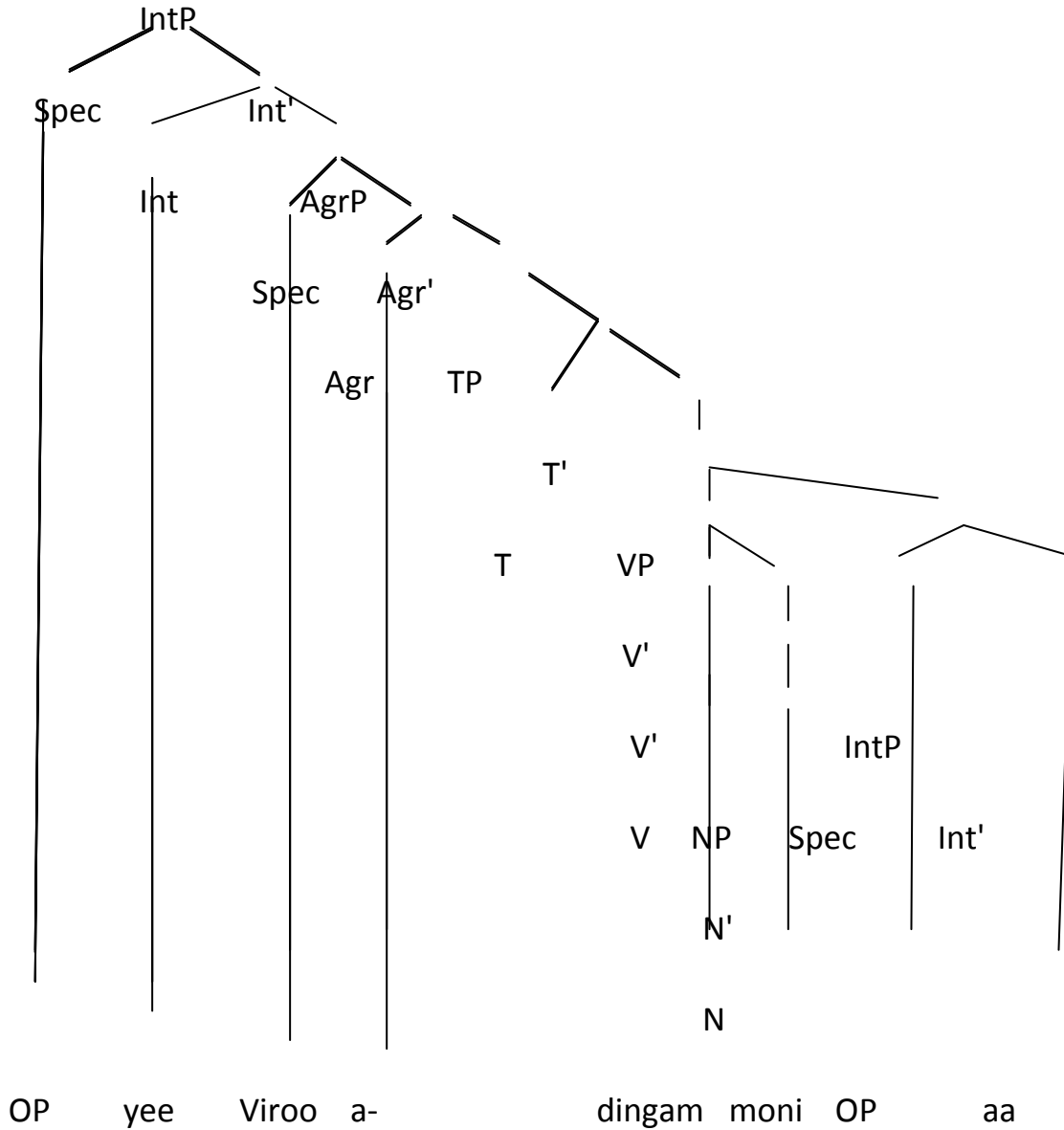

If this PM is acceptable in the framework we have adopted, one has to wonder how *aa* gets to have scope over the entire clause. Suppose it raises over the clause to some position inside the left periphery at LF. That movement is likely to violate either the Head Movement Constraint (HMC)(Travis 1984) or Relativized

Minimality (RM) (Rizzi 1990, 2004b) or the Minimal Link Condition (MLC) (Chomsky 1995). To circumvent this hurdle, assume that the clause is pied-piped to the Spec of ForceP while the Q morpheme *aa* fills the head Force°:

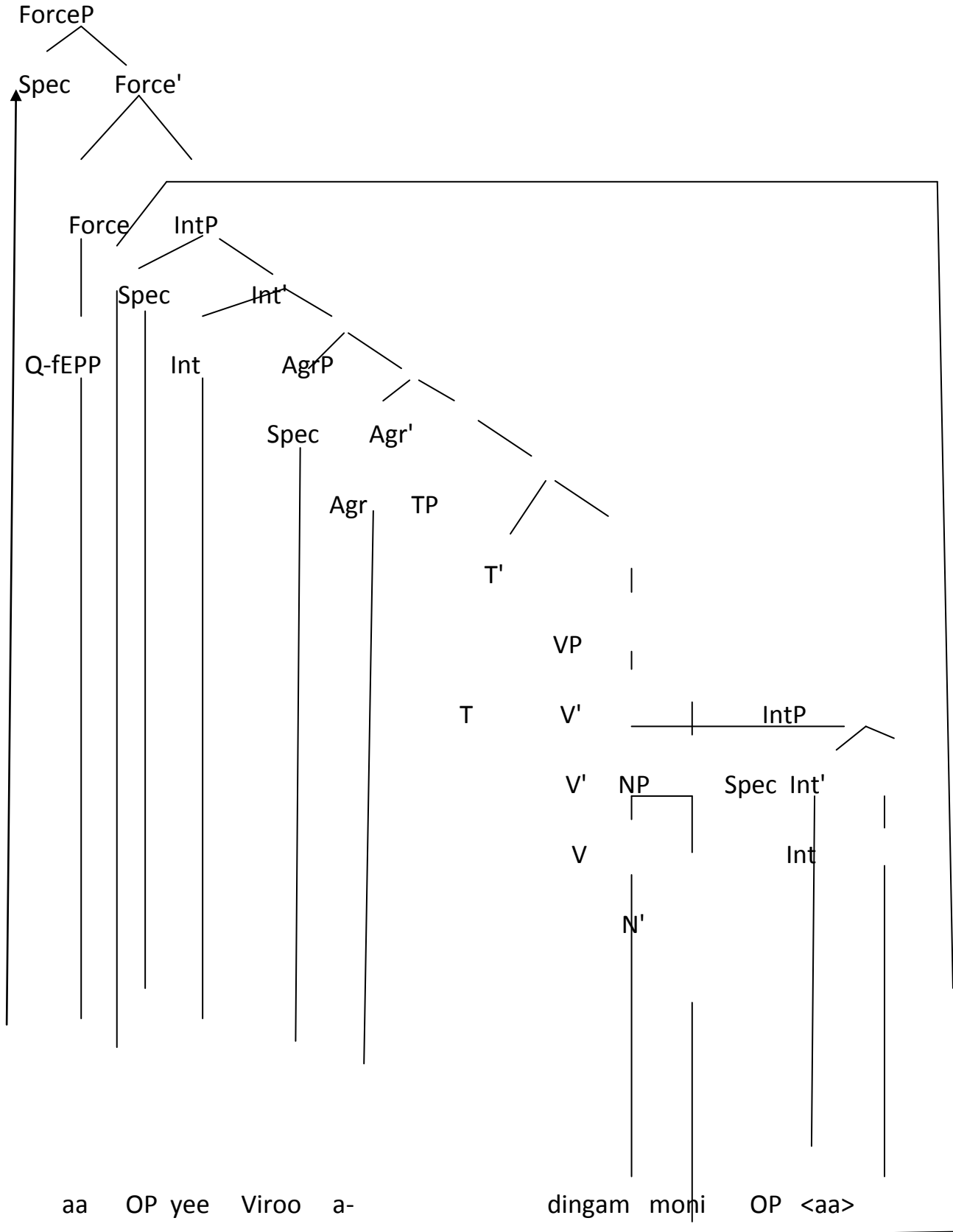

So at LF the Q morpheme *aa* has scope over the entire clause, thereby generating the desired interpretation.

Notice that in interrogatives involving wh-phrases, the so called clause-final Q morpheme can occur:

(135)

Ate aye Puta a- ma- fa nosi —aa
↑

What FOC Puta SM p2 give mother Q

“what did Puta give her mother?”

Obviously, the above sentence can not be interpreted as a yes/no question. It is a genuine wh-question in which the morpheme *aa* is optional, as it is optional in constructions where the INT morpheme *yee* occurs (clause initially). Needless to say when *aa* occurs without *yee*, its presence is compulsory for the clause to be interpreted as a yes/no question. Having said that, sentence (135) will be assigned the following tree structure:

(136)

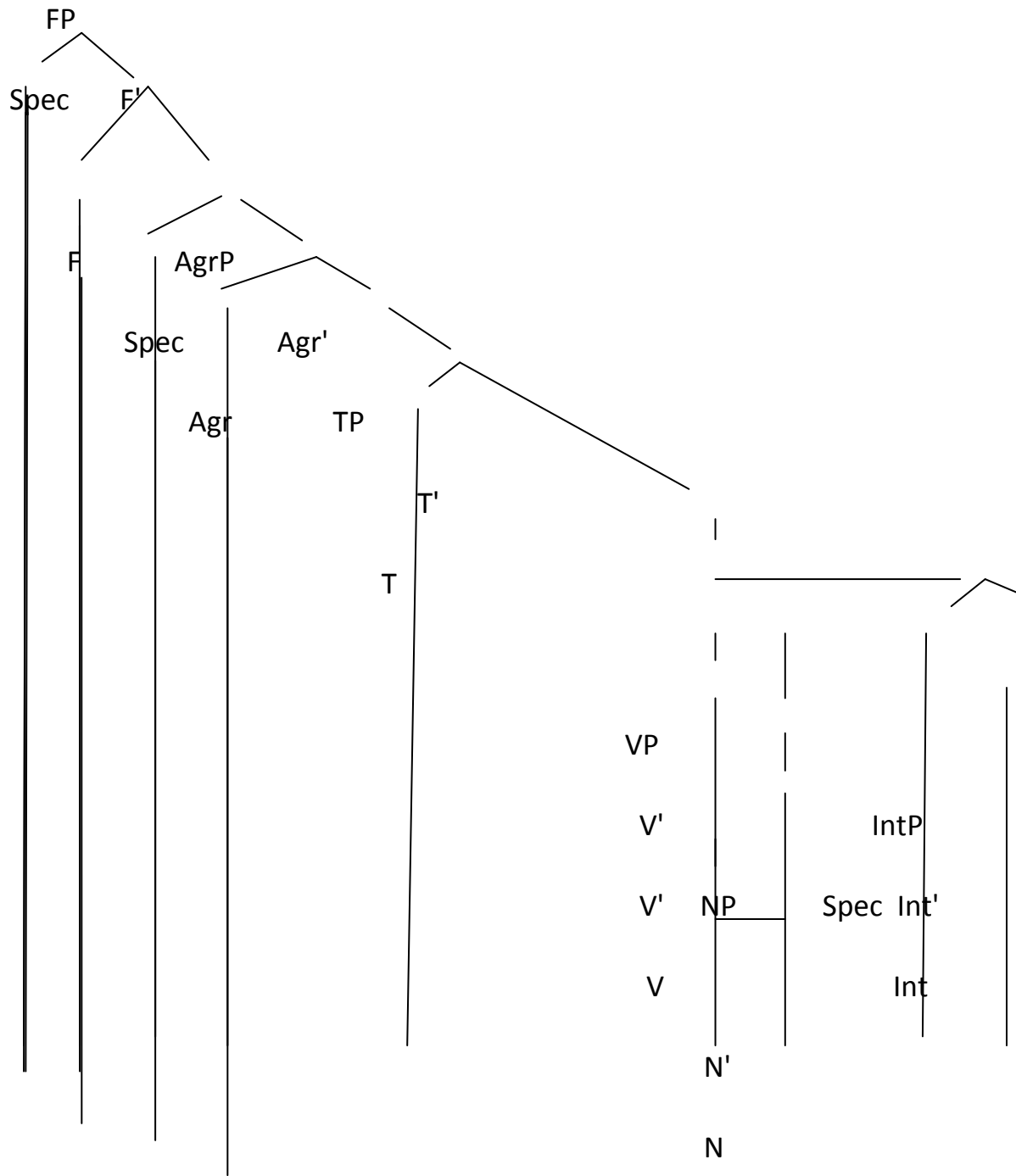

ate aye Puta a- ma- fa nosi OP aa

In the old terminology (before minimalism), this tree structure is the S-structure representation of (109). Since the sentence is a genuine *wh*-question, *aa* could be argued to function here as a Q morpheme, therefore explaining why it is located under Int^0 . The question now is “how does it have scope over the entire clause?” By resorting to pied piping of the whole material preceding *aa* and lodging it under the position [Spec, ForceP], one obtains the desired result:

(137)

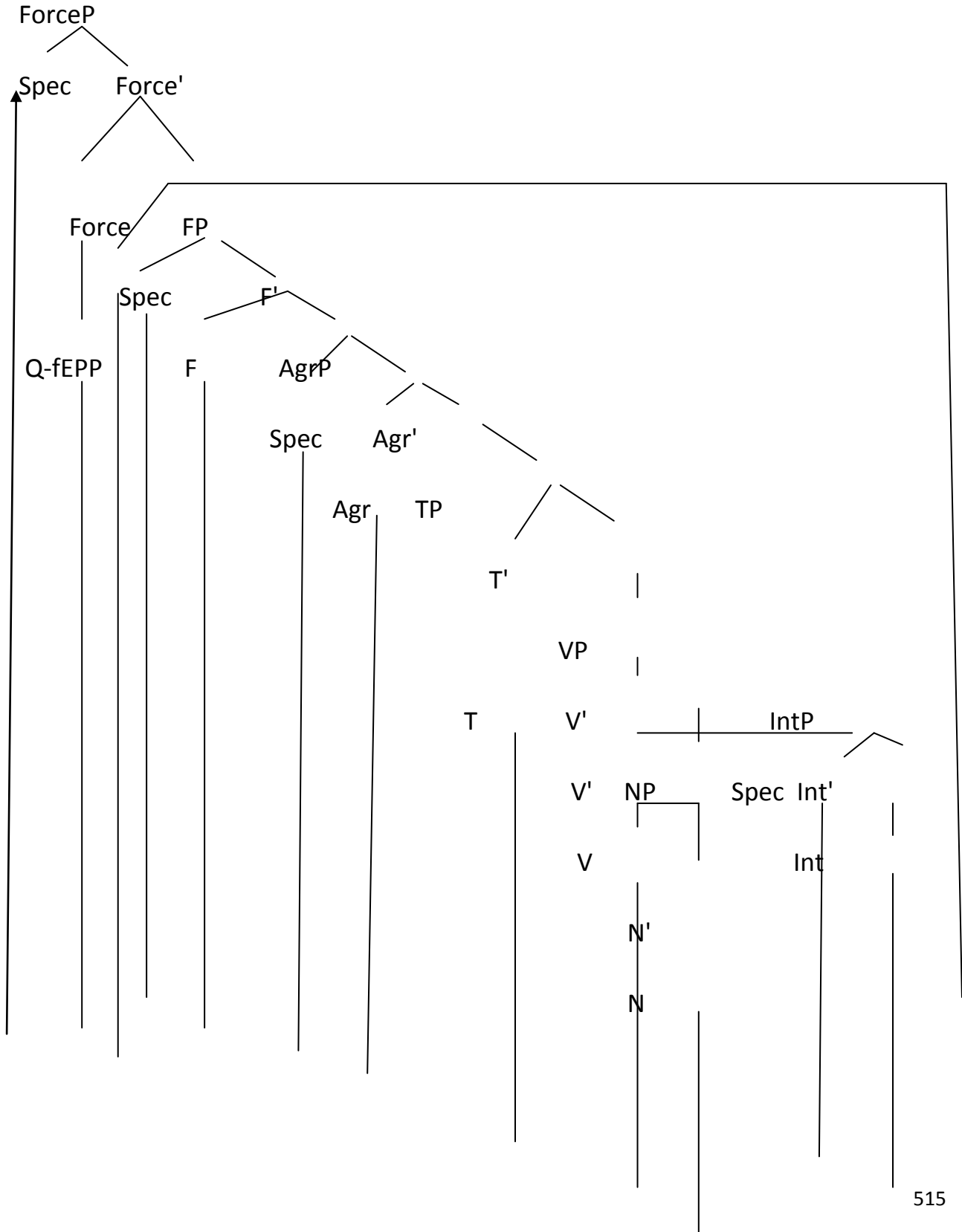

aa ate aye Puta a- ma fa nosi OP <aa>

So far it has been shown that *yee* and *aa* can co-occur in the same clause, while the presence of either one of them is enough for the construction to be interpreted a yes/no question. Moreover, *yee* cannot co-occur with a *wh*-phrase (focalized or not):

(138)

a. **yee* ate aye Puta a- ma- fa nosi

Q what Foc Puta SM P2 give mother

b. **yee* Puta a- ma- fa nosi ate

Q Puta SM P2 give mother what

The illicitness of the above sentences can be explained by the fact that a sentence cannot be both a yes/no question and a genuine question. These sentences therefore illustrate a case of feature saturation. Gabriela Soare's theory (2007) accounts nicely for these facts. She "suggest [s] a typology of question

morphological split between the Q-feature and the wh-feature. In addition to the distinction between the Q-feature and the wh-feature, [she] assume [s] universal overt/covert merge of a Q-particle in the left peripheral Focus head. Furthermore, the two features, Q and wh, on focus, have each a potential EPP-subfeature. It ensues that there are languages with syncretic Q- and wh-features and variation among them is explained in terms of the presence or absence of an EPP-feature. Similarly, other languages show a non-syncretic split head hosting the two features: the Q-feature, which is assumed to be responsible for clausal typing, is realized as a Q-particle, and the wh-feature on the Focus head, which enters into AGREE or AGREE + MOVE with the corresponding feature on the wh-phrase inside IP/TP [the clause]” (Soare, 2007:107-131).

Given the above theoretical apparatus, Tuki is a language with visible wh-movement (although it also allows wh-in-situ phrases) and endowed with a question particle. The following table adapted from Soare (2007:109) captures the Tuki facts:

	Q-feature	Wh-feature
+EPP/Agree+Move		

Coming back to the two ungrammatical sentences illustrated in (112), they are ungrammatical because they have a positive value for the two features, Q and Wh. It is a case of feature saturation: a clause cannot be both a yes/no question and a genuine question. Such constructions cannot satisfy the Principle of Full Interpretation (PFI).

Such a problem does not arise with the following sentence:

(139)

yee manya ama Puta a- ma- fa nosi (aa)

Q food Foc Puta SM P2 give mother Q

“Is it the food that Puta gave her mother?”

The Q-particle *yee* can co-occur with the focalized constituent (along with optional *aa* at the end) as long as the latter is not a focused wh-item. The sentence is rightly interpreted as a yes/no question since the Q-particle bears the feature +Q and the focalized NP bears the feature + foc, but not + Wh. It appears then that + Q is incompatible with +wh (at least in Tuki).

Now notice that a focused wh-item can cooccur with *aa* (in clause-final position) and the clause is still interpreted as a genuine direct question:

(140)

Tane owu Mbara a- m (a) enda na itutu aa

Where Foc Mbara SM P2 go with motorcycle Q

“Where did Mbara go with the motobyke?”

This sentence seems to constitute prima facie evidence that *aa* can fulfil two roles: either generate a yes/no question or be a question particle. When there is no wh-phrase, a sentence with *aa* is necessarily interpreted as a yes/no question:

(141)

Mamu o-ma- kusa tsono na mboo aa

You SM P2 buy clothes in market Q

“Did you buy clothes at the market?”

The Tuki clause containing both a *wh*-item and the morpheme *aa* is reminiscent of the situation that prevails in Japanese and Korean. Consider the following Japanese and Korean data borrowed from Bayer (2003) who quotes Sohn (1999), Hagstrom (1998) and Nishigauchi (1990):

(142) *Korean*

akasi-num [[[ku-ta mwues-ul mek-kess] -nya]-ko] mwulessta

waitress-TOP he-NOM what-Acc eat-want Q QUOT asked

“The waitress asked what he wanted to eat”

(143) *Japanese*

John – ga [[Mary -ga nani- o katta] ka sitteiru

John-NOM Mary -NOM what-Acc bought Q knows

“ John knows what Mary has bought”

(144) *Korean*

Bill –um [[[John-i wa- ss] –nya] –ko] mwulessta

Bill-TOP John-NOM come PAST Q QUOT asked

“Bill asked whether John had come”

The above data show that in Japanese and Korean, a *wh*-phrase or *whether* co-occur with a question particle. It sounds like Tuki, doesn't it? The following Tuki sentence is not structurally very different from (144) as far as the behavior of the Q morpheme is concerned:

(145) Viroo a- sesam ee ngi mangadzu a- mu-naata werete aa

Viroo SM asks that if child SM P1 climb tree Q

“Viroo wonders whether the child climbed the tree”

So, apart from the fact that the Q morpheme *aa* can induce a yes/no question interpretation, it behaves pretty much like the Japanese and Korean question particles.

In Biloa (1992, 1995), it is indicated that Tuki wh-phrases can freely stay in situ; visible wh-movement is optional. Now, just like in Japanese and Korean, wh-in-situ items co-occur with *aa* in Tuki:

(146)

a. Puta a- ma- kusa ate aa

Puta SM P2 buy what Q

“What did Puta buy?”

b. ate (aye) Puta a-ma- kusa aa

what did Puta SM P2 buy Q

“What did Puta buy?”

(147) (Gabriela Soare, 2007:110 (5))

John –NOM nari – o katta no?

John – nom what-Acc bought Q

“What did John buy?”

In analyzing (147), her (5), Soare (2007:110) states that “*no* is the overt realization of the Q-feature on the Focus head in the left periphery of the clause, which also

hosts a *wh*-feature. The *wh*-object *nani-o* “what” vacates the VP domain and so does the subject DP. A TP headed by the past tense morpheme *-ta* is assumed to be above [what she calls] SubjectP [which is AgrP]. Since the high T head has an associated EPP feature, the large constituent SubP containing the *wh*-phrase undergoes pied-piping to Spec TP, and is subsequently attracted into Spec Focus by the EPP on the Focus head”

(148) (Soare, 2007: 110, (6))

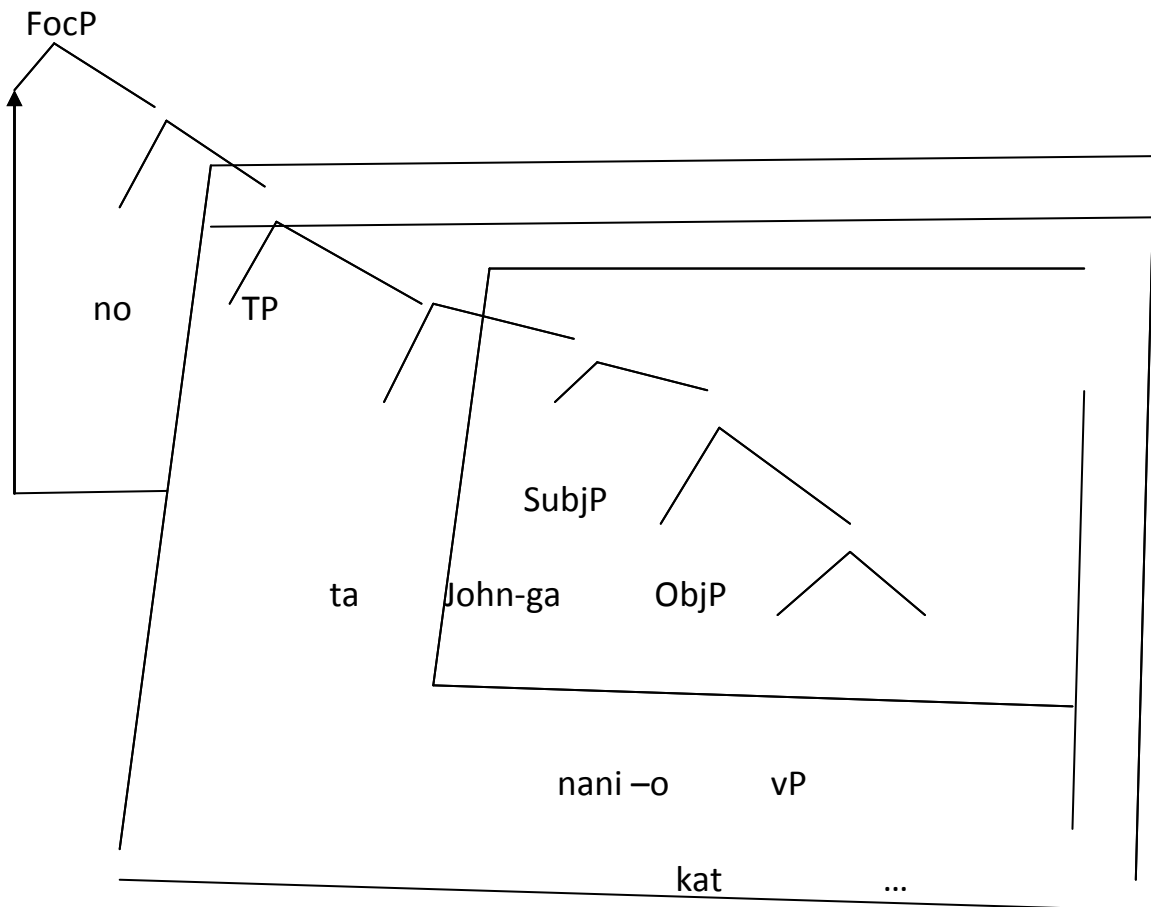

Coming back to Tuki, (146a) can be explained by moving at LF *aa* to the head of ForceP and pied-piping the rest of the clause to the Spec of ForceP.

(149)

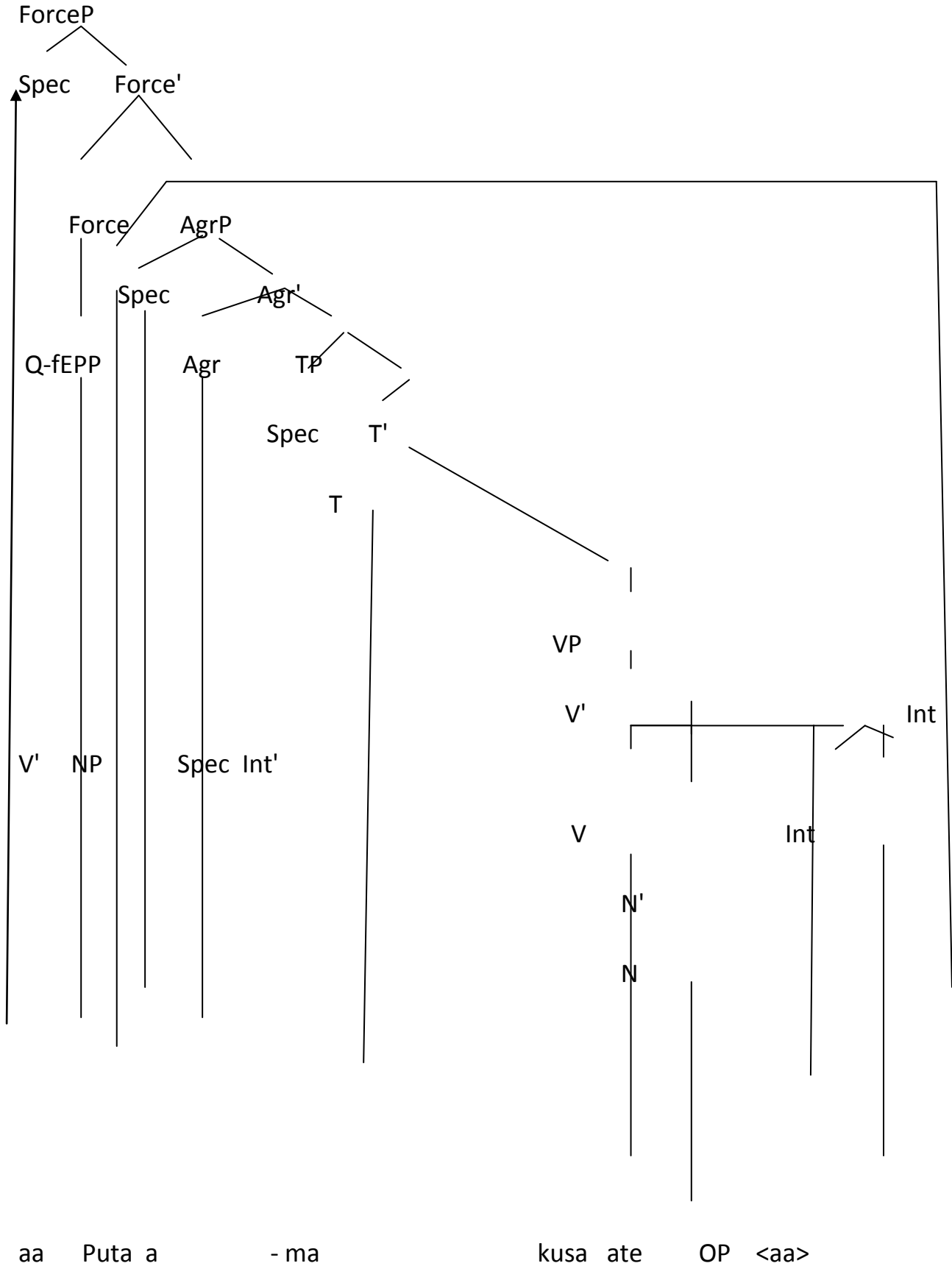

the derivation of (146b) will proceed exactly as the one in (139): the visibly moved wh-word is in the Spec of Focus Phrase, so *aa* raises to [F° , ForceP] while the rest of the clause substitute for [Spec, ForceP].

Partially summarizing, it has been argued in this subsection that *aa* can either generate a yes/no question or play the role of a question particle. Moreover, it has been claimed that it fills the position Spec of the IntP and the latter maximal projection can be recursive.

The presence of the Q morpheme *aa* in Tuki reminds us of Lisa Cheng's (1991) clausal Typing Hypothesis. Her hypothesis is accomplished either by wh-movement or by a question particle. Otherwise phrased, a language will have either wh-movement or a question particle. No language will have both or neither. Bruening (2007) has argued that her predictions cannot be correct since there is no direct relation between question particles and wh-in-situ, on the one hand, and wh-indefinites and wh-in-situ, on the other hand (Soare 2007:111). A language like Tuki in which both the Q-particle and wh-raising (wh-movement) are attested clearly violates Cheng's (1991) typology. Vata, a Kru language of the West African Republic, the Ivory Coast, carefully studied by Hilda Koopman (1984), also exhibits syntactic wh-movement as well as a clause-final Q-particle.

11.6. The position ‘Mod (ifier) P (hrase)’ in Tuki

In Tuki, adverbs can occupy a position in the left periphery of the clause and inside IP. In particular, since preposed adverbs may land in positions inside the C space, a structured theory of the latter space is needed.

First of all, even if the left peripheral adverbs apparently fill regular topic positions, Rizzi (2004b) shows that preposed adverbs do not behave, on interpretive grounds, like full-fledged topics. For example, in Italian, Rizzi says, a sentence with a topic (expressed via the Clitic Left Dislocation construction) is not felicitous in out-of-the-blue (or “what happened?”) contexts, whereas a preposed adverb is grammatically acceptable in such contexts. On the basis of data from Italian, Rizzi concludes that “a preposed adverb seems to have something in common with a topic, the fact of being made prominent by movement to the left periphery, but it does not share with the topic the necessary connection to the background, whence its compatibility with “what happened context”. Furthermore, preposed adverbs in the left periphery camp in positions that are distinct from topic positions. It is true in Italian as it is true in Tuki. In the latter language, a left peripheral adverb can dominate a topic, a focalized constituent; however, it cannot precede a wh-phrase:

(150) isimi, kuru, mutu a bwa a- mu-una

Quickly rat man of hunt SM P1 kill

“Quickly, it is the rat that the hunter killed”

(151) isimi, kuru adze Puta a- ma- namba

Quickly rat FOC Puta SM P2 cook

“Quickly, it is the rat that Puta cooked”

(152) *isimi, ate aye Puta a-ma-namba

Quickly what FOC Puta SM P2 cook

“Quickly, what did Puta cook?”

As stated above, Tuki adverbs can also fill IP- internal positions:

(153)

a. Puta a- ma – namba ngo isimi

Puta SM P2 cook chicken quickly

“Puta quickly cooked chicken”

b. Puta, isimi, a-ma-namba ngo

Puta quickly SM P2 cook chicken

“Puta, quickly, cooked chicken”

c.* Puta a-ma-namba isimi ngo

Puta SM P2 cook quickly chicken

Sentence (153c) is ungrammatical because the verb cannot assign the accusative case to the direct object complement due to the intervening presence of the adverb. In other words, the adjacency requirement is violated here. In this particular respect, Tuki functions like English.

Now, what position(s) do left peripheral adverbs occupy in embedded contexts? To answer this question, consider the following paradigm:

(154)

a. Mbara a- sesam ee ngi igere, tsono, na sove owu Viroo a-kutu-suwa

Mbara SM asks that if slowly clothes with soap FOC is Viroo SM prog. wash

“Mbara wonders whether slowly, clothes, with soap, Viroo is washing”

b. Mbara a- sesam ee ngi igere, na sove owu, tsono, Viroo a-kutu-suwa

Mbara SM asks that if slowly with soap FOC clothes Viroo SM prog wash

c.* Mbara a- sesam ee ngi igere ate aye Viroo a- kutu -suwa

Mbara SM asks that if slowly what FOC Viroo SM prog wash

It appears from the above data that a left peripheral adverb in a embedded context can precede and dominate an FP and a TopP but it can never do so with a wh-phrase. Moreover, it seems to be the case that TopP and FP can licitly dominate an adverb, as the following sentence clearly shows:

(155)

Mbara a- sesam ee ngi na sove owu tsono Viroo a-kutu-suwa

Mbara SM asks that if with soap FOC clothes Viroo SM prog wash

“Mbara wonders whether clothes with soap Viroo is washing”

All the examples illustrated above clearly show that the preposed adverb in the left periphery occupies a non-focal as well a non-topic position. The same reasoning applies to the IP- internal adverb.

Based on work in Italian, Rizzi (2004b) indicates that the adverb, be it preposed or IP-internal, occupies the specifier position of ModP (Modifier Phrase). This conclusion stems from his following “the usual restrictive theory of syntactic position” according to which “a phrasal slot can only arise as the Spec of head licencing the position”. This head is called “Mod (ifier)”. Adopting Rizzi’s theory, adverbs in Tuki substitute for the specifier position of ModP. In the left periphery of the clause, ModP may occur with TopP or FP: all these phrases fulfilling different roles and functions. This state of affairs notwithstanding, an adverb can also be focalized and fill the Spec of FP:

(156) isimi owu Puta a- ma – namba ngo idzo

Quickly FOC Puta SM P2 cook chicken yesterday

“It is quickly that Puta cooked chicken yesterday”

Given the integration of the left peripheral ModP position, the C system in Tuki stands to be restructured as follows:

(157)

RelP >ForceP> IntP > (ModP) >TopP >FP (ModP) > AgrP

or

RelP> ForceP> IntP > (ModP) >FP> TopP> (ModP) >AgrP

Conclusion

It has been shown in this chapter that in the Bantu language of Cameroun, Tuki, question formation as well as cleft constructions substitute (Wh) phrases for

the specifier position of a headed constituent focus phrase (called since Biloa 1992, 1995 FP). The head of Force Phrase (ForceP) is occupied by a lexical complementizer, *ee* “that”. A maximal projection dominating Force P hosts a null operator and an agreeing word in Tuki relatives: it has been called a Relative Phrase (RelP). Tuki topicalized constituents are said to substitute for the specifier position of Topic Phrase ([Spec, TopP]). The head of a position Interrogative Phrase can be occupied either by a special morphological marker that functions as a question morpheme (QM) or by an element which introduces either matrix or embedded yes-no questions. Another morpheme that occurs in clause-final position is said to generate yes/no questions and when it co-occurs with wh-phrases it plays the role of a question particle like in Japanese or Korean. It has been a Q morpheme and it has been argued to occupy the head of IntP, Int^o Tuki adverbs, on the other hand occur either in the left periphery or inside the clause. Based on Rizzi’s work and on Cinque’s (1999) analysis of adverbial positions, it is argued that these adverbs are licensed in the spec of a dedicated head called Mod and the latter can co-occur with Top or Foc in the left peripheral field of clauses.

CHAPTER TWELVE

Arguments, Adjuncts and Relativized Minimality

12.0. Introduction

In this chapter, we analyse the behavior of wh-arguments and wh-adjuncts in Tuki. More specifically, an attempt is made to explain why the presence of several wh-in-situ adjuncts in a clause does not cause any ECP violations. It is argued that at LF wh-phrases may adjoin to FocP(Focus Phrase) and adjunction being iterative (by definition), multiple adjunction to FocP is licensed. Since the hierarchy of adjunction is irrelevant for Rizzi's Relativized Minimality theory, from their adjoined positions several adjuncts can govern their variables.

12.1. Relativized Minimality

12.1.1. Definitions

Rizzi (1990) proposes a relativized version of the Minimality Condition first elaborated by Chomsky (1986). The two types of government which his system uses are defined as follows:

(1)

Head Government: X head-governs Y iff

- (i) X belongs to the set {A, N, P, V, Agr, T}
- (ii) X m-commands Y
- (iii) No barrier intervenes
- (iv) Relativized Minimality is respected

(2)

Antecedent Government: X antecedent-governs Y iff

- (i) X and Y are coindexed
- (ii) X c-commands Y
- (iii) No barrier intervenes
- (iv) Relativized Minimality is respected

Head governors are the lexical heads and some functional heads (at least functional heads containing the agreement and tense specification). Rizzi assumes that XP's which are not directly selected by [+V] elements are inviolable barriers.

Relativized Minimality is defined as follows:

(3)

Relativized Minimality:

X a-governs Y if and only if there is no Z such that

- (i) Z is a typical potential a-governor for Y,
- (ii) Z c-commands Y and does not c-command X.

The notion "typical a-governor" is defined in the following manner for the head government subcase:

(4)

Z is a typical potential head governor for Y=Z is a head m-commanding Y.

As for antecedent government, the notion “typical potential a-governor” is a property of chains. There are three subcases depending on the nature of chain:

(5)

a. Y is a trace in an A-chain (NP movement)

b. Y is a trace in an A'-chain (wh movement)

c. Y is a trace in an X⁰-chain (head movement)

given that there are three subcases of antecedent government, the notion “typical potential a-governor” varies accordingly:

(6)

a. Z is a typical potential antecedent governor for Y, Y in an A-chain=Z is an A specifier c-commanding Y.

b. Z is a typical potential governor for Y, Y in an A'-chain=Z is an A' specifier c-commanding Y.

c. Z is a typical potential antecedent governor for Y, Y in an X⁰-chain=Z is a head c-commanding Y.

In section 8.2 and subsequent sections, we will see how the system devised by Rizzi works with regard to Tuki wh-constructions.

12.1.2. The Referentiability Principle and the ECP

Focusing on argument/adjunct asymmetries, Rizzi argues that the notion of “referentiability” should be defined in terms of Theta-Theory. It is observed that arguments are assigned a theta role whereas adjuncts are not assigned a theta role. Moreover, only elements bearing a referential theta role can be raised out of a wh-island; elements assigned a nonreferential theta role cannot be extracted from a wh-island.

In view of the above constructions, Rizzi proposes a principle; let us call it the Referentiability Principle:

(7)

The Referentiability Principle:

A referential index must be licensed by a referential theta role.

The above principle captures the fact that all arguments carry a referential theta role. Every argument carrying a referential theta role is assigned a referential index at D-structure. When the argument is raised to a higher position, it carries its index along. The relationship that obtains between a raised argument and the variable it has left behind is a binding relation which, in turn, is defined in terms of the notion of referential index:

(8)

X binds Y iff

(i) X c-commands Y

(ii) X and Y have the same referential index.

The Referentiability Principle restricts binding relations to elements bearing theta roles. This restriction subsumes the essential effect of the identification clause of the ECP and properly captures the fundamental argument-adjunct asymmetries:

(9)

ECP: a nonpronominal empty category must be:

- (i) Properly head-governed (formal licensing)
- (ii) Theta-governed, or antecedent-governed (identification)

Since the Referentiability Principle subsumes the identification clause of the ECP, the latter principle is reduced to its formal licensing requirement:

(10)

ECP: A nonpronominal empty category must be properly head-governed.

Binding will regulate the relationship between an extracted argument and its variable, whereas government will connect an adjunct and its variable. Binding can be arbitrary while government is intrinsically local.

Consider the following sentence:

(11)

How do you think [t' that [we can solve the problem t]]

(11) shows that long – distance extraction of an adjunct from a declarative is acceptable. In (11) *how* governs *t'* and the latter item governs *t*. Notice that *how*, *t'* and *t* form a chain. A chain is defined by Chomsky (1986) as follows:

(12)

(a_1, \dots, a_n) is a chain only if, for $1 \leq i < n$, a_i antecedent-governs a_{i+1} .

Recall that since adjuncts are not assigned any theta role, they cannot bear an index. This implies that any definition of antecedent government that is meant to apply to adjuncts must get rid of co-indexation. To achieve that goal, Rizzi proposes a global nondistinctness requirement:

(13)

X antecedent – governs Y iff

- (i) X and Y are nondistinct
- (ii) X c-commands Y
- (iii) No barrier intervenes
- (iv) Relativized Minimality is respected

Thus, in this system there are two (nonexclusive) ways to connect an operator and its variable; binding links arguments and their traces whereas government links an adjunct and its variable. While binding requires identity of referential indices, government may take place either directly (direct government of a trace by an “antecedent operator”) or through a sequence of government relations (the use of intermediate traces).

Next, we turn to an examination of wh-constructions in Tuki.

12.2. That-Trace Effects in Tuki

WH-elements in Tuki do not exhibit any subject/object asymmetry, therefore they are immune to COMP-trace effects:

ándzu_i [IP Mbárá údzám [CP x_i ée [IP Díma a- má- dínga x_i]]]

who Mbara says that Dima SM P2 love
 “who does Mbara say that Dima loved?”

(15)

a. ándzu_i [IP Mbárá údzám [CP x_i ée [IP x_i a- nambám cwí x_i]]]

who Mbara says that SM cooks fish

“who does Mbara say that cooks fish”

b. mutu ódzu_i nga-t- ídzima ngi x_i a- nu- áram námbari
 man who SM Neg know if SM fl come tomorrow

“a man that I do who I do not know if will come tomorrow”

d. Okutu ódzu_i nga- t- ídzima ate x_i a- m- údza
 Woman who SM neg know what SM p1 say

“the woman who I don’t know what said”

The lack of COMP-trace effects in Tuki is expected under the assumption that the language is a null subject one (for details see the preceding chapter). Since Perlmutter (1971), it has become customary to assume that pro-drop languages do not exhibit any subject-object asymmetries in cases of extraction across an overt complementizer. Thus Italian subjects are freely extractable across declarative and interrogative complementizers:

(16)

(Rizzi (1990)’s (94))

a. Chi credi che abbia telefonato?

“who do you think that has telephoned?”

b. Un uomo che non so se ci potrà aiutare

“ a man that I don’t know if will be able to help us”

c. L’uomo che non so che cosa abbia detto

“the man who I don’t know what said”

Rizzi (1982a, chapter4) suggested that the property of free extraction of the subject over a phonetically realized complementizer is a consequence of free inversion of the subject. In tensed clauses the subject can occur in postverbal position:

(17)

(Rizzi’s (95))

a. Credo che abbia telefonato Gianni

“I think that has telephoned Gianni”

b. Non so se ci potrà aiutare Gianni

“I don’t know if will be able to help us Gianni”

c. Non so che cosa abbia detto Gianni

“I don’t know what has said Gianni”

The idea that subjects are freely extractable across declarative and interrogative complementizers because the subject can be placed in postverbal position has been substantiated by an overwhelming bulk of empirical material (Rizzi 1982a; Jaeggli 1982; Kenstowicz 1984; Safir 1985; Burzio 1986; Raposo 1988; Brandi and Cordin 1981, 1989).

When the subject occurs in postverbal position in those languages that license free inversion, it is adjoined to VP and the preverbal position is occupied by an expletive *pro*:

(18)

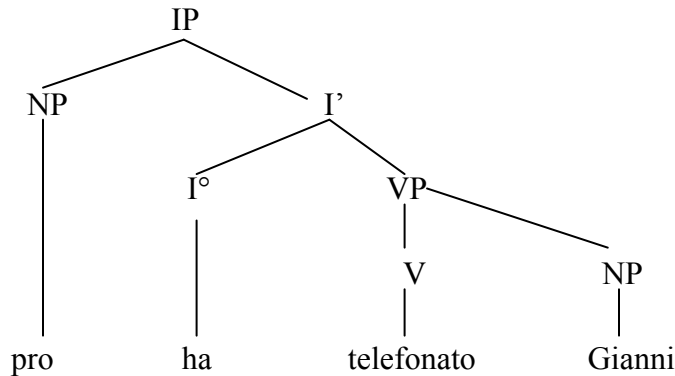

Rizzi assumes that the postverbal position is properly governed by Infl (T° in the articulated sentential structure proposed by Chomsky (1988) and Pollock (1989)). Consequently, a trace is well formed in this position in the case of subject extraction.

Coming back to Tuki, this language does not allow free inversion of the subject:

(19)

a. * Nû m- búnganám ée a- má- gwa Putá
 I SM think that SM p2 die Puta

“I think that Puta died”

b. * nû nga t- ídzima ngi a- fitím o- su- áka Isomo
 I SM Neg know if SM can inf. marker us help Isomo

“I don’t know if Isomo can help us”

c. * Nu nga- t- ídzima ate a- m- údza Mbára
 I SM Neg know what SM p1 say Mbara

“I don’t know what Mbara said”

Since free inversion of the subject is strictly disallowed in Tuki, it cannot be appealed to in order to explain free extraction of the subject across an overt complementizer. Recall that we said in the previous chapter that Tuki licenses *pro* in subject position because *Agr-s* is a proper governor in the language.

(20)

a. Díma a- tá- a- kúsa matúwa
 Dima SM Neg p1 buy car

“Dima did not buy a car”

(b) *pro* a- tá- a- kúsa matúwa
 SM Neg p1 buy car

“he/she did not buy a car”

The tree structure representation of (20b) is the following:

(21)

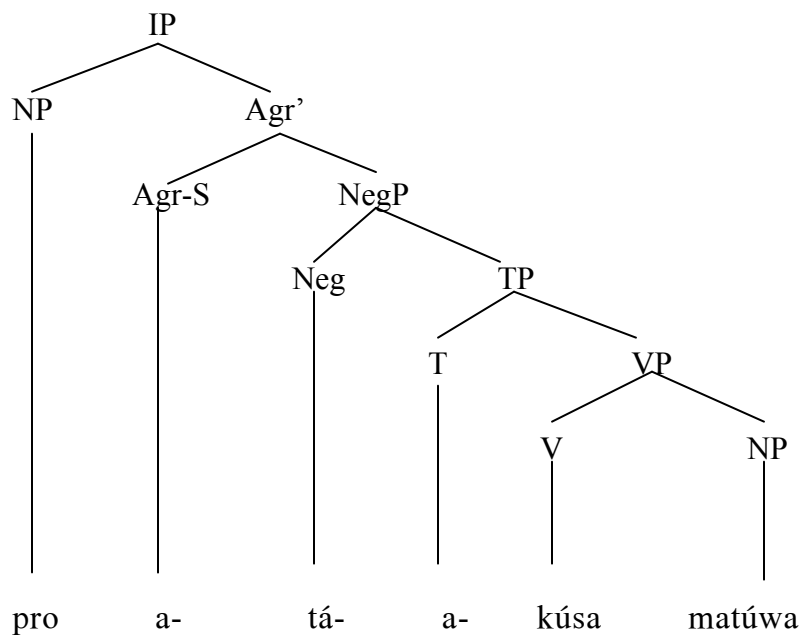

In (21), Agr-S case – governs *pro*; better it properly head-governs *pro*, thereby licensing the occurrence of the latter empty category. Now we can appeal to this explanation to account for the free extractability of Tuki subjects across declarative and interrogative complementizers. We will say that Tuki is immune to COMP-trace effects because the variable created by *wh*-extraction in subject position is properly governed by Agr-S. In *Relativized Minimality* terms, Agr-S properly head-governs the variable in subject position. This conclusion apparently runs counter to Rizzi’s prediction that a trace must be head-governed “within the immediate projection of the head”, that is governed “within the immediate projection of the head”, that is “governed by X° within X ”. In (21), we would expect Agr-S to head –govern *pro* within Agr’. But this is clearly not the case since Agr-S head-governs the specifier position of IP. Notice, however, that Rizzi’s prediction is not entirely wrong since it is borne out in the case of object extraction. Consider the phrase marker (14):

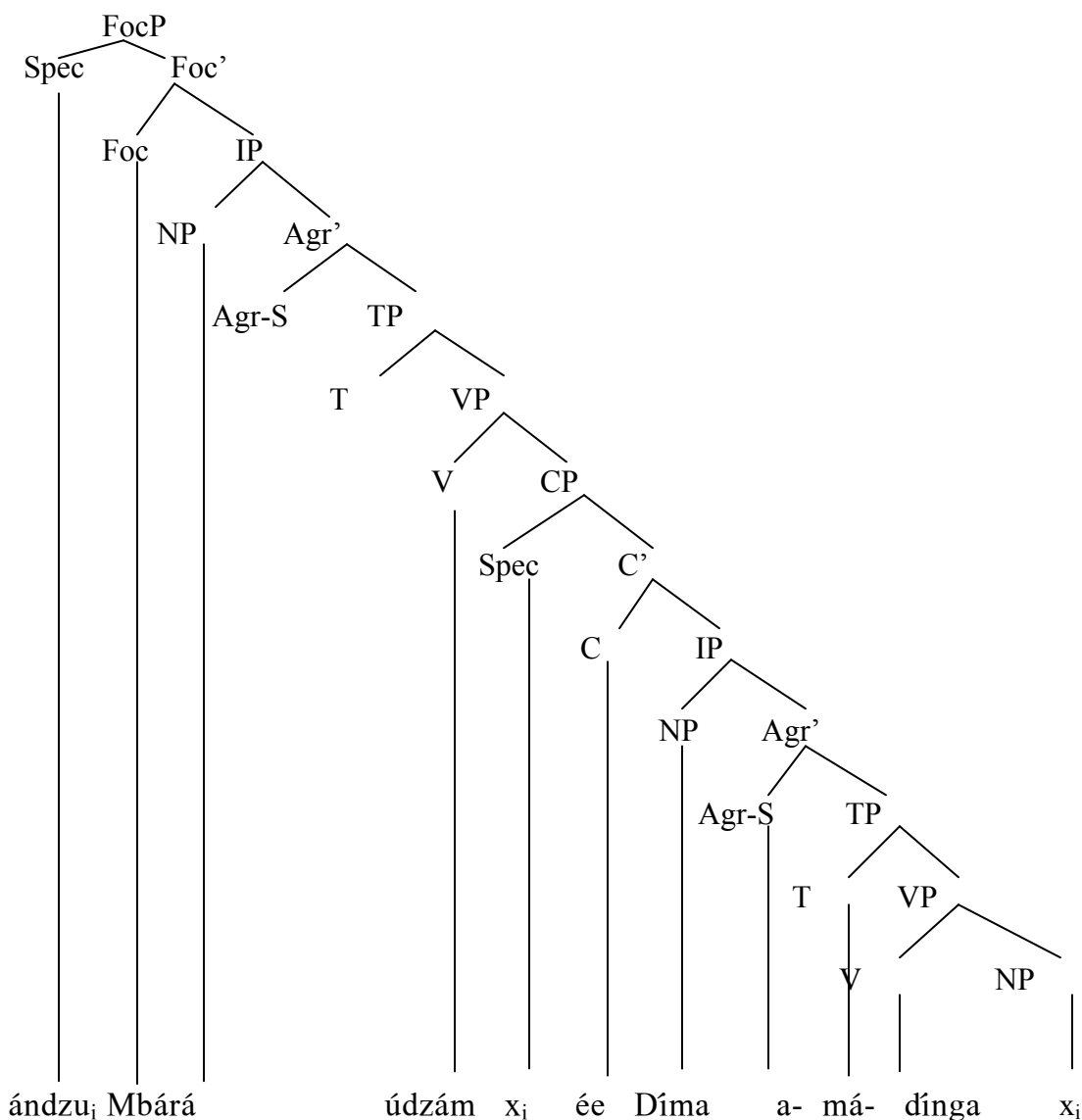

in (22), V properly head-governs the object NP within V'. Thus we have an asymmetry with respect to how head-government is achieved in this language in cases of subject extraction and object extraction: in one case X° properly governs outside X', while in another X° properly governs within X'. This state of affairs is not entirely surprising since in the latter case V directly selects the object and therefore the object is an internal argument whereas in the former case the specifier of IP is an external argument. It seems to be the case that the head-government requirement on traces must take into account the fact that complements and specifiers differ in the way they are selected by their potential governors.

It could be argued that the cases of subject extraction examined so far are ruled in because antecedent-government obtains through a sequence of government relations. Thus in the following sentence:

(23)

ándzu_i o- bungánám [t'_i ée [t_i a- m- énda]]
Who SM think that SM p1 go

“who do you think that left?”

ándzu_i “who” governs t'_i and the latter t_i since *ee* “that” does not hinder the c-command relation in structures such as the one below:

(24)

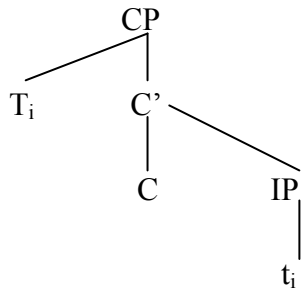

Bear in mind that the presence of *ee* is compulsory in (23). Although antecedent-government seems to obtain in (23) because the c-command connection is not broken, there is no need to assume that it rescues (23). It seems to be the case that (23) would have been grammatical with or without antecedent – government obtaining. This is evidenced by the fact that in the case of subject topicalization across an overt complementizer, although the c-command relation cannot be established and antecedent-government cannot obviously be appealed to, the construction is licit.

(25)

Isómo_i, nu n- tsétsám ngi x_i a- má-kúsa nanga
Isomo I SM ask if SM p2 buy house

“Isomo_i, I ask whether X_i bought a house”

(25) is uniquely salvaged by proper head government of x_i by Agr-S.

More evidence that all extractions from subject position in this language are acceptable is provided by the following two constructions:

(26)

a. ándzu_i o- kambím ngi x_i a- fitím wúna ngó
who SM astonish if SM can kill a panther

“who do you wonder whether can kill a panther?”

b. ándzu_i o- kambím ngi tu- bungánám ée x_i a- fitím wúna ngó
who SM astonish if SM think that SM can kill a panther

“who do you wonder whether we think that can kill a panther?”

In the two examples provided above, Agr-S licenses the variable in subject position.

Next, we turn to the behavior of Wh-in-situ elements.

12.3. The syntax of wh-in-situ in Tuki

Up to now we have concentrated on the behavior of extracted wh-phrases in Tuki. Thus we have essentially analysed wh-movement at S-structure in this language. This language,

however, exhibits wh-movement at another level of representation, namely Logical form. In the following pages, we would like to look at the syntax of wh-phrases in situ, that is wh-phrases that have remained in their base position and have not undergone raising in the syntax.

It is well known that some languages exhibit syntactic wh-movement while others do not. Thus for the most part, English is one of those languages which allows wh-movement in Syntax, whereas Chinese and Japanese license wh-movement in Logical Form (Huang (1982), Lasnik and Saito (1984)). However there is no clear-cut dichotomy between languages like English and languages like Chinese. English, for instance, is known to exhibit LF wh-movement in some circumstances (cf. Baker (1970)) and Chinese has been claimed by Pau-San HOH and Wen-yu Chiang (1990) to move wh-phrases at S-structure. Still English and Chinese are radically different in many instances with respect to wh-extraction. It is fairly established that content question formation in English uses wh-in-situ only under certain conditions (such as echo questions or multiple interrogation) and syntactic wh-movement is not a genuine strategy in Chinese (in fact wh-phrases are syntactically extracted in Chinese only when they are clefted (cf. Hoh and Chiang (1990)).

In what follows, we will present abundant data that show that wh-in-situ phrases participate in genuine content question formation in Tuki. More specifically, we will show that this language licenses the occurrence of multiple wh-arguments and wh-adjuncts in situ. Interestingly, the presence of wh-adjuncts in a clause raises pertinent questions about the satisfaction of the Empty Category Principle. We will argue that at LF wh-phrases can adjoin to FocP in this language and since adjunction may be a recursive operation, nothing rules out multiple adjunction to FocP, from which position several adjuncts can identify their traces. This approach seems to be warranted by the fact that traditional analyses such as the COMP Indexing algorithm or an approach that essentially assumes substitution to a maximal projection at LF fails to accommodate the Tuki empirical material. We will start by describing the data in detail, then we will account for the behavior of wh-in-situ items in this language.

12.3.1. Movement to CP at LF?

Before we turn to the description of the Tuki empirical material we need to address the issue of where exactly wh-phrases land at LF. We have argued extensively above that wh-phrases move into the [spec, FocP] at s-structure in some Bantu languages. The question of much theoretical relevance is “what happens at LF? Does a wh-element in FocP move to CP? Does a wh-in-situ element raise to CP or FocP at LF? “Aoun, Hornstein, and Sportiche (1981) suggest that LF movement takes the form of the syntactic rule of wh-movement. In other words, LF movement must be movement into COMP. this means that for the Duala and Tuki cases, although syntactic wh-movement is substitution to FocP, LF wh-movement may involve movement into CP. There is considerable crosslinguistic evidence that Aoun, Hornstein, and Sportiche are right (see also Catherine Rudin (1988)). Huang (1982), for instance, has shown that LF wh-movement cannot be adjunction to IP, in a way analogous to QR (May 1977, 1985). For if wh-movement at LF could function as Quantifier Raising, one would expect wh-phrases to have NP-internal scope, given that QR has the two adjunction sites IP and “sister of QP”. Consider the following Chinese sentence from Huang:

(27)

*Zhangsan mai-le neiben shei de shu
buy-ASP that who DE book

“*who did Zhangsan buy that book of?”

(Huang’s (194),pp. 266)

Huang concludes that if wh-words were allowed to have NP-internal scope, it would be impossible to disqualify the above sentence. Consequently, wh-words must always have sentential scope. To satisfy that requirement, wh-words must move to COMP at LF. Huang observes that since NPs for instance are devoid of COMPs, and sentences have them, wh-words may have only sentential scope.

In the following two sentences, *what* (or *who*) moves from the [Spec, FocP] position to a higher position in the matrix clause at LF, thereby explaining its wide scope reading:

(28)

a. *Tuki*

Mbárá a- bungánám [ée [ane[ódzu [Putá a- má- băna t]]]]

Mbara SM thinks that who FOC Puta SM P2 marry

“Who does Mbara think that Puta married?”

b. *Duala*

Dikoso a- ndongele [na [nje [Kinge a- bodi no t Kuo]]]

Dikoso SM thinks that what Kinge SM give Kuo

“what does Dikoso think that Kinge gave Kuo”

Thus at LF the wh-phrase raise to a higher position in the matrix clause. What position is it? Recall that in Tuki and Duala, FocP occurs between CP and IP. Now if we assume that the wh-phrases went to CP, then we have to posit that they traveled through FocP, as illustrated below:

(29)

a. *Tuki*

[CP ane ódzu [FocP t’][IP Mbárá a- bungánám[CPt’ éé[FocP t’[Putá a- má- băna t]]]]]

b. *Duala*

[CP nje [FocP t’][IP Dikoso a- ndongele [CP t’ na [FocP t’[Kinge a- bodi no t Kuo]]]]]

In the two LF representations exhibited above, the wh-phrases have to go to the matrix CP and therefore have scope over the entire sentence. Now we have to wonder whether movement to the higher CP through the higher FocP is warranted, for were the wh-items to stop at the matrix FocP, they would still have a wide scope reading:

(30)

a. *Tuki*

[FocP ane ódzu [IP Mbárá a- bungánám [CP t’ éé [FocP t’[IP Putá a-

má- băna t]]]]]

b. *Duala*

[FocP nje [IP Dikoso a- ndongele [CP t'na [FocP t'[IP kinge a- bodi no t Kuo]]]]]

In the above LF representations, the wh-phrases that have raised to the matrix FocP have a wide scope interpretation, much in the same way as in the representations that allow movement to CP through FocP. Now we have to choose between the two derivations. Both seem to produce the same results (in terms of scope interpretation at least). In the spirit of economy of derivation and representation (cf. Chomsky (1989)), it appears that an LF derivation that licenses movement of wh-phrases to the higher FocP is maximally less superfluous than one that allows raising to a higher CP through FocP and has to account for the intermediate trace(s) that are left in FocP. We therefore conclude that at LF wh-phrases in Tuki (and Duala) travel to FocP for scope reasons. This result strengthens the parallelism between Tuki and English in terms of the landing site of wh-movement. In English, wh – phrases move to CP in syntax or in Logical Form. In Tuki, wh-phrases raise to FocP in Syntax or Logical Form. In the following pages, we will stick to the latter conclusion.

12.3.2. Simplex Clauses: Wh-In-Situ

12.3.2.0. Simple Questions

Syntactic wh-movement is not compulsory in Tuki as evidenced by the behavior of wh-operators in the following sentences:

(31)

a. Putá a- má- namba ate
puta SM P2 cook what
“what did Puta cook?”

b. Mbára a- má- fá ane manyá
Mbara SM p2 give who food
“who did Mbara give food?”

c. Díma a- mu- nóba agee wáá owáte
Dima SM p1 beat wife his why
“why did Dima beat his wife?”

d. Díma a- mu- fénda matúwa twí
Dima SM p1 repair car how
“how did Dima fix the car?”

e. Mwána wóó a- n(û)- éndam ná sukuru ni?
Child your SM F1 go to school when
“when will your child go to school?”

f. Mbára a- má- kúsa tsonó ráá tané?
Mbara SM p2 buy clothes his where

“where did Mbara buy his clothes?”

12.3.3. Multiple questions

12.3.3.1. Arguments

Wh-in-situ phrases are allowed in multiple interrogation in Tuki. In the following examples, object arguments have not moved at S-structure:

(32)

a. áné ódzu a- m(u)- úna ane?
Who FOC SM p1 kill who
“who killed who?”

b. áné ódzu a- m(u)- íbá ate?
Who FOC SM p1 steal what
“who stole what?”

12.3.3.2. Multiple questions with adjuncts

Wh-adjuncts as well as wh-arguments can remain in situ in multiple questions:

(33)

a. áné ódzu a- má- fénda ate twí ?
who FOC SM p2 repair what how
“who fixed what how?”

b. áné ódzu a- má- noba ane owáte?
Who FOC SM p2 beat who why
“who beat whom why?”

12.3.3.2. Double adjuncts questions

This language allows constructions in which two adjuncts occur in situ:

(34)

a. áné ódzu a- má- noba agéé wáá twí ni?
Who FOC SM p2 beat wife his how when
“who beat his wife how when?”

b. Díma a- má- noba áné twí ni?
Dima SM p2 beat who how when
“who did Dima beat how when?”

12.3.4. Wh-in-situ phrases in embedded contexts

In the following sentences, a wh-word appears in subject position of a subordinate clause:

a. Mbárá a- sesám ée áné ódzu a- má- kúsá tsónó?
Mbara SM asks that who FOC SM P2 buy clothes
“Mbara asks who bought clothes?”

b. Mbárá a- bungánám ée áné ódzu a- má kúsá tsónó?
Mbara SM think that who FOC SM p2 buy clothes

“who does Mbara think that bought clothes?”

- c. Mbárá ídzimám ée áné ódzu a- má- kúsá tsónó?
Mbara knows that who FOC SM P2 buy clothes

“Mbara asks who bought clothes?”

- a. “who does Mbara know bought cloths?”
b. “Mbara knows who bought clothes?”

In the following examples, a wh-in-situ occurs in object position:

(36)

- a. Mbárá a- sesám ée Putá a- má kúsa ate?
Mbara SM asks that Puta SM P2 buy what

“Mbara asks what Puta bought”

- b. Mbárá a- bungánám ée Puta a- má kúsa ate?
Mbara SM think that Puta SM p2 buy what

“what does Mbara think that Puta bought?”

- c. Mbárá ídzimám ée Putá a- má kúsa ate?
Mbara knows that Puta SM p2 buy what

- a. “what does Mbara know Puta bought?”
b. “Mbara knows what Puta bought?”

12.3.5. Multiple Questions with Wh-in-situ

We can have multiple interrogations in embedded contexts in Tuki:

(37)

- a. Mbárá a- má- sesá Putá ée áné ódzu a- má- wúba áné
Mbara SM p2 ask Puta that who FOC SM P2 hit who

“Mbara asked Puta who hit who?”

- b. Mbárá a- má- sesá Putá ée Díma a- má- fá áné ate
Mbara SM p2 ask Puta that Dima SM P2 give who what

“Mbara asked Puta what Dima gave to who?”

Wh-in-situ adjuncts can occur in subordinate clauses as well:

(38)

- a. Mbárá a- má- sesá Putá ée áné ódzu a- má- fendá matúwa twi
Mbara SM p2 ask Puta that who FOC SM P2 repair car how

“Mbara asked Puta who fixed the car how?”

- b. Mbárá a- má- sesá Putá ée áné ódzu a- má- fendá ate twi
Mbara SM P2 ask Puta that who FOC SM P2 repair what how

“Mbara asked Puta who fixed what how?”

- c. Mbárá a- má- sesá Putá ée áné ódzu a- má- fendá matúwa twi ni
Mbara SM P2 ask Puta that who FOC SM P2 repair car how when

“Mbara asked Puta who fixed the car how?”

12.4. Wh-in – situ and the ECP

Next we attempt to account for the behavior of wh-in-situ in this language. It is generally assumed that wh-in-situ elements raise at LF to a higher position from which they can govern their traces. Thus in the following Tuki sentences:

(39)

John endámtá
John goes where
“where does John go”

The adjunct *tá* “where” raises at LF to a higher position (let us assume that it is FocP in Tuki). When FocP is occupied by a wh-element, it is indexed after this one (assuming the application of the COMP Indexing mechanism proposed by Aoun, Hornstein and Sportiche (1981), thus FocP can antecedent govern the trace left by the adjunct. Now consider the following question:

(40)

áné ódzu a- m(á)- énda owáte
who FOC SM p2 go why
“who left why”

How could the COMP Indexing approach handle this grammatical Tuki construction? We would expect the above construction to be ungrammatical but it is not. At LF *áné* “who” first moves to Spec of FocP, thus FocP should have the index of *áné*. When *owáte* “why” raises to FocP, the latter already has an index. Consequently the trace left by *owáte* will not be antecedent governed and an ECP violation should follow. The COMP Indexing approach can be salvaged if we assume that the trace of *áné* moves vacuously and is therefore in situ, this would allow *owáte* to move first at LF and give its index to FocP.

It has been proposed by Aoun, Hornstein, Lightfoot and Weinberg (1987) that the COMP Indexing can apply freely irrespective of which wh-item moves to COMP first. Their proposal could easily account for (40). But while all the various applications of the COMP Indexing mentioned above can indeed account for (40), they will have a hard time with sentences in which several adjuncts remain in their base position. One such sentence is given below for ease of exposition:

(41)

Mbárá a- sesám Putá ée áné ódzu a-má- fendá itútú twí owáte
Mbara SM asks Puta that who FOC SM p2 repair motorcycle how why
“Mbara asks Puta who how why fixed the motorcycle?”

We have shown above that double adjunct wh-phrases are possible in simple questions as well as subordinate questions. (41) is extremely annoying for the COMP Indexing approach for even if we assume that *áné* “who” does not raise first to FocP and that indexing takes place in

this language at LF, at which level wh-in-situ adjuncts are supposed to raise, FocP can only have one index and there are two traces that require antecedent government (the traces of *twí* ‘how’ and *owáte* ‘owate’). So how can we reasonably account for the grammaticality of (41)? One can posit that at LF wh-phrases can adjoin to FocP in this language, and since adjunction is essentially a recursive operation one can obtain multiple adjunction of wh-phrases to the embedded FocP. Under this analysis, (41) will have the following LF representation:

(42)

Mbárá a- sesám Putá éé [_{FocP} twí_i [_{FP} owáte_j [_{FocP} áné ódzu a-má- fendá itútú x_i x_j]]]]

In (42) the original traces of the adjuncts *twí* ‘how’ and *owáte* ‘why’ are antecedent governed by the FocP adjoined adjuncts. In this derivation, there is no need to posit any ordering of wh-phrases after extraction at LF (we will come back to this problem shortly).

Now the question of much theoretical interest is whether in Tuki a wh-item in an embedded context can take scope over embedded clause. In this respect, is there any asymmetry between wh-arguments and wh-adjuncts? To answer this question, we need to look at two sets of example sentences:

(43)

a. Mbárá a- sesám Putá éé áné ódzu a- má- nobá áné
Mbara SM asks Puta that who FOC SM P2 beat who
‘Mbara asks Puta who beats who?’

b. Mbárá a- sesám Putá éé Díma a- má- fá áné ate
Mbara SM asks Puta that Dima SM P2 give who what
‘Mbara asks Puta what Dima gave to who?’

(44)

a. Mbárá a- má- sesá Putá éé áné ódzu a- má- fendá matúwa twí
Mbara SM P2 ask Puta that who FOC SM P2 repair car how
‘Mbara asked Puta who fixed the car how?’

b. Mbárá a- má- sesá Putá éé áné ódzu a- má- fendá ate twí
Mbara SM P2 ask Puta that who FOC SM P2 repair what how
‘Mbara asked Puta who fixed what how?’

In (43a), either of the wh-items can be interpreted as having wide scope, with the other embedded wh-item as having a narrow scope reading. Thus (43a) can have one of these two readings:

(45)

a. ‘who is the X such that Mbara asks Puta who X beat?’

b. ‘who is the X such that Mbara asks Puta who beat X?’

thus (43) reveals that wh-arguments that occur in an embedded context can be construed as having a matrix scope reading. At LF when the wh-subject raises to the matrix A’-position in

(43.a), its trace is properly governed by INFL, whereas the trace left by the extraction of the wh-object is lexically governed by the verb.

As for the two sentences exhibited in (44), they are all unambiguous. In (44a), only the wh-word *ane* “who” can have matrix scope while the scope of the adjunct *twi* “how” is reduced to the embedded clause. Thus (44a) can be a direct question on *ane*, but it can only be an indirect question on *twi*. The same reasoning applies to (44b): *ane* “who” and *ate* “what” can be each construed as having a wide scope interpretation whereas *twi* can only be assigned a narrow scope reading. In sum, the generalization seems to be that when a wh-argument and a wh-adjunct occur in the same embedded context, the argument is more likely to have a matrix scope reading than the adjunct. So far we have considered *ane* “who” and *twi* “how”. Consider this time *ate* “what” and *owate* “why”:

(46)

Mbárá a- má- sesá Putá ée Putá a- mu- será ate owáte
 Mbara SM p2 ask Puta that Puta SM p1 sell what why
 “what is the thing X such that Mbara asks why Puta soldX?”

Not surprisingly, in (46) *ate* can have a matrix scope interpretation while *owáte* cannot. Thus matrix scope for Tuki embedded adjuncts is ruled out. This is clearly reminiscent of the Chinese type ECP effects for adjunct-argument asymmetries (cf. Huang (1982)).

12.5. LF adjunction and Relativized Minimality

We argued above that to account for the grammaticality of sentences such as (41), we have to allow multiple adjunction of wh-phrases to FocP at LF with the proviso that the order of adjunction not be constrained. For ease of exposition, let us illustrate a relevant example and its LF representation:

(47)

Mbárá a- sesám Putá ée áné ódzu a- má- ibá tsonó ráá twí owáte
 Mbara SM ask Puta that who FOC SM p2 steal clothes his how why
 “Mbara asked Puta who how why stole his clothes?”

(48)

LF representation of (47)

Mbárá a- sesám Putá [_{CP}éé [_{FocP}twí_i [_{FocP} owáte_j [áné ódzu_x a- má- ibá tsono ráá x_i x_j]]]]]

One has to make sure that in (48), *owate* for instance does not block antecedent government between *twi* “how” and its trace. Does necessarily this situation warrant a reformulation of Rizzi ‘s theory of Relativized Minimality? Not necessary since for Rizzi adjoined positions are not potential governors. Thus in the following configuration:

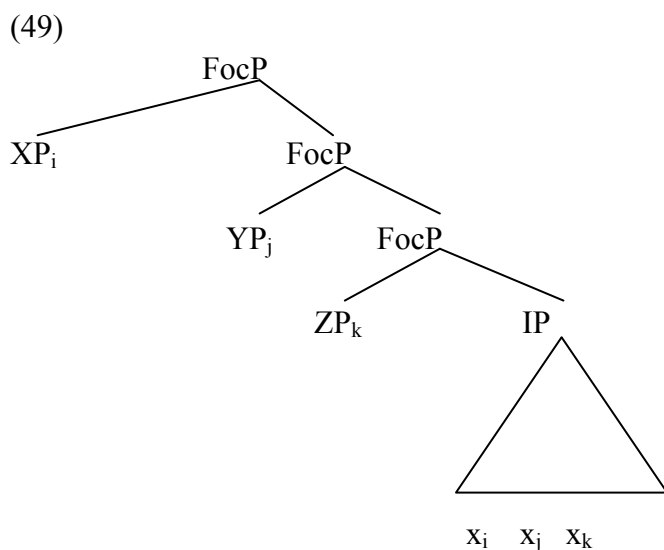

YP is not a potential A-bar binder for the trace of XP in Rizzi's theory. This correctly accommodates our perception that the hierarchy of adjunction is irrelevant at LF (see however Anoop Kumar Mahajan (1990) who shows that in Hindi adjoined phrases can count as potential governors except when they are included in the same maximal projection).

12.6. Superiority

Chomsky (1973) notes the following subject/object asymmetry:

(50)

Who_i [_i saw what]

(51)

*what_i [did who see x_i]

Such effects seem to be nonexistent in Tuki, since the equivalent of (51) is grammatical:

(52)

ate_i (áye_i) [áné a- m- éna x_i]

what FOC who SM P1 see

“what did who see?”

The LF representation of (52) is (53):

(53)

[áné_j ate_i (áye_i)] [x_j a- m- éna x_i]

The equivalent of (53) in English is (54):

(54) [who_j what_i] [did x_j see x_i]

(54) violates the ECP in that the variable left in subject position by the movement on *who* at LF is not properly head-governed (in our terms). The same problem does not arise in Tuki since Agr-S is a proper governor in the language. This accounts for the grammaticality of (52). At LF, when the subject wh-element *ané* raises, the variable it leaves behind is properly head-governed by Agr-S. As for the trace left by the raising of the object wh-item *ate* “what” in (52), it is properly head-governed by the verb.

Consider, this time, an adjunct in postverbal position:

(55)

até (áye) o- má- kúsa owáte
what FOC SM p2 buy why

“what did you buy why?”

The schematic LF representation of (55) is the following:

(56) [owáte ate_i (áye_i)] o- má- kúsa x_i x]]

x is a variable left by *owáte*. We would expect (55) to be ungrammatical; since *owáte* “why” is not an argument, its trace is not head-governed by the verb. It turns out that (55) is grammatical. At LF (in (56), *owáte* adjoins to FocP, from which position it governs the trace it has left in postpredicate position. And since the hierarchy of adjunction is irrelevant for Relativized Minimality, *até* cannot count as a potential A-bar binder. This accounts for the licitness of (55).

12.7. Conclusions

In this chapter, we have argued that

- I) CP-Trace effects are nonexistent in Tuki because Agr-S properly head-governs any variable left by wh-raising in subject position.
- II) Adjuncts can stay in situ in Tuki unlike the situation that obtains in English and French.
- III) In Tuki several wh-adjuncts can remain in situ without any ECP violation arising, providing thereby evidence that at LF multiple adjunction of adjuncts to FocP is allowed. Since the traces created by LF raising of the wh-adjuncts are properly governed (antecedent governed), it has to be the case that Relativized Minimality is respected and the hierarchy of adjunction is irrelevant.

Chapter THIRTEEN Focus-V-Movement

Introduction

Koopman (1984) is the most well-known attempt to systematically account for the phenomenon of predicate clefting. Among other findings, she indicates that in Vata the clefted verb occupies the position that is normally occupied by a Wh-phrase in question formation. But this position cannot be CP, she argues, since CP is clause-final and the host position of Wh-items and of the clefted verb is clause-initial (but for an opposing view see Yafei Li (1990)). Baltin (1991) specifically argues that predicate clefting in Vata is necessary substitution for the specifier position of CP. He notes that “by specifying both verb copying and wh-movement as substitutions, their mutual exclusivity is accounted for, since the application of one of these processes would bleed the other”. Baltin’s viewpoint runs counter to Li’s opinion that predicate clefting in Vata involves movement of the verb to the head of CP (namely C). In this work, we will provide evidence that Li’s opinion is unmotivated. In this chapter, we analyze Focus-Verb-Movement (or predicate clefting) in Tuki. It is argued that the behavior of the focused verb in this language can be accounted for by a condition that licenses the substitution of a head for the specifier position of a maximal projection. We have called this condition the Specifier Identity Condition (SIC). The SIC opens the door for the licensing of the movement of a head to a maximal projection. Whether or not the SIC is realized in a given language could be the dividing line between verb Focusing Languages and Nonverb Focusing Languages. This is expressed as the Verb Focusing Parameter.

13.1 The Tuki empirical Material

In Tuki, Focus-V-Movement is expressed by placing a verb in clause-initial position. The verb in clause initial position is the infinitive form of the verb that appears inside the clause. This construction, although widespread among many Bantu languages, is not attested in all the dialects of the Tuki language. A dialect of Tuki known as Tungoro, for instance, does not license this construction. In the following examples, focus is indicated by capital letters in the glosses:

(1)

a. o-	suwá	ówú	Putá	a-	mu-	suwá	tsónó	ráá
inf. marker	wash	FOC	Putá	SM	P1	wash	clothes	her
“Putá WASHED her clothes”								

b. o-	suwá	ówú	Putá	a-	nú-	suwámí	tsónó	ráá
inf. marker	wash	FOC	Putá	SM	F1	wash	clothes	her
“Putá will WASH her clothes”								

c. o- bángá	ówú	Putá	a-	bángám
inf. cry	FOC	Putá	SM	cry
“Putá is CRYING”				

Notice that the focused verb is accompanied by what we have called throughout a focus word (*owu*). The latter focus word occurs when adverbials or wh-adjuncts are focused in a sentence:

(2)

a. Mbárá a- nú- endám n(á) ádongo nambari
 Mbara SM F1 go to village tomorrow
 “Mbara will go to the village tomorrow”

b. nambari owu Mbárá a- nú- endám n(á) ádongo
 tomorrow FOC Mbara SM F1 go to village
 “It is tomorrow that Mbara will go to the village”

(3)

a. Díma a- má- kúsa matúwa ni
 Dima SM P2 buy car when
 “When did Dima buy a car?”

b. ni Díma a- má- kúsa matúwa
 when Dima SM P2 buy car
 “When did Dima buy a car?”

(4)

a. Kúnú a- mu- fíya yěndze yáá owáte
 Kunu SM P1 burn house her why
 “Why did Kunu burn her house?”

b. owáte ówú Kúnú a- mu- fíya yěndze yáá
 why FOC Kunu SM P1 burn house her
 “Why did Kunu burn her house?”

Observe that in the above constructions, a focused word (in this case *owu*) shows up any time an adverbial or a wh-adjunct is clefted. Bear in mind that Tuki wh-elements may remain in situ or move to clause initial position. The focus word appears only when there has been syntactic movement. Now the focus element that appears when wh-adjuncts and adverbials are focused is homophonous with the focus word that occurs in Focus-V-Movement constructions. It is reasonable to assume that it is the same focus item that is generated in both structures and that both constructions underlyingly involve the same movement process. We will come back to the similarities between Focus-V-Movement on the one hand and NP Focus, wh-Movement constructions on the other hand.

Coming back to the Focus-V-Movement construction specifically, it should be noted that the focused verb may not carry tense or aspectual morphology. The focused verb can only be in the infinitive form:

(5)

a. o- nobá ówú Isomo a- má- nobá agee wáá ídzo
Inf. beat FOC Isomo SM P2 beat wife his yesterday
“Isomo BEAT his wife yesterday”

b.* o- má- nobá ówú Isomo a- má- nobá agee wáá ídzo
Inf. P2 beat FOC Isomo SM P2 beat wife his yesterday

(6)

a. o- vánga ówú Putá a- kutu- vánga cwí
Inf. fry FOC Puta SM Prog. fry fish
“Putá is FRYING fish”

b.* o- kutu- vánga ówú Putá a- kutu- vánga cwí
Inf. kutu- fry FOC Puta SM progr. fry fish

13.1.1 Characteristics of the Focused Verb

When a focused verb is moved to clause initial position, its complements cannot follow it:

(7)

a. o- nyá ówú Mbárá a- nyám cwí
Inf. eat FOC Mbara SM eat fish
“Mbara EATS fish”

b. o- nyá ówú (*cwí) Mbárá a- nyám cwí
Inf. eat FOC fish Mbara eat fish

Adverbs can, however, follow the focused verb to clause initial position showing that it is indeed the verb that is clefted²:

(8)

o- numá ifúndu ówú ongúna o- má- numá ídzo
Inf. shine much FOC sun SM P2 shine yesterday
“The sun SHINED a lot yesterday”

Notice that the adverb may follow the clefted verb. The fact that adverbs like *ifundu* “much” can follow the focused verb may indicate that they are really incorporated into it. Similar facts are shown to exist in Armenian (Tamrazian 1991) and Hungarian (Brody 1990), where the idea is basically that certain adverbs are in a head-adjunction structure with the verbal head. It is this possibility available to adverbs but not to complements of the verb that possibly allows the former to join the verb but not the latter.

We said above that the focused verb may not carry tense or aspectual morphology. In fact, it should be added that none of the inflectional morphology that appears on tensed verbs may be carried by the focused verb³:

(9)

a. o- nambá ówú Putá a- tá- má- kutu- nambá súbu
Inf. cook FOC Puta SM Neg P2 Prog cook sauce
a ngó
of chicken

“Putá was not COOKING chicken soup”

b. o- (*a- tá- má- kutu) nambá ówú Putá a- tá- má-
Inf. SM Neg P2 Prog. cook FOC Puta SM Neg P2
kutu- nambá súbu a ngo
Prog cook sauce of chicken

13.1.2 Can Any verb Be Focused?

Every verb with a base form can be focused in this language. Intransitive verbs can be focused:

(10)

o- biná ówú Putá a- kutu- biná
Inf. dance FOC Puta SM Prog dance

“Putá is DANCING”

Ergative verbs can be clefted too:

(11)

Wárá (= o + árá) ówú vǎdzu va- m(á)- árá
Come Inf. come FOC children SM P2 come

“The children CAME”

Transitive verbs can be focused:

(12)

o- kúsa ówú Isomo a- má- kúsa tsónó
Inf. buy FOC Isomo SM P2 buy clothes

“Isomo BOUGHT clothes”

Verbs which take a double object construction can be focused:

(13)

o- fá ówú Ndumá a- mu- fá ísa wáá moní
Inf. give FOC Nduma SM p1 give father her money

“Nduma GAVE her father money”

Verbs which are part of an idiomatic expression can be focused:

(14)

o-	súwa	ówú	nubúra	nu-	má-	súwa	ídzo
Inf.	wash	FOC	rain	SM	P2	wash	yesterday

“It RAINED yesterday”

Verbs whose argument structure has been modified by verbal morphology, such as causative verbs (15), reciprocal verbs (16), applicative verbs (17) can be focused:

(15)

o-	bang-	éy-	a	ówú	Putá	a-	má-	bang-	éy-	a	mwaná	wáá
Inf.	cry	CAUS	FV	FOC	Putá	SM	P2	cry	CAUS	FV	child	her

“Putá made her child CRY”

(16)

o-	dínga-	na	ówú	Díma	na	Kunu	vá-	dingá-	ná-	mí
Inf.	love	REC	FOC	Dima	and	Kunu	SM	love	REC	Asp

“Dima and Kunu LOVE each other”

(17)

o-	námb-	en-	aówú	Putá	a-	má-	námb-	en-	a	anémé	wáa	vibúfa
Inf.	cook	Appl.	FV	FOC	Putá	SM	p2	cook	Appl.	FV	husband	her vegetable

“Putá COOKED vegetables for her husband”

13.1.3 Characteristics of Focus-V-Movement Constructions

Consider the following constructions:

(18)

a. o-	nyá	ówú	Isomo	a-	nyám	cwí
Inf.	eat	FOC	Isomo	SM	eat	fish

“Isomo EATS fish”

b. *[o-	nyá	ówú	[ate	[Isomo	a-	nyám]]]
Inf.	eat	FOC	what	Isomo	SM	eats

c. *[ate	[o-	nyá	ówú	[Isomo	a-	nyám]]]
what	Inf.	eat	FOC	Isomo	SM	eats

Notice in (18 b-c) the presence of a focused verb and fronted wh-element. The ungrammaticality of both constructions as opposed to the grammaticality of (18a) suggests that the focused verb and the fronted wh-phrase compete for the same structural position. So it has to be the case that the position occupied by the clefted verb is also the position that a wh-item would normally occupy in a construction that exhibits syntactic wh-movement.

We have just considered short distance wh-movement. Now let us turn to long distance wh-movement. Tuki licenses long distance wh-movement:

(19)

a. ate	ayé	o-	bunganám	[ée	[Mbárá	a-	mu-dzá	[ée	[Putá	a-	má-	námba]]]]]
--------	-----	----	----------	-----	--------	----	--------	-----	-------	----	-----	------------

what FOC SM think that Mbara SM P1 say that Puta SM P2 cook
 “What do you think that Mbara said that Puta cooked?”

b. *áné ódzú o- má- barafyá*[CP 0[o- beráána]]
 who FOC SM P2 forget Inf. call
 “Who did you forget to call?”

Focus-V-movement may also occur in long distance; verbs like *obungana* “to think” and *odza* “to say” license long distance predicate clefting:

(20)
 a. *wénda ówú Mbárá a- bunganám*[*ée*[o- nu- *éndám ná Púrási*]]
 go FOC Mbara SM think that SM F1 go to Paris
 “Mbara thinks that you will GO to Paris”

b. *o- bánga ówú Mbárá a- b- [ée [nõsi wáá a- nu- bangám]]*
 Inf. cry FOC Mbara SM says that mother her SM F1 cry
 “Mbara says that his mother will CRY”

Now consider the following constructions:

(21)
 a. **[na áné ódzú]_i Isomo a- m(u)- údza na Putá marú ama[ée[*
 to whom FOC Isomo SM P1 tell to Puta story this that
visimbi vi- m(u)- dzára x_i]]
 police SM P1 talk
 “* To whom Isomo told Puta the story that the police talked”

b. **wúna ówú Isomo a- m(u)- údza ná Putá marú ama[ée[*
 kill FOC Isomo SM P1 tell to Puta story this that
visimbi vi- m(u) -úna Dima]]
 police SM P1 kill Dima
 “* Isomo told Puta the story that the police KILLED Dima”

c. **o- fendá ówú Isomo a- m(u)- úba marú ama[ée[Díma a-*
 Inf. repair FOC Isomo SM P1 hear story this that Dima SM
má- fendá matúwa wáá]]
 P2 repair car his
 “Isomo heard the story that Dima REPAIRED his car”

(21a) is illicit because the pied-piping of the wh-phrase *na ane* has taken place over an island. Similarly (21 b-c) are both ruled out because a clefted verb is related to an identical verb inside an island (in this case a complex noun phrase). So Focus -V- Movement obeys the Complex Noun Phrase Constraint. Hence the illicitness of the following constructions:

(22)
 a. **o- kós- en- a tu- t- ídzima*[*ate tu- fitím o- kós- en- a iya iitsú*]]
 Inf. buy Appl. FV SM Neg know what SM can Inf. buy Appl. FV mother our

"We do not know what we can BUY for our mother"

b. * wénda ówú tu- t- ídzima[táne [t- éndam]]
 go FOC SM Neg know where SM go

"We do not know where we are GOING"

Thus it can be safely stated that Focus-V-Movement is subject to the Complex Noun Phrase Constraint and the Wh-Island Constraint.

13.2 Focus-V-Movement

13.2.0 Summary

Up to now, we have established the following facts about Focus-V-Movement in Tuki:

(23)

(i) In this language, Focus-V-Movement moves a verb to clause initial position⁴; the verb in clause initial position is the infinitive form of the verb that appears inside a clause.

(ii) A syntactically raised wh-element and a focused verb may not occur in the same clause, suggesting that syntactic Wh-Movement and Focus-V-Movement substitute items to the same position.

(iii) long distance Focus-V-Movement is licensed when there is a bridge verb.

(iv) The relationship between a focused verb and its copy inside the clause is strictly subject to Bounding Theory as evidenced by the fact that a clefted verb may not be "linked" to its copy inside a complex noun phrase or a wh-island. This amounts to saying that the relationship between a focused verb and its copy is constrained by Subjacency and CP, IP and NP are the Bounding Nodes.

13.2.1 Wh-Movement as Substitution for Spec of FP

We have argued extensively in a preceding chapter that Wh-Movement in Tuki (and Duala) substitutes wh-phrases to the specifier position of a Focus Phrase; very briefly, we summarize here the arguments that have led to such a conclusion.

13.2.1.1 Structure of Focus sentences

Focus constructions in Tuki are characterized by the appearance of a focus word after the focused constituent:

(24)

a. Putá a- nú- fám nõsi wáá manyá námbari
 Puta SM F1 give mother her food tomorrow

"Puta will give her mother food tomorrow"

b. Putá ódzú a- nú- fám nõsi wáá manyá námbari
 Puta FOC SM F1 give mother her food tomorrow

"It is Puta who will give her mother food tomorrow"

c. manyá ama Putá a- nú- fám nõsi wáá námbari
 Puta FOC Puta SM P1 give mother her tomorrow

“It is food that Puta will give her mother tomorrow”

d. nŏsi wáá ódzú Putá a- nú- fám manyá námbari
 mother her FOC Puta SM F1 give food tomorrow

“It is her mother that Puta will give food tomorrow”

e. námbari ówú Putá a- nu- fám nŏsi wáá manyá
 tomorrow FOC Puta SM F1 give mother her food

“It is tomorrow that Puta will give her mother food”

Any constituent of the sentence except the verb has been focused and has appeared in pre-FOC position. Thus focus sentences have the following structure:

(25)

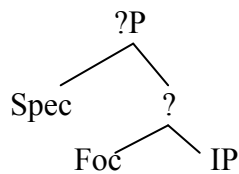

The exact identity of *?P* and *?* will be specified shortly.

13.2.1.2 Matrix Wh-Questions

When Wh-movement occurs in the Syntax, a focus word accompanies the extracted wh-word:

(26)a. áné ódzú Mbára a- benám
 who FOC Mbara SM hates

“Who does Mbara hate?”

b. até áyé Mbára a- mu- kúsa
 what FOC Mbara SM p1 buy

“What did Mbara buy?”

c. ni ówú Mbára a- nú- kúsám matúwa
 when FOC Mbara SM F1 buy car

“When will Mbara buy a car?”

d. owáte ówú Mbárá a- nú- fiyá yěndze yáá
 why FOC Mbara SM F1 burn house his

“Why did Mbara burn his house ?

Wh-questions have a structure similar to focus constructions:

(27)

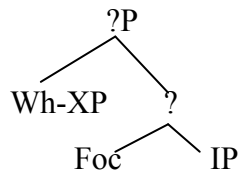

13.2.1.3 Embedded Wh-Questions

Now admire the fact that a focus word occurs in Tuki embedded questions:

(28)

a. Mbárá a- sesám [ée [áné [ódzú [Putá a- benám]]]]
 Mbara SM asks that who FOC Puta SM hates

“Mbara asks who Puta hates”

b. Mbara a- sesám [ée [ate [aye [Putá a- mu- kusa]]]]
 Mbara SM asks that what FOC Puta SM P1 buy

“Mbara asks what Puta bought”

c. Mbárá a- kambím [ée [ní [ówú[Putá a- nú- kusám matúwa]]]]
 Mbara SM astonish that when FOC Puta SM F1 buy car

“Mbara wonders when Puta will buy a car”

d. Mbárá a- kambím [ée [owáte [ówú[Putá a- mu- fiya yěndze yáá]]]]
 Mbara SM astonish that why FOC Puta SM P1 burn house her

“Mbara wonders why Puta burned her house”

Tuki embedded questions have the following structure:

(29)

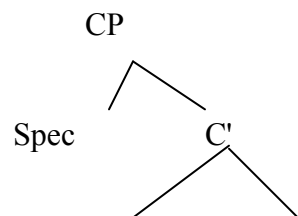

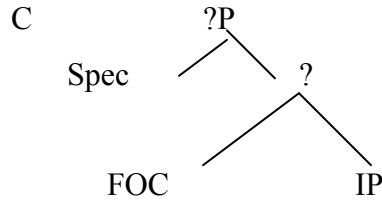

Notice that our analysis predicts that long distance wh-movement would leave agreeing Focus words in intermediate FPs. That is precisely what happens:

(30)

a. Mbárá a- mu-dzá ée agee wáá a- mu-nambá ngó
 Mbara SM P1 say that wife his SM P1 cook chicken
 “Mbara said that his wife cooked chicken”

b. até áyé Mbárá a- mu-dzá ée áyé agee wáá a- mu-nambá ngó
 what FOC Mbara SM P1 say that FOC wife his SM P1 cook chicken
 “What did Mbara say that his wife cooked?”

c. até áyé Mbárá a- mu-dzá ée agee wáá a- mu-nambá ngo
 what FOC Mbara SM P1 say that wife his SM P1 cook chicken
 “What did Mbara say that his wife cooked?”

Sentence (b), in which an agreeing Focus word occurs in the intermediate FP, constitutes evidence that there is a functional projection between CP and IP. For, if there were one maximal projection, *ee* and *owu* would be in complementary distribution, as in Germanic languages where there is a complementary distribution between V-movement to C and the presence of a lexical complementizer (see Den Besten (1977) and Koopman (1984)). The optionality of the agreeing Focus word in the (c) sentence is plausible in view of the fact that the same optionality obtains in matrix contexts. The fact that a Focus word can be ‘stranded’ and appear in intermediate FPs would seem to argue convincingly against a view that a Focus word is part of a Wh-Phrase (either as a modifier or the head of a DP-like constituent).

Incidentally, notice that in long distance predicate clefting constructions too, a Focus word may occur in intermediate FPs:

(31)

o- bánga ówú Mbárá a- bungánám ée ówú nõsi wáá a- nú- bangám
 Inf. cry FOC Mbara SM think that FOC mother his SM F1 cry

“Mbara thinks that his mother will cry”

13.2.1.4 Wh-Questions and Clause Structure

So far we have argued the following:

- (i) Focus sentences have the linear structure *XP Focus Word IP*.
- (ii) When movement occurs in the Syntax, wh-questions are formed *Wh-XP Focus Word IP*.
- (iii) Embedded questions are formed *That WH Focus Word IP*.
- (iv) The choice of the focus word is dependent upon the choice of the moved wh-element, suggesting that an agreement relation obtains between them.

In view of (i-iv), the structure of Tuki questions seems to be:

(32)

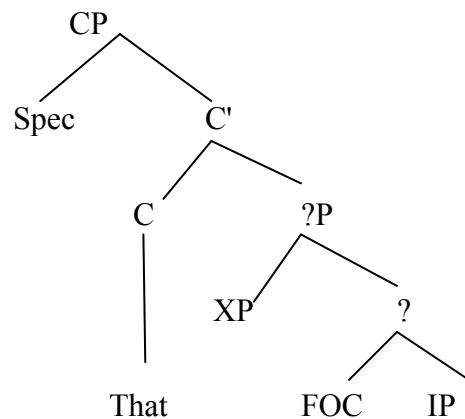

Since ?P is the projection of a focus word, it can be analysed as a F(ocus) P(hrase):

(33)

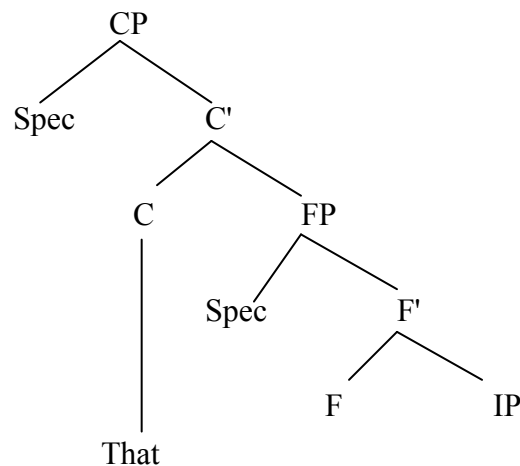

13.2.2 Focus -V-Movement as substitution for Spec of FP

As in Wh-movement, a focus word appears when a verb is clefted:

(34)

Wanyó	ówú	Isomo	a-	má-	nyó	maábo	ídzo
drink	FOC	Isomo	SM	P2	eat	wine	yesterday

“Isomo DRANK wine yesterday”

Do we want to treat the similarity between Focus-V-Movement and Wh-Movement (in terms of the choice of the focus word) as a coincidence or as logical outcome of the fact that Focus-V-Movement is simply as Koopman puts it the WH-Type of Verb Movement⁵?

We want to claim that both Focus-V-Movement and Wh-Movement in this language substitute their extracted elements to the same position. If Focus-V-Movement and Wh-Movement were raising to different syntactic positions, we would expect the following (b-c) sentences to be grammatical:

(35)

a. [o-	nyá	ówú	[Isomo	a-	nyám	ndzambú]]
Inf.	eat	FOC	Isomo	SM	eat	meat

“Isomo EATS meat”

b. *[o-	nyá	ówú	[ate	áyé	[Isomo	a-	nyám	ndzambú]]]
Inf.	eat	FOC	what	FOC	Isomo	SM	eat	meat

c. *[ate	áyé	[o-	nyá	ówú	[Isomo	a-	nyám]]]
what	FOC	Inf.	eat	FOC	Isomo	SM	eat	

d. [ate	áyé	[Isomo	a-	nyám]]]
what	FOC	Isomo	SM	eats

e. *[áne _i	ódzú	[ate _j	áyé _j [Mbárá	a-	má-	fá	x _i x _j]]]
who	FOC	what	FOC	Mbara	SM	P2	give

“Who what_j Mbara x_i x_j”

f.* [ate _j	áyé _j	[áne _i	ódzu _i	[Mbárá	a-	má-	fá	x _i x _j]]]
what	FOC	who	FOC	Mbara	SM	P2	give	

“What_j who_i Mbara X_i X_j”

The ungrammaticality of the (b-c) sentences is paralleled by the behaviour of the (e-f) constructions: it seems to be the case that double application of (wh-) movement to the same structural position is strictly prohibited for those languages that do not license multiple adjunction of wh-phrases to clause initial position. Polish, Serbo-Croatian and Czech allow

several wh-phrases to be fronted in content question formation (for details see Lasnik and Saito (1984) and Rudin (1988)). This is possible because these languages license the *adjunction* of wh-phrases (to IP). This state of affairs constitutes prima facie evidence that Wh-Movement and Predicate clefting in Tuki are both substitution for a maximal projection rather than adjunction to a maximal projection. Notice that the English equivalents of the (e-f) sentences are also ungrammatical. Chomsky (1986b) considers English sentences similar to (e-f). Ignoring possible Bounding Theory considerations, he concludes that a general principle of UG states that a particular rule (Front-wh or Front-V-here) cannot apply twice to the same clause. He suggests a reformulation of the principle that blocks multiple application of a rule to a clause as a “filter” on S-structure: a VP cannot immediately contain two NP traces⁶. The fact that constructions such as (e-f) are licensed in languages that allow multiple adjunction of wh-phrases to clause initial position may suggest that the above mentioned VP-“filter” is subject to lower-level parametric variation among languages.

Since we have argued that wh-items substitute for FocP, it is appropriate to state that Focus-V-Movement substitutes for the same structural position. Thus (35a) will be assigned the following representation:

(36)

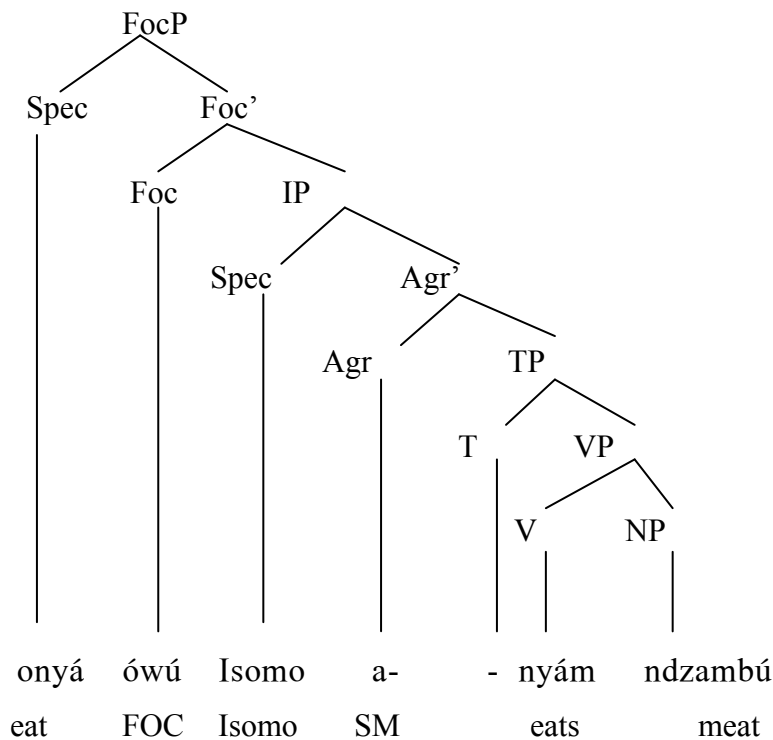

The phrase marker of (35d) is provided below:

(37)

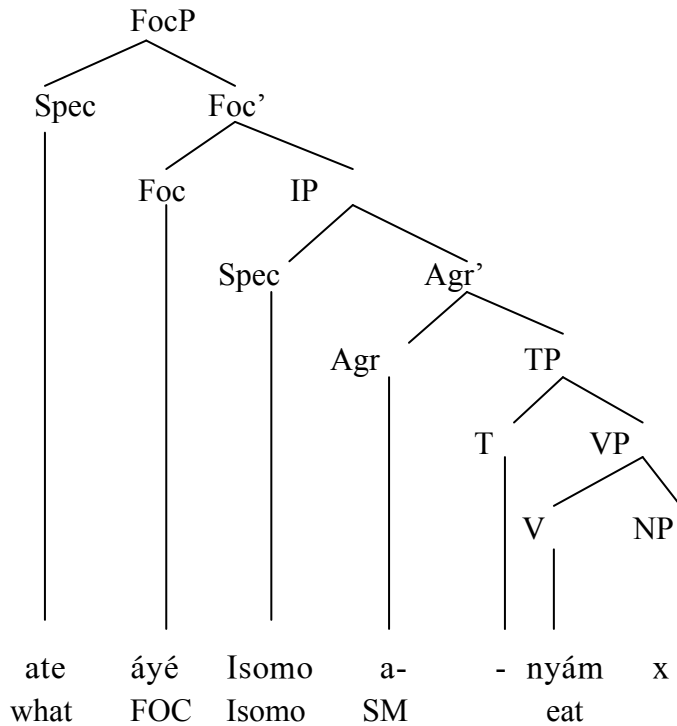

In many respects, (36) and (37) look alike. But it is (36) that we need to motivate further. What happens when (35a) is embedded? We obtain the following structured sentence:

(38)

Mbárá a-b-[_{CP} ée [_{FocP} [_{Spec} onyá [_{Foc'} [_{Foc} ówú [_{IP} Isomo a- nyám cwí]]]]]]]
 Mbara SM say that eat FOC Isomo SM eat fish
 “Mbara says that Isomo EATS fish”

The parallelism between Focus-V-Movement and syntactic Wh-Movement carries over to embedded contexts since we know by now that constructions such as the following are licensed:

(39)

Mbárá a-sesám [_{CP} ée [_{FocP} [_{Spec} ate [_{Foc'} [_{Foc} áyé [_{IP} Isomo a- nyám]]]]]]]
 Mbara SM ask that what FOC Isomo SM eat
 “Mbara asks what Isomo eats?”

In view of the parallelism between Focus-V-Movement and Wh-Movement, our claim that the former process is substitution for the specifier position of a headed constituent focus phrase seems to be supported by a strong factual basis. However, the position that a maximal projection can be the landing site of X° Movement is far from uncontroversial. In fact there are three *possible* types of Head Movement:

(40)

- (i) Substitution for a maximal projection (i.e. a specifier)
- (ii) Adjunction to a maximal projection
- (iii) Substitution for or adjunction to an X° category.

Chomsky (1986) indicates that (40i) and (40ii) are ruled out by some version of “structure preservation” which prohibits XP projections from taking the position of X° projections and vice versa (see also Baker (1988, 59)). Baker (1988) indicates that Chomsky (1986, 73) accounts for the inability of an X° to adjoin to a maximal projection by postulating that Head movement is in fact “A-movement” (Movement to an argument position, i.e. like NP-movement). Thus, for Chomsky, Head Movement is not “A’-movement” (movement to a nonargument position). Then adjunction of an X° to an XP is ruled out in the same way that movement of an NP from a lower subject to a higher subject by way of CP is.

Chomsky and Baker assume that only (40iii) is a viable option for Verb Movement. If indeed (40iii) is the only viable option for Verb Movement, it may not account for the empirical material presented here. Recall that it was clearly shown above that the focused verb competes with the extracted wh-phrase for the same structural position. Crucially, assuming that the Tuki clefted verb substitutes for or adjoins to some head will amount to saying that wh-movement in this language raises wh-items to some X° category. This, obviously, cannot be maintained. Since a verb and a wh-phrase may not be fronted in the same clause, the only way out for us is to maintain that verb movement in the Tuki case of predicate clefting is substitution for a maximal projection (i.e. a specifier). But there is a question that has so far remained unaddressed: what allows verb movement in Tuki to be substitution for FocP? In other words, under what conditions can an X° category move to an XP?

13.2.3 The Morphological conversion Hypothesis

It could be argued that in certain situations, a Tuki verb acts like a noun phrase. Thus when it is clefted, it behaves much in the same way as an NP would in the same situation. It has been argued by Lefebvre and Lumsden (1989) that in certain Haitian predicate clefting structures, a process of morphological conversion that transforms verbs into nouns takes place. They indicate that Filipovich (1987) has demonstrated that such derived nouns have all properties of simple nouns and that they project an NP which has the same properties as NPs headed by other nouns in the language.

There is no evidence that Tuki predicate clefting sentences involve a process of morphological conversion that converts verbs into nouns. The clefted verb does not carry nominal morphology, it may not be accompanied by determiners or possessive pronouns:

(41)

a. wénda ówú Putá a- m- énda ná mbóo
 go FOC Puta SM P1 go to market
 “Putá WENT to the market”

b. * wénda wáme
 go my

The illicitness of (41b) suggests that infinitives may not in general function as a noun phrase. In fact as far as we have been able to determine, no Tuki infinitive may be used as an NP, irrespective of whether a verb assigns case or not to any complement:

(42)

a. o- bína “to dance”
 Inf. dance

b. o- dínga “to love”
 Inf. love

c. w- árá “to come”
 Inf. come

(43)

a. Mbínino ráme
 dancing my
 “My dancing”

b. ndíngino ráme
 loving my
 “My loving”

c. ngéndéno ráme
 going my
 “My going”

English has an affix (*-ing*) that changes a verb phrase into a noun phrase. Tuki seems to have an English type gerund as illustrated in (42). No such gerund shows up in verb focussing

constructions. Thus it appears that the morphological conversion hypothesis is not supported by a strong factual basis.

Next, we consider another proposal that has been advanced to account for predicate clefting phenomena.

13.2.4 The semantic hypothesis

Lefebvre (1989) discusses the various types of verbs which may participate in Haitian predicate cleft constructions (e.g. “run”, “sleep”, “eat”, “make”, “buy”, “look”, “hear”, etc;)

a. se kouri jan kouri
that-is run John run

“It is run (not walk) that John did”

b. se domi Jan domi (pandan inèdtan)
that-is sleep john sleep (for an hour)

“It is sleep (not throw away) that John did (for an hour)”

c. se manje Jan manje pen
that-is eat john eat bread

“It is eat (not throw away) that John ate bread”

d. se fè jan fè tab
that-is make John make table

“It is make (not paint) that John made tables”

e. se gade Jan gade television an
that-is watch John watch television DET

“It is watch (not fix) that John watched television”

f. se achte Jan achte flè a
that-is buy John buy flower DET

“it is buy (not steal) that John bought the flower”

g. se tande jan tande volè a

that-is hear john hear thief DET

“It is hear (see) that John heard the thief”

She also shows that predicates like “be intelligent”, “know”, “love”, resemble” do not participate in predicate cleft constructions:

(45)

- | | | | | | | |
|---------|-------------|------|---------------|------|------------|--|
| a. *se | intèlijan | Jan | intèlijan | | | |
| that-is | intelligent | John | intelligent | | | |
| b. * se | konnè | jan | konnè lang | sa | a | |
| that-is | know | John | know language | this | DET | |
| c. *se | renmen | jan | renmen | Mari | | |
| that-is | love | John | love | mary | | |
| d.se | samble | Jan | samble | ak | papa-l | |
| that-is | resemble | John | resemble | with | father-his | |

The predicates exemplified in the first Haitian paradigm are referred to as Stage-Level predicates, while those illustrated in the second paradigm are called Individual-Level predicates (Carlson (1977), Diesing (1988), Kratzer (1988)). Lefebvre indicates that Stage-Level predicates denote a transitory property whereas Individual-Level predicates denote a permanent property. Thus in the first paradigm, all predicates denote a transitory property (e.g. “run”, “eat”), while in the second paradigm all predicates denote a constant property (e.g. “resemble”, “be intelligent”). Verbs like “sit”, “stand”, which are stative are Stage-Level predicates since they denote a transitory property. Lefebvre observes that Stative Individual-Level predicates cannot participate in predicate cleft constructions (cf. (45)) while Stage-Level predicates can:

(46)

- | | | | |
|---------------------------------------|-------|------|-------|
| a.se | chita | Jan | chita |
| that is | sit | John | sit |
| “It is sit (not stand) that John did” | | | |
| b. se | kanpe | Jan | kanpe |
| that-is | stand | John | stand |
| “It is stand (not sit) that John did” | | | |

c. se	tande/wè	Jan	tande/wè	vole	a
that-is	hear/see	John	hear/see	thief	DET

“It is hear/see that John heard/saw the thief”

She concludes that the contrast in grammaticality between (45) and (46) show that Stage-Level/ Individual-Level is the key difference between predicates which can be clefted and those which cannot.

We would expect the verb class constraint exhibited above to obtain in Tuki. Consider the behavior of Stage-Level predicates (47) and Individual-Level predicates (48) below:

(47)

a. o-	fendá	ówú	Isomo	a-	má-	fénda	tévère	ídzo
inf.	make	FOC	Isomo	SM	P2	make	table	yesterday

“Isomo MADE a table yesterday”

b.o-	bete	ówú	Putá	a-	kutu	béte	ná	tsúmba
Inf.	sleep	FOC	Putá	SM	Prog	sleep	in	bedroom

“Putá is SLEEPING in the bedroom”

c.o-	bóno	ówú	Isomo	a-	mu-	bonó
Inf.	run away	FOC	Isomo	SM	P1	run away

“Isomo RAN away”

(48)

a. o-	dingá	ówú	Isomo	a-	má-	dingá	Tsimi
Inf.	love	FOC	Isomo	SM	P2	love	Tsimi

‘Isomo LOVED Tsimi’

b. o-	fwánena	ówú	Isomo	a-	fwánenám	ísa	wáá
Inf.	resemble	FOC	Isomo	SM	resemble	father	his

“Isomo RESEMBLES his father”

c. wídzima	(=o +ídзима)	ówú	Isomo	ídзимám	agee	wáá
	Inf. know	FOC	Isomo	know	wife	his

“Isomo KNOWS his wife”

(47) and (48) show that there is no marked contrast between Stage-Level predicates and Individual-Level ones with regard to clefting. We therefore conclude that the verb class constraint (namely, Stative Individual-Level predicates do not participate in predicate clefting whereas Stage-Level predicates do) is unable to account for the process of verb fronting in Tuki.

13.2.5 The Specifier Identity Condition

If it can be maintained that the clefted element in Tuki Focus-V-Movement constructions is a verb, we have to explain how this view fares with regard to the theory of phrase structure. Chomsky (1986b) elaborates on the circumstances under which categories can occur in certain configurations. He mentions that predication and theta-marking are the relationships that license the occurrence of maximal projections in structures. Nonmaximal projections (i.e. X° categories), on the other hand, must be licensed relative to the maximal projection in which they appear, by X-bar theory. With the above in mind, let us assume that specifiers of functional maximal projections are neutral with respect to the nature of items they might host (temporarily or permanently). This would allow heads to substitute for the specifier position of a functional maximal projection, a desired result in view of the Tuki empirical material. If this conclusion proves to hold water, it would force a recasting of X-bar theory and the Structure-Preserving Hypothesis in the following form:

(49) *Specifier Identity Condition (SIC)*

Specifiers of functional maximal projections are unspecified with respect to the identity of the elements they may host.

The Specifier Identity Condition (SIC) extends a little bit the scope of the standard X-bar convention and the Structure-Preserving Hypothesis. The latter constraints on configurational schemata require that maximal projections substitute for maximal projections, while the SIC states that the specifiers of maximal projections can host raised items irrespective of their identity. Thus the SIC allows the movement of a head to the specifier position of a maximal projection. Now, it is fairly obvious that the SIC cannot apply to all languages, since French and English, among others, do not license verb focusing constructions à la Tuki. Thus it is appropriate to suggest that the manifestation of the SIC in a given language could be the dividing line between Verb-Focussing-languages and Non-Verb-Focussing-languages. Let us formalize this linguistic dichotomy in the form of a parameter:

(50)

VerbFocussing Parameter

heads [may/may not] substitute for the specifier position of a functional maximal projection.

MAY: Tuki, Vata...

MAY NOT: English, French, German...

It is possible to argue that the existence of verb focusing constructions in languages like Tuki and their nonexistence in languages like English can be attributed to a difference in the constituent structure of those languages.

13.3 Extension of the Analysis: Basque

It would be nice to extend the analysis presented here to languages other than Tuki (or other related African languages). In the following pages, we will provide evidence that Wh-Movement, some instances of verb movement and focusing constructions in Basque move elements to the specifier position of a maximal projection (in this case CP).

13.3.1 Wh-Movement and Focus in Basque

Basque, as analyzed by Jon Ortiz De Urbina (1988), exhibits overt movement of focalized constituents and wh-words. Recall that Horvath (1981), analyzing Hungarian, argues for the existence of a preverbal FOCUS position which can host both wh- phrases and foci. This FOCUS position is said to be distinct from the Spec of CP. The latter position can only function as the landing site of relative operators. Relative clause formation in Basque does not use relative pronouns. Thus, in Horvath's framework, the Spec of CP plays no role at all⁷. De Urbina claims, instead, that in Basque both wh-words and focalized items move in the Syntax to Spec of CP. He analyzes the preverbal position of these operators as an instance of the Verb-second (V2) phenomenon.

13.3.1.1 Interrogative and focal Operators

It is well known that in Basque interrogative operators appear in preverbal position:

(51)

i. noiz etorri zen Jon herri hon-etara ?

when come aux John town this-to

“When did John come to this town?”

- ii. zein herri-tan bizi zen Jon lehenago?
 which town-in live aux John before

“In which town did John live before?”

The following constructions ((52) below) are ungrammatical because an element occurs between the items in A'-position and the verb:

(52)

- i. *Noiz Jon da herri hontara?
 when John has come to this town
- ii. *zein herritan Jon bizi zen lehenago?
 in which town John lived before

In embedded contexts as well the verb must be immediately preceded by the wh-item:

(53)

- i. Ez dakit noiz etorri d-en herri honetara
 neg know when has come aux-sub this town

“I don't know when he has come to this town”

- ii. *Ez dakit noiz etorri d-en herri honetara

In negative constructions, the negative particle *ez* and the inflected verb are moved to the left, the participle is left behind :

(54)

- i. Jon herri honetara aurten etorri da (Periphrastic)
 this year come aux

“John came this year to this town”

- ii. Jon ez da erri honetara aurten etorri
 neg aux come town this year come

“John has not come this year to this town”

- iii. Jon bide horr-etatik dator (Synthetic)
 way that-by comes

“John is coming that way”

- iv. Jon ez dator bide horretatik
 neg come way that-by

“John is not coming that way”

In negative questions, the [*ɛz*-inflected verb] unit is preceded by the wh-word (when there is a participle, it is left behind):

(55)

i. Nor ez da bide horretatik etorri?
 who neg aux

“Who has not come that way?”

ii. Nor ez dator bide horretatik?
 who neg comes

“Who is not coming that way?”

No element can occur between the wh-word and the inflected verb:

(56)

* Nor bide horretatik ez da etorri

Focalized elements behaves like wh-phrases. In the following sentences, the focused word is *aurten* “this year”:

(57)

i. Jon aurten etorri da herri honetara
 this year come aux

“John has come this year to this town/it is this year that John has come to this town”

ii. aurten Jon etorii da herri honetara

Ortiz De Urbina indicates that focused constituents are phonologically emphasized. Thus not all constituents preceding the verb are interpreted as foci. Suffice to remember that all focalized constituents must occur in the position immediately preceding the verb.

Basque has a nonlexical structure like this one⁸:

(58)

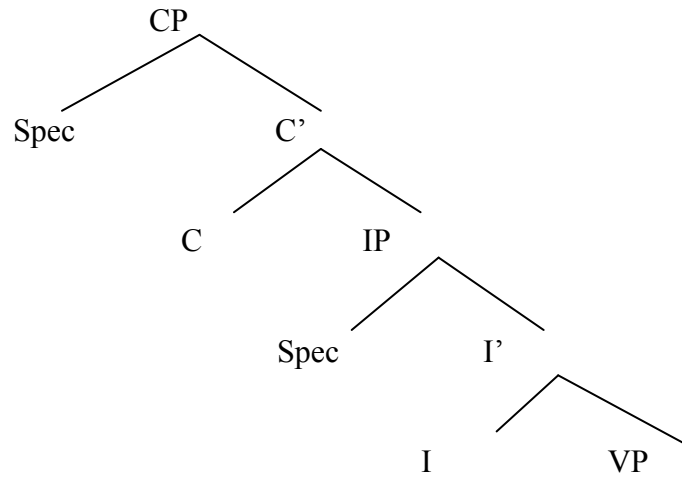

He shows that Wh-Movement in Basque occurs in the Syntax and that operator-variable pairs are formed not only for wh-operators, but also for focalized operators at that level. Focalized words also behave like operators at LF. At the latter level they bind variables. If a focalized constituent binds more than one variable, the Bijection Principle is violated:

(59)

- i. *not_i maite du bere_i ama-k
 who (A) love aux his mother-≠E
 “Who does his mother love?”
- ii. ??Jon_i maite du bere_i amak
 John (A)

Now consider the following sentence:

(60)

- Nor-k entzun du kanta hori
 who-E hear aux song that
 “Who has heard that song?”

Its LF representation is (61) if it is assumed that V' is the host of focused constituents⁹:

(61)

Nork_i[_{IP}[e]_i [_{VP}[V'₂[e]₂ entzun]kanta]I]]

Notice that in (61) e₂ is bound by e₁. This is a violation of Binding Theory Principle C since the variable is A-bound in the domain of its operator (*nork*). (61) is possible in an approach that argues for V' as the landing site of focused constituents. In the V'-approach, *nork* would be lowered to the V'-position, then moved to a position having scope over the whole clause (at LF).

In De Urbina's CP analysis the Principle C violation does not occur since *nork* moves directly from its D-structure position to Spec of CP where it binds its only trace.

13.3.1.2 Verb- Second Phenomenon

De Urbina shows that Basque wh-phrases and focused elements raise to Spec of CP, thereby prompting verb movement to a position adjacent to their right. He calls this peculiar behavior of Wh-Movement in Basque a V2 phenomenon. As in other languages, V2 in Basque involves a process of V/I – to-C-movement.

In the following English and Spanish verb second constructions, the verb (or modal or auxiliary in the case of English) has been moved to the right of the wh-word:

(62)

- i. John is home now
- ii. Juan fue a casa hoy
 John went home today
- iii. Where is [John now]
- iv. Adonde fue [Juan hoy]
 where

“Where did John go today?”

In Basque, the inflected verb moves to the head of CP when an operator substitutes for the specifier position of CP. The movement of the inflected verb proceeds as follow: V raises to I, amalgamating with the latter. The inflected morphological V/I unit raises from I to C. Head-to-head movement is required to avoid an ECP violation.

In Basque, most verbs do not have conjugated forms of their own. Since they cannot amalgamate with I they are adjoined to it. An auxiliary verb carries the inflectional affixes. A sentence like (63i) is analyzed as (63ii):

(63)

- i. Nork-k entzun du kanta hori
 who-E hear aux song that

“Who has heard that song?”

ii.

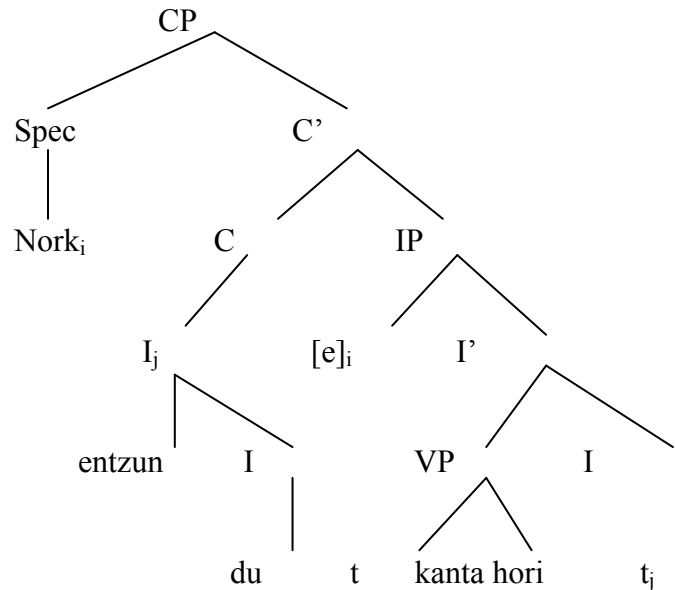

Below, Basque (i, ii), Catalan (v, vi) and Torrego's (1984) Spanish (iii, iv) behaves alike, in contrast to Italian (viii) and English (vii). While adjacency between the wh-element and the verb is required in matrix and embedded contexts in the former group of languages, it is not in the second group:

(64)

- i. ez dakit zer bilatzen duten mutil hoiek
 neg know what look for aux guys those
 "I don't know what those guys are looking for"
- ii. *Ez dakit zer mutil hoiek bilatzen duten
- iii. na sabia qué querian esos dos
 neg knew what wanted those two
 "I did not know what these two wanted"
- iv. * No sabia qué esos dos querian
- v. no sabia què buscaven els meus amics
 "I did not know what my friends were looking for"
- vi. *No sabia què els meus amics buscaven
- vii. I don't know what they wanted
- viii. Non se che cosa Giannia ti abbia detto

In Basque, Catalan and Spanish, the inflected verb must be adjacent to the operator, rather than the auxiliary (as in English). De Urbina argues that it is the raising or the operator to

the Spec of CP that triggers verb fronting to pre-IP position. This reasoning extends to other focalized constituents:

(65)
 [ni-k entzun dut [kanta hori]]
 I-E hear aux song that
 “I have heard that song”

In the above sentence, *nik* raises to Spec, thereby triggering the movement of the verb *entzun dut* to C¹⁰.

13.3.1.3 Verb focalization

The verb too can be focalized in Basque. The process of verb focalization varies according to whether the verb is synthetic or not. Synthetic verbs can amalgamate with inflection, incorporating agreement and tense markers along with the verbal root, as in *nindoan* ‘I went’, *dakaru* ‘you are bringing’, *zirudien* ‘it seemed’... When a verb does not have a form of its own, an auxiliary is inserted to support the affixes in I. De Urbina assumes that all verbs raise to I. synthetic verbs amalgamate with I in some tenses to form the inflected morphological verbal unit V/I as below

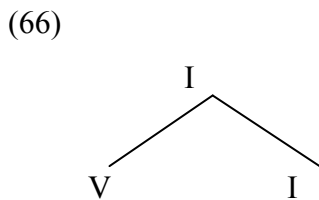

An auxiliary verb is inserted to carry the affixes in I. Verb raising seems to occur in periphrastic verbs and tenses¹¹, as indicated by the fact that: a) the auxiliary and the verb both move to CP in positive interrogatives as a whole constituent, and b) arguments may not appear between the auxiliary and the verb. As for synthetic verbs, the head of the inflected verb unit (V/I) moves to C of CP and Spec of CP is occupied by the affirmative particle *ba*:

(67)
 i. ba dakit_i [ni-k t_i v_p[t hori]]
 know I-E that (A)
 ii. Jon ba dator
 John-A comes

“John is already coming/ is really coming/ does come”

In (67i) the affirmative particle *ba* occupies the Spec position of CP; t_i is the original trace of the verb *jakin* ‘to know’, t_j is the trace left in I, the inflected verbal unit (V/I) *dakit* has moved to the head position of CP (C).

In some dialects of Basque (Bizkaiera), a participial copy of the focalized verb occurs immediately to the left of the synthetic verb:

(68)

i. Etorri dator
 come comes
 “He does come”

ii. ibili dabil
 walk walks
 “He does walk”

Since the inflected verb, as we have seen, is hosted by the head of CP, its participial copy has to substitute for the specifier position of CP, as indicated below:

(69)

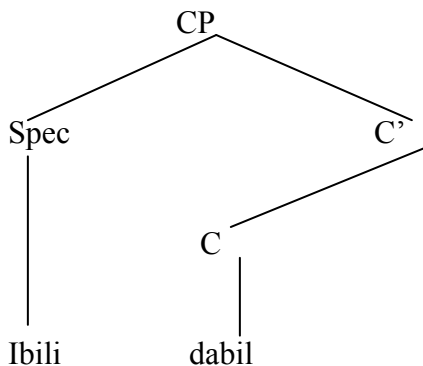

In the case of periphrastic verbs, an auxiliary verb carries the inflectional affixes. If the auxiliary verb raises to the head of CP, then the uninflected verb has to move to Spec CP in Focus-V-Movement. Citing Euskaltzaaindia (1985: 46), De Urbina indicates that there are two strategies of verb focalization of periphrastic verbs. A possible answer to (70i) could be either (ii) or (iii):

(70)

i. zer gertatu zaio zure aita-ri
 what happen aux your father-D

“What has happened to your father”

ii. Hil egin da gure aita
 die do aux our father

“Our father has died”

iii. Hil da gure aita
 die aux

“Our father has died”

In (ii), we can assume that the dummy verb *egin* ‘to do’ occupies C of CP while the uninflected *hil* ‘to die’ is hosted by Spec CP. The same reasoning applies to (iii), but in this case C of CP is the auxiliary verb *da*. Thus the relevant tree-structure representation of (iii) is (71) below:

(71)

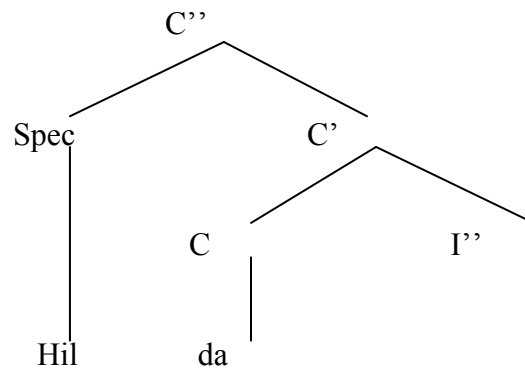

The Basque data is pretty much similar to the Tuki. If it can be maintained that Basque verb focalization licenses the substitution of the verb for the specifier position of CP, this strengthens the analysis of Focus-V-Movement adopted in this work. Thus the idea that heads may move to specifiers of maximal projections is supported by a diverse strong factual basis. Since Tuki (and possibly Vata) and Basque are languages that belong to two unrelated linguistic families, the process of verb raising examined here can only be a property of Universal Grammar (UG). And as such it has to be accounted for by general invariant principles. We have already proposed the Specifier Identity Condition (SIC) that essentially licenses the movement of heads to functional maximal projections. Next we consider whether Focus-V-Movement has a counterpart at LF.

13.4 Chinese: LF Verb Movement to CP.

Baltin(1991), quoting Huang (1982), argues that the construction called A-not-A question involves the movement of the verb to CP. Consider (73), the yes-no question corresponding to (72): =Huang (1982b, (63))

Ta xihuan ni
 he likes you
 “He likes you”

(73) =Huang (1982b, (64))

Ta xi- bu -xi-huan ni ?
 He lik- not- li- ke you
 “Does he or doesn’t he like you?”

To form an A-not-A question, the first syllable of the verb is copied, then it is prefixed to the verb, and the negative marker *bu* is inserted between the prefixed copy of the first syllable and the first syllable. When the questioned verb appears in a sentential complement, it takes scope over the matrix sentence, providing thereby evidence that movement is involved:

(74)= Huang ((1982b, (66))

[ni renwei [s’ ta xi- bu -xi-huan ni]] ?
 You think he lik- not -li-ke you
 “Do you think he likes you or do you think he doesn’t?”

Huang calls this process Move A-not-A, an instance of Move a. The questioned verb moves to CP at LF.

More evidence that a movement process is involved in A-not-A question formation is provided by the fact that the behavior of Move A-not-A question formation is provided by the fact that the behavior of Move A-not-A is regulated by Bounding Theory. Consider the following sentences:

(75)

[Ni xiang-zhidao [shei xi-bu -sihuan ta]] ?
 You wonder who he-not like him

(76)

[wo xiang-zhidao[Lisi xi-bu -xihuan ta]]
 I wonder Lisi like-not like him

(77)

[wo xiang-zhidao [shei xihuan ta]]

I wonder who like him

According to Huang's reported position in Baltin, (76) could be an appropriate answer to (75), but (77) could not be. (77) could not be an answer to (75) because *xi-bu-xihuan* cannot have matrix scope, it cannot raise over the wh-element *shei* 'who'; should it raise over *shei*, it would violate the Wh-Island Constraint. Obviously, *xi-bu-xi-huan* can take matrix scope in (76).

The ungrammaticality of (78) below shows that A-not-A questions are subject to the Complex NP Constraint:

(78)= Huang (1982b, (81))

*[_S[_{NP}[_S' ni mai-bu -mai de] shu] bijiao guik] ?

You buy-not-buy DE book more expensive

In sum, the questioned verb in A-not-A questions moves to CP at LF, providing one more evidence that verbs can move to specifiers of functional projections, much in the same way as wh-words.

13.5 Yafei Li's Analysis

Li (1991), reanalyzing Koopman's (1984) data, argues that predicate clefting in Vata involves movement of the verbal head to C. If indeed the verb moves to C of CP, why is it in complementary distribution with an extracted wh-phrase? On Li's account it would be possible to have a raised wh-word and a clefted verb in clause initial position at the same time since the former would be hosted by Spec CP and the latter would occupy C°. The fact that both items are mutually exclusive suggests that they would occupy the same position in a grammatical sentence (for arguments that this position is basically correct, see Baltin (1991)).

Moreover, if we extend Li's analysis to Tuki, we would have a clefted verb in Foc of FocP. Consider the following sentence:

(79)

Wénga	ówú	Mbárá	a-	mu-	énga	imwéne
do	FOC	Mbara	SM	P1	do	it

"Mbara DID it"

If the copied verb *wénga* is hosted by Foc° in the above sentence, where would *owu* go? Foc° cannot reasonably host both *wénga* and *owu*. It has to be the case that the copied verb raises to Spec and *owu* is hosted by Foc°. The Tuki data thus raise doubts about the validity of Li's account.

We need to qualify the SIC a little bit. For obviously, we do not want any head to adjoin to or substitute for maximal projections. We turn to this task next.

13.6 SIC, Case-Resistance Principle, Theta-Role-Resistance Principle

As already noted, assuming that V moves to Spec of CP or Spec of FocP is at odds with some version of Structure Preservation (see Chomsky (1986a) who refers to Emonds). Normally, only maximal projections can move to maximal projections. Similarly, only heads can adjoin to heads. Since we have assumed throughout that V can move to Spec, logically speaking we would also expect N to be able to raise to Spec. Given that we have no knowledge of an instance where N has been said to travel to Spec, we have to be able to explain why V raising to Spec is tolerated while N raising is strictly disallowed. One way of drawing a principled distinction between V and N would be to explain the differences between VPs and NPs in terms of theta theory and case theory. Notice that the head of VP, namely V, assigns theta-role and case to its complement NPs: a patient theta-role in most cases (but not always) and objective case. VP itself is assigned neither a theta -role nor case. Since VP is not assigned theta-role or case, it is natural to assume its head (V) is also not assigned neither. NP, on the other hand, is assigned a theta-role by an external theta-role assigner and case (per the case Filter of Rouveret and Vergnaud (1980)). Non-deverbal Ns do not contain any theta-grid that they can assign. As De Urbina notes, the difference between VP and NP can explain why movement of *which* out of *which movie* is impossible, making pied piping of the whole NP compulsory, while V may be raised without the whole VP. When an NP is theta-marked by a sister theta-assigner, theta-marking percolates down from the theta-assigner to all the items contained within NP. However, a theta-role is not directly assigned to a single item within NP. The same reasoning probably applies to case-marking. Since none of the items contained within NP is directly theta-role-assigned or case-marked, it follows that no item within NP may be raised out of NP because its trace will not be able to be transmitted a theta-role or case, and the extracted item will not be theta-role- assigned or case-assigned. The whole NP, on the other hand, may be extracted and because a theta-role and case are directly assigned to it, the variable created by its extraction is directly case-assigned and theta-role marked. The difference in behavior between N and V with regard to theta-role-marking and case-assignment can explain why V can raise to the specifier position of a functional maximal projection and N cannot. While NPs are directly case-assigned and theta-role-marked and therefore can be moved, Ns which receive case and theta-role only through

percolation cannot be moved. VPs, on the hand, are not assigned theta-role and case; Vs also are not theta-role and case-marked. Why aren't VPs and Vs assigned case and theta-role? With respect to case assignment, a principle proposed by Stowell (1981) accounts for the inability of VPs and Vs to receive case:

(80)

The Case-resistance Principle

Case may not be assigned to a category bearing a case-assigning feature.

To account for the incapacity of VPs and Vs to be theta -marked, let us propose the following principle:

(81)

The Theta – Role Resistance Principle

A theta-role may not be assigned to a category that can assign a theta-role.

Now we are in a position where we can answer the question: what licenses V-movement to Spec of FocP or CP? V is assigned neither case nor theta-role and thus can be fronted to Spec of FocP in Tuki and Spec CP in Basque. This finding complements the Specifier Identity Condition (SIC) in the sense that not all heads may substitute for the specifier position of a functional maximal projection: only those that are not assigned case or theta-role can travel to such a position. Heads in all languages, however, cannot move to the latter position, as evidenced by the fact that English and French (among other languages) do not display a verb focalization process à la Basque or Tuki. Hence the validity of the Verb Focusing Parameter.

13.7 The A/A' and V/V' System

Having now argued that syntactically extracted wh-phrases and clefted verbs substitute for the FP position in Tuki, it is appropriate to characterize the relationship that obtains between the raised elements and the positions they have vacated. Noting that the wh-phrase lands in an A'-position and locally binds a trace (or a resumptive pronoun) in an A-position, Koopman (1984), in her seminal work on the Kru languages, extends the A'/A terminology to the predicate cleft construction. She proposes that the landing site position of the clefted verb be called a V'-position. Since an A'-position must bind an A-position by virtue of the Map Principle (Sportiche (1983)), a V'-position must also bind a V-position. She therefore reformulates the Map Principle as follows:

(82)

Map Principle

An A'- or V'-position must bind an A-, or V-position, respectively.

Adopting essentially here the insights of Koopman's much important work, we will say that when a wh-phrase raises to FocP in Tuki, the latter position is an A'-position; when a focused verb moves to FocP, this landing site is then a V'-position.

13.7.1 Focus-V-Movement and the Empty Category Principle

Up to now, we have argued that a verb movement process is involved in Tuki Focus-V-Movement constructions. We have claimed that this movement is similar to extraction in Wh-Movement constructions. In the latter constructions, an operator (in A'-position) binds a variable in A-position:

(83)

a. áne _i	ódzu _i	Mbárá	a-	benám	x _i
who	FOC	Mbara	SM	hates	

“Who does Mbara hate?”

b. onúmútu	ódzu _i	Putá	a-	m(u)-	úna	x _i
man	FOC	Putá	SM	p1	kill	

“It is the man Puta killed”

In Tuki (as reported in Biloa (1989a, 1990)), resumptive pronouns can be syntactically bound by a wh-phrase in A'-positions. Thus resumptive pronouns can appear in the constructions exhibited above:

(84)

a. áne _i	ódzú _i	Mbárá	a-	mú-	benám	ómwéné _i
who	FOC	Mbara	SM	OM	hates	him/her

“Who does Mbara hate him/her?”

b. onúmútu	ódzu _i	Putá	a-	mu-	mú-	úna	ómwéné _i
man	FOC	Putá	SM	P1	OM	kill	him

“It is the man Puta killed him”

In any case, bear in mind that when extraction occurs from a properly governed position in Tuki, an empty category is licensed. However, if a wh-item is raised from a non-properly governed position, a resumptive pronoun **MUST** occur (in postpositional position):

(85)

a. * áné_i ódzu_i Putá a- má- dzárá ná x_i
 who FOC Puta SM P2 talk to

“Who did Puta talk to?”

b. áné_i ódzu_i Putá a- má- dzárá ná á_i
 who FOC Puta SM P2 talk to him

“who did Puta talk to him?”

Now consider the following two sentences:

(86)

a. áne_i ódzu_i x_i a- má- beté ná Pútá
 who FOC SM P2 sleep with Puta

“who slept with Puta?”

b. áné_i ódzu_i Mbárá a- mu- dzá ée x_i a- má- beté ná Pútá
 who FOC Mbara SM P1 say that SM P2 sleep with Puta

“* Who did Mbara say that slept with Puta?”

In Biloa (1991) it is claimed that Agr-S is a proper governor in Tuki. It properly governs empty categories in subject position, allowing thereby local extraction (86a) above), extraction over an overt complementizer ((86b) above) and accounting for the licensing of null thematic subjects in the language ((87) and (88) below):

(87)

a. Putá a- nambám orese
 Puta SM cooks rice

“Puta cooks rice”

b. [e] a- nambám orese
 SM cooks rice

“He/she cooks rice”

(88)

a. vakútu vá- nambám orese
 women SM cook rice

“Women cook rice”

b. [e] vá- nambám orese
 SM cook rice

“They cook rice”

Although Wh-constructions allow empty categories to be bound by elements in A'-positions, Focus-V-Movement constructions do not license empty verbal categories:

(89)

a. o-	námba	ówú	vakútu	vá-	nambám	orese
Inf.	cook	FOC	women	SM	cook	rice

“Women COOK rice”

b.*o-	námba	ówú	vakútu	x	orese
Inf.	cook	FOC	women		rice

Following Koopman (1984), we will argue that the ungrammaticality of (89b) is accounted for by the Empty Category Principle (ECP):

(90)

Empty Category Principle

a. Traces must be PROPERLY GOVERNED.

b. A PROPERLY GOVERNS B if and only if A governs B, or A and B are coindexed.

Essentially, the ECP states that traces created by NP-Movement and Wh-Movement must be either lexically governed or antecedent-governed.

Let us briefly illustrate how the ECP regulates the behavior of wh-traces for instance. Consider the following Tuki paradigm:

(91)

a. áne _i	ódzú _i	[_{IP} x[_{VP} a-	m(á)-iba	matúwa	ame]]
who	FOC		SM P2	steal car	my

“Who_i [_{IP} x_i[stole my car]]?”

b. áte _i	aye _i	[_{IP} Isomo	[_{VP} a-	m(á)-íba	x _i]]
what	FOC	Isomo	SM P2	steal	

“What did [_{IP} Isomo[_{VP} steal x_i]]?”

c. twí	ówú _i	[_{IP} Isomo	[_{VP} a-	m(á)-íba	matúwa	ame]x _i]]
how	FOC	Isomo	SM P2	steal car	my	

“How did Isomo steal my car?”

d. áne _i	ódzu _i	[o-	kambím[_{CP} ngi	[x _i [_{VP}	a-m(á)-	íba	matúwa	ame]]]]
---------------------	-------------------	-----	---------------------------	---------------------------------	---------	-----	--------	---------

who FOC SM astonish whether SM P2 steal car my

“*Who do [you wonder [_{CP} whether [x [_{VP} stole my car]]]]

Notice that we have oversimplified the structures of the constructions exhibited in (91). We have not assumed, for instance, that agreement and tense should head their own maximal projections. This will have no bearing on what follows.

In the above paradigm, local movement to the nearest A'-position (in this case FocP) is licensed since FocP which contains a coindexed antecedent properly governs the trace in subject position. Under this reasoning (91d) should be ruled out given that in this case of long-distance extraction the connection between the coindexed element in A'-position and the subject trace is broken up by an overt complementizer (*ngi* “whether”). However (91d) is licit. This can be accounted for if (as assumed above) Agr-S is a proper governor in the language. This explains why CP-trace effects are nonexistent in Tuki (for details see Biloa (1991)). In (91b), the object trace is lexically governed by the verb *iba* “steal”. In (91c), the antecedent of the adjunct trace antecedent-governs the latter if we assume that IP is not a barrier to government in this sentence. However, in the following sentence, the movement of the adjunct is prohibited:

(92)

*twí_i ówú_i[o kambím[_{CP} ngi [_{IP} Isomo a- m(á)- íba matúwa ame]_{x_i}]]

how FOC you astonish whether Isomo SM P2 steal car my

“How do [you wonder [_{CP} whether[_{IP} Isomo stole my car]]]”

In (92), the wh-phrase has moved long-distance and in the process it has crossed a CP (which is a barrier in this case (see Chomsky 1986)). Crucially, the adjunct in (92) does not antecedent-govern its trace. Thus the ECP is violated and the sentence is ruled out.

Having briefly illustrated how the ECP operates with regard to the behavior of wh-traces, let us see how it can be extended to verbal traces.

Extending the ECP to verbal trace, Koopman (1984) proposes (93) below:

(93)

An empty verbal category is subject to the ECP.

Consider the ungrammatical (89b) (repeated here for convenience as (94)):

(94)

*o- námba ówú vakútu x orese

Inf. cook FOC women rice

Recall that antecedent government from clause initial position is possible in Tuki. So we should expect (94) to be salvaged by that option of the ECP. The illicitness of the construction suggests that antecedent-government is not enough in this case. And since lexical government is unavailable too, the sentence is ruled out by the ECP. This readily explains why in Focus-V-Movement constructions a (tensed) copy of the preposed verb must always occur in the clause.

13.7.2 Focus-V-Movement and the No-Free-Affix Principle

However, an ECP account of these facts seems to be problematic. If it is the case that verb-focusing is substitution for the Spec of FocP like *wh-* or focused phrases in Tuki, then it is not clear why antecedent-government is not available for the former but it is for the latter given that antecedent-government is basically subject to barrierhood. One could appeal to Lasnik's (1981, p. 162) No-Free-Affix Principle (see also Koopman 1984, p. 149) to explain the Tuki verb-focusing phenomena:

(95)

A morphologically realized affix must be realized as a syntactic dependent at Surface structure.

Now, assume that in verb-focusing constructions, the verb moves to (Spec, FocP) prior to its affixation to the inflectional heads. When the verb raises to (Spec, FP), AGR(ement) and T(ense) morphemes are left stranded in violation of the general S-structure constraint on affixal elements. Thus, a copy of the verb is inserted to support these inflectional heads. This approach enables us to dispense with the ad hoc stipulation that the antecedent – government clause of the ECP applies to *wh-* or NP- movement but not to V-movement.

Conclusion

In this chapter, we have analyzed verb movement in Tuki. Evidence has been provided that a focused verb substitutes for the specifier position of a maximal projection, much in the same way that *wh-*movement operates. Abundant data from Basque empirical material has corroborated the claim. To accommodate the Tuki and Basque empirical, we have proposed the Specifier Identity Condition (SIC) that assumes that specifiers of functional maximal projections are neutral with regard to the grammatical “function” of categories they might be called to host. Since the SIC is inoperative in those languages that do not display focusing constructions à la Tuki and Basque, a Verb Focusing Parameter has been suggested. The SIC would be the dividing line between Verb-Focussing-Languages and Non-Verb-Focussing-Languages. Moreover, an

answer to the following question has been provided: why can V travel to Spec whereas such movement of N seems to be prohibited? Essentially, it has been argued that the raising of a head to Spec is licensed if such a move does not violate Case Theory and Theta-Theory. V is assigned neither case (per the Case-Resistance Principle of Stowell (1981)) nor theta-role (per our Theta-Role Resistance Principle), consequently it can be raised to the specifier of a functional maximal projection. N, on the other hand, must be assigned both case and theta-role (albeit indirectly within NP) and thus cannot be fronted without violating Case Theory and Theta Theory.

Finally, we have argued that predicate clefting is regulated by the No-Free-Affix Principle.

Notes

1. Even if the direct object *cwí* “fish” is placed right after the verb in (7b), the sentence would still be ungrammatical:

(i)

*o- nyá cwí ówú Mbárá a- nyám cwí
 Inf. marker eat fish FOC Mbara SM eats fish

(i) Provides evidence that it is not the entire VP that is raised, only the verb is moved.

2. The adverb *ifundu* “much” cannot be repeated downstairs:

(i)

o- numa ifúndu ówú onguna o- má- numá (*ifúndu) ídzo
 Inf. shine much FOC sun SM P2 shine much yesterday

The same facts obtain in Vata (Koopman 1984). We have no explanation as to why an adverb can follow the extracted verb, but not an NP.

3. The material suggests that the fact that derivational but not inflectional morphemes can join the focused verb may suggest that there is a fundamental difference between them with respect to their representation. In particular, a difference between lexical versus syntactic affixation may be invoked in order to account for their distinct behavior. We have no real account of these facts, see Baker (1988).

4. It is mostly important to establish that what we call V-movement is not in fact VP-movement. Evidence that predicate clefting in Tuki is not VP-movement is provided by the fact

that the clause-initial verb can neither co-occur with a Subject Marker, a Tense Morpheme nor with its object (as illustrated in text and by the examples below):

(i)

a. o- nyá ówú vitsú tu- mu- nyá cwí ibísi aye
 Inf. eat FOC we SM P1 eat fish morning this

“We ATE fish this morning”

b. * tu- mu- nyá ówú vitsú tu- mu- nyá cwí
 SM P1 eat FOC we SM P1 eat fish

c. *o-nyá cwí ówú vitsú tu- mu- nyá cwí ibísi aye
 Inf. eat fish FOC we SM p1 eat fish morning this

The above examples clearly demonstrate that what is raised to sentence-initial position is a verb, rather than a verb phrase. The same facts obtain in Vata (as described by Koopman (1984)) (in the following Vata examples, tones are not marked):

(ii)

a. li a li- da zue saka
 eat we eat- past yesterday rice

“We ATE rice yesterday”

b. * li da a li- da zue saka
 eat- past we eat- past yesterday rice

(iii)

a. li a li saka
 eat we ate rice

“We ATE rice”

b. *li saka a li saka
 eat rice we ate rice

Predicate clefting is very different from VP-Preposing (or VP Topicalization) of the kind encountered in English. As indicated by Rochemont and Culicover (1990), in VP Topicalization

constructions, predicate phrases, adverbs, and multiple PPs and extraposed object relatives may topicalize with the rest of the VP:

(iv)= Rochemont and Culicover's (21)

- a. ..., and walk gracefully down the stairs, she did.
..., and walk down the stairs, she did gracefully
- b. ..., and run into the room, behind her, they did
..., and run into the room, they did behind her.
- c. ..., and run into the storeroom this morning that Mary was working in, an escaped convict did.

The above facts do not obtain in Tuki, providing thereby evidence that VP Topicalization (à la English) is distinct from predicate clefting (à la Tuki).

5. Koopman (1984) indicates that predicate cleft constructions in Vata have the same properties as *wh*-movement of NP. Focus-V-movement in Vata has the following characteristics (Koopman's (22), p. 161):

- (i) Predicate clefting of the matrix verb is always possible, provided the verb has a base form and no *wh*-phrase occurs in sentence-initial position;
- (ii) When there is a bridge verb, long predicate clefting is possible;
- (iv) A focused verb may not be related to an (identical) verb inside a *wh*-island;
- (v) A focused verb may not be related to an (identical) verb inside a Complex Noun Phrase .

Notice that a focus marker does not accompany the clefted verb in Vata (as it does in Tuki). Koopman notes that in Vata, the focused verb occurs in clause-initial position, a position to which either an extracted *wh*-item or a clefted verb may move, but both elements (a *wh*-item and a focused verb) may not occur at the same time in clause-initial position, a situation which is reminiscent of the Tuki data. But the picture is a little bit complicated than that: Koopman argues that COMP is sentence final in Vata, therefore if the focused verb occurs in sentence-initial position, it cannot occupy COMP. this means that Focus-V-movement and *wh*-movement in this language are movements to a position other than COMP (for an alternative viewpoint, see Yafei Li (1990) and Baltin (1991)).

We have argued here that *wh*-phrases and clefted verbs raise to a Focus Phrase (FocP), more precisely to the specifier position of FocP, the latter projection occurring between CP and IP. Furthermore, Tuki (unlike Vata) exhibits overt morphological evidence that Focus-V-

movement is the wh-type of V-movement: when a clefted verb and a wh-word are raised, an agreeing focus word accompanies them. Since the raised elements substitute for Spec, the agreeing focus words are thought to be the overt manifestation of SPEC-Head agreement.

6. This may be true for languages like English. However, the filter mentioned in the text does not extend to languages like Czech, Serbo-Croatian (see Rudin 1986) or Hindi (see Mahajan 1990) that freely front several wh-phrases in a single clause. As indicated in the text, Chomsky’s filter may be subject to parametric variation.

7. Ortiz de Urbina (1983) has followed the analysis developed by Horvath (1981) for Hungarian (which is similar to Basque). According to Ortiz de Urbina, a questioned item in Basque moves to an A-bar position left sister to V, a projection of the latter including both the verb and the focus position. For illustration, consider the following sentence:

- (i)
- | | | | | | |
|------|---|--------|-----|-------|------|
| Nor- | k | entzun | du | kanta | hori |
| who- | E | hear | aux | song | that |
- “Who has heard that song?”

Ortiz de Urbina (1983) analyzed the above sentences as involving movement of the wh-word from the A-position it occupies at D-structure to the A-bar focus position in V’:

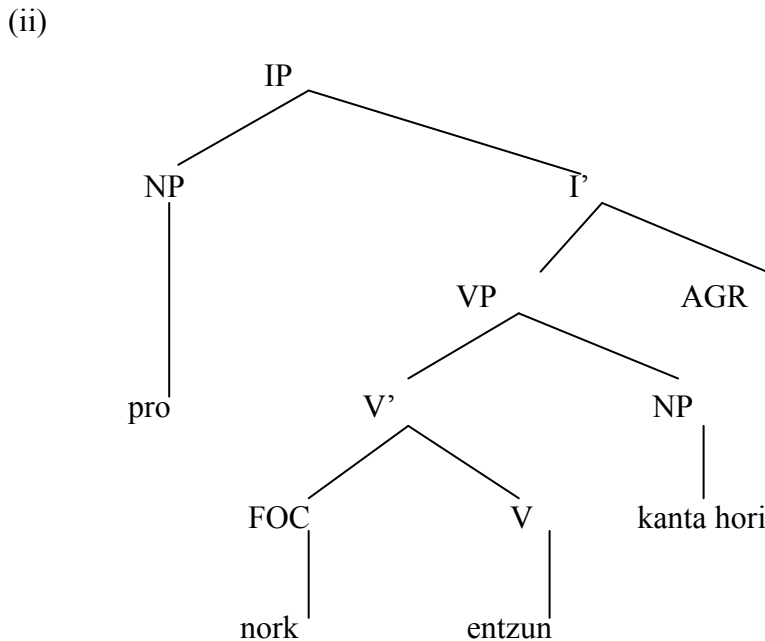

Notice that the wh-item has undergone a type of “downward” movement to a position from which it cannot c-command its trace. Ortiz de Urbina argued that the above structure is

possible because Basque is a null subject language and therefore the content of an empty category created by the movement of the wh-element can be identified as pro. As he pointed out, the situation is reminiscent of the case of postposed subjects in Romance languages like Spanish:

(iii)

[e] I VP[viene] Juan]]

In (iii) [e] is not c-commanded by Juan. [e] cannot be PRO, because it is governed by I, not a trace, since it is free. The content of [e] can be recovered by AGR and [e] is an empty pronominal pro.

8. In fact, Ortiz de Urbina assumes that Basque has a nonlexical structure like this one:

(i)

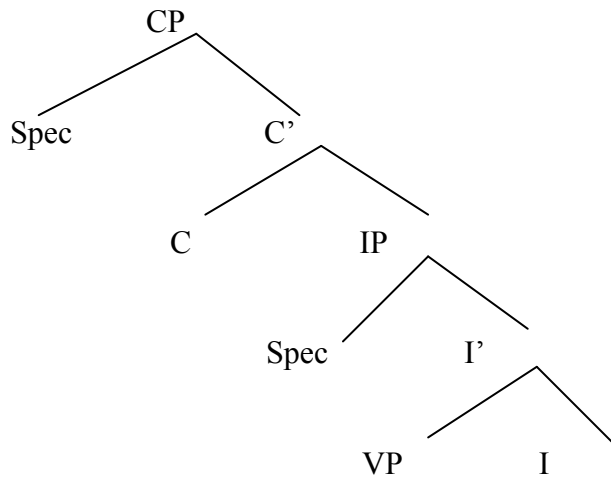

Notice that the above is both head-initial (C) and head-final (I). We have not been able to determine what pushed de Urbina to adopt this structure.

9. Here are the D-structure, S-structure and LF representations of (60):

(i)

D-structure

[_{IP}[_{Spec} Nork-k [_{I'}[_I[_{VP} entzun du kanta hori]]]]]

Who-E hear aux song that

“Who-E has heard that song?”

(ii)

S-structure (à la Horvath (1981), Ortiz de Urbina (1983))

[_{IP}[_{Spec} pro [_{I'} [_I [_{VP} [_{V'} [_{FOC} *nork* [_{ventzun} [_{NP} *kanta hori*]]]]]]]]]]

(ii) assumes an analysis that moves foci and wh-items to an A-bar position left sister to

V.

(iii)

S-structure (à la Ortiz de Urbina (1989)):

[_{CP}[_{Spec} *nork*_i [_{C'}[_C 0 [_{IP} *t*_i [_{I'} [_I [_{VP} *entzun du kanta hori*]]]]]]]]

In (iii), the wh-element *nork* has raised from its D-structure position to Spec of CP, from which position it c-commands the trace left in subject position (and binds it legally). Thus (iii) as opposed to (ii) does not use a type of downward movement which (ii) favors. (ii) and (iii) produce two different LF representations. (61) (in the main text) is the LF representation that is derived from (ii). (ii) and (61) show that after undergoing downward movement, the wh-item *nork* has to raise to clause-initial position at LF for scope reasons. As argued in the text, these ping-pong movements create a violation of Binding Theory Principle C.

An LF representation that is derived from (iii) avoids the bad effects of ping-pong (downward-upward) movements. The wh-item *nork* is already in Spec of CP (the highest position in the clause), therefore it has scope over the entire sentence.

10. This process is reminiscent of what happens in English constructions such as:

(i)

a. what will John do?

b.

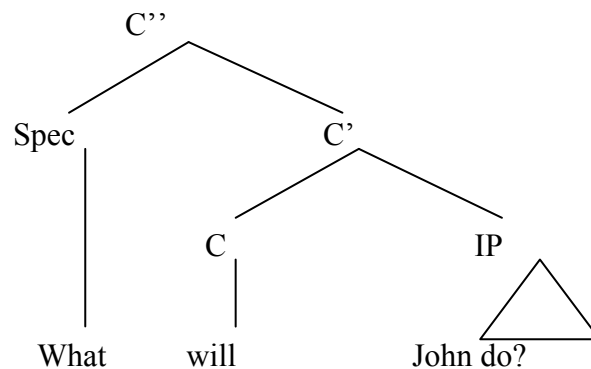

At D-structure, the modal *will* is in Infl. When it moves to C at S-structure, the process is known as I-to-C movement (see Chomsky 1986 among other references). It is generally assumed

that the raising of the modal *will* to C is caused by the movement of a wh-item or a null operator to Spec CP. Thus I-to-C movement in English is very similar to V/I-to-C movement in Basque.

11. Ortiz de Urbina indicates that “periphrastic verbs crucially differ from synthetic verbs in that inflection is borne by an auxiliary verb, which can occupy the ‘second’ position of the V2 analysis, so that, in principle, some verbal uninflected element can occupy the SPEC position in verb focalization” (p. 226).

CHAPTER FOURTEEN

Anaphora and Binding

Introduction

In this chapter, we analyze the ways in which anaphora and binding operate in Tuki. It is argued that AGR counts as SUBJECT in the determination of a governing category for pronouns in Tuki and does not count as SUBJECT for determining the governing category for anaphors. Thus an anaphor in subject position of an embedded clause may be long-distance bound by a superordinate syntactic subject because the embedded AGR is not a SUBJECT accessible to the anaphor. For Tuki anaphors then, a SUBJECT is the syntactic subject [NP, IP] or [NP, NP]. In this respect, Tuki patterns with Chinese (Huang 1982). For Tuki pronouns, the syntactic subject [NP, IP] or [NP, NP], or the AGR specification in INFL constitutes a SUBJECT. To capture the fact that the domain for anaphor binding and the domain for pronominal noncoreference are not the same in Tuki (though overlapping is possible), it is assumed with Chomsky (1986) that the minimal governing category (MGC) for X (a pronoun or an anaphor) is the least ‘complete functional complex’ (CFC) in which some indexing satisfies the binding theory. Thus the concept of ‘accessible subject’ and the notion of AGR as a binder are discarded, while the NIC is subsumed under the ECP under the assumption that anaphors undergo LF movement to the INFL position.

14.1. Application of the binding theory in Tuki

Consider the following sentences:

- (1) a. vátú va- m(u)- éna vamwámáte_i na ngéné
 men SM P1 see themselves in mirror²
 ‘The men_i saw themselves_i in the mirror’
- b. vátú va- mu- dzá éé [vamwámáte_i va- n(ú)- arám]
 men SM P1 say that themselves SM F1 come
 * ‘the men_i said that [themselves_i would come]’
- c. vátú va- mu- dzá éé [ngu- m(u)- éna vamwámáte_i]
 men SM P1 say that SM P1 see themselves
 * ‘the men_i said that [I saw themselves_i]’
- (2) a. [vátú va- mu- éna vamwéné_i]
 men SM P1 see them
 * ‘The men_i saw them_i’
- b. vátú va- mu- dzá éé [[e]_i va- n(ú)- arám]
 men SM P1 say that SM F1 come
 ‘the men_i said that they_i would come’
- c. vǎdzu_i va- mu- dzá éé [Mbárá a- mu- éna vamwéné_i]
 children SM P1 say that Mbara SM P1 see them

‘The children_i said that Mbara saw them_i’

In (1a) the lexical anaphor *vamwámáte* ‘themselves’ is lexically governed by the verb *va- m(u)- éna* ‘saw’. The governing category for the lexical anaphor *vamwámáte* ‘themselves’ is then the whole clause. Notice that *vamwámáte* ‘themselves’ is bound in its governing category, thereby complying with principle A of the binding theory. In (1b) the governor of *vamwámáte* ‘themselves’ is the embedded INFL; consequently the governing category for the lexical anaphor is the embedded clause. Since the anaphor is not bound inside its governing category, we should expect the sentence to be ungrammatical. However, the sentence is grammatical; we will come back to this problem in the next section. In (1c), the governor of the anaphor is the embedded verb *m(u)- éna* ‘saw’. Therefore, the governing category of the anaphor is the embedded clause. The lexical anaphor *vamwámáte* ‘themselves’ is bound out of its governing category, and as expected the sentence is ungrammatical in this specific case. In (2a), the pronoun *vamwéne* ‘them’ is not free in its governing category; therefore the construction is disqualified by principle B of the binding theory. (2b) – (2c) obey principle B, no disjoint reference interpretation being required since the pronouns are not bound in the embedded clause that is their governing category.

So far, we have seen that the governing category for an NP (anaphor, pronoun) is IP. There are, however, cases where the governing category is NP, as in the well-known English sentences exhibited below:

- (3) a. I saw [the men’s_i pictures of themselves_i/ each other_i]
 b. I saw [the city’s_i destruction t_i]
 c. *the men_i saw [my picture of themselves_i/ each other_i]
 d. *the city_i was seen [our destruction t_i]

- (4) a. *I saw [the men’s_i pictures of them_i]
 b. the men_i saw [my picture of them_i]

- (5) a. * I saw [his_i pictures of John_i]
 b. *he_i saw [my pictures of John_i]

The facts observed above for English, namely that a governing category for an NP can be NP, also obtain in Tuki:

- (6)
 a. Nû nga- tá- dingá [ngédénó ra Mbárá_i na wucó omwámáte_i]
 I SM Neg love walking of Mbara in front himself
 ‘‘I don’t like Mbara’s behavior toward himself’’
 b. *Mbárá_i a- tá- dingá [ngédénó ráme na wucó omwámáte_i]
 Mbara SM Neg love walking my in front himself
 ‘‘Mbara does not like my behavior toward himself’’

- (7)
 a. *Nû nga- tá- dingá [ngédénó ra Mbárá_i na wucó wáá_i]

I SM Neg love walking of Mbara in front his
 * “I do not like Mbara’s_i behavior toward him_i”
 b. Mbára_i a tá dingá [ngédénó ráme na wucó wáá_i]
 Mbara SM Neg love walking my in front his
 “Mbara does not like my behavior toward him”

(8)

a. *Nû nga- tá- dingá [ngédénó ráa_i na wucó a Mbára_i]
 I SM Neg love walking his in front of Mbara
 * “I do not like his_i behavior toward Mbara_i”
 b. * [e]_i a tá dingá [ngédénó ráme na wucó a Mbára_i]
 SM Neg love walking my in front of Mbara
 “He_i/she_i does not like [my behavior toward Mbara”

14.2. Problems

The binding theory as devised by Chomsky (1981) predicts that anaphors and pronouns occur in mutually exclusive domains. However, Chomsky (1980, 1981), Huang (1982), and others have presented instances where a possessive NP can be either an anaphor or a proximate pronoun. The same facts seem to obtain in the following Tuki sentences:

(9)

a. Mbára_i a- mu- kúsa [vakáráte váa_i]
 Mbara SM P1 buy books his
 “Mbara bought his books”
 b. Mbára_i a- mu- kúsa [vakáráte váámáte_i]
 Mbara SM P1 buy books his own
 “Mbara_i bought his own_i books”

In the sentences exhibited above, anaphors and pronouns are not mutually exclusive. In (9), the governing category is an NP and the lexical anaphor or the pronoun occurs as the possessive of an NP. The governor of the possessive is the head N. In the above sentences, the lexical anaphor is always bound out of its governing category. So only half of the above sentences comply with the requirements of the theory of binding: all pronouns are free within their governing category NP.

To accommodate problematic cases such as those mentioned, Chomsky (1981: 211f) proposes to modify the definition of governing category along the lines in (10), along with the two independent principles (11) and (12) and the notion of accessibility defined in (13):

(10) *Governing category*

Alpha is a governing category for *Beta* if and only if *Alpha* is the minimal category containing *Beta*, a governor of *Beta*, and a SUBJECT accessible to *Beta*.

(11) AGR is coindexed with the NP it governs.

(12) *The i-within-i well-formedness condition*:

*[a...b...], where a and b bear the same index.

(13) *Accessibility*:

Alpha is accessible to *Beta* if and only if *Beta* is in the c-command domain of *Alpha* and assignment of the index of *Alpha* to *Beta* would not violate the i-within-i condition.

The principle in (11) is meant to express the subject – verb agreement phenomenon, which is very transparent in Tuki:

(14)

a. mutu a- bangám
 man cll SM cries

“a man cries”

b. ímgbéme i- bangám
 lion SM cries

“a lion cries”

(15)

a. * mutu i- bangám
 *ímgbéme a- bangám

(14) and (15) are a patent illustration of the principle (11).

The i-within-i condition disqualifies cases of ‘referential circuitry’:

(16)

a. *[a picture of itself]_i

b. *I met [his own_i brother]_i

Chomsky defines the notion SUBJECT as the ‘most prominent nominal element’ within an NP or IP. The notion SUBJECT also includes AGR of a clause that contains it, or the syntactic subject [NP, IP] or [NP, NP].

The (b) sentence of (9), in which the anaphor is apparently bound out of its governing category, is no longer a problem for the binding theory as reformulated above. Above we said that in this sentence, the bracketed NP was the governing category for the lexical anaphor since it contains the anaphor and its governor. However, a SUBJECT accessible to the lexical anaphor is nonexistent in the bracketed NP. Therefore, the latter does not qualify as a valid governing category for the lexical anaphor. If we assume that the IP dominating the bracketed NP is the valid governing category of the anaphor in the (b) sentence of (9), we will obtain desirable results. In effect, the IP dominating the bracketed NP qualifies as the governing category for the anaphor because it contains a subject which c-commands the lexical anaphor. The latter is bound to the subject within its governing category which is IP. The i-within-i well formedness condition is not violated. So the binding theory can account for the grammaticality of these sentences. Can the theory also account for the sentences examined above, (1b)- (1c)?

In (1c) above, the bracketed IP qualifies as a governing category for the anaphor contained in it. The bracketed IP contains an accessible subject (of the embedded clause), which c-commands the anaphor, and coindexing the latter with the subject does not violate the i/i condition. However, (1c) is ungrammatical because the anaphor is not bound inside its governing

category. In (1b), the embedded bracketed IP is also the governing category for the anaphor. The AGR element is accessible to the lexical anaphor. AGR being the head of IP c-commands the subject anaphor in (1b). Now consider (17):

(17)

a. *vátú_i* *va-* *mu-* *dzá* *éé* [*vamwámáte_i* *va-* *n(ú)-* *arám*]
 men SM P1 say that themselves SM F1 come

‘*the men_i said that [themselves_i AGR_i would come]’

b. *munyínyí_i* *mu-* *tá-* *bungáná* *éé* [*mumwámáte_i* *mu-* *nu-* *gwám* *ísí* *ámó*]
 birds SM neg think that themselves SM AGR F1 die day some

‘*birds_i don’t think that [themselves_i AGR_i will die one day]’

(17a) is the representation of (1b) after the agreement rule (11) has applied. In Tuki, as well as in most Bantu languages, syntactic subjects agree in noun class with the verb. The latter carries an agreement prefix labeled subject marker (SM). In (17a)-(17b), coindexing the embedded subject anaphor with AGR does not violate the i-inside-i well-formedness filter. Thus AGR is accessible to the lexical anaphors *vamwámáte/mumwámáte* “themselves” in (17a)-(17b), validating thereby the claim that the clause of AGR is a governing category for these anaphors. We would expect (17a)-(17b), as well as (1b) to be ungrammatical (like their English counterparts) since the anaphor in each case is bound outside its governing category. However, the sentences are well formed, bringing about another potential bone of contention between the Tuki empirical material and the binding theory. Notice, furthermore, that the position occupied by the lexical anaphor above can be filled by an empty proximate pronoun, since Tuki can alternate empty pronouns with strong ones (contra what was argued in Biloa (1991:850)):

(18)

a. *vatu* *va-* *mu-* *dzá* *éé* [[*e*]_i *vá-* *n(ú)-* *arám*]
 men SM P1 say that SM F1 come

‘[the men said that they would come]’

b. *ngó_i* *í-* *ta-* *bungáná* *éé* [[*e*]_i *í-* *mú-* *gwám*]
 hens SM neg think that SM F2 die

‘Hens do not think that they will die’

a’. *vatu* *va-* *mu-* *dzá* *éé* [*vámwéné_i* *vá-* *n(ú)-* *arám*]
 men SM P1 say that they SM F1 come

“The men said that they would come”

b’. *ngó_i* *í-* *ta-* *bungáná* *éé* [*ímwéné_i* *í-* *mú-* *gwám*]
 Hens SM Neg think that they SM F1 die

“Hens do not think that they will die”

So, it seems to be the case that in Tuki, the same position may be filled either by a pronoun or by an anaphor:

(19)

a. Mbárá_i a b- [éé [_{IP} [e]_i a- t- ídzíma [_{CP} ngí [_{IP} omwámáte_i a- mú- ongubí]]]]

Mbara SM say that SM neg know if himself SM is thief

‘Mbara says that he does not know whether himself is a thief’

b. Mbárá_i a b- [éé [_{IP} [e]_i a t- ídzíma [_{CP} ngí [_{IP} [e]_i a mu ongubí]]]]

Mbara SM say that SM neg know if SM is thief

‘Mbara says that he does not know whether he is a thief’

In (19), the pronoun and the anaphor are mutually interchangeable without any resulting ungrammaticality. (19) seems, then, to be blind to the nominative-island condition (NIC):

(20). A nominative anaphor must be bound inside its clause.

The irrelevancy of the NIC is further illustrated below:

(21)

a. Mbárá_i a- mú- bánám [_{NP} okutu [_{CP} ódzú [_{IP} omwámáte_i a- mú- dínám]]]

Mbara SM F1 marry woman who himself SM F1 marry

‘Mbara will marry the woman that himself will love’

b. Mbárá_i a- mú- bánám [_{NP} okutu [_{CP} ódzú [_{IP} [e]_i a- mú- dínám]]]

Mbara SM F1 marry woman who SM F1 marry

‘Mbara will marry the woman that he will love’

In (19) *omwámáte* ‘‘himself’’ and the empty pronoun occur in an embedded tensed clause complement. In (21), the lexical anaphor and the empty pronoun both occur in subject position of a relative clause. Examples like (21) are utterly problematic for the NIC and the TSC. Notice that their Chinese counterparts, in contrast to the English ones, are also grammatical. Huang (1982) indicates that Chomsky’s (1981) formulation of a governing category involving the technical notion of SUBJECT can account for the Chinese facts. George and Kornfilt (1981) have observed that the presence of agreement in a clause determines opacity. Chinese does not show any subject-verb agreement. Therefore, INFL in Chinese does not contain [+AGR], irrespective of whether a clause is tensed or not. In a Chinese clause, then, a syntactic subject has no accessible SUBJECT. Anaphora is consequently possible between a subject NP in the main clause and an anaphor in subject position of an embedded clause in the Chinese counterparts of the Tuki sentences (19) and (21). Long distance anaphora is accounted for in Chinese by the binding theory since INFL is devoid of subject-verb agreement.

In contrast to Chinese, Tuki exhibits subject-verb agreement. Thus, wherever a clause is finite in Tuki, its INFL contains [+AGR]³. It is then evident that a syntactic subject in a Tuki clause has a SUBJECT accessible to it. Therefore an anaphor in subject position in an embedded Tuki clause should be bound in the latter since it constitutes its governing category. We should expect sentences like (19) and (21) to be ungrammatical. However, they are not. That anaphora is possible with a reflexive in the subject position of an embedded clause as in (19) and (21) suggests that the notion SUBJECT in Tuki corresponds to the syntactic subject [NP, IP] or [NP,

NP]; this is tantamount to saying that the AGR element in INFL does not play a role in the determination of a governing category for anaphors in Tuki.

Is anaphora possible with an anaphor in object position of an embedded clause? The ungrammaticality of (1c) suggests a negative answer.

The anaphor in (1c) is not bound by the subject accessible to it; it is rather bound out of its governing category, violating therefore principle A of the binding theory. So, it seems to be the case that the reflexive in object position of an embedded clause cannot be bound by a superordinate subject in Tuki.

We are left now with the problem of explaining why the (b) sentences of (19) and (21), in which a pronoun has replaced an anaphor, are grammatical. For if we assume, as we did for anaphors, that AGR does not count as a SUBJECT for determining a governing category for pronouns, then the whole IP in (19) and (21) will be the governing category for pronouns. The latter will be bound inside of their governing category, violating thereby binding principle B. But if AGR does count as a SUBJECT for determining a governing category for pronouns, then we can account for the grammaticality of the (b) sentences of (19) and (21). Thus, the subject marker (SM) that agrees in noun class with the empty pronoun in subject position stands for the AGR specification of INFL. The subject marker (AGR) is coindexed with the empty pronoun. The latter thus has a governing category that is the embedded clause since it contains a SUBJECT accessible to the pronoun, which though bound to the superordinate syntactic subject in (19) and (21) is nevertheless unbound in its governing category.

We still have to explain why AGR counts as SUBJECT in the determination of a governing category for pronouns in Tuki and does not count as a SUBJECT for determining the governing category for reflexives. We showed above that an anaphor in subject position of an embedded clause can be long-distance bound by a superordinate subject because the embedded AGR is not a SUBJECT accessible to the anaphor. What counts then as a SUBJECT for Tuki anaphors is the syntactic subject [NP, IP] or [NP, NP]. And what count as a SUBJECT for Tuki pronouns are the syntactic subject [NP, IP] or [NP, NP], and the AGR element in INFL. And more importantly, AGR seems to be inaccessible to Tuki anaphors. This amounts to saying that in Tuki, the governing category for anaphors is not always identical to the governing category for pronouns. The above conclusion makes perfect sense if we bear in mind that pronouns need no antecedents, whereas anaphors do. In effect, Lasnik (1976) has indicated that a theory of pronouns should be speechless about when coreference is possible; a theory of pronouns should determine only when disjoint reference is required.

14.3. Complete functional complex (CFC)

The above analysis is somehow too complicated and inelegant in some respects. In Chomsky (1986), it is assumed that the local domain for an anaphor or a pronominal X is the minimal governing category of X, a governing category being a maximal projection containing both a subject and a lexical category governing X and containing X. Chomsky indicates that a governing category is a 'complete functional complex' (CFC) in the sense that all grammatical functions compatible with its head are realized in it. The local domain for an anaphor or a

pronominal X in (22) below is the least CFC containing a lexical governor of X – the minimal governing category of X (MGC [X]).

(22)

- a. an anaphor is bound in a local domain;
- b. a pronominal is free in a local domain.

As we have indicated above, the position in which a pronominal cannot appear bound by its antecedent is distinct from the position in which an anaphor appears bound by its antecedent. The situation is illustrated in English by the following paradigm sentences:

(23)

- a. the children like [each other's friends]
- b. the children like [their friends]

Chomsky (1986) presents convincing arguments showing that (23a) violates the binding theory as formulated in Chomsky (1981). The embedded noun phrase counts as MGC (X) when X is the anaphor of the pronoun, since it contains a subject (the anaphor or the pronoun itself) and a governor of X, the head noun. But if the embedded noun phrase is the minimal governing category (MGC) for the anaphor, the latter will be bound out of its local domain, thereby violating binding principle A. So the theory correctly predicts that the embedded noun phrase is a legitimate minimal governing category (MGC) for the pronoun, but it wrongly predicts that the noun phrase is also the MGC for the anaphor in (23a). To remedy the situation, Chomsky proposes a revision of the binding theory to the effect that 'the relevant governing category for an expression X be the least complete functional complex (CFC) containing a governor of X in which X could satisfy the binding theory with some indexing (perhaps not the actual indexing of the expression under investigation)'. Thus in (23) for instance, the embedded noun phrase is the relevant governing category for the pronoun, while the whole clause is the relevant governing category for the anaphor.

Chomsky's (1986) reformulation of the binding theory is as follows: An expression E is indexed I; an indexing is an association of indices with phrases of E. The indexing I and the pair (X, Y) are compatible with regard to the binding theory if X satisfies the binding theory in the local domain Y under the indexing I:

(24) I is BT-compatible with (X, Y) if

- a. X is an anaphor and is bound in Y under I.
- b. X is a pronominal and is free in Y under I.

A category X is governed by a lexical category Z in the expression E with I under the following licensing condition:

(25) For some Y such that I is BT-compatible with (X, Y):

X is an anaphor or a pronominal and Y is the least CFC containing Z for which there is an indexing J BT-compatible with (X, Y).

(25) indicates that the relevant governing category for X (an anaphor or a pronominal) is the MGC in which some indexing could satisfy the binding theory. And the licensing condition (25) is applicable only if X has a governor.

Consider now the following sentences in which X is the complement or subject of N in an NP subject:

(26)

- a. the children thought that [_{IP}[_{NP} pictures of each other] were on sale]
- b. the children thought that [_{IP}[_{NP} each other's pictures] were on sale]
- c. the children thought that [_{IP}[_{NP} pictures of them] were on sale]
- d. the children thought that [_{IP}[_{NP} their pictures] were on sale]

In (26), X (anaphor or pronominal) is bound by the superordinate subject *the children*. (26a) – (26b) seem to violate the binding theory as outlined in (25). In both cases, the anaphor is bound outside its MGC, which is the IP containing a governor of *each other* and a subject. The indexing of *each other* with the AGR specification of the INFL head of the embedded IP is possible, just as the NP containing *each other* with the AGR element in INFL in (26a) – (26b) is ruled out by the ‘i-within-i condition’ (12) which prohibits coindexing of a phrase with a phrase that contains it. In (26a) – (26b), then, for the anaphor *each other* to be bound to the main subject *the children*, the MGC must be the main clause.

Chomsky, following Lebeaux (1983), assumes that anaphors undergo LF movement to the INFL position, leaving a trace. Differences in the properties of anaphors can be reduced to differences in conditions on S-structure and LF representation; A-positions at the LF level would be occupied by anaphor traces rather than overt anaphors. If principles A and B of the binding theory apply at LF, they will apply to the anaphor-trace condition, thereby eliminating the need for the NIC, though still satisfying the SSC. Chomsky’s suggestion that anaphors be raised at LF also dispenses with the option of having AGR count as an antecedent for the subject of a tensed clause in (24) and (25). Assuming that anaphors undergo move-WH at LF, an anaphor in subject position of an embedded clause will be barred in this position by the ECP. This line of reasoning makes interesting predictions for Tuki. Recall that the ECP excludes the trace of move-alpha in subject position of a subordinate clause in some languages. If it is proven that Tuki allows variables left in subject position of an embedded finite clause, then we could expect Tuki to license anaphors in that position too. The prediction is borne out:

(27)

- a. ǎndzu_i Mbárá a- búngánám éé x_i a- m(u)- éna Dimá
 who Mbara SM think that SM p1 see Dima
 ‘*who_i does Mbara think that x_i saw Dima’
- b. vísímbi_i ví- bungánám [éé [vimwámáte_i ví- n(ú)- éndám ná vitá
 soldiers SM think that themselves SM fl go to war
 ‘*the soldiers_i think that themselves_i will go to the war’

The LF representation of (27b) is the following:

(28)

visímbi_i [_{INFL} vimwámáte_i ví- bungánám [éé[x_i n(ú)- éndám ná vitá]]]
 soldiers themselves SM think that fl go to war

in (28), the lexical anaphor *vimwámáte* ‘themselves’ has been raised by LF movement to the INFL position, leaving a coindexed variable in subject position of the subordinate tensed clause. This variable is properly governed by the embedded INFL, in compliance with the ECP.

But is there real evidence that INFL is a proper governor in the language, apart from the lack of *that-trace* effects? If nonreflexive subjects can be extracted from WH islands (modulo subjacency at S-structure), evidence is gained for the claim that INFL is a proper governor in Tuki. The following sentence corroborates the position that INFL properly governs empty categories in subject position in the language:

(29)

[íya ámé]_i [nú nga- ti- ǐdzimá [CP[CP áté [IP x_i a- má -kúsa ná mbóó]]]
 mother my I SM neg know what SM P2 buy at market

‘My mother, I do not know what (she) bought at the market’

In the above sentence, the topic NP *iya ame* ‘my mother’ is extracted over the WH element *ate* ‘what’. Since antecedent government cannot obtain between *iya ame_i* and *x_i* because of the presence of *ate*, we have to conclude that *INFL properly governs x_i* for the purpose of ECP.

We have seen above that anaphors can occur in the subject position of *whether* clauses and relative clauses (see the example [21]) and that they undergo LF WH movement to the higher INFL where they are licitly bound by their antecedents. The variable left by the raising of the anaphors is properly governed by INFL. Given this analysis, one would expect that WH subjects can also be extracted from the subject position of *whether* clauses. This prediction is borne out:

(30)

ǎndzu_i Mbárá a- sésám ngí x_i a- dingám Putá
 Who Mbara SM asks whether SM loves Puta

‘* who does Mbara ask whether loves Puta?’

The above sentence is nicely accounted for in a framework that assumes that INFL is a proper governor.

Finally, recall that it was mentioned in section 2 and previous chapters that Tuki is a pro-drop language; its thematic subject may be empty:

(31)

a. Mbárá a- suwám tsónó ráá
 Mbara SM washes clothes his

‘Mbara is washing his clothes’

b. [e] a- suwám tsónó ráá
 SM washes clothes his

‘he is washing his clothes’

Bear in mind that in Tuki, the agreement features (gender, number, and person) agreeing with the subject NP are encoded on the verb. The subject markers (SM), which represent AGR, agree in noun class with the subject NPs. Jaeggli and Safir (1989) indicate that the referential value of a null pronominal must be recovered through identification. They argue that agreement affixes are identifiers in pro-drop languages. Essentially, the identification condition that they propose states that AGR can identify an empty thematic pronoun if the category which contains AGR case-governs the null pro. Thus the identification condition predicts that Tuki licenses pro in subject position because AGR, which is part of INFL, case-governs it; better, AGR properly governs the subject position. This provides *prima facie* independent evidence that INFL is a

proper governor (for more convincing arguments for Pro-drop involves proper government by INFL [AGR] in some cases, see Jaeggli and Safir (1989); Biloa (1991)).

Notice that it is not necessary to assume now that AGR is a binder. As argued by Chomsky, the analysis adopted here thus eliminates a redundancy between the ECP and NIC. Moreover, if AGR is no longer a binder, there is no need for the *i*-inside-*i* well-formedness condition, because the embedded clause will not be the MGC in (32):

(32)

Vǎdzu_i va- bungánám éé [IP [NP pútá rabúmáte_i i- serám wúsi]]
 children SM think that pictures their own SM sell well
 ‘The children_i think that their pictures_i sell well’

Chinese, Japanese, and Tuki present cases where the subject of a tensed clause can be either a bound pronoun or a bound reflexive:

(33)

a. Mbárá_i a- dǐngám [éé [[e]_i enda]]
 Mbara SM loves that go
 ‘Mbara wants to go’

b. Mbárá_i a- dǐngám [éé [omwámáte_i enda]]
 Mbara SM loves that himself go
 ‘Mbara wants himself to go’

As noted by Chomsky, an anaphor in the subject position of a tensed clause behaves in the manner of a WH trace. In this case, the NIC is reduced to the ECP.

To summarize, Chomsky’s (1986) reformulation of the binding theory is appealing with regard to Tuki in that it correctly predicts that the least CFC for an anaphor or a pronoun is the MGC in which the binding theory is satisfied by some indexing without any further speculation. Furthermore, the revisited binding theory dispenses with the need for the *i*-inside-*i* well-formedness filter and the notion of accessible subject; AGR is no longer a potential binder and may not act as an antecedent for the subject of a finite clause. Last, but not least, the NIC is subsumed under the ECP.

Notes

1. I am much indebted, for providing helpful comments and reviewing drafts of this chapter, to Joseph Aoun, Hajime Hoji, Osvaldo Jaeggli (†), and one reviewer of *Linguistics*. Thanks also go to Jim Huang, with whom I discussed material included here during his brief visit at USC. The usual disclaimers apply.
2. Jim Huang (personal communication) notes that there is no doubt that INFL in Tuki is richer than INFL in Chinese and Japanese. Japanese and Chinese show no number-person agreement. Japanese verbal paradigms inflect for tense/mood/aspect and negation, but there is no person or number agreement. As for Chinese, it has no agreement (Huang 1982; Jaeggli and Safir 1989).

(i) Japanese

yom-ru ‘read-present’
 yom-ta ‘read-past’

yom-anai	‘read-neg’
yom-eba	‘read-conditional’
yom-oo	‘read-imperative’
yom-itai	‘read-volitional’
yom-are	‘read-passive’
yom-ase	‘read-causative’

(ii) Chinese

xihuan ‘like’

Tuki verbal paradigms inflect for tense / aspect and negation and there is person – number agreement.

(iii) Tuki

ò- banga ----► obanga ‘to cry’
 infinitive stem

Present tense

m-	banga-	mí	‘I cry’	1sg
ò-	banga-	mí	‘you cry’	2sg
à-	banga-	mí	‘he / she cries’	3sg
tù-	banga-	mí	‘we cry’	1pl
nù-	banga-	mí	‘you cry’	2pl
và-	banga-	mí	‘they cry’	3pl

Negation : tá- ‘negation marker’

nù-	tá-	banga	‘I don’t cry’
ò-	tá-	banga	‘you don’t cry’
à-	tá-	banga	‘he / she doesn’t cries’
tù-	tá-	banga	‘we don’t cry’
nù-	tá-	banga	‘you don’t cry’
và-	tá-	banga	‘they don’t cry’

past tense : má- ‘past tense two marker’

nù-	má-	banga	‘I cried’	1sg
ò-	má-	banga	‘you cried’	2sg
à-	má-	banga	‘he /she cried’	3sg
tù-	má-	banga	‘we cried’	1pl
nù-	má-	banga	‘you cried’	2pl
và-	má-	banga	‘they cried’	3pl

Negation

nù-	tá-	má-	banga	‘I did not cry’	1sg
ò-	tá-	má-	banga	‘you did not cry’	2sg

`à-	tá-	má-	bàngà	‘he /she did not cry’	3sg
̀tù-	tá-	má-	bàngà	‘we did not cry’	1pl
nù-	tá-	má-	bàngà	‘you did not cry	2pl
và-	tá-	má-	bàngà	‘they did not cry’	3pl

CHAPTER FIFTEEN

Bound Variables

Introduction

In this chapter, we study the relationship between quantificationally bound pronouns and referential pronouns. It is demonstrated that bound variables and pronouns in coreference have very similar distribution with regard to Binding Theory. Following Aoun and Li (1993), we claim that referential pronouns are subject to an A-disjointness requirement, whereas bound pronouns obey a minimal disjointness requirement. Tuki pronouns must be free in the minimal domain in which they occur. Tuki anaphors must be bound to an accessible syntactic subject in the local environment in which they are contained. Long distance anaphors in Tuki can undergo Move Alpha at LF, and as such satisfy the locality principle. Short distance anaphors in Tuki do not raise at LF, and are strictly bound to the first available antecedent.

1. Pronouns in Coreference and Bound Pronouns

Let us consider the following sentences:

- (1) a. Mbára_i a- dingám nõsí wáá_i
Mbara SM love mother his
“Mbara_i loves his_i mother”
b. [mutu óngíma]_i a dingám nõsí wáá_i
man all SM loves mother his
“Everyone_i loves his_i mother”
- (2) a. Mbárá a- m(u)- údza éé [[e]]_i; a- dingám éé [[e]]_i; eta námbári
Mbara SM P1 say that SM love that go back tomorrow
“Mbara_i said that he_i wants to go back tomorrow”
b. ǎndzu_i a- m(u)- údza éé [[e]]_i; a- dingám éé [[e]]_i; eta námbári
who_i SM P1 say that SM love that go back tomorrow
“Who_i said that he_i wants to go back tomorrow?”

Tuki allows empty pronominal subjects as evidenced by (2a-b). In the (a) sentences, the antecedent of the pronoun is a name, *Mbára*. The name *Mbára* denoting some person in the real world, the pronoun *wáá* “his” and the empty subject pronominal [e] “he/she” also have the reference of *Mbárá*. In the (b) sentences, the antecedents of the pronouns, namely *mutu óngíma* “everyone” and *ǎndzu* “who” do not have a reference since they do not denote any person in the real world. Consequently, the pronouns depending upon these non referential antecedents are devoid of any reference. Quantificational noun phrases like *mutu óngíma* “everyone” and *ǎndzu*

“who” are said to denote extensions or a set of possible references. Pronouns construed as dependent on these quantificational noun phrases would denote whatever extension the Q-NP would denote, should a value be provided from among its set of possible references.

Pronouns of which the antecedents are names are called referential pronouns, whereas pronouns of which the antecedents are quantificational are called bound variables.

1.1 Referential Pronouns in Tuki

In the Government and Binding Theory of Chomsky (1981a), it is required that a pronoun be free (i.e. not c-commanded by an antecedent) in its governing category. The definition of governing category is provided in (3), along with the two independent principles (4) and (5), and the notion of accessibility defined in (6):

(3) *Governing Category*

Alpha is a governing category for *Beta* if and only if *Alpha* is the minimal category containing *Beta*, a governor of *Beta*, and a SUBJECT accessible to *Beta*.

(4) AGR is coindexed with the NP it governs

(5) The i-inside-i well-formedness condition:

*[*a...b...*], where *a* and *b* bear the same index.

(6) Accessibility

Alpha is accessible to *Beta* if and only if *Beta* is in the c-command domain of *Alpha* and assignment of the index of *Alpha* to *Beta* would not violate the i-within-i condition.

A reformulation of the binding requirement for pronominals is provided in Chomsky (1986):

(7) A pronoun must be free in the minimal Clause or NP containing this pronoun and a SUBJECT (where SUBJECT=AGR, [NP, IP] or [NP, NP]).

With the above in mind, consider the following examples:

(8)a. [ísá wá Putá_i] a- m(u)- énda na á_i ná mbóó

father of Puta SM P1 go with her to market

“Putá_i’s father went with her_i to the market”

b. Putá_i a- mú- kúsa wásá na wúco á [ísa wáá_i]

Putá SM P1 buy watch in front of father her

“ Putá_i bought a watch for [her_i father]”

In (a), the whole clause constitutes the governing category for the pronoun; although *Putá* does not bind the pronoun *a* “her”, for it does not c-command it. The pronoun is therefore free in its local domain, and binding principle B is not violated. In (b), the local domain of the pronoun is the bracketed NP. The pronoun is not bound inside that minimal NP; consequently the structure is well-formed.

(9) a. *Putá_i a- dingám ómwéné_i

Putá SM loves her

“*Putá_i loves her_i”

b. Putá_i a- bunganam ee [Mbárá a-dingám ómwéné_i

Putá SM think that Mbárá SM love her

“Putá_i thinks that [Mbárá loves her_i]”

c. [nۆsi wá Mbárá_i] a- dingám ómwéné_i

mother of Mbárá SM love her/him

“Mbárá_i’s mother loves her/ him_i”

d. nۆsi wáá_i a- dingám Mbárá_i

mother his SM love Mbárá

“His_i mother loves Mbara_i”

The (a) sentence is ruled out because the pronoun is bound in its minimal clause. In (b), the pronoun is free in its minimal clause; therefore Principle B is satisfied. In the (c) sentence, the whole clause is the local domain in which the pronoun should be free; *Mbara* is a potential binder, but does not c-command the pronoun, it does not bind it in its minimal clause. The same reasoning applies to (d). (c) and (d) are therefore well-formed.

Let us now consider cases where pronouns interact with R-expressions and wh-traces or variables. Recall that in Government and Binding Theory, R-expressions and wh-phrases must be A-free everywhere (Principle C):

(10) a. * [e]_i a dingám Mbárá_i

SM love Mbárá

“*He_i loves Mbara_i”

b. *ándzú_i [e]_i a dingám e_i?

who_i SM love

“*Who_i does he_i love e_i?”

c. *[e]_i a- bungánám éé Mbárá a- dingám Putá_i

SM think that Mbara SM love Puta

“*She thinks that Mbárá loves Puta”

d. *ándzú_i [e]_i a- bungánám éé Mbárá a- dingám [e]_i

who SM think that Mbárá SM love

“*Who_i does he_i think that Mbara loves e_i?”

All the sentences in (10) are ruled out because R-expressions are bound, violating thereby the strict requirement that they be unbound within any domain. (10b) and (10d) are instances of Strong Crossover: the movement of the Wh-phrase “crosses over” a coreferential pronoun as it moves into CP. Since the pronoun c-commands the variable left behind by wh-movement, the latter is A-bound, in violation of Principle C.

1.2. Bound Pronouns

Pronouns linked to quantificational NP(s) are generally considered as bound variables (Higginbotham 1980). They are subject to well-formedness conditions such as the following devised by Higginbotham (1980):

(11) “an occurrence of *B* of a pronoun will be interpreted as variable bound to $A=NP$, *A* quantificational; if and only if (i) *B* can be coindexed with *A* at LF, and (ii) at LF *B* is within the scope of *A*.”

B is within the scope of *A* in case *B* is c-commanded by *A* (MAY 1977). S-structures are mapped to LF by May’s (1977) Quantifier Raising Rule, among other rules. Quantificational NPs are assigned scope by the rule of Quantifier Raising which Chomsky adjoins to the node IP, leaving a trace. Aoun and Hornstein (1985) have argued that the rule of Quantifier Raising is “Clause-Bound” for the core cases. In (12) below from Higginbotham (1980:684), the quantifier *everybody* cannot bind the pronoun *him* because the scope of the embedded quantifier is the embedded clause. The quantificational NP *everybody* cannot be raised out of its embedded minimal clause, and so at LF cannot c-command the pronoun *him*:

(12) * somebody who liked everybody_i lent him_i money

Higginbotham observes that “any adequate theory of pronominal binding must imply...that a pronoun can be bound to a quantificational NP only if it could overlap in reference with a referential NP occupying the same position as the quantifier. Possibilities for binding form a subset of possibilities for overlapping reference- a proper subset.”

Consider the following sentences adapted from Higginbotham (1980):

- (13) a. *He_i expected to see him_i
 b. He_i expected Bill to see him_i
 c. *Someone_i expected to see him_i
 d. Someone_i expected Bill to see him_i

In (a), coreference between *he* and *him* cannot be purported. In (b), coreference is possible between *he* and *him*. In (c), *him* cannot be bound to the subject someone, but *him* is bindable in (d). Aoun(1986) has indicated that pronouns, whether referential or bound as in (13), are subject to Principle B of the Binding Theory. The same situation obtains in Tuki, where a pronoun may be linked to a Q-NP unless binding principle B is violated:

- (14) a. *[mutu óngíma]_i a- dingám ómwéné_i
 “*everyone_i loves him_i/her”
 b. *[mutu óngíma]_i a bungánám éé Mbará a- dingám ómwéné_i
 man all SM think that Mbara SM love him/her
 “everybody_i thinks that Mbara loves him_i/her”

Let us now consider the following Tuki sentence in which a quantificational NP is bound to an empty subject pronominal:

- (15)[mutu mo]_i a bunganam ee [e]_i a timbam péyó
 man some SM think that SM has intelligence
 “Somebody thinks that he is intelligent”

In Tuki, a Q-NP can also bind an overt pronominal:

- (16))[mutu mo]_i idzimam ee [nosi waa]_i a- nom
 man some knows that mother his SM sick
 “Somebody knows that his mother is sick”

Finally, “the reflexive” form *omwámáte* “himself/herself” can be linked to a quantificational NP in Tuki:

- (17) [mutu mo]_i a- m(u)- udza ee omwamate_i a- n(û)- arám
 man some SM P1 say that himself SM F1 come

“Someone_i said that himself_i would come”

It seems to be the case that bound pronouns in Tuki behave as referential pronouns; for (15), (16) and (17) are equally grammatical if the antecedent of the pronoun is not quantificational:

(18) a. Mbárá_i a- bungánám éé [e]_i a- timbám péyó

Mbara SM think that SM has intelligence

“Mbara_i thinks that he_i is intelligent”

b. Mbárá_i ø- ídzimám éé [nõsi wáá]_i a- nóm

Mbárá SM knows that mother his SM sick

“ Mbara_i knows that his_i mother is sick”

c. Mbárá_i a- m(u)- udza éé omwámáte_i a- n(û)- aram

Mbara SM P1 say that himself SM F1 come

“Mbárá said that himself would come”

Let us consider the environments in which the relation between a pronoun and a quantifier is possible.

1.2.1 Simplex Sentences

Let us consider the following paradigm:

(19) a. *[mutu mo]_i a- benám ómwéné_i

man some SM hate him

“*Somebody hates him”

b. [mutu mo]_i a- benám omwámáte_i

man some SM hate himself

“Somebody hates himself”

(19a) is ruled out because the pronoun is bound in its minimal clause, thereby violating the anti-locality requirement expressed in (7) or Principle B of the Binding Theory (Chomsky 1981a). In (19b), the quantificational NP may bind the lexical anaphor *omwámáte* “himself”, since the latter must be bound inside its local domain.

1.2.2 Embedded Contexts

In Tuki, a referential pronoun can occur in subject position of an embedded clause:

(20) a. Putá_i a- m(u)- údzá éé omwámáte_i a- nû nambám cwí

Putá SM P1 say that herself SM F1 cook fish

“Putá said that herself would cook fish”

b. Putá_i a- m(u)- údzá éé [e]_i a- nû nambám cwí

Putá SM P1 say that SM F1 cook fish

“Putá said that she would cook fish”

c. Putá_i a- m(u)- údzá éé onumutu waa_i a- nû- nambám cwí

Putá SM P1 say that husband her SM F1 cook fish

“Putá said that her husband would cook fish”

(20a) is similar to the Chinese sentence in (21), in that a lexical anaphor bound to the superordinate subject occurs in subject position of the subordinate clause:

(21) Zhangsan shuo ziji ao lai

“Zhangsan said that himself would come”

Huang (1982) has indicated that the AGR specification is absent in the Chinese INFL, so in (21) the embedded clause is not the minimal domain in which the anaphor should be bound. Rather, the local domain in which the anaphor in the embedded subject position must be bound is the matrix clause. According to Aoun (1986), Huang (1982), the locality requirement for Chinese reflexives is the following:

(22) An anaphor must be bound in the minimal clause or NP containing the anaphor and an accessible syntactic subject.

The above locality requirement surprisingly seems to operate in Tuki as illustrated by the well-formedness of (20a). Tuki, like English, is invested with subject-verb agreement¹:

(23)a. mutu a- nyám ngó

cl.1 man SM eat chicken

“A man eats chicken”

b. mbwa i- nyám ngó

cl. 9 dog SM eat chicken

“A dog eats chicken”

(24) a. *mutu i- nyám ngó

b. *mbwa a- nyám ngó

We would expect (20a) to be ungrammatical as its English counterpart:

(25)*John believes that himself will win the race

The grammaticality of (20a) suggests that the notion of AGR does not play a role in the determination of the local domain in which Tuki anaphors should be bound. If that proves to be true, then (22) is equally valid for Tuki. (20b) is grammatical because the empty subject pronominal is free in the embedded clause, thereby confirming the principle in (7) above that a pronoun be free in the minimal clause or NP in which it is contained with a SUBJECT. The same reasoning applies to (20c).

Let us turn now to cases where the bound variable is in the object position of the embedded clause:

(26) a. [mutu mo]_i a- m(u)- údza éé Putá a- benám ómwéné_i;

man some SM P1 say that Putá SM hates him

“Somebody said that Puta hates him”

b. *[mutu mo]_i a- m(u)- údza éé Putá a- benám omwámáte_i;

man some SM P1 say that Putá SM hates himself

“Somebody said that Puta hates himself”

The well-formedness of (26a) is predicted by binding theory. The ungrammaticality of (26b) nicely parallels the ill-formedness of cases where names like *Mbárá* are involved:

(27) *Mbárá_i a- m(u)- údza éé Putá a- benám omwámáte_i;

Mbárá SM P1 say that Putá SM hates himself

“Mbara said that Puta hates herself”

Coreferentiality between *Mbárá* and *omwámáte* “himself” is disallowed in (27) since the principle enunciated in (22) would be violated should it be allowed. Up to now, all the cases we have considered suggest that the binding requirement governing bound pronouns in Tuki parallels the binding requirement governing referential pronouns.

1.2.2 Complex NPs

Let us now consider complex noun phrases:

(28) Ad-nominal complements

a. [mutu mo]_i a- nu' dingám marú ama éé [e]_i a- mu- kaví nkata
man some SM F1 love story this that SM P1 succeed exam
“Somebody will like the story that he passed the exam”

b. [mutu mo]_i a- nú- dingám marú ama éé omwámáte_i a- mu- kaví nkata
man some SM F1 love story this that himself SM P1 succeed exam
“Somebody will like the story that himself passed the exam”

(29) Relative clauses

a. [mutu mo]_i a- nú- dingám mátúwa odzu [e]_i a- mú- kúsa
man some SM F1 love car which SM P1 buy
“Somebody will like the car which he bought”

b. [mutu mo]_i a- nú- dingám mátúwa odzu omwámáte_i a- mu' kúsa
man some SM F1 love car which himself SM P1 buy
“Somebody will like the car which himself bought”

As indicated in the above sentences, a bound variable (pronominal or anaphor) occurs in a relative clause or in the sentential complement of a noun. Chomsky (1981) has argued that anaphors must be bound in the environment of an accessible subject. The notion of accessibility as defined in (6) above states that a subject is accessible to an anaphor if it c-commands the latter, and coindexing of the subject and the anaphor must be in compliance with the *i*-inside-*I* well-formedness condition (see (5) above). Huang (1982) has shown that “the domain for defining anaphor and the domain for defining pronominal non-coreference are not identical, they overlap to a large extent” (p. 336). To instantiate this claim, Huang (1982) proposes that the notion of governing category be given the form of (30):

(30) *Governing Category*

Alpha is a governing category for *Beta* if and only if *Alpha* is the minimal category containing *Beta*, and a SUBJECT which, if *Beta* an anaphor, is accessible to *Beta* (Huang, 1982:337).

(30) in effect suggests that the notion of accessibility be dispensed with regard to pronouns. This obviously entails that the *i*-within-*i* condition is irrelevant for pronouns. In (28a) and (29a), the

nominal head of the complex noun phrase counts as subject for the bound pronouns (see Huang, 1984; Aoun, 1986). The complex noun phrase is the minimal domain in which the pronoun should be free. The pronouns are free in that local phrase, therefore both sentences are grammatical².

In (28b) and (29b), the head of the complex NP cannot count as a subject accessible to the anaphor because coindexation of the latter with the former would violate the i-inside-i well-formedness condition. Since the head of the complex NP is not an accessible subject, this complex NP cannot be the minimal governing category in which the anaphor should be bound. The local phrase containing an accessible syntactic subject as required by (22) is the matrix clause. The anaphor is bound inside that matrix clause, consequently the constructions (28b) and (29b) are licit.

1.2.3 Simplex Noun Phrases

Let us consider the following simplex constructions:

(31) a. [mutu óngíma]_i a- dingám[nǒsi wáá_i]

man all SM loves mother his

“Everybody loves his mother”

b. Mbára a- dingám éé [mutu ongíma]_i ara na [nabéna wáá_i]

Mbara SM love that man all come with brother his

“Mbara wants everybody to come with his brother”

(32) . [mutu óngíma]_i a- m(u) udza éé [nǒsi wáá_i] a- tímám akúma

man all SM P1 say that mother his SM has wealth

“Everybody said that his mother is rich”

In (31a-b), the governing category for the pronoun is the NP indicated by the bracketing. The pronoun is free in that minimal phrase, as a consequence both sentences are well formed. As for (32), the local domain in which the pronoun should be free is the subordinate clause since the notion of accessibility is irrelevant for pronouns. In the embedded clause then of (32), there is a subject *nǒsí wáá* “his mother” and a pronoun *wáá* “his” and the pronoun is in that embedded domain, thereby licensing the whole construction.

(33) [mutu óngíma]_i a- m(u)- udza éé [isá wáamate_i] a- tímam adasa

man all SM P1 say that father his self SM has baldness

“Everyone said that his own father is bald”

In (33), *isá waamate* “his own father” cannot be coindexed with *waamate* “his self”; otherwise we would end up with a case of “referential circularity” of the type disallowed by the i-inside-i condition. So the anaphor *waamate* “his self” has no accessible syntactic subject in the subordinate clause. The matrix clause in (33), however, contains an accessible syntactic subject for the anaphor *mutu óngíma* “everyone”. In the matrix clause, the anaphor *waamate* “his self” is bound by the syntactic subject *mutu óngíma* “everyone”. The binding theory is satisfied³.

To summarize, we have shown here that Tuki pronouns linked to Q-NPs obey the binding requirements similar to the ones constraining the behaviour of pronouns in coreference.

Binding Theory in Tuki

- A) An anaphor must be bound in the minimal clause or NP containing this anaphor and an accessible syntactic subject.
- B) A pronoun must be free in the minimal NP or clause containing it.
- C) An R-expression is free.

2. Minimality

2.1 Locality

In this section, following essentially Aoun and Li (1993), we would like to consider the various ways in which the concept of minimality applies to the pronominal system in Tuki. As discussed above, referential pronouns and bound pronouns in Tuki have very similar distribution. So the following structures are equally allowed for both types of pronouns:

(34)	Contexts	RP	BP
a.	NP_i V [CP NP_i V NP]	+	+
b.	NP_i V[CP NP V NP_i]	+	+
c.	NP_i V [CP NP V[CP NP_i V NP]]	+	+

Consider now the sentences in (35) and (36) instantiating the contexts represented in (34):

(35) Referential Pronouns (RP)

a. Díma_i a- mu- údza éé [e]_i a- mu- kúsa árángá

Díma SM P1 say that SM P1 buy bicycle

“Díma_i said that he_i bought a bicycle”

b. Díma_i a- mu- údza éé ngu mú- dínga ómwéné_i

Díma SM P1 say that SM P1 love him

“Dima_i said that I like him_i”

c. Díma_i a- bungánám éé Mbárá a- mu- údza éé [e]_i a- má kúsa árángá

Dima SM thinks that Mbara SM P1 say that SM P2 buy bicycle

“Dima_i thinks that Mbara said that he_i bought a bicycle”

In the sentences (35a-c), referential pronouns are free in the embedded clause which is in this case then the minimal domain in which they should be free. Therefore these sentences are grammatical.

(36) Bound Variables (BP)

a. [mutu óngíma]_i a- mu- údza éé [e]_i a- má kúsa árángá

man all SM P1 say that SM P2 buy bicycle

“Everyone_i said that he_i bought a bicycle”

b. [mutu óngíma]_i a- bungánám éé Mbárá a- mu- údza éé [e]_i a- má- kúsa árángá

man all SM thinks that Mbara SM P1 say that SM P2 buy bicycle

“Everyone_i thinks that Mbara said that he_i bought a bicycle”

The bound pronouns in (36a-b) are all free in the minimal clause containing them, hence the well-formedness of the sentences in which they occur. This is again prima facie evidence that bound variables in Tuki and pronouns in coreference have identical distribution.

Aoun and Li (1993) have suggested that bound pronouns and referential ones obey the following disjointness requirement:

(37) a. *The A-disjointness Requirement*

A pronoun must be A-free in the least Complete Functional Complex (CFC) in which it occurs (see Chomsky; 1986).

b. *The A'-disjointness Requirement*

A pronoun must be A'-free in the least CFC containing a SUBJECT and the pronoun.

Along the lines of Aoun and Hornstein (1986), Aoun and Li indicate that bound pronoun must seek a c-commanding antecedent. Since the antecedent is quantificational, at LF it will undergo Quantifier Raising (May; 1977) and land in an A'-position. Bound pronouns, though seeking an A'-binder, must be A'-free in the minimal domain containing a SUBJECT, whereas pronouns in coreference must be free in the local domain in which they occur.

Let us now see whether Aoun and Li's system is relevant with regard to Tuki.

(38) a. Díma_i a- dingám omwámáte_i

Dima SM love himself

“Dima_i loves himself_i”

b. Díma_i a- dingám nõsi waámáte_i

Dima SM love mother his own

“Dima_i loves [his own]_i mother”

c. Díma_i a- mu- údza éé omwámáte_i a- dingám ákóndó

Dima SM P1 say that himself SM loves plantain

“Dima_i said that himself_i likes plantain”

d. Díma_i a- mu- údza na omwámáte_i éé [e]_i a- nyá ákóndó

Dima SM P1 say to himself that SM eat plantain

“Dima_i said to himself_i to eat plantain”

e. Díma_i a- bungánám éé Putá_j a- dingám_i omwámáte^{*/j}_i

Dima_i SM think that Puta_j SM love herself_j

“Dima_i thinks that Puta_j loves herself_j”

f. Díma_i ø- idzímám éé Putá a- bungánám éé omwámáte_i a- mu- íba moní

Dima SM know that Puta SM think that himself SM P1 steal money

“Dima_i knows that Puta thinks that himself_i stole the money”

Chomsky (1986), following Lebeaux (1983), claims that anaphors are raised at LF. In the following Tuki sentences, coindexing between the name, the lexical anaphor and the pronoun is licit:

(39) a. Díma_i a- idzímám éé omwámáte_i a- tá bená okutu wáá_i

Dima_i SM know that himself SM Neg hates wife his

“Dima_i knows that himself_i does not hate his wife”

b. Díma_i a- mu- údza éé omwámáte_i idzímám éé [e]_i a- timbám akúmá

Díma_i SM P1 say that himself think that SM has wealth
 “Díma_i said that himself_i knows that he_i is rich”

- c. Díma_i a- mu- údza na omwámáte_i éé [e]_i a- timbám akúmá
 Dima SM P1 say to himself that SM has wealth
 “Díma_i said to himself_i that he_i is rich”

We should expect the sentences (39a-c) to be ruled out if the A'-disjointness requirement on pronouns is relevant. After the LF movement of the lexical *omwámáte* “himself” to an A'-position, the logical form representations of (39) are:

- (40)a. [CP Díma_i omwámáte_i x_i ídzímám [CP éé x_i a- tá- bená okutu wáá_i]]
 Dima himself knows that SM Neg hate wife his
- b. [CP₁ Díma_i omwámáte_i x_i a m(u) údza [CP₂ éé x_i ídzímám [CP₃ [e]_i a timbám akúmá]]]
 Dima himself SM P1 say that knows SM has
 akúmá]]]
 wealth
- c. [CP₁ Díma_i omwámáte_i a- mu- údza na x_i [CP₂ éé [e]_i a- timbám akúmá]]]
 Dima himself SM P1 say to that SM has wealth
 “Díma_i himself_i said to that he is rich”

Recall that, INFL is invested with an AGR specification So the minimal domain in which the pronoun in the subordinate clause of (.39) and (40) must be A'-free is exactly the embedded IP, since that IP invariably contains AGR. Thus, the pronoun in each LF representation of (40) is A'-free in embedded clause. As a consequence, sentences (39a-c) are licit because the pronouns meet the A'-disjointness requirement. In Tuki, it is also possible to have a pronoun bound by a lexical anaphor *omwámáte* “himself” if a subject intervenes between the pronoun and the anaphor:

- (41) a. [IP₁ Mbárá_i a- mu-údza na omwámáte_i [CP éé [IP₂ Putá a- ta- nu- bāna ómwéné]]]
 Mbara SM P1 say to himself that Puta SM Neg F1 marry him
 “Mbara_i said to himself_i that that Puta would not marry him_i”
- b. [IP₁ Mbárá_i a- mu- údza na omwámáte_i [CP éé [IP₂ Putá dzímám [CP éé [IP[e]_i a-

Mbara SM P1 say to himself that Puta knows that SM
 mú ongúbí]]]]]]
 is thief

“Mbara_i said to himself_i that Puta knows that he_i is a thief”

The pronoun must be A'-free in IP2 and IP3 respectively. Since *omwámáte* “himself” is contained in IP1 both sentences are licit.

2.2 Minimal Disjointness

Aoun and Li (1993) argue that the A'-disjointness requirement must incorporate a minimality effect:

(42)a. A pronoun must be free from the most local A'-binder in the smallest CFC containing the pronoun and a SUBJECT.

“the most local A'-binder” is defined as:

A is the most local A'-binder of B if and only if there is no C such that A c-commands C, C commands B.

Aoun and Li predict, based on the minimal disjointness requirement, that coindexing between a QP and a pronoun is allowed in case a modal, negation and wh-element occur between them.

(43) a. [mutu ongímá]_i a- sésám ngí [e]_i a- mu- káví nkátá
 man all SM ask if SM P1 succeed exam

“Everyone asks if he bought a car”

b. [mutu ongímá]_i a- sésám owate [e]_i a- mu- kúsá matúwa
 man all SM ask why SM P1 buy car

“Everyone asks why he bought a car”

c. [mutu ongímá]_i a- sésám na áne [e]_i éndám n(a) adóngo
 man all SM asks with who goes to village

“Everybody_i asks with whom he_i goes to the village”

d. [mutu ongímá]_i a- sésám ate [e]_i a- nu- kusám na mbóó
 man all SM ask what SM F1 buy in market

“Everybody ask what he will buy in the market”

Assuming that wh-elements and quantifiers raise at LF, the logical form representations of (43a-d) are provided below:

(44) a. [mutu ongímá]_i[x_i a- sésám[ngi_j[x_j [e]_i a- mu káví nkátá]]]

“Everyone asks whether he passed the exam”

b. [mutu ongímá]_i[x_i a- sésám owate_j [[e]_i a- mu- kúsá matúwa x_j]]]

“Everyone asks why he bought a car”

c. [mutu ongímá]_i[x_i a- sésám [[n(a) áne]_j[e]_i éndám x_j n(a) adóngo]]]

“Everyone asks with whom he goes to the village”

d. [mutu ongímá]_i [x_i a- sésám [ate_j[[e]_i a- nú- kusám x_j na mbóó]]]

“Everybody asks what he will buy in the market”

In the LF representations exhibited above, a distinct A'-binder occurs between the pronoun and the quantifier, and as predicted by Aoun and Li, coindexing between the pronoun and the quantifier is licit in configurations of the following type:

(45) QP_i ...modal/negation/wh-element...pronoun_i

Aoun and Li also predict that sentences of the context in (a-b) below will be ruled out in natural languages:

(46) a. modal/negation/wh-element...QP_i...pronoun_i

b. QP_i...pronoun_i...modal/negation/wh-element

The Tuki empirical material does not seem to support the prediction made by (46a-b):

(47) a. [ngu- mú- wonom [ara[[mutu ongímá]_i a- mu- údzám éé [e]_i a- mú- kaví nkata]]]]]

SM F1 laugh when man all SM F1 say that SM P1 succeed exam

“I will laugh when everyone says that he passed the exam”

b.[mutu ongímá]_i a- mu- údza éé [[e]_i a- m(á) ídzímá [éé[ngu- nú- kaví nkátá]]]

man all SM P1 say that SM P2 know that SM F1 succeed exam

“Everyone said that he knew that I would pass the exam”

c. [mutu ongímá]_i a- mu- údza éé [[e]_i a- nú- ídzímá [éé[nga má kaví nkátá]]]]]

man all SM P1 say that SM F1 know that I P2 succeed exam
 “Everyone said that he would know that I passed the exam”

The LF representations of sentences in (47) are given in (48) below:

(48) a. [ngu- mu-_j x_j wonóm [ara[[mutu ongímá]_i x_i a- mú-_k x_k údzám éé[[mu_i [e]_i a- x_i kaví
 SM F1 laugh when man all SM F1 say that P1 SM succeed
 nkata]]]]

exam

b. [mutu ongímá]_i x_i a- mu-_j x_j údza ée m(á)_k [e]_i a- x_k ídzímá [éé[nú_i[ngu- x_i
 man all SM P1 say that P2 SM know that F1 SM
 kávím nkátá]]]

succeed exam

c. [mutu ongímá]_i x_i a- mu-_j x_j údza [ée [n(ú)_k [[e]_i a- x_k ídzímá [éé[ma-_i[nga
 man all SM P1 say that F1 SM know that P2 SM
 kávím nkátá]]]

succeed exam

In Tuki, all tenses, with the exception of the present tense, require the use of modals⁴. In all the LF representations of (48), the modal intervenes between the pronoun and the quantifier, in compliance with (45). This correctly ensures that the most local A'-binder for the bound pronoun is no longer the raised QP, but the modals mu_i , $m(a)_k$, and $n(u)_k$ respectively in (48a-c) are the most local A'-binders for the bound pronoun. The latter is A'-free, obeying therefore the minimal disjointness requirement. In the following sentences, wh-words and negative polarity items do not intervene between the quantifier phrase and the bound variable; however the constructions are grammatical because at LF, modals raise and act as the most local A'-binders for the pronoun.

(49) *Wh-elements*

a. [ǎndzú a- m(u)- úba [[mutu ongímá]_i údzá [éé[[e]_i a- ma- kaví nkátá]]]
 who SM P1 hear man all say that SM P2 succeed exam

“Who heard everyone say that he passed the exam”

b. [mutu ongímá]_i a- m(u)- údzá [éé [e]_i a- mu sésám [ngí[ngu mu káví nkáta
 man all SM P1 say that SM P1 ask if I P1 succeed exam

“Everyone said that he asked whether I passed the exam”

(50) *Negation*

(51) a. nga- tá- [ídzíma éé [mutu ongímá]_i a- m(u)- údzá [éé [e]_i a- má- káví nkátá]]]
 SM Neg know that man all SM P1 say that SM P2 succeed exam

“I don’t know that everyone said that he said that he passed the exam”

b. [mutu ongímá]_i a- m(u)- údzá [éé[e]_i a- má- ídzíma éé nga- ta- nu- káví
 nkátá]]]

man all SM P1 say that SM P2 know that SM Neg F1succeed
 exam

“Everyone said that he knew that I would not pass the exam”

Consider the LF representations of (49) and (50) respectively:

(51) a. [ǎndzú a- m(u)- úba [[mutu ongímá]_i[x_i údzá [éé[CP má_j[[e]_i a- x_j káví nkátá]]]]]
 who SM P1 hear man all say that P2 SM succeed exam

b. [mutu ongímá]_i[x_i a- mu- údzá [éé [CP mu_j[e]_i a- x_j mu- sésám [ngí [CP mu_k[ngu x_k
 man all SM P1 say that P1 SM P1 ask if P1 SM
 káví nkáta]]]]]]]
 succeed exam

(52) *Negation*

a. [nga- tá- [ídzíma éé [[mutu ongímá]_i[x_i a- mu- údzá [éé[e]_i [CP má_j[[e]_i a- x_jkáví
 SM Neg know that man all SM P1 say that P2 SM succeed
 nkátá]]]]]
 exam

b. [[mutu ongímá]_i [x_i a- mu- údzá [éé[[CP máj- [e]_i a- x_j ídzima éé [CPnu_k nga- ta-
_{x_k}
man all SM P1 say that P2 SM know that F1 SM
Neg
káví nkátá]]]]]]
succeed exam

In (51) and (52), the modals have been raised at LF to the CP position dominating the IP in which the bound variable occurs. The local A'-binders for the bound pronoun are thus the modals in the CP position. The raised QP is no longer then the most local A'-binder for the pronoun in (51) and (52), in compliance with the minimal disjointness requirement. This explains the grammaticality of the sentences in (49) and (50).

2.3 Short distance anaphors

We want to claim here that short distance anaphors do not raise at LF; consequently they must be bound by the first available antecedent in subject position.

2.3.1 Reflexive verbs

Some morphemes in Tuki change the nature of verbs. Virtually, all verbs in Tuki can become inherently reflexive⁵. It is just necessary to add to the infinitive the object agreement morpheme *wáá-* meaning “oneself”. Thus the verbs:

(53) wúná “to kill”; odinga “to love”; otúmá “to send”

are immediately transformed into reflexive verbs when attached to the morpheme *waa-*:

(54) waa-wúná “to kill oneself”; waa-dinga “to love oneself”; waa-otúmá “to send oneself.

(55) a. Mbárá, ísa_i a- a_i- dínga

Mbara father SM self love

“Mbara, father_i likes himself_i”

b. *Díma_i, nǒsi a- a_i- túma na waspíta

Dima mother SM self send to hospital

“Dima_i, mother send himself_i to the hospital”

c. Putá_i a- a-_i wunám na manóó

Putá SM self kill with work

“Putá kills herself with work”

2.3.2 Reciprocal verbs

Tuki exhibits a class of verbs whose meaning is equivalent to the English anaphor “each other”. A morpheme is added to the verb thereby allowing this one to have the meaning of a reciprocal. Thus the verb *odinga* “to love” becomes, when *-na* is added, *odinga-na* “to love each other”. As a convention, let us call such verbs reciprocal verbs. Do these so-called reciprocal verbs obey the locality requirement of the binding theory? Let us consider the following sentences:

(56) a. Mbárá na mutu mo va- díngá na- mí

Mbárá and man some SM love e.o. asp

“Mbárá and someone love each other”

b. Mbárá na Putá v- éna- na-mí

Mbárá and Puta SM see e.o asp

“Mbárá and Putá see each other”

c. Mbárá na Putá va- woro- no- mí pútá

Mbara and Puta SM take e.o. asp pictures

“ Mbara and Puta take each other’s pictures”

In the above sentences, the reciprocal morpheme is bound to the subject marker of the verb which in turn (agrees with) refers to the syntactic subjects. It is then clear that the reciprocal is bound in its minimal domain, in accordance with the binding theory.

3. Conclusion

In this chapter, we have argued that Tuki pronouns linked to quantificational noun phrases obey the binding requirements identical to the ones constraining the behaviour of referential pronouns. Adopting the framework devised by Aoun and Li (1993), we have shown that the interpretation of Tuki pronominals is regulated by an A-disjointness requirement and a minimal disjointness requirement. A pronoun must be free in its minimal domain, whereas an anaphor must be bound in its local domain. Following Lebeaux (1983), Chomsky (1986), we have claimed that Tuki long distance lexical anaphors must raise at LF, thereby satisfying the minimality principle. Let us consider the following sentences:

(57) Mbárá a- mu- údza éé Putá a- má- búngána éé omwámáte a- nú- gwám

Mbara SM P1 say that P. SM P2 think that himself SM F1 die

“Mbara said that Puta thought that self would die”

(58)a. [Mbárá a- mu- údza[éé [Putá_i omwámáte_i a- ma- búngáná [éé x_i a- nú- gwám]]]]

Mbara SM P1 say that Puta herself SM P2 think that SM F1 die

“Mbara said that Puta herself thought that he would die”

b. Mbárá_i omwámáte_i a m(u) údza[éé [Putá a má búngáná [éé x_i a nu gwám]]]]

Mbara himself SM P1 say that Puta SM P2 think that SM F1 die

“ Mbara_i himself_i said that Puta thought that he_i would die”

In (a), *omwámáte* “herself” is bound to *Putá*, while in (b) *omwámáte* “himself” is bound to *Mbara*. As pointed out by Aoun and Li, the minimal disjointness requirement is trivially satisfied for pronouns in coreference, since they are not A’-bound.

The analysis adopted above with respect to the wh-movement of anaphors at LF makes interesting predictions with regard to that-trace phenomena. It can predict that if long distance anaphors can raise at LF in a given language, the latter will be blind to ECP violations in CP-trace configurations. The prediction is borne out in Chinese and Tuki:

(59) andzú_i Mbara a- bunganám [ee [x_i a- nú- bánám Púta]]

Who Mbara SM thinks that SM F1 marry Puta

“*Who_i does Mbara think that x_i will marry Puta?”

NOTES

1. Consider for instance the conjugation of the verb *onya* “to eat” in the present tense:

nyám	“I eat”
onyám	“you eat”(2 nd pers. Sg)
anyám	“he/she eats”
tunyám	“we eat”
nuyám	“you eat”(2 nd pers. Pl.)
ványám	“they eat”

The above Tuki paradigm shows number-person agreement.

2. In the case of pronouns/anaphors *not* c-commanded by their antecedent, the following structures obtain:

Q-NP

Referential NP

Pronoun	*	OK
Reflexive –NP	*	*

The cases we are thinking about here are so-called weak-crossover structures:

(i)a. * ísa wáá_i a- dínɡám [mutu ongíma]_i

father his SM loves man all

“His father loves everybody”

b. * ísa wáá_i a- dínɡám [andzu_i]

father his SM loves who

“His father loves who”

c. * omwámáte_i a- dínɡám [mutu ongíma]_i

himself SM loves man all

“Himself loves everybody”

d. * omwámáte_i a- dínɡám [andzu_i]

himself SM loves who

“Himself loves who?”

e. * nǒsi wáámáte_i a- dínɡám Mbára_i

mother herself SM loves Mbara

“Her mother loves Mbara”

(ii) nǒsi wáa_i a- dínɡám Mbára_i

mother his SM loves Mbara

“His mother loves Mbara”

A detailed account of the weak crossover phenomena in Tuki has been given in a preceding chapter and therefore is beyond the scope of this chapter.

4. Notice that these results may not be attributed solely to the presence of modals. Note what happens in simplex contexts:

[CP QP_i...[NP pron_i...]] as per our description in the text.

5. The argument structure of these verbs surely changes.

REFERENCES

- Abney, S.P. (1987). *The English Noun Phrase in its Sentential Aspect*. Ph.D. dissertation, MIT.
- Aboh, Enoh, O. (1996a). "A propos de la syntaxe du Gungbe." *Rivista di Grammatica Generativa* 21 :3-56
- Aboh, Enoh O. (1996b). "On Argumental Topicalization in Gungbe." *GenGenP* 2:80-93
- Aboh, Enoh, O. (1998a). "Focus Constructions and the Wh-Criterion in Gungbe". *Linguistique Africaine* 20:5-50
- Aboh, Enoh, O. (1998b). "On the Syntax of Gungbe Noun Phrases." *GenGenP* 6:1-28
- Aboh, E. O. (2003). "Focus constructions across Kwa". In Chege Githiora, Heather Littlefield & Victor Manfredi (eds.) *Kinyira njira!- Step firmly on the pathway! Trends in African Linguistics* 6: 7-22. Trenton, NJ: Africa World Press.
- Aboh, Enoh, O. (2004a). *The Morphosyntax of Complement-Head Sequences: Clause Structure and Word Order Patterns in Kwa*. New York. Oxford University Press.
- Aoun, J., N. Hornstein, and D. Sportiche. (1980). Some Aspects of Wide Scope Quantification. *Journal of Linguistic Research* 1, 69-95.
- Aoun, J. and D. Sportiche. (1983). "On the Formal Theory of Government." *The Linguistic Review* 2.3.
- Aoun, J., N. Hornstein, (1985). "Quantifier Types," *Linguistic Inquiry* 16, 623-636
- Aoun, J., N. Hornstein, D. Lightfoot, and A. Weinberg. (1987). "Two Types of Locality". *Linguistic Inquiry* 18 537-577.
- Aoun, J. and Yen-hui Audrey Li (1993) "Three Cases of Logical Relations: Relative Scope, Bound Pronouns and Anaphoric Relations." *Natural Language and Linguistic Theory*, 11:175-195
- Aoun, J. and Yen-hui Audrey Li (2003) *Essays on the Representational and Derivational Nature of Grammar. The Diversity of Wh-Constructions*, The MIT Press, Cambridge.
- Aoun, J. (1986). *Generalized Binding*. Dordrecht. Foris Publications.
- Authier, J.M.P. (1987). "Null Object Constructions in Kinande", *NLLT* 6, 19-37.
- Baker, M. (1989). "Object Sharing and Projection in Serial Verb Constructions", *LI* 20

- Baker, C.L. (1970). Notes on the description of English questions; The role of an abstract question morpheme. *Foundations of Language* 6, 197-219.
- Bauman and Westermann. (1967). *Les Peuples et les Civilisations de l'Afrique, Les Langues et l'Education*, Payot, Paris
- Belletti, A. and L. Rizzi. (1981). "The Syntax of ne: Some Theoretical Implications". *Linguistic Review* 1: 117-154.
- Bernstein, J. (1991). DPs in French and Walloon: Evidence for parametric variation in nominal head movement. *Probus* 2, 1-26
- Bernstein, J. (1993). Topics in the Syntax of Nominal Structure across Romance. Ph. D. dissertation, City University of New York.
- Bernstein, J. (1997). "Demonstratives and Reinforcers in Romance and Germanic languages." *Lingua* 102:87-113
- Bilola, E. (1989). "Tuki Gaps: Null Resumptive Pronouns or Variables?", *Studies in the Linguistic Sciences*, Vol. 19, Number 2.
- Bilola, E. (1991). "Null Subjects, Identification and Proper Government" *Linguistics* 29, number 1
- Bilola, E. (1993). "Resumptive Pronouns in Tuki", *Studies in African Linguistics*.
- Borer, H. (1979). "Restrictive Relatives in Modern Hebrew", *NLLT* 2: 219-260
- Brandi, L. and P. Cordin. (1981). "Dialetti e italiano: un confronto sul parametro del soggetto null". *Revista di grammatica generativa* 6: 33-87.
- Brandi, L. and P. Cordin. (1989). "Two Italian dialects and the Null Subject Parameter". In *The Null Subject Parameter*, ed. O. Jaeggli and K. Safir (Kluwer).
- Bresnan, J.W. (1970). On Complementizers: Toward a syntactic theory of complement types. *Foundations of Language* 6, 297-321
- Bresnan, J.W. (1971). Sentence stress and syntactic transformations. *Language* 48: 326-342
- Bresnan, J.W. (1972). Theory of complementation in English syntax. Doctoral dissertation, MIT. (New YORK: Garland, 1979).
- Brody M. (1990). "Some Remarks on the Focus Field in Hungarian". *UCL Working Papers in Linguistics* 201-25.
- Brody M. (1995). "Focus and Checking Theory". In István Kenesei, ed; *Approaches to Hungarian*, vol 5. JATE, Szeged.
- Brousseau, Anne-Marie, & John S. Lumsden. (1992) "Nominal Structure in Fongbe." *The Journal of West African Languages* 22: 5-25

- Brugei, L. (1996). "Demonstrative Movement in Spanish: A Comparative approach." *University of Venice Working Papers in Linguistics* 6
- Bryan, M.A. (1959). *The Bantu Languages of Africa*. Oxford University Press.
- Burzio, L. (1986). *Italian Syntax*. Reidel.
- Campbell, R. (1996). "Specificity Operators in Spec DP." *Studia Linguistica* 2:161-188.
- Campos, H. (1986). "Indefinite Object Drop", *LI* 17, 354-359.
- Cardinaletti, A. & Ian Robert (1991). "Clause Structure and X-second." In Wynn Chao and Geoffrey Horrocks. Eds; *Levels of Representation*. Foris, Dordrecht.
- Cardinaletti, A. & Michal Starke (1996). "Deficient Pronouns: A view from Germanic. A Study in the Unified Description of Germanic and Romance." In Hoskuldur Thrainsson, Samuel David Epstein, & Steve Peter, eds; *Studies in Comparative Germanic Syntax. Studies in Natural Language and Linguistic Theory* 38. Kluwer, Dordrecht,
- Cardinaletti, A. & Michal Starke. (1999). "The Typology of Structural Deficiency: A Case Study of the Three Classes of Pronouns." In Henk Van Riemsdijk, ed., *Clitics in the languages of Europe*. Mouton de Gruyter, Berlin.
- Carstens, M.V. (1991). The Morphology and Syntax of Determiner Phrases in Kiswahili. Ph. D. dissertation, UCLA.
- Carstens, M. V. (2000). "Concord in Minimalist Theory." *Linguistic Inquiry* 31:319-355.
- Carstens, V.M. and K.K.W. Kinyalolo .(1989). "On IP Structure:Tense Aspect and Agreement", ms., Cornell and UCLA
- Choe, J.W. (1984). "LF WH-Movement: A case of pied piping?" ms.,University of Massachusetts, Amherst.
- Chomsky, N. (1965). *Aspects of the Theory of Syntax*, MIT Press.
- Chomsky, N. (1970). "Remarks on Nominalization" [Remarks] in Jacobs, R.A. and Rosenbaum,P.S. *English Transformational Grammar*,pp.184-221
- Chomsky, N. (1973). "Conditions on Transformations" In Anderson, S.R. and Kiparsky, P. (eds) *A Festschrift for Morris Halle*.Holt, Rinehart and Winston, New York, pp. 232-86.
- Chomsky,N. (1976). "Conditions on Rules of Grammar", *Linguistic Analysis* 2: 303-351.
- Chomsky, N. (1976). *Reflections on Language*. Fontana, London.
- Chomsky,N. (1977). "On Wh-Movement", In Culicover P.W. et al. eds. *Formal Syntax*, pp.71-132.
- Chomsky,N. (1981). *Lectures on Government and Binding*. Dordrecht:Foris.

- Chomsky, N. (1982). *Some Concepts and Consequences of the Theory of Government and Binding*, Linguistic Inquiry Monograph, MIT Press.
- Chomsky, N. (1986). *Knowledge of Language*. Praeger.
- Chomsky, N. (1986). *Barriers*. Cambridge, MA: MIT Press.
- Chomsky, N. (1988). "Some Notes on Economy of Derivation and Representation", ms., MIT. Appeared also as Chomsky (1989). in I. Laka and A.K. Mahajan (eds), *MIT Working Papers in Linguistics*, Vol. 10, 43-74.
- Chomsky, N. (1995). *The Minimalist Program*. MIT Press, Cambridge, Mass.
- Chomsky, Noam, & Howard Lasnik. (1993). "Principles and Parameters Theory". In Joachim Jacobs, Arnim von Stechow, Wolfgang Sternefeld, & Theo Vennemann, eds; *Syntax: An International Handbook of Contemporary Research*, Walter de Gruyter, Berlin, New York
- Chung, S. (1982a). "Unbounded Dependencies in Chamorro Grammar", LI 13 39-78.
- Cinque, G. (1994). "On the Evidence for Partial N-movement in the Romance DP." In Guglielmo Cinque, Jan Koster, Jean-Yves Pollock, Luigi Rizzi, & Raffaella Zanuttini, eds; *Paths towards Universal Grammar*. Georgetown University Press, Washington, D.C.
- Cinque, G. (1999). *Adverbs and Functional Heads. A cross-linguistic Perspective*. Oxford University Press. New York.
- Cinque, G. (2005b). 'The dual source of adjectives and phrasal movement in the Romance DP', ms., Ca Foscari University of Venice.
- Cinque, G. (2010). *The Syntax of Adjectives: A Comparative Study*.
- Clements, N. and K.C. Ford. (1979). "Kikuyu Tone Shift and its Synchronic Consequences", LI 10. 2, 179-210.
- Cole, P. (1982). "Subjacency and Successive Cyclicity: Evidence from Ancash Quechua", *Journal of Linguistic Research* 2.4
- Cole, P. (1987). "Null Objects in Universal Grammar", LI 18, 597-612.
- Comrie, B. (1976). "The Syntax of Causative Constructions: Cross-Language similarities and differences". In Shibatani 1976: 261-312.
- Crisma, P. (1991). Functional Categories inside the Noun Phrase: A study on the Distribution of Nominal Modifiers. Ph. D. dissertation, University of Venice.
- Crisma, P. (1996). "On the Configurational Nature of Adjectival Modification." In Karen Zagana, ed ; *Grammatical Theory and Romance Languages*. Benjamins, Amsterdam
- Delafosse. (1932). *Esquisse Générale des Langues de l'Afrique*. Paris.

- De rijck, R.P.G.(1978). "Topic Fronting, Focus Positioning and the Nature of the Verb Phrase in Basque". In *Studies on Fronting*, ed. By F. Jansen. Peter de Ridder Press, Lisse.
- Dobrovie-Sorin, C. (1987). "A propos de la structure du groupe nominal en roumain." *Rivista di Grammatica Generativa* 12 :123-152
- Dobrovie-Sorin, C. (1994). *The Syntax of Romanian: Comparative Studies in Romance*. Mouton de Gruyter, Berlin, New York.
- Durrleman, S. (1999). The Architecture of the Clause in Jamaican Creole. Mémoire de licence, University of Geneva
- Engdahl, E. (1980). *The Syntax and Semantics of Questions in Swedish*, Doctoral dissertation, University of Massachusetts, Amherst.
- Engdahl, E. (1983). "Parasitic Gaps", *Linguistics and Philosophy* 6, 5-34.
- Engdahl, E. (1984). "Parasitic Gaps, Resumptive Pronouns, and Subject Extractions", *Linguistics*.
- Engdahl, E. and E. Ejerhed .(1982). *Readings on Unbounded Dependencies in Scandinavian Languages*, Umea, Stockholm, Sweden.
- Epée. (1975). Generative syntactic studies in Duala. Ph.D. dissertation, Cornell.
- . Epée. (1976a). On some rules that are not successive cyclic in Duala. *Linguistic Inquiry* 7, number 1.
- Epée. (1976b). A counter example to the Q replacement and COMP substitution universals. *Linguistic Inquiry* 7, 677-685.
- Essono, J-J. (1974). *Description Phonologique du Tuki. Ati*. Yaoundé. Université de Yaoundé. Mémoire de D.E.S.
- Essono, J-J. (1980). *Morphologie Nominale du Tuki. Manuscript*, Université de Yaoundé.
- Fabb, N.(1990). "The Difference Between English Restrictive and Non restrictive Relative Clauses", *Journal of Linguistics*.
- Farrell, P.(1990). "Null Objects in Brazilian Portuguese", *NLLT* 8, 325-346.
- Fiengo, R., J. Huang, H. Lasnik, T. Reinhart .(1989). "The Syntax of Wh-in-situ". In WCCFL 7, Hagit Borer (ed.).
- Georgopoulos, C.(1983). "Trace and Resumptive Pronouns in Palauan", In A. Chkerman, M. Marks, and J. Richardson(eds.), *Papers from the Nineteenth Regional Meeting*, Chicago Linguistic Society, Chicago, pp. 134-145.

- Georgopoulos, C. (1984). "Resumptive Pronouns, Syntactic Binding, and Levels of Representation in Belau", In C. Jones and P. Sells (eds.), *Proceedings of North Eastern Linguistic Society* 14, Graduate Linguistic Student Association, Amherst, pp. 81-97.
- Georgopoulos, C. (1985). "Variables in Palauan Syntax", *NLLT* 3, pp.59-94
- Georgopoulos, C. (1989). "The ECP and Weak Crossover", manuscript, University of Utah.
- Grimshaw, J. (1991). *Extended Projections*. Ms. Rutgers University.
- Grosu, A. (1973). "On the Status of the SO-called Right Roof Constraint." *Language* 49:294-311.
- Grosu, A. (1988). "On the Distribution of Genitive Phrases in Rumanian.: *Linguistics* 26:931-949
- Guthrie, M. (1955). *The Bantu Languages of Western Equatorial Africa*. University Press, Oxford.
- Haik, I. (1984). Indirect Binding. *Linguistic Inquiry* 15.2
- Haik, I., H. Koopman and D. Sportiche (1988). "Anaphoric, Pronominal and Referential INFL". Mimeograph, UQUAM.
- Haik, I., H. Koopman and D. Sportiche (1985). "INFL en Moore et le liage dans le système A". *Rapport de recherche du groupe de linguistique africaniste*, année 1985-1986, Montréal.
- Hale, K. (1978). "On the position of Walbiri in a typology of the base", ms, MIT.
- Hawkins, J. (1983). *Word Order Universals*. Academic Press, New York, London
- Hawkins, J. (1990). "A Parsing Theory of Word Order Universals." *Linguistic Inquiry* 21:223-261
- Heny, F. (1971). *Focus and Relativization in Bali*. Paper read to the Second Conference on African Linguistics, University of California, Los Angeles.
- Higginbotham, J. (1980). "Pronouns and Bound Variables", *LI* 11.4.
- Higginbotham, J. and R. May (1981) "Questions, Quantifiers, and Crossing", *The Linguistic Review* 1.1.
- Higginbotham, J. (1983). *Logical Form, Binding and Nominals*, *LI* 14.3.
- Hoh, P.-S. and Wen-Yu Chiang (1990). "A Focus Account of Moved Wh-Phrases at S-Structure in Chinese", *Lingua* 81,47-73
- Hoji, H. (1985a). "Movement and Variable Binding in Japanese", ms., University of Massachusetts, Amherst.
- Hoji, H. (1985b). *Logical Form Constraints and Configurational Structures in Japanese*, Doctoral dissertation, University of Washington, Seattle.

- Horvath, J. (1981). *Aspects of Hungarian Syntax and the Theory of Grammar*. Unpublished Ph.D. dissertation UCLA.
- Horvath, J. (1986). *Focus in the Theory of Grammar and the Syntax of Hungarian*. Foris, Dordrecht
- Huang, J.(1982). Logical relations in Chinese and the theory of grammar. Ph.D.dissertation, MIT.
- Huang, J. (1984) “ On the distribution and Reference of Empty Pronouns”, LI 15, 531-575.
- Hyman, L.M. (1980). *Noun Classes in the Grassfields Bantu Borderland*, Southern California Occasional Papers in Linguistics 8.
- Jaeggli, O. (1980). On Some Phonologically Null Elements in Syntax. Ph.D.dissertation, MIT.
- Jaeggli, O. (1982). *Topics in Romance Syntax*. Dordrecht: Foris.
- Jaeggli, O. (1984). “Subject Extraction and the Null Subject Parameter”. NELS.
- Jaeggli, O.(1986). “Passive”, LI 17, 587-622.
- Jaeggli, O.and K. Safir (1989). *The Null Subject Parameter and Parametric Theory*. Kluwer.
- Jaeggli, O.and N. Hyman (1989). “On the Independence and Interdependence of Syntactic and Morphological Properties: English Aspectual *Come* and *Go*”, ms., USC and UCLA.
- Jackendoff, R.S. (1977) “Constraints on Phrase Structure Rules”, In Culicover P.W. et al.(eds.) *Formal Syntax*, pp.249-83
- Kayne, R.and J.-Y. Pollock (1978). “Stylistic Inversion, Successive Cyclicity, and Move NP”, LI 9:595-621.
- Kayne, R. (1984). *Connectedness and Binary Branching*, Foris, Dordrecht.
- Kayne, Richard,(1994). *The Antisymmetry of Syntax* . MIT Press, Cambridge, Mass.
- Keenan,E.L. and B. Comrie (1977). “ NP Accessibility and Universal Grammar” LI 8:63-100
- Kenstowicz,M. (1984) “The Null Subject Parameter in Modern Arabic Dialects”. NELS 14:207-219.
- Klima,E.(1964). Relatedness between grammatical systems. *Language* 40.
- Koopman, H.and D. Sportiche (1981) “Variables and the Bijection Principle”, *The Linguistic Review* 2, 135-170.
- Koopman, H. (1984). *The Syntax of Verbs: From Verb Movement Rules in the Kru Languages to Universal Grammar* Dordrecht: Foris.
- Koopman, H. (2000a). “The Internal and External Distribution of Pronominal DPs.” *In The Syntax of Specifier and Heads*. Routledge, London.

- Koopman, H. (2000b). *The Syntax of Specifier and Heads*. Routledge, London
- Kuno, S. (1973). *The Structure of the Japanese Language*, MIT Press, Cambridge.
- Laenzlinger, C. (1998). *Comparative Studies in Word Order Variation. Adverbs, Pronouns and Clausal Structure in Romance and Germanic*. Benjamins, Amsterdam.
- Laenzlinger C. (2000). French Adjective Ordering: Perspectives on DP-internal Movement Types. *Generative Grammar in Geneva 1*, 55-104
- Laenzlinger C. (2005a). French Adjective Ordering: Perspectives on DP-internal Movement Types. *Lingua* 115: 645-689
- Laenzlinger, C. (2005b). 'Some Notes on DP-internal Movement', *GG@G* 4:227-260
- Laenzlinger, C. (2006). 'Le role de l'interface syntaxe-structure informationnelle dans la variation de l'ordre des constituants dans la phrase', *Nouveaux Cahiers de Linguistique Francaise* 27 :53-81. Université de Genève.
- Lamarche, J. (1991). Problems for N^0 -movement to NumP. *Probus* 3: 215-236
- Lasnik, H. and M. Saito (1984) "On the nature of proper government". *Linguistic Inquiry* 15, 235-289.
- Leben, W. (1978). "The Representation of Tone". In V. Fromkin ed. *Tone: A Linguistic Survey*.
- Li, C. and S. Thompson (1976) "Subject and Topic: A New Typology of Language", In C. Li (ed.) *Subject and Topic* Academic Press, New York.
- Li, Y. (1990). Conditions on X^0 Movement. Ph.D dissertation. MIT
- Longobardi, G. (1994). "Reference and Proper Names: A Theory of N-Movement in Syntax and Logical Form". *Linguistic Inquiry* 25: 609-665
- Longobardi, G. (2001). "The Structure of DPs: Some Principles, Parameters and Problems." In Mark Baltin & Chris Collins, eds; *The Contemporary Handbook of Syntactic Theory*. Blackwell, Oxford.
- Mahajan, A.K. (1990). The A/A-Bar Distinction and Movement Theory. Ph.D. dissertation. MIT.
- May, R. (1977). The grammar of quantification. Doctoral dissertation, MIT.
- May, R. (1985). *Logical Form: its Structure and Derivation*. Cambridge, MA: MIT Press.
- Mc Closkey, J. (1978). "On the Binding of Resumptive Pronouns in Irish", *Glow*, New York, England.
- Mc Closkey, J. (1979). *Transformational Syntax and Model Theoretic Semantics*, Reidel, Dordrecht.
- Mc Closkey, J and K. Hale. (1984). "On the Syntax of Person-Number Inflection in Modern Irish", *NLLT* 4, 442-487.

- Mchombo, S. (2004). *The Syntax of Chichewa*. Cambridge: CUP.
- Meinhof, C. (1948). *Grundriss einer Lautlehre der Bantusprachen*. Leipzig: Deutschen Morgenlandischen Gesellschaft
- Mutaka, P. N. and P. Tamanji. (2001). *Introduction to African Linguistics*. Munchen: Lincom Europa.
- Myers, A. (1971). "Emphatics and Questions in Kikuyu", *In Proceedings of the Second Conference on African Linguistics, supplement #2*, 11-18.
- Nishigauchi, T. (1986). Quantification in Syntax. Doctoral dissertation, University of Massachusetts, Amherst.
- Nurse, D. and G. Philippson. (2003). *The Bantu Languages*. New York: Routledge.
- Ouhalla, J. (1993). "Negation, Focus and Tense: the Arabic *maa* and *laa*." *Rivista di Linguistica* 5:275--298
- Panagiotidis, P. (2000). "Demonstrative Determiners and Operators: The Case of Greek". *Lingua* 110: 717-742.
- Pedrales, H. DE (1945). "Contribution à l' établissement d'un Inventaire éthique du Cameroun" . *Bulletin de la Société d'études camerounaises* n° 15-16.
- Perlmutter, D. (1971). Deep and Surface Structure Constraints in Syntax. Ph. D. dissertation, MIT.
- Pesetsky, D. (1987.) "Wh-in-situ: Movement and Unselective Binding" In Eric J. Reuland and Alice G. B. ter Meulen (eds.) ; *The Representation of In definiteness*, Cambridge, MIT Press.
- Pollock, J. -Y (1989). "Verb Movement, Universal Grammar and the Structure of IP" , LI 20.
- Raposo, E. (1986). "On the Null Object in European Portuguese", in Osvaldo Jaeggli and Carmen Silva-Corvalan (eds.), *Studies in Romance Linguistics*, 373-390, Foris Publications and Cinnaminson.
- Raposo, E. (1988). "Romance Inversion, the Minimality Condition, and the ECP". *NELS* 18: 357-374.
- Reinhart, T. (1976). The Syntactic Domain of Anaphora, Ph.D.dissertation, MIT.
- Reinhart, T. (1983). *Anaphora and Semantic Interpretation*. London: Croom Helm. [Also published by University of Chicago Press, Chicago (1985)].
- Reinhart, T. (1985). "Center and Periphery in the Grammar of Anaphora", In B. Lust, ed. *Studies in the Acquisition of Anaphora*. Dordrecht, D. Reidel

- Reinhart, T.(1987). “Specifier and Operator Binding”, In Eric J. Reuland and Alice G.B. ter Meulen, (eds.) , *The Representation of (In)definiteness*. MIT Press, Cambridge, MA.
- Richardson, I. (1956). *Linguistic Survey of the Northern Bantu Borderland*. Oxford. IAI Vol. 1. Oxford ,Oxford University Press.
- Rizzi, L. (1982). *Issues in Italian Syntax*. Dordrecht: Foris.
- Rizzi, L. (1986). “Null Objects in Italian and the Theory of pro,” *LI* 17.3.
- Rizzi, L. (1990). *Relativized Minimality*, Linguistic Inquiry Monograph, Cambridge, MIT Press.
- Rizzi, L. (1997). “The Fine Structure of the Left Periphery”. In Liliane Haegeman, ed; *Elements of Grammar*. Kluwer, Dordrecht, Boston, London. 281-337
- Rizzi, L. (2001a). “On the Position of ‘Int(errogative)’ in the Left Periphery of the Clause.”In g. cinque & G. Salvi, eds. *Current Studies in Italian Syntax. Essays offered to LORENZO Renzi*. Amsterdam: Elsevier, pp 267-296.
- Rizzi, L. (2001b). “Relativized Minimality Effects”. In Mark Baltin & Chris Collins eds; *The Contemporary Handbook of Syntactic Theory*. Blackwell, Oxford.
- Rizzi, L. (2004) “The Structure of CP and IP”, *The Cartography of Syntactic Structures*, Vol. 2 Oxford University Press, New York.
- Roberge, Y.(1987). “On the Recoverability of Null Object,” ms. Université du Québec à Montréal.
- Roberts, I. (1985). “Agreement Parameters and the Development of English Modal Auxiliaries” *Natural Languages and Linguistic Theory* 3:21-58.
- Roberts, I. (1993). “Agreement and Object Clitics in Franco-Provencial Valdoêtain.” *GenGenP* 7:31-41
- Roberts, I. (2001). “Head Movement.” In Mark Baltin & Chris Collins, eds; *The Contemporary Handbook of Syntactic Theory*. Blackwell, Oxford.
- Rochemont, M.(1986). *Focus in Generative Grammar*. Amsterdam: John Benjamins Publishing Company.
- Ross, J.R. (1967). *Constraints on Variables in Syntax*. Ph.D. dissertation, MIT.
- Rudin, C. (1988). On multiple questions and wh-fronting. *Natural Language and Linguistic Theory* 6, 445-501.
- Safir,K.(1984). “Multiple Variable Binding”, *LI* 15: 603-638.
- Safir,K.(1985). *Syntactic Chains*, Cambridge, CUP.

- Safir, K. (1986). "Relative Clauses in a Theory of Binding and Levels", *LI* 17: 663-690.
- Saito, M. (1985). *Some Asymmetries in Japanese and their Theoretical Implications*, Doctoral dissertation, MIT.
- Schachter, P. (1971). *Focus and Relativization*. *Language*.
- Schwarz, L. (1987). "Asymmetric Feature Distribution in Pronominal 'Coordination'" " In Charles A. Ferguson and Michael Barlow (eds.) *Agreement in Natural Language*.
- Scott, G.-J. (1998). Stacked adjectival modification and the structure of the nominal phrases. In G. Cinque, eds, *Functional Structures in DP and IP. The Cartography of Syntactic Structures, vol. 1. 91-120*. New York: Oxford University Press.
- Scott, G.-J. (2002). 'Stacked adjectival modification and the structure of the nominal phrases'. *SOAS Working Papers in Linguistics and Phonetics, vol. 8: 59-89*.
- Sells, P. (1984a). "Resumptive Pronouns and Weak Crossover", in M. Cobler, S. McKaye, and M. Wescoat (eds.), *Proceedings of West Coast Conference on Formal Linguistics 3*, Stanford, California, pp. 252-262.
- Sells, P. (1984b). *Syntax and Semantics of Resumptive Pronouns*, Ph.D. dissertation, University of Massachusetts, Amherst.
- Sells, P. (1987). "Binding Resumptive Pronouns", *Linguistics and Philosophy* 10. 3., pp. 261-298.
- Shlonsky, U. (1992). "Resumptive Pronouns as a Last Resort". *Linguistic Inquiry* 23:443-468.
- Shlonsky, U. (2000). *The form of Semitic noun phrases. An Antisymmetric non N-movement account*. Ms., Université de Genève.
- Siloni, T. (1991). "Noun Raising and the Structure of Noun Phrases." *MIT Working Papers in Linguistics* 14: 255-270
- Sproat, R. And C. Shih (1988). 'Prenominal adjective ordering in English and Mandarin, *NELS* 18: 465-489
- Sproat, R. And C. Shih (1991). 'The Cross-linguistic distribution of adjective ordering restrictions' in: C. Georgopolous, R. I Shihara (eds), *Interdisciplinary Approaches to language. Essays in Honor of S. Y. Kuroda: 565-593*. Dordrecht: Kluwer. Academic Publishers.
- Suner, M. (1983). "pro arb", *LI* 14, 188-191.
- Szabolsci, A. (1981). "The Possessive Construction in Hungarian: A Configurational Category in a Non-Configurational Language", *Acta Linguistica Academiae Scientiarum Hungaricae* 31: 261-286.
- Szabolsci, A. (1984). "The Possessor that ran away from home", *The Linguistic Review* 3: 89-102.

- Szabolsci, A. (1987). "Functional Categories in the Noun Phrase", to appear in Kenesei, ed., *Approaches to Hungarian*, Vol.2, Szeged.
- Takizala, A.(1972). Focus and Relativization: the case of Kihung'an. *Studies in African Linguistics* 3, 259-287.
- Tamrazian, A. (1991). "Focus and Wh-Movement in Armenian" in UCL Working Papers in Linguistics 3. Department of Phonetics and Linguistics. University College London, Gower Street, London WC1E 6BT.
- Tessman, G.(1932). *Die Volker und Sprachen Kameruns*. Gotha. Petermann's Mitteilungen.
- Travis, L.(1984). Parameters and Effects of Word Order. Ph.D. dissertation, MIT.
- Tsao, F.F. (1977). A Functional Study of Topic in Chinese: the First Step Towards Discourse Analysis, University of Southern California. Ph.D. Dissertation. (Student Book Co., Taipei, 1979).
- Tsimpli, I.-M.(1990). "The Clause Structure and Word Order of Modern Greek" in UCL Working Papers in Linguistics 2. Department of Phonetics and Linguistics. University College London, Gower Street, London WC1E 6BT.
- Valois, D. (1991). 'The internal syntax of DP and adjective placement in French and English, *NELS* 21:367-382
- Van Riemsdijk, H. and E. Williams (1986). *Introduction to the Theory of Grammar*. Cambridge, MA: MIT Press.
- Wahba, W.A.F.B.(1984). Wh-Constructions in Egyptian Arabic. Ph.D. dissertation, University of Illinois at Urbana-Champaign.
- Watters, J. (1979). FOCUS IN Aghem. In L. Hyman, ed., *Aghem Grammatical Structure* SCOPIL 7.(University of Southern California).
- Weisler, S.(1982). "Generalized Binding", in UMOP 8, University of Massachusetts, Amherst.
- Weisler, S.(1986). "On Reconstruction," in UMOP 12, University of Massachusetts. Amherst.
- Williams, E.S.(1978). "Across-the-board-application of rules", *LI* 8, 419-423.
- Zaenen, A., E. Engdahl, and Joan Maling .(1981). "Resumptive Pronouns can be Syntactically Bound", *LI* 12, 679-682.
- Zribi-Hertz, A. & Jean-François Hanne.(1995). "Pronoms, Déterminants et Relatives Bambara de Bamako". *Linguistique Africaine* 15 :91-135.
- Zribi-Hertz, A. (1998). "Les syntagmes nominaux possessifs en français moderne : syntaxe et morphologie". In Jacqueline Guéron & Anne ZRIBI-Hertz, éd ; *La grammaire de la possession*. Publidix, Université Paris X, Nanterre.

Zribi-Hertz. A. & Lilianne Mbolatianavalona. (1997). "De la structure à la référence : les pronoms du malgache". In Anne Zribi éd ; *Les Pronoms : Morphologie, Syntaxe et Typologie. Sciences du Langage*. PUV, Paris 8.

Zribi-Hertz. A. & Lilianne Mbolatianavalona (1999). Towards a Modular Theory of Linguistic Deficiency: "Evidence from Malagasy Personal Pronouns". *Natural Language & Linguistic Theory* 17:161-218.