

BALL, ROLLER, AND NEEDLE BEARINGS

Rolling contact bearings substitute a rolling element, ball or roller, for a hydrodynamic or hydrostatic fluid film to carry an impressed load without wear and with reduced friction. Because of their greatly reduced starting friction, when compared to the conventional journal bearing, they have acquired the common designation of "anti-friction" bearings. Although normally made with hardened rolling elements and races, and usually utilizing a separator to space the rolling elements and reduce friction, many variations are in use throughout the mechanical and electrical industries. The most common anti-friction bearing application is that of the deep-groove ball bearing with ribbon-type separator and sealed-grease lubrication used to support a shaft with radial and thrust loads in rotating equipment. This shielded or sealed bearing has become a standard and commonplace item ordered from a supplier's catalogue in much the same manner as nuts and bolts. Because of the simple design approach and the elimination of a separate lubrication system or device, this bearing is found in as many installations as the wick-fed or impregnated porous plain bushing.

Currently, a number of manufacturers produce a complete range of ball and roller bearings in a fully interchangeable series with standard dimensions, tolerances and fits as specified in Anti-Friction Bearing Manufacturers Association (AFBMA) Standards. Except for deep-groove ball bearings, performance standards are not so well defined and selection must be done in close conformance with the specific manufacturer's catalogue requirements. In general, desired functional features should be carefully gone over with the vendor's representatives.

Rolling contact bearings are made to high standards of accuracy and with close metallurgical control. Balls and rollers are normally held to diametral tolerances of .0001 inch or less within one bearing and are often used as "gage" blocks in routine toolroom operations. This accuracy is essential to the performance and durability of rolling-contact bearings and in limiting runout, providing proper radial and axial clearances, and ensuring smoothness of operation.















Because of their low friction, both starting and running, rolling-contact bearings are utilized to reduce the complexity of many systems that normally function with journal bearings. Aside from this advantage and that of precise radial and axial location of rotating elements, however, they also are desirable because of their reduced lubrication requirements and their ability to function during brief interruptions in normal lubrication.

In applying rolling-contact bearings it is well to appreciate that their life is limited by the fatigue life of the material from which they are made and is modified by the lubricant used. In rolling-contact fatigue, precise relationships among life, load, and design characteristics are not predictable, but a statistical function described as the "probability of survival" is used to relate them according to equations recommended by the AFBMA. Deviations from these formulas result when certain extremes in applications such as speed, deflection, temperature, lubrication, and internal geometry must be dealt with.

Types of Anti-friction Bearings.—The general types are usually determined by the shape of the rolling element, but many variations have been developed that apply conventional elements in unique ways. Thus it is well to know that special bearings can be procured with races adapted to specific applications, although this is not practical for other than high volume configurations or where the requirements cannot be met in a more economical manner. "Special" races are appreciably more expensive. Quite often, in such situations, races are made to incorporate other functions of the mechanism, or are "submerged" in the surrounding structure, with the rolling elements supported by a shaft or housing that has been hardened and finished in a suitable manner. Typical anti-friction bearing types are shown in Table 1.

Types of Ball Bearings.—Most types of ball bearings originate from three basic designs: the single-row radial, the single-row angular contact, and the double-row angular contact.









Table 1. Types of Rolling Element Bearings and Their Symbols

BALL BEARINGS, SINGLE ROW, RADIAL CONTACT					
Symbol	Description		Symbol	Description	
BC	Non-filling slot assembly		BH	Non-separable counter-bore assembly	
BL	Filling slot assembly		BM	Separable assembly	
BALL BEARINGS, SINGLE ROW, ANGULAR CONTACT ^a					
Symbol	Description		Symbol	Description	
BN	Non-separable Nominal contact angle: from above 10° to and including 22°		BAS	Separable inner ring Nominal contact angle: from above 22° to and including 32°	
BNS	Separable outer ring Nominal contact angle: from above 10° to and including 22°		BT	Non-separable Nominal contact angle: from above 32° to and including 45°	
BNT	Separable inner ring Nominal contact angle: from above 10° to and including 22°		BY	Two-piece outer ring	
BA	Non-separable Nominal contact angle: from above 22° to and including 32°		BZ	Two-piece inner ring	
BALL BEARINGS, SINGLE ROW, RADIAL CONTACT, SPHERICAL OUTSIDE SURFACE					
Symbol	Description		Symbol	Description	
BCA	Non-filling slot assembly		BLA	Filling slot assembly	

^a A line through the ball contact points forms an acute angle with a perpendicular to the bearing axis.

Single-row Radial, Non-filling Slot: This is probably the most widely used ball bearing and is employed in many modified forms. It is also known as the “Conrad” type or “Deep-groove” type. It is a symmetrical unit capable of taking combined radial and thrust loads in which the thrust component is relatively high, but is not intended for pure thrust loads, however. Because this type is not self-aligning, accurate alignment between shaft and housing bore is required.

Single-row Radial, Filling Slot: This type is designed primarily to carry radial loads. Bearings of this type are assembled with as many balls as can be introduced by eccentric displacement of the rings, as in the non-filling slot type, and then several more balls are inserted through the loading slot, aided by a slight spreading of the rings and heat expansion of the outer ring, if necessary. This type of bearing will take a certain degree of thrust when in combination with a radial load but is not recommended where thrust loads exceed 60 per cent of the radial load.

BALL BEARINGS, DOUBLE ROW, RADIAL CONTACT			
Symbol	Description	Symbol	Description
BF	Filling slot assembly 	BHA	Non-separable two-piece outer ring 
BK	Non-filling slot assembly 		
BALL BEARINGS, DOUBLE ROW, ANGULAR CONTACT ^a			
Symbol	Description	Symbol	Description
BD	Filling slot assembly Vertex of contact angles inside bearing 	BG	Non-filling slot assembly Vertex of contact angles outside bearing 
BE	Filling slot assembly Vertex of contact angles outside bearing 	BAA	Non-separable Vertex of contact angles inside bearing Two-piece outer ring 
BJ	Non-filling slot assembly Vertex of contact angles inside bearing 	BVV	Separable Vertex of contact angles outside bearing Two-piece inner ring 

^a A line through the ball contact points forms an acute angle with a perpendicular to the bearing axis.















BALL BEARINGS, DOUBLE ROW, SELF-ALIGNING ^a			
	Symbol	Description	
	BS	Raceway of outer ring spherical 	















Single-row Angular-contact: This type is designed for combined radial and thrust loads where the thrust component may be large and axial deflection must be confined within very close limits. A high shoulder on one side of the outer ring is provided to take the thrust, while the shoulder on the other side is only high enough to make the bearing non-separable. Except where used for a pure thrust load in one direction, this type is applied either in pairs (duplex) or one at each end of the shaft, opposed.

Double-row Bearings: These are, in effect, two single-row angular-contact bearings built as a unit with the internal fit between balls and raceway fixed at the time of bearing assembly. This fit is therefore not dependent upon mounting methods for internal rigidity. These bearings usually have a known amount of internal preload built in for maximum resistance to deflection under combined loads with thrust from either direction. Thus, with balls and races under compression before an external load is applied, due to this internal preload, the bearings are very effective for radial loads where bearing deflection must be minimized.

Other Types: Modifications of these basic types provide arrangements for self-sealing, location by snap ring, shielding, etc., but the fundamentals of mounting are not changed. A special type is the *self-aligning* ball bearing which can be used to compensate for an appreciable degree of misalignment between shaft and housing due to shaft deflections, mounting inaccuracies, or other causes commonly encountered. With a single row of balls, alignment is provided by a spherical outer surface on the outer ring; with a double row of

balls, alignment is provided by a spherical raceway on the outer ring. Bearings in the wide series have a considerable amount of thrust capacity.

CYLINDRICAL ROLLER BEARING, SINGLE ROW, NON-LOCATING TYPE					
Symbol	Description				
RU	Inner ring without ribs Double-ribbed outer ring Inner ring separable		RNS	Double-ribbed inner ring Outer ring without ribs Outer ring separable Spherical outside surface	
RUP	Inner ring without ribs Double-ribbed outer ring with one loose rib Both rings separable		RAB	Inner ring without ribs Single-ribbed outer ring Both rings separable	
RUA	Inner ring without ribs Double-ribbed outer ring Inner ring separable Spherical outside surface		RM	Inner ring without ribs Rollers located by cage, end-rings or internal snap rings recesses in outer ring Inner ring separable	
RN	Double-ribbed inner ring Outer ring without ribs Outer ring separable		RNU	Inner ring without ribs Outer ring without ribs Both rings separable	
CYLINDRICAL ROLLER BEARINGS, SINGLE ROW, ONE-DIRECTION-LOCATING TYPE					
Symbol	Description				
RR	Single-ribbed inner ring Outer ring with two internal snap rings Inner ring separable		RF	Double-ribbed inner ring Single-ribbed outer ring Outer ring separable	
RJ	Single-ribbed inner ring Double-ribbed outer ring Inner ring separable		RS	Single-ribbed inner ring Outer ring with one rib and one internal snap ring Inner ring separable	
RJP	Single-ribbed inner ring Double-ribbed outer ring with one loose rib Both rings separable		RAA	Single-ribbed inner ring Single-ribbed outer ring Both rings separable	

CYLINDRICAL ROLLER BEARINGS, SINGLE ROW, TWO-DIRECTION-LOCATING TYPE					
Symbol	Description		Symbol	Description	
RK	Double-ribbed inner ring Outer ring with two internal snap rings Non-separable		RY	Double-ribbed inner ring Outer ring with one rib and one internal snap ring Non-separable	
RC	Double-ribbed inner ring Double-ribbed outer ring Non-separable		RCS	Double-ribbed inner ring Double-ribbed outer ring Non-separable Spherical outside surface	
RG	Inner ring, with one rib and one snap ring Double-ribbed outer ring Non-separable				
RP	Double-ribbed inner ring Double-ribbed outer ring with one loose rib Outer ring separable		RT	Double-ribbed inner ring with one loose rib Double-ribbed outer ring Inner ring separable	
CYLINDRICAL ROLLER BEARINGS					
Double Row Non-Locating Type		Double Row Two-Direction-Locating Type			
Symbol	Description	Symbol	Description		
RA	Inner ring without ribs Three integral ribs on outer ring Inner ring separable		RB	Three integral ribs on inner ring Outer ring without ribs, with two internal snap rings Non-separable	
RD	Three integral ribs on inner ring Outer ring without ribs Outer ring separable		Multi-Row Non-Locating Type		
RE	Inner ring without ribs Outer rings without ribs, with two internal snap rings Inner ring separable		RV	Inner ring without ribs Double-ribbed outer ring (loose ribs) Both rings separable	
SELF-ALIGNING ROLLER BEARINGS, DOUBLE ROW					
Symbol	Description	Symbol	Description		
SD	Three integral ribs on inner ring Raceway of outer ring spherical		SL	Raceway of outer ring spherical Rollers guided by the cage Two integral ribs on inner ring	

SELF-ALIGNING ROLLER BEARINGS, DOUBLE ROW			
Symbol	Description	Symbol	Description
SE	Raceway of outer ring spherical Rollers guided by separate center guide ring in outer ring	SELF-ALIGNING ROLLER BEARINGS SINGLE ROW	
		Symbol	Description
SW	Raceway of inner ring spherical	SR	Inner ring with ribs Raceway of outer ring spherical Radial contact
SC	Raceway of outer ring spherical Rollers guided by separate axially floating guide ring on inner ring	SA	Raceway of outer ring spherical Angular contact
		SB	Raceway of inner ring spherical Angular contact
THRUST BALL BEARINGS			
Symbol	Description	Symbol	Description
TA TB ^a	Single direction, grooved raceways, flat seats	TDA	Double direction, washers with grooved raceways, flat seats
TBF ^a	Single direction, flat washers, flat seats		
THRUST ROLLER BEARINGS			
Symbol	Description	Symbol	Description
TS	Single direction, aligning flat seats, spherical rollers	TPC ^a	Single direction, flat seats, flat races, outside band, cylindrical rollers
TP	Single direction, flat seats, cylindrical rollers	TR ^a	Single direction, flat races, aligning seat with aligning washer, cylindrical rollers

^a Inch dimensioned only.







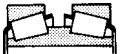

Types of Roller Bearings.—Types of roller bearings are distinguished by the design of rollers and raceways to handle axial, combined axial and thrust, or thrust loads.

Cylindrical Roller: These bearings have solid or helically wound hollow cylindrical rollers. The free ring may have a restraining flange to provide some restraint to endwise movement in one direction or may be without a flange so that the bearing rings may be displaced axially with respect to each other. Either rolls or roller path on the races may be slightly crowned to prevent edge loading under slight shaft misalignment. Low friction makes this type suitable for relatively high speeds.

Barrel Roller: These bearings have rollers that are barrel-shaped and symmetrical. They are furnished in both single- and double-row mountings. As with cylindrical roller bearings, the single-row mounting type has a low thrust capacity, but angular mounting of rolls in the double-row type permits its use for combined axial and thrust loads.

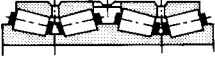
Spherical Roller: These bearings are usually furnished in a double-row, self-aligning mounting. Both rows of rollers have a common spherical outer raceway. The rollers are barrel-shaped with one end smaller than the other to provide a small thrust to keep the rollers in contact with the center guide flange. This type of roller bearing has a high radial and thrust load carrying capacity with the ability to maintain this capacity under some degree of misalignment of shaft and bearing housing.

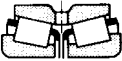
Tapered Roller: In this type, straight tapered rollers are held in accurate alignment by means of a guide flange on the inner ring. The basic characteristic of these bearings is that the apexes of the tapered working surfaces of both rollers and races, if extended, would coincide on the bearing axis. These bearings are separable. They have a high radial and thrust carrying capacity.

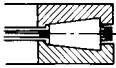
TAPERED ROLLER BEARINGS — INCH			
Symbol	Description	Symbol	Description
TS	Single row 	TDI	Two row, double-cone single cups 
TDO	Two row, double-cup single-cone adjustable 	TNA	Two row, double-cup single cone nonadjustable 
TQD, TQI	Four row, cup adjusted 		
TAPERED ROLLER BEARINGS — METRIC			
Symbol	Description	Symbol	Description
TS	Single row, straight bore 	TSF	Single row, straight bore, flanged cup 
TDO	Double row, straight bore, two single cones, one double cup with lubrication hole and groove 	2TS	Double row, straight bore, two single cones, two single cups 
THRUST TAPERED ROLLER BARINGS			
Symbol	Description		
TT	Thrust bearings 		

Types of Ball and Roller Thrust Bearings.—Are designed to take thrust loads alone or in combination with radial loads.









One-direction Ball Thrust: These bearings consist of a shaft ring and a flat or spherical housing ring with a single row of balls between. They are capable of carrying pure thrust loads in one direction only. They cannot carry any radial load.

Two-direction Ball Thrust: These bearings consist of a shaft ring with a ball groove in either side, two sets of balls, and two housing rings so arranged that thrust loads in either direction can be supported. No radial loads can be carried.

Spherical Roller Thrust: This type is similar in design to the radial spherical roller bearing except that it has a much larger contact angle. The rollers are barrel shaped with one end smaller than the other. This type of bearing has a very high thrust load carrying capacity and can also carry radial loads.

Tapered Roller Thrust: In this type the rollers are tapered and several different arrangements of housing and shaft are used.

Roller Thrust: In this type the rollers are straight and several different arrangements of housing and shaft are used.

NEEDLE ROLLER BEARINGS, DRAWN CUP					
Symbol ^a	Description		Symbol ^a	Description	
NIB NB	Needle roller bearing, full complement, drawn cup, without inner ring		NIYM NYM	Needle roller bearing, full complement, rollers retained by lubricant, drawn cup, closed end, without inner ring	
NIBM NBM	Needle roller bearing, full complement, drawn cup, closed end, without inner ring		NIH NH	Needle roller bearing, with cage, drawn cup, without inner ring	
NIY NY	Needle roller bearing, full complement, rollers retained by lubricant, drawn cup, without inner ring		NIHM NHM	Needle roller bearing, with cage, drawn cup, closed end, without inner ring	
NEEDLE ROLLER BEARINGS			NEEDLE ROLLER AND CAGE ASSEMBLIES		
Symbol ^a	Description		Symbol ^a	Description	
NIA NA	Needle roller bearing, with cage, machined ring lubrication hole and groove in OD, without inner ring		NIM NM	Needle roller and cage assembly	
NEEDLE ROLLER BEARING INNER RINGS			Machined Ring Needle Roller Bearings Type NIA may be used with inch dimensioned inner rings, Type NIR, and Type NA may be used with metric dimensional inner rings, Type NR.		
Symbol ^a	Description				
NIR NR	Needle roller bearing inner ring, lubrication hole and groove in bore				

^a Symbols with I, as NIB, are inch-dimensioned, and those without the I, as NB, are metric dimensioned.

Types of Needle Bearings.—Needle bearings are characterized by their relatively small size rollers, usually not above $\frac{1}{4}$ inch in diameter, and a relatively high ratio of length to diameter, usually ranging from about 3 to 1 and 10 to 1. Another feature that is characteristic of several types of needle bearings is the absence of a cage or separator for retaining the individual rollers. Needle bearings may be divided into three classes: loose-roller, outer race and retained roller, and non-separable units.

Loose-roller: This type of bearing has no integral races or retaining members, the needles being located directly between the shaft and the outer bearing bore. Usually both shaft and outer bore bearing surfaces are hardened and retaining members that have smooth unbroken surfaces are provided to prevent endwise movement. Compactness and high radial load capacity are features of this type.

Outer Race and Retained Roller: There are two types of outer race and retained roller bearings. In the *Drawn Shell* type, the needle rollers are enclosed by a hardened shell that acts as a retaining member and as a hardened outer race. The needles roll directly on the shaft, the bearing surface of which should be hardened. The capacity for given roller length and shaft diameter is about two-thirds that of the loose roller type. It is mounted in the housing with a press fit.

In the *Machined Race* type, the outer race consists of a heavy machined member. Various modifications of this type provide heavy ends or faces for end location of the needle rollers, or open end construction with end washers for roller retention, or a cage that maintains alignment of the rollers and is itself held in place by retaining rings. An auxiliary outer member with spherical seat that holds the outer race may be provided for self-alignment. This type is applicable where split housings occur or where a press fit of the bearing into the housing is not possible.

Non-separable: This type consists of a non-separable unit of outer race, rollers and inner race. These bearings are used where high static or oscillating motion loads are expected as in certain aircraft components and where both outer and inner races are necessary.

Special or Unconventional Types.—Rolling contact bearings have been developed for many highly specialized applications. They may be constructed of non-corrosive materials, non-magnetic materials, plastics, ceramics, and even wood. Although the materials are chosen to adapt more conventional configurations to difficult applications or environments, even greater ingenuity has been applied in utilizing rolling contact for solving particular problems. Thus, linear or recirculating bearings are available to provide low friction, accurate location, and simplified lubrication features to such applications as machine ways, axial motion devices, jack-screws, steering linkages, collets, and chucks. This type of bearing utilizes the “full-complement” style of loading the rolling elements between “races” or ways without a cage and with each element advancing by the action of “races” in the loaded areas and by contact with the adjacent element in the unloaded areas. The “races” may not be cylindrical or bodies of revolution but plane surfaces, with suitable interruptions to free the rolling elements so that they can follow a return trough or slot back to the entry-point at the start of the “race” contact area. Combinations of radial and thrust bearings are available for the user with special requirements.

Plastics Bearings.—A more recent development has been the use of Acetal resin rollers and balls in applications where abrasive, corrosive and difficult-to-lubricate conditions exist. Although these bearings do not have the load carrying capacity nor the low friction factor of their hard steel counterparts, they do offer freedom from indentation, wear, and corrosion, while at the same time providing significant weight savings.

Of additional value are: 1) their resistance to indentation from shock loads or oscillation; and 2) their self-lubricating properties.

Usually these bearings are not available from stock, but must be designed and produced in accordance with the data made available by the plastics processor.

Pillow Block and Flanged Housing Bearings.—Of great interest to the shop man and particularly adaptable to “line-shafting” applications are a series of ball and roller bearings supplied with their own housings, adapters, and seals. Often called pre-mounted bearings, they come with a wide variety of flange mountings permitting location on faces parallel to or perpendicular to the shaft axis.

Inner races can be mounted directly on ground shafts, or can be adapter-mounted to “drill-rod” or to commercial shafting. For installations sensitive to imbalance and vibration, the use of accurately ground shaft seats is recommended.

Most pillow block designs incorporate self-aligning types of bearings so they do not require the precision mountings utilized with more normal bearing installations.

Conventional Bearing Materials.—Most rolling contact bearings are made with all load carrying members of full hard steel, either through- or case-hardened. For greater reliabil-

ity this material is controlled and selected for cleanliness and alloying practices in conformity with rigid specifications in order to reduce anomalies and inclusions that could limit the useful fatigue life. Magnaflux inspection is employed to ensure that elements are free from both material defects and cracks. Likewise, a light etch is employed between rough and finish grinding to allow detection of burns due to heavy stock removal and associated decarburization in finished pieces.

Cage Materials.—Standard bearings are normally made with cages of free-machining brass or low carbon sulfurized steel. In high-speed applications or where lubrication may be intermittent or marginal, special materials may be employed. Iron-silicon-bronze, laminated phenolics, silver-plating, over-lays, solid-film baked-on coatings, carbon-graphite inserts, and, in extreme cases, sintered or even impregnated materials are used in separators.

Commercial bearings usually rely on stamped steel with or without a phosphate treatment; some low cost varieties are found with snap-in plastic or metallic cages.

So long as lubrication is adequate and speeds are both reasonable and steady, the materials and design of the cage are of secondary importance when compared with those of the rolling elements and their contacts with the races. In spite of this tolerance, a good portion of all rolling bearing failures encountered can be traced to cage failures resulting from inadequate lubrication. It can never be overemphasized that *no bearing can be designed to run continuously without lubrication!*

Standard Method of Bearing Designation.—The Anti-Friction Bearing Manufacturers Association has adopted a standard identification code that provides a specific designation for each different ball, roller, and needle bearing. Thus, for any given bearing, a uniform designation is provided for manufacturer and user alike, so that the confusion of different company designations can be avoided.

In this identification code there is a “basic number” for each bearing that consists of three elements: a one- to four-digit number to indicate the size of the bore in numbers of millimeters (metric series); a two- or three-letter symbol to indicate the type of bearing; and a two-digit number to identify the dimension series to which the bearing belongs.

In addition to this “basic number” other numbers and letters are added to designate type of tolerance, cage, lubrication, fit up, ring modification, addition of shields, seals, mounting accessories, etc. Thus, a complete designating symbol might be *50BC02JPXE0A10*, for example. The basic number is *50BC02* and the remainder is the supplementary number. For a radial bearing, this latter consists of up to four letters to indicate modification of design, one or two digits to indicate internal fit and tolerances, a letter to indicate lubricants and preservatives, and up to three digits to indicate special requirements.

For a thrust bearing the supplementary number would consist of two letters to indicate modifications of design, one digit to indicate tolerances, one letter to indicate lubricants and preservatives, and up to three digits to indicate special requirements.

For a needle bearing the supplementary number would consist of up to three letters indicating cage material or integral seal information or whether the outer ring has a crowned outside surface and one letter to indicate lubricants or preservatives.

Dimension Series: Annular ball, cylindrical roller, and self-aligning roller bearings are made in a series of different outside diameters for every given bore diameter and in a series of different widths for every given outside diameter. Thus, each of these bearings belongs to a dimension series that is designated by a two-digit number such as *or, 23, 93*, etc. The first digit (8, 0, 1, 2, 3, 4, 5, 6 and 9) indicates the *width series* and the second digit (7, 8, 9, 0, 1, 2, 3, and 4) the *diameter series* to which the bearing belongs. Similar types of identification codes are used for ball and roller thrust bearings and needle roller bearings.

Table 1. ABEC-1 and RBEC-1 Tolerance Limits for Metric Ball and Roller Bearings ANSI/ABMA 20-1987

Basic Inner Ring Bore Diameter, d		V_{dpr}^a max			Δ_{dmp}^b		K_{ia}^c
mm		Diameter Series					
Over	Incl.	7,8,9	0,1	2,3,4	High	Low	max
2.5	10	10	8	6	0	-8	10
10	18	10	8	6	0	-8	10
18	30	13	10	8	0	-10	13
30	50	15	12	9	0	-12	15
50	80	19	19	11	0	-15	20
80	120	25	25	15	0	-20	25
120	180	31	31	19	0	-25	30
180	250	38	38	23	0	-30	40
250	315	44	44	26	0	-35	50
315	400	50	50	30	0	-40	60

^a Bore diameter variation in a single radial plane.

^b Single plane mean bore diameter deviation from basic. (For a basically tapered bore, Δ_{dmp} refers only to the theoretical small end of the bore.)

^c Radial runout of assembled bearing inner ring.

Basic Outer Ring Outside Diameter, D		V_{Dpr}^a max				Δ_{Dmp}^b		K_{ea}^c
mm		Open Bearings		Capped Bearings ^d				
Over	Incl.	7,8,9	0,1	2,3,4	2,3,4	High	Low	max
6	18	10	8	6	10	0	-8	15
18	30	12	9	7	12	0	-9	15
30	50	14	11	8	16	0	-11	20
50	80	16	13	10	20	0	-13	25
80	120	19	19	11	26	0	-15	35
120	150	23	23	14	30	0	-18	40
150	180	31	31	19	38	0	-25	45
180	250	38	38	23	...	0	-30	50
250	315	44	44	26	...	0	-35	60
315	400	50	50	50	...	0	-40	70

^a Outside diameter variation in a single radial plane. Applies before mounting and after removal of internal or external snap ring.

^b Single plane mean outside diameter deviation from basic.

^c Radial runout of assembled bearing outer ring.

^d No values have been established for diameters series 7, 8, 9, 0, and 1.

Width Tolerances									
d		Δ_{Bs}^a			d		Δ_{Bs}^a		
mm		All	Normal	Modified ^b	mm		All	Normal	Modified ^b
Over	Incl.	High	Low		Over	Incl.	High	Low	
2.5	10	0	-120	-250	80	120	0	-200	-380
10	18	0	-120	-250	120	180	0	-250	-500
18	30	0	-120	-250	180	250	0	-300	-500
30	50	0	-120	-250	250	315	0	-350	-500
50	80	0	-150	-380	315	400	0	-400	-630

^a Single inner ring width deviation from basic. Δ_{Cs} (single outer ring width deviation from basic) is identical to Δ_{Bs} of inner ring of same bearing.

^b Refers to the rings of single bearings made for paired or stack mounting.

All units are micrometers, unless otherwise indicated. For sizes beyond range of this table, see Standard. This table does not cover tapered roller bearings.

Table 2. ABEC-3 AND RBEC-3 Tolerance Limits for Metric Ball and Roller Bearings ANSI/ABMA 20-1987

Basic Inner Ring Bore Diameter, d		V_{dp} , ^a max			Δ_{dmp} ^b		K_{ia} ^c
mm		Diameter Series			High	Low	
Over	Incl.	7, 8, 9	0, 1	2, 3, 4			
2.5	10	9	7	5	0	-7	6
10	18	9	7	5	0	-7	7
18	30	10	8	6	0	-8	8
30	50	13	10	8	0	-10	10
50	80	15	15	9	0	-12	10
80	120	19	19	11	0	-15	13
120	180	23	23	14	0	-18	18
180	250	28	28	17	0	-22	20
250	315	31	31	19	0	-25	25
315	400	38	38	23	0	-30	30

^a Bore diameter variation in a single radial plane.

^b Single plane mean bore diameter deviation from basic. (For a basically tapered bore, Δ_{dmp} refers only to the theoretical small end of the bore.)

^c Radial runout of assembled bearing inner ring.

Basic Outer Ring Outside Outsider Diameter, D		V_{Dp} , ^a max				Δ_{Dmp} ^b		K_{ea} ^c
mm		Open Bearings		Capped Bearings ^d		High	Low	
Over	Incl.	7,8,9	0,1	2,3,4	2,3,4			
6	18	9	7	5	9	0	-7	8
18	30	10	8	6	10	0	-8	9
30	50	11	9	7	13	0	-9	10
50	80	14	11	8	16	0	-11	13
80	120	16	16	10	20	0	-13	18
120	150	19	19	11	25	0	-15	20
150	180	23	23	14	30	0	-18	23
180	250	25	25	15	...	0	-20	25
250	315	31	31	19	...	0	-25	30
315	400	35	35	21	...	0	-28	35

^a Outside diameter variation in a single radial plane. Applies before mounting and after removal of internal or external snap ring.

^b Single plane mean outside diameter deviation from basic.

^c Radial runout of assembled bearing outer ring.

^d No values have been established for diameter series 7, 8, 9, 0, and 1.

Width Tolerances									
d		Δ_{Bs} ^a			d		Δ_{Bs} ^a		
mm		All	Normal	Modified ^b	mm		All	Normal	Modified ^b
Over	Incl.	High	Low		Over	Incl.	High	Low	
2.5	10	0	-120	-250	80	120	0	-200	-380
10	18	0	-120	-250	120	180	0	-250	-500
18	30	0	-120	-250	180	250	0	-300	-500
30	50	0	-120	-250	250	315	0	-350	-500
50	80	0	-150	-380	315	400	0	-400	-630

^a Single inner ring width deviation from basic. Δ_{Cs} (single outer ring width deviation from basic) is identical to Δ_{Bs} of inner ring of same bearing.

^b Refers to the rings of single bearings made for paired or stack mounting.

All units are micrometers, unless otherwise indicated. For sizes beyond range of this table, see Standard. This table does not cover tapered roller bearings.

Table 3. ABEC-5 and RBEC-5 Tolerance Limits for Metric Ball and Roller Bearings ANSI/ABMA 20-1987

INNER RING												
Inner Ring Bore Basic Dia., d		V_{dp} ^a max		Δ_{dmp} ^b		Radial Runout K_{ra}	Ref. Face Runout with Bore S_d	Axial Runout of Assembled Bearing with Inner Ring S_{ia} ^c	Width			V_{Bs} ^e
mm		Diameter Series							Δ_{Bs} ^d			
Over	Incl.	7, 8, 9	0, 1, 2, 3, 4	High	Low	max	max	max	All	Normal	Modified ^f	max
2.5	10	5	4	0	-5	4	7	7	0	-40	-250	5
10	18	5	4	0	-5	4	7	7	0	-80	-250	5
18	30	6	5	0	-6	4	8	8	0	-120	-250	5
30	50	8	6	0	-8	5	8	8	0	-120	-250	5
50	80	9	7	0	-9	5	8	8	0	-150	-250	6
80	120	10	8	0	-10	6	9	9	0	-200	-380	7
120	180	13	10	0	-13	8	10	10	0	-250	-380	8
180	250	15	12	0	-15	10	11	13	0	-300	-500	10

^aBore (V_{dp}) and outside diameter (V_{Dp}) variation in a single radial plane.

^bSingle plane mean bore (Δ_{dmp}) and outside diameter (Δ_{Dmp}) deviation from basic. (For a basically tapered bore, Δ_{dmp} refers only to the theoretical small end of the bore.)

^cApplies to groove-type ball bearings only.

^dSingle bore (Δ_{Bs}) and outer ring (Δ_{Cs}) width variation.

^eInner (V_{Bs}) and outer (V_{Cs}) ring width deviation from basic.

^fApplies to the rings of single bearings made for paired or stack mounting.

OUTER RING												
Basic Outer Ring Outside Dia., D		V_{Dp} ^{aa} max		Δ_{Dmp} ^b		Radial Runout K_{ra}	Outside Cylindrical Surface Runout with Outer Ring Ref. Face S_D	Axial Runout of Assembled Bearing with Outer Ring S_{oa}	Width			V_{Cs} ^e
mm		Diameter Series							Δ_{Cs} ^d			
Over	Incl.	7, 8, 9	0, 1, 2, 3, 4	High	Low	max	max	max	High	Low	max	
6	18	5	4	0	-5	5	8	8				5
18	30	6	5	0	-6	6	8	8				5
30	50	7	5	0	-7	7	8	8				5
50	80	9	7	0	-9	8	8	10				6
80	120	10	8	0	-10	10	9	11				8
120	150	11	8	0	-11	11	10	13				8
150	180	13	10	0	-13	13	10	14				8
180	250	15	11	0	-15	15	11	15				10

^aNo values have been established for capped bearings.

All units are micrometers, unless otherwise indicated. For sizes beyond range of this table, see Standard. This table does not cover instrument bearings and tapered roller bearings.

Table 4. ABEC-7 Tolerance Limits for Metric Ball and Roller Bearings ANSI/ABMA 20-1987

INNER RING														
Inner Ring Bore Basic Dia., d		V_{dp} ^a max		Δ_{dmp} ^b		Δ_{ds} ^c		Radial Runout K_{ra}	Ref. Face Runout with Bore S_d	Axial Runout of Assembled Bearing with Inner Ring S_{ia} ^d	Width			
mm		Diameter Series									Δ_{Bs} ^e		V_{Bs} ^f	
Over	Incl.	7, 8, 9	0, 1, 2, 3, 4	High	Low	High	Low	max	max	max	All	Normal	Modified ^g	max
2.5	10	4	3	0	-4	0	-4	2.5	3	3	0	-40	-250	2.5
10	18	4	3	0	-4	0	-4	2.5	3	3	0	-80	-250	2.5
18	30	5	4	0	-5	0	-5	3	4	4	0	-120	-250	2.5
30	50	6	5	0	-6	0	-6	4	4	4	0	-120	-250	3
50	80	7	5	0	-7	0	-7	4	5	5	0	-150	-250	4
80	120	8	6	0	-8	0	-8	5	5	5	0	-200	-380	4
120	180	10	8	0	-10	0	-10	6	6	7	0	-250	-380	5
180	250	12	9	0	-12	0	-12	8	7	8	0	-300	-500	6

^aBore (V_{dp}) and outside diameter (V_{Dp}) variation in a single radial plane.

^bSingle plane mean bore (Δ_{dmp}) and outside diameter (Δ_{Dmp}) deviation from basic. (For a basically tapered bore, Δ_{dmp} refers only to the theoretical small end of the bore.)

^cSingle bore (Δ_{ds}) and outside diameter (Δ_{Ds}) deviations from basic. These deviations apply to diameter series 0, 1, 2, 3, and 4 only.

^dApplies to groove-type ball bearings only.

^eSingle bore (Δ_{Bs}) and outer ring (Δ_{Cs}) width deviation from basic.

^fInner (V_{Bs}) and outer (V_{Cs}) ring width variation.

^gApplies to the rings of single bearings made for paired or stack mounting.

OUTER RING														
Basic Outer Ring Outside Dia., D		V_{Dp} ^a max		Δ_{Dmp} ^b		Δ_{Ds} ^c		Radial Runout K_{ra}	Outside Cylindrical Surface Runout Outer Ring Ref. Face S_D	Axial Runout of Assembled Bearing Outer Ring S_{ea} ^d	Width			
mm		Diameter Series									Δ_{Cs} ^e		V_{Cs} ^f	
Over	Incl.	7, 8, 9	0, 1, 2, 3, 4	High	low	High	Low	max	max	max	High	Low	max	
6	18	4	3	0	-4	0	-4	3	4	5	Identical to Δ_{Bs} of inner ring of same bearing		2.5	
18	30	5	4	0	-5	0	-5	4	4	5			2.5	
30	50	6	5	0	-6	0	-6	5	4	5			2.5	
50	80	7	5	0	-7	0	-7	5	4	5			3	
80	120	8	6	0	-8	0	-8	6	5	6			4	
120	150	9	7	0	-9	0	-9	7	5	7			5	
150	180	10	8	0	-10	0	-10	8	5	8			5	
180	250	11	8	0	-11	0	-11	19	7	10			5	
													7	

^aNo values have been established for capped bearings.

All units are micrometers, unless otherwise indicated. For sizes beyond range of this table, see Standard. This table does not cover instrument bearings.

Table 5. ABEC-9 Tolerance Limits for Metric Ball and Roller Bearing ANSI/ABMA 20-1987

INNER RING												
Inner Ring Bore Basic Dia., d		V_{dp} ^a max	Δ_{dmp} ^b		Δ_{ds} ^c		Radial Runout K_{ra}	Ref. Face Runout with Bore S_d	Axial Runout of Assembled Bearing with Inner Ring S_{ia} ^d	Width		
mm										Δ_{Bs} ^e		V_{Bs} ^f
Over	Incl.	max	High	Low	High	Low	max	max	max	High	Low	max
2.5	10	2.5	0	-2.5	0	-2.5	1.5	1.5	1.5	0	-40	1.5
10	18	2.5	0	-2.5	0	-2.5	1.5	1.5	1.5	0	-80	1.5
18	30	2.5	0	-2.5	0	-2.5	2.5	1.5	2.5	0	-120	1.5
30	50	2.5	0	-2.5	0	-2.5	2.5	1.5	2.5	0	-120	1.5
50	80	4	0	-4	0	-4	2.5	1.5	2.5	0	-150	1.5
50	80	4	0	-4	0	-4	2.5	1.5	2.5	0	-150	1.5
80	120	5	0	-5	0	-5	2.5	2.5	2.5	0	-200	2.5
120	150	7	0	-7	0	-7	2.5	2.5	2.5	0	-250	2.5
150	180	7	0	-7	0	-7	5	4	5	0	-300	4
180	250	8	0	-8	0	-8	5	5	5	0	-350	5

^a Bore (V_{dp}) and outside diameter (V_{Dp}) variation in a single radial plane.

^b Single plane mean bore (Δ_{dmp}) and outside diameter (Δ_{Dmp}) deviation from basic. (For a basically tapered bore, Δ_{dmp} refers to the theoretical small end of the bore.)

^c Single bore diameter (Δ_{ds}) and outside diameter (Δ_{Ds}) deviation from basic.

^d Applies to groove-type ball bearings only.

^e Single bore (Δ_{Bs}) and outer ring (Δ_{Cs}) width variation from basic.

^f Inner (V_{Bs}) and outer (V_{Cs}) ring width variation.

OUTER RING												
Basic Outside Diameter, D		V_{Dp} ^a	Δ_{Dmp} ^b		Δ_{Ds} ^c		Radial Runout K_{ra}	Outside Cylindrical Surface Runout with Outer Ring S_D	Axial Runout of Assembled Bearing with Outer Ring S_{oa}	Width		
mm										Δ_{Cs} ^e		V_{Cs} ^f
Over	Incl.	max	High	Low	High	Low	max	max	max	High	Low	max
6	18	2.5	0	-2.5	0	-2.5	1.5	1.5	1.5	Identical to Δ_{Bs} of inner ring of same bearing		1.5
18	30	4	0	-4	0	-4	2.5	1.5	2.5			1.5
30	50	4	0	-4	0	-4	2.5	1.5	2.5			1.5
50	80	4	0	-4	0	-4	4	1.5	4			1.5
80	120	5	0	-5	0	-5	5	2.5	5			1.5
120	150	5	0	-5	0	-5	5	2.5	5			1.5
150	180	7	0	-7	0	-7	5	2.5	5			2.5
180	250	8	0	-8	0	-8	7	4	7			4
250	315	8	0	-8	0	-8	7	5	7			5

^a No values have been established for capped bearings.

All units are micrometers, unless otherwise indicated. For sizes beyond range of this table, see Standard. This table does not cover instrument bearings.

Bearing Tolerances.—In order to provide standards of precision for proper application of ball or roller bearings in all types of equipment, five classes of tolerances have been established by the Anti-Friction Bearing Manufacturers Association for ball bearings, three for cylindrical roller bearings and one for spherical roller bearings. These tolerances are given in Tables 1, 2, 3, 4, and 5. They are designated as ABEC-1, ABEC-3, ABEC-5, ABEC-7 and ABEC-9 for ball bearings, the ABEC-9 being the most precise, RBEC-1, RBEC-3, and RBEC-5 for roller bearings. In general, bearings to specifications closer than ABEC-1 or RBEC-1 are required because of the need for very precise fits on shaft or housing, to reduce eccentricity or runout of shaft or supported part, or to permit operation at very high speeds. All five classes include tolerances for bore, outside diameter, ring width, and radial runouts of inner and outer rings. ABEC-5, ABEC-7 and ABEC-9 provide added tolerances for parallelism of sides, side runout and groove parallelism with sides.

Thrust Bearings: Anti-Friction Bearing Manufacturers Association and American National Standard tolerance limits for metric single direction thrust ball and roller bearings are given in Table 6. Tolerance limits for single direction thrust ball bearings, inch dimensioned are given in Table 7, and for cylindrical thrust roller bearings, inch dimensioned in Table 8.

**Table 6. AFBMA and American National Standard Tolerance Limits for Metric Single Direction Thrust Ball (Type TA) and Roller Type (Type TS) Bearings
ANSI/ABMA 24.1-1989**

Bore Dia. of Shaft Washer, <i>d</i>		Δd_{mp}^a				S_p, S_e^b		ΔT_s^c		Outside Dia. of Housing Washer, <i>D</i>		ΔD_{mp}^a	
mm		High	Low	Max	Max	Min Type TA	Min Type TS	Over	Incl.	High	Low		
Over	Incl.												
18	30	0	-10	10	20	-250	...	10	18	0	-11		
30	50	0	-12	10	20	-250	-300	18	30	0	-13		
50	80	0	-15	10	20	-300	-400	30	50	0	-16		
80	120	0	-20	15	25	-300	-400	50	80	0	-19		
120	180	0	-25	15	25	-400	-500	80	120	0	-22		
180	250	0	-30	20	30	-400	-500	120	180	0	-25		
250	315	0	-35	25	40	-400	-700	180	250	0	-30		
315	400	0	-40	30	40	-500	-700	250	315	0	-35		
400	500	0	-45	30	50	-500	-900	315	400	0	-40		
500	630	0	-50	35	60	-600	-1200	400	500	0	-45		

^a Single plane mean bore diameter deviation of central shaft washer (Δd_{mp}) and outside diameter (ΔD_{mp}) variation.

^b Raceway parallelism with the face, housing-mounted (S_p) and boremounted (S_e) race or washer.

^c Deviation of the actual bearing height.

All dimensions in micrometers, unless otherwise indicated.

Tolerances are for normal tolerance class only. For sizes beyond the range of this table and for other tolerance class values, see Standard. All entries apply to type TA bearings; boldface entries also apply to type TS bearings.

**Table 7. Tolerance Limits for Single Direction Ball Thrust Bearings—Inch Design
ANSI/ABMA 24.2-1998**

Bore Diameter ^a <i>d</i> , Inches		Single Plane Mean Bore Dia. Variation, <i>d</i> , Inch		Outside Diameter <i>D</i> , Inches		Single Plane Mean O.D. Variation, <i>D</i> , Inch	
Over	Incl.	High	Low	Over	Incl.	High	Low
0	6.7500	+0.005	0	0	5.3125	+0	-0.002
6.7500	20.0000	+0.010	0	5.3125	17.3750	+0	-0.003
...	17.3750	39.3701	+0	-0.004

^a Bore tolerance limits are: For bore diameters over 0 to 1.8125 inches, inclusive, +0.005, -0.005; over 1.8125 to 12.000 inches, inclusive, +0.010, -0.010; over 12.000 to 20.000, inclusive, +0.0150, -0.0150.

Table 8. Tolerance Limits for Cylindrical Roller Thrust Bearings—Inch Design
ANSI/ABMA 24.2-1998

Basic Bore Dia., d		Δd_{mp}^a		ΔT_s^b		Basic Outside dia., D		ΔD_{mp}^c	
Over	Incl.	Low	High	High	Low	Over	Incl.	High	Low
EXTRA LIGHT SERIES—TYPE TP									
0	0.9375	+0.040	+0.060	+0.050	-0.050	0	4.7188	+0	-0.030
0.9375	1.9375	+0.050	+0.070	+0.050	-0.050	4.7188	5.2188	+0	-0.030
1.9375	3.0000	+0.060	+0.080	+0.050	-0.050
3.0000	3.5000	+0.080	+0.100	-0.100	-0.100

^aSingle plane mean bore diameter deviation.

^bDeviation of the actual bearing height, single direction bearing.

^cSingle plane mean outside diameter deviation.

Basic Bore Diameter, d		Δd_{mp}^a		Basic Outside Diameter, D		Outside Dia., D Tolerance Limits		Basic Bore Diameter, d		ΔT_s	
Over	Incl.	High	Low	Over	Incl.	High	Low	Over	Incl.	High	Low
LIGHT SERIES—TYPE TP											
0	1.1870	+0	-0.005	0	2.8750	+0.005	-0	0	2.0000	+0	-0.06
1.1870	1.3750	+0	-0.006	2.8750	3.3750	+0.007	-0	2.0000	3.0000	+0	-0.08
1.3750	1.5620	+0	-0.007	3.3750	3.7500	+0.009	-0	3.0000	6.0000	+0	-0.10
1.5620	1.7500	+0	-0.008	3.7500	4.1250	+0.011	-0	6.0000	10.0000	+0	-0.15
1.7500	1.9370	+0	-0.009	4.1250	4.7180	+0.013	-0	10.0000	18.0000	+0	-0.20
1.9370	2.1250	+0	-0.010	4.7180	5.2180	+0.015	-0	18.0000	30.0000	+0	-0.25
2.1250	2.5000	+0	-0.011
2.2500	3.0000	+0	-0.012
3.0000	3.5000	+0	-0.013
HEAVY SERIES—TYPE TP											
2.0000	3.0000	+0	-0.010	5.0000	10.0000	+0.015	-0	0	2.000	+0	-0.06
3.0000	3.5000	+0	-0.012	10.0000	18.0000	+0.020	-0	2.000	3.000	+0	-0.08
3.5000	9.0000	+0	-0.015	18.0000	26.0000	+0.025	-0	3.000	6.000	+0	-0.10
9.0000	12.0000	+0	-0.018	26.0000	34.0000	+0.030	-0	6.000	10.000	+0	-0.15
12.0000	18.0000	+0	-0.020	34.0000	44.0000	+0.040	-0	10.000	18.000	+0	-0.20
18.0000	22.0000	+0	-0.025	18.000	30.000	+0	-0.25
22.0000	30.0000	+0	-0.03
TYPE TPC											
0	2.0156	+0.010	-0	2.5000	4.0000	+0.005	-0.005	0	2.0156	+0	-0.08
2.0156	3.0156	+0.010	-0.020	4.0000	6.0000	+0.006	-0.006	2.0156	3.0156	+0	-0.10
3.0156	6.0156	+0.015	-0.020	6.0000	10.0000	+0.010	-0.010	3.0156	6.0156	+0	-0.15
6.0156	10.1560	+0.015	-0.050	10.0000	18.0000	+0.012	-0.012	6.0156	10.1560	+0	-0.20

All dimensions are in inches.

For Type TR bearings, see Standard.

Only one class of tolerance limits is established for metric thrust bearings.

Radial Needle Roller Bearings: Tolerance limits for needle roller bearings, drawn cup, without inner ring, inch types NIB, NIBM, NIY, NIYM, NIH, and NIHM are given in Table 9 and for metric types NB, NBM, NY, NYM, NH and NHM in Table 10. Standard tolerance limits for needle roller bearings, with cage, machined ring, without inner ring, inch type NIA are given in Table 11 and for needle roller bearings inner rings, inch type NIR in Table 12.

Table 9. AFBMA and American National Standard Tolerance Limits for Needle Roller Bearings, Drawn Cup, Without Inner Ring — Inch Types NIB, NIBM, NIY, NIYM, NIH, and NIHM ANSI/ABMA 18.2-1982 (R1993)

Ring Gage Bore Diameter ^a			Basic Bore Diameter under Needle Rollers, F_w		Allowable Deviation from F_w ^a		Allowable Deviation from Width, B	
Basic Outside Diameter, D Inch		Deviation from D Inch	Inch		Inch		Inch	
Over	Incl.		Over	Incl.	Low	High	High	Low
0.1875	0.9375	+0.0005	0.1875	0.6875	+0.0015	+0.0024	+0	-0.0100
0.9375	4.0000	-0.0005	0.6875	1.2500	+0.0005	+0.0014	+0	-0.0100
For fitting and mounting practice see Table 18.			1.2500	1.3750	+0.0005	+0.0015	+0	-0.0100
			1.3750	1.6250	+0.0005	+0.0016	+0	-0.0100
			1.6250	1.8750	+0.0005	+0.0017	+0	-0.0100
			1.8750	2.0000	+0.0006	+0.0018	+0	-0.0100
			2.0000	2.5000	+0.0006	+0.0020	+0	-0.0100
			2.5000	3.5000	+0.0010	+0.0024	+0	-0.0100

^a The bore diameter under needle rollers can be measured only when bearing is pressed into a ring gage, which rounds and sizes the bearing.

Table 10. AFBMA and American National Standard Tolerance Limits for Needle Roller Bearings, Drawn Cup, Without Inner Ring — Metric Types NB, NBM, NY, NYM, NH, and NHM ANSI/ABMA 18.1-1982 (R1994)

Ring Gage Bore Diameter ^a			Basic Bore Diameter under Needle Rollers, F_w		Allowable Deviation from F_w ^a		Allowable Deviation from Width, B	
Basic Outside Diameter, D mm		Deviation from D Micrometers	mm		Micrometers		Micrometers	
Over	Incl.		Over	Incl.	Low	High	High	Low
6	10	-16	3	6	+10	+28	+0	-250
10	18	-20	6	10	+13	+31	+0	-250
30	50	-28	18	30	+20	+41	+0	-250
50	80	-33	30	50	+25	+50	+0	-250
...	50	70	+30	+60	+0	-250

^a The bore diameter under needle rollers can be measured only when bearing is pressed into a ring gage, which rounds and sizes the bearing.

For fitting and mounting practice, see Table 18.

Table 11. AFBMA and American National Standard Tolerance Limits for Needle Roller Bearings, With Cage, Machined Ring, Without Inner Ring—Inch Type NIA ANSI/ABMA 18.2-1982 (R1993)

Basic Outside Diameter, D		Allowable Deviation From D of Single Mean Diameter, D_{mp}		Basic Bore Diameter under Needle Rollers, F_w		Allowable Deviation from F_w		Allowable Deviation from Width, B	
Inch		Inch		Inch		Inch		Inch	
Over	Incl.	High	Low	Over	Incl.	Low	High	High	Low
0.7500	2.0000	+0	-0.0005	0.3150	0.7087	+0.0008	+0.0017	+0	-0.0050
2.0000	3.2500	+0	-0.0006	0.7087	1.1811	+0.0009	+0.0018	+0	-0.0050
3.2500	4.7500	+0	-0.0008	1.1811	1.6535	+0.0010	+0.0019	+0	-0.0050
4.7500	7.2500	+0	-0.0010	1.6535	1.9685	+0.0010	+0.0020	+0	-0.0050
				1.9685	2.7559	+0.0011	+0.0021	+0	-0.0050
7.2500	10.2500	+0	-0.0012	2.7559	3.1496	+0.0011	+0.0023	+0	-0.0050
10.2500	11.1250	+0	-0.0014	3.1496	4.0157	+0.0012	+0.0024	+0	-0.0050
...	4.0157	4.7244	+0.0012	+0.0026	+0	-0.0050
...	4.7244	6.2992	+0.0013	+0.0027	+0	-0.0050
...	6.2992	7.0866	+0.0013	+0.0029	+0	-0.0050
...	7.0866	7.8740	+0.0014	+0.0030	+0	-0.0050
...	7.8740	9.2520	+0.0014	+0.0032	+0	-0.0050

For fitting and mounting practice, see Table 19.

Table 12. AFBMA and American National Standard Tolerance Limits for Needle Roller Bearing Inner Rings—Inch Type NIR ANSI/ABMA 18.2-1982 (R1993)

Basic Outside Diameter, F		Allowable Deviation From F of Single Mean Diameter, F_{mp}		Basic Bore Diameter d		Allowable Deviation from d of Single Mean Diameter, d_{mp}		Allowable Deviation from Width, B	
Inch		Inch		Inch		Inch		Inch	
Over	Incl.	High	Low	Over	Incl.	High	Low	High	Low
0.3937	0.7087	-0.0005	-0.0009	0.3125	0.7500	+0	-0.0004	+0.0100	+0.0050
0.7087	1.0236	-0.0007	-0.0012	0.7500	2.0000	+0	-0.0005	+0.0100	+0.0050
1.0236	1.1811	-0.0009	-0.0014	2.0000	3.2500	+0	-0.0006	+0.0100	+0.0050
1.1811	1.3780	-0.0009	-0.0015	3.2500	4.2500	+0	-0.0008	+0.0100	+0.0050
1.3780	1.9685	-0.0010	-0.0016	4.2500	4.7500	+0	-0.0008	+0.0150	+0.0100
1.9685	3.1496	-0.0011	-0.0018	4.7500	7.0000	+0	-0.0010	+0.0150	+0.0100
3.1496	3.9370	-0.0013	-0.0022	7.0000	8.0000	+0	-0.0012	+0.0150	+0.0100
3.9370	4.7244	-0.0015	-0.0024
4.7244	5.5118	-0.0015	-0.0025
5.5118	7.0866	-0.0017	-0.0027
7.0866	8.2677	-0.0019	-0.0031
8.2677	9.2520	-0.0020	-0.0032

For fitting and mounting practice, see Table 20.

Metric Radial Ball and Roller Bearing Shaft and Housing Fits.—To select the proper fits, it is necessary to consider the type and extent of the load, bearing type, and certain other design and performance requirements.

The required shaft and housing fits are indicated in Tables 13 and 14. The terms “Light,” “Normal,” and “Heavy” loads refer to radial loads that are generally within the following limits, with some overlap (C being the Basic Load Rating computed in accordance with AFBMA-ANSI Standards):

Bearing Type	Radial Load		
	Light	Normal	Heavy
Ball	Up to $0.075C$	From $0.075C$ to $0.15C$	Over $0.15C$
Cylindrical Roller	Up to $0.075C$	From $0.075C$ to $0.2C$	Over $0.15C$
Spherical Roller	Up to $0.075C$	From $0.070C$ to $0.25C$	Over $0.15C$

Shaft Fits: Table 13 indicates the initial approach to shaft fit selection. Note that for most normal applications where the shaft rotates and the radial load direction is constant, an interference fit should be used. Also, the heavier the load, the greater is the required interference. For stationary shaft conditions and constant radial load direction, the inner ring may be moderately loose on the shaft.

For pure thrust (axial) loading, heavy interference fits are not necessary; only a moderately loose to tight fit is needed.

The upper part of Table 15 shows how the shaft diameters for various ANSI shaft limit classifications deviate from the basic bore diameters.

Table 16 gives metric values for the shaft diameter and housing bore tolerance limits given in Table 15.

The lower parts of Tables 15 and 16 show how housing bores for various ANSI hole limit classifications deviate from the basic shaft outside diameters.

Table 13. Selection of Shaft Tolerance Classifications for Metric Radial Ball and Roller Bearings of ABEC-1 and RBEC-1 Tolerance Classes ANSI/ABMA 7-1995

Operating Conditions			Nominal Shaft Diameter						Tolerance Symbol ^a
			Ball Bearings		Cylindrical Roller Bearings		Spherical Roller Bearings		
			mm	Inch	mm	Inch	mm	Inch	
Inner ring stationary in relation to the direction of the load.	All loads	Inner ring has to be easily displaceable	All diameters	All diameters	All diameters	All diameters	All diameters	All diameters	g6
		Inner ring does not have to be easily displaceable	All diameters	All diameters	All diameters	All diameters	All diameters	All diameters	h6
Direction of load indeterminate or the inner ring rotating in relation to the direction of the load.	Radial load:		≤18	≤0.71	≤40	≤1.57	≤40	≤1.57	h5
	LIGHT		>18	>0.71	(40)–140	(1.57)–5.51	(40)–100	(1.57)–3.94	j6 ^b
					(140)–320	(5.51)–12.6	(100)–320	(3.94)–12.6	k6 ^b
					(320)–500	(12.6)–19.7	(320)–500	(12.6)–19.7	m6 ^b
					>500	>19.7	>500	>19.7	n6
									p6
								j5	
								k5	
								m5	
								m6	
								n6	
								p6	
								r6	
								r7	
								k5	
								m5	
								m6 ^b	
								n6 ^b	
								p6 ^b	
								r6 ^b	
								r7 ^b	
Pure Thrust Load			All diam.	All diam.	Consult Bearing Manufacturer			j6	

^aFor solid steel shafts. For hollow or nonferrous shafts, tighter fits may be needed.

^bWhen greater accuracy is required, use j5, k5, and m5 instead of j6, k6, and m6, respectively.

Numerical values are given in Tables 15 and 16.

Table 14. Selection of Housing Tolerance Classifications for Metric Radial Ball and Roller Bearings of ABEC-1 and RBEC-1 Tolerance Classes

Design and Operating Conditions				Tolerance Classification ^a
Rotational Conditions	Loading	Outer Ring Axial Displacement Limitations	Other Conditions	
Outer ring stationary in relation to load direction	Light Normal and Heavy	Outer ring must be easily axially displaceable	Heat input through shaft	G7
			Housing split axially	H7 ^b
			Housing not split axially	H6 ^b
	J6 ^b			
Load direction is indeterminate	Shock with temporary complete unloading	Transitional Range ^c	split housing not recommended	K6 ^b
	Light and normal			
	Normal and Heavy			
Outer ring rotating in relation to load direction	Heavy Shock	Outer ring need not be axially displaceable	Thin wall housing not split	P6 ^b
	Light			
	Normal and Heavy			

^aFor cast iron or steel housings. For housings of nonferrous alloys tighter fits may be needed.

^bWhere wider tolerances are permissible, use tolerance classifications P7, N7, M7, K7, J7, and H7, in place of P6, N6, M6, K6, J6, and H6, respectively.

^cThe tolerance zones are such that the outer ring may be either tight or loose in the housing.

Table 15. AFBMA and American National Standard Shaft Diameter and Housing Bore Tolerance Limits ANSI/ABMA 7-1995

Allowable Deviations of Shaft Diameter from Basic Bore Diameter, Inch																
Inches		mm		g6	h6	h5	j5	j6	k5	k6	m5	m6	n6	p6	r6	r7
Over	Incl.	Over	Incl.													
Base Bore Diameter																
0.2362	0.3937	6	10	-0.002 -0.006	0 -0.004	0 -0.002	+0.002 -0.001	+0.003 -0.001	+0.003 0		+0.005 +0.002					
0.3937	0.7087	10	18	-0.002 -0.007	0 -0.004	0 -0.003	+0.002 -0.001	+0.003 -0.001	+0.004 0		+0.006 +0.003					
0.7087	1.1811	18	30	-0.003 -0.008	0 -0.005		+0.002 -0.002	+0.004 -0.002	+0.004 +0.001		+0.007 +0.003					
1.1811	1.9685	30	50	-0.004 -0.010	0 -0.006		+0.002 -0.002	+0.004 -0.002	+0.005 +0.001	+0.007 +0.001	+0.008 +0.004	+0.010 +0.004				
1.9685	3.1496	50	80	-0.004 -0.011	0 -0.007		+0.002 -0.003	+0.005 -0.003	+0.006 +0.001	+0.008 +0.001	+0.009 +0.004	+0.012 +0.004	+0.018 +0.009			
3.1496	4.7244	80	120	-0.005 -0.013	0 -0.009		+0.002 -0.004	+0.005 -0.004	+0.007 +0.001	+0.010 +0.001	+0.011 +0.005	+0.014 +0.005	+0.019 +0.010	+0.023 +0.015		
Allowable Deviations of Housing Bore from Basic Outside Diameter of Shaft, Inch																
Basic Outside Diameter				G7	H7	H6	J7	J6	K6	K7	M6	M7	N6	N7	P6	P7
0.7087	1.1811	18	30	+0.003 +0.011	0 +0.008	0 +0.005	-0.004 +0.005	-0.002 +0.003	-0.004 +0.001	-0.006 +0.002	-0.007 +0.002	-0.008 0	-0.009 -0.004	-0.011 -0.003	-0.012 -0.007	-0.014 -0.006
1.1811	1.9685	30	50	+0.004 +0.013	0 +0.010	0 +0.006	-0.004 +0.006	-0.002 +0.004	-0.005 +0.001	-0.007 +0.003	-0.008 -0.002	-0.010 0	-0.011 -0.005	-0.013 -0.003	-0.015 -0.008	-0.017 -0.007
1.9685	3.1496	50	80	+0.004 +0.016	0 +0.012	0 +0.007	-0.005 +0.007	-0.002 +0.005	-0.006 +0.002	-0.008 +0.004	-0.009 -0.002	-0.012 0	-0.013 -0.006	-0.015 -0.004	-0.018 -0.010	-0.020 -0.008
3.1496	4.7244	80	120	+0.005 +0.019	0 +0.014	0 +0.009	-0.005 +0.009	-0.002 +0.006	-0.007 +0.002	-0.010 +0.004	-0.011 -0.002	-0.014 0	-0.015 -0.006	-0.018 -0.004	-0.020 -0.012	-0.023 -0.009
4.7244	7.0866	120	180	+0.006 +0.021	0 +0.016	0 +0.010	-0.006 +0.010	-0.003 +0.007	-0.008 +0.002	-0.011 +0.005	-0.013 -0.003	-0.016 0	-0.018 -0.008	-0.020 -0.005	-0.024 -0.014	-0.027 -0.011
7.0866	9.8425	180	250	+0.006 +0.024	0 +0.018	0 +0.011	-0.006 +0.012	-0.003 +0.009	-0.009 +0.002	-0.013 +0.005	-0.015 -0.003	-0.018 0	-0.020 -0.009	-0.024 -0.006	-0.028 -0.016	-0.031 -0.013

Based on ANSI B4.1-1967 (R1994) Preferred Limits and Fits for Cylindrical Parts. Symbols g6, h6, etc., are shaft and G7, H7, etc., hole limits designations. For larger diameters and metric values see AFBMA Standard 7.

Table 16. AFBMA and American National Standard Shaft Diameter and Housing Bore Tolerance Limits ANSI/ABMA 7-1995

Allowable Deviations of Shaft Diameter from Basic Bore Diameter, mm																
Inches		mm		g6	h6	h5	j5	j6	k5	k6	m5	m6	n6	p6	r6	r7
Over	Incl.	Over	Incl.													
Base Bore Diameter																
0.2362	0.3937	6	10	-.005 -.014	0 -.009	0 -.006	+.004 -.002	+.007 -.002	+.007 -.001		+.012 +.006					
0.3937	0.7087	10	18	-.006 -.017	0 -.011	0 -.008	+.005 -.003	+.008 -.003	+.009 +.001		+.015 +.007					
0.7087	1.1811	18	30	-.007 -.020	0 -.013		+.005 -.004	+.009 -.004	+.011 +.002		+.017 +.008					
1.1811	1.9685	30	50	-.009 -.025	0 -.016		+.006 -.005	+.011 -.005	+.013 +.002	+.018 +.002	+.020 +.009	+.025 +.009				
1.9685	3.1496	50	80	-.010 -.029	0 -.019		+.006 -.007	+.012 -.007	+.015 +.002	+.021 +.002	+.024 +.011	+.030 +.011	+.039 +.020			
3.1496	4.7244	80	120	-.012 -.034	0 -.022		+.006 -.009	+.013 -.009	+.018 +.003	+.025 +.003	+.028 +.013	+.035 +.013	+.045 +.023	+.059 +.037		
Allowable Deviations of Housing Bore from Basic Outside Diameter of Shaft, mm																
Basic Outside Diameter				G7	H7	H6	J7	J6	K6	K7	M6	M7	N6	N7	P6	P7
.7086	1.1811	18	30	+.007 +.028	0 +.021	0 +.013	-.009 +.012	-.005 +.008	-.011 +.002	-.015 +.006	-.017 -.004	-.021 0	-.024 -.011	-.028 -.007	-.031 -.018	-.035 -.014
1.1811	1.9685	30	50	+.009 +.034	0 +.025	0 +.016	-.011 +.014	-.006 +.010	-.013 +.003	-.018 +.007	-.020 -.004	-.025 0	-.028 -.012	-.033 -.008	-.037 -.021	-.042 -.017
1.9685	3.1496	50	80	+.010 +.040	0 +.030	0 +.019	-.012 +.018	-.006 +.013	-.015 +.004	-.021 +.009	-.024 -.005	-.030 0	-.033 -.014	-.039 -.009	-.045 -.026	-.051 -.021
3.1496	4.7244	80	120	+.012 +.047	0 +.035	0 +.022	-.013 +.022	-.006 +.016	-.018 +.004	-.025 +.010	-.028 -.006	-.035 0	-.038 -.016	-.045 -.010	-.052 -.030	-.059 -.024
4.7244	7.0866	120	180	+.014 +.054	0 +.040	0 +.025	-.014 +.026	-.007 +.018	-.021 +.004	-.028 +.012	-.033 -.008	-.040 0	-.045 -.020	-.052 -.012	-.061 -.036	-.068 -.028
7.0866	9.8425	180	250	+.015 +.061	0 +.046	0 +.029	-.016 +.030	-.007 +.022	-.024 +.005	-.033 +.013	-.037 -.008	-.046 0	-.051 -.022	-.060 -.014	-.070 -.041	-.079 -.033

Based on ANSI B4.1-1967 (R1994) Preferred Limits and Fits for Cylindrical Parts. Symbols g6, h6, etc., are shaft and G7, H7, etc., hole limits designations. For larger diameters and metric values see AFBMA Standard 7.

Design and Installation Considerations.—Interference fitting will reduce bearing radial internal clearance, so it is recommended that prospective users consult bearing manufacturers to make certain that the required bearings are correctly specified to satisfy all mounting, environmental and other operating conditions and requirements. This check is particularly necessary where heat sources in associated parts may further diminish bearing clearances in operation.

Standard values of radial internal clearances of radial bearings are listed in AFBMA-ANSI Standard 20.

Allowance for Axial Displacement.—Consideration should be given to axial displacement of bearing components owing to thermal expansion or contraction of associated parts. Displacement may be accommodated either by the internal construction of the bearing or by allowing one of the bearing rings to be axially displace-able. For unusual applications consult bearing manufacturers.

Needle Roller Bearing Fitting and Mounting Practice.—The tolerance limits required for shaft and housing seat diameters for needle roller beatings with inner and outer rings as well as limits for raceway diameters where inner or outer rings or both are omitted and rollers operate directly upon these surfaces are given in Tables 17 through 20, inclusive. Unusual design and operating conditions may require a departure from these practices. In such cases, bearing manufacturers should be consulted.

Needle Roller Bearings, Drawn Cup: These beatings without inner ring, Types NIB, NB, NIBM, NBM, NIY, NY, NIYM, NYM, NIH, NH, NIHM, NHM, and Inner Rings, Type NIR depend on the housings into which they are pressed for their size and shape. Therefore, the housings must not only have the proper bore dimensions but also must have sufficient strength. Tables 17 and 18, show the bore tolerance limits for rigid housings such as those made from cast iron or steel of heavy radial section equal to or greater than the ring gage section given in AFBMA Standard 4, 1984. The bearing manufacturers should be consulted for recommendations if the housings must be of lower strength materials such as aluminum or even of steel of thin radial section. The shape of the housing bores should be such that when the mean bore diameter of a housing is measured in each of several radial planes, the maximum difference between these mean diameters should not exceed 0.0005 inch (0.013 mm) or one-half the housing bore tolerance limit, if smaller. Also, the radial deviation from circular form should not exceed 0.00025 inch (0.006 mm). The housing bore surface finish should not exceed 125 micro-inches (3.2 micrometers) arithmetical average.

Table 17. AFBMA and American National Standard Tolerance Limits for Shaft Raceway and Housing Bore Diameters—Needle Roller Bearings, Drawn Cup, Without Inner Ring, Inch Types NIB, NIBM, NIY, NIYM, NIH, and NIHM
ANSI/ABMA 18.2-1982 (R1993)

Basic Bore Diameter under Needle Rollers, F_w		Shaft Raceway Diameter ^a Allowable Deviation from F_w		Basic Outside Diameter, D		Housing Bore Diameter ^a Allowable Deviation from D	
Inch		Inch		Inch		Inch	
Over	Incl.	High	Low	Over	Incl.	Low	High
OUTER RING STATIONARY RELATIVE TO LOAD							
0.1875	1.8750	+0	-0.0005	0.3750	4.0000	-0.0005	+0.0005
1.8750	3.5000	+0	-0.0006
OUTER RING ROTATING RELATIVE TO LOAD							
0.1875	1.8750	-0.0005	-0.0010	0.3750	4.0000	-0.0010	+0
1.8750	3.5000	-0.0005	-0.0011

^a See text for additional requirements.

For bearing tolerances, see Table 9.

Table 18. AFBMA and American National Standard Tolerance Limits for Shaft Raceway and Housing Bore Diameters—Needle Roller Bearings, Drawn Cup, Without Inner Ring, Metric Types NB, NBM, NY, NYM, NH, and NHM
ANSI/ABMA 18.1-1982 (R1994)

Basic Bore Diameter Under Needle Rollers, F_w				Shaft Raceway Diameter ^a Allowable Deviation from F_w		Basic Outside Diameter, D				Housing Bore Diameter ^a Allowable Deviation from D	
OUTER RING STATIONARY RELATIVE TO LOAD											
mm		Inch		ANSI h6, Inch		mm		Inch		ANSI N7, Inch	
Over	Incl.	Over	Incl.	High	Low	Over	Incl.	Over	Incl.	Low	High
3	6	0.1181	0.2362	+0	-0.0003	6	10	0.2362	0.3937	-0.0007	-0.0002
6	10	0.2362	0.3937	+0	-0.0004	10	18	0.3937	0.7087	-0.0009	-0.0002
10	18	0.3937	0.7087	+0	-0.0004	18	30	0.7087	1.1811	-0.0011	-0.0003
18	30	0.7087	1.1811	+0	-0.0005	30	50	1.1811	1.9685	-0.0013	-0.0003
30	50	1.1811	1.9685	+0	-0.0006	50	80	1.9685	3.1496	-0.0015	-0.0004
50	80	1.9685	3.1496	+0	-0.0007
OUTER RING ROTATING RELATIVE TO LOAD											
mm		Inch		ANSI f6, Inch		mm		Inch		ANSI R7, Inch	
Over	Incl.	Over	Incl.	High	Low	Over	Incl.	Over	Incl.	Low	High
3	6	0.1181	0.2362	-0.0004	-0.0007	6	10	0.2362	0.3937	-0.0011	-0.0005
6	10	0.2362	0.3937	-0.0005	-0.0009	10	18	0.3937	0.7087	-0.0013	-0.0006
10	18	0.3937	0.7087	-0.0006	-0.0011	18	30	0.7087	1.1811	-0.0016	-0.0008
18	30	0.7087	1.1811	-0.0008	-0.0013	30	50	1.1811	1.9685	-0.0020	-0.0010
30	50	1.1811	1.9685	-0.0010	-0.0016	50	65	1.9685	2.5591	-0.0024	-0.0012
50	80	1.9685	3.1496	-0.0012	-0.0019	65	80	2.5591	3.1496	-0.0024	-0.0013

For bearing tolerances, see Table 10.

Table 19. AFBMA and American National Standard Tolerance Limits for Shaft Raceway and Housing Bore Diameters—Needle Roller Bearings, With Cage, Machined Ring, Without Inner Ring, Inch Type NIA
ANSI/ABMA 18.2-1982 (R1993)

Basic Bore Diameter under Needle Rollers, F_w		Shaft Raceway Diameter ^a Allowable Deviation from F_w		Basic Outside Diameter, D		Housing Bore Diameter ^a Allowable Deviation from D	
OUTER RING STATIONARY RELATIVE TO LOAD							
Inch		ANSI h6, Inch		Inch		ANSI H7, Inch	
Over	Incl.	High	Low	Over	Incl.	Low	High
0.2362	0.3937	+0	-0.0004	0.3937	0.7087	+0	+0.0007
0.3937	0.7087	+0	-0.0004	0.7087	1.1811	+0	+0.0008
0.7087	1.1811	+0	-0.0005	1.1811	1.9685	+0	+0.0010
1.1811	1.9685	+0	-0.0006	1.9685	3.1496	+0	+0.0012
1.9685	3.1496	+0	-0.0007	3.1496	4.7244	+0	+0.0014
3.1496	4.7244	+0	-0.0009	4.7244	7.0866	+0	+0.0016
4.7244	7.0866	+0	-0.0010	7.0866	9.8425	+0	+0.0018
7.0866	9.8425	+0	-0.0011	9.8425	12.4016	+0	+0.0020
OUTER RING ROTATING RELATIVE TO LOAD							
Inch		ANSI f6, Inch		Inch		ANSI N7, Inch	
Over	Incl.	High	Low	Over	Incl.	Low	High
0.2362	0.3937	-0.0005	-0.0009	0.3937	0.7087	-0.0009	-0.0002
0.3937	0.7087	-0.0006	-0.0011	0.7087	1.1811	-0.0011	-0.0003
0.7087	1.1811	-0.0008	-0.0013	1.1811	1.9685	-0.0013	-0.0003
1.1811	1.9685	-0.0010	-0.0016	1.9685	3.1496	-0.0015	-0.0004
1.9685	3.1496	-0.0012	-0.0019	3.1496	4.7244	-0.0018	-0.0004
3.1496	4.7244	-0.0014	-0.0023	4.7244	7.0866	-0.0020	-0.0005
4.7244	7.0866	-0.0016	-0.0027	7.0866	9.8425	-0.0024	-0.0006
7.0866	9.8425	-0.0020	-0.0031	9.8425	11.2205	-0.0026	-0.0006

^a See text for additional requirements.

For bearing tolerances, see Table 11.

Table 20. AFBMA and American National Standard Tolerance Limits for Shaft Diameters—Needle Roller Bearing Inner Rings, Inch Type NIR (Used with Bearing Type NIA) ANSI/ABMA 18.2-1982 (R1993)

Basic Bore, <i>d</i>		Shaft Diameter ^a			
		Shaft Rotating Relative to Load, Outer Ring Stationary Relative to Load Allowable Deviation from <i>d</i>		Shaft Stationary Relative to Load, Outer Ring Rotating Relative to Load Allowable Deviation from <i>d</i>	
Inch		ANSI m5, Inch		ANSI g6, Inch	
Over	Incl.	High	Low	High	Low
0.2362	0.3937	+0.0005	+0.0002	-0.0002	-0.0006
0.3937	0.7087	+0.0006	+0.0003	-0.0002	-0.0007
0.7087	1.1811	+0.0007	+0.0003	-0.0003	-0.0008
1.1811	1.9685	+0.0008	+0.0004	-0.0004	-0.0010
1.9685	3.1496	+0.0009	+0.0004	-0.0004	-0.0011
3.1496	4.7244	+0.0011	+0.0005	-0.0005	-0.0013
4.7244	7.0866	+0.0013	+0.0006	-0.0006	-0.0015
7.0866	9.8425	+0.0015	+0.0007	-0.0006	-0.0017

^a See text for additional requirements.

For inner ring tolerance limits, see Table 12.

Most needle roller bearings do not use inner rings, but operate directly on the surfaces of shafts. When shafts are used as inner raceways, they should be made of bearing quality steel hardened to Rockwell C 58 minimum. Tables 14 and 18 show the shaft raceway tolerance limits and Table 20 shows the shaft seat tolerance limits when inner rings are used. However, whether the shaft surfaces are used as inner raceways or as seats for inner rings, the mean outside diameter of the shaft surface in each of several radial planes should be determined. The difference between these mean diameters should not exceed 0.0003 inch (0.008 mm) or one-half the diameter tolerance limit, if smaller. The radial deviation from circular form should not exceed 0.0001 inch (0.0025 mm), for diameters up to and including 1 in. (25.4 mm). Above one inch the allowable deviation is 0.0001 times the shaft diameter. The surface finish should not exceed 16 micro-inches (0.4 micrometer) arithmetical average. The housing bore and shaft diameter tolerance limits depend upon whether the load rotates relative to the shaft or the housing.

Needle Roller Bearing With Cage, Machined Ring, Without Inner Ring: The following covers needle roller bearings Type NIA and inner rings Type NIR. The shape of the housing bores should be such that when the mean bore diameter of a housing is measured in each of several radial planes, the maximum difference between these mean diameters does not exceed 0.0005 inch (0.013 mm) or one-half the housing bore tolerance limit, if smaller. Also, the radial deviation from circular form should not exceed 0.00025 inch (0.006 mm). The housing bore surface finish should not exceed 125 micro-inches (3.2 micrometers) arithmetical average. Table 20 shows the housing bore tolerance limits.

When shafts are used as inner raceways their requirements are the same as those given above for Needle Roller Bearings, Drawn Cup. Table 19 shows the shaft raceway tolerance limits and Table 20 shows the shaft seat tolerance limits when inner rings are used.

Needle Roller and Cage Assemblies, Types NIM and NM: For information concerning boundary dimensions, tolerance limits, and fitting and mounting practice, reference should be made to ANSI/ABMA 18.1-1982 (R1994) and ANSI/ABMA 18.2-1982 (R1993).

Bearing Mounting Practice.—Because of their inherent design and material rigidity, rolling contact bearings must be mounted with careful control of their alignment and runout. Medium-speed or slower (400,000 *DN* values or less where *D* is the bearing bore in

millimeters and N is the beating speed in revolutions per minute), and medium to light load (C/P values of 7 or greater where C is the beating specific dynamic capacity in pounds and P is the average beating load in pounds) applications can endure misalignments equivalent to those acceptable for high-capacity, precision journal bearings utilizing hard bearing materials such as silver, copper-lead, or aluminum. In no case, however, should the maximum shaft deflection exceed .001 inch per inch for well-crowned roller bearings, and .003 inch per inch for deep-groove ball-bearings. Except for self-aligning ball-bearings and spherical or barrel roller bearings, all other types require shaft alignments with deflections no greater than .0002 inch per inch. With preloaded ball bearings, this same limit is recommended as a maximum. Close-clearance tapered bearings or thrust bearings of most types require the same shaft alignment also.

Of major importance for all bearings requiring good reliability, is the location of the races on the shaft and in the housing.

Assembly methods must insure: 1) that the faces are square, before the cavity is closed; 2) that the cover face is square to the shoulder and pulled in evenly; and 3) that it will be located by a face parallel to it when finally seated against the housing.

These requirements are shown in the accompanying figure. In applications not controlled by automatic tooling with closely controlled fixtures and bolt torquing mechanisms, races should be checked for squareness by sweeping with a dial indicator mounted as shown below. For commercial applications with moderate life and reliability requirements, outer race runouts should be held to .0005 inch per inch of radius and inner race runout to .0004 inch per inch of radius. In preloaded and precision applications, these tolerances must be cut in half. In regard to the question of alignment, it must be recognized that rolling-contact bearings, being made of fully-hardened steel, do not wear in as may certain journal bearings when carefully applied and initially operated. Likewise, rolling contact bearings absorb relatively little deflection when loaded to C/P values of 6 or less. At such stress levels the rolling element-race deformation is generally not over .0002 inch. Consequently, proper mounting and control of shaft deflections are imperative for reliable bearing performance. Aside from inadequate lubrication, these factors are the most frequent causes of premature bearing failures.

Mountings for Precision and Quiet-running Applications.—In applications of rolling-element bearings where vibration or smoothness of operation is critical, special precautions must be taken to eliminate those conditions which can serve to initiate radial and axial motions. These exciting forces can result in shaft excursions which are in resonance with shaft or housing components over a range of frequencies from well below shaft speed to as much as 100 times above it. The more sensitive the configuration, the greater is the need for precision bearings and mountings to be used.

Precision bearings are normally made to much closer tolerances than standard and therefore benefit from better finishing techniques. Special inspection operations are required, however, to provide races and rolling elements with smoothness and runouts compatible with the needs of the application. Similarly, shafts and housings must be carefully controlled.

Among the important elements to be controlled are shaft, race, and housing roundness; squareness of faces, diameters, shoulders, and rolling paths. Though not readily appreciated, grinding chatter, lobular and compensating out-of-roundness, waviness, and flats of less than .0005 inch deviation from the average or mean diameter can cause significant roughness. To detect these and insure the selection of good pieces, three-point electronic indicator inspection must be made. For ultra-precise or quiet applications, pieces are often checked on a "Talyrond" or a similar continuous recording instrument capable of measuring to within a few millionths of an inch. Though this may seem extreme, it has been found that shaft deformities will be reflected through inner races shrunk onto them. Similarly, tight-fit outer races pick up significant deviations in housings. In many instrument and in

missile guidance applications, such deviations and deformities may have to be limited to less than .00002 inch.

In most of these precision applications, bearings are used with rolling elements controlled to less than 5 millionths of an inch deviation from roundness and within the same range for diameter.

Special attention is required both in housing design and in assembly of the bearing to shaft and housing. Housing response to axial excursions forced by bearing wobble (which in itself is a result of out-of-square mounting) has been found to be a major source of small electric and other rotating equipment noise and howl. Stiffer, more massive housings and careful alignment of bearing races can make significant improvements in applications where noise or vibration has been found to be objectionable.

Commercial Application Alignment Tolerances

1. **Housing Face Runout** — Square to shaft center within .0004 inch/inch of radius full indicator-reading.
2. **Outer Race Face Runout** — Square to shaft center within .0004 inch/inch of radius full indicator reading and complementary to the housing runout (not opposed).
3. **Inner Race Face Runout** — Square to shaft center within .0003 inch/inch of radius full indicator reading.
4. and 5. **Cover and Closure Mounting Face Parallelism** — Parallel within .001.
6. **Housing Mounting Face Parallelism** — Parallel within .001

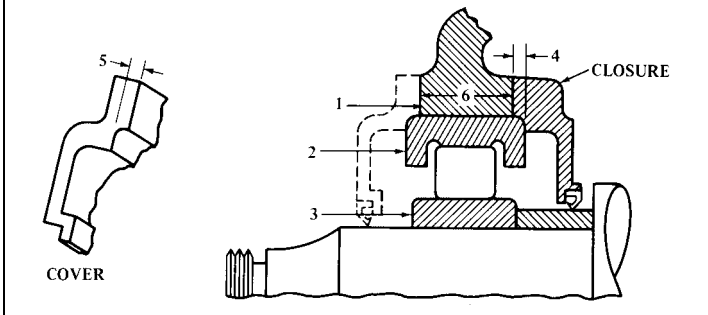

Squareness and Alignment.—In addition to the limits for roundness and wall variation of the races and their supports, squareness of end faces and shoulders must be closely controlled. Tolerances of .0001 inch full indicator reading per inch of diameter are normally required for end faces and shoulders, with appropriately selected limits for fillet eccentricities. The latter must also fall within specified limits for radii tolerances to prevent interference and the resulting cocking of the race. Reference should be made to the bearing dimension tables which list corner radii for typical bearings. Shoulders must also be of a sufficient height to insure proper support for the races, since they are of hardened steel and are less capable of absorbing shock loads and abuse. The general subject of squareness and alignment is of primary importance to the life of rolling element bearings.

The following recommendations for shaft and housing design are given by the New Departure Division of General Motors Corporation:*

“As a rule, there is little trouble experienced with inaccuracies in shafts. Bearings seats and locating shoulders are turned and ground to size with the shaft held on centers and, with ordinary care, there is small chance for serious out-of-roundness or taper. Shaft shoul-

*New Departure Handbook, Vol. II — 1951.

ders should present sufficient surface in contact with the bearing face to assure positive and accurate location.

“Where an undercut must be made for wheel runout in grinding a bearing seat, care should be exercised that no sharp corners are left, for it is at such points that fatigue is most likely to result in shaft breakage. It is best to undercut as little as possible and to have the undercut end in a fillet instead of a sharp corner.

“Where clamping nuts are to be used, it is important to cut the threads as true and square as possible in order to insure even pressure at all points on the bearing inner ring faces when the nuts are set up tight. It is also important not to cut threads so far into the bearing seat as to leave part of the inner ring unsupported or carried on the threads. Excessive deflection is usually the result of improperly designed or undersized machine parts. With a weak shaft, it is possible to seriously affect bearing operation through misalignment due to shaft deflection. Where shafts are comparatively long, the diameter between bearings must be great enough to properly resist bending. In general, the use of more than two bearings on a single shaft should be avoided, owing to the difficulty of securing accurate alignment. With bearings mounted close to each other, this can result in extremely heavy bearing loads.

“Design is as important as careful machining in construction of accurate bearing housings. There should be plenty of metal in the wall sections and large, thin areas should be avoided as much as possible, since they are likely to permit deflection of the boring tool when the housing is being finish-machined.

“Wherever possible, it is best to design a housing so that the radial load placed on the bearing is transmitted as directly as possible to the wall or rib supporting the housing. Diaphragm walls connecting an offset housing to the main wall or side of a machine are apt to deflect unless made thick and well braced.

“When two bearings are to be mounted opposed, but in separate housings, the housings should be so reinforced with fins or webs as to prevent deflection due to the axial load under which the bearings are opposed.

“Where housings are deep and considerable overhang of the boring tool is required, there is a tendency to produce out-of-roundness and taper, unless the tool is very rigid and light finishing cuts are taken. In a too roughly bored housing there is a possibility for the ridges of metal to peen down under load, thus eventually resulting in too loose a fit for the bearing outer ring.”

Soft Metal and Resilient Housings.—In applications relying on bearing housings made of soft materials (aluminum, magnesium, light sheet metal, etc.) or those which lose their fit because of differential thermal expansion, outer race mounting must be approached in a cautious manner. Of first importance is the determination of the possible consequences of race loosening and turning. In conjunction with this, the type of loading must be considered for it may serve to magnify the effect of race loosening. It must be remembered that generally, balancing processes do not insure zero unbalance at operating speeds, but rather an “acceptable” maximum. This force exerted by the rotating element on the outer race can initiate a precession which will aggravate the race loosening problem by causing further attrition through wear, pounding, and abrasion. Since this force is generally of an order greater than the friction forces in effect between the outer race, housing, and closures (retaining nuts also), no foolproof method can be recommended for securing outer races in housings which deform significantly under load or after appreciable service wear. Though many such “fixes” are offered, the only sure solution is to press the race into a housing of sufficient stiffness with the heaviest fit consistent with the installed and operating clearances. In many cases, inserts, or liners of cast iron or steel are provided to maintain the desired fit and increase useful life of both bearing and housing.

Quiet or Vibration-free Mountings.—In seeming contradiction is the approach to bearing mountings in which all shaft or rotating element excursions must be isolated from the

frame, housing, or supporting structure. Here bearing outer races are often supported on elastomeric or metallic springs. Fundamentally, this is an isolation problem and must be approached with caution to insure solution of the primary bearing objective — location and restraint of the rotating body, as well as the reduction or elimination of the dynamic problem. Again, the danger of skidding rolling elements must be considered and reference to the resident engineers or sales engineers of the numerous bearing companies is recommended, as this problem generally develops requirements for special, or non-catalog-type bearings.

General Mounting Precautions.—Since the last operations involving the bearing application — mounting and closing — have such important effects on bearing performance, durability, and reliability, it must be cautioned that more bearings are abused or “killed” in this early stage of their life than wear out or “die” under conditions for which they were designed. Hammer and chisel “mechanics” invariably handle bearings as though no blow could be too hard, no dirt too abrasive, and no misalignment of any consequence. Proper tools, fixtures, and techniques are a must for rolling bearing application, and it is the responsibility of the design engineer to provide for this in his design, advisory notes, mounting instructions, and service manuals. Nicks, dents, scores, scratches, corrosion staining, and dirt must be avoided if reliability, long life, and smooth running are to be expected of rolling bearings. All manufacturers have pertinent service instructions available for the bearing user. These should be followed for best performance. In a later section, methods for inspecting bearings and descriptions of most common bearing deficiencies will be given.

Seating Fits for Bearings.—Anti-Friction Bearing Manufacturers Association (AFBMA) standard shaft and housing bearing seat tolerances are given in Tables 12 through 17, inclusive.

Clamping and Retaining Methods.—Various methods of clamping bearings to prevent axial movement on the shaft are employed, one of the most common being a nut screwed on the end of the shaft and held in place by a tongued lock washer (see Table 21). The shaft thread for the clamping nut (see Table 22) should be cut in accurate relation to bearing seats and shoulders if bearing stresses are to be avoided. The threads used are of American National Form, Class 3; special diameters and data for these are given in Tables 23 and 24. Where somewhat closer than average accuracy is required, the washers and locknut faces may be obtained ground for closer alignment with the threads. For a high degree of accuracy the shaft threads are ground and a more precise clamping means is employed. Where a bearing inner ring is to be clamped, it is important to provide a sufficiently high shoulder on the shaft to locate the bearing positively and accurately. If the difference between bearing bore and maximum shaft diameter gives a low shoulder which would enter the corner of the radius of the bearing, a shoulder ring that extends above the shoulder and well into the shaft corner is employed. A shoulder ring with snap wire fitting into a groove in the shaft is sometimes used where no locating shaft shoulder is present. A snap ring fitting into a groove is frequently employed to prevent endwise movement of the bearing away from the locating shoulder where tight clamping is not required. Such a retaining ring should not be used where a slot in the shaft surface might lead to fatigue failure. Snap rings are also used to locate the outer bearing ring in the housing. Dimensions of snap rings used for this latter purpose are given in AFBMA and ANSI standards.

Table 21. AFBMA Standard Lockwashers (Series W-00) for Ball Bearings and Cylindrical and Spherical Roller Bearings and (Series TW-100) for Tapered Roller Bearings, Inch Design.

Type W No.	Q	Type TW No.	Q	Tangs		Key						Bore R		Diameter		Dia. Over Tangs.		
				No.	Width ^a	Project. ^a	Width S		X		X'		Min.	Max.	E	Tol.	Max.	
					T	V	Min.	Max.	Min.	Max.	Min.	Max.					B	B'
W-00	.032	TW-100	.032	9	.120	.031	.110	.120	.334	.359	.334	.359	.406	0.421	0.625	+0.015	0.875	0.891
W-01	.032	TW-101	.032	9	.120	.031	.110	.120	.412	.437	.412	.437	.484	.499	0.719	+0.015	1.016	1.031
W-02	.032	TW-102	.048	11	.120	.031	.110	.120	.529	.554	.513	.538	.601	.616	0.813	+0.015	1.156	1.156
W-03	.032	TW-103	.048	11	.120	.031	.110	.120	.607	.632	.591	.616	.679	.694	0.938	+0.015	1.328	1.344
W-04	.032	TW-104	.048	11	.166	.031	.156	.176	.729	.754	.713	.738	.801	.816	1.125	+0.015	1.531	1.563
W-05	.040	TW-105	.052	13	.166	.047	.156	.176	.909	.939	.897	.927	.989	1.009	1.281	+0.015	1.719	1.703
W-06	.040	TW-106	.052	13	.166	.047	.156	.176	1.093	1.128	1.081	1.116	1.193	1.213	1.500	+0.015	1.922	1.953
		TW-065	.052	15	.166156	.176	1.221	1.256	1.333	1.353	1.813	+0.015	...	2.234
W-07	.040	TW-107	.052	15	.166	.047	.156	.176	1.296	1.331	1.284	1.319	1.396	1.416	1.813	+0.015	2.250	2.250
W-08	.048	TW-108	.062	15	.234	.047	.250	.290	1.475	1.510	1.461	1.496	1.583	1.603	2.000	+0.030	2.469	2.484
W-09	.048	TW-109	.062	17	.234	.062	.250	.290	1.684	1.724	1.670	1.710	1.792	1.817	2.281	+0.030	2.734	2.719
W-10	.048	TW-110	.062	17	.234	.062	.250	.290	1.884	1.924	1.870	1.910	1.992	2.017	2.438	+0.030	2.922	2.922
W-11	.053	TW-111	.062	17	.234	.062	.250	.290	2.069	2.109	2.060	2.100	2.182	2.207	2.656	+0.030	3.109	3.094
W-12	.053	TW-112	.072	17	.234	.062	.250	.290	2.267	2.307	2.248	2.288	2.400	2.425	2.844	+0.030	3.344	3.328
W-13	.053	TW-113	.072	19	.234	.062	.250	.290	2.455	2.495	2.436	2.476	2.588	2.613	3.063	+0.030	3.578	3.563
W-14	.053	TW-114	.072	19	.234	.094	.250	.290	2.658	2.698	2.639	2.679	2.791	2.816	3.313	+0.030	3.828	3.813
W-15	.062	TW-115	.085	19	.328	.094	.250	.290	2.831	2.876	2.808	2.853	2.973	3.003	3.563	+0.030	4.109	4.047
W-16	.062	TW-116	.085	19	.328	.094	.313	.353	3.035	3.080	3.012	3.057	3.177	3.207	3.844	+0.030	4.375	4.391

^a *Tolerances:* On width, T , $-.010$ inch for Types W-00 to W-03 and TW-100 to TW-103; $-.020$ inch for W-04 to W-07 and TW-104 to TW-107; $-.030$ inch for all others shown. On Projection V , $+.031$ inch for all sizes up through W-13 and TW-113; $+.062$ inch for all others shown.

All dimensions in inches. For dimensions in millimeters, multiply inch values by 25.4 and round result to two decimal places.

Data for sizes larger than shown are given in ANSI/AFBMA Standard 8.2-1991.

Table 22. AFBMA Standard Locknuts (Series N-00) for Ball Bearings and Cylindrical and Spherical Roller Bearings and (Series TN-00) for Tapered Roller Bearings. Inch Design.

Runout and parallelism of faces measured on a tight fitting threaded arbor.

N-00 to N-06 = .002 Max.
N-07 to AN-15 = .004 Max.

TN-065 to TAN-15 = .002 Max.

Surface Finish Note

TN-065 to TN-11, 100 μ in., max.
TN-12 to TAN-15, 120 μ in., max.

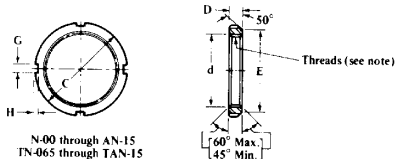

BB & RB Nut No.	TRB Nut No.	Thds. per Inch	Thread Minor Deam.		Thread Pitch Dia.		Thd. Major Dia. <i>d</i>	Outside Dia. <i>C</i>	Face Dia. <i>E</i>		Slot dimension			Thickness <i>D</i>	
			Min.	Max.	Min.	Max.			Min.	Max.	Width <i>G</i>		Height <i>H</i>	Min.	Max.
											Min.	Max.			
N-00	—	32	0.3572	0.3606	0.3707	0.3733	0.391	0.755	.605	.625	.120	.130	.073	.209	.229
N-01	—	32	0.4352	0.4386	0.4487	0.4513	0.469	0.880	.699	.719	.120	.130	.073	.303	.323
N-02	—	32	0.5522	0.5556	0.5657	0.5687	0.586	1.005	.793	.813	.120	.130	.104	.303	.323
N-03	—	32	0.6302	0.6336	0.6437	0.6467	0.664	1.130	.918	.938	.120	.130	.104	.334	.354
N-04	—	32	0.7472	0.7506	0.7607	0.7641	0.781	1.380	1.105	1.125	.178	.198	.104	.365	.385
N-05	—	32	0.9352	0.9386	0.9487	0.9521	0.969	1.568	1.261	1.281	.178	.198	.104	.396	.416
N-06	—	18	1.1129	1.1189	1.1369	1.1409	1.173	1.755	1.480	1.500	.178	.198	.104	.396	.416
	TN-065	18	1.2524	1.2584	1.2764	1.2804	1.312	2.068	1.793	1.813	.178	.198	.104	.428	.448
N-07	TN-07	18	1.3159	1.3219	1.3399	1.3439	1.376	2.068	1.793	1.813	.178	.198	.104	.428	.448
N-08	TN-08	18	1.5029	1.5089	1.5269	1.5314	1.563	2.255	1.980	2.000	.240	.260	.104	.428	.448
N-09	TN-09	18	1.7069	1.7129	1.7309	1.7354	1.767	2.536	2.261	2.281	.240	.260	.104	.428	.448
N-10	TN-10	18	1.9069	1.9129	1.9309	1.9354	1.967	2.693	2.418	2.438	.240	.260	.104	.490	.510
N-11	TN-11	18	2.0969	2.1029	2.1209	2.1260	2.157	2.974	2.636	2.656	.240	.260	.135	.490	.510
N-12	TN-12	18	2.2999	2.3059	2.3239	2.3290	2.360	3.161	2.824	2.844	.240	.260	.135	.521	.541
N-13	TN-13	18	2.4879	2.4949	2.5119	2.5170	2.548	3.380	3.043	3.063	.240	.260	.135	.553	.573
N-14	TN-14	18	2.6909	2.6969	2.7149	2.7200	2.751	3.630	3.283	3.313	.240	.260	.135	.553	.573
AN-15	TAN-15	12	2.8428	2.8518	2.8789	2.8843	2.933	3.880	3.533	3.563	.360	.385	.135	.584	.604

All dimensions in inches. For dimensions in millimeters, multiply inch values, except thread diameters, by 25.4 and round result to two decimal places.

Threads are American National form, Class 3.

Typical steels for locknuts are: AISI, C1015, C1018, C1020, C1025, C1035, C1117, C1118, C1212, C1213, and C1215. Minimum hardness, tensile strength, yield strength and elongation are given in ANSI/ABMA 8.2-1991 which also lists larger sizes of locknuts.

Table 23. AFBMA Standard for Shafts for Locknuts (series N-00) for Ball Bearings and Cylindrical and Spherical Roller Bearings. Inch Design.

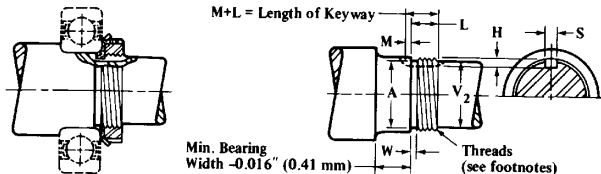

Locknut Number	Bearing Bore	V ₂	Threads ^a					Relief		Keyway		
			No. per inch	Major Dia.	Pitch Dia.	Minor Dia.	Length L	Dia. A	Width W	Depth H	Width S	M
				Max.	Max.	Max.	Max.	Max.	Max.	Max.	Min.	Min.
N-00	0.3937	0.312	32	0.391	0.3707	0.3527	0.297	0.3421	0.078	0.062	0.125	0.094
N-01	0.4724	0.406	32	0.469	0.4487	0.4307	0.391	0.4201	0.078	0.062	0.125	0.094
N-02	0.5906	0.500	32	0.586	0.5657	0.5477	0.391	0.5371	0.078	0.078	0.125	0.094
N-03	0.6693	0.562	32	0.664	0.6437	0.6257	0.422	0.6151	0.078	0.078	0.125	0.094
N-04	0.7874	0.719	32	0.781	0.7607	0.7427	0.453	0.7321	0.078	0.078	0.188	0.094
N-05	0.9843	0.875	32	0.969	0.9487	0.9307	0.484	0.9201	0.078	0.094	0.188	0.125
N-06	1.1811	1.062	18	1.173	1.1369	1.1048	0.484	1.0942	0.109	0.094	0.188	0.125
N-07	1.3780	1.250	18	1.376	1.3399	1.3078	0.516	1.2972	0.109	0.094	0.188	0.125
N-08	1.5748	1.469	18	1.563	1.5269	1.4948	0.547	1.4842	0.109	0.094	0.312	0.125
N-09	1.7717	1.688	18	1.767	1.7309	1.6988	0.547	1.6882	0.141	0.094	0.312	0.156
N-10	1.9685	1.875	18	1.967	1.9309	1.8988	0.609	1.8882	0.141	0.094	0.312	0.156
N-11	2.1654	2.062	18	2.157	2.1209	2.0888	0.609	2.0782	0.141	0.125	0.312	0.156
N-12	2.3622	2.250	18	2.360	2.3239	2.2918	0.641	2.2812	0.141	0.125	0.312	0.156
N-13	2.5591	2.438	18	2.548	2.5119	2.4798	0.672	2.4692	0.141	0.125	0.312	0.156
N-14	2.7559	2.625	18	2.751	2.7149	2.6828	0.672	2.6722	0.141	0.125	0.312	0.250
AN-15	2.9528	2.781	12	2.933	2.8789	2.8308	0.703	2.8095	0.172	0.125	0.312	0.250
AN-16	3.1496	3.000	12	3.137	3.0829	3.0348	0.703	3.0135	0.172	0.125	0.375	0.250

^aThreads are American National form Class 3.

All dimensions in inches. For dimensions in millimeters, multiply inch values, except thread diameters, by 25.4 and round result to two decimal places. See footnote to Table 24 for material other than steel. For sizes larger than shown, see ANSI/ABMA 8.2-1991.

Table 24. AFBMA Standard for Shafts for Tapered Roller Bearing Locknuts. Inch Design.

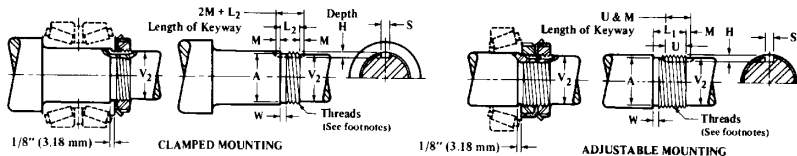

Locknut Number	Bearing Bore	V ₂	Threads ^a					Relief		Keyway				
			No. per inch	Major Dia.	Pitch Dia.	Minor Dia.	Length		Dia. A	Width W	Depth H	Width S	M	U
				Max.	Max.	Max.	L ₁ Max.	L ₂ Max.						
N-00	0.3937	0.312	32	0.391	0.3707	0.3527	0.609	0.391	0.3421	0.078	0.094	0.125	0.094	0.469
N-01	0.4724	0.406	32	0.469	0.4487	0.4307	0.797	0.484	0.4201	0.078	0.094	0.125	0.094	0.562
N-02	0.5906	0.500	32	0.586	0.5657	0.5477	0.828	0.516	0.5371	0.078	0.094	0.125	0.094	0.594
N-03	0.6693	0.562	32	0.664	0.6437	0.6257	0.891	0.547	0.6151	0.078	0.078	0.125	0.094	0.625
N-04	0.7874	0.703	32	0.781	0.7607	0.7427	0.922	0.547	0.7321	0.078	0.094	0.188	0.094	0.625
N-05	0.9843	0.875	32	0.969	0.9487	0.9307	1.016	0.609	0.9201	0.078	0.125	0.188	0.125	0.719
N-06	1.1811	1.062	18	1.173	1.1369	1.1048	1.016	0.609	1.0942	0.109	0.125	0.188	0.125	0.719
TN-065	1.3750	1.188	18	1.312	1.2764	1.2443	1.078	0.641	1.2337	0.109	0.125	0.188	0.125	0.750
TN-07	1.3780	1.250	18	1.376	1.3399	1.3078	1.078	0.641	1.2972	0.109	0.125	0.188	0.125	0.750
TN-08	1.5748	1.438	18	1.563	1.5269	1.4948	1.078	0.641	1.4842	0.109	0.125	0.312	0.125	0.750
TN-09	1.7717	1.656	18	1.767	1.7309	1.6988	1.078	0.641	1.6882	0.141	0.125	0.312	0.156	0.781
TN-10	1.9685	1.859	18	1.967	1.9309	1.8988	1.203	0.703	1.882	0.141	0.125	0.312	0.156	0.844
TN-11	2.1654	2.047	18	2.157	2.1209	2.0888	1.203	0.703	2.0782	0.141	0.125	0.312	0.156	0.844
TN-12	2.3622	2.250	18	2.360	2.3239	2.2918	1.297	0.766	2.2812	0.141	0.156	0.312	0.156	0.906
TN-13	2.5591	2.422	18	2.548	2.5119	2.4798	1.359	0.797	2.4692	0.141	0.156	0.312	0.156	0.938
TN-14	2.7559	2.625	18	2.751	2.7149	2.6828	1.359	0.797	2.6722	0.141	0.156	0.312	0.250	1.000
TAN-15	2.9528	2.781	12	2.933	2.8789	2.8308	1.422	0.828	2.8095	0.172	0.188	0.312	0.250	1.031
TAN-16	3.1496	3.000	12	3.137	3.0829	3.0348	1.422	0.828	3.0135	0.172	0.188	0.375	0.250	1.031

^aThreads are American National form Class 3.

All dimensions in inches. For dimensions in millimeters, multiply inch values, except thread diameters, by 25.4 and round results to two decimal places. These data apply to steel. When either the nut or the shaft is made of stainless steel, aluminum, or other material having a tendency to seize, it is recommended that the maximum thread diameter of the shaft, both major and pitch, be reduced by 20 per cent of the pitch diameter tolerance listed in the Standard. For sizes larger than shown, see ANSI/ABMA 8.2-1991.

Bearing Closures.—Shields, seals, labyrinths, and slingers are employed to retain the lubricant in the bearing and to prevent the entry of dirt, moisture, or other harmful substances. The type selected for a given application depends upon the lubricant, shaft, speed, and the atmospheric conditions in which the unit is to operate. The shields or seals may be located in the bearing itself. Shields differ from seals in that they are attached to one bearing race but there is a definite clearance between the shield and the other, usually the inner, race. When a shielded bearing is placed in a housing in which the grease space has been filled, the bearing in running will tend to expel excess grease past the shields or to accept grease from the housing when the amount in the bearing itself is low.

Seals of leather, rubber, cork, felt, or plastic composition may be used. Since they must bear against the rotating member, excessive pressure should be avoided and some lubricant must be allowed to flow into the area of contact in order to prevent seizing and burning of the seal and scoring of the rotating member. Some seals are made up in the form of cartridges which can be pressed into the end of the bearing housing.

Leather seals may be used over a wide range of speeds. Although lubricant is best retained with a leather cupped inward toward the bearing, this arrangement is not suitable at high speeds due to danger of burning the leather. At high speeds where abrasive dust is present, the seal should be arranged with the leather cupped outward to lead some lubricant into the contact area. Only light pressure of leather against the shaft should be maintained.

Bearing Fits.—The slipping or creeping of a bearing ring on a rotating shaft or in a rotating housing occurs when the fit of the ring on the shaft or in the housing is loose. Such slipping or creeping action may cause rapid wear of both shaft and bearing ring when the surfaces are dry and highly loaded. To prevent this action the bearing is customarily mounted with the rotating ring a press fit and the stationary ring a push fit, the tightness or looseness depending upon the service intended. Thus, where shock or vibratory loads are to be encountered, fits should be made somewhat tighter than for ordinary service. The stationary ring, if correctly fitted, is allowed to creep very slowly so that prolonged stressing of one part of the raceway is avoided.

To facilitate the assembly of a bearing on a shaft it may become necessary to expand the inner ring by heating. This should be done in clean oil or in a temperature-controlled furnace at a temperature of between 200 and 250°F. The utmost care must be used to make sure that the temperature does not exceed 250°F. as overheating will tend to reduce the hardness of the rings. Prelubricated bearings should not be mounted by this method.

Friction Losses in Rolling Element Bearings.—The static and kinematic torques of rolling element bearings are generally small and in many applications are not significant. Bearing torque is a measure of the frictional resistance of the bearing to rotation and is the sum of three components: the torque due to the applied load; the torque due to viscous forces in lubricated rolling element bearings; and the torque due to roller end motions, for example, thrust loads against flanges. The friction or torque data may be used to calculate power absorption or heat generation within the bearing and can be utilized in efficiency or system-cooling studies.

Empirical equations have been developed for each of the torque components. These equations are influenced by such factors as bearing load, lubrication environment, and bearing design parameters. These design parameters include sliding friction from contact between the rolling elements and separator surfaces or between adjacent rolling elements; rolling friction from material deformations during the passage of the rolling elements over the race path; skidding or sliding of the Hertzian contact; and windage friction as a function of speed.

Starting or breakaway torques are also of interest in some situations. Breakaway torques tend to be between 1.5 and 1.8 times the running or kinetic torques.

When evaluating the torque requirements of a system under design, it should be noted that other components of the bearing package, such as seals and closures, can increase the overall system torque significantly. Seal torques have been shown to vary from a fraction of the bearing torque to several times that torque. In addition, the torque values given can vary significantly when load, speed of rotation, temperature, or lubrication are outside normal ranges.

For small instrument bearings friction torque has implications more critical than for larger types of bearings. These bearings have three operating friction torques to consider: starting torque, normal running torque, and peak running torque. These torque levels may vary between manufacturers and among lots from a given manufacturer.

Instrument bearings are even more critically dependent on design features — radial play, retainer type, and race conformity — than larger bearings. Typical starting torque values for small bearings are given in the accompanying table, extracted from the New Departure General Catalog.

Finally, if accurate control of friction torque is critical to a particular application, tests of the selected bearings should be conducted to evaluate performance.

Starting Torque — ABEC7

Bearing Bore (in.)	Max. Starting Torque (g cm)	Thrust Load (g)	Minimum Radial Play Range (inches)	
			High Carbon Chrome Steel and All Miniatures	Stainless Steel Except Miniatures
0.125	0.10	75	0.0003–0.0005	—
	0.14	75	0.0002–0.0004	0.0004–0.0006
	0.18	75	0.0001–0.0003	0.0003–0.0005
	0.22	75	0.0001–0.0003	0.0001–0.0003
0.1875–0.312	0.40	400	0.0005–0.0008	—
	0.45	400	0.0004–0.0006	0.0005–0.0008
	0.50	400	0.0003–0.0005	0.0003–0.0005
	0.63	400	0.0001–0.0003	0.0002–0.0004
0.375	0.50	400	0.0005–0.0008	0.0008–0.0011
	0.63	400	0.0004–0.0006	0.0005–0.0008
	0.75	400	0.0003–0.0005	0.0004–0.0006
	0.95	400	0.0002–0.0004	0.0003–0.0005

Selection of Ball and Roller Bearings.—As compared with sleeve bearings, ball and roller bearings offer the following advantages: 1) Starting friction is low; 2) Less axial space is required; 3) Relatively accurate shaft alignment can be maintained; 4) Both radial and axial loads can be carried by certain types; 5) Angle of load application is not restricted; 6) Replacement is relatively easy; 7) Comparatively heavy overloads can be carried momentarily; 8) Lubrication is simple; and 9) Design and application can be made with the assistance of bearing supplier engineers.

In selecting a ball or roller bearing for a specific application five choices must be made:

1) the bearing series; 2) the type of bearing; 3) the size of bearing; 4) the method of lubrication; and 5) the type of mounting.

Naturally these considerations are modified or affected by the anticipated operating conditions, expected life, cost, and overhaul philosophy.

It is well to review the possible history of the bearing and its function in the machine it will be applied to, thus: 1) Will it be expected to endure removal and reapplication?; 2) Must it be free from maintenance attention during its useful life?; 3) Can wear of the housing or shaft be tolerated during the overhaul period?; 4) Must it be adjustable to take up wear, or to change shaft location?; 5) How accurately can the load spectrum be estimated? and; and 6) Will it be relatively free from abuse in operation?.

Though many cautions could be pointed out, it should always be remembered that inadequate design approaches limit the utilization of rolling element bearings, reduce customer satisfaction, and reduce reliability. Time spent in this stage of design is the most rewarding effort of the bearing engineer, and here again he can depend on the bearing manufacturers' field organization for assistance.

Type: Where loads are low, ball bearings are usually less expensive than roller bearings in terms of unit-carrying capacity. Where loads are high, the reverse is usually true.

For a purely radial load, almost any type of radial bearing can be used, the actual choice being determined by other factors. To support a combination of thrust and radial loads, several types of bearings may be considered. If the thrust load component is large, it may be most economical to provide a separate thrust bearing. When a separate thrust bearing cannot be used due to high speed, lack of space, or other factors, the following types may be considered: angular contact ball bearing, deep groove ball bearing without filling slot, tapered roller bearing with steep contact angle, and self-aligning bearing of the wide type. If movement or deflection in an axial direction must be held to a minimum, then a separate thrust bearing or a preloaded bearing capable of taking considerable thrust load is required. To minimize deflection due to a moment in an axial plane, a rigid bearing such as a double row angular contact type with outwardly converging load lines is required. In such cases, the resulting stresses must be taken into consideration in determining the proper size of the bearing.

For shock loads or heavy loads of short duration, roller bearings are usually preferred.

Special bearing designs may be required where accelerations are usually high as in planetary or crank motions.

Where the problem of excessive shaft deflection or misalignment between shaft and housing is present, a self-aligning type of bearing may be a satisfactory solution.

It should be kept in mind that a great deal of difficulty can be avoided if standard types of bearings are used in preference to special designs, wherever possible.

Size: The size of bearing required for a given application is determined by the loads that are to be carried and, in some cases, by the amount of rigidity that is necessary to limit deflection to some specified amount.

The forces to which a bearing will be subjected can be calculated by the laws of engineering mechanics from the known loads, power, operating pressure, etc. Where loads are irregular, varying, or of unknown magnitude, it may be difficult to determine the actual forces. In such cases, empirical determination of such forces, based on extensive experience in bearing design, may be needed to attack the problem successfully. Where such experience is lacking, the bearing manufacturer should be consulted or the services of a bearing expert obtained.

If a ball or roller bearing is to be subjected to a combination of radial and thrust loads, an *equivalent radial load* is computed in the case of radial or angular type bearings and an *equivalent thrust load* is computed in the case of thrust bearings.

Method of Lubrication.—If speeds are high, relubrication difficult, the shaft angle other than horizontal, the application environment incompatible with normal lubrication, leakage cannot be tolerated; if other elements of the mechanism establish the lubrication requirements, bearing selection must be made with these criteria as controlling influences. Modern bearing types cover a wide selection of lubrication means. Though the most popular type is the “cartridge” type of sealed grease ball bearing, many applications have

requirements which dictate against them. Often, operating environments may subject bearings to temperatures too high for seals utilized in the more popular designs. If minute leakage or the accumulation of traces of dirt at seal lips cannot be tolerated by the application (as in baking industry machinery), then the selections of bearings must be made with other sealing and lubrication systems in mind.

High shaft speeds generally dictate bearing selection based on the need for cooling, the suppression of churning or aeration of conventional lubricants, and most important of all, the inherent speed limitations of certain bearing types. An example of the latter is the effect of cage design and of the roller-end thrust-flange contact on the lubrication requirements in commercial taper roller bearings, which limit the speed they can endure and the thrust load they can carry. Reference to the manufacturers' catalog and application-design manuals is recommended before making bearing selections.

Type of Mounting.—Many bearing installations are complicated because the best adapted type was not selected. Similarly, performance, reliability, and maintenance operations are restricted because the mounting was not thoroughly considered. There is no universally adaptable bearing for all needs. Careful reviews of the machine requirements should be made before designs are implemented. In many cases complicated machining, redundant shaft and housings, and use of an oversize bearing can be eliminated if the proper bearing in a well-thought-out mounting is chosen.

Advantage should be taken of the many race variations available in "standard" series of bearings. Puller grooves, tapered sleeves, ranged outer races, split races, fully demountable rolling-element and cage assemblies, flexible mountings, hydraulic removal features, relubrication holes and grooves, and many other innovations are available beyond the obvious advantages which are inherent in the basic bearing types.

Radial and Axial Clearance.—In designing the bearing mounting, a major consideration is to provide running clearances consistent with the requirements of the application. Race fits must be expected to absorb some of the original bearing clearance so that allowance should be made for approximately 80 per cent of the actual interference showing up in the diameter of the race. This will increase for heavy, stiff housings or for extra light series races shrunk onto solid shafts, while light metal housings (aluminum, magnesium, or sheet metal) and tubular shafts with wall sections less than the race wall thickness will cause a lesser change in the race diameter.

Where the application will impose heat losses through housing or shaft, or where a temperature differential may be expected, allowances must be made in the proper direction to insure proper operating clearance. Some compromises are required in applications where the indicated modification cannot be fully accommodated without endangering the bearing performance at lower speeds, during starting, or under lower temperature conditions than anticipated. Some leeway can be relied on with ball bearings since they can run with moderate preloads (.0005 inch, max.) without affecting bearing life or temperature rise. Roller bearings, however, have a lesser tolerance for preloading, and must be carefully controlled to avoid overheating and resulting self-destruction.

In all critical applications axial and radial clearances should be checked with feeler gages or dial indicators to insure mounted clearances within tolerances established by the design engineer. Since chips, scores, race misalignment, shaft or housing denting, housing distortion, end cover (closure) off-squareness, and mismatch of rotor and housing axial dimensions can rob the bearing of clearance, careful checks of running clearance is recommended.

For precision applications, taper-sleeve mountings, opposed ball or tapered-roller bearings with adjustable or shimmed closures are employed to provide careful control of radial and/or axial clearances. This practice requires skill and experience as well as the initial assistance of the bearing manufacturer's field engineer.

Tapered bore bearings are often used in applications such as these, again requiring careful and well worked-out assembly procedures. They can be assembled on either tapered shafts or on adapter sleeves. Advancement of the inner race over the tapered shaft can be done either by controlled heating (to expand the race as required) or by the use of a hydraulic jack. The adapter sleeve is supplied with a lock-nut which is used to advance the race on the tapered sleeve. With the heavier fits normally required to effect the clearance changes compatible with such mountings, hydraulic removal devices are normally recommended.

For the conventional application, with standard fits, clearances provided in the standard bearing are suitable for normal operation. To insure that the design conditions are "normal," a careful review of the application requirements, environments, operating speed range, anticipated abuses, and design parameters must be made.

General Bearing Handling Precautions.—To insure that rolling element bearings are capable of achieving their design life and that they perform without objectionable noise, temperature rise, or shaft excursions, the following precautions are recommended:

1) Use the best bearing available for the application, consistent with the value of the application. Remember, the cost of the best bearing is generally small compared to the replacement costs of the rotating components that can be destroyed if a bearing fails or malfunctions.

2) If questions arise in designing the bearing application, seek out the assistance of the bearing manufacturer's representative.

3) Handle bearings with care, keeping them in the sealed, original container until ready to use.

4) Follow the manufacturer's instructions in handling and assembling the bearings.

5) Work with clean tools, clean dry hands, and in clean surroundings.

6) Do not wash or wipe bearings prior to installation unless special instructions or requirements have been established to do so.

7) Place unwrapped bearings on clean paper and keep them similarly covered until applied, if they cannot be kept in the original container.

8) Don't use wooden mallets, brittle or chipped tools, or dirty fixtures and tools in mounting bearings.

9) Don't spin uncleaned bearings, nor spin *any* bearing with an air blast.

10) Use care not to scratch or nick bearings.

11) Don't strike or press on race flanges.

12) Use adapters for mounting which provide uniform steady pressure rather than hammering on a drift or sleeve.

13) Insure that races are started onto shafts and into housings evenly so as to prevent cocking.

14) Inspect shafts and housings before mounting bearing to insure that proper fits will be maintained.

15) When removing beatings, clean housings, covers, and shafts before exposing the bearings. All dirt can be considered an abrasive, dangerous to the reuse of any rolling bearing.

16) Treat used beatings, which may be reused, as new ones.

17) Protect dismantled bearings from dirt and moisture.

18) Use clean, lint-free rags if bearings are wiped.

19) Wrap beatings in clean, oil-proof paper when not in use.

20) Use clean filtered, water-free Stoddard's solvent or flushing oil to clean bearings.

21) In heating beatings for mounting onto shafts, follow manufacturer's instructions.

22) In assembling bearings onto shafts *never* strike the outer race, or press on it to force the inner race. Apply the pressure on the inner race only. In dismantling follow the same precautions.

23) Do not press, strike, or otherwise force the seal or shield on factory-sealed beatings.

Bearing Failures, Deficiencies, and Their Origins.—The general classifications of failures and deficiencies requiring bearing removal are:

1) Overheating a) Inadequate or insufficient lubrication; b) Excessive lubrication; c) Grease liquefaction or aeration; d) Oil foaming; e) Abrasive or corrosive action due to contaminants in bearing; f) Distortion of housing due to warping, or out-of-round; g) Seal rubbing or failure; h) Inadequate or blocked scavenge oil passages; i) Inadequate bearing-clearance or bearing-preload; j) Race turning; k) Cage wear; 1) and a) Shaft expansion — loss of bearing or seal clearance..

2) Vibration a) Dirt or chips in bearing; b) Fatigued race or rolling elements; c) Race turning; d) Rotor unbalance; e) Out-of-round shaft; f) Race misalignment; g) Housing resonance; h) Cage wear; i) Flats on races or rolling elements; j) Excessive clearance; k) Corrosion; l) False-brinelling or indentation of races; m) Electrical discharge (similar to corrosion effects); n) Mixed rolling element diameters; 3) and a) Out-of-square rolling paths in races.

4) Turning on shaft a) Growth of race due to overheating; b) Fretting wear; c) Improper initial fit; d) Excessive shaft deflection; e) Initially coarse shaft finish; 5) and a) Seal rub on inner race.

6) Binding of the shaft a) Lubricant breakdown; b) Contamination by abrasive or corrosive matter; c) Housing distortion or out-of-round pinching bearing; d) Uneven shimming of housing with loss of clearance; e) Tight rubbing seals; f) Preloaded beatings; g) Cocked races; h) Loss of clearance due to excessive tightening of adapter; i) Thermal expansion of shaft or housing; 7) and a) Cage failure.

8) Noisy bearing a) Lubrication breakdown, inadequate lubrication, stiff grease; b) Contamination; c) Pinched bearing; d) Seal rubbing; e) Loss of clearance and preloading; f) Bearing slipping on shaft or in housing; g) Flatted roller or ball; h) Brinelling due to assembly abuse, handling, or shock loads; i) Variation in size of rolling elements; j) Out-of-round or lobular shaft; k) Housing bore waviness; 9) and a) Chips or scores under bearing race seat.

10) Displaced shaft a) Bearing wear; b) Improper housing or closure assembly; c) Overheated and shifted bearing; d) Inadequate shaft or housing shoulder; e) Lubrication and cage failure permitting rolling elements to bunch; f) Loosened retainer nut or adapter; g) Excessive heat application in assembling inner race, causing growth and shifting on shaft; 11) and a) Housing pounding out.

12) Lubricant leakage a) Overfilling of lubricant; b) Grease churning due to use of too soft a consistency; c) Grease deterioration due to excessive operating temperature; d) Operating life longer than grease life (grease breakdown, aeration, and purging); e) Seal wear; f) Wrong shaft attitude (bearing seals designed for horizontal mounting only); g) Seal failure; h) Clogged breather; i) Oil foaming due to churning or air flow through housing; j) Gasket (O-ring) failure or misapplication; k) Porous housing or closure; 13) and a) Lubricator set at wrong flow rate.

Load Ratings and Fatigue Life

Ball and Roller Bearing Life.—The performance of ball and roller bearings is a function of many variables. These include the bearing design, the characteristics of the material from which the bearings are made, the way in which they are manufactured, as well as many variables associated with their application. The only sure way to establish the satisfactory operation of a bearing selected for a specific application is by actual performance in the application. As this is often impractical, another basis is required to estimate the suitability of a particular bearing for a given application. Two factors are taken into consideration: the bearing fatigue life, and its ability to withstand static loading.

Life Criterion: Even if a ball or roller bearing is properly mounted, adequately lubricated, protected from foreign matter and not subjected to extreme operating conditions, it can ultimately fatigue. Under ideal conditions, the repeated stresses developed in the contact areas between the balls or rollers and the raceways eventually can result in the fatigue of the material which manifests itself with the spalling of the load-carrying surfaces. In most applications the fatigue life is the maximum useful life of a bearing.

Static Load Criterion: A static load is a load acting on a non-rotating bearing. Permanent deformations appear in balls or rollers and raceways under a static load of moderate magnitude and increase gradually with increasing load. The permissible static load is, therefore, dependent upon the permissible magnitude of permanent deformation. It has been found that for ball and roller bearings suitably manufactured from hardened alloy steel, deformations occurring under maximum contact stress of 4,000 megapascals (580,000 pounds per square inch) acting at the center of contact (in the case of roller bearings, of a uniformly loaded roller) do not greatly impair smoothness or friction. Depending on requirements for smoothness of operation, friction, or sound level, higher or lower static load limits may be tolerated.

Ball Bearing Types Covered.—AFBMA and American National Standard ANSI/ABMA 9-1990 sets forth the method of determining ball bearing Rating Life and Static Load Rating and covers the following types:

1) *Radial, deep groove and angular contact ball bearings* whose inner ring raceways have a cross-sectional radius not larger than 52 percent of the ball diameter and whose outer ring raceways have a cross-sectional radius not larger than 53 percent of the ball diameter.

2) *Radial, self-aligning ball bearings* whose inner ring raceways have cross-sectional radii not larger than 53 percent of the ball diameter.

3) *Thrust ball bearings* whose washer raceways have cross-sectional radii not larger than 54 percent of the ball diameter.

4) *Double row, radial and angular contact ball bearings* and double direction thrust ball bearings are presumed to be symmetrical.

Limitations for Ball Bearings.—The following limitations apply:

1) *Truncated contact area.* This standard* may not be safely applied to ball bearings subjected to loading which causes the contact area of the ball with the raceway to be truncated by the raceway shoulder. This limitation depends strongly on details of bearing design which are not standardized.

2) *Material.* This standard applies only to ball bearings fabricated from hardened good quality steel.

3) *Types.* The f_c factors specified in the basic load rating formulas are valid only for those ball bearing types specified above.

4) *Lubrication.* The Rating Life calculated according to this standard is based on the assumption that the bearing is adequately lubricated. The determination of adequate lubrication depends upon the bearing application.

5) *Ring support and alignment.* The Rating Life calculated according to this standard assumes that the bearing inner and outer rings are rigidly supported and the inner and outer ring axes are properly aligned.

6) *Internal clearance.* The radial ball bearing Rating Life calculated according to this standard is based on the assumption that only a nominal interior clearance occurs in the mounted bearing at operating speed, load and temperature.

7) *High speed effects.* The Rating Life calculated according to this standard does not account for high speed effects such as ball centrifugal forces and gyroscopic moments. These effects tend to diminish fatigue life. Analytical evaluation of these effects frequently

* All references to "standard" are to AFBMA and American National Standard "Load Ratings and Fatigue Life for Ball Bearings" ANSI/ABMA 9-1990.

requires the use of high speed digital computation devices and hence is not covered in the standard.

8) *Groove radii.* If groove radii are smaller than those specified in the bearing types covered, the ability of a bearing to resist fatigue is not improved: however, it is diminished by the use of larger radii.

Ball Bearing Rating Life.—According to the Anti-Friction Bearing Manufacturers Association standards the Rating Life L_{10} of a group of apparently identical ball bearings is the life in millions of revolutions that 90 percent of the group will complete or exceed. For a single bearing, L_{10} also refers to the life associated with 90 percent reliability.

Radial and Angular Contact Ball Bearings: The magnitude of the Rating Life L_{10} in millions of revolutions, for a radial or angular contact ball bearing application is given by the formula:

$$L_{10} = \left(\frac{C}{P}\right)^3 \tag{1}$$

where C = basic load rating, newtons (pounds). See Formulas (2), (3a) and (3b)

P = equivalent radial load, newtons (pounds). See Formula (4)

Table 25. Values of f_c for Radial and Angular Contact Ball Bearings

$\frac{D \cos \alpha}{d_m}$	Single Row Radial Contact; Single and Double Row Angular Contact, Groove Type ^a		Double Row Radial Contact Groove Type		Self-Aligning	
	Metric ^b	Inch ^c	Metric ^b	Inch ^c	Metric ^b	Inch ^c
0.05	46.7	3550	44.2	3360	17.3	1310
0.06	49.1	3730	46.5	3530	18.6	1420
0.07	51.1	3880	48.4	3680	19.9	1510
0.08	52.8	4020	50.0	3810	21.1	1600
0.09	54.3	4130	51.4	3900	22.3	1690
0.10	55.5	4220	52.6	4000	23.4	1770
0.12	57.5	4370	54.5	4140	25.6	1940
0.14	58.8	4470	55.7	4230	27.7	2100
0.16	59.6	4530	56.5	4290	29.7	2260
0.18	59.9	4550	56.8	4310	31.7	2410
0.20	59.9	4550	56.8	4310	33.5	2550
0.22	59.6	4530	56.5	4290	35.2	2680
0.24	59.0	4480	55.9	4250	36.8	2790
0.26	58.2	4420	55.1	4190	38.2	2910
0.28	57.1	4340	54.1	4110	39.4	3000
0.30	56.0	4250	53.0	4030	40.3	3060
0.32	54.6	4160	51.8	3950	40.9	3110
0.34	53.2	4050	50.4	3840	41.2	3130
0.36	51.7	3930	48.9	3730	41.3	3140
0.38	50.0	3800	47.4	3610	41.0	3110
0.40	48.4	3670	45.8	3480	40.4	3070

^aA. When calculating the basic load rating for a unit consisting of two similar, single row, radial contact ball bearings, in a duplex mounting, the pair is considered as one, double row, radial contact ball bearing.

B. When calculating the basic load rating for a unit consisting of two, similar, single row, angular contact ball bearings in a duplex mounting, "face-to-face" or "back-to-back," the pair is considered as one, double row, angular contact ball bearing.

C. When calculating the basic load rating for a unit consisting of two or more similar, single angular contact ball bearings mounted "in tandem," properly manufactured and mounted for equal load distribution, the rating of the combination is the number of bearings to the 0.7 power times the rating of a single row ball bearing. If the unit may be treated as a number of individually interchangeable single row bearings, this footnote "C" does not apply.

^bUse to obtain *C* in newtons when *D* is given in mm.

^cUse to obtain *C* in pounds when *D* is given in inches.

Table 26. Values of *X* and *Y* for Computing Equivalent Radial Load *P* of Radial and Angular Contact Ball Bearings

Contact Angle, α	Table Entering Factors ^a			Single Row Bearings ^b		Double Row Bearings				
				$\frac{F_a}{F_r} > e$		$\frac{F_a}{F_r} \leq e$		$\frac{F_a}{F_r} > e$		
RADIAL CONTACT GROOVE BEARINGS										
	F_d/C_o	$F_d/\sqrt{ZD^2}$		<i>e</i>	<i>X</i>	<i>Y</i>	<i>X</i>	<i>Y</i>	<i>X</i>	<i>Y</i>
		Metric Units	Inch Units							
0°	0.014	0.172	25	0.19		2.30				2.30
	0.028	0.345	50	0.22		1.99				1.99
	0.056	0.689	100	0.26		1.71				1.71
	0.084	1.03	150	0.28		1.56				1.55
	0.11	1.38	200	0.30	0.56	1.45	1	0	0.56	1.45
	0.17	2.07	300	0.34		1.31				1.31
	0.28	3.45	500	0.38		1.15				1.15
	0.42	5.17	750	0.42		1.04				1.04
	0.56	6.89	1000	0.44		1.00				1.00
	ANGULAR CONTACT GROOVE BEARINGS									
	iF_d/C_o	F_d/ZD^2		<i>e</i>	<i>X</i>	<i>Y</i>	<i>X</i>	<i>Y</i>	<i>X</i>	<i>Y</i>
		Metric Units	Inch Units							
5°	0.014	0.172	25	0.23	For this type use the <i>X</i> , <i>Y</i> , and <i>e</i> values applicable to single row radial contact bearings					3.74
	0.028	0.345	50	0.26			2.78		0.78	3.23
	0.056	0.689	100	0.30			2.40			2.78
	0.085	1.03	150	0.34			2.07			2.52
	0.11	1.38	200	0.36			1.87	1		2.36
	0.17	2.07	300	0.40			1.75			2.13
	0.28	3.45	500	0.45			1.58			1.87
	0.42	5.17	750	0.50			1.39			1.69
	0.56	6.89	1000	0.52			1.26			1.63
10°	0.014	0.172	25	0.29		1.88				3.06
	0.029	0.345	50	0.32		1.71				2.78
	0.057	0.689	100	0.36		1.52				2.47
	0.086	1.03	150	0.38		1.41				2.20
	0.11	1.38	200	0.40	0.46	1.41	1		0.75	2.18
	0.17	2.07	300	0.44		1.34				2.18
	0.29	3.45	500	0.49		1.23				2.00
	0.43	5.17	750	0.54		1.10				1.79
	0.57	6.89	1000	0.54		1.01				1.64
						1.00				1.16

Table 26. (Continued) Values of X and Y for Computing Equivalent Radial Load P of Radial and Angular Contact Ball Bearings

15°	0.015	0.172	25	0.38		1.47		1.65		2.39
	0.029	0.345	50	0.40		1.40		1.57		2.28
	0.058	0.689	100	0.43		1.30		1.46		2.11
	0.087	1.03	150	0.46		1.23		1.38		2.00
	0.12	1.38	200	0.47	0.44	1.19	1	1.34	0.72	1.93
	0.17	2.07	300	0.50		1.12		1.26		1.82
	0.29	3.45	500	0.55		1.02		1.14		1.66
	0.44	5.17	750	0.56		1.00		1.12		1.63
	0.58	6.89	1000	0.56		1.00		1.12		1.63
20°	0.57	0.43	1.00	1	1.09	0.70	1.63
25°	0.68	0.41	0.87	1	0.92	0.67	1.41
30°	0.80	0.39	0.76	1	0.78	0.63	1.24
35°	0.95	0.37	0.66	1	0.66	0.60	1.07
40°	1.14	0.35	0.57	1	0.55	0.57	0.98
Self-aligning Ball Bearings				1.5 tan α	0.40	0.4 cot α	1	0.42 cot α	0.65	0.65 cot α

^a Symbol definitions are given on the following page.

^b For single row bearings when $F_a/F_r \leq e$, use $X = 1, Y = 0$. Two similar, single row, angular contact ball bearings mounted face-to-face or back-to-back are considered as one double row, angular contact bearing.

Values of X, Y , and e for a load or contact angle other than shown are obtained by linear interpolation. Values of X, Y , and e do not apply to filling slot bearings for applications in which ball-raceway contact areas project substantially into the filling slot under load. Symbol Definitions: F_a is the applied axial load in newtons (pounds); C_o is the static load rating in newtons (pounds) of the bearing under consideration and is found by Formula (20); i is the number of rows of balls in the bearing; Z is the number of balls per row in a radial or angular contact bearing or the number of balls in a single row, single direction thrust bearing; D is the ball diameter in millimeters (inches); and F_r is the applied radial load in newtons (pounds).

For radial and angular contact ball bearings with balls not larger than 25.4 mm (1 inch) in diameter, C is found by the formula:

$$C = f_c (i \cos \alpha)^{0.7} Z^{2/3} D^{1.8} \tag{2}$$

and with balls larger than 25.4 mm (1 inch) in diameter C is found by the formula:

$$C = 3.647 f_c (i \cos \alpha)^{0.7} Z^{2/3} D^{1.4} \text{ (metric)} \tag{3a}$$

$$C = f_c (i \cos \alpha)^{0.7} Z^{2/3} D^{1.4} \text{ (inch)} \tag{3b}$$

where f_c = a factor which depends on the geometry of the bearing components, the accuracy to which the various bearing parts are made and the material. Values of f_c , are given in Table 25

i = number of rows of balls in the bearing

α = nominal contact angle, degrees

Z = number of balls per row in a radial or angular contact bearing

D = ball diameter, mm (inches)

The magnitude of the equivalent radial load, P , in newtons (pounds) for radial and angular contact ball bearings, under combined constant radial and constant thrust loads is given by the formula:

$$P = XF_r + YF_a \tag{4}$$

where F_r = the applied radial load in newtons (pounds)

F_a = the applied axial load in newtons (pounds)

X = radial load factor as given in Table 28

Y = axial load factor as given in Table 28

Thrust Ball Bearings: The magnitude of the Rating Life L_{10} in millions of revolutions for a thrust ball bearing application is given by the formula:

$$L_{10} = \left(\frac{C_a}{P_a}\right)^3 \tag{5}$$

where C_a = the basic load rating, newtons (pounds). See Formulas (6) to (10)

P_a = equivalent thrust load, newtons (pounds). See Formula (11)

For single row, single and double direction, thrust ball bearing with balls not larger than 25.4 mm (1 inch) in diameter, C_a is found by the formulas:

$$\text{for } \alpha = 90 \text{ degrees, } C_a = f_c Z^{2/3} D^{1.8} \tag{6}$$

$$\text{for } \alpha \neq 90 \text{ degrees, } C_a = f_c (\cos \alpha)^{0.7} Z^{2/3} D^{1.8} \tan \alpha \tag{7}$$

and with balls larger than 25.4 mm (1 inch) in diameter, C_a is found by the formulas:

$$\text{for } \alpha = 90 \text{ degrees, } C_a = 3.647 f_c Z^{2/3} D^{1.4} \quad (\text{metric}) \tag{8a}$$

$$C_a = f_c Z^{2/3} D^{1.4} \quad (\text{inch}) \tag{8b}$$

$$\text{for } \alpha \neq 90 \text{ degrees, } C_a = 3.647 f_c (\cos \alpha)^{0.7} Z^{2/3} D^{1.4} \tan \alpha \quad (\text{metric}) \tag{9a}$$

$$C_a = f_c (\cos \alpha)^{0.7} Z^{2/3} D^{1.4} \tan \alpha \quad (\text{inch}) \tag{9b}$$

where f_c = a factor which depends on the geometry of the bearing components, the accuracy to which the various bearing parts are made, and the material. Values of f_c are given in Table 27

Z = number of balls per row in a single row, single direction thrust ball bearing

D = ball diameter, mm (inches)

α = nominal contact angle, degrees

Table 27. Values of f_c for Thrust Ball Bearings

$\frac{D}{d_m}$	$\alpha = 90^\circ$		$D \cos \alpha$	$\alpha = 45^\circ$		$\alpha = 60^\circ$		$\alpha = 75^\circ$	
	Metric ^a	Inch ^b		Metric ^a	Inch ^b	Metric ^a	Inch ^b	Metric ^a	Inch ^b
0.01	36.7	2790	0.01	42.1	3200	39.2	2970	37.3	2840
0.02	45.2	3430	0.02	51.7	3930	48.1	3650	45.9	3490
0.03	51.1	3880	0.03	58.2	4430	54.2	4120	51.7	3930
0.04	55.7	4230	0.04	63.3	4810	58.9	4470	56.1	4260
0.05	59.5	4520	0.05	67.3	5110	62.6	4760	59.7	4540
0.06	62.9	4780	0.06	70.7	5360	65.8	4990	62.7	4760
0.07	65.8	5000	0.07	73.5	5580	68.4	5190	65.2	4950
0.08	68.5	5210	0.08	75.9	5770	70.7	5360	67.3	5120
0.09	71.0	5390	0.09	78.0	5920	72.6	5510	69.2	5250
0.10	73.3	5570	0.10	79.7	6050	74.2	5630	70.7	5370
0.12	77.4	5880	0.12	82.3	6260	76.6	5830
0.14	81.1	6160	0.14	84.1	6390	78.3	5950
0.16	84.4	6410	0.16	85.1	6470	79.2	6020
0.18	87.4	6640	0.18	85.5	6500	79.6	6050
0.20	90.2	6854	0.20	85.4	6490	79.5	6040
0.22	92.8	7060	0.22	84.9	6450
0.24	95.3	7240	0.24	84.0	6380
0.26	97.6	7410	0.26	82.8	6290
0.28	99.8	7600	0.28	81.3	6180
0.30	101.9	7750	0.30	79.6	6040
0.32	103.9	7900
0.34	105.8	8050

^a Use to obtain C_a in newtons when D is given in mm.

^b Use to obtain C_a in pounds when D is given in inches.

For thrust ball bearings with two or more rows of similar balls carrying loads in the same direction, the basic load rating, C_a , in newtons (pounds) is found by the formula:

$$C_a = (Z_1 + Z_2 + \dots + Z_n) \left[\left(\frac{Z_1}{C_{a1}} \right)^{10/3} + \left(\frac{Z_2}{C_{a2}} \right)^{10/3} + \dots + \left(\frac{Z_n}{C_{an}} \right)^{10/3} \right]^{-0.3} \tag{10}$$

where Z_1, Z_2, \dots, Z_n = number of balls in respective rows of a single-direction multi-row thrust ball bearing

$C_{a1}, C_{a2}, \dots, C_{an}$ = basic load rating per row of a single-direction, multi-row thrust ball bearing, each calculated as a single-row bearing with Z_1, Z_2, \dots, Z_n balls, respectively

The magnitude of the equivalent thrust load, P_a , in newtons (pounds) for thrust ball bearings with $\alpha \neq 90$ degrees under combined constant thrust and constant radial loads is found by the formula:

$$P_a = XF_r + YF_a \tag{11}$$

where F_r = the applied radial load in newtons (pounds)

F_a = the applied axial load in newtons (pounds)

X = radial load factor as given in Table 28

Y = axial load factor as given in Table 28

Table 28. Values of X and Y for Computing Equivalent Thrust Load P_a for Thrust Ball Bearings

Contact Angle α	e	Single Direction Bearings		Double Direction Bearings			
		$\frac{F_a}{F_r} > e$		$\frac{F_a}{F_r} \leq e$		$\frac{F_a}{F_r} > e$	
		X	Y	X	Y	X	Y
45°	1.25	0.66	1	1.18	0.59	0.66	1
60°	2.17	0.92	1	1.90	0.54	0.92	1
75°	4.67	1.66	1	3.89	0.52	1.66	1

For $\alpha = 90^\circ, F_r = 0$ and $Y = 1$.

Roller Bearing Types Covered.—This standard* applies to *cylindrical, tapered and self-aligning radial and thrust roller bearings* and to *needle roller bearings*. These bearings are presumed to be within the size ranges shown in the AFBMA dimensional standards, of good quality and produced in accordance with good manufacturing practice.

Roller bearings vary considerably in design and execution. Since small differences in relative shape of contacting surfaces may account for distinct differences in load carrying ability, this standard does not attempt to cover all design variations, rather it applies to basic roller bearing designs.

The following limitations apply:

1) *Truncated contact area.* This standard may not be safely applied to roller bearings subjected to application conditions which cause the contact area of the roller with the raceway to be severely truncated by the edge of the raceway or roller.

2) *Stress concentrations.* A cylindrical, tapered or self-aligning roller bearing must be expected to have a basic load rating less than that obtained using a value of f_c taken from Table 29 or Table 30 if, under load, a stress concentration is present in some part of the roller-raceway contact. Such stress concentrations occur in the center of nominal point contacts, at the contact extremities for line contacts and at inadequately blended junctions of a rolling surface profile. Stress concentrations can also occur if the rollers are not accu-

* All references to "standard" are to AFBMA and American National Standard "Load Ratings and Fatigue Life for Roller Bearings" ANSI/AFBMA Std 11-1990.

rately guided such as in bearings without cages and bearings not having rigid integral flanges. Values of f_c given in Tables 29 and 30 are based upon bearings manufactured to achieve optimized contact. For no bearing type or execution will the factor f_c be greater than that obtained in Tables 29 and 30.

3) *Material*. This standard applies only to roller bearings fabricated from hardened, good quality steel.

4) *Lubrication*. Rating Life calculated according to this standard is based on the assumption that the bearing is adequately lubricated. Determination of adequate lubrication depends upon the bearing application.

5) *Ring support and alignment*. Rating Life calculated according to this standard assumes that the bearing inner and outer rings are rigidly supported, and that the inner and outer ring axes are properly aligned.

6) *Internal clearance*. Radial roller bearing Rating Life calculated according to this standard is based on the assumption that only a nominal internal clearance occurs in the mounted bearing at operating speed, load, and temperature.

7) *High speed effects*. The Rating Life calculated according to this standard does not account for high speed effects such as roller centrifugal forces and gyroscopic moments: These effects tend to diminish fatigue life. Analytical evaluation of these effects frequently requires the use of high speed digital computation devices and hence, cannot be included.

Table 29. Values of f_c for Radial Roller Bearings

$D \cos \alpha$ d_m	f_c		$D \cos \alpha$ d_m	f_c		$D \cos \alpha$ d_m	f_c	
	Metric ^a	Inch ^b		Metric ^a	Inch ^b		Metric ^a	Inch ^b
0.01	52.1	4680	0.18	88.8	7980	0.35	79.5	7140
0.02	60.8	5460	0.19	88.8	7980	0.36	78.6	7060
0.03	66.5	5970	0.20	88.7	7970	0.37	77.6	6970
0.04	70.7	6350	0.21	88.5	7950	0.38	76.7	6890
0.05	74.1	6660	0.22	88.2	7920	0.39	75.7	6800
0.06	76.9	6910	0.23	87.9	7890	0.40	74.6	6700
0.07	79.2	7120	0.24	87.5	7850	0.41	73.6	6610
0.08	81.2	7290	0.25	87.0	7810	0.42	72.5	6510
0.09	82.8	7440	0.26	86.4	7760	0.43	71.4	6420
0.10	84.2	7570	0.27	85.8	7710	0.44	70.3	6320
0.11	85.4	7670	0.28	85.2	7650	0.45	69.2	6220
0.12	86.4	7760	0.29	84.5	7590	0.46	68.1	6120
0.13	87.1	7830	0.30	83.8	7520	0.47	67.0	6010
0.14	87.7	7880	0.31	83.0	7450	0.48	65.8	5910
0.15	88.2	7920	0.32	82.2	7380	0.49	64.6	5810
0.16	88.5	7950	0.33	81.3	7300	0.50	63.5	5700
0.17	88.7	7970	0.34	80.4	7230

^aFor $\alpha = 0^\circ$, $F_a = 0$ and $X = 1$.

^bUse to obtain C in pounds when l_{eff} and D are given in inches.

Table 30. Values of f_c for Thrust Roller Bearings

$D \cos \alpha$ d_m	$45^\circ < \alpha < 60^\circ$		$60^\circ < \alpha < 75^\circ$		$75^\circ \leq \alpha < 90^\circ$		D d_m	$\alpha = 90^\circ$	
	f_c							f_c	
	Metric ^a	Inch ^b	Metric ^a	Inch ^b	Metric ^a	Inch ^b		Metric ^a	Inch ^b
0.01	109.7	9840	107.1	9610	105.6	9470	0.01	105.4	9500
0.02	127.8	11460	124.7	11180	123.0	11030	0.02	122.9	11000
0.03	139.5	12510	136.2	12220	134.3	12050	0.03	134.5	12100
0.04	148.3	13300	144.7	12980	142.8	12810	0.04	143.4	12800
0.05	155.2	13920	151.5	13590	149.4	13400	0.05	150.7	13200
0.06	160.9	14430	157.0	14080	154.9	13890	0.06	156.9	14100

Table 30. (Continued) Values of f_c for Thrust Roller Bearings

$\frac{D \cos \alpha}{d_m}$	45° < α < 60°		60° < α < 75°		75° ≤ α < 90°		$\frac{D}{d_m}$	α = 90°	
	f_c							f_c	
	Metric ^a	Inch ^b	Metric ^a	Inch ^b	Metric ^a	Inch ^b		Metric ^a	Inch ^b
0.07	165.6	14850	161.6	14490	159.4	14300	0.07	162.4	14500
0.08	169.5	15200	165.5	14840	163.2	14640	0.08	167.2	15100
0.09	172.8	15500	168.7	15130	166.4	14930	0.09	171.7	15400
0.10	175.5	15740	171.4	15370	169.0	15160	0.10	175.7	15900
0.12	179.7	16120	175.4	15730	173.0	15520	0.12	183.0	16300
0.14	182.3	16350	177.9	15960	175.5	15740	0.14	189.4	17000
0.16	183.7	16480	179.3	16080	0.16	195.1	17500
0.18	184.1	16510	179.7	16120	0.18	200.3	18000
0.20	183.7	16480	179.3	16080	0.20	205.0	18500
0.22	182.6	16380	0.22	209.4	18800
0.24	180.9	16230	0.24	213.5	19100
0.26	178.7	16030	0.26	217.3	19600
0.28	0.28	220.9	19900
0.30	0.30	224.3	20100

^a Use to obtain C_a in newtons when l_{eff} and D are given in mm.

^b Use to obtain C_a in pounds when l_{eff} and D are given in inches.

Roller Bearing Rating Life.—The Rating Life L_{10} of a group of apparently identical roller bearings is the life in millions of revolutions that 90 percent of the group will complete or exceed. For a single bearing, L_{10} also refers to the life associated with 90 percent reliability.

Radial Roller Bearings: The magnitude of the Rating Life, L_{10} , in millions of revolutions, for a radial roller bearing application is given by the formula:

$$L_{10} = \left(\frac{C}{P}\right)^{10/3} \tag{12}$$

where C = the basic load rating in newtons (pounds), see Formula (13); and, P = equivalent radial load in newtons (pounds), see Formula (14).

For radial roller bearings, C is found by the formula:

$$C = f_c (i l_{eff} \cos \alpha)^{7/9} Z^{3/4} D^{29/27} \tag{13}$$

where f_c = a factor which depends on the geometry of the bearing components, the accuracy to which the various bearing parts are made, and the material. Maximum values of f_c are given in Table 29

i = number of rows of rollers in the bearing

l_{eff} = effective length, mm (inches) α = nominal contact angle, degrees

Z = number of rollers per row in a radial roller bearing

D = roller diameter, mm (inches) (mean diameter for a tapered roller, major diameter for a spherical roller)

When rollers are longer than $2.5D$, a reduction in the f_c value must be anticipated. In this case, the bearing manufacturer may be expected to establish load ratings accordingly.

In applications where rollers operate directly on a shaft surface or a housing surface, such a surface must be equivalent in all respects to the raceway it replaces to achieve the basic load rating of the bearing.

When calculating the basic load rating for a unit consisting of two or more similar single-row bearings mounted "in tandem," properly manufactured and mounted for equal load distribution, the rating of the combination is the number of bearings to the 7/9 power times

the rating of a single-row bearing. If, for some technical reason, the unit may be treated as a number of individually interchangeable single-row bearings, this consideration does not apply.

The magnitude of the equivalent radial load, P , in newtons (pounds), for radial roller bearings, under combined constant radial and constant thrust loads is given by the formula:

$$P = XF_r + YF_a \quad (14)$$

where F_r = the applied radial load in newtons (pounds)

F_a = the applied axial load in newtons (pounds)

X = radial load factor as given in Table 31

Y = axial load factor as given in Table 31

Typical Bearing Life for Various Design Applications

Uses	Design life in hours	Uses	Design life in hours
Agricultural equipment	3000 – 6000	Gearing units	
Aircraft equipment	500 – 2000	Automotive	600 – 5000
Automotive		Multipurpose	8000 – 15000
Race car	500 – 800	Machine tools	20000
Light motor cycle	600 – 1200	Rail Vehicles	15000 – 25000
Heavy motor cycle	1000 – 2000	Heavy rolling mill	> 50000
Light cars	1000 – 2000	Machines	
Heavy cars	1500 – 2500	Beater mills	20000 – 30000
Light trucks	1500 – 2500	Briquette presses	20000 – 30000
Heavy trucks	2000 – 2500	Grinding spindles	1000 – 2000
Buses	2000 – 5000	Machine tools	10000 – 30000
Electrical		Mining machinery	4000 – 15000
Household appliances	1000 – 2000	Paper machines	50000 – 80000
Motors $\leq \frac{1}{2}$ hp	1000 – 2000	Rolling mills	
Motors ≤ 3 hp	8000 – 10000	Small cold mills	5000 – 6000
Motors, medium	10000 – 15000	Large multipurpose mills	8000 – 10000
Motors, large	20000 – 30000	Rail vehicle axle	
Elevator cables sheaves	40000 – 60000	Mining cars	5000
Mine ventilation fans	40000 – 50000	Motor rail cars	16000 – 20000
Propeller thrust bearings	15000 – 25000	Open-pit mining cars	20000 – 25000
Propeller shaft bearings	> 80000	Streetcars	20000 – 25000
Gear drives		Passenger cars	26000
Boat gearing units	3000 – 5000	Freight cars	35000
Gear drives	> 50000	Locomotive outer bearings	20000 – 25000
Ship gear drives	20000 – 30000	Locomotive inner bearings	30000 – 40000
Machinery for 8 hour service which are not always fully utilized	14000 – 20000	Machinery for short or intermittent operation where service interruption is of minor importance	4000 – 8000
Machinery for 8 hour service which are fully utilized	20000 – 30000	Machinery for intermittent service where reliable operation is of great importance	8000 – 14000
Machinery for continuous 24 hour service	50000 – 60000	Instruments and apparatus in frequent use	0 – 500

Table 31. Values of X and Y for Computing Equivalent Radial Load P for Radial Roller Bearing

Bearing Type	$\frac{F_a}{F_r} \leq e$		$\frac{F_a}{F_r} > e$	
	X	Y	X	Y
Self-Aligning and Tapered Roller Bearings ^a $\alpha \neq 0^\circ$	Single Row Bearings			
	1	0	0.4	$0.4 \cot \alpha$
	Double Row Bearings ^a			
	1	$0.45 \cot \alpha$	0.67	$0.67 \cot \alpha$

^aFor $\alpha = 0^\circ$, $F_a = 0$ and $X = 1$.

$e = 1.5 \tan \alpha$

Roller bearings are generally designed to achieve optimized contact; however, they usually support loads other than the loading at which optimized contact is maintained. The 10/3 exponent in Rating Life Formulas (12) and (15) was selected to yield satisfactory Rating Life estimates for a broad spectrum from light to heavy loading. When loading exceeds that which develops optimized contact, e.g., loading greater than $C/4$ to $C/2$ or $C_d/4$ to $C_d/2$, the user should consult the bearing manufacturer to establish the adequacy of the Rating Life formulas for the particular application.

Thrust Roller Bearings: The magnitude of the Rating Life, L_{10} , in millions of revolutions for a thrust roller bearing application is given by the formula:

$$L_{10} = \left(\frac{C_a}{P_a} \right)^{10/3} \tag{15}$$

where C_a = basic load rating, newtons (pounds). See Formulas (16) to (18)

P_a = equivalent thrust load, newtons (pounds). See Formula (19)

For single row, single and double direction, thrust roller bearings, the magnitude of the basic load rating, C_a , in newtons (pounds), is found by the formulas:

$$\text{for } \alpha = 90^\circ, C_a = f_c l_{eff}^{7/9} Z^{3/4} D^{29/27} \tag{16}$$

$$\text{for } \alpha \neq 90^\circ, C_a = f_c (l_{eff} \cos \alpha)^{7/9} Z^{3/4} D^{29/27} \tan \alpha \tag{17}$$

where f_c = a factor which depends on the geometry of the bearing components, the accuracy to which the various parts are made, and the material. Values of f_c are given in Table

l_{eff} = effective length, mm (inches)

Z = number of rollers in a single row, single direction, thrust roller bearing

D = roller diameter, mm (inches) (mean diameter for a tapered roller, major diameter for a spherical roller)

α = nominal contact angle, degrees

For thrust roller bearings with two or more rows of rollers carrying loads in the same direction the magnitude of C_a is found by the formula:

$$C_a = (Z_1 l_{eff1} + Z_2 l_{eff2} \dots Z_n l_{effn}) \left\{ \left[\frac{Z_1 l_{eff1}}{C_{a1}} \right]^{9/2} + \left[\frac{Z_2 l_{eff2}}{C_{a2}} \right]^{9/2} + \dots \left[\frac{Z_n l_{effn}}{C_{an}} \right]^{9/2} \right\}^{-2/9} \tag{18}$$

Where $Z_1, Z_2 \dots Z_n$ = the number of rollers in respective rows of a single direction, multi-row bearing

$C_{a1}, C_{a2} \dots C_{an}$ = the basic load rating per row of a single direction, multi-row, thrust roller bearing, each calculated as a single row bearing with $Z_1, Z_2 \dots Z_n$ rollers respectively

$l_{eff1}, l_{eff2} \dots l_{effn}$ = effective length, mm (inches), or rollers in the respective rows

In applications where rollers operate directly on a surface supplied by the user, such a surface must be equivalent in all respects to the washer raceway it replaces to achieve the basic load rating of the bearing.

In case the bearing is so designed that several rollers are located on a common axis, these rollers are considered as one roller of a length equal to the total effective length of contact of the several rollers. Rollers as defined above, or portions thereof which contact the same washer-raceway area, belong to one row.

When the ratio of the individual roller effective length to the pitch diameter (at which this roller operates) is too large, a reduction of the f_c value must be anticipated due to excessive slip in the roller-raceway contact.

When calculating the basic load rating for a unit consisting of two or more similar single row bearings mounted "in tandem," properly manufactured and mounted for equal load distribution, the rating of the combination is defined by Formula (18). If, for some technical reason, the unit may be treated as a number of individually interchangeable single-row bearings, this consideration does not apply.

The magnitude of the equivalent thrust load, P_a , in pounds, for thrust roller bearings with α not equal to 90 degrees under combined constant thrust and constant radial loads is given by the formula:

$$P_a = XF_r + YF_a \quad (19)$$

where F_r = applied radial load, newtons (pounds)

F_a = applied axial load, newtons (pounds)

X = radial load factor as given in Table 32

Y = axial load factor as given in Table 32

Table 32. Values of X and Y for Computing Equivalent Thrust Load P_a for Thrust Roller Bearings

Bearing Type	Single Direction Bearings		Double Direction Bearings			
	$\frac{F_a}{F_r} > e$		$\frac{F_a}{F_r} \leq e$		$\frac{F_a}{F_r} > e$	
	X	Y	X	Y	X	Y
Self-Aligning Tapered Thrust Roller Bearings ^a $\alpha \neq 0$	$\tan \alpha$	1	$1.5 \tan \alpha$	0.67	$\tan \alpha$	1

^a For $\alpha = 90^\circ$, $F_r = 0$ and $Y = 1$.

$e = 1.5 \tan \alpha$

Life Adjustment Factors.— In certain applications of ball or roller bearings it is desirable to specify life for a reliability other than 90 per cent. In other cases the bearings may be fabricated from special bearing steels such as vacuum-degassed and vacuum-melted steels, and improved processing techniques. Finally, application conditions may indicate other than normal lubrication, load distribution, or temperature. For such conditions a series of life adjustment factors may be applied to the fatigue life formula. This is fully explained in AFBMA and American National Standard "Load Ratings and Fatigue Life for Ball Bear-

ings" ANSI/AFBMA Std 9-1990 and AFBMA and American National Standard "Load Ratings and Fatigue Life for Roller Bearings" ANSI/AFBMA Std 11-1990. In addition to consulting these standards it may be advantageous to also obtain information from the bearing manufacturer.

Life Adjustment Factor for Reliability.—For certain applications, it is desirable to specify life for a reliability greater than 90 per cent which is the basis of the Rating Life.

To determine the bearing life of ball or roller bearings for reliability greater than 90 per cent, the Rating Life must be adjusted by a factor a_1 such that $L_n = a_1 L_{10}$. For a reliability of 95 per cent, designated as L_5 , the life adjustment factor a_1 is 0.62; for 96 per cent, L_4 , a_1 is 0.53; for 97 per cent, L_3 , a_1 is 0.44; for 98 per cent, L_2 , a_1 is 0.33; and for 99 per cent, L_1 , a_1 is 0.21.

Life Adjustment Factor for Material.—For certain types of ball or roller bearings which incorporate improved materials and processing, the Rating Life can be adjusted by a factor a_2 such that $L_{10}' = a_2 L_{10}$. Factor a_2 depends upon steel analysis, metallurgical processes, forming methods, heat treatment, and manufacturing methods in general. Ball and roller bearings fabricated from consumable vacuum remelted steels and certain other special analysis steels, have demonstrated extraordinarily long endurance. These steels are of exceptionally high quality, and bearings fabricated from these are usually considered special manufacture. Generally, a_2 values for such steels can be obtained from the bearing manufacturer. However, all of the specified limitations and qualifications for the application of the Rating Life formulas still apply.

Life Adjustment Factor for Application Condition.—Application conditions which affect ball or roller bearing life include: 1) lubrication; 2) load distribution (including effects of clearance, misalignment, housing and shaft stiffness, type of loading, and thermal gradients); and 3) temperature.

Items 2 and 3 require special analytical and experimental techniques, therefore the user should consult the bearing manufacturer for evaluations and recommendations.

Operating conditions where the factor a_3 might be less than 1 include: D) exceptionally low values of Nd_m (rpm times pitch diameter, in mm); e.g., $Nd_m < 10,000$; E) lubricant viscosity at less than 70 SSU for ball bearings and 100 SSU for roller bearings at operating temperature; and F) excessively high operating temperatures.

When a_3 is less than 1 it may not be assumed that the deficiency in lubrication can be overcome by using an improved steel. When this factor is applied, $L_{10}' = a_3 L_{10}$.

In most ball and roller bearing applications, lubrication is required to separate the rolling surfaces, i.e., rollers and raceways, to reduce the retainer-roller and retainer-land friction and sometimes to act as a coolant to remove heat generated by the bearing.

Factor Combinations.—A fatigue life formula embodying the foregoing life adjustment factors is $L_{10}' = a_1 a_2 a_3 L_{10}$. Indiscriminate application of the life adjustment factors in this formula may lead to serious overestimation of bearing endurance, since fatigue life is only one criterion for bearing selection. Care must be exercised to select bearings which are of sufficient size for the application.

Ball Bearing Static Load Rating.—For ball bearings suitably manufactured from hardened alloy steels, the static radial load rating is that uniformly distributed static radial bearing load which produces a maximum contact stress of 4,000 megapascals (580,000 pounds per square inch). In the case of a single row, angular contact ball bearing, the static radial load rating refers to the radial component of that load which causes a purely radial displacement of the bearing rings in relation to each other. The static axial load rating is that uniformly distributed static centric axial load which produces a maximum contact stress of 4,000 megapascals (580,000 pounds per square inch).

Radial and Angular Contact Groove Ball Bearings: The magnitude of the static load rating C_o in newtons (pounds) for radial ball bearings is found by the formula:

$$C_o = f_o i Z D^2 \cos \alpha \quad (20)$$

where f_o = a factor for different kinds of ball bearings given in Table 33

i = number of rows of balls in bearing

Z = number of balls per row

D = ball diameter, mm (inches)

α = nominal contact angle, degrees

This formula applies to bearings with a cross sectional raceway groove radius not larger than $0.52 D$ in radial and angular contact groove ball bearing inner rings and $0.53 D$ in radial and angular contact groove ball bearing outer rings and self-aligning ball bearing inner rings.

The load carrying ability of a ball bearing is not necessarily increased by the use of a smaller groove radius but is reduced by the use of a larger radius than those indicated above.

Radial or Angular Contact Ball Bearing Combinations: The basic static load rating for two similar single row radial or angular contact ball bearings mounted side by side on the same shaft such that they operate as a unit (duplex mounting) in "back-to-back" or "face-to-face" arrangement is two times the rating of one single row bearing.

The basic static radial load rating for two or more single row radial or angular contact ball bearings mounted side by side on the same shaft such that they operate as a unit (duplex or stack mounting) in "tandem" arrangement, properly manufactured and mounted for equal load distribution, is the number of bearings times the rating of one single row bearing.

Thrust Ball Bearings: The magnitude of the static load rating C_{oa} for thrust ball bearings is found by the formula:

$$C_{oa} = f_o Z D^2 \cos \alpha \quad (21)$$

where f_o = a factor given in Table 33

Z = number of balls carrying the load in one direction

D = ball diameter, mm (inches)

α = nominal contact angle, degrees

This formula applies to thrust ball bearings with a cross sectional raceway radius not larger than $0.54 D$. The load carrying ability of a bearing is not necessarily increased by use of a smaller radius, but is reduced by use of a larger radius.

Roller Bearing Static Load Rating: For roller bearings suitably manufactured from hardened alloy steels, the static radial load rating is that uniformly distributed static radial bearing load which produces a maximum contact stress of 4,000 megapascals (580,000 pounds per square inch) acting at the center of contact of the most heavily loaded rolling element. The static axial load rating is that uniformly distributed static centric axial load which produces a maximum contact stress of 4,000 megapascals (580,000 pounds per square inch) acting at the center of contact of each rolling element.

Table 33. Values of f_o for Calculating Static Load Rating for Ball Bearings

$\frac{D \cos \alpha}{d_m}$	Radial and Angular Contact Groove Type		Radial Self-Aligning		Thrust	
	Metric ^a	Inch ^b	Metric ^a	Inch ^b	Metric ^a	Inch ^b
0.00	12.7	1850	1.3	187	51.9	7730
0.01	13.0	1880	1.3	191	52.6	7620
0.02	13.2	1920	1.3	195	51.7	7500
0.03	13.5	1960	1.4	198	50.9	7380
0.04	13.7	1990	1.4	202	50.2	7280
0.05	14.0	2030	1.4	206	49.6	7190
0.06	14.3	2070	1.5	210	48.9	7090
0.07	14.5	2100	1.5	214	48.3	7000
0.08	14.7	2140	1.5	218	47.6	6900
0.09	14.5	2110	1.5	222	46.9	6800
0.10	14.3	2080	1.6	226	46.4	6730
0.11	14.1	2050	1.6	231	45.9	6660
0.12	13.9	2020	1.6	235	45.5	6590
0.13	13.6	1980	1.7	239	44.7	6480
0.14	13.4	1950	1.7	243	44.0	6380
0.15	13.2	1920	1.7	247	43.3	6280
0.16	13.0	1890	1.7	252	42.6	6180
0.17	12.7	1850	1.8	256	41.9	6070
0.18	12.5	1820	1.8	261	41.2	5970
0.19	12.3	1790	1.8	265	40.4	5860
0.20	12.1	1760	1.9	269	39.7	5760
0.21	11.9	1730	1.9	274	39.0	5650
0.22	11.6	1690	1.9	278	38.3	5550
0.23	11.4	1660	2.0	283	37.5	5440
0.24	11.2	1630	2.0	288	37.0	5360
0.25	11.0	1600	2.0	293	36.4	5280
0.26	10.8	1570	2.1	297	35.8	5190
0.27	10.6	1540	2.1	302	35.0	5080
0.28	10.4	1510	2.1	307	34.4	4980
0.29	10.3	1490	2.1	311	33.7	4890
0.30	10.1	1460	2.2	316	33.2	4810
0.31	9.9	1440	2.2	321	32.7	4740
0.32	9.7	1410	2.3	326	32.0	4640
0.33	9.5	1380	2.3	331	31.2	4530
0.34	9.3	1350	2.3	336	30.5	4420
0.35	9.1	1320	2.4	341	30.0	4350
0.36	8.9	1290	2.4	346	29.5	4270
0.37	8.7	1260	2.4	351	28.8	4170
0.38	8.5	1240	2.5	356	28.0	4060
0.39	8.3	1210	2.5	361	27.2	3950
0.40	8.1	1180	2.5	367	26.8	3880
0.41	8.0	1160	2.6	372	26.2	3800
0.42	7.8	1130	2.6	377	25.7	3720
0.43	7.6	1100	2.6	383	25.1	3640
0.44	7.4	1080	2.7	388	24.6	3560
0.45	7.2	1050	2.7	393	24.0	3480
0.46	7.1	1030	2.8	399	23.5	3400
0.47	6.9	1000	2.8	404	22.9	3320
0.48	6.7	977	2.8	410	22.4	3240
0.49	6.6	952	2.9	415	21.8	3160
0.50	6.4	927	2.9	421	21.2	3080

^a Use to obtain C_o or C_{oa} in newtons when D is given in mm.

^b Use to obtain C_o or C_{oa} in pounds when D is given in inches.

Note: Based on modulus of elasticity = 2.07×10^5 megapascals (30×10^6 pounds per square inch) and Poisson's ratio = 0.3.

Radial Roller Bearings: The magnitude of the static load rating C_o in newtons (pounds) for radial roller bearings is found by the formulas:

$$C_o = 44 \left(1 - \frac{D \cos \alpha}{d_m} \right) i Z l_{eff} D \cos \alpha \quad (\text{metric}) \quad (22a)$$

$$C_o = 6430 \left(1 - \frac{D \cos \alpha}{d_m} \right) i Z l_{eff} D \cos \alpha \quad (\text{inch}) \quad (22b)$$

where D = roller diameter, mm (inches); mean diameter for a tapered roller and major diameter for a spherical roller

d_m = mean pitch diameter of the roller complement, mm (inches)

i = number of rows of rollers in bearing

Z = number of rollers per row

l_{eff} = effective length, mm (inches); overall roller length minus roller chamfers or minus grinding undercuts at the ring where contact is shortest

α = nominal contact angle, degrees

Radial Roller Bearing Combinations: The static load rating for two similar single row roller bearings mounted side by side on the same shaft such that they operate as a unit is two times the rating of one single row bearing.

The static radial load rating for two or more similar single row roller bearings mounted side by side on the same shaft such that they operate as a unit (duplex or stack mounting) in "tandem" arrangement, properly manufactured and mounted for equal load distribution, is the number of bearings times the rating of one single row bearing.

Thrust Roller Bearings: The magnitude of the static load rating C_{oa} in newtons (pounds) for thrust roller bearings is found by the formulas:

$$C_{oa} = 220 \left(1 - \frac{D \cos \alpha}{d_m} \right) Z l_{eff} D \sin \alpha \quad (\text{metric}) \quad (23a)$$

$$C_{oa} = 32150 \left(1 - \frac{D \cos \alpha}{d_m} \right) Z l_{eff} D \sin \alpha \quad (\text{inch}) \quad (23b)$$

where the symbol definitions are the same as for Formulas (22a) and (22b).

Thrust Roller Bearing Combination: The static axial load rating for two or more similar single direction thrust roller bearings mounted side by side on the same shaft such that they operate as a unit (duplex or stack mounting) in "tandem" arrangement, properly manufactured and mounted for equal load distribution, is the number of bearings times the rating of one single direction bearing. The accuracy of this formula decreases in the case of single direction bearings when $F_r > 0.44 F_a \cot \alpha$ where F_r is the applied radial load in newtons (pounds) and F_a is the applied axial load in newtons (pounds).

Ball Bearing Static Equivalent Load.—For ball bearings the static equivalent radial load is that calculated static radial load which produces a maximum contact stress equal in magnitude to the maximum contact stress in the actual condition of loading. The static equivalent axial load is that calculated static centric axial load which produces a maximum contact stress equal in magnitude to the maximum contact stress in the actual condition of loading.

Radial and Angular Contact Ball Bearings: The magnitude of the static equivalent radial load P_o in newtons (pounds) for radial and angular contact ball bearings under combined thrust and radial loads is the greater of:

$$P_o = X_o F_r + Y_o F_a \quad (24)$$

$$P_o = F_r \tag{25}$$

where X_o = radial load factor given in Table 34

Y_o = axial load factor given in Table 34

F_r = applied radial load, newtons (pounds)

F_a = applied axial load, newtons (pounds)

Table 34. Values of X_o and Y_o for Computing Static Equivalent Radial Load P_o of Ball Bearings

Contact Angle	Single Row Bearings ^a		Double Row Bearings	
	X_o	Y_o^b	X_o	Y_o^b
RADIAL CONTACT GROOVE BEARINGS ^{c,a}				
$\alpha = 0^\circ$	0.6	0.5	0.6	0.5
ANGULAR CONTACT GROOVE BEARINGS				
$\alpha = 15^\circ$	0.5	0.47	1	0.94
$\alpha = 20^\circ$	0.5	0.42	1	0.84
$\alpha = 25^\circ$	0.5	0.38	1	0.76
$\alpha = 30^\circ$	0.5	0.33	1	0.66
$\alpha = 35^\circ$	0.5	0.29	1	0.58
$\alpha = 40^\circ$	0.5	0.26	1	0.52
SELF-ALIGNING BEARINGS				
...	0.5	$0.22 \cot \alpha$	1	$0.44 \cot \alpha$

^a P_o is always $\geq F_r$.

^b Values of Y_o for intermediate contact angles are obtained by linear interpolation.

^c Permissible maximum value of F_r/C_o (where F_a is applied axial load and C_o is static radial load rating) depends on the bearing design (groove depth and internal clearance).

Thrust Ball Bearings: The magnitude of the static equivalent axial load P_{oa} in newtons (pounds) for thrust ball bearings with contact angle $\alpha \neq 90^\circ$ under combined radial and thrust loads is found by the formula:

$$P_{oa} = F_a + 2.3 F_r \tan \alpha \tag{26}$$

where the symbol definitions are the same as for Formulas (24) and (25). This formula is valid for all load directions in the case of double direction ball bearings. For single direction ball bearings, it is valid where $F_r/F_a \leq 0.44 \cot \alpha$ and gives a satisfactory but less conservative value of P_{oa} for F_r/F_a up to $0.67 \cot \alpha$.

Thrust ball bearings with $\alpha = 90^\circ$ can support axial loads only. The static equivalent load for this type of bearing is $P_{oa} = F_a$.

Roller Bearing Static Equivalent Load.—The static equivalent radial load for roller bearings is that calculated, static radial load which produces a maximum contact stress acting at the center of contact of a uniformly loaded rolling element equal in magnitude to the maximum contact stress in the actual condition of loading. The static equivalent axial load is that calculated, static centric axial load which produces a maximum contact stress acting at the center of contact of a uniformly loaded rolling element equal in magnitude to the maximum contact stress in the actual condition of loading.

Radial Roller Bearings: The magnitude of the static equivalent radial load P_o in newtons (pounds) for radial roller bearings under combined radial and thrust loads is the greater of:

$$P_o = X_o F_r + Y_o F_a \quad (27)$$

$$P_o = F_r \quad (28)$$

where X_o = radial factor given in Table 35

Y_o = axial factor given in Table 35

F_r = applied radial load, newtons (pounds)

F_a = applied axial load, newtons (pounds)

Table 35. Values of X_o and Y_o for Computing Static Equivalent Radial Load P_o for Self-Aligning and Tapered Roller Bearings

Bearing Type	Single Row ^a		Double Row	
	X_o	Y_o	X_o	Y_o
Self-Aligning and Tapered $\alpha \neq 0$	0.5	$0.22 \cot \alpha$	1	$0.44 \cot \alpha$

^a P_o is always $\geq F_r$.

The static equivalent radial load for radial roller bearings with $\alpha = 0^\circ$ and subjected to radial load only is $P_{or} = F_r$.

Note: The ability of radial roller bearings with $\alpha = 0^\circ$ to support axial loads varies considerably with bearing design and execution. The bearing user should therefore consult the bearing manufacturer for recommendations regarding the evaluation of equivalent load in cases where bearings with $\alpha = 0^\circ$ are subjected to axial load.

Radial Roller Bearing Combinations: When calculating the static equivalent radial load for two similar single row angular contact roller bearings mounted side by side on the same shaft such that they operate as a unit (duplex mounting) in "back-to-back" or "face-to-face" arrangement, use the X_o and Y_o values for a double row bearing and the F_r and F_a values for the total loads on the arrangement.

When calculating the static equivalent radial load for two or more similar single row angular contact roller bearings mounted side by side on the same shaft such that they operate as a unit (duplex or stack mounting) in "tandem" arrangement, use the X_o and Y_o values for a single row bearing and the F_r and F_a values for the total loads on the arrangement.

Thrust Roller Bearings: The magnitude of the static equivalent axial load P_{oa} in newtons (pounds) for thrust roller bearings with contact angle $\alpha \neq 90^\circ$, under combined radial and thrust loads is found by the formula:

$$P_{oa} = F_a + 2.3 F_r \tan \alpha \quad (29)$$

where F_a = applied axial load, newtons (pounds)

F_r = applied radial load, newtons (pounds)

α = nominal contact angle, degrees

The accuracy of this formula decreases for single direction thrust roller bearings when $F_r > 0.44 F_a \cot \alpha$.

Thrust Roller Bearing Combinations: When calculating the static equivalent axial load for two or more thrust roller bearings mounted side by side on the same shaft such that they operate as a unit (duplex or stack mounting) in "tandem" arrangement, use the F_r and F_a values for the total loads acting on the arrangement.