

MILLING CUTTERS

Selection of Milling Cutters.—The most suitable type of milling cutter for a particular milling operation depends on such factors as the kind of cut to be made, the material to be cut, the number of parts to be machined, and the type of milling machine available. Solid cutters of small size will usually cost less, initially, than inserted blade types; for long-run production, inserted-blade cutters will probably have a lower overall cost. Depending on either the material to be cut or the amount of production involved, the use of carbide-tipped cutters in preference to high-speed steel or other cutting tool materials may be justified.

Rake angles depend on both the cutter material and the work material. Carbide and cast alloy cutting tool materials generally have smaller rake angles than high-speed steel tool materials because of their lower edge strength and greater abrasion resistance. Soft work materials permit higher radial rake angles than hard materials; thin cutters permit zero or practically zero axial rake angles; and wide cutters operate smoother with high axial rake angles. See *Rake Angles for Milling Cutters* on page 801.

Cutting edge relief or clearance angles are usually from 3 to 6 degrees for hard or tough materials, 4 to 7 degrees for average materials, and 6 to 12 degrees for easily machined materials. See *Clearance Angles for Milling Cutter Teeth* on page 800.

The number of teeth in the milling cutter is also a factor that should be given consideration, as explained in the next paragraph.

Number of Teeth in Milling Cutters.—In determining the number of teeth a milling cutter should have for optimum performance, there is no universal rule.

There are, however, two factors that should be considered in making a choice: 1) The number of teeth should never be so great as to reduce the chip space between the teeth to a point where a free flow of chips is prevented; and 2) The chip space should be smooth and without sharp corners that would cause clogging of the chips in the space.

For milling ductile materials that produce a continuous and curled chip, a cutter with large chip spaces is preferable. Such coarse tooth cutters permit an easier flow of the chips through the chip space than would be obtained with fine tooth cutters, and help to eliminate cutter "chatter." For cutting operations in thin materials, fine tooth cutters reduce cutter and workpiece vibration and the tendency for the cutter teeth to "straddle" the workpiece and dig in. For slitting copper and other soft nonferrous materials, teeth that are either chamfered or alternately flat and V-shaped are best.

As a general rule, to give satisfactory performance the number of teeth in milling cutters should be such that *no more than two teeth at a time are engaged in the cut*. Based on this rule, the following formulas are recommended:

For face milling cutters,

$$T = \frac{6.3D}{W} \quad (1)$$

For peripheral milling cutters,

$$T = \frac{12.6D \cos A}{D + 4d} \quad (2)$$

where T = number of teeth in cutter; D = cutter diameter in inches; W = width of cut in inches; d = depth of cut in inches; and A = helix angle of cutter.

To find the number of teeth that a cutter should have when other than two teeth in the cut at the same time is desired, Formulas (1) and (2) should be divided by 2 and the result multiplied by the number of teeth desired in the cut.

Example: Determine the required number of teeth in a face mill where $D = 6$ inches and $W = 4$ inches. Using Formula (1),

$$T = \frac{6.3 \times 6}{4} = 10 \text{ teeth, approximately}$$

Example: Determine the required number of teeth in a plain milling cutter where $D = 4$ inches and $d = \frac{1}{4}$ inch. Using Formula (2),

$$T = \frac{12.6 \times 4 \times \cos 0^\circ}{4 + (4 \times \frac{1}{4})} = 10 \text{ teeth, approximately}$$

In *high speed milling* with sintered carbide, high-speed steel, and cast non-ferrous cutting tool materials, a formula that permits full use of the power available at the cutter but prevents overloading of the motor driving the milling machine is:

$$T = \frac{K \times H}{F \times N \times d \times W} \quad (3)$$

where T = number of cutter teeth; H = horsepower available at the cutter; F = feed per tooth in inches; N = revolutions per minute of cutter; d = depth of cut in inches; W = width of cut in inches; and K = a constant which may be taken as 0.65 for average steel, 1.5 for cast iron, and 2.5 for aluminum. These values are conservative and take into account dulling of the cutter in service.

Example: Determine the required number of teeth in a sintered carbide tipped face mill for high speed milling of 200 Brinell hardness alloy steel if $H = 10$ horsepower; $F = 0.008$ inch; $N = 272$ rpm; $d = 0.125$ inch; $W = 6$ inches; and K for alloy steel is 0.65. Using Formula (3),

$$T = \frac{0.65 \times 10}{0.008 \times 272 \times 0.125 \times 6} = 4 \text{ teeth, approximately}$$

American National Standard Milling Cutters.—According to American National Standard ANSI/ASME B94.19-1997 milling cutters may be classified in two general ways, which are given as follows:

By Type of Relief on Cutting Edges: Milling cutters may be described on the basis of one of two methods of providing relief for the cutting edges. *Profile sharpened* cutters are those on which relief is obtained and which are resharpened by grinding a narrow land back of the cutting edges. Profile sharpened cutters may produce flat, curved, or irregular surfaces. *Form relieved* cutters are those which are so relieved that by grinding only the faces of the teeth the original form is maintained throughout the life of the cutters. Form relieved cutters may produce flat, curved or irregular surfaces.

By Method of Mounting: Milling cutters may be described by one of two methods used to mount the cutter. *Arbor type* cutters are those which have a hole for mounting on an arbor and usually have a keyway to receive a driving key. These are sometimes called *Shell type*. *Shank type* cutters are those which have a straight or tapered shank to fit the machine tool spindle or adapter.

Explanation of the “Hand” of Milling Cutters.—In the ANSI Standard the terms “right hand” and “left hand” are used to describe hand of rotation, hand of cutter and hand of flute helix.

Hand of Rotation or Hand of Cut: is described as either “right hand” if the cutter revolves counterclockwise as it cuts when viewed from a position in front of a horizontal milling machine and facing the spindle or “left hand” if the cutter revolves clockwise as it cuts when viewed from the same position.

American National Standard Plain Milling Cutters ANSI/ASME B94.19-1997

Cutter Diameter			Range of Face Widths Nom. ^a	Hole Diameter		
Nom.	Max.	Min.		Nom.	Max.	Min.
Light-duty Cutters ^b						
2½	2.515	2.485	⅜, ¼, ⅝, ⅜, ½, ⅝, ¾, 1, 1½, 2 and 3	1	1.00075	1.0000
3	3.015	2.985	⅜, ¼, ⅝, ⅜, ⅝, ¾, and 1½ ½, ⅝, ¾,	1	1.00075	1.0000
3	3.015	2.985	1, 1¼, 1½, 2 and 3	1¼	1.2510	1.2500
4	4.015	3.985	¼, ⅝ and ⅜	1	1.00075	1.0000
4	4.015	3.985	⅜, ½, ⅝, ¾, 1, 1½, 2, 3 and 4	1¼	1.2510	1.2500
Heavy-duty Cutters ^c						
2½	2.515	2.485	2	1	1.00075	1.0000
2½	2.515	2.485	4	1	1.0010	1.0000
3	3.015	2.985	2, 2½, 3, 4 and 6	1¼	1.2510	1.2500
4	4.015	3.985	2, 3, 4 and 6	1½	1.5010	1.5000
High-helix Cutters ^d						
3	3.015	2.985	4 and 6	1¼	1.2510	1.2500
4	4.015	3.985	8	1½	1.5010	1.5000

^a Tolerances on Face Widths: Up to 1 inch, inclusive, ± 0.001 inch; over 1 to 2 inches, inclusive, +0.010, -0.000 inch; over 2 inches, +0.020, -0.000 inch.

^b Light-duty plain milling cutters with face widths under ¾ inch have straight teeth. Cutters with ¾-inch face and wider have helix angles of not less than 15 degrees nor greater than 25 degrees.

^c Heavy-duty plain milling cutters have a helix angle of not less than 25 degrees nor greater than 45 degrees.

^d High-helix plain milling cutters have a helix angle of not less than 45 degrees nor greater than 52 degrees.

All dimensions are in inches. All cutters are high-speed steel. Plain milling cutters are of cylindrical shape, having teeth on the peripheral surface only.

Hand of Cutter: Some types of cutters require special consideration when referring to their hand. These are principally cutters with unsymmetrical forms, face type cutters, or cutters with threaded holes. *Symmetrical* cutters may be reversed on the arbor in the same axial position and rotated in the cutting direction without altering the contour produced on the work-piece, and may be considered as either right or left hand. *Unsymmetrical* cutters reverse the contour produced on the work-piece when reversed on the arbor in the same axial position and rotated in the cutting direction. A *single-angle* cutter is considered to be a right-hand cutter if it revolves counterclockwise, or a left-hand cutter if it revolves clockwise, when cutting as viewed from the side of the larger diameter. The *hand of rotation* of a single angle milling cutter need not necessarily be the same as its *hand of cutter*. A *single corner rounding* cutter is considered to be a right-hand cutter if it revolves counterclockwise, or a left-hand cutter if it revolves clockwise, when cutting as viewed from the side of the smaller diameter.

American National Standard Side Milling Cutters ANSI/ASME B94.19-1997

Cutter Diameter			Range of Face Widths Nom. ^a	Hole Diameter		
Nom.	Max.	Min.		Nom.	Max.	Min.
Side Cutters ^b						
2	2.015	1.985	$\frac{3}{16}, \frac{1}{4}, \frac{3}{8}$	$\frac{5}{8}$	0.62575	0.6250
2½	2.515	2.485	$\frac{1}{4}, \frac{3}{8}, \frac{1}{2}$	$\frac{7}{8}$	0.87575	0.8750
3	3.015	2.985	$\frac{1}{4}, \frac{5}{16}, \frac{3}{8}, \frac{7}{16}, \frac{1}{2}$	1	1.00075	1.0000
4	4.015	3.985	$\frac{1}{4}, \frac{3}{8}, \frac{1}{2}, \frac{5}{8}, \frac{3}{4}, \frac{7}{8}$	1	1.00075	1.0000
4	4.015	3.985	$\frac{1}{2}, \frac{5}{8}, \frac{3}{4}$	1¼	1.2510	1.2500
5	5.015	4.985	$\frac{1}{2}, \frac{5}{8}, \frac{3}{4}$	1	1.00075	1.0000
5	5.015	4.985	$\frac{1}{2}, \frac{5}{8}, \frac{3}{4}, 1$	1¼	1.2510	1.2500
6	6.015	5.985	$\frac{1}{2}$	1	1.00075	1.0000
6	6.015	5.985	$\frac{1}{2}, \frac{5}{8}, \frac{3}{4}, 1$	1¼	1.2510	1.2500
7	7.015	6.985	$\frac{3}{4}$	1¼	1.2510	1.2500
7	7.015	6.985	$\frac{3}{4}$	1½	1.5010	1.5000
8	8.015	7.985	$\frac{3}{4}, 1$	1¼	1.2510	1.2500
8	8.015	7.985	$\frac{3}{4}, 1$	1½	1.5010	1.5000
Staggered-tooth Side Cutters ^c						
2½	2.515	2.485	$\frac{1}{4}, \frac{5}{16}, \frac{3}{8}, \frac{1}{2}$	$\frac{7}{8}$	0.87575	0.8750
3	3.015	2.985	$\frac{3}{16}, \frac{1}{4}, \frac{5}{16}, \frac{3}{8}$	1	1.00075	1.0000
3	3.015	2.985	$\frac{1}{2}, \frac{5}{8}, \frac{3}{4}$	1¼	1.2510	1.2500
4	4.015	3.985	$\frac{1}{4}, \frac{5}{16}, \frac{3}{8}, \frac{7}{16}, \frac{1}{2}, \frac{5}{8}, \frac{3}{4}$ and $\frac{7}{8}$	1¼	1.2510	1.2500
5	5.015	4.985	$\frac{1}{2}, \frac{5}{8}, \frac{3}{4}$	1¼	1.2510	1.2500
6	6.015	5.985	$\frac{3}{8}, \frac{1}{2}, \frac{5}{8}, \frac{3}{4}, \frac{7}{8}, 1$	1¼	1.2510	1.2500
8	8.015	7.985	$\frac{3}{8}, \frac{1}{2}, \frac{5}{8}, \frac{3}{4}, 1$	1½	1.5010	1.5000
Half Side Cutters ^d						
4	4.015	3.985	$\frac{3}{4}$	1¼	1.2510	1.2500
5	5.015	4.985	$\frac{3}{4}$	1¼	1.2510	1.2500
6	6.015	5.985	$\frac{3}{4}$	1¼	1.2510	1.2500

^a *Tolerances on Face Widths:* For side cutters, +0.002, -0.001 inch; for staggered-tooth side cutters up to $\frac{3}{4}$ inch face width, inclusive, +0.000 -0.0005 inch, and over $\frac{3}{4}$ to 1 inch, inclusive, +0.000 -0.0010 inch; and for half side cutters, +0.015, -0.000 inch.

^b Side milling cutters have straight peripheral teeth and side teeth on both sides.

^c Staggered-tooth side milling cutters have peripheral teeth of alternate right- and left-hand helix and alternate side teeth.

^d Half side milling cutters have side teeth on one side only. The peripheral teeth are helical of the same hand as the cut. Made either with right-hand or left-hand cut.

All dimensions are in inches. All cutters are high-speed steel. Side milling cutters are of cylindrical shape, having teeth on the periphery and on one or both sides.

Hand of Flute Helix: Milling cutters may have *straight flutes* which means that their cutting edges are in planes parallel to the cutter axis. Milling cutters with flute helix in one direction only are described as having a right-hand helix if the flutes twist away from the observer in a clockwise direction when viewed from either end of the cutter or as having a left-hand helix if the flutes twist away from the observer in a counterclockwise direction when viewed from either end of the cutter. *Staggered tooth cutters* are milling cutters with every other flute of opposite (right and left hand) helix.

An illustration describing the various milling cutter elements of both a profile cutter and a form-relieved cutter is given on page 776.

American National Standard Staggered Teeth, T-Slot Milling Cutters with Brown & Sharpe Taper and Weldon Shanks ANSI/ASME B94.19-1997

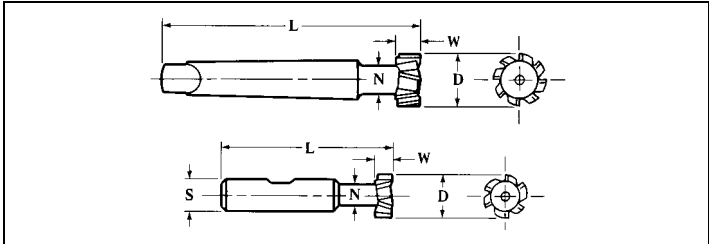

Bolt Size	Cutter Dia., D	Face Width, W	Neck Dia., N	With B. & S. Taper ^{a,b}		With Weldon Shank	
				Length, L	Taper No.	Length, L	Dia., S
$\frac{1}{4}$	$\frac{9}{16}$	$\frac{15}{64}$	$\frac{17}{64}$	$2\frac{19}{32}$	$\frac{1}{2}$
$\frac{5}{16}$	$\frac{21}{32}$	$\frac{17}{64}$	$\frac{21}{64}$	$2\frac{11}{16}$	$\frac{1}{2}$
$\frac{3}{8}$	$\frac{25}{32}$	$\frac{21}{64}$	$\frac{13}{32}$	$3\frac{1}{4}$	$\frac{3}{4}$
$\frac{1}{2}$	$\frac{31}{32}$	$\frac{25}{64}$	$\frac{17}{32}$	5	7	$3\frac{7}{16}$	$\frac{3}{4}$
$\frac{5}{8}$	$1\frac{1}{4}$	$\frac{31}{64}$	$\frac{21}{32}$	$5\frac{1}{4}$	7	$3\frac{15}{16}$	1
$\frac{3}{4}$	$1\frac{15}{32}$	$\frac{3}{8}$	$\frac{25}{32}$	$6\frac{3}{8}$	9	$4\frac{7}{16}$	1
1	$1\frac{27}{32}$	$\frac{5}{8}$	$1\frac{1}{32}$	$7\frac{1}{4}$	9	$4\frac{13}{16}$	$1\frac{1}{4}$

^a For dimensions of Brown & Sharpe tapers, see information given on page 916.

^b Brown & Sharpe taper shanks have been removed from ANSI/ASME B94.19 they are included for reference only.

All dimensions are in inches. All cutters are high-speed steel and only right-hand cutters are standard.

Tolerances: On D , +0.000, -0.010 inch; on W , +0.000, -0.005 inch; on N , +0.000, -0.005 inch; on L , $\pm \frac{1}{16}$ inch; on S , -0.0001 to -0.0005 inch.

American National Standard Form Relieved Corner Rounding Cutters with Weldon Shanks ANSI/ASME B94.19-1997

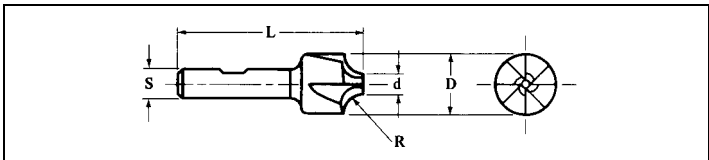

Rad., R	Dia., D	Dia., d	S	L	Rad., R	Dia., D	Dia., d	S	L
$\frac{1}{16}$	$\frac{7}{16}$	$\frac{1}{4}$	$\frac{3}{8}$	$2\frac{1}{2}$	$\frac{3}{8}$	$1\frac{1}{4}$	$\frac{3}{8}$	$\frac{1}{2}$	$3\frac{1}{2}$
$\frac{3}{32}$	$\frac{1}{2}$	$\frac{1}{4}$	$\frac{3}{8}$	$2\frac{1}{2}$	$\frac{3}{16}$	$\frac{7}{8}$	$\frac{5}{16}$	$\frac{3}{4}$	$3\frac{1}{8}$
$\frac{1}{8}$	$\frac{5}{8}$	$\frac{1}{4}$	$\frac{1}{2}$	3	$\frac{1}{4}$	1	$\frac{3}{8}$	$\frac{3}{4}$	$3\frac{1}{4}$
$\frac{5}{32}$	$\frac{3}{4}$	$\frac{5}{16}$	$\frac{1}{2}$	3	$\frac{5}{16}$	$1\frac{1}{8}$	$\frac{3}{8}$	$\frac{7}{8}$	$3\frac{1}{2}$
$\frac{3}{16}$	$\frac{7}{8}$	$\frac{3}{16}$	$\frac{1}{2}$	3	$\frac{3}{8}$	$1\frac{1}{4}$	$\frac{3}{8}$	$\frac{7}{8}$	$3\frac{3}{4}$
$\frac{1}{4}$	1	$\frac{3}{8}$	$\frac{1}{2}$	3	$\frac{7}{16}$	$1\frac{3}{8}$	$\frac{3}{8}$	1	4
$\frac{1}{16}$	$1\frac{1}{8}$	$\frac{3}{8}$	$\frac{1}{2}$	$3\frac{1}{4}$	$\frac{1}{2}$	$1\frac{1}{2}$	$\frac{3}{8}$	1	$4\frac{1}{8}$

All dimensions are in inches. All cutters are high-speed steel. Right-hand cutters are standard.

Tolerances: On D , ± 0.010 inch; on diameter of circle, $2R$, ± 0.001 inch for cutters up to and including $\frac{1}{8}$ -inch radius, +0.002, -0.001 inch for cutters over $\frac{1}{8}$ -inch radius; on S , -0.0001 to -0.0005 inch; and on L , $\pm \frac{1}{16}$ inch.

American National Standard Metal Slitting Saws ANSI/ASME B94.19-1997

Cutter Diameter			Range of Face Widths Nom. ^a	Hole Diameter		
Nom.	Max.	Min.		Nom.	Max.	Min.
Plain Metal Slitting Saws^b						
2½	2.515	2.485	½, ¾, ⅞, ⅝, ⅜	⅞	0.87575	0.8750
3	3.015	2.985	½, ¾, ⅞, ⅝, ⅜, ⅞ and ⅝	1	1.00075	1.0000
4	4.015	3.985	½, ¾, ⅞, ⅝, ⅜, ⅞ and ⅝	1	1.00075	1.0000
5	5.015	4.985	⅞, ⅝, ⅜	1	1.00075	1.0000
5	5.015	4.985	⅞	¼	1.2510	1.2500
6	6.015	5.985	⅞, ⅝, ⅜	1	1.00075	1.0000
6	6.015	5.985	⅞, ⅝	¼	1.2510	1.2500
8	8.015	7.985	⅞	1	1.00075	1.0000
8	8.015	7.985	⅞	¼	1.2510	1.2500
Metal Slitting Saws with Side Teeth^c						
2½	2.515	2.485	⅞, ⅝, ⅜	⅞	0.87575	0.8750
3	3.015	2.985	⅞, ⅝, ⅜, ⅞, ⅝	1	1.00075	1.0000
4	4.015	3.985	⅞, ⅝, ⅜, ⅞, ⅝	1	1.00075	1.0000
5	5.015	4.985	⅞, ⅝, ⅜, ⅞, ⅝	1	1.00075	1.0000
5	5.015	4.985	⅞	¼	1.2510	1.2500
6	6.015	5.985	⅞, ⅝, ⅜, ⅞	1	1.00075	1.0000
6	6.015	5.985	⅞, ⅝	¼	1.2510	1.2500
8	8.015	7.985	⅞	1	1.00075	1.0000
8	8.015	7.985	⅞, ⅝	¼	1.2510	1.2500
Metal Slitting Saws with Staggered Peripheral and Side Teeth^d						
3	3.015	2.985	⅞	1	1.00075	1.0000
4	4.015	3.985	⅞	1	1.00075	1.0000
5	5.015	4.985	⅞, ¼	1	1.00075	1.0000
6	6.015	5.985	⅞, ¼	1	1.00075	1.0000
6	6.015	5.985	⅞, ¼	¼	1.2510	1.2500
8	8.015	7.985	⅞, ¼	¼	1.2510	1.2500
10	10.015	9.985	⅞, ¼	¼	1.2510	1.2500
12	12.015	11.985	¼, ⅞	½	1.5010	1.5000

^aTolerances on face widths are plus or minus 0.001 inch.

^bPlain metal slitting saws are relatively thin plain milling cutters having peripheral teeth only. They are furnished with or without hub and their sides are concaved to the arbor hole or hub.

^cMetal slitting saws with side teeth are relatively thin side milling cutters having both peripheral and side teeth.

^dMetal slitting saws with staggered peripheral and side teeth are relatively thin staggered tooth milling cutters having peripheral teeth of alternate right- and left-hand helix and alternate side teeth.

All dimensions are in inches. All saws are high-speed steel. Metal slitting saws are similar to plain or side milling cutters but are relatively thin.

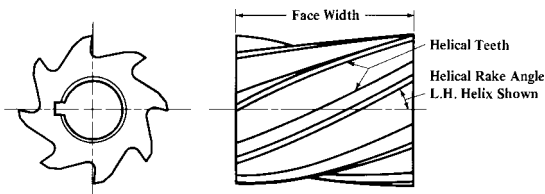
Milling Cutter Terms

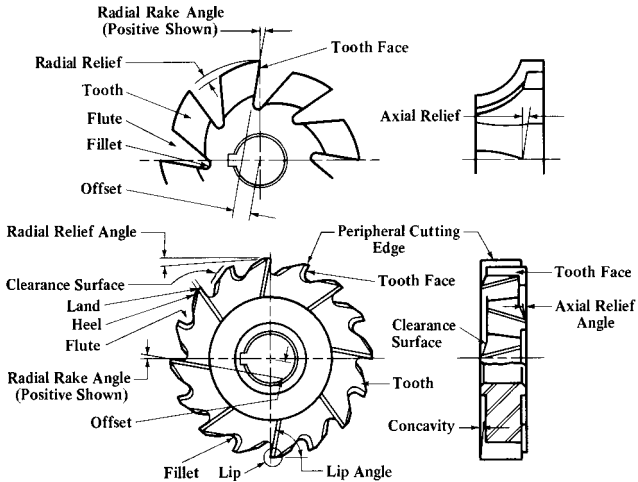

**American National Standard Single- and Double-Angle
Milling Cutters ANSI/ASME B94.19-1997**

Cutter Diameter			Nominal Face Width ^a	Hole Diameter		
Nom.	Max.	Min.		Nom.	Max.	Min.
Single-angle Cutters ^b						
$\leq 1\frac{1}{4}$	1.265	1.235	$\frac{7}{16}$	$\frac{3}{8}$ -24 UNF-2B RH $\frac{3}{8}$ -24 UNF-2B LH		
$\leq 1\frac{1}{8}$	1.640	1.610	$\frac{9}{16}$	$\frac{1}{2}$ -20 UNF-2B RH		
$2\frac{1}{4}$	2.765	2.735	$\frac{1}{2}$	1	1.00075	1.0000
3	3.015	2.985	$\frac{1}{2}$	$1\frac{1}{4}$	1.2510	1.2500
Double-angle Cutters ^d						
$2\frac{1}{4}$	2.765	2.735	$\frac{1}{2}$	1	1.00075	1.0000

^a Face width tolerances are plus or minus 0.015 inch.

^b Single-angle milling cutters have peripheral teeth, one cutting edge of which lies in a conical surface and the other in the plane perpendicular to the cutter axis. There are two types: one has a plain keywayed hole and has an included tooth angle of either 45 or 60 degrees plus or minus 10 minutes; the other has a threaded hole and has an included tooth angle of 60 degrees plus or minus 10 minutes. Cutters with a right-hand threaded hole have a right-hand hand of rotation and a right-hand hand of cutter. Cutters with a left-hand threaded hole have a left-hand hand of rotation and a left-hand hand of cutter. Cutters with plain keywayed holes are standard as either right-hand or left-hand cutters.

^c These cutters have threaded holes, the sizes of which are given under "Hole Diameter."

^d Double-angle milling cutters have symmetrical peripheral teeth both sides of which lie in conical surfaces. They are designated by the included angle, which may be 45, 60 or 90 degrees. Tolerances are plus or minus 10 minutes for the half angle on each side of the center.

All dimensions are in inches. All cutters are high-speed steel.

American National Standard Shell Mills ANSI/ASME B94.19-1997

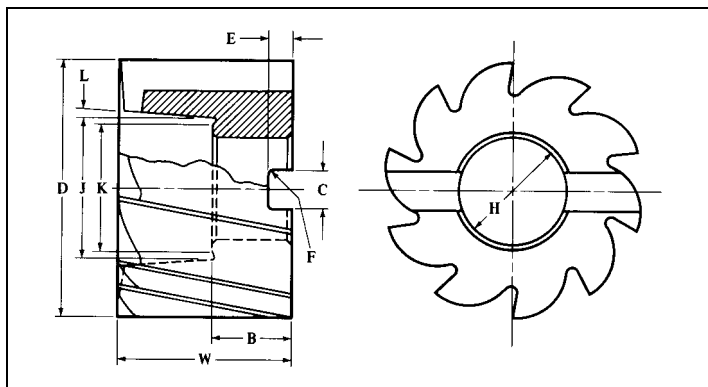

Dia., <i>D</i>	Width, <i>W</i>	Dia., <i>H</i>	Length, <i>B</i>	Width, <i>C</i>	Depth, <i>E</i>	Radius, <i>F</i>	Dia., <i>J</i>	Dia., <i>K</i>	Angle, <i>L</i>
inches	inches	inches	inches	inches	inches	inches	inches	degrees	inches
1½	1	½	¾	¼	⅜ ₃₂	⅜ ₆₄	1¼ ₁₆	⅜	0
1½	1⅜	½	¾	¼	⅜ ₃₂	⅜ ₆₄	1¼ ₁₆	⅜	0
1¾	1¼	¾	¾	⅜ ₁₆	⅜ ₁₆	⅜ ₃₂	1½ ₁₆	⅞	0
2	1⅜	¾	¾	⅜ ₁₆	⅜ ₁₆	⅜ ₃₂	1½ ₁₆	⅞	0
2¼	1½	1	¾	⅜	⅞ ₃₂	⅜ ₃₂	1¼	1⅜ ₁₆	0
2½	1⅝	1	¾	⅜	⅞ ₃₂	⅜ ₃₂	1⅜	1⅜ ₁₆	0
2¾	1⅝	1	¾	⅜	⅞ ₃₂	⅜ ₃₂	1½	1⅜ ₁₆	5
3	1¾	1¼	¾	½	⅞ ₃₂	⅜ ₃₂	1¾ ₃₂	1½	5
3½	1⅞	1¼	¾	½	⅞ ₃₂	⅜ ₃₂	1¼ ₁₆	1½	5
4	2¼	1½	1	⅝	⅞	⅜ ₁₆	2½ ₃₂	1⅞	5
4½	2¼	1½	1	⅝	⅞	⅜ ₁₆	2½ ₁₆	1⅞	10
5	2¼	1½	1	⅝	⅞	⅜ ₁₆	2⅞ ₁₆	1⅞	10
6	2¼	2	1	¾	⅞ ₁₆	⅜ ₁₆	2½ ₁₆	2½	15

All cutters are high-speed steel. Right-hand cutters with right-hand helix and square corners are standard.

Tolerances: On *D*, + $\frac{1}{64}$ inch; on *W*, $\pm\frac{1}{64}$ inch; on *H*, +0.0005 inch; on *B*, + $\frac{1}{64}$ inch; on *C*, at least +0.008 but not more than +0.012 inch; on *E*, + $\frac{1}{64}$ inch; on *J*, + $\frac{1}{64}$ inch; on *K*, $\pm\frac{1}{64}$ inch.

End Mill Terms

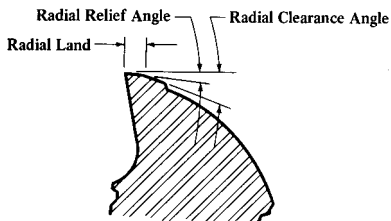

Enlarged Section of End Mill Tooth

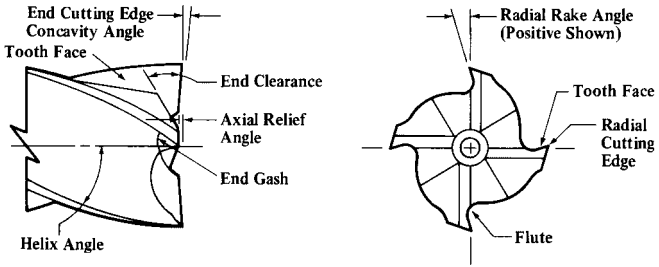

Enlarged Section of End Mill

American National Standard Multiple- and Two-Flute Single-End Helical End Mills with Plain Straight and Weldon Shanks ANSI/ASME B94.19-1997

Cutter Diameter, D			Shank Diameter, S		Length of Cut, W	Length Overall, L
Nom.	Max.	Min.	Max.	Min.		
Multiple-flute with Plain Straight Shanks						
$\frac{1}{8}$.130	.125	.125	.1245	$\frac{5}{16}$	$1\frac{1}{4}$
$\frac{3}{16}$.1925	.1875	.1875	.1870	$\frac{1}{2}$	$1\frac{3}{8}$
$\frac{1}{4}$.255	.250	.250	.2495	$\frac{3}{8}$	$1\frac{1}{16}$
$\frac{3}{8}$.380	.375	.375	.3745	$\frac{3}{4}$	$1\frac{13}{16}$
$\frac{1}{2}$.505	.500	.500	.4995	$1\frac{5}{16}$	$2\frac{1}{4}$
$\frac{3}{4}$.755	.750	.750	.7495	$1\frac{1}{4}$	$2\frac{3}{8}$
Two-flute for Keyway Cutting with Weldon Shanks						
$\frac{1}{8}$.125	.1235	.375	.3745	$\frac{3}{8}$	$2\frac{5}{16}$
$\frac{3}{16}$.1875	.1860	.375	.3745	$\frac{7}{16}$	$2\frac{3}{16}$
$\frac{1}{4}$.250	.2485	.375	.3745	$\frac{1}{2}$	$2\frac{3}{16}$
$\frac{5}{16}$.3125	.3110	.375	.3745	$\frac{9}{16}$	$2\frac{5}{16}$
$\frac{3}{8}$.375	.3735	.375	.3745	$\frac{9}{16}$	$2\frac{5}{16}$
$\frac{1}{2}$.500	.4985	.500	.4995	1	3
$\frac{5}{8}$.625	.6235	.625	.6245	$1\frac{5}{16}$	$3\frac{7}{16}$
$\frac{3}{4}$.750	.7485	.750	.7495	$1\frac{3}{16}$	$3\frac{3}{16}$
$\frac{7}{8}$.875	.8735	.875	.8745	$1\frac{1}{2}$	$3\frac{3}{4}$
1	1.000	.9985	1.000	.9995	$1\frac{5}{8}$	$4\frac{1}{8}$
$1\frac{1}{4}$	1.250	1.2485	1.250	1.2495	$1\frac{3}{8}$	$4\frac{1}{8}$
$1\frac{1}{2}$	1.500	1.4985	1.250	1.2495	$1\frac{3}{8}$	$4\frac{1}{8}$

All dimensions are in inches. All cutters are high-speed steel. Right-hand cutters with right-hand helix are standard.

The helix angle is not less than 10 degrees for multiple-flute cutters with plain straight shanks; the helix angle is optional with the manufacturer for two-flute cutters with Weldon shanks.

Tolerances: On W , $\pm\frac{1}{32}$ inch; on L , $\pm\frac{1}{16}$ inch.

ANSI Regular-, Long-, and Extra Long-Length, Multiple-Flute Medium Helix Single-End End Mills with Weldon Shanks ANSI/ASME B94.19-1997

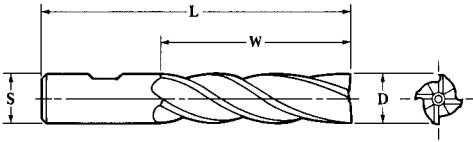

As Indicated By The Dimensions Given Below, Shank Diameter S May Be Larger, Smaller, Or The Same As The Cutter Diameter D

Cutter Dia., D	Regular Mills				Long Mills				Extra Long Mills			
	S	W	L	N ^a	S	W	L	N ^a	S	W	L	N ^a
1/8 ^b	3/8	3/8	2 5/16	4
3/16 ^b	3/8	1/2	2 3/8	4
1/4 ^b	3/8	5/8	2 7/16	4	3/8	1 1/4	3 1/16	4	3/8	1 3/4	3 5/16	4
5/16 ^b	3/8	3/4	2 1/2	4	3/8	1 3/8	3 3/8	4	3/8	2	3 3/4	4
3/8 ^b	3/8	3/4	2 1/2	4	3/8	1 1/2	3 1/4	4	3/8	2 1/2	4 1/4	4
7/16	3/8	1	2 11/16	4	1/2	1 3/4	3 3/4	4
1/2	3/8	1	2 11/16	4	1/2	2	4	4	1/2	3	5	4
1/2 ^b	1/2	1 1/4	3 1/4	4
9/16	1/2	1 3/8	3 3/8	4
5/8	1/2	1 3/8	3 3/8	4	5/8	2 1/2	4 3/8	4	5/8	4	6 5/8	4
11/16	1/2	1 5/8	3 5/8	4
3/4	1/2	1 5/8	3 5/8	4	3/4	3	5 1/4	4	3/4	4	6 1/4	4
5/8 ^b	5/8	1 5/8	3 3/4	4
11/16	5/8	1 5/8	3 3/4	4
3/4 ^b	5/8	1 5/8	3 3/4	4
13/16	5/8	1 7/8	4	6
7/8	5/8	1 7/8	4	6	7/8	3 1/2	5 3/4	4	7/8	5	7 1/4	4
1	5/8	1 7/8	4	6	1	4	6 1/2	4	1	6	8 1/2	4
7/8	7/8	1 7/8	4 1/8	4
1	7/8	1 7/8	4 1/8	4
1 1/8	7/8	2	4 1/4	6	1	4	6 1/2	6
1 1/4	7/8	2	4 1/4	6	1	4	6 1/2	6	1 1/4	6	8 1/2	6
1	1	2	4 1/2	4
1 1/8	1	2	4 1/2	6
1 1/4	1	2	4 1/2	6
1 3/8	1	2	4 1/2	6
1 1/2	1	2	4 1/2	6	1	4	6 1/2	6
1 1/4	1 1/4	2	4 1/2	6	1 1/4	4	6 1/2	6
1 1/2	1 1/4	2	4 1/2	6	1 1/4	4	6 1/2	6	1 1/4	8	10 1/2	6
1 3/4	1 1/4	2	4 1/2	6	1 1/4	4	6 1/2	6
2	1 1/4	2	4 1/2	8	1 1/4	4	6 1/2	8

^aN = Number of flutes.

^bIn this size of regular mill a left-hand cutter with left-hand helix is also standard.

All dimensions are in inches. All cutters are high-speed steel. Helix angle is greater than 19 degrees but not more than 39 degrees. Right-hand cutters with right-hand helix are standard.

Tolerances: On D, +0.003 inch; on S, -0.0001 to -0.0005 inch; on W, ±1/32 inch; on L, ±1/16 inch.

ANSI Two-Flute, High Helix, Regular-, Long-, and Extra Long-Length, Single-End End Mills with Weldon Shanks ANSI/ASME B94.19-1997

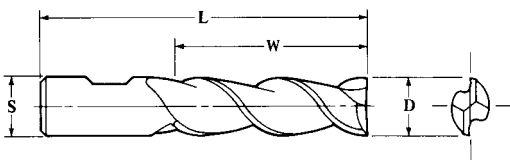

Cutter Dia., <i>D</i>	Regular Mill			Long Mill			Extra Long Mill		
	<i>S</i>	<i>W</i>	<i>L</i>	<i>S</i>	<i>W</i>	<i>L</i>	<i>S</i>	<i>W</i>	<i>L</i>
1/4	3/8	5/8	2 1/16	3/8	1 1/4	3 1/16	3/8	1 3/4	3 3/16
5/16	3/8	3/4	2 1/2	3/8	1 3/8	3 1/8	3/8	2	3 3/4
3/8	3/8	3/4	2 1/2	3/8	1 1/2	3 1/4	3/8	2 1/2	4 1/4
7/16	3/8	1	2 11/16	1/2	1 3/4	3 3/4
1/2	1/2	1 1/4	3 1/4	1/2	2	4	1/2	3	5
5/8	5/8	1 3/8	3 3/4	5/8	2 1/2	4 3/8	5/8	4	6 1/8
3/4	3/4	1 3/8	3 3/8	3/4	3	5 1/4	3/4	4	6 1/4
7/8	7/8	1 7/8	4 1/8
1	1	2	4 1/2	1	4	6 1/2	1	6	8 1/2
1 1/4	1 1/4	2	4 1/2	1 1/4	4	6 1/2	1 1/4	6	8 1/2
1 1/2	1 1/4	2	4 1/2	1 1/4	4	6 1/2	1 1/4	8	10 1/2
2	1 1/4	2	4 1/2	1 1/4	4	6 1/2

All dimensions are in inches. All cutters are high-speed steel. Right-hand cutters with right-hand helix are standard. Helix angle is greater than 39 degrees.

Tolerances: On *D*, +0.003 inch; on *S*, -0.0001 to -0.0005 inch; on *W*, $\pm 1/32$ inch; and on *L*, $\pm 1/16$ inch.

Combination Shanks for End Mills ANSI/ASME B94.19-1997

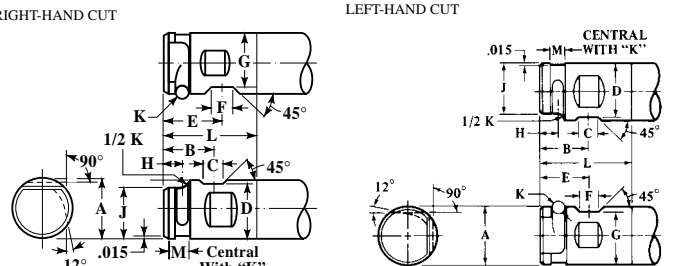

Di., <i>A</i>	<i>L</i> ^a	<i>B</i>	<i>C</i>	<i>D</i>	<i>E</i>	<i>F</i>	<i>G</i>	<i>H</i>	<i>J</i>	<i>K</i>	<i>M</i>
1 1/2	2 11/16	1 3/16	.515	1.406	1 1/2	.515	1.371	9/16	1.302	.377	7/16
2	3 1/4	1 23/32	.700	1.900	1 3/4	.700	1.809	5/8	1.772	.440	1/2
2 1/2	3 1/2	1 5/16	.700	2.400	2	.700	2.312	3/4	2.245	.503	9/16

^a Length of shank.

All dimensions are in inches.

Modified for use as Weldon or Pin Drive shank.

ANSI Roughing, Single-End End Mills with Weldon Shanks, High-Speed Steel
ANSI/ASME B94.19-1997

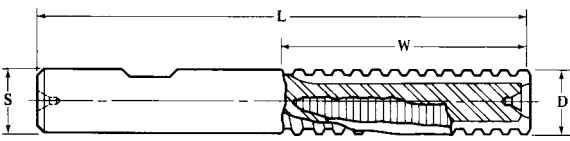

Diameter		Length		Diameter		Length	
Cutter	Shank	Cut	Overall	Cutter	Shank	Cut	Overall
D	S	W	L	D	S	W	L
1/2	1/2	1	3	2	2	2	5 3/4
1/2	1/2	1 1/4	3 1/4	2	2	3	6 3/4
1/2	1/2	2	4	2	2	4	7 3/4
3/8	3/8	1 1/4	3 3/8	2	2	5	8 3/4
3/8	3/8	1 3/8	3 1/4	2	2	6	9 3/4
3/8	3/8	2 1/2	4 5/8	2	2	7	10 3/4
3/4	3/4	1 1/2	3 3/4	2	2	8	11 3/4
3/4	3/4	1 3/8	3 7/8	2	2	10	13 3/4
3/4	3/4	3	5 1/4	2	2	12	15 3/4
1	1	2	4 1/2	2 1/2	2	4	7 3/4
1	1	4	6 1/2	2 1/2	2	6	9 3/4
1 1/4	1 1/4	2	4 1/2	2 1/2	2	8	11 3/4
1 1/4	1 1/4	4	6 1/2	2 1/2	2	10	13 3/4
1 1/2	1 1/2	2	4 1/2	3	2 1/2	4	7 3/4
1 1/2	1 1/2	4	6 1/2	3	2 1/2	6	9 3/4
1 3/4	1 1/2	2	4 1/2	3	2 1/2	8	11 3/4
1 3/4	1 1/2	4	6 1/2	3	2 1/2	10	13 3/4

All dimensions are in inches. Right-hand cutters with right-hand helix are standard.

Tolerances: Outside diameter, +0.025, -0.005 inch; length of cut, +1/8, -1/32 inch.

American National Standard Heavy Duty, Medium Helix Single-End End Mills,
2 1/2-inch Combination Shank, High-Speed Steel ANSI/ASME B94.19-1997

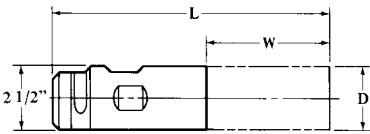

Dia. of Cutter, D	No. of Flutes	Length of Cut, W	Length Overall, L	Dia. of Cutter, D	No. of Flutes	Length of Cut, W	Length Overall, L
2 1/2	3	8	12	3	3	4	7 3/4
2 1/2	3	10	14	3	3	6	9 3/4
2 1/2	6	4	8	3	3	8	11 3/4
2 1/2	6	6	10	3	8	4	7 3/4
2 1/2	6	8	12	3	8	6	9 3/4
2 1/2	6	10	14	3	8	8	11 3/4
2 1/2	6	12	16	3	8	10	13 3/4
3	2	4	7 3/4	3	8	12	15 3/4
3	2	6	9 3/4

All dimensions are in inches. For shank dimensions see page 781. Right-hand cutters with right-hand helix are standard. Helix angle is greater than 19 degrees but not more than 39 degrees.

Tolerances: On D, +0.005 inch; on W, ±1/32 inch; on L, ±1/16 inch.

ANSI Stub-, Regular-, and Long-Length, Four-Flute, Medium Helix, Plain-End, Double-End Miniature End Mills with $\frac{3}{16}$ -Inch Diameter Straight Shanks
ANSI/ASME B94.19-1997

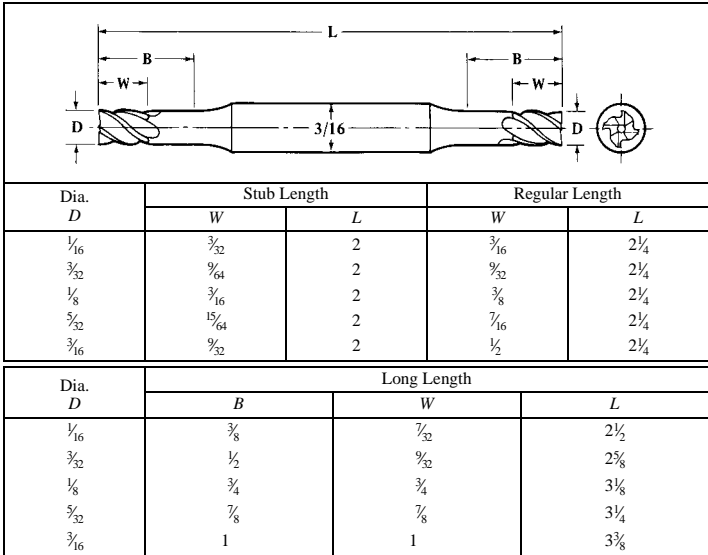

All dimensions are in inches. All cutters are high-speed steel. Right-hand cutters with right-hand helix are standard. Helix angle is greater than 19 degrees but not more than 39 degrees.

Tolerances: On D , +0.003 inch (if the shank is the same diameter as the cutting portion, however, then the tolerance on the cutting diameter is -0.0025 inch.); on W , + $\frac{1}{32}$, - $\frac{1}{64}$ inch; and on L , $\pm\frac{1}{16}$ inch.

American National Standard 60-Degree Single-Angle Milling Cutters with Weldon Shanks ANSI/ASME B94.19-1997

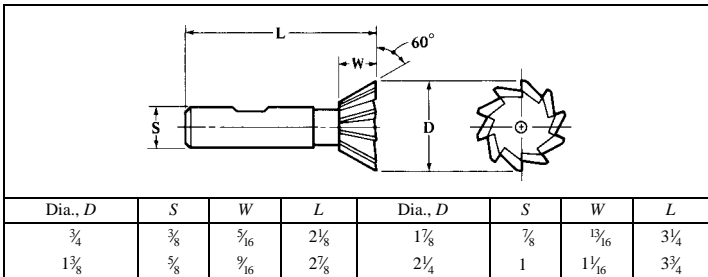

All dimensions are in inches. All cutters are high-speed steel. Right-hand cutters are standard.

Tolerances: On D , ± 0.015 inch; on S , -0.0001 to -0.0005 inch; on W , ± 0.015 inch; and on L , $\pm\frac{1}{16}$ inch.

American National Standard Stub-, Regular-, and Long-Length, Two-Flute, Medium Helix, Plain- and Ball-End, Double-End Miniature End Mills with $\frac{3}{16}$ -Inch Diameter Straight Shanks ANSI/ASME B94.19-1997

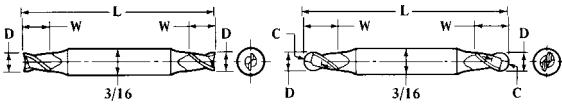

Dia., C and D	Stub Length				Regular Length			
	Plain End		Ball End		Plain End		Ball End	
	W	L	W	L	W	L	W	L
$\frac{1}{32}$	$\frac{3}{64}$	2	$\frac{3}{32}$	$2\frac{1}{4}$
$\frac{3}{64}$	$\frac{1}{16}$	2	$\frac{1}{8}$	$2\frac{1}{4}$
$\frac{1}{16}$	$\frac{3}{32}$	2	$\frac{3}{32}$	2	$\frac{3}{16}$	$2\frac{1}{4}$	$\frac{3}{16}$	$2\frac{1}{4}$
$\frac{3}{64}$	$\frac{1}{8}$	2	$\frac{15}{64}$	$2\frac{1}{4}$
$\frac{1}{32}$	$\frac{3}{64}$	2	$\frac{3}{64}$	2	$\frac{9}{32}$	$2\frac{1}{4}$	$\frac{9}{32}$	$2\frac{1}{4}$
$\frac{7}{64}$	$\frac{7}{32}$	2	$2\frac{1}{64}$	$2\frac{1}{4}$
$\frac{1}{8}$	$\frac{3}{16}$	2	$\frac{3}{16}$	2	$\frac{1}{8}$	$2\frac{1}{4}$	$\frac{3}{8}$	$2\frac{1}{4}$
$\frac{3}{64}$	$\frac{7}{32}$	2	$\frac{13}{32}$	$2\frac{1}{4}$
$\frac{1}{16}$	$\frac{15}{64}$	2	$\frac{15}{64}$	2	$\frac{7}{16}$	$2\frac{1}{4}$	$\frac{7}{16}$	$2\frac{1}{4}$
$\frac{11}{64}$	$\frac{1}{4}$	2	$\frac{1}{2}$	$2\frac{1}{4}$
$\frac{3}{16}$	$\frac{7}{32}$	2	$\frac{7}{32}$	2	$\frac{1}{2}$	$2\frac{1}{4}$	$\frac{1}{2}$	$2\frac{1}{4}$

Dia., D	Long Length		
	Plain End		
	B ^a	W	L
$\frac{1}{16}$	$\frac{3}{8}$	$\frac{7}{32}$	$2\frac{1}{2}$
$\frac{3}{32}$	$\frac{1}{2}$	$\frac{9}{32}$	$2\frac{3}{8}$
$\frac{1}{8}$	$\frac{3}{4}$	$\frac{3}{4}$	$3\frac{1}{8}$
$\frac{3}{16}$	$\frac{7}{8}$	$\frac{7}{8}$	$3\frac{1}{4}$
$\frac{1}{4}$	1	1	$3\frac{3}{8}$

^aB is the length below the shank.

All dimensions are in inches. All cutters are high-speed steel. Right-hand cutters with right-hand helix are standard. Helix angle is greater than 19 degrees but not more than 39 degrees.

Tolerances: On C and D, -0.0015 inch for stub and regular length; +0.003 inch for long length (if the shank is the same diameter as the cutting portion, however, then the tolerance on the cutting diameter is -0.0025 inch.); on W, + $\frac{1}{32}$, - $\frac{1}{64}$ inch; and on L, $\pm \frac{1}{16}$ inch.

American National Standard Multiple Flute, Helical Series End Mills with Brown & Sharpe Taper Shanks

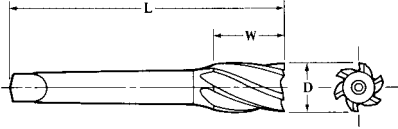

Dia., D	W	L	Taper No.	Dia., D	W	L	Taper No.
...	1	$1\frac{1}{8}$	$5\frac{3}{8}$	7
...	$1\frac{1}{2}$	2	$7\frac{1}{4}$	9
$\frac{1}{2}$	$\frac{15}{16}$	$4\frac{15}{16}$	7	$1\frac{1}{2}$	$2\frac{1}{4}$	$7\frac{1}{2}$	9
$\frac{3}{4}$	$1\frac{1}{4}$	$5\frac{1}{4}$	7	2	$2\frac{3}{4}$	8	9

All dimensions are in inches. All cutters are high-speed steel. Right-hand cutters with right-hand helix are standard. Helix angle is not less than 10 degrees.

No. 5 taper is standard without tang; Nos. 7 and 9 are standard with tang only.

Tolerances: On D, +0.005 inch; on W, $\pm \frac{1}{32}$ inch; and on L $\pm \frac{1}{16}$ inch.

For dimensions of B & S taper shanks, see information given on page 916.

American National Standard Stub- and Regular-Length, Two-Flute, Medium Helix, Plain- and Ball-End, Single-End End Mills with Weldon Shanks

ANSI/ASME B94.19-1997

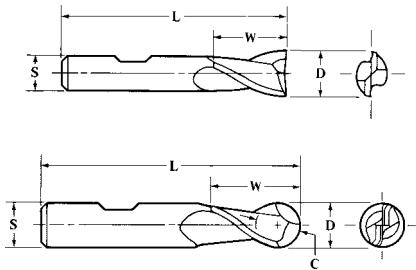

Regular Length — Plain End				Stub Length — Plain End			
Dia., D	S	W	L	Cutter Dia., D	Shank Dia., S	Length of Cut. W	Length Overall. L
1/8	3/8	3/8	2 3/16	1/8	3/8	3/16	2 1/8
3/16	3/8	7/16	2 7/16	3/16	3/8	7/32	2 3/16
1/4	3/8	1/2	2 1/2	1/4	3/8	3/8	2 1/4
5/16	3/8	9/16	2 5/16	Regular Length — Ball End			
3/8	3/8	7/16	2 1/2				
7/16	3/8	1 1/16	2 1/2	Dia., C and D	Shank Dia., S	Length of Cut. W	Length Overall. L
1/2	3/8	1 1/16	2 1/2	1/8	3/8	3/8	2 3/16
1/2	1/2	1	3	3/16	3/8	3/8	2 3/16
9/16	1/2	1 1/8	3 3/8	1/4	3/8	3/8	2 7/16
5/8	1/2	1 1/4	3 3/8	3/16	3/8	3/4	2 1/2
11/16	1/2	1 3/16	3 3/16	3/8	3/8	3/4	2 1/2
3/4	1/2	1 5/16	3 5/16	7/16	1/2	1	3
5/8	3/8	1 3/16	3 7/16	1/2	1/2	1	3
11/16	3/8	1 3/16	3 7/16	9/16	1/2	1 1/8	3 3/8
3/4	3/8	1 3/16	3 7/16	5/8	1/2	1 1/8	3 3/8
13/16	3/8	1 1/2	3 3/8	3/8	3/8	1 3/8	3 1/2
1	3/8	1 1/2	3 3/8	3/4	1/2	1 3/8	3 5/8
1	3/8	1 1/2	3 3/8	3/4	3/4	1 3/8	3 3/8
1 1/8	7/8	1 1/2	3 3/4	7/8	7/8	2	4 1/4
1 1/4	7/8	1 3/8	3 3/8	1	1	2 1/4	4 3/4
1	1	1 3/8	3 3/8	1 1/8	1	2 1/4	4 3/4
1 1/8	1	1 3/8	4 1/8	1 1/4	1 1/4	2 1/2	5
1 1/4	1	1 3/8	4 1/8	1 1/2	1 1/4	2 1/2	5
1 3/8	1	1 3/8	4 1/8				
1 1/2	1	1 3/8	4 1/8				
1 1/4	1 1/4	1 3/8	4 1/8				
1 1/2	1 1/4	1 3/8	4 1/8				
1 3/4	1 1/4	1 3/8	4 1/8				
2	1 1/4	1 3/8	4 1/8				

All dimensions are in inches. All cutters are high-speed steel. Right-hand cutters with right-hand helix are standard. Helix angle is greater than 19 degrees but not more than 39 degrees.

Tolerances: On C and D, -0.0015 inch for stub-length mills, + 0.003 inch for regular-length mills; on S, -0.0001 to -0.0005 inch; on W, $\pm 1/32$ inch; and on L, $\pm 1/16$ inch.

The following single-end end mills are available in premium high speed steel: ball end, two flute, with D ranging from 1/8 to 1 1/2 inches; ball end, multiple flute, with D ranging from 1/8 to 1 inch; and plain end, two flute, with D ranging from 1/8 to 1 1/2 inches.

American National Standard Long-Length Single-End and Stub-, and Regular Length, Double-End, Plain- and Ball-End, Medium Helix, Two-Flute End Mills with Weldon Shanks ANSI/ASME B94.19-1997

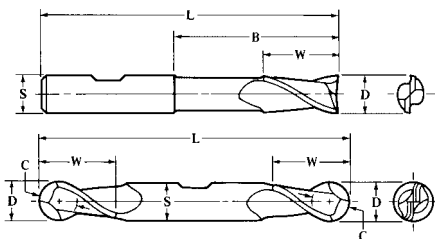

Single End

Dia., C and D	Long Length — Plain End				Long Length — Ball End			
	S	B ^a	W	L	S	B ^a	W	L
1/8	3/8	13/16	3/8	2 3/8
3/16	3/8	1 1/2	1/2	2 11/16
1/4	3/8	1 1/2	3/8	3 3/16	3/8	1 1/2	3/8	3 1/16
5/16	3/8	1 3/4	3/4	3 7/16	3/8	1 3/4	3/4	3 7/16
3/8	3/8	1 3/4	3/4	3 3/16	3/8	1 3/4	3/4	3 3/16
7/16	1/2	1 7/8	1	3 11/16
1/2	1/2	2 7/32	1	4	1/2	2 1/4	1	4
5/8	5/8	2 23/32	1 3/8	4 5/8	5/8	2 3/4	1 3/8	4 5/8
3/4	3/4	3 11/32	1 5/8	5 3/8	3/4	3 3/8	1 5/8	5 3/8
1	1	4 31/32	2 1/2	7 1/4	1	5	2 1/2	7 1/4
1 1/4	1 1/4	4 31/2	3	7 1/4

^a B is the length below the shank.

Dia., C and D	Stub Length — Plain End			Regular Length — Plain End			Regular Length — Ball End		
	S	W	L	S	W	L	S	W	L
1/8	3/8	3/16	2 3/4	3/8	3/8	3 1/16	3/8	3/8	3 3/16
3/32	3/8	15/64	2 3/4	3/8	7/16	3 3/8
3/16	3/8	9/32	2 3/4	3/8	7/16	3 3/8	3/8	7/16	3 3/8
7/32	3/8	21/64	2 7/8	3/8	1/2	3 3/8
1/4	3/8	3/8	2 7/8	3/8	1/2	3 3/8	3/8	1/2	3 3/8
5/32	3/8	9/16	3 3/8
5/16	3/8	9/16	3 3/8	3/8	9/16	3 3/8
11/32	3/8	9/16	3 3/8
3/8	3/8	9/16	3 3/8	3/8	9/16	3 3/8
13/32	1/2	13/16	3 3/4
7/16	1/2	13/16	3 3/4	1/2	13/16	3 3/4
15/32	1/2	13/16	3 3/4
1/2	1/2	13/16	3 3/4	1/2	13/16	3 3/4
9/16	5/8	1 1/8	4 1/2
5/8	5/8	1 1/8	4 1/2	3/8	1 1/8	4 1/2
11/16	3/4	1 5/16	5
3/4	3/4	1 5/16	5	3/4	1 5/16	5
7/8	3/8	1 1/16	5 1/2
1	1	1 1/8	5 7/8	1	1 1/8	5 7/8

All dimensions are in inches. All cutters are high-speed steel. Right-hand cutters with right-hand helix are standard. Helix angle is greater than 19 degrees but not more than 39 degrees.

Tolerances: On C and D, +0.003 inch for single-end mills, -0.0015 inch for double-end mills; on S, -0.0001 to -0.0005 inch; on W, $\pm 1/32$ inch; and on L, $\pm 1/16$ inch.

**American National Standard Regular-, Long-, and Extra Long-Length,
Three- and Four-Flute, Medium Helix, Center Cutting, Single-End
End Mills with Weldon Shanks ANSI/ASME B94.19-1997**

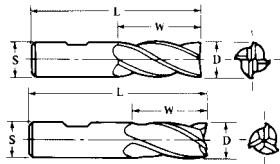

Four Flute

Dia., <i>D</i>	Regular Length			Long Length			Extra Long Length		
	<i>S</i>	<i>W</i>	<i>L</i>	<i>S</i>	<i>W</i>	<i>L</i>	<i>S</i>	<i>W</i>	<i>L</i>
1/8	3/8	3/8	2 5/16
3/16	3/8	1/2	2 3/8
1/4	3/8	5/8	2 7/16	3/8	1 1/4	3 3/16	3/8	1 3/4	3 3/16
5/16	3/8	3/4	2 1/2	3/8	1 3/8	3 3/8	3/8	2	3 3/4
3/8	3/8	3/4	2 1/2	3/8	1 1/2	3 3/4	3/8	2 1/2	4 1/4
1/2	3/8	1 1/2	3 3/4	1/2	2	4	1/2	3	5
5/8	3/8	1 3/8	3 3/4	5/8	2 1/2	4 5/8	5/8	4	6 5/8
1 1/16	3/8	1 3/8	3 3/4
3/4	3/4	1 3/8	3 3/4	3/4	3	5 1/4	3/4	4	6 1/4
7/8	3/8	1 3/8	4 1/8	7/8	3 1/2	5 3/4	7/8	5	7 1/4
1	1	2	4 1/2	1	4	6 1/2	1	6	8 1/2
1 1/8	1	2	4 1/2
1 1/4	1 1/4	2	4 1/2	1 1/4	4	6 1/2	1 1/4	6	8 1/2
1 1/2	1 1/4	2	4 1/2

Three Flute

Dia., <i>D</i>	<i>S</i>	<i>W</i>	<i>L</i>	Dia., <i>D</i>			
				Regular Length		Regular Length (cont.)	
1/8	3/8	3/8	2 5/16	1 1/8	1	2	4 1/2
3/16	3/8	5/8	2 3/8	1 1/2	1	2	4 1/2
1/4	3/8	7/8	2 7/16	1 1/2	1	2	4 1/2
5/16	3/8	3/4	2 1/2	1 1/4	1 1/4	2	4 1/2
3/8	3/8	3/4	2 1/2	1 1/2	1 1/4	2	4 1/2
7/16	3/8	1	2 11/16	1 3/4	1 1/4	2	4 1/2
1/2	3/8	1	2 11/16	2	1 1/4	2	4 1/2
5/8	3/8	1 1/4	3 1/4	Long Length			
3/4	3/8	1 3/8	3 3/8				
7/8	3/8	1 3/8	3 3/8	1/4	3/8	1 1/4	3 11/16
1	3/8	1 3/8	3 3/8	5/16	3/8	1 3/8	3 3/8
1 1/8	3/8	1 3/8	3 3/8	3/8	3/8	1 1/2	3 3/4
1 1/4	3/8	1 3/8	3 3/4	7/16	1/2	1 3/4	3 3/4
1 1/2	3/8	1 3/8	3 3/4	1/2	1/2	2	4
1 3/4	3/8	1 3/8	4	5/8	5/8	2 1/2	4 3/8
2	3/8	1 3/8	4	3/4	3/4	3	5 1/4
2 1/8	3/4	1 3/8	3 3/8	1	1	4	6 1/2
2 1/4	3/4	1 3/8	4 3/8	1 1/4	1 1/4	4	6 1/2
2 1/2	3/4	1 3/8	4 3/8	1 1/2	1 1/4	4	6 1/2
2 3/4	3/8	1 3/8	4 3/8	1 3/4	1 1/4	4	6 1/2
3	1	2	4 1/2	2	1 1/4	4	6 1/2

All dimensions are in inches. All cutters are high-speed steel. Right-hand cutters with right-hand helix are standard. Helix angle is greater than 19 degrees but not more than 39 degrees.

Tolerances: On *D*, +0.003 inch; on *S*, -0.0001 to -0.0005 inch; on *W*, $\pm 1/32$ inch; and on *L*, $\pm 1/16$ inch.

The following center-cutting, single-end end mills are available in premium high speed steel: regular length, multiple flute, with *D* ranging from 1/8 to 1 1/2 inches; long length, multiple flute, with *D* ranging from 3/8 to 1 1/4 inches; and extra long-length, multiple flute, with *D* ranging from 3/8 to 1 1/4 inches.

American National Standard Stub- and Regular-length, Four-flute, Medium Helix, Double-end End Mills with Weldon Shanks ANSI/ASME B94.19-1997

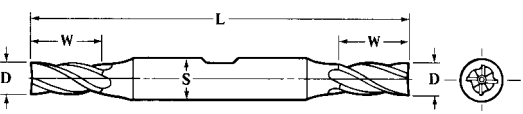

Dia., D	S	W	L	Dia., D	S	W	L	Dia., D	S	W	L
Stub Length											
1/8	3/8	3/16	2 3/4	3/16	3/8	9/32	2 3/4	1/4	3/8	3/8	2 7/8
5/32	3/8	15/64	2 3/4	7/32	3/8	21/64	2 7/8
Regular Length											
1/8 ^a	3/8	3/8	3 1/16	11/32	3/8	3/4	3 1/2	5/8 ^a	3/8	1 3/8	5
5/32 ^a	3/8	7/16	3 1/8	3/8 ^a	3/8	3/4	3 1/2	11/16	3/4	1 1/8	5 5/8
3/16 ^a	3/8	1/2	3 1/4	13/32	1/2	1	4 1/8	3/4 ^a	3/4	1 3/8	5 5/8
7/32	3/8	9/16	3 1/4	7/16	1/2	1	4 1/8	13/16	7/8	1 7/8	6 1/8
1/4 ^a	3/8	5/8	3 3/8	15/32	1/2	1	4 1/8	7/8	7/8	1 7/8	6 1/8
9/32	3/8	11/16	3 3/8	1/2 ^a	1/2	1	4 1/8	1	1	1 7/8	6 3/8
5/16 ^a	3/8	3/4	3 1/2	9/16	3/8	1 3/8	5

^a In this size of regular mill a left-hand cutter with a left-hand helix is also standard.

All dimensions are in inches. All cutters are high-speed steel. Right-hand cutters with right-hand helix are standard. Helix angle is greater than 19 degrees but not more than 39 degrees.

Tolerances: On D, +0.003 inch (if the diameter is the same diameter as the cutting portion, however, then the tolerance on the cutting diameter is -0.0025 inch); on S, -0.0001 to -0.0005 inch; on W, ±1/32 inch; and on L, ±1/16 inch.

American National Standard Stub- and Regular-Length, Four-Flute, Medium Helix, Double-End End Mills with Weldon Shanks ANSI/ASME B94.19-1997

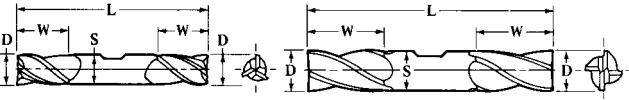

Dia., D	S	W	L	Dia., D	S	W	L
Three Flute				Four Flute			
1/8	3/8	3/8	3 1/16	1/8	3/8	3/8	3 1/16
3/16	3/8	1/2	3 1/4	3/16	3/8	1/2	3 1/4
1/4	3/8	3/8	3 3/8	1/4	3/8	3/8	3 3/8
5/16	3/8	3/4	3 1/2	5/16	3/8	3/4	3 1/2
3/8	3/8	3/4	3 1/2	3/8	3/8	3/4	3 1/2
7/16	1/2	1	4 1/8	1/2	1/2	1	4 1/8
1/2	1/2	1	4 1/8	3/8	3/8	1 3/8	5
9/16	3/8	1 3/8	5	1/4	3/4	1 3/8	5 5/8
5/8	3/8	1 3/8	5	7/8	7/8	1 7/8	6 1/8
3/4	3/4	1 3/8	5 5/8	1	1	1 7/8	6 3/8
1	1	1 7/8	6 3/8

All dimensions are in inches. All cutters are high-speed steel. Right-hand cutters with right-hand helix are standard. Helix angle is greater than 19 degrees but not more than 39 degrees.

Tolerances: On D, +0.0015 inch; on S, -0.0001 to -0.0005 inch; on W, ±1/32 inch; and on L, ±1/16 inch.

American National Standard Plain- and Ball-End, Heavy Duty, Medium Helix, Single-End End Mills with 2-Inch Diameter Shanks ANSI/ASME B94.19-1997

Dia., C and D	Plain End			Ball End		
	W	L	No. of Flutes	W	L	No. of Flutes
2	2	5 $\frac{3}{4}$	2, 4, 6
2	3	6 $\frac{3}{4}$	2, 3
2	4	7 $\frac{3}{4}$	2, 3, 4, 6	4	7 $\frac{3}{4}$	6
2	5	8 $\frac{3}{4}$	2, 4
2	6	9 $\frac{3}{4}$	2, 3, 4, 6	6	9 $\frac{3}{4}$	6
2	8	11 $\frac{3}{4}$	6	8	11 $\frac{3}{4}$	6
2 $\frac{1}{2}$	4	7 $\frac{3}{4}$	2, 3, 4, 6
2 $\frac{1}{2}$	5	8 $\frac{3}{4}$	4
2 $\frac{1}{2}$	6	9 $\frac{3}{4}$	2, 4, 6
2 $\frac{1}{2}$	8	11 $\frac{3}{4}$	6

All dimensions are in inches. All cutters are high-speed steel. Right-hand cutters with right-hand helix are standard. Helix angle is greater than 19 degrees but not more than 39 degrees.

Tolerances: On C and D, +0.005 inch for 2, 3, 4 and 6 flutes; on W, $\pm \frac{1}{16}$ inch; and on L, $\pm \frac{1}{16}$ inch.

**Dimensions of American National Standard Weldon Shanks
ANSI/ASME B94.19-1997**

Shank		Flat		Shank		Flat	
Dia.	Length	X ^a	Length ^b	Dia.	Length	X ^a	Length ^b
$\frac{3}{8}$	1 $\frac{1}{16}$	0.325	0.280	1	2 $\frac{7}{32}$	0.925	0.515
$\frac{1}{2}$	1 $\frac{7}{32}$	0.440	0.330	1 $\frac{1}{2}$	2 $\frac{7}{32}$	1.156	0.515
$\frac{5}{8}$	1 $\frac{9}{32}$	0.560	0.400	1 $\frac{1}{2}$	2 $\frac{11}{16}$	1.406	0.515
$\frac{3}{4}$	2 $\frac{1}{32}$	0.675	0.455	2	3 $\frac{1}{4}$	1.900	0.700
$\frac{7}{8}$	2 $\frac{1}{32}$	0.810	0.455	2 $\frac{1}{2}$	3 $\frac{1}{2}$	2.400	0.700

^a X is distance from bottom of flat to opposite side of shank.

^b Minimum.

All dimensions are in inches.

Centerline of flat is at half-length of shank except for 1 $\frac{1}{2}$ -, 2- and 2 $\frac{1}{2}$ -inch shanks where it is 1 $\frac{3}{16}$ -, 1 $\frac{27}{32}$ and 1 $\frac{15}{16}$ from shank end, respectively.

Tolerance on shank diameter, -0.0001 to -0.0005 inch.

**American National Standard Form Relieved, Concave, Convex, and
Corner-Rounding Arbor-Type Cutters ANSI/ASME B94.19-1997**

Diameter C or Radius R			Cutter Dia. D ^a	Width W ± .010 ^b	Diameter of Hole H		
Nom.	Max.	Min.			Nom.	Max.	Min.
Concave Cutters^c							
$\frac{1}{8}$	0.1270	0.1240	$2\frac{1}{4}$	$\frac{1}{4}$	1	1.00075	1.00000
$\frac{3}{16}$	0.1895	0.1865	$2\frac{1}{4}$	$\frac{3}{8}$	1	1.00075	1.00000
$\frac{1}{4}$	0.2520	0.2490	$2\frac{1}{2}$	$\frac{7}{16}$	1	1.00075	1.00000
$\frac{5}{16}$	0.3145	0.3115	$2\frac{3}{4}$	$\frac{9}{16}$	1	1.00075	1.00000
$\frac{3}{8}$	0.3770	0.3740	$2\frac{3}{4}$	$\frac{5}{8}$	1	1.00075	1.00000
$\frac{7}{16}$	0.4395	0.4365	3	$\frac{3}{4}$	1	1.00075	1.00000
$\frac{1}{2}$	0.5040	0.4980	3	$1\frac{1}{16}$	1	1.00075	1.00000
$\frac{5}{8}$	0.6290	0.6230	$3\frac{1}{2}$	1	$1\frac{1}{4}$	1.251	1.250
$\frac{3}{4}$	0.7540	0.7480	$3\frac{1}{2}$	$1\frac{3}{16}$	$1\frac{1}{4}$	1.251	1.250
$\frac{7}{8}$	0.8790	0.8730	4	$1\frac{3}{8}$	$1\frac{1}{4}$	1.251	1.250
1	1.0040	0.9980	$4\frac{1}{4}$	$1\frac{9}{16}$	$1\frac{1}{4}$	1.251	1.250
Convex Cutters^c							
$\frac{1}{8}$	0.1270	0.1230	$2\frac{1}{4}$	$\frac{1}{8}$	1	1.00075	1.00000
$\frac{3}{16}$	0.1895	0.1855	$2\frac{1}{4}$	$\frac{3}{16}$	1	1.00075	1.00000
$\frac{1}{4}$	0.2520	0.2480	$2\frac{1}{2}$	$\frac{1}{4}$	1	1.00075	1.00000
$\frac{5}{16}$	0.3145	0.3105	$2\frac{3}{4}$	$\frac{5}{16}$	1	1.00075	1.00000
$\frac{3}{8}$	0.3770	0.3730	$2\frac{3}{4}$	$\frac{3}{8}$	1	1.00075	1.00000
$\frac{7}{16}$	0.4395	0.4355	3	$\frac{7}{16}$	1	1.00075	1.00000
$\frac{1}{2}$	0.5020	0.4980	3	$\frac{1}{2}$	1	1.00075	1.00000
$\frac{5}{8}$	0.6270	0.6230	$3\frac{1}{2}$	$\frac{5}{8}$	$1\frac{1}{4}$	1.251	1.250
$\frac{3}{4}$	0.7520	0.7480	$3\frac{3}{4}$	$\frac{3}{4}$	$1\frac{1}{4}$	1.251	1.250
$\frac{7}{8}$	0.8770	0.8730	4	$\frac{7}{8}$	$1\frac{1}{4}$	1.251	1.250
1	1.0020	0.9980	$4\frac{1}{4}$	1	$1\frac{1}{4}$	1.251	1.250
Corner-rounding Cutters^d							
$\frac{1}{8}$	0.1260	0.1240	$2\frac{1}{2}$	$\frac{1}{4}$	1	1.00075	1.00000
$\frac{1}{4}$	0.2520	0.2490	3	$1\frac{1}{32}$	1	1.00075	1.00000
$\frac{3}{8}$	0.3770	0.3740	$3\frac{1}{4}$	$\frac{9}{16}$	$1\frac{1}{4}$	1.251	1.250
$\frac{1}{2}$	0.5020	0.4990	$4\frac{1}{4}$	$\frac{3}{4}$	$1\frac{1}{4}$	1.251	1.250
$\frac{5}{8}$	0.6270	0.6240	$4\frac{1}{4}$	$1\frac{1}{16}$	$1\frac{1}{4}$	1.251	1.250

^a Tolerances on cutter diameter are $+\frac{1}{16}, -\frac{1}{16}$ inch for all sizes.

^b Tolerance does not apply to convex cutters.

^c Size of cutter is designated by specifying diameter C of circular form.

^d Size of cutter is designated by specifying radius R of circular form.

All dimensions in inches. All cutters are high-speed steel and are form relieved.

Right-hand corner rounding cutters are standard, but left-hand cutter for $\frac{1}{4}$ -inch size is also standard.

For key and keyway dimensions for these cutters, see page 794.

American National Standard Roughing and Finishing Gear Milling Cutters for Gears with 14½-Degree Pressure Angles ANSI/ASME B94.19-1997

ROUGHING			FINISHING					
Diametral Pitch	Dia. of Cutter, <i>D</i>	Dia. of Hole, <i>H</i>	Diametral Pitch	Dia. of Cutter, <i>D</i>	Dia. of Hole, <i>H</i>	Diametral Pitch	Dia. of Cutter, <i>D</i>	Dia. of Hole, <i>H</i>
Roughing Gear Milling Cutters								
1	8½	2	3	5¼	1½	5	3⅝	1
1¼	7¾	2	3	4¾	1¼	6	3⅝	1½
1½	7	1¾	4	4¾	1¾	6	3½	1¼
1¾	6½	1¾	4	4½	1½	6	3⅝	1
2	6½	1¾	4	4¼	1¼	7	3⅝	1¼
2	5¾	1½	4	3⅝	1	7	2⅞	1
2½	6¼	1¾	5	4⅝	1¾	8	3¼	1¼
2½	5¾	1½	5	4¼	1½	8	2⅞	1
3	5⅝	1¾	5	3¾	1¼
Finishing Gear Milling Cutters								
1	8½	2	6	3⅝	1½	14	2⅞	⅞
1¼	7¾	2	6	3½	1¼	16	2½	1
1½	7	1¾	6	3⅝	1	16	2⅞	⅞
1¾	6½	1¾	7	3⅝	1½	18	2⅞	1
2	6½	1¾	7	3⅝	1¼	18	2	⅞
2	5¾	1½	7	2⅞	1	20	2⅞	1
2½	6¼	1¾	8	3½	1½	20	2	⅞
2½	5¾	1½	8	3¼	1¼	22	2¼	1
3	5⅝	1¾	8	2⅞	1	22	2	⅞
3	5¼	1½	9	3⅝	1¼	24	2¼	1
3	4¾	1¼	9	2¾	1	24	1¾	⅞
4	4¾	1¾	10	3	1¼	26	1¾	⅞
4	4½	1½	10	2¾	1	28	1¾	⅞
4	4¼	1¼	10	2⅞	⅞	30	1¾	⅞
4	3⅝	1	11	2⅞	1	32	1¾	⅞
5	4⅝	1¾	11	2⅞	⅞	36	1¾	⅞
5	4¼	1½	12	2⅞	1¼	40	1¾	⅞
5	3¾	1¼	12	2⅞	1	48	1¾	⅞
5	3⅝	1	12	2¼	⅞
6	4¼	1¾	14	2½	1

All dimensions are in inches.

All gear milling cutters are high-speed steel and are form relieved.

For keyway dimensions see page 794.

Tolerances: On outside diameter, + $\frac{1}{16}$, - $\frac{1}{16}$ inch; on hole diameter, through 1-inch hole diameter, +0.00075 inch, over 1-inch and through 2-inch hole diameter, +0.0010 inch.

For cutter number relative to numbers of gear teeth, see page 2021. Roughing cutters are made with No. 1 cutter form only.

**American National Standard Gear Milling Cutters for Mitre and Bevel
Gears with $14\frac{1}{2}$ -Degree Pressure Angles ANSI/ASME B94.19-1997**

Diametral Pitch	Diameter of Cutter, D	Diameter of Hole, H	Diametral Pitch	Diameter of Cutter, D	Diameter of Hole, H
3	4	$1\frac{1}{4}$	10	$2\frac{3}{8}$	$\frac{7}{8}$
4	$3\frac{3}{8}$	$1\frac{1}{4}$	12	$2\frac{1}{2}$	$\frac{7}{8}$
5	$3\frac{3}{8}$	$1\frac{1}{4}$	14	$2\frac{3}{8}$	$\frac{7}{8}$
6	$3\frac{1}{2}$	1	16	$2\frac{1}{2}$	$\frac{7}{8}$
7	$2\frac{7}{8}$	1	20	2	$\frac{7}{8}$
8	$2\frac{7}{8}$	1	24	$1\frac{3}{4}$	$\frac{7}{8}$

All dimensions are in inches.

All cutters are high-speed steel and are form relieved.

For keyway dimensions see page 794. For cutter selection see page 2060.

Tolerances: On outside diameter, $+\frac{1}{16}$, $-\frac{1}{16}$ inch; on hole diameter, through 1-inch hole diameter, $+0.00075$ inch, for $1\frac{1}{4}$ -inch hole diameter, $+0.0010$ inch.

To select the cutter number for bevel gears with the axis at any angle, double the back cone radius and multiply the result by the diametral pitch. This procedure gives the number of equivalent spur gear teeth and is the basis for selecting the cutter number from the table on page 2023.

**American National Standard Roller Chain Sprocket
Milling Cutters ANSI/ASME B94.19-1997**

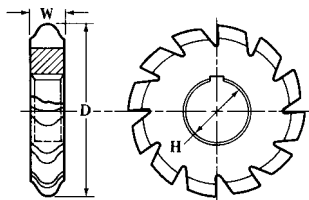

Chain Pitch	Dia. of Roll	No. of Teeth in Sprocket	Dia. of Cutter, D	Width of Cutter, W	Dia. of Hole, M
$\frac{1}{4}$	0.130	6	$2\frac{1}{4}$	$\frac{3}{16}$	1
$\frac{1}{4}$	0.130	7-8	$2\frac{1}{4}$	$\frac{3}{16}$	1
$\frac{1}{4}$	0.130	9-11	$2\frac{1}{4}$	$\frac{3}{16}$	1
$\frac{1}{4}$	0.130	12-17	$2\frac{1}{4}$	$\frac{5}{16}$	1
$\frac{1}{4}$	0.130	18-34	$2\frac{1}{4}$	$\frac{9}{32}$	1
$\frac{1}{4}$	0.130	35 and over	$2\frac{1}{4}$	$\frac{9}{32}$	1
$\frac{3}{8}$	0.200	6	$2\frac{1}{4}$	$\frac{15}{32}$	1
$\frac{3}{8}$	0.200	7-8	$2\frac{1}{4}$	$\frac{15}{32}$	1
$\frac{3}{8}$	0.200	9-11	$2\frac{1}{4}$	$\frac{15}{32}$	1
$\frac{3}{8}$	0.200	12-17	$2\frac{1}{4}$	$\frac{7}{16}$	1
$\frac{3}{8}$	0.200	18-34	$2\frac{1}{4}$	$\frac{7}{16}$	1
$\frac{3}{8}$	0.200	35 and over	$2\frac{1}{4}$	$\frac{13}{32}$	1
$\frac{1}{2}$	0.313	6	3	$\frac{3}{4}$	1
$\frac{1}{2}$	0.313	7-8	3	$\frac{3}{4}$	1
$\frac{1}{2}$	0.313	9-11	$3\frac{1}{8}$	$\frac{3}{4}$	1
$\frac{1}{2}$	0.313	12-17	$3\frac{1}{8}$	$\frac{3}{4}$	1
$\frac{1}{2}$	0.313	18-34	$3\frac{1}{8}$	$\frac{21}{32}$	1
$\frac{1}{2}$	0.313	35 and over	$3\frac{1}{8}$	$\frac{11}{16}$	1
$\frac{5}{8}$	0.400	6	$3\frac{1}{8}$	$\frac{3}{4}$	1
$\frac{5}{8}$	0.400	7-8	$3\frac{1}{8}$	$\frac{3}{4}$	1
$\frac{5}{8}$	0.400	9-11	$3\frac{1}{4}$	$\frac{3}{4}$	1
$\frac{5}{8}$	0.400	12-17	$3\frac{1}{4}$	$\frac{3}{4}$	1

**American National Standard Roller Chain Sprocket
Milling Cutters ANSI/ASME B94.19-1997**

Chordal Pitch	Dia. of Roll	No. of Teeth in Sprocket	Dia. of Cutter, <i>D</i>	Width of Cutter, <i>D</i>	Dia. of Hole, <i>H</i>
$\frac{5}{8}$	0.400	18-34	$3\frac{1}{4}$	$2\frac{3}{32}$	1
$\frac{5}{8}$	0.400	35 and over	$3\frac{1}{4}$	$1\frac{1}{16}$	1
$\frac{3}{4}$	0.469	6	$3\frac{1}{4}$	$2\frac{9}{32}$	1
$\frac{3}{4}$	0.469	7-8	$3\frac{1}{4}$	$2\frac{9}{32}$	1
$\frac{3}{4}$	0.469	9-11	$3\frac{3}{8}$	$2\frac{9}{32}$	1
$\frac{3}{4}$	0.469	12-17	$3\frac{3}{8}$	$\frac{7}{8}$	1
$\frac{3}{4}$	0.469	18-34	$3\frac{3}{8}$	$2\frac{9}{32}$	1
$\frac{3}{4}$	0.469	35 and over	$3\frac{3}{8}$	$1\frac{7}{16}$	1
1	0.625	6	$1\frac{1}{2}$	$1\frac{1}{2}$	$1\frac{1}{4}$
1	0.625	7-8	4	$1\frac{1}{2}$	$1\frac{1}{4}$
1	0.625	9-11	$4\frac{1}{8}$	$1\frac{1}{32}$	$1\frac{1}{4}$
1	0.625	18-34	$4\frac{1}{4}$	$1\frac{13}{32}$	$1\frac{1}{4}$
1	0.625	35 and over	$4\frac{1}{4}$	$1\frac{11}{32}$	$1\frac{1}{4}$
$1\frac{1}{4}$	0.750	6	$4\frac{1}{4}$	$1\frac{1}{16}$	$1\frac{1}{4}$
$1\frac{1}{4}$	0.750	7-8	$4\frac{3}{8}$	$1\frac{13}{16}$	$1\frac{1}{4}$
$1\frac{1}{4}$	0.750	9-11	$4\frac{1}{2}$	$1\frac{29}{32}$	$1\frac{1}{4}$
$1\frac{1}{4}$	0.750	18-34	$4\frac{3}{8}$	$1\frac{1}{16}$	$1\frac{1}{4}$
$1\frac{1}{4}$	0.750	35 and over	$4\frac{3}{8}$	$1\frac{3}{8}$	$1\frac{1}{4}$
$1\frac{1}{2}$	0.875	6	$4\frac{3}{8}$	$1\frac{13}{16}$	$1\frac{1}{4}$
$1\frac{1}{2}$	0.875	7-8	$4\frac{1}{2}$	$1\frac{13}{16}$	$1\frac{1}{4}$
$1\frac{1}{2}$	0.875	9-11	$4\frac{3}{8}$	$1\frac{29}{32}$	$1\frac{1}{4}$
$1\frac{1}{2}$	0.875	12-17	$4\frac{3}{8}$	$1\frac{3}{4}$	$1\frac{1}{4}$
$1\frac{1}{2}$	0.875	18-34	$4\frac{3}{4}$	$1\frac{11}{16}$	$1\frac{1}{4}$
$1\frac{1}{2}$	0.875	35 and over	$4\frac{3}{4}$	$1\frac{5}{8}$	$1\frac{1}{4}$
$1\frac{3}{4}$	1.000	6	5	$2\frac{29}{32}$	$1\frac{1}{2}$
$1\frac{3}{4}$	1.000	7-8	$5\frac{1}{8}$	$2\frac{31}{32}$	$1\frac{1}{2}$
$1\frac{3}{4}$	1.000	9-11	$5\frac{1}{4}$	$2\frac{1}{16}$	$1\frac{1}{2}$
$1\frac{3}{4}$	1.000	12-17	$5\frac{3}{8}$	$2\frac{1}{32}$	$1\frac{1}{2}$
$1\frac{3}{4}$	1.000	18-34	$5\frac{1}{2}$	$1\frac{31}{32}$	$1\frac{1}{2}$
$1\frac{3}{4}$	1.000	35 and over	$5\frac{1}{2}$	$1\frac{7}{8}$	$1\frac{1}{2}$
2	1.125	6	$5\frac{3}{8}$	$2\frac{1}{32}$	$1\frac{1}{2}$
2	1.125	7-8	$5\frac{1}{2}$	$2\frac{13}{32}$	$1\frac{1}{2}$
2	1.125	9-11	$5\frac{3}{8}$	$2\frac{3}{8}$	$1\frac{1}{2}$
2	1.125	12-17	$5\frac{1}{4}$	$2\frac{5}{16}$	$1\frac{1}{2}$
2	1.125	18-34	$5\frac{3}{8}$	$2\frac{1}{4}$	$1\frac{1}{2}$
2	1.125	35 and over	$5\frac{3}{8}$	$2\frac{29}{32}$	$1\frac{1}{2}$
$2\frac{1}{4}$	1.406	6	$5\frac{7}{8}$	$2\frac{1}{16}$	$1\frac{1}{2}$
$2\frac{1}{4}$	1.406	7-8	6	$2\frac{1}{16}$	$1\frac{1}{2}$
$2\frac{1}{4}$	1.406	9-11	$6\frac{1}{4}$	$2\frac{21}{32}$	$1\frac{1}{2}$
$2\frac{1}{4}$	1.406	12-17	$6\frac{3}{8}$	$2\frac{9}{32}$	$1\frac{1}{2}$
$2\frac{1}{4}$	1.406	18-34	$6\frac{1}{2}$	$2\frac{1}{32}$	$1\frac{1}{2}$
$2\frac{1}{4}$	1.406	35 and over	$6\frac{1}{2}$	$2\frac{1}{32}$	$1\frac{1}{2}$
$2\frac{1}{2}$	1.563	6	$6\frac{3}{8}$	3	$1\frac{3}{4}$
$2\frac{1}{2}$	1.563	7-8	$6\frac{5}{8}$	3	$1\frac{3}{4}$
$2\frac{1}{2}$	1.563	9-11	$6\frac{1}{4}$	$2\frac{15}{16}$	$1\frac{3}{4}$
$2\frac{1}{2}$	1.563	12-17	$6\frac{3}{4}$	$2\frac{29}{32}$	$1\frac{3}{4}$
$2\frac{1}{2}$	1.563	18-34	7	$2\frac{3}{4}$	$1\frac{3}{4}$
$2\frac{1}{2}$	1.563	35 and over	$7\frac{1}{8}$	$2\frac{1}{16}$	$1\frac{3}{4}$
3	1.875	6	$7\frac{1}{2}$	$3\frac{9}{32}$	2
3	1.875	7-8	$7\frac{1}{4}$	$3\frac{9}{32}$	2
3	1.875	9-11	$7\frac{3}{8}$	$3\frac{1}{32}$	2
3	1.875	12-17	8	$3\frac{1}{32}$	2
3	1.875	18-34	8	$3\frac{11}{32}$	2
3	1.875	35 and over	$8\frac{1}{4}$	$3\frac{1}{32}$	2

All dimensions are in inches.

All cutters are high-speed steel and are form relieved.

For keyway dimensions see page 794.

Tolerances: Outside diameter, $+1/16$, $-1/16$ inch; hole diameter, through 1-inch diameter, $+0.00075$ inch, above 1-inch diameter and through 2-inch diameter, $+0.0010$ inch.

For tooth form, see ANSI sprocket tooth form table on page 2438.

American National Standard Keys and Keyways for Milling Cutters and Arbors *ANSI/ASME B94.19-1997*

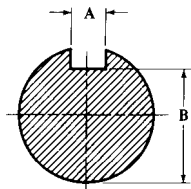

ARBOR AND KEYSEAT

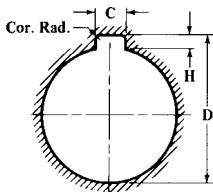

CUTTER HOLE AND KEYWAY

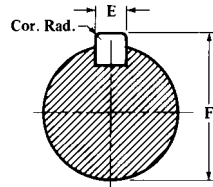

ARBOR AND KEY

Nom. Arbor and Cutter Hole Dia.	Nom. Size Key (Square)	Arbor and Keyseat				Hole and Keyway					Arbor and Key			
		A Max.	A Min.	B Max.	B Min.	C Max.	C Min.	D ^a Min.	H Nom.	Corner Radius	E Max.	E Min.	F Max.	F Min.
1/2	3/32	0.0947	0.0937	0.4531	0.4481	0.106	0.099	0.5578	3/64	0.020	0.0932	0.0927	0.5468	0.5408
3/8	1/8	0.1260	0.1250	0.5625	0.5575	0.137	0.130	0.6985	1/16	3/32	0.1245	0.1240	0.6875	0.6815
3/4	1/8	0.1260	0.1250	0.6875	0.6825	0.137	0.130	0.8225	1/16	1/32	0.1245	0.1240	0.8125	0.8065
7/8	1/8	0.1260	0.1250	0.8125	0.8075	0.137	0.130	0.9475	1/16	1/32	0.1245	0.1240	0.9375	0.9315
1	1/4	0.2510	0.2500	0.8438	0.8388	0.262	0.255	1.1040	3/32	3/64	0.2495	0.2490	1.0940	1.0880
1 1/4	5/16	0.3135	0.3125	1.0630	1.0580	0.343	0.318	1.3850	1/8	1/16	0.3120	0.3115	1.3750	1.3690
1 1/2	3/8	0.3760	0.3750	1.2810	1.2760	0.410	0.385	1.6660	3/32	1/16	0.3745	0.3740	1.6560	1.6500
1 3/4	7/16	0.4385	0.4375	1.5000	1.4950	0.473	0.448	1.9480	3/16	1/16	0.4370	0.4365	1.9380	1.9320
2	1/2	0.5010	0.5000	1.6870	1.6820	0.535	0.510	2.1980	3/16	1/16	0.4995	0.4990	2.1880	2.1820
2 1/2	3/8	0.6260	0.6250	2.0940	2.0890	0.660	0.635	2.7330	7/32	1/16	0.6245	0.6240	2.7180	2.7120
3	3/4	0.7510	0.7500	2.5000	2.4950	0.785	0.760	3.2650	1/4	3/32	0.7495	0.7490	3.2500	3.2440
3 1/2	7/8	0.8760	0.8750	3.0000	2.9950	0.910	0.885	3.8900	3/8	3/32	0.8745	0.8740	3.8750	3.8690
4	1	1.0010	1.0000	3.3750	3.3700	1.035	1.010	4.3900	3/8	3/32	0.9995	0.9990	4.3750	4.3690
4 1/2	1 1/8	1.1260	1.1250	3.8130	3.8080	1.160	1.135	4.9530	7/16	1/8	1.1245	1.1240	4.9380	4.9320
5	1 1/4	1.2510	1.2500	4.2500	4.2450	1.285	1.260	5.5150	1/2	1/8	1.2495	1.2490	5.5000	5.4940

^a D max. is 0.010 inch larger than D min.

All dimensions given in inches.

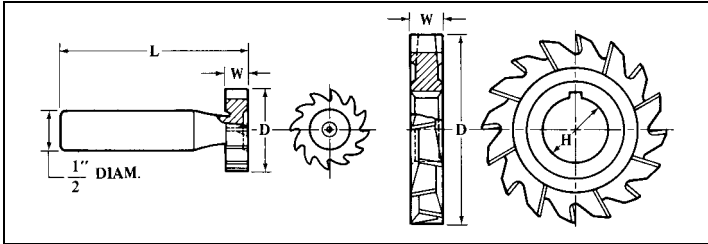
American National Standard Woodruff Keyseat Cutters—Shank-Type Straight-Teeth and Arbor-Type Staggered-Teeth ANSI/ASME B94.19-1997

Shank-type Cutters

Cutter Number	Nom. Dia. of Cutter, D	Width of Face, W	Length Overall, L	Cutter Number	Nom. Dia. of Cutter, D	Width of Face, W	Length Overall, L	Cutter Number	Nom. Dia. of Cutter, D	Width of Face, W	Length Overall, L
202	$\frac{1}{4}$	$\frac{1}{16}$	$2\frac{1}{16}$	506	$\frac{3}{4}$	$\frac{3}{32}$	$2\frac{3}{32}$	809	$1\frac{1}{8}$	$\frac{1}{4}$	$2\frac{1}{4}$
202 $\frac{1}{2}$	$\frac{3}{16}$	$\frac{1}{16}$	$2\frac{1}{16}$	606	$\frac{3}{4}$	$\frac{3}{16}$	$2\frac{3}{16}$	1009	$1\frac{1}{8}$	$\frac{5}{16}$	$2\frac{5}{16}$
302 $\frac{1}{2}$	$\frac{3}{16}$	$\frac{3}{32}$	$2\frac{3}{32}$	806	$\frac{3}{4}$	$\frac{1}{4}$	$2\frac{1}{4}$	610	$1\frac{1}{4}$	$\frac{3}{16}$	$2\frac{3}{16}$
203	$\frac{3}{8}$	$\frac{1}{16}$	$2\frac{1}{16}$	507	$\frac{7}{8}$	$\frac{3}{32}$	$2\frac{3}{32}$	710	$1\frac{1}{4}$	$\frac{7}{32}$	$2\frac{7}{32}$
303	$\frac{3}{8}$	$\frac{3}{32}$	$2\frac{3}{32}$	607	$\frac{7}{8}$	$\frac{3}{16}$	$2\frac{3}{16}$	810	$1\frac{1}{4}$	$\frac{1}{4}$	$2\frac{1}{4}$
403	$\frac{3}{8}$	$\frac{1}{8}$	$2\frac{1}{8}$	707	$\frac{7}{8}$	$\frac{7}{32}$	$2\frac{7}{32}$	1010	$1\frac{1}{4}$	$\frac{3}{16}$	$2\frac{3}{16}$
204	$\frac{1}{2}$	$\frac{1}{16}$	$2\frac{1}{16}$	807	$\frac{7}{8}$	$\frac{1}{4}$	$2\frac{1}{4}$	1210	$1\frac{1}{4}$	$\frac{3}{8}$	$2\frac{3}{8}$
304	$\frac{1}{2}$	$\frac{3}{32}$	$2\frac{3}{32}$	608	1	$\frac{3}{16}$	$2\frac{3}{16}$	811	$1\frac{3}{8}$	$\frac{1}{4}$	$2\frac{1}{4}$
404	$\frac{1}{2}$	$\frac{1}{8}$	$2\frac{1}{8}$	708	1	$\frac{7}{32}$	$2\frac{7}{32}$	1011	$1\frac{3}{8}$	$\frac{5}{16}$	$2\frac{5}{16}$
305	$\frac{5}{8}$	$\frac{3}{32}$	$2\frac{3}{32}$	808	1	$\frac{1}{4}$	$2\frac{1}{4}$	1211	$1\frac{3}{8}$	$\frac{3}{8}$	$2\frac{3}{8}$
405	$\frac{5}{8}$	$\frac{1}{8}$	$2\frac{1}{8}$	1008	1	$\frac{5}{16}$	$2\frac{5}{16}$	812	$1\frac{1}{2}$	$\frac{1}{4}$	$2\frac{1}{4}$
505	$\frac{5}{8}$	$\frac{3}{32}$	$2\frac{3}{32}$	1208	1	$\frac{3}{8}$	$2\frac{3}{8}$	1012	$1\frac{1}{2}$	$\frac{3}{16}$	$2\frac{3}{16}$
605	$\frac{5}{8}$	$\frac{3}{16}$	$2\frac{3}{16}$	609	$1\frac{1}{8}$	$\frac{3}{16}$	$2\frac{3}{16}$	1212	$1\frac{1}{2}$	$\frac{3}{8}$	$2\frac{3}{8}$
406	$\frac{3}{4}$	$\frac{1}{8}$	$2\frac{1}{8}$	709	$1\frac{1}{8}$	$\frac{7}{32}$	$2\frac{7}{32}$

Arbor-type Cutters

Cutter Number	Nom. Dia. of Cutter, D	Width of Face, W	Dia. of Hole, H	Cutter Number	Nom. Dia. of Cutter, D	Width of Face, W	Dia. of Hole, H	Cutter Number	Nom. Dia. of Cutter, D	Width of Face, W	Dia. of Hole, H
617	$2\frac{1}{8}$	$\frac{3}{16}$	$\frac{3}{4}$	1022	$2\frac{3}{4}$	$\frac{3}{16}$	1	1628	$3\frac{1}{2}$	$\frac{1}{2}$	1
817	$2\frac{1}{8}$	$\frac{1}{4}$	$\frac{3}{4}$	1222	$2\frac{3}{4}$	$\frac{3}{8}$	1	1828	$3\frac{1}{2}$	$\frac{9}{16}$	1
1017	$2\frac{1}{8}$	$\frac{5}{16}$	$\frac{3}{4}$	1422	$2\frac{3}{4}$	$\frac{7}{16}$	1	2028	$3\frac{1}{2}$	$\frac{3}{8}$	1
1217	$2\frac{1}{8}$	$\frac{3}{8}$	$\frac{3}{4}$	1622	$2\frac{3}{4}$	$\frac{1}{2}$	1	2428	$3\frac{1}{2}$	$\frac{3}{4}$	1
822	$2\frac{3}{4}$	$\frac{1}{4}$	1	1228	$3\frac{1}{2}$	$\frac{3}{8}$	1

All dimensions are given in inches. All cutters are high-speed steel.

Shank type cutters are standard with right-hand cut and straight teeth. All sizes have $\frac{1}{2}$ -inch diameter straight shank.

Arbor type cutters have staggered teeth.

For Woodruff key and key-slot dimensions, see pages 2348 through 2350.

Tolerances: Face with W for shank type cutters: $\frac{1}{16}$ - to $\frac{5}{32}$ -inch face, +0.0000, -0.0005; $\frac{3}{16}$ to $\frac{7}{32}$, -0.0002, -0.0007; $\frac{1}{4}$, -0.0003, -0.0008; $\frac{5}{16}$, -0.0004, -0.0009; $\frac{3}{8}$, -0.0005, -0.0010 inch. Face width W for arbor type cutters; $\frac{3}{16}$ inch face, -0.0002, -0.0007; $\frac{1}{4}$, -0.0003, -0.0008; $\frac{5}{16}$, -0.0004, -0.0009; $\frac{3}{8}$ and over, -0.0005, -0.0010 inch. Hole size H : +0.00075, -0.0000 inch. Diameter D for shank type cutters: $\frac{1}{4}$ - through $\frac{3}{4}$ -inch diameter, +0.010, +0.015, $\frac{7}{8}$ through $1\frac{1}{8}$, +0.012, +0.017; $1\frac{1}{4}$ through $1\frac{1}{2}$, +0.015, +0.020 inch. These tolerances include an allowance for sharpening. For arbor type cutters diameter D is furnished $\frac{1}{32}$ inch larger than listed and a tolerance of ± 0.002 inch applies to the oversize diameter.

Setting Angles for Milling Straight Teeth of Uniform Land Width in End Mills, Angular Cutters, and Taper Reamers.—The accompanying tables give setting angles for the dividing head when straight teeth, having a land of uniform width throughout their length, are to be milled using single-angle fluting cutters. These setting angles depend upon three factors: the number of teeth to be cut; the angle of the blank in which the teeth are to be cut; and the angle of the fluting cutter. Setting angles for various combinations of these three factors are given in the tables. For example, assume that 12 teeth are to be cut on the end of an end mill using a 60-degree cutter. By following the horizontal line from 12 teeth, read in the column under 60 degrees that the dividing head should be set to an angle of 70 degrees and 32 minutes.

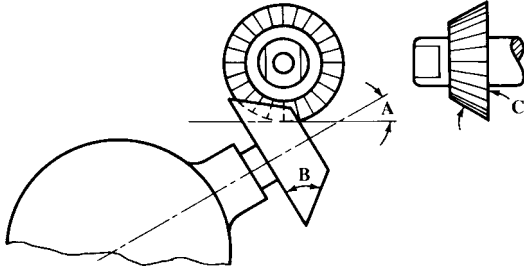

The following formulas, which were used to compile these tables, may be used to calculate the setting-angles for combinations of number of teeth, blank angle, and cutter angle not covered by the tables. In these formulas, A = setting-angle for dividing head, B = angle of blank in which teeth are to be cut, C = angle of fluting cutter, N = number of teeth to be cut, and D and E are angles not shown on the accompanying diagram and which are used only to simplify calculations.

$$\tan D = \cos(360^\circ/N) \times \cot B \quad (1)$$

$$\sin E = \tan(360^\circ/N) \times \cot C \times \sin D \quad (2)$$

$$\text{Setting-angle } A = D - E \quad (3)$$

Example: Suppose 9 teeth are to be cut in a 35-degree blank using a 55-degree single-angle fluting cutter. Then, $N = 9$, $B = 35^\circ$, and $C = 55^\circ$.

$$\tan D = \cos(360^\circ/9) \times \cot 35^\circ = 0.76604 \times 1.4281 = 1.0940; \text{ and } D = 47^\circ 34'$$

$$\sin E = \tan(360^\circ/9) \times \cot 55^\circ \times \sin 47^\circ 34' = 0.83910 \times 0.70021 \times 0.73806 \\ = 0.43365; \text{ and } E = 25^\circ 42'$$

$$\text{Setting angle } A = 47^\circ 34' - 25^\circ 42' = 21^\circ 52'$$

For end mills and side mills the angle of the blank B is 0 degrees and the following simplified formula may be used to find the setting angle A

$$\cos A = \tan(360^\circ/N) \times \cot C \quad (4)$$

Example: If in the previous example the blank angle was 0 degrees,

$$\cos A = \tan(360^\circ/9) \times \cot 55^\circ$$

$$= 0.83910 \times 0.70021 = 0.58755; \text{ and setting-angle } A = 54^\circ 1'$$

Angles of Elevation for Milling Straight Teeth in 0-, 5-, 10-, 15-, 20-, 25-, 30-, and 35-degree Blanks Using Single-Angle Fluting Cutters

No. of Teeth	Angle of Fluting Cutter									
	90°	80°	70°	60°	50°	90°	80°	70°	60°	50°
	0° Blank (End Mill)					5° Blank				
6	...	72° 13'	50° 55'	80° 4'	62° 34'	41° 41'
8	...	79 51	68 39	54° 44'	32° 57'	82 57	72 52	61 47	48° 0'	25° 40'
10	...	82 38	74 40	65 12	52 26	83 50	76 31	68 35	59 11	46 4
12	...	84 9	77 52	70 32	61 2	84 14	78 25	72 10	64 52	55 5
14	...	85 8	79 54	73 51	66 10	84 27	79 36	74 24	68 23	60 28
16	...	85 49	81 20	76 10	69 40	84 35	80 25	75 57	70 49	64 7
18	...	86 19	82 23	77 52	72 13	84 41	81 1	77 6	72 36	66 47
20	...	86 43	83 13	79 11	74 11	84 45	81 29	77 59	73 59	68 50
22	...	87 2	83 52	80 14	75 44	84 47	81 50	78 40	75 4	70 26
24	...	87 18	84 24	81 6	77 0	84 49	82 7	79 15	75 57	71 44
	10° Blank					15° Blank				
6	70° 34'	53° 50'	34° 5'	61° 49'	46° 12'	28° 4'
8	76 0	66 9	55 19	41° 56'	20° 39'	69 15	59 46	49 21	36° 34'	17° 34'
10	77 42	70 31	62 44	53 30	40 42	71 40	64 41	57 8	48 12	36 18
12	78 30	72 46	66 37	59 26	49 50	72 48	67 13	61 13	54 14	45 13
14	78 56	74 9	69 2	63 6	55 19	73 26	68 46	63 46	57 59	50 38
16	79 12	75 5	70 41	65 37	59 1	73 50	69 49	65 30	60 33	54 20
18	79 22	75 45	71 53	67 27	61 43	74 5	70 33	66 46	62 26	57 0
20	79 30	76 16	72 44	68 52	63 47	74 16	71 6	67 44	63 52	59 3
22	79 35	76 40	73 33	69 59	65 25	74 24	71 32	68 29	65 0	60 40
24	79 39	76 59	74 9	70 54	66 44	74 30	71 53	69 6	65 56	61 59
	20° Blank					25° Blank				
6	53° 57'	39° 39'	23° 18'	47° 0'	34° 6'	19° 33'
8	62 46	53 45	43 53	31° 53'	14° 31'	56 36	48 8	38 55	27° 47'	11° 33'
10	65 47	59 4	51 50	43 18	32 1	60 2	53 40	46 47	38 43	27 47
12	67 12	61 49	56 2	49 18	40 40	61 42	56 33	51 2	44 38	36 10
14	68 0	63 29	58 39	53 4	46 0	62 38	58 19	53 41	48 20	41 22
16	68 30	64 36	60 26	55 39	49 38	63 13	59 29	55 29	50 53	44 57
18	68 50	65 24	61 44	57 32	52 17	63 37	60 19	56 48	52 46	47 34
20	69 3	65 59	62 43	58 58	54 18	63 53	60 56	57 47	54 11	49 33
22	69 14	66 28	63 30	60 7	55 55	64 5	61 25	58 34	55 19	51 9
24	69 21	66 49	64 7	61 2	57 12	64 14	61 47	59 12	56 13	52 26
	30° Blank					35° Blank				
6	40° 54'	29° 22'	16° 32'	35° 32'	25° 19'	14° 3'
8	50 46	42 55	34 24	24° 12'	10° 14'	45 17	38 5	30 18	21° 4'	8° 41'
10	54 29	48 30	42 3	34 31	24 44	49 7	43 33	37 35	30 38	21 40
12	56 18	51 26	46 14	40 12	32 32	51 3	46 30	41 39	36 2	28 55
14	57 21	53 15	48 52	43 49	37 27	52 9	48 19	44 12	39 28	33 33
16	58 0	54 27	50 39	46 19	40 52	52 50	49 20	45 56	41 51	36 45
18	58 26	55 18	51 57	48 7	43 20	53 18	50 21	47 12	43 36	39 8
20	58 44	55 55	52 56	49 30	45 15	53 38	50 59	48 10	44 57	40 57
22	58 57	56 24	53 42	50 36	46 46	53 53	51 29	48 56	46 1	42 24
24	59 8	56 48	54 20	51 30	48 0	54 4	51 53	49 32	46 52	43 35

Angles of Elevation for Milling Straight Teeth in 40-, 45-, 50-, 55-, 60-, 65-, 70-, and 75-degree Blanks Using Single-Angle Fluting Cutters

No. of Teeth	Angle of Fluting Cutter									
	90°	80°	70°	60°	50°	90°	80°	70°	60°	50°
	40° Blank					45° Blank				
6	30° 48'	21° 48'	11° 58'	26° 34'	18° 43'	10° 11'
8	40 7	33 36	26 33	18° 16'	7° 23'	35 16	29 25	23 8	15° 48'	5° 58'
10	43 57	38 51	33 32	27 3	18 55	38 58	34 21	29 24	23 40	16 10
12	45 54	41 43	37 14	32 3	25 33	40 54	37 5	33 0	28 18	22 13
14	47 3	43 29	39 41	35 19	29 51	42 1	38 46	35 17	31 18	26 9
16	47 45	44 39	41 21	37 33	32 50	42 44	39 54	36 52	33 24	28 57
18	48 14	45 29	42 34	39 13	35 5	43 13	40 42	38 1	34 56	30 1
20	48 35	46 7	43 30	40 30	36 47	43 34	41 18	38 53	36 8	32 37
22	48 50	46 36	44 13	41 30	38 8	43 49	41 46	39 34	37 5	34 53
24	49 1	46 58	44 48	42 19	39 15	44 0	42 7	40 7	37 50	35 55
	50° Blank					55° Blank				
6	22° 45'	15° 58'	8° 38'	19° 17'	13° 30'	7° 15'
8	30 41	25 31	19 59	13° 33'	5° 20'	26 21	21 52	17 3	11° 30'	4° 17'
10	34 10	30 2	25 39	20 32	14 9	29 32	25 55	22 3	17 36	11 52
12	36 0	32 34	28 53	24 42	19 27	31 14	28 12	24 59	21 17	16 32
14	37 5	34 9	31 1	27 26	22 58	32 15	29 39	26 53	23 43	19 40
16	37 47	35 13	32 29	29 22	25 30	32 54	30 38	28 12	25 26	21 54
18	38 15	35 58	33 33	30 46	27 21	33 21	31 20	29 10	26 43	23 35
20	38 35	36 32	34 21	31 52	28 47	33 40	31 51	29 54	27 42	24 53
22	38 50	36 58	34 59	32 44	29 57	33 54	32 15	30 29	28 28	25 55
24	39 1	37 19	35 30	33 25	30 52	34 5	32 34	30 57	29 7	26 46
	60° Blank					65° Blank				
6	16° 6'	11° 12'	6° 2'	13° 7'	9° 8'	4° 53'
8	22 13	18 24	14 19	9° 37'	3° 44'	18 15	15 6	11 42	7° 50'	3° 1'
10	25 2	21 56	18 37	14 49	10 5	20 40	18 4	15 19	12 9	8 15
12	26 34	23 57	21 10	17 59	14 13	21 59	19 48	17 28	14 49	11 32
14	27 29	25 14	22 51	20 6	16 44	22 48	20 55	18 54	16 37	13 48
16	28 5	26 7	24 1	21 37	18 40	23 18	21 39	19 53	17 53	15 24
18	28 29	26 44	24 52	22 44	20 6	23 40	22 11	20 37	18 50	16 37
20	28 46	27 11	25 30	23 35	21 14	23 55	22 35	21 10	19 33	17 34
22	29 0	27 34	26 2	24 17	22 8	24 6	22 53	21 36	20 8	18 20
24	29 9	27 50	26 26	24 50	22 52	24 15	23 8	21 57	20 36	18 57
	70° Blank					75° Blank				
6	10° 18'	7° 9'	3° 48'	7° 38'	5° 19'	2° 50'
8	14 26	11 55	9 14	6° 9'	2° 21'	10 44	8 51	6 51	4° 34'	1° 45'
10	16 25	14 21	12 8	9 37	6 30	12 14	10 40	9 1	7 8	4 49
12	17 30	15 45	13 53	11 45	9 8	13 4	11 45	10 21	8 45	6 47
14	18 9	16 38	15 1	13 11	10 55	13 34	12 26	11 13	9 50	8 7
16	18 35	17 15	15 50	14 13	12 13	13 54	12 54	11 50	10 37	9 7
18	18 53	17 42	16 26	14 59	13 13	14 8	13 14	12 17	11 12	9 51
20	19 6	18 1	16 53	15 35	13 59	14 18	13 29	12 38	11 39	10 27
22	19 15	18 16	17 15	16 3	14 35	14 25	13 41	12 53	12 0	10 54
24	19 22	18 29	17 33	16 25	15 5	14 31	13 50	13 7	12 18	11 18

Angles of Elevation for Milling Straight Teeth in 80- and 85-degree Blanks Using Single-Angle Fluting Cutters

No. of Teeth	Angle of Fluting Cutter									
	90°	80°	70°	60°	50°	90°	80°	70°	60°	50°
	80° Blank					85° Blank				
6	5° 2'	3° 30'	1° 52'	2° 30'	1° 44'	0° 55'
8	7 6	5 51	4 31	3° 2'	1° 8'	3 32	2 55	2 15	1° 29'	0° 34'
10	8 7	7 5	5 59	4 44	3 11	4 3	3 32	2 59	2 21	1 35
12	8 41	7 48	6 52	5 48	4 29	4 20	3 53	3 25	2 53	2 15
14	9 2	8 16	7 28	6 32	5 24	4 30	4 7	3 43	3 15	2 42
16	9 15	8 35	7 51	7 3	6 3	4 37	4 17	3 56	3 30	3 1
18	9 24	8 48	8 10	7 26	6 33	4 42	4 24	4 5	3 43	3 16
20	9 31	8 58	8 24	7 44	6 56	4 46	4 29	4 12	3 52	3 28
22	9 36	9 6	8 35	7 59	7 15	4 48	4 33	4 18	3 59	3 37
24	9 40	9 13	8 43	8 11	7 30	4 50	4 36	4 22	4 5	3 45

Spline-Shaft Milling Cutter.—The most efficient method of forming splines on shafts is by hobbing, but special milling cutters may also be used. Since the cutter forms the space between adjacent splines, it must be made to suit the number of splines and the root diameter of the shaft. The cutter angle B equals 360 degrees divided by the number of splines. The following formulas are for determining the chordal width C at the root of the splines or the chordal width across the concave edge of the cutter. In these formulas, A = angle between center line of spline and a radial line passing through the intersection of the root circle and one side of the spline; W = width of spline; d = root diameter of splined shaft; C = chordal width at root circle between adjacent splines; N = number of splines.

$$\sin A = \frac{W}{d} \quad C = d \times \sin\left(\frac{180}{N} - A\right)$$

Splines of involute form are often used in preference to the straight-sided type. Dimensions of the American Standard involute splines and hobs are given in the section on splines.

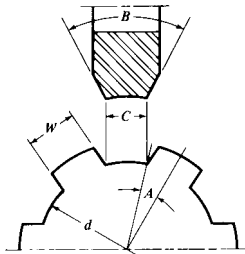

Cutter Grinding

Wheels for Sharpening Milling Cutters.—Milling cutters may be sharpened either by using the periphery of a disk wheel or the face of a cup wheel. The latter grinds the lands of the teeth flat, whereas the periphery of a disk wheel leaves the teeth slightly concave back of the cutting edges. The concavity produced by disk wheels reduces the effective clearance angle on the teeth, the effect being more pronounced for wheels of small diameter than for wheels of large diameter. For this reason, large diameter wheels are preferred

when sharpening milling cutters with disk type wheels. Irrespective of what type of wheel is used to sharpen a milling cutter, any burrs resulting from grinding should be carefully removed by a hand stoning operation. Stoning also helps to reduce the roughness of grinding marks and improves the quality of the finish produced on the surface being machined. Unless done very carefully, hand stoning may dull the cutting edge. Stoning may be avoided and a sharper cutting edge produced if the wheel rotates toward the cutting edge, which requires that the operator maintain contact between the tool and the rest while the wheel rotation is trying to move the tool away from the rest. Though slightly more difficult, this method will eliminate the burr.

Specifications of Grinding Wheels for Sharpening Milling Cutters

Cutter Material	Operation	Grinding Wheel			
		Abrasive Material	Grain Size	Grade	Bond
Carbon Tool Steel	Roughing Finishing	Aluminum Oxide	46-60	K	Vitrified
		Aluminum Oxide	100	H	Vitrified
High-speed Steel:	18-4-1 { Roughing Finishing	Aluminum Oxide	60	K,H	Vitrified
		Aluminum Oxide	100	H	Vitrified
	18-4-2 { Roughing Finishing	Aluminum Oxide	80	F,G,H	Vitrified
		Aluminum Oxide	100	H	Vitrified
Cast Non-Ferrous Tool Material	Roughing Finishing	Aluminum Oxide	46	H,K,L,N	Vitrified
		Aluminum Oxide	100-120	H	Vitrified
Sintered Carbide	Roughing after Brazing	Silicon Carbide	60	G	Vitrified
	Roughing Finishing	Diamond	100	a	Resinoid
		Diamond	Up to 500	a	Resinoid
Carbon Tool Steel and High-Speed Steel ^b	Roughing Finishing	Cubic Boron Nitride	80-100	R,P	Resinoid
		Cubic Boron Nitride	100-120	S,T	Resinoid

^a Not indicated in diamond wheel markings.

^b For hardnesses above Rockwell C 56.

Wheel Speeds and Feeds for Sharpening Milling Cutters.—Relatively low cutting speeds should be used when sharpening milling cutters to avoid tempering and heat checking. Dry grinding is recommended in all cases except when diamond wheels are employed. The surface speed of grinding wheels should be in the range of 4500 to 6500 feet per minute for grinding milling cutters of high-speed steel or cast non-ferrous tool material. For sintered carbide cutters, 5000 to 5500 feet per minute should be used.

The maximum stock removed per pass of the grinding wheel should not exceed about 0.0004 inch for sintered carbide cutters; 0.003 inch for large high-speed steel and cast non-ferrous tool material cutters; and 0.0015 inch for narrow saws and slotting cutters of high-speed steel or cast non-ferrous tool material. The stock removed per pass of the wheel may be increased for backing-off operations such as the grinding of secondary clearance behind the teeth since there is usually a sufficient body of metal to carry off the heat.

Clearance Angles for Milling Cutter Teeth.—The clearance angle provided on the cutting edges of milling cutters has an important bearing on cutter performance, cutting efficiency, and cutter life between sharpenings. It is desirable in all cases to use a clearance angle as small as possible so as to leave more metal back of the cutting edges for better heat dissipation and to provide maximum support. Excessive clearance angles not only weaken the cutting edges, but also increase the likelihood of "chatter" which will result in poor finish on the machined surface and reduce the life of the cutter. According to The Cincinnati Milling Machine Co., milling cutters used for general purpose work and having diameters

from $\frac{1}{8}$ to 3 inches should have clearance angles from 13 to 5 degrees, respectively, decreasing proportionately as the diameter increases. General purpose cutters over 3 inches in diameter should be provided with a clearance angle of 4 to 5 degrees. The land width is usually $\frac{1}{64}$, $\frac{1}{32}$, and $\frac{1}{16}$ inch, respectively, for small, medium, and large cutters.

The primary clearance or relief angle for best results varies according to the material being milled about as follows: low carbon, high carbon, and alloy steels, 3 to 5 degrees; cast iron and medium and hard bronze, 4 to 7 degrees; brass, soft bronze, aluminum, magnesium, plastics, etc., 10 to 12 degrees. When milling cutters are resharpened, it is customary to grind a secondary clearance angle of 3 to 5 degrees behind the primary clearance angle to reduce the land width to its original value and thus avoid interference with the surface to be milled. A general formula for plain milling cutters, face mills, and form relieved cutters which gives the clearance angle C , in degrees, necessitated by the feed per revolution F , in inches, the width of land L , in inches, the depth of cut d , in inches, the cutter diameter D , in inches, and the Brinell hardness number B of the work being cut is:

$$C = \frac{45860}{DB} \left(1.5L + \frac{F}{\pi D} \sqrt{d(D-d)} \right)$$

Rake Angles for Milling Cutters.—In peripheral milling cutters, the rake angle is generally defined as the angle in degrees that the tooth face deviates from a radial line to the cutting edge. In face milling cutters, the teeth are inclined with respect to both the radial and axial lines. These angles are called *radial* and *axial* rake, respectively. The radial and axial rake angles may be positive, zero, or negative.

Positive rake angles should be used whenever possible for all types of high-speed steel milling cutters. For sintered carbide tipped cutters, zero and negative rake angles are frequently employed to provide more material back of the cutting edge to resist shock loads.

Rake Angles for High-speed Steel Cutters: Positive rake angles of 10 to 15 degrees are satisfactory for milling steels of various compositions with plain milling cutters. For softer materials such as magnesium and aluminum alloys, the rake angle may be 25 degrees or more. Metal slitting saws for cutting alloy steel usually have rake angles from 5 to 10 degrees, whereas zero and sometimes negative rake angles are used for saws to cut copper and other soft non-ferrous metals to reduce the tendency to "hog in." Form relieved cutters usually have rake angles of 0, 5, or 10 degrees. Commercial face milling cutters usually have 10 degrees positive radial and axial rake angles for general use in milling cast iron, forged and alloy steel, brass, and bronze; for milling castings and forgings of magnesium and free-cutting aluminum and their alloys, the rake angles may be increased to 25 degrees positive or more, depending on the operating conditions; a smaller rake angle is used for abrasive or difficult to machine aluminum alloys.

Cast Non-ferrous Tool Material Milling Cutters: Positive rake angles are generally provided on milling cutters using cast non-ferrous tool materials although negative rake angles may be used advantageously for some operations such as those where shock loads are encountered or where it is necessary to eliminate vibration when milling thin sections.

Sintered Carbide Milling Cutters: Peripheral milling cutters such as slab mills, slotting cutters, saws, etc., tipped with sintered carbide, generally have negative radial rake angles of 5 degrees for soft low carbon steel and 10 degrees or more for alloy steels. Positive axial rake angles of 5 and 10 degrees, respectively, may be provided, and for slotting saws and cutters, 0 degree axial rake may be used. On soft materials such as free-cutting aluminum alloys, positive rake angles of 10 to so degrees are used. For milling abrasive or difficult to machine aluminum alloys, small positive or even negative rake angles are used.

Eccentric Type Radial Relief.—When the radial relief angles on peripheral teeth of milling cutters are ground with a disc type grinding wheel in the conventional manner the ground surfaces on the lands are slightly concave, conforming approximately to the radius of the wheel. A flat land is produced when the radial relief angle is ground with a cup

wheel. Another entirely different method of grinding the radial angle is by the eccentric method, which produces a slightly convex surface on the land. If the radial relief angle at the cutting edge is equal for all of the three types of land mentioned, it will be found that the land with the eccentric relief will drop away from the cutting edge a somewhat greater distance for a given distance around the land than will the others. This is evident from a study of Table entitled, "Indicator Drops for Checking Radial Relief Angles on Peripheral Teeth." This feature is an advantage of the eccentric type relief which also produces an excellent finish.

Indicator Drops for Checking the Radial Relief Angle on Peripheral Teeth

Cutter Diameter, Inch	Recom. Range of Radial Relief Angles, Degrees	Checking Distance, Inch	Indicator Drops, Inches				Recom. Max. Primary Land Width, Inch
			For Flat and Concave Relief		For Eccentric Relief		
			Min.	Max.	Min.	Max.	
1/16	20-25	.005	.0014	.0019	.0020	.0026	.007
3/32	16-20	.005	.0012	.0015	.0015	.0019	.007
1/8	15-19	.010	.0018	.0026	.0028	.0037	.015
5/32	13-17	.010	.0017	.0024	.0024	.0032	.015
3/16	12-16	.010	.0016	.0023	.0022	.0030	.015
7/32	11-15	.010	.0015	.0022	.0020	.0028	.015
1/4	10-14	.015	.0017	.0028	.0027	.0039	.020
9/32	10-14	.015	.0018	.0029	.0027	.0039	.020
5/16	10-13	.015	.0019	.0027	.0027	.0035	.020
11/32	10-13	.015	.0020	.0028	.0027	.0035	.020
3/8	10-13	.015	.0020	.0029	.0027	.0035	.020
13/32	9-12	.020	.0022	.0032	.0032	.0044	.025
7/16	9-12	.020	.0022	.0033	.0032	.0043	.025
15/32	9-12	.020	.0023	.0034	.0032	.0043	.025
1/2	9-12	.020	.0024	.0034	.0032	.0043	.025
9/16	9-12	.020	.0024	.0035	.0032	.0043	.025
5/8	8-11	.020	.0022	.0032	.0028	.0039	.025
11/16	8-11	.030	.0029	.0045	.0043	.0059	.035
3/4	8-11	.030	.0030	.0046	.0043	.0059	.035
13/16	8-11	.030	.0031	.0047	.0043	.0059	.035
7/8	8-11	.030	.0032	.0048	.0043	.0059	.035
15/16	7-10	.030	.0027	.0043	.0037	.0054	.035
1	7-10	.030	.0028	.0044	.0037	.0054	.035
1 1/8	7-10	.030	.0029	.0045	.0037	.0053	.035
1 1/4	6-9	.030	.0024	.0040	.0032	.0048	.035
1 3/8	6-9	.030	.0025	.0041	.0032	.0048	.035
1 1/2	6-9	.030	.0026	.0041	.0032	.0048	.035
1 5/8	6-9	.030	.0026	.0042	.0032	.0048	.035
1 3/4	6-9	.030	.0026	.0042	.0032	.0048	.035
1 7/8	6-9	.030	.0027	.0043	.0032	.0048	.035
2	6-9	.030	.0027	.0043	.0032	.0048	.035
2 1/4	5-8	.030	.0022	.0038	.0026	.0042	.040
2 1/2	5-8	.030	.0023	.0039	.0026	.0042	.040
2 3/4	5-8	.030	.0023	.0039	.0026	.0042	.040
3	5-8	.030	.0023	.0039	.0026	.0042	.040
3 1/2	5-8	.030	.0024	.0040	.0026	.0042	.047
4	5-8	.030	.0024	.0040	.0026	.0042	.047
5	4-7	.030	.0019	.0035	.0021	.0037	.047
6	4-7	.030	.0019	.0035	.0021	.0037	.047
7	4-7	.030	.0020	.0036	.0021	.0037	.060
8	4-7	.030	.0020	.0036	.0021	.0037	.060
10	4-7	.030	.0020	.0036	.0021	.0037	.060
12	4-7	.030	.0020	.0036	.0021	.0037	.060

The setup for grinding an eccentric relief is shown in Fig. 2. In this setup the point of contact between the cutter and the tooth rest must be in the same plane as the centers, or axes, of the grinding wheel and the cutter. A wide face is used on the grinding wheel, which is trued and dressed at an angle with respect to the axis of the cutter. An alternate method is to tilt the wheel at this angle. Then as the cutter is traversed and rotated past the grinding wheel while in contact with the tooth rest, an eccentric relief will be generated by the angular face of the wheel. This type of relief can only be ground on the peripheral teeth on milling cutters having helical flutes because the combination of the angular wheel face and the twisting motion of the cutter is required to generate the eccentric relief. Therefore, an eccentric relief cannot be ground on the peripheral teeth of straight fluted cutters.

Table 4 is a table of wheel angles for grinding an eccentric relief for different combinations of relief angles and helix angles. When angles are required that cannot be found in this table, the wheel angle, W , can be calculated by using the following formula, in which R is the radial relief angle and H is the helix angle of the flutes on the cutter.

$$\tan W = \tan R \times \tan H$$

Table 4. Grinding Wheel Angles for Grinding Eccentric Type Radial Relief Angle

Radial Relief Angle, R , Degrees	Helix Angle of Cutter Flutes, H , Degrees							
	12	18	20	30	40	45	50	52
	Wheel Angle, W , Degrees							
1	0°13'	0°19'	0°22'	0°35'	0°50'	1°00'	1°12'	1°17'
2	0°26'	0°39'	0°44'	1°09'	1°41'	2°00'	2°23'	2°34'
3	0°38'	0°59'	1°06'	1°44'	2°31'	3°00'	3°34'	3°50'
4	0°51'	1°18'	1°27'	2°19'	3°21'	4°00'	4°46'	5°07'
5	1°04'	1°38'	1°49'	2°53'	4°12'	5°00'	5°57'	6°23'
6	1°17'	1°57'	2°11'	3°28'	5°02'	6°00'	7°08'	7°40'
7	1°30'	2°17'	2°34'	4°03'	5°53'	7°00'	8°19'	8°56'
8	1°43'	2°37'	2°56'	4°38'	6°44'	8°00'	9°30'	10°12'
9	1°56'	2°57'	3°18'	5°13'	7°34'	9°00'	10°41'	11°28'
10	2°09'	3°17'	3°40'	5°49'	8°25'	10°00'	11°52'	12°43'
11	2°22'	3°37'	4°03'	6°24'	9°16'	11°00'	13°03'	13°58'
12	2°35'	3°57'	4°25'	7°00'	10°07'	12°00'	14°13'	15°13'
13	2°49'	4°17'	4°48'	7°36'	10°58'	13°00'	15°23'	16°28'
14	3°02'	4°38'	5°11'	8°11'	11°49'	14°00'	16°33'	17°42'
15	3°16'	4°59'	5°34'	8°48'	12°40'	15°00'	17°43'	18°56'
16	3°29'	5°19'	5°57'	9°24'	13°32'	16°00'	18°52'	20°09'
17	3°43'	5°40'	6°21'	10°01'	14°23'	17°00'	20°01'	21°22'
18	3°57'	6°02'	6°45'	10°37'	15°15'	18°00'	21°10'	22°35'
19	4°11'	6°23'	7°09'	11°15'	16°07'	19°00'	22°19'	23°47'
20	4°25'	6°45'	7°33'	11°52'	16°59'	20°00'	23°27'	24°59'
21	4°40'	7°07'	7°57'	12°30'	17°51'	21°00'	24°35'	26°10'
22	4°55'	7°29'	8°22'	13°08'	18°44'	22°00'	25°43'	27°21'
23	5°09'	7°51'	8°47'	13°46'	19°36'	23°00'	26°50'	28°31'
24	5°24'	8°14'	9°12'	14°25'	20°29'	24°00'	27°57'	29°41'
25	5°40'	8°37'	9°38'	15°04'	21°22'	25°00'	29°04'	30°50'

Indicator Drop Method of Checking Relief and Rake Angles.—The most convenient and inexpensive method of checking the relief and rake angles on milling cutters is by the indicator drop method. Three tables, Tables 5 and 6, of indicator drops are provided in this section, for checking radial relief angles on the peripheral teeth, relief angles on side and end teeth, and rake angles on the tooth faces.

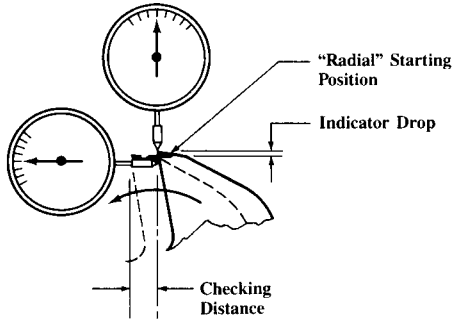

Fig. 1. Setup for Checking the Radial Relief Angle by Indicator Drop Method

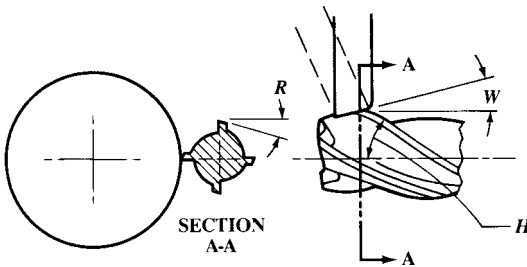
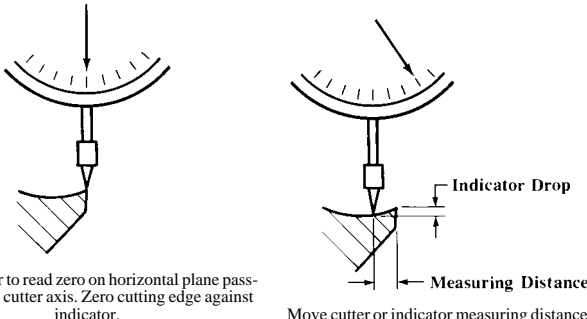

Fig. 2. Setup for Grinding Eccentric Type Radial Relief Angle

Table 5. Indicator Drops for Checking Relief Angles on Side Teeth and End Teeth

Checking Distance, Inch	Given Relief Angle								
	1°	2°	3°	4°	5°	6°	7°	8°	9°
	Indicator Drop, inch								
.005	.00009	.00017	.00026	.00035	.0004	.0005	.0006	.0007	.0008
.010	.00017	.00035	.00052	.0007	.0009	.0011	.0012	.0014	.0016
.015	.00026	.0005	.00079	.0010	.0013	.0016	.0018	.0021	.0024
.031	.00054	.0011	.0016	.0022	.0027	.0033	.0038	.0044	.0049
.047	.00082	.0016	.0025	.0033	.0041	.0049	.0058	.0066	.0074
.062	.00108	.0022	.0032	.0043	.0054	.0065	.0076	.0087	.0098

Table 6. Indicator Drops for Checking Rake Angles on Milling Cutter Face

Set indicator to read zero on horizontal plane passing through cutter axis. Zero cutting edge against indicator.

Move cutter or indicator measuring distance.

Rate Angle, Deg.	Measuring Distance, inch				Rate Angle, Deg.	Measuring Distance, inch			
	.031	.062	.094	.125		.031	.062	.094	.125
	Indicator Drop, inch					Indicator Drop, inch			
1	.0005	.0011	.0016	.0022	11	.0060	.0121	.0183	.0243
2	.0011	.0022	.0033	.0044	12	.0066	.0132	.0200	.0266
3	.0016	.0032	.0049	.0066	13	.0072	.0143	.0217	.0289
4	.0022	.0043	.0066	.0087	14	.0077	.0155	.0234	.0312
5	.0027	.0054	.0082	.0109	15	.0083	.0166	.0252	.0335
6	.0033	.0065	.0099	.0131	16	.0089	.0178	.0270	.0358
7	.0038	.0076	.0115	.0153	17	.0095	.0190	.0287	.0382
8	.0044	.0087	.0132	.0176	18	.0101	.0201	.0305	.0406
9	.0049	.0098	.0149	.0198	19	.0107	.0213	.0324	.0430
10	.0055	.0109	.0166	.0220	20	.0113	.0226	.0342	.0455

The setup for checking the radial relief angle is illustrated in Fig. 1. Two dial test indicators are required, one of which should have a sharp pointed contact point. This indicator is positioned so that the axis of its spindle is vertical, passing through the axis of the cutter. The cutter may be held by its shank in the spindle of a tool and cutter grinder workhead, or between centers while mounted on a mandrel. The cutter is rotated to the position where the vertical indicator contacts a cutting edge. The second indicator is positioned with its spindle axis horizontal and with the contact point touching the tool face just below the cutting edge. With both indicators adjusted to read zero, the cutter is rotated a distance equal to the checking distance, as determined by the reading on the second indicator. Then the indicator drop is read on the vertical indicator and checked against the values in the tables. The indicator drops for radial relief angles ground by a disc type grinding wheel and those ground with a cup wheel are so nearly equal that the values are listed together; values for the eccentric type relief are listed separately, since they are larger. A similar procedure is used to check the relief angles on the side and end teeth of milling cutters; however, only one indicator is used. Also, instead of rotating the cutter, the indicator or the cutter must be moved a distance equal to the checking distance in a straight line.

Various Set-ups Used in Grinding the Clearance Angle on Milling Cutter Teeth

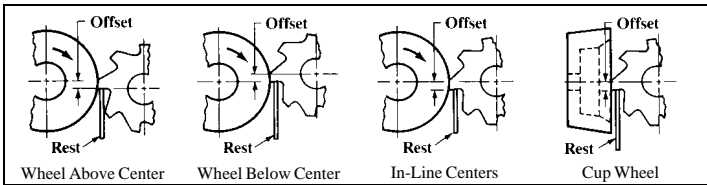

Distance to Set Center of Wheel Above the Cutter Center (Disk Wheel)

Dia. of Wheel, Inches	Desired Clearance Angle, Degrees											
	1	2	3	4	5	6	7	8	9	10	11	12
	*Distance to Offset Wheel Center Above Cutter Center, Inches											
3	.026	.052	.079	.105	.131	.157	.183	.209	.235	.260	.286	.312
4	.035	.070	.105	.140	.174	.209	.244	.278	.313	.347	.382	.416
5	.044	.087	.131	.174	.218	.261	.305	.348	.391	.434	.477	.520
6	.052	.105	.157	.209	.261	.314	.366	.417	.469	.521	.572	.624
7	.061	.122	.183	.244	.305	.366	.427	.487	.547	.608	.668	.728
8	.070	.140	.209	.279	.349	.418	.488	.557	.626	.695	.763	.832
9	.079	.157	.236	.314	.392	.470	.548	.626	.704	.781	.859	.936
10	.087	.175	.262	.349	.436	.523	.609	.696	.782	.868	.954	1.040

* Calculated from the formula: Offset = Cutter Diameter $\times \frac{1}{2} \times$ Sine of Clearance Angle.

Distance to Set Center of Wheel Below the Cutter Center (Disk Wheel)

Dia. of Cutter, Inches	Desired Clearance Angle, Degrees											
	1	2	3	4	5	6	7	8	9	10	11	12
	*Distance to Offset Wheel Center Below Cutter Center, Inches											
2	.017	.035	.052	.070	.087	.105	.122	.139	.156	.174	.191	.208
3	.026	.052	.079	.105	.131	.157	.183	.209	.235	.260	.286	.312
4	.035	.070	.105	.140	.174	.209	.244	.278	.313	.347	.382	.416
5	.044	.087	.131	.174	.218	.261	.305	.348	.391	.434	.477	.520
6	.052	.105	.157	.209	.261	.314	.366	.417	.469	.521	.572	.624
7	.061	.122	.183	.244	.305	.366	.427	.487	.547	.608	.668	.728
8	.070	.140	.209	.279	.349	.418	.488	.557	.626	.695	.763	.832
9	.079	.157	.236	.314	.392	.470	.548	.626	.704	.781	.859	.936
10	.087	.175	.262	.349	.436	.523	.609	.696	.782	.868	.954	1.040

Distance to Set Tooth Rest Below Center Line of Wheel and Cutter.—When the clearance angle is ground with a disk type wheel by keeping the center line of the wheel in line with the center line of the cutter, the tooth rest should be lowered by an amount given by the following formula:

$$\text{Offset} = \frac{\text{Wheel Diam.} \times \text{Cutter Dia.} \times \text{Sine of One-half the Clearance Angle}}{\text{Wheel Dia.} + \text{Cutter Dia.}}$$

Distance to Set Tooth Rest Below Cutter Center When Cup Wheel is Used.—When the clearance is ground with a cup wheel, the tooth rest is set below the center of the cutter the same amount as given in the table for “Distance to Set Center of Wheel Below the Cutter Center (Disk Wheel).”