

# PROGRAMMING ACTIONSCRIPT™ 3.0

© 2007 Adobe Systems Incorporated. All rights reserved.

Programming ActionScript™ 3.0

If this guide is distributed with software that includes an end-user agreement, this guide, as well as the software described in it, is furnished under license and may be used or copied only in accordance with the terms of such license. Except as permitted by any such license, no part of this guide may be reproduced, stored in a retrieval system, or transmitted, in any form or by any means, electronic, mechanical, recording, or otherwise, without the prior written permission of Adobe Systems Incorporated. Please note that the content in this guide is protected under copyright law even if it is not distributed with software that includes an end-user license agreement.

The content of this guide is furnished for informational use only, is subject to change without notice, and should not be construed as a commitment by Adobe Systems Incorporated. Adobe Systems Incorporated assumes no responsibility or liability for any errors or inaccuracies that may appear in the informational content contained in this guide.

Please remember that existing artwork or images that you may want to include in your project may be protected under copyright law. The unauthorized incorporation of such material into your new work could be a violation of the rights of the copyright owner. Please be sure to obtain any permission required from the copyright owner.

Any references to company names in sample templates are for demonstration purposes only and are not intended to refer to any actual organization.

Adobe, the Adobe logo, Flex, Flex Builder and Flash Player are either registered trademarks or trademarks of Adobe Systems Incorporated in the United States and/or other countries.

ActiveX and Windows are either registered trademarks or trademarks of Microsoft Corporation in the United States and other countries. Macintosh is a trademark of Apple Inc., registered in the United States and other countries. All other trademarks are the property of their respective owners.

Speech compression and decompression technology licensed from Nellymoser, Inc. ([www.nellymoser.com](http://www.nellymoser.com)).

**Sorenson Spark** Sorenson™ Spark™ video compression and decompression technology licensed from Sorenson Media, Inc.  
Opera® browser Copyright © 1995-2002 Opera Software ASA and its suppliers. All rights reserved.

Adobe Systems Incorporated, 345 Park Avenue, San Jose, California 95110, USA

Notice to U.S. government end users. The software and documentation are “Commercial Items,” as that term is defined at 48 C.F.R. §2.101, consisting of “Commercial Computer Software” and “Commercial Computer Software Documentation,” as such terms are used in 48 C.F.R. §12.212 or 48 C.F.R. §227.7202, as applicable. Consistent with 48 C.F.R. §12.212 or 48 C.F.R. §§227.7202-1 through 227.7202-4, as applicable, the Commercial Computer Software and Commercial Computer Software Documentation are being licensed to U.S. Government end users (a) only as Commercial items and (b) with only those rights as are granted to all other end users pursuant to the terms and conditions herein. Unpublished-rights reserved under the copyright laws of the United States. Adobe Systems Incorporated, 345 Park Avenue, San Jose, CA 95110-2704, USA. For U.S. Government End Users, Adobe agrees to comply with all applicable equal opportunity laws including, if appropriate, the provisions of Executive Order 11246, as amended, Section 402 of the Vietnam Era Veterans Readjustment Assistance Act of 1974 (38 USC 4212), and Section 503 of the Rehabilitation Act of 1973, as amended, and the regulations at 41 CFR Parts 60-1 through 60-60, 60-250, and 60-741. The affirmative action clause and regulations contained in the preceding sentence shall be incorporated by reference.

# Contents

<b>About this manual</b> .....	<b>13</b>
Using this manual .....	14
Accessing ActionScript documentation .....	15
ActionScript learning resources .....	17
<b>Chapter 1: Introduction to ActionScript 3.0</b> .....	<b>19</b>
About ActionScript .....	19
Advantages of ActionScript 3.0 .....	20
What's new in ActionScript 3.0 .....	21
Core language features .....	21
Flash Player API features .....	23
Compatibility with previous versions .....	24
<b>Chapter 2: Getting started with ActionScript</b> .....	<b>27</b>
Programming fundamentals .....	27
What computer programs do .....	27
Variables and constants .....	28
Data types .....	29
Working with objects .....	31
Properties .....	31
Methods .....	32
Events .....	33
Basic event handling .....	34
Examining the event-handling process .....	35
Event-handling examples .....	39
Creating object instances .....	40
Common program elements .....	42
Example: Animation portfolio piece .....	44
Building applications with ActionScript .....	47
Options for organizing your code .....	48
Choosing the right tool .....	50
The ActionScript development process .....	51
Creating your own classes .....	53
Strategies for designing a class .....	53
Writing the code for a class .....	54

Suggestions for organizing your classes .....	56
Example: Creating a basic application .....	56
Running subsequent examples .....	63
<b>Chapter 3: ActionScript language and syntax .....</b>	<b>67</b>
Language overview .....	68
Objects and classes .....	69
Packages and namespaces .....	70
Packages .....	70
Namespaces .....	75
Variables .....	83
Data types .....	87
Type checking .....	88
Dynamic classes .....	93
Data type descriptions .....	94
Type conversions .....	97
Syntax .....	103
Operators .....	109
Conditionals .....	117
Looping .....	119
Functions .....	122
Basic function concepts .....	122
Function parameters .....	128
Functions as objects .....	134
Function scope .....	135
<b>Chapter 4: Object-oriented programming in ActionScript .....</b>	<b>137</b>
Basics of object-oriented programming .....	138
Classes .....	140
Class definitions .....	141
Class property attributes .....	144
Variables .....	147
Methods .....	148
Enumerations with classes .....	156
Embedded asset classes .....	158
Interfaces .....	158
Inheritance .....	162
Advanced topics .....	171
Example: GeometricShapes .....	180

<b>Chapter 5: Working with dates and times.</b>	<b>191</b>
Basics of dates and times.	191
Managing calendar dates and times	193
Controlling time intervals	196
Example: Simple analog clock.	199
<b>Chapter 6: Working with strings</b>	<b>203</b>
Basics of strings	204
Creating strings	205
The length property	207
Working with characters in strings	208
Comparing strings	208
Obtaining string representations of other objects.	209
Concatenating strings	209
Finding substrings and patterns in strings	210
Converting strings between uppercase and lowercase	215
Example: ASCII art.	216
<b>Chapter 7: Working with arrays</b>	<b>223</b>
Basics of arrays.	223
Indexed arrays	225
Associative arrays	234
Multidimensional arrays	239
Cloning arrays	241
Advanced topics.	241
Example: PlayList.	247
<b>Chapter 8: Handling errors</b>	<b>253</b>
Basics of error handling	254
Types of errors	257
Error handling in ActionScript 3.0	259
ActionScript 3.0 error-handling elements	260
Error-handling strategies	261
Working with the debugger version of Flash Player.	261
Handling synchronous errors in an application	262
Creating custom error classes	267
Responding to error events and status	268

Comparing the Error classes . . . . .	272
ECMAScript core Error classes . . . . .	272
ActionScript core Error classes . . . . .	275
flash.error package Error classes . . . . .	276
Example: CustomErrors application . . . . .	278
<b>Chapter 9: Using regular expressions . . . . .</b>	<b>285</b>
Basics of regular expressions . . . . .	286
Regular expression syntax . . . . .	288
Creating an instance of a regular expression . . . . .	289
Characters, metacharacters, and metasequences . . . . .	290
Character classes . . . . .	293
Quantifiers . . . . .	295
Alternation . . . . .	297
Groups . . . . .	297
Flags and properties . . . . .	301
Methods for using regular expressions with strings . . . . .	305
Example: A Wiki parser . . . . .	306
<b>Chapter 10: Handling events . . . . .</b>	<b>313</b>
Basics of handling events . . . . .	314
How ActionScript 3.0 event handling differs from earlier versions . . . . .	317
The event flow . . . . .	320
Event objects . . . . .	322
Event listeners . . . . .	327
Example: Alarm Clock . . . . .	335
<b>Chapter 11: Working with XML . . . . .</b>	<b>343</b>
Basics of XML . . . . .	344
The E4X approach to XML processing . . . . .	348
XML objects . . . . .	350
XMLList objects . . . . .	353
Initializing XML variables . . . . .	354
Assembling and transforming XML objects . . . . .	356
Traversing XML structures . . . . .	358
Using XML namespaces . . . . .	363
XML type conversion . . . . .	364
Reading external XML documents . . . . .	366
Example: Loading RSS data from the Internet . . . . .	367

<b>Chapter 12: Display programming</b> .....	<b>371</b>
Basics of display programming .....	372
Core display classes .....	377
Advantages of the display list approach .....	379
Working with display objects .....	382
Properties and methods of the DisplayObject class .....	382
Adding display objects to the display list .....	383
Working with display object containers .....	383
Traversing the display list .....	387
Setting Stage properties .....	389
Handling events for display objects .....	392
Choosing a DisplayObject subclass .....	393
Manipulating display objects .....	395
Changing position .....	395
Panning and scrolling display objects .....	400
Manipulating size and scaling objects .....	402
Controlling distortion when scaling .....	403
Caching display objects .....	405
When to enable caching .....	406
Enabling bitmap caching .....	408
Setting an opaque background color .....	409
Applying blending modes .....	409
Adjusting DisplayObject colors .....	410
Setting color values with code .....	411
Altering color and brightness effects with code .....	412
Rotating objects .....	413
Fading objects .....	413
Masking display objects .....	414
Animating objects .....	416
Loading display content dynamically .....	418
Loading display objects .....	419
Monitoring loading progress .....	420
Specifying loading context .....	421
Example: SpriteArranger .....	423
<b>Chapter 13: Working with geometry</b> .....	<b>431</b>
Basics of geometry .....	431
Using Point objects .....	434
Using Rectangle objects .....	436
Using Matrix objects .....	440
Example: Applying a matrix transformation to a display object . . . .	442

<b>Chapter 14: Using the drawing API</b> . . . . .	<b>447</b>
Basics of using the drawing API . . . . .	448
Understanding the Graphics class . . . . .	450
Drawing lines and curves . . . . .	450
Drawing shapes using built-in methods . . . . .	453
Creating gradient lines and fills . . . . .	454
Using the Math class with drawing methods . . . . .	460
Animating with the drawing API . . . . .	461
Example: Algorithmic Visual Generator . . . . .	462
<b>Chapter 15: Filtering display objects</b> . . . . .	<b>465</b>
Basics of filtering display objects . . . . .	465
Creating and applying filters . . . . .	467
Creating a new filter . . . . .	467
Applying a filter . . . . .	467
How filters work . . . . .	470
Potential issues for working with filters . . . . .	470
Available display filters . . . . .	472
Bevel filter . . . . .	473
Blur filter . . . . .	474
Drop shadow filter . . . . .	474
Glow filter . . . . .	475
Gradient bevel filter . . . . .	476
Gradient glow filter . . . . .	477
Example: Combining basic filters . . . . .	478
Color matrix filter . . . . .	480
Convolution filter . . . . .	481
Displacement map filter . . . . .	484
Example: Filter Workbench . . . . .	490
<b>Chapter 16: Working with movie clips</b> . . . . .	<b>491</b>
Basics of movie clips . . . . .	491
Working with MovieClip objects . . . . .	494
Controlling movie clip playback . . . . .	494
Working with scenes . . . . .	497
Creating MovieClip objects with ActionScript . . . . .	498
Exporting library symbols for ActionScript . . . . .	498
Loading an external SWF file . . . . .	501
Example: RuntimeAssetsExplorer . . . . .	503



<b>Chapter 17: Working with text</b> .....	<b>509</b>
Basics of working with text.....	510
Displaying text.....	513
Types of text .....	513
Modifying the text field contents .....	514
Displaying HTML text .....	514
Using images in text fields .....	515
Scrolling text in a text field.....	516
Selecting and manipulating text .....	517
Capturing text input .....	518
Restricting text input .....	520
Formatting text .....	520
Assigning text formats .....	521
Applying cascading style sheets.....	521
Loading an external CSS file.....	523
Formatting ranges of text within a text field .....	524
Advanced text rendering.....	525
Working with static text.....	528
Example: Newspaper-style text formatting .....	529
Reading the external CSS file.....	530
Arranging story elements on the page .....	532
Altering font size to fit the field size .....	533
Splitting text across multiple columns.....	535
<b>Chapter 18: Working with bitmaps</b> .....	<b>539</b>
Basics of working with bitmaps.....	540
The Bitmap and BitmapData classes .....	543
Manipulating pixels.....	545
Manipulating individual pixels .....	545
Pixel-level collision detection .....	547
Copying bitmap data .....	549
Making textures with noise functions.....	550
Scrolling bitmaps .....	552
Example: Animating sprites using an offscreen bitmap.....	553
<b>Chapter 19: Working with video</b> .....	<b>555</b>
Basics of video .....	556
Understanding the Flash Video (FLV) format .....	559
Understanding the Video class .....	560
Loading video files .....	561
Controlling video playback.....	562
Detecting the end of a video stream .....	563

Streaming video files .....	564
Understanding cue points .....	565
Writing callback methods for onCuePoint and onMetaData .....	566
Set the NetStream object's client property to an Object .....	567
Create a custom class and define methods to handle the callback methods.....	568
Extend the NetStream class and add methods to handle the callback methods.....	569
Extend the NetStream class and make it dynamic .....	570
Set the NetStream object's client property to this.....	572
Using cue points .....	572
Using video metadata .....	573
Capturing camera input .....	577
Understanding the Camera class .....	577
Displaying camera content on-screen .....	578
Designing your camera application.....	578
Connecting to a user's camera.....	578
Verifying that cameras are installed .....	579
Detecting permissions for camera access .....	580
Maximizing video quality .....	582
Monitoring playback conditions.....	583
Sending video to a server .....	584
Advanced topics .....	585
Flash Player compatibility with encoded FLV files .....	585
About configuring FLV files for hosting on a server .....	585
About targeting local FLV files on the Macintosh .....	586
Example: Video Jukebox.....	587
<b>Chapter 20: Working with sound .....</b>	<b>595</b>
Basics of working with sound.....	596
Understanding the sound architecture .....	599
Loading external sound files .....	600
Working with embedded sounds .....	603
Working with streaming sound files .....	604
Playing sounds.....	605
Pausing and resuming a sound .....	606
Monitoring playback.....	607
Stopping streaming sounds .....	609
Security considerations when loading and playing sounds .....	609
Controlling sound volume and panning .....	611
Working with sound metadata .....	613
Accessing raw sound data.....	614
Capturing sound input .....	617

Accessing a microphone . . . . .	617
Routing microphone audio to local speakers. . . . .	619
Altering microphone audio. . . . .	619
Detecting microphone activity . . . . .	620
Sending audio to and from a media server. . . . .	621
Example: Podcast Player . . . . .	622
Reading RSS data for a podcast channel . . . . .	623
Simplifying sound loading and playback using the SoundFacade class. . . . .	623
Displaying playback progress . . . . .	627
Pausing and resuming playback. . . . .	628
Extending the Podcast Player example . . . . .	629
<b>Chapter 21: Capturing user input . . . . .</b>	<b>631</b>
Basics of user input . . . . .	631
Capturing keyboard input . . . . .	633
Capturing mouse input . . . . .	636
Example: WordSearch . . . . .	641
<b>Chapter 22: Networking and communication . . . . .</b>	<b>645</b>
Basics of networking and communication . . . . .	646
Working with external data. . . . .	649
Connecting to other Flash Player instances. . . . .	656
Socket connections . . . . .	662
Storing local data . . . . .	668
Working with file upload and download . . . . .	671
Example: Building a Telnet client . . . . .	682
Example: Uploading and downloading files . . . . .	685
<b>Chapter 23: Client system environment . . . . .</b>	<b>695</b>
Basics of the client system environment. . . . .	695
Using the System class. . . . .	698
Using the Capabilities class . . . . .	699
Using the ApplicationDomain class . . . . .	700
Using the IME class . . . . .	704
Example: Detecting system capabilities . . . . .	709

<b>Chapter 24: Printing</b> .....	<b>715</b>
Basics of printing .....	716
Printing a page .....	718
Flash Player tasks and system printing .....	719
Setting size, scale, and orientation .....	722
Example: Multiple-page printing .....	725
Example: Scaling, cropping, and responding .....	727
<b>Chapter 25: Using the external API</b> .....	<b>731</b>
Basics of using the external API .....	732
External API requirements and advantages .....	735
Using the ExternalInterface class .....	736
Getting information about the external container .....	737
Calling external code from ActionScript .....	737
Calling ActionScript code from the container .....	739
The external API's XML format .....	740
Example: Using the external API with a web page container .....	742
Example: Using the external API with an ActiveX container .....	749
<b>Chapter 26: Flash Player security</b> .....	<b>757</b>
Flash Player security overview .....	758
Overview of permission controls .....	760
Security sandboxes .....	770
Restricting networking APIs .....	773
Full-screen mode security .....	775
Loading content .....	776
Cross-scripting .....	779
Accessing loaded media as data .....	783
Loading data .....	786
Loading embedded content from SWF files imported into a security domain .....	788
Working with legacy content .....	789
Setting LocalConnection permissions .....	790
Controlling access to scripts in a host web page .....	790
Shared objects .....	792
Camera, microphone, clipboard, mouse, and keyboard access .....	794
<b>Index</b> .....	<b>795</b>

# About this manual

This manual provides a foundation for developing applications in ActionScript™ 3.0. To best understand the ideas and techniques described, you should already be familiar with general programming concepts such as data types, variables, loops, and functions. You should also understand basic object-oriented programming concepts such as classes and inheritance. Prior knowledge of ActionScript 1.0 or ActionScript 2.0 is helpful but not necessary.

## Contents

<a href="#">Using this manual</a> .....	14
<a href="#">Accessing ActionScript documentation</a> .....	15
<a href="#">ActionScript learning resources</a> .....	17

# Using this manual

The chapters in this manual are organized into the following logical groups to help you better find related areas of ActionScript documentation:

Chapters	Description
Chapters 1 through 4, overview of ActionScript programming	Discusses core ActionScript 3.0 concepts, including language syntax, statements and operators, the ECMAScript edition 4 draft language specification, object-oriented ActionScript programming, and the new approach to managing display objects on the Adobe® Flash® Player 9 display list.
Chapters 5 through 10, core ActionScript 3.0 data types and classes	Describes top-level data types in ActionScript 3.0 that are also part of the ECMAScript draft specification.
Chapters 11 through 26, Flash Player APIs	Describes important features that are implemented in packages and classes specific to Adobe Flash Player 9, including event handling, networking and communications, file input and output, the external interface, the application security model, and more.

This manual also contains numerous sample files that demonstrate application programming concepts for important or commonly used classes. Sample files are packaged in ways to make them easier to load and use with Adobe® Flash® CS3 Professional and may include wrapper files. However, the core sample code is pure ActionScript 3.0 that you can use in whichever development environment you prefer.

ActionScript 3.0 can be written and compiled a number of ways, including:

- Using the Adobe Flex Builder 2 development environment
- Using any text editor and a command-line compiler, such as the one provided with Flex Builder 2
- Using the Adobe® Flash® CS3 Professional authoring tool

For more information about ActionScript development environments, see [Chapter 1](#), “Introduction to ActionScript 3.0.”

To understand the code samples in this manual, you don't need to have prior experience using integrated development environments for ActionScript, such as Flex Builder or the Flash authoring tool. You will, however, want to refer to the documentation for those tools to learn how to use them to write and compile ActionScript 3.0 code. For more information, see [“Accessing ActionScript documentation” on page 15](#).

## Accessing ActionScript documentation

Because this manual focuses on describing ActionScript 3.0, which is a rich and powerful object-oriented programming language, it does not extensively cover the application development process or workflow within a particular tool or server architecture. So in addition to *Programming ActionScript 3.0*, you'll want to consult other sources of documentation as you design, develop, test, and deploy ActionScript 3.0 applications.

### ActionScript 3.0 documentation

This manual familiarizes you with the concepts behind the ActionScript 3.0 programming language and gives you implementation details and samples illustrating important language features. However, this manual is not a complete language reference. For that, see the *ActionScript 3.0 Language and Components Reference*, which describes every class, method, property, and event in the language. The *ActionScript 3.0 Language and Components Reference* provides detailed reference information about the core language, Flash components (in the fl packages), and Flash Player APIs (in the flash packages).

### Flash documentation

If you use the Flash development environment, you may want to consult these manuals:

Book	Description
<i>Using Flash</i>	Describes how to develop your dynamic web applications in the Flash authoring environment
<i>Programming ActionScript 3.0</i>	Describes specific usage of the ActionScript 3.0 language and core Flash Player API
<i>ActionScript 3.0 Language and Components Reference</i>	Provides syntax, usage, and code examples for the Flash components and ActionScript 3.0 API
<i>Using ActionScript 3.0 Components</i>	Explains the details of using components to develop Flash applications

<b>Book</b>	<b>Description</b>
<i>Learning ActionScript 2.0 in Adobe Flash</i>	Provides an overview of ActionScript 2.0 syntax and explains how to use ActionScript 2.0 when working with different types of objects
<i>ActionScript 2.0 Language Reference</i>	Provides syntax, usage, and code examples for the Flash components and ActionScript 2.0 API
<i>Using ActionScript 2.0 Components</i>	Explains in detail how to use ActionScript 2.0 components to develop Flash applications
<i>ActionScript 2.0 Components Language Reference</i>	Describes each component available in the Version 2 Adobe Component Architecture, along with its API
<i>Extending Flash</i>	Describes the objects, methods, and properties available in the JavaScript API
<i>Getting Started with Flash Lite 2.x</i>	Explains how to use Adobe® Flash® Lite™ 2.x to develop applications and provides syntax, usage, and code examples for the ActionScript features that are available with Flash Lite 2.x
<i>Developing Flash Lite 2.x Applications</i>	Explains how to develop Flash Lite 2.x applications
<i>Introduction to Flash Lite 2.x ActionScript</i>	Introduces how to develop applications with Flash Lite 2.x and describes all the ActionScript features available to Flash Lite 2.x developers
<i>Flash Lite 2.x ActionScript Language Reference</i>	Provides syntax, usage, and code examples for the ActionScript 2.0 API that is available in Flash Lite 2.x
<i>Getting Started with Flash Lite 1.x</i>	Provides an introduction to Flash Lite 1.x and describes how to test your content using the Adobe® Device Central CS3 emulator
<i>Developing Flash Lite 1.x Applications</i>	Describes how to develop applications for mobile devices using Flash Lite 1.x
<i>Learning Flash Lite 1.x ActionScript</i>	Explains how to use ActionScript in Flash Lite 1.x applications and describes all the ActionScript features available with Flash Lite 1.x
<i>Flash Lite 1.x ActionScript Language Reference</i>	Provides the syntax and usage of ActionScript elements that are available with Flash Lite 1.x



# ActionScript learning resources

In addition to the content in these manuals, Adobe provides regularly updated articles, design ideas, and examples at the Adobe Developer Center and the Adobe Design Center.

## Adobe Developer Center

The Adobe Developer Center is your resource for up-to-the-minute information on ActionScript, articles about real-world application development, and information about important emerging issues. View the Developer Center at [www.adobe.com/devnet/](http://www.adobe.com/devnet/).

## Adobe Design Center

Learn the latest in digital design and motion graphics. Browse work by leading artists, discover new design trends, and hone your skills with tutorials, key workflows, and advanced techniques. Check back twice a month for fresh tutorials and articles, and inspirational gallery pieces. View the Design Center at [www.adobe.com/designcenter/](http://www.adobe.com/designcenter/).



# Introduction to ActionScript 3.0

This chapter provides an overview of ActionScript 3.0, the newest and most revolutionary version of ActionScript.

## Contents

About ActionScript .....	19
Advantages of ActionScript 3.0 .....	20
What's new in ActionScript 3.0 .....	21
Compatibility with previous versions .....	24

## About ActionScript

ActionScript is the programming language for the Adobe Flash Player run-time environment. It enables interactivity, data handling, and much more in Flash content and applications.

ActionScript is executed by the ActionScript Virtual Machine (AVM), which is part of Flash Player. ActionScript code is typically compiled into *bytecode format* (a sort of programming language that's written and understood by computers) by a compiler, such as the one built into Adobe Flash CS3 Professional or Adobe® Flex™ Builder™, or that is available in the Adobe® Flex™ SDK and the Flex™ Data Services. The bytecode is embedded in SWF files, which are executed by the Flash Player, the run-time environment.

ActionScript 3.0 offers a robust programming model that will be familiar to developers with a basic knowledge of object-oriented programming. Some of the key features of ActionScript 3.0 include the following:

- A new ActionScript Virtual Machine, called AVM2, that uses a new bytecode instruction set and provides significant performance improvements
- A more modern compiler code base that adheres much more closely to the ECMAScript (ECMA 262) standard and that performs deeper optimizations than previous versions of the compiler

- An expanded and improved application programming interface (API), with low-level control of objects and a true object-oriented model
- A core language based on the upcoming ECMAScript (ECMA-262) edition 4 draft language specification
- An XML API based on the ECMAScript for XML (E4X) specification (ECMA-357 edition 2). E4X is a language extension to ECMAScript that adds XML as a native data type of the language.
- An event model based on the Document Object Model (DOM) Level 3 Events Specification

## Advantages of ActionScript 3.0

ActionScript 3.0 goes beyond the scripting capabilities of previous versions of ActionScript. It is designed to facilitate the creation of highly complex applications with large data sets and object-oriented, reusable code bases. While ActionScript 3.0 is not required for content that runs in Adobe Flash Player 9, it opens the door to performance improvements that are only available with the AVM2, the new virtual machine. ActionScript 3.0 code can execute up to ten times faster than legacy ActionScript code.

The older version of ActionScript Virtual Machine, AVM1, executes ActionScript 1.0 and ActionScript 2.0 code. AVM1 is supported by Flash Player 9 for backward compatibility with existing and legacy content. For more information, see [“Compatibility with previous versions” on page 24](#).

# What's new in ActionScript 3.0

Although ActionScript 3.0 contains many classes and features that will be familiar to ActionScript programmers, ActionScript 3.0 is architecturally and conceptually different from previous versions of ActionScript. The enhancements in ActionScript 3.0 include new features of the core language and an improved Flash Player API that provides increased control of low-level objects.

## Core language features

The core language defines the basic building blocks of the programming language, such as statements, expressions, conditions, loops, and types. ActionScript 3.0 contains many new features that speed up the development process.

## Run-time exceptions

ActionScript 3.0 reports more error conditions than previous versions of ActionScript. Run-time exceptions are used for common error conditions, improving the debugging experience and enabling you to develop applications that handle errors robustly. Run-time errors can provide stack traces annotated with source file and line number information, helping you quickly pinpoint errors.

## Run-time types

In ActionScript 2.0, type annotations were primarily a developer aid; at run time, all values were dynamically typed. In ActionScript 3.0, type information is preserved at run time, and used for a number of purposes. Flash Player 9 performs run-time type checking, improving the system's type safety. Type information is also used to represent variables in native machine representations, improving performance and reducing memory usage.

## Sealed classes

ActionScript 3.0 introduces the concept of sealed classes. A sealed class possesses only the fixed set of properties and methods that were defined at compile time; additional properties and methods cannot be added. This enables stricter compile-time checking, resulting in more robust programs. It also improves memory usage by not requiring an internal hash table for each object instance. Dynamic classes are also possible using the `dynamic` keyword. All classes in ActionScript 3.0 are sealed by default, but can be declared to be dynamic with the `dynamic` keyword.

## Method closures

ActionScript 3.0 enables a method closure to automatically remember its original object instance. This feature is useful for event handling. In ActionScript 2.0, method closures would not remember what object instance they were extracted from, leading to unexpected behavior when the method closure was invoked. The `mx.utils.Delegate` class was a popular workaround, but it is no longer needed.

## ECMAScript for XML (E4X)

ActionScript 3.0 implements ECMAScript for XML (E4X), recently standardized as ECMA-357. E4X offers a natural, fluent set of language constructs for manipulating XML. In contrast to traditional XML-parsing APIs, XML with E4X performs like a native data type of the language. E4X streamlines the development of applications that manipulate XML by drastically reducing the amount of code needed. For more information about the ActionScript 3.0 implementation of E4X, see [Chapter 11, “Working with XML,” on page 343](#).

To view ECMA’s E4X specification, go to [www.ecma-international.org](http://www.ecma-international.org).

## Regular expressions

ActionScript 3.0 includes native support for regular expressions so that you can quickly search for and manipulate strings. ActionScript 3.0 implements support for regular expressions as they are defined in the ECMAScript (ECMA-262) edition 3 language specification.

## Namespaces

Namespaces are similar to the traditional access specifiers used to control visibility of declarations (`public`, `private`, `protected`). They work as custom access specifiers, which can have names of your choice. Namespaces are outfitted with a Universal Resource Identifier (URI) to avoid collisions, and are also used to represent XML namespaces when you work with E4X.

## New primitive types

ActionScript 2.0 has a single numeric type, `Number`, a double-precision, floating-point number. ActionScript 3.0 contains the `int` and `uint` types. The `int` type is a 32-bit signed integer that lets ActionScript code take advantage of the fast integer math capabilities of the CPU. The `int` type is useful for loop counters and variables where integers are used. The `uint` type is an unsigned, 32-bit integer type that is useful for RGB color values, byte counts, and more.

## Flash Player API features

The Flash Player API in ActionScript 3.0 contains many new classes that allow you to control objects at a low level. The architecture of the language is completely new and more intuitive. While there are too many new classes to cover in detail here, the following sections highlight some significant changes.

### DOM3 event model

Document Object Model Level 3 event model (DOM3) provides a standard way of generating and handling event messages so that objects within applications can interact and communicate, maintaining their state and responding to change. Patterned after the World Wide Web Consortium DOM Level 3 Events Specification, this model provides a clearer and more efficient mechanism than the event systems available in previous versions of ActionScript.

Events and error events are located in the `flash.events` package. The Flash components framework uses the same event model as the Flash Player API, so the event system is unified across the Flash platform.

### Display list API

The API for accessing the Flash Player display list—the tree that contains any visual elements in a Flash application—consists of classes for working with visual primitives in Flash.

The new `Sprite` class is a lightweight building block, similar to the `MovieClip` class but more appropriate as a base class for UI components. The new `Shape` class represents raw vector shapes. These classes can be instantiated naturally with the `new` operator and can be dynamically re-parented at any time.

Depth management is now automatic and built into Flash Player, rendering assignment of depth numbers unnecessary. New methods are provided for specifying and managing the z-order of objects.

### Handling dynamic data and content

ActionScript 3.0 contains mechanisms for loading and handling assets and data in your Flash application that are intuitive and consistent across the API. The new `Loader` class provides a single mechanism for loading SWF files and image assets and provides a way to access detailed information about loaded content. The `URLLoader` class provides a separate mechanism for loading text and binary data in data-driven applications. The `Socket` class provides a means to read and write binary data to server sockets in any format.

## Low-level data access

Various APIs provide low-level access to data that was never before available in ActionScript. For data that is being downloaded, the `URLStream` class, which is implemented by `URLLoader`, provides access to data as raw binary data while it is being downloaded. The `ByteArray` class lets you optimize reading, writing, and working with binary data. The new Sound API provides detailed control of sound through the `SoundChannel` and `SoundMixer` classes. New APIs dealing with security provide information about the security privileges of a SWF file or loaded content, enabling you to better handle security errors.

## Working with text

ActionScript 3.0 contains a `flash.text` package for all text-related APIs. The `TextLineMetrics` class provides detailed metrics for a line of text within a text field; it replaces the `TextField.getLineMetrics()` method in ActionScript 2.0. The `TextField` class contains a number of interesting new low-level methods that can provide specific information about a line of text or a single character in a text field. These methods include `getCharBoundaries()`, which returns a rectangle representing the bounding box of a character, `getCharIndexAtPoint()`, which returns the index of the character at a specified point, and `getFirstCharInParagraph()`, which returns the index of the first character in a paragraph. Line-level methods include `getLineLength()`, which returns the number of characters in a specified line of text, and `getLineText()`, which returns the text of the specified line. A new `Font` class provides a means to manage embedded fonts in SWF files.

## Compatibility with previous versions

As always, Flash Player provides full backward compatibility with previously published content. Any content that ran in previous versions of Flash Player runs in Flash Player 9. The introduction of ActionScript 3.0 in Flash Player 9, however, does present some challenges for interoperability between old and new content running in Flash Player 9. The compatibility issues include the following:

- A single SWF file cannot combine ActionScript 1.0 or 2.0 code with ActionScript 3.0 code.
- ActionScript 3.0 code can load a SWF file written in ActionScript 1.0 or 2.0, but it cannot access the SWF file's variables and functions.



- SWF files written in ActionScript 1.0 or 2.0 cannot load SWF files written in ActionScript 3.0. This means that SWF files authored in Flash 8 or Flex Builder 1.5 or earlier versions cannot load ActionScript 3.0 SWF files.

The only exception to this rule is that an ActionScript 2.0 SWF file can replace itself with an ActionScript 3.0 SWF file, as long as the ActionScript 2.0 SWF file hasn't previously loaded anything into any of its levels. An ActionScript 2.0 SWF file can do this through a call to `loadMovieNum()`, passing a value of 0 to the `level` parameter.

- In general, SWF files written in ActionScript 1.0 or 2.0 must be migrated if they are to work together with SWF files written in ActionScript 3.0. For example, say you created a media player using ActionScript 2.0. The media player loads various content that was also created using ActionScript 2.0. You cannot create new content in ActionScript 3.0 and load it in the media player. You must migrate the video player to ActionScript 3.0.

If, however, you create a media player in ActionScript 3.0, that media player can perform simple loads of your ActionScript 2.0 content.

The following table summarizes the limitations of previous versions of Flash Player in relation to loading new content and executing code, as well as the limitations for cross-scripting between SWF files written in different versions of ActionScript.

<b>Supported functionality</b>	<b>Run-time environment</b>		
	Flash Player 7	Flash Player 8	Flash Player 9
Can load SWFs published for	7 and earlier	8 and earlier	9 and earlier
Contains this AVM	AVM1	AVM1	AVM1 and AVM2
Runs SWFs written in ActionScript	1.0 and 2.0	1.0 and 2.0	1.0 and 2.0, and 3.0

<b>Supported functionality*</b>	<b>Content created in</b>	
	ActionScript 1.0 and 2.0	ActionScript 3.0
Can load content and execute code in content created in	ActionScript 1.0 and 2.0 only	ActionScript 1.0 and 2.0, and ActionScript 3.0
Can cross script content created in	ActionScript 1.0 and 2.0 only†	ActionScript 3.0‡

\* Content running in Flash Player 9 or later. Content running in Flash Player 8 or earlier can load, display, execute, and cross-script only ActionScript 1.0 and 2.0.

† ActionScript 3.0 through Local Connection.

‡ ActionScript 1.0 and 2.0 through LocalConnection.

# Getting started with ActionScript

This chapter is designed to get you started with ActionScript programming and give you the background you'll need to understand the concepts and examples in the rest of this manual. We'll begin with a discussion of basic programming concepts, described in the context of how to apply them in ActionScript. We'll also cover the essentials of how to organize and build an ActionScript application.

## Contents

Programming fundamentals.....	27
Working with objects.....	31
Common program elements .....	42
Example: Animation portfolio piece .....	44
Building applications with ActionScript.....	47
Creating your own classes .....	53
Example: Creating a basic application.....	56
Running subsequent examples.....	63

## Programming fundamentals

Since ActionScript is a programming language, it will help you learn ActionScript if you first understand a few general computer programming concepts.

### What computer programs do

First of all, it's useful to have a conceptual idea of what a computer program is and what it does. There are two main aspects to a computer program:

- A program is a series of instructions or steps for the computer to carry out.
- Each step ultimately involves manipulating some piece of information or data.

In a general sense, a computer program is just a list of step-by-step instructions that you give to the computer, which it performs one by one. Each individual instruction is known as a *statement*. As you'll see throughout this manual, in ActionScript, each statement is written with a semicolon at the end.

In essence, all that a given instruction in a program does is manipulate some bit of data that's stored in the computer's memory. In a simple case, you might instruct the computer to add two numbers and store the result in its memory. In a more complex case, imagine there is a rectangle drawn on the screen, and you want to write a program to move it somewhere else on the screen. The computer is keeping track of certain information about the rectangle—the x, y coordinates where it's located, how wide and tall it is, what color it is, and so forth. Each of those bits of information is stored somewhere in the computer's memory. A program to move the rectangle to a different location would have steps like “change the x coordinate to 200; change the y coordinate to 150” (in other words, specifying new values to be used for the x and y coordinates). Of course, the computer does something with this data to actually turn those numbers into the image that appears on the computer screen; but for the level of detail we're interested in, it's enough to know that the process of “moving a rectangle on the screen” really just involves changing bits of data in the computer's memory.

## Variables and constants

Since programming mainly involves changing pieces of information in the computer's memory, there needs to be a way to represent a single piece of information in the program. A *variable* is a name that represents a value in the computer's memory. As you write statements to manipulate values, you write the variable's name in place of the value; any time the computer sees the variable name in your program, it looks in its memory and uses the value it finds there. For example, if you have two variables named `value1` and `value2`, each containing a number, to add those two numbers you could write the statement:

```
value1 + value2
```

When it's actually carrying out the steps, the computer will look to see the values in each variable, and add them together.

In ActionScript 3.0, a variable actually consists of three different parts:

- The variable's name
- The type of data that can be stored in the variable
- The actual value stored in the computer's memory

We've just discussed how the computer uses the name as a placeholder for the value. The data type is also important. When you create a variable in ActionScript, you specify the specific type of data that it will hold; from that point on, your program's instructions can store only that type of data in the variable, and you can manipulate the value using the particular characteristics associated with its data type. In ActionScript, to create a variable (known as *declaring* the variable), you use the `var` statement:

```
var value1:Number;
```

In this case, we've told the computer to create a variable named `value1`, which will hold only Number data ("Number" is a specific data type defined in ActionScript). You can also store a value in the variable right away:

```
var value2:Number = 17;
```

In the Adobe Flash CS3 Professional, there is another way to declare a variable. When you place a movie clip symbol, button symbol, or text field on the Stage, you can give it an instance name in the Property inspector. Behind the scenes, Flash creates a variable with the same name as the instance name, which you can use in your ActionScript code to refer to that Stage item. So, for example, if you have a movie clip symbol on the Stage and you give it the instance name `rocketShip`, whenever you use the variable `rocketShip` in your ActionScript code, you will in fact be manipulating that movie clip.

## Data types

In ActionScript, there are many data types that you can use as the data type of the variables you create. Some of these can be thought of as "simple" or "fundamental" data types:

- String: a textual value, like a name or the text of a book chapter
- Numeric: ActionScript 3.0 includes three specific data types for numeric data:
  - Number: any numeric value, including values with or without a fraction
  - int: an integer (a whole number without a fraction)
  - uint: an "unsigned" integer, meaning a whole number that can't be negative
- Boolean: a true-or-false value, such as whether a switch is on or whether two values are equal

The simple data types represent a single piece of information: for example, a single number or a single sequence of text. However, the majority of the data types defined in ActionScript could be described as complex data types, because they represent a set of values grouped together. For example, a variable with the data type `Date` represents a single value—a moment in time. Nevertheless, that date value is actually represented as several values: the day, month, year, hours, minutes, seconds, and so on, all of which are individual numbers. So while we think of a date as a single value (and we can treat it as a single value by creating a `Date` variable), internally the computer thinks of it as a group of several values that, put together, define a single date.

Most of the built-in data types, as well as data types defined by programmers, are complex data types. Some of the complex data types you might recognize are:

- `MovieClip`: a movie clip symbol
- `TextField`: a dynamic or input text field
- `SimpleButton`: a button symbol
- `Date`: information about a single moment in time (a date and time)

Two words that are often used as synonyms for data type are class and object. A *class* is simply the definition of a data type—it's like a template for all objects of the data type, like saying “all variables of the `Example` data type have these characteristics: A, B, and C.” An *object*, on the other hand, is just an actual instance of a class; a variable whose data type is `MovieClip` could be described as a `MovieClip` object. The following are different ways of saying the same thing:

- The data type of the variable `myVariable` is `Number`.
- The variable `myVariable` is a `Number` instance.
- The variable `myVariable` is a `Number` object.
- The variable `myVariable` is an instance of the `Number` class.

# Working with objects

ActionScript is what's known as an object-oriented programming language. Object-oriented programming is simply an approach to programming—really nothing more than a way to organize the code in a program, using objects.

Earlier we defined a computer program as a series of steps or instructions that the computer performs. Conceptually, then, we might imagine a computer program as just a single long list of instructions. However, in object-oriented programming, the program instructions are divided among different objects—the code is grouped into chunks of functionality, so related types of functionality or related pieces of information are grouped together in one container.

In fact, if you've worked with symbols in Flash, you're already used to working with objects. Imagine you've defined a movie clip symbol—let's say it's a drawing of a rectangle—and you've placed a copy of it on the Stage. That movie clip symbol is also (literally) an object in ActionScript; it's an instance of the `MovieClip` class.

There are various characteristics of the movie clip that you can modify. For example, when it's selected there are values you can change in the Property inspector, like its x coordinate, or its width, or various color adjustments like changing its alpha (transparency), or applying a drop-shadow filter to it. Other Flash tools let you make more changes, like using the Free Transform tool to rotate the rectangle. All of these things that you can do to modify a movie clip symbol in the Flash authoring environment are also things you can do in ActionScript by changing the pieces of data that are all put together into a single bundle called a `MovieClip` object.

In ActionScript object-oriented programming, there are three types of characteristics that any class can include:

- Properties
- Methods
- Events

Together, these elements are used to manage the pieces of data used by the program and to decide what actions are carried out and in what order.

## Properties

A property represents one of the pieces of data that are bundled together in an object. A song object might have properties named `artist` and `title`; the `MovieClip` class has properties like `rotation`, `x`, `width`, and `alpha`. You work with properties like individual variables—in fact, you might think of properties as simply the “child” variables contained in an object.

Here are some examples of ActionScript code that uses properties. This line of code moves the MovieClip named `square` to the x coordinate 100 pixels:

```
square.x = 100;
```

This code uses the `rotation` property to make the `square` MovieClip rotate to match the rotation of the `triangle` MovieClip:

```
square.rotation = triangle.rotation;
```

This code alters the horizontal scale of the `square` MovieClip so that it's one-and-a-half times wider than it used to be:

```
square.scaleX = 1.5;
```

Notice the common structure: you use a variable (`square`, `triangle`) as the name of the object, followed by a period (`.`) and then the name of the property (`x`, `rotation`, `scaleX`). The period, known as the *dot operator*, is used to indicate that you're accessing one of the child elements of an object. The whole structure together, "variable name-dot-property name," is used like a single variable, as a name for a single value in the computer's memory.

## Methods

A *method* is an action that can be performed by an object. For example, if you've made a movie clip symbol in Flash with several keyframes and animation on its timeline, that movie clip can play, or stop, or be instructed to move the playhead to a particular frame.

This code instructs the MovieClip named `shortFilm` to start playing:

```
shortFilm.play();
```

This line makes the MovieClip named `shortFilm` stop playing (the playhead stops in place, like pausing a video):

```
shortFilm.stop();
```

This code makes a MovieClip named `shortFilm` move its playhead to Frame 1 and stop playing (like rewinding a video):

```
shortFilm.gotoAndStop(1);
```



As you can see, methods, like properties, are accessed by writing the object's name (a variable), then a period, and then the name of the method followed by parentheses. The parentheses are the way that you indicate that you're *calling* the method—or in other words, instructing the object to perform that action. Sometimes values (or variables) are placed in the parentheses, as a way to pass along additional information that is needed to carry out the action. These values are known as method *parameters*. For example, the `gotoAndStop()` method needs to know which frame it should go to, so it requires a single parameter in the parentheses. Other methods, like `play()` and `stop()`, are self-explanatory, so they don't require extra information. Nevertheless, they are still written with parentheses.

Unlike properties (and variables), methods aren't used as value placeholders. However, some methods can perform calculations and return a result that can be used like a variable. For example, the `Number` class's `toString()` method converts the numeric value to its text representation:

```
var numericData:Number = 9;
var textData:String = numericData.toString();
```

For instance, you would use the `toString()` method if you wanted to display the value of a `Number` variable in a text field on the screen. The `TextField` class's `text` property (which represents the actual text content displayed on the screen) is defined as a `String`, so it can contain only text values. This line of code converts the numeric value in the variable `numericData` to text, and then makes it show up on the screen in the `TextField` object named `calculatorDisplay`:

```
calculatorDisplay.text = numericData.toString();
```

## Events

We've described a computer program as a series of instructions that the computer carries out step-by-step. Some simple computer programs consist of nothing more than that—a few steps which the computer carries out, at which point the program ends. However, `ActionScript` programs are designed to keep running, waiting for user input or other things to happen. Events are the mechanism that determines which instructions the computer carries out and when.

In essence, *events* are things that happen that `ActionScript` is aware of and can respond to. Many events are related to user interaction—like a user clicking a button, or pressing a key on the keyboard—but there are also other types of events. For example, if you use `ActionScript` to load an external image, there is an event that can let you know when the image has finished loading. In essence, when an `ActionScript` program is running, Adobe Flash Player just sits and waits for certain things to happen, and when those things happen, it runs the specific `ActionScript` code that you've specified for those events.

## Basic event handling

The technique for specifying certain actions that should be performed in response to particular events is known as *event handling*. When you are writing ActionScript code to perform event handling, there are three important elements you'll want to identify:

- The event source: Which object is the one the event is going to happen to? For instance, which button will be clicked, or which Loader object is loading the image? The event source is also known as the *event target*, because it's the object where the event is targeted by Flash Player (where the event actually happens).
- The event: What is the thing that is going to happen, the thing that you want to respond to? This is important to identify, because many objects trigger several events.
- The response: What step(s) do you want performed when the event happens?

Any time you write ActionScript code to handle events, it will include these three elements, and the code will follow this basic structure (elements in bold are placeholders you'd fill in for your specific case):

```
function eventResponse(eventObject:EventType):void
{
    // Actions performed in response to the event go here.
}
```

```
eventSource.addEventListener(EventType.EVENT_NAME, eventResponse);
```

This code does two things. First, it defines a function, which is the way to specify the actions you want performed in response to the event. Next, it calls the `addEventListener()` method of the source object, in essence “subscribing” the function to the specified event so that when the event happens, the function's actions are carried out. We'll consider each of these parts in more detail.

A *function* provides a way for you to group actions together, with a single name that is like a shortcut name to carry out the actions. A function is identical to a method except that it isn't necessarily associated with a specific class (in fact, a method could be defined as a function that is associated with a particular class). When you're creating a function for event handling, you must choose the name for the function (named `eventResponse` in this case), and you must also specify one parameter (named `eventObject` in this example). Specifying a function parameter is like declaring a variable, so you also have to indicate the data type of the parameter. There is an ActionScript class defined for each event, and the data type you specify for the function parameter is always the class associated with the particular event you want to respond to. Finally, between the opening and closing curly braces (`{ ... }`), you write the instructions you want the computer to carry out when the event happens.

Once you've written the event-handling function, you need to tell the event source object (the object that the event happens to—for example, the button) that you want your function to be called when the event happens. You do this by calling the `addEventListener()` method of that object (all objects that have events also have an `addEventListener()` method). The `addEventListener()` method takes two parameters:

- First, the name of the specific event you want to respond to. Once again, each event is affiliated with a specific class, and that class will have a special value predefined for each event—sort of like the event's own unique name, which you should use for the first parameter.
- Second, the name of your event response function. Note that a function name is written without parentheses when it's passed as a parameter.

## Examining the event-handling process

The following is a step-by-step description of the process that happens when you create an event listener. In this case, it's an example of creating a listener function that is called when an object named `myButton` is clicked.

The actual code written by the programmer is as follows:

```
function eventResponse(event:MouseEvent):void
{
    // Actions performed in response to the event go here.
}

myButton.addEventListener(MouseEvent.CLICK, eventResponse);
```

Here is how this code would actually work when it's running in Flash Player:

1. When the SWF file loads, Flash Player makes note of the fact that there's a function named `eventResponse()`.



2. Flash Player then runs the code (specifically, the lines of code that aren't in a function). In this case that's only one line of code: calling the `addEventListener()` method on the event source object (named `myButton`) and passing the `eventResponse` function as a parameter.

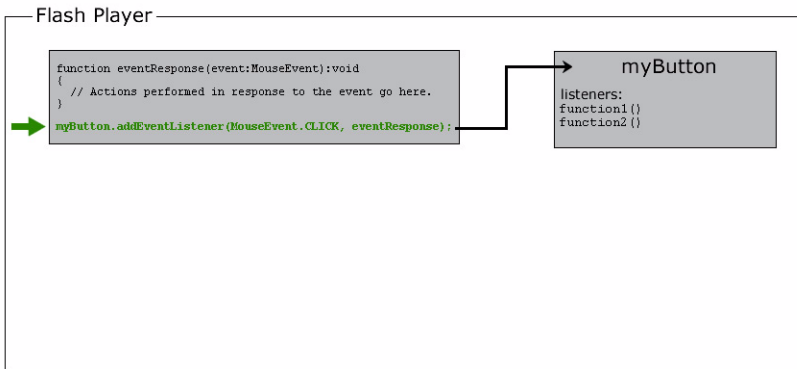

- a. Internally, `myButton` has a list of functions that are listening to each of its events, so when its `addEventListener()` method is called, `myButton` stores the `eventResponse()` function in its list of event listeners.

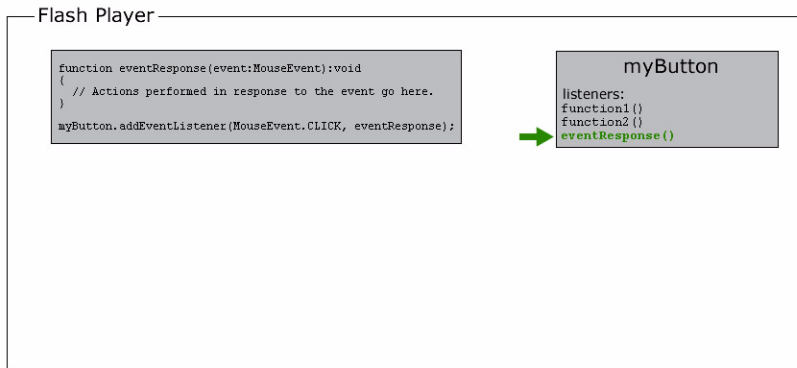

3. At some point, the user clicks the `myButton` object, triggering its `click` event (identified as `MouseEvent.CLICK` in the code).

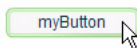

At that point, the following occurs:

- a. Flash Player creates an object, an instance of the class associated with the event in question (MouseEvent in this example). For many events this will be an instance of the Event class; for mouse events it will be a MouseEvent instance; and for other events it will be an instance of the class that's associated with that event. This object that's created is known as the *event object*, and it contains specific information about the event that happened: what type of event it is, where it happened, and other event-specific information if applicable.

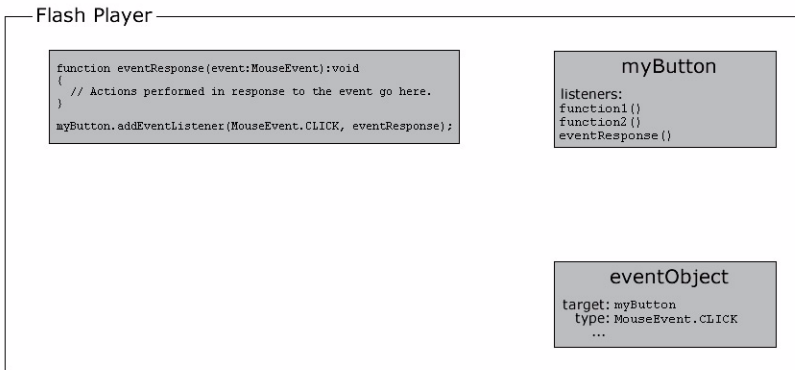

- b. Flash Player then looks at the list of event listeners stored by myButton. It goes through these functions one by one, calling each function and passing the event object to the function as a parameter. Since the eventResponse() function is one of myButton's listeners, as part of this process Flash Player calls the eventResponse() function.

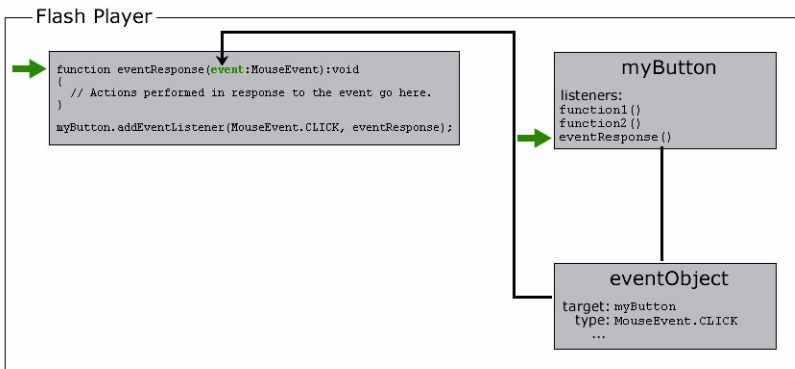

- c. When the `eventResponse()` function is called, the code in that function runs, so your specified actions are carried out.

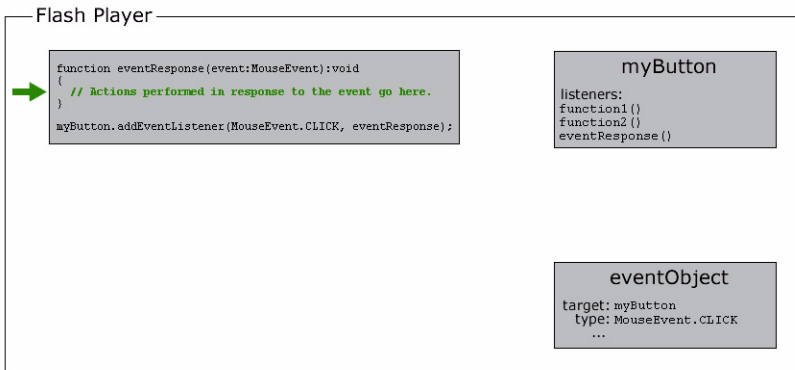

## Event-handling examples

Here are a few more concrete examples of events to give you an idea of some of the common event elements and possible variations available when you write event-handling code:

- Clicking a button to start the current movie clip playing. In the following example, `playButton` is the instance name of the button, and `this` is a special name meaning “the current object”:

```
this.stop();
```

```
function playMovie(event:MouseEvent):void
{
  this.play();
}
```

```
playButton.addEventListener(MouseEvent.CLICK, playMovie);
```

- Detecting typing in a text field. In this example, `entryText` is an input text field, and `outputText` is a dynamic text field:

```
function updateOutput(event:TextEvent):void
{
  var pressedKey:String = event.text;
  outputText.text = "You typed: " + pressedKey;
}
```

```
entryText.addEventListener(TextEvent.TEXT_INPUT, updateOutput);
```

- Clicking a button to navigate to a URL. In this case, `linkButton` is the instance name of the button:

```
function gotoAdobeSite(event:MouseEvent):void
{
    var adobeURL:URLRequest = new URLRequest("http://www.adobe.com/");
    navigateToURL(adobeURL);
}

linkButton.addEventListener(MouseEvent.CLICK, gotoAdobeSite);
```

## Creating object instances

Of course, before you can use an object in ActionScript, the object has to exist in the first place. One part of creating an object is declaring a variable; however, declaring a variable only creates an empty place in the computer's memory. You must assign an actual value to the variable—that is, create an object and store it in the variable—before you attempt to use or manipulate it. The process of creating an object is known as *instantiating* the object—in other words, creating an instance of a particular class.

One simple way to create an object instance doesn't involve ActionScript at all. In Flash, when you place a movie clip symbol, button symbol, or text field on the Stage, and you assign it an instance name in the Property inspector, Flash automatically declares a variable with that instance name, creates an object instance, and stores that object in the variable. Likewise, in Adobe Flex Builder when you create a component in Macromedia® MXML™ from Adobe (either by coding an MXML tag or by placing the component on the editor in Design mode) and assign an ID to that component (in the MXML markup or in the Flex Properties view), that ID becomes the name of an ActionScript variable, and an instance of the component is created and stored in the variable.

However, you won't always want to create an object visually. There are also several ways you can create object instances using only ActionScript. First, with several ActionScript data types, you can create an instance using a *literal expression*—a value written directly into the ActionScript code. Here are some examples:

- Literal numeric value (enter the number directly):

```
var someNumber:Number = 17.239;
var someNegativeInteger:int = -53;
var someUInt:uint = 22;
```

- Literal String value (surround the text with double quotation marks):

```
var firstName:String = "George";
var soliloquy:String = "To be or not to be, that is the question...";
```



- Literal Boolean value (use the literal values `true` or `false`):

```
var niceWeather:Boolean = true;
var playingOutside:Boolean = false;
```

- Literal XML value (enter the XML directly):

```
var employee:XML = <employee>
    <firstName>Harold</firstName>
    <lastName>Webster</lastName>
</employee>;
```

ActionScript also defines literal expressions for the `Array`, `RegExp`, `Object`, and `Function` data types. For details on these classes, see [“Working with arrays” on page 223](#), [“Using regular expressions” on page 285](#), and [“Object data type” on page 97](#).

For any other data type, to create an object instance you use the `new` operator with the class name, like this:

```
var raceCar:MovieClip = new MovieClip();
var birthday>Date = new Date(2006, 7, 9);
```

Creating an object using the `new` operator is often referred to as “calling the class’s constructor.” A *constructor* is a special method that is called as part of the process of creating an instance of a class. Notice that when you create an instance in this way, you put parentheses after the class name, and sometimes you specify parameter values—two things that you also do when calling a method.

NOTE

Even for those data types that let you create instances using a literal expression, you can still use the `new` operator to create an object instance. For instance, these two lines of code do exactly the same thing:

```
var someNumber:Number = 6.33;
var someNumber:Number = new Number(6.33);
```

It’s important to be familiar with the `new ClassName()` way of creating objects. If you need to create an instance of any ActionScript data type that doesn’t have a visual representation (and hence can’t be created by placing an item on the Flash Stage or the Design mode of Flex Builder’s MXML editor), you can only do so by creating the object directly in ActionScript using the `new` operator.

In Flash specifically, the `new` operator can also be used to create an instance of a movie clip symbol that is defined in the Library but isn’t placed on the Stage. For more about this, see [“Creating MovieClip objects with ActionScript” on page 498](#).

# Common program elements

In addition to declaring variables, creating object instances, and manipulating objects using their properties and methods, there are a few other building blocks that you use to create an ActionScript program.

## Operators

*Operators* are special symbols (or occasionally words) that are used to perform calculations. They are mostly used for math operations, and also used when comparing values to each other. As a general rule, an operator uses one or more values and “works out” to a single result. For example:

- The addition operator (+) adds two values together, resulting in a single number:  

```
var sum:Number = 23 + 32;
```
- The multiplication operator (\*) multiplies one value by another, resulting in a single number:  

```
var energy:Number = mass * speedOfLight * speedOfLight;
```
- The equality operator (==) compares two values to see if they are equal, resulting in a single true-or-false (Boolean) value:  

```
if (dayOfWeek == "Wednesday")  
{  
    takeOutTrash();  
}
```

As shown here, the equality operator and the other “comparison” operators are most commonly used with the `if` statement to determine if certain instructions should be carried out or not.

For more details and examples of using operators, see [“Operators” on page 109](#).

## Comments

As you’re writing ActionScript, you’ll often want to leave notes to yourself, perhaps explaining how certain lines of code work or why you made a particular choice. *Code comments* are a tool you can use to write text that the computer should ignore in your code. ActionScript includes two kinds of comments:

- **Single-line comment:** A single-line comment is designated by placing two slashes anywhere on a line. Everything after the slashes up to the end of that line is ignored by the computer:

```
// This is a comment; it's ignored by the computer.  
var age:Number = 10; // Set the age to 10 by default.
```

- **Multiline comments:** A multiline comment includes a starting comment marker (`/*`), then the comment content, and an ending comment marker (`*/`). Everything between the starting and ending markers is ignored by the computer, regardless of how many lines the comment spans:

```
/*  
This might be a really long description, perhaps describing what  
a particular function is used for or explaining a section of code.  
  
In any case, these lines are all ignored by the computer.  
*/
```

Another common use of comments is to temporarily “turn off” one or more lines of code—for example, if you’re testing out a different way of doing something, or trying to figure out why certain ActionScript code isn’t working the way you expect.

## Flow control

Many times in a program, you will want to repeat certain actions, perform only certain actions and not others, perform alternative actions depending on certain conditions, and so on. *Flow control* is the control over which actions are performed. There are several types of flow control elements available in ActionScript.

- **Functions:** Functions are like shortcuts—they provide a way to group a series of actions under a single name, and can be used to perform calculations. Functions are particularly important for handling events, but are also used as a general tool for grouping a series of instructions. For more on functions, see [“Functions” on page 122](#).
- **Loops:** Loop structures let you designate a set of instructions that the computer will perform a set number of times or until some condition changes. Often loops are used to manipulate several related items, using a variable whose value changes each time the computer works through the loop. For more on loops, see [“Looping” on page 119](#).
- **Conditional statements:** Conditional statements provide a way to designate certain instructions that are carried out only under certain circumstances or to provide alternative sets of instructions for different conditions. The most common type of conditional statement is the `if` statement. The `if` statement checks a value or expression in its parentheses. If the value is `true`, the lines of code in curly braces are carried out; otherwise, they are ignored. For example:

```
if (age < 20)  
{  
    // show special teenager-targeted content  
}
```

The `if` statement's companion, the `else` statement, lets you designate alternative instructions to be performed if the condition is not true:

```
if (username == "admin")
{
    // do some administrator-only things, like showing extra options
}
else
{
    // do some non-administrator things
}
```

For more on conditional statements, see [“Conditionals” on page 117](#).

## Example: Animation portfolio piece

This example is designed to give you a first opportunity to see how you can piece together bits of ActionScript into a complete, if not ActionScript-heavy, application. The animation portfolio piece is an example of how you could take an existing linear animation (for example, a piece created for a client) and add some minor interactive elements appropriate for incorporating that animation into an online portfolio. The interactive behavior that we'll add to the animation will include two buttons the viewer can click: one to start the animation, and one to navigate to a separate URL (such as the portfolio menu or the author's home page).

The process of creating this piece can be divided into these main sections:

1. Prepare the FLA file for adding ActionScript and interactive elements.
2. Create and add the buttons.
3. Write the ActionScript code.
4. Test the application.

## Preparing to add interactivity

Before we can add interactive elements to our animation, it's helpful to set up the FLA file by creating some places to add our new content. This includes creating actual space on the Stage where buttons can be placed, and also creating “space” in the FLA file for keeping different items separate.

### To set up your FLA for adding interactive elements:

1. If you don't already have a linear animation to which you'll be adding interactivity, create a new FLA file with a simple animation such as a single motion tween or shape tween. Otherwise, open the FLA file containing the animation that you're showcasing in the project, and save it with a new name to create a new working file.
2. Decide where on the screen you'll want the two buttons to appear (one to start the animation and one to link to the author portfolio or home page). If necessary, clear or add some space on the Stage for this new content. If the animation doesn't already have one, you might want to create a splash screen on the first frame (you'll probably want to shift the animation over so it starts on Frame 2 or later).
3. Add a new layer, above the other layers in the Timeline, and rename it **buttons**. This will be the layer where you'll add the buttons.
4. Add a new layer, above the buttons layer, and name it **actions**. This will be where you'll add ActionScript code to your application.

## Creating and adding buttons

Next we'll need to actually create and position the buttons that will form the center of our interactive application.

### To create and add buttons to the FLA:

1. Using the drawing tools, create the visual appearance of your first button (the "play" button) on the buttons layer. For example, you might draw a horizontal oval with text on top of it.
2. Using the Selection tool, select all the graphic parts of the single button.
3. From the main menu, choose **Modify > Convert To Symbol**.
4. In the dialog box, choose **Button** as the symbol type, give the symbol a name, and click **OK**.
5. With the button selected, in the Property inspector give the button the instance name `playButton`.
6. Repeat steps 1 through 5 to create the button that will take the viewer to the author's home page. Name this button `homeButton`.

## Writing the code

The ActionScript code for this application can be divided into three sets of functionality, although it will all be entered in the same place. The three things the code needs to do are:

- Stop the playhead as soon as the SWF file loads (when the playhead enters Frame 1).

- Listen for an event to start the SWF file playing when the user clicks the play button.
- Listen for an event to send the browser to the appropriate URL when the user clicks the author home page button.

### To create code to stop the playhead when it enters Frame 1:

1. Select the keyframe on Frame 1 of the actions layer.
2. To open the Actions panel, from the main menu, choose Window > Actions.
3. In the Script pane, enter the following code:

```
stop();
```

### To write code to start the animation when the play button is clicked:

1. At the end of the code entered in the previous steps, add two empty lines.
2. Enter the following code at the bottom of the script:

```
function startMovie(event:MouseEvent):void  
{  
    this.play();  
}
```

This code defines a function called `startMovie()`. When `startMovie()` is called, it causes the main timeline to start playing.

3. On the line following the code added in the previous step, enter this line of code:

```
playButton.addEventListener(MouseEvent.CLICK, startMovie);
```

This line of code registers the `startMovie()` function as a listener for `playButton`'s click event. In other words, it makes it so that whenever the button named `playButton` is clicked, the `startMovie()` function is called.

### To write code to send the browser to a URL when the home page button is clicked:

1. At the end of the code entered in the previous steps, add two empty lines.
2. Enter this code at the bottom of the script:

```
function gotoAuthorPage(event:MouseEvent):void  
{  
    var targetURL:URLRequest = new URLRequest("http://example.com/");  
    navigateToURL(targetURL);  
}
```

This code defines a function called `gotoAuthorPage()`. This function first creates a `URLRequest` instance representing the URL `http://example.com/`, and then passes that URL to the `navigateToURL()` function, causing the user's browser to open that URL.

3. On the line following the code added in the previous step, enter this line of code:

```
homeButton.addEventListener(MouseEvent.CLICK, gotoAuthorPage);
```

This line of code registers the `gotoAuthorPage()` function as a listener for `homeButton`'s `click` event. In other words, it makes it so that whenever the button named `homeButton` is clicked, the `gotoAuthorPage()` function is called.

## Testing the application

At this point, the application should be completely functional. Let's test it to make sure that's the case.

### To test the application:

1. From the main menu, choose **Control > Test Movie**. Flash creates the SWF file and opens it in a Flash Player window.
2. Try both the buttons to make sure they do what you expect them to.
3. If the buttons don't work, here are some things to check for:
  - Do the buttons both have distinct instance names?
  - Do the `addEventListener()` method calls use the same names as the buttons' instance names?
  - Are the correct event names used in the `addEventListener()` method calls?
  - Is the correct parameter specified for each of the functions? (Both should have a single parameter with the data type `MouseEvent`.)

All of these and most other possible mistakes should give an error message either when you choose the **Test Movie** command or when you click the button. Look in the **Compiler Errors** panel for compiler errors (the ones that happen when you first choose **Test Movie**), and check the **Output** panel for run-time errors (errors which happen while the SWF is playing—such as when you click a button).

## Building applications with ActionScript

The process of writing ActionScript to build an application involves more than just knowing the syntax and the names of the classes you'll use. While most of the information in this manual is geared towards those two topics (syntax and using ActionScript classes), you'll also want to know some information such as what programs can be used for writing ActionScript, how ActionScript code can be organized and included in an application, and what steps you should follow in developing an ActionScript application.

## Options for organizing your code

You can use ActionScript 3.0 code to power everything from simple graphics animations to complex client-server transaction processing systems. Depending on the type of application you're building, you may prefer to use one or more of these different ways of including ActionScript in your project.

### Storing code in frames in a Flash timeline

In the Flash authoring environment, you can add ActionScript code to any frame in a timeline. This code will be executed while the movie is playing back, when the playhead enters that frame.

Placing ActionScript code in frames provides a simple way to add behaviors to applications built in the Flash authoring tool. You can add code to any frame in the main timeline or to any frame in the timeline of any MovieClip symbol. However, this flexibility comes with a cost. When you build larger applications, it becomes easy to lose track of which frames contain which scripts. This can make the application more difficult to maintain over time.

Many developers simplify the organization of their ActionScript code in the Flash authoring tool by placing code only in the first frame of a timeline, or on a specific layer in the Flash document. This makes it easier to locate and maintain the code in your Flash FLA files. However, in order to use the same code in another Flash project, you must copy and paste the code into the new file.

If you want to be able to use your ActionScript code in other Flash projects in the future, you will want to store your code in external ActionScript files (text files with the .as extension).

### Storing code in ActionScript files

If your project involves significant ActionScript code, the best way to organize your code is in separate ActionScript source files (text files with the .as extension). An ActionScript file can be structured in one of two ways, depending on how you intend to use it in your application.

- **Unstructured ActionScript code:** Lines of ActionScript code, including statements or function definitions, written as though they were entered directly in a timeline script, MXML file, and so on.



ActionScript written in this way can be accessed using the `include` statement in ActionScript, or the `<mx:Script>` tag in Adobe Flex MXML. The ActionScript `include` statement causes the contents of an external ActionScript file to be inserted at a specific location and within a given scope in a script, as if it were entered there directly. In the Flex MXML language, the `<mx:Script>` tag lets you specify a source attribute that identifies an external ActionScript file to be loaded at that point in the application. For example, the following tag will load an external ActionScript file named `Box.as`:

```
<mx:Script source="Box.as" />
```

- ActionScript class definition: A definition of an ActionScript class, including its method and property definitions.

When you define a class, you can access the ActionScript code in the class by creating an instance of the class and using its properties, methods, and events, just as you would with any of the built-in ActionScript classes. This requires two parts:

- Use the `import` statement to specify the full name of the class, so the ActionScript compiler knows where to find it. For example, if you want to use the `MovieClip` class in ActionScript, you first need to import that class using its full name, including package and class:

```
import flash.display.MovieClip;
```

Alternatively, you can import the package that contains the `MovieClip` class, which is equivalent to writing separate `import` statements for each class in the package:

```
import flash.display.*;
```

The only exceptions to the rule that a class must be imported if you refer to that class in your code are the top-level classes, which are not defined in a package.

NOTE

In Flash, for scripts attached to frames on the Timeline, the built-in classes (in the `flash.*` packages) are automatically imported. However, when you write your own classes, or if you're working with Flash authoring components (the `fl.*` packages) or if you're working in Flex, you will need to explicitly import any class in order to write code that creates instances of that class.

- Write code which specifically refers to the class name (usually declaring a variable with that class as its data type, and creating an instance of the class to store in the variable). By referring to another class name in ActionScript code, you tell the compiler to load the definition of that class. For example, given an external class called `Box`, this statement causes a new instance of the `Box` class to be created:

```
var smallBox:Box = new Box(10,20);
```

When the compiler comes across the reference to the `Box` class for the first time, it searches the loaded source code to locate the `Box` class definition.

## Choosing the right tool

Depending on the needs of your project and the resources you have available to you, you may want to use one of several tools (or multiple tools in conjunction with each other) for writing and editing your ActionScript code.

### Flash authoring tool

In addition to its graphics and animation creation capabilities, Adobe Flash CS3 Professional includes tools for working with ActionScript code, either attached to elements in a FLA file or in external ActionScript-only files. The Flash authoring tool is ideal for projects that involve significant animation or video or where you want to create most of the graphic assets yourself, particularly projects with minimal user interaction or functionality requiring ActionScript. Another reason you may choose to use the Flash authoring tool to develop your ActionScript project is if you prefer to create visual assets and write code in the same application. You may also want to use Flash authoring if you want to use pre-built user interface components, but smaller SWF size or easier visual skinning are key priorities for your project.

Adobe Flash CS3 Professional includes two tools for writing ActionScript code:

- **Actions panel:** Available when working in a FLA file, this panel allows you to write ActionScript code attached to frames on a timeline.
- **Script window:** The Script window is a dedicated text editor for working with ActionScript (.as) code files.

### Flex Builder

Adobe Flex Builder is the premier tool for creating projects with the Flex framework. In addition to its visual layout and MXML editing tools, Flex Builder also includes a full-featured ActionScript editor, so it can be used to create Flex or ActionScript-only projects. Flex applications have several benefits, including a rich set of pre-built user interface controls, flexible dynamic layout controls, and built-in mechanisms for working with external data sources and linking external data to user interface elements. However, because of the additional code required to provide these features, Flex applications can have a larger SWF file size and can't be completely re-skinned as easily as their Flash counterparts.

Use Flex Builder if you are creating full-featured, data-driven rich Internet applications with Flex, and you want to edit ActionScript code, edit MXML code, and lay out your application visually, all within a single tool.

## Third-party ActionScript editor

Because ActionScript (.as) files are stored as simple text files, any program that is capable of editing plain text files can be used to write ActionScript files. In addition to Adobe's ActionScript products, several third-party text editing programs with ActionScript-specific capabilities have been created. You can write an MXML file or ActionScript classes using any text editor program. You can then create a SWF application (either a Flex or an ActionScript-only application) from those files using the Flex SDK, which includes the Flex framework classes as well as the Flex compiler. Alternatively, many developers use a third-party ActionScript editor for writing ActionScript classes, in combination with the Flash authoring tool for creating graphical content.

You might choose to use a third-party ActionScript editor if:

- You prefer to write ActionScript code in a separate program in conjunction with designing visual elements in Flash.
- You use an application for non-ActionScript programming (such as creating HTML pages or building applications in another programming language), and you want to use the same application for your ActionScript coding as well.
- You want to create ActionScript-only or Flex projects using the Flex SDK without the expense of Flash or Flex Builder.

Some of the notable code editors providing ActionScript-specific support include:

- [Adobe Dreamweaver® CS3](#)
- [ASDT](#)
- [FDT](#)
- [FlashDevelop](#)
- [PrimalScript](#)
- [SE|PY](#)
- [XCode](#) (with ActionScript [template and code-hint files](#))

## The ActionScript development process

No matter whether your ActionScript project is large or small, using a process to design and develop your application will help you work more efficiently and effectively. The following steps describe a basic development process for building an application that uses ActionScript 3.0:

1. Design your application.

You should describe your application in some way before you start building it.

**2.** Compose your ActionScript 3.0 code.

You can create ActionScript code using Flash, Flex Builder, Dreamweaver, or a text editor.

**3.** Create a Flash or Flex application file to run your code.

In the Flash authoring tool, this involves creating a new FLA file, setting up the publish settings, adding user interface components to the application, and referencing the ActionScript code. In the Flex development environment, creating a new application file involves defining the application and adding user interface components using MXML, and referencing the ActionScript code.

**4.** Publish and test your ActionScript application.

This involves running your application from within the Flash authoring or Flex development environment, and making sure it does everything you intended.

Note that you don't necessarily have to follow these steps in order, or completely finish one step before working on another. For example, you might design one screen of your application (step 1), and then create the graphics, buttons, and so forth (step 3), before writing ActionScript code (step 2) and testing (step 4). Or you might design part of it, and then add one button or interface element at a time, writing ActionScript for each one and testing it as it's built. Although it's helpful to remember these four stages of the development process, in real-world development it's usually more effective to move back and forth among the stages as appropriate.

# Creating your own classes

The process of creating classes for use in your projects can seem daunting. However, the more difficult part of creating a class is the task of designing the class—identifying the methods, properties, and events that it will include.

## Strategies for designing a class

The topic of object-oriented design is a complex one; entire careers have been devoted to the academic study and professional practice of this discipline. Nevertheless, here are a few suggested approaches that can help you get started.

1. Think about the role that the instances of this class will play in the application. Generally, objects serve one of these three roles:
  - Value object: These objects serve primarily as containers of data—that is, they likely have several properties and fewer methods (or sometimes no methods). They are generally code representations of clearly defined items, such as a Song class (representing a single real-world song) or Playlist class (representing a conceptual group of songs) in a music player application.
  - Display object: These are objects that actually appear on the screen. Examples include user-interface elements like a drop-down list or status readout, graphical elements like creatures in a video game, and so forth.
  - Application structure: These objects play a broad range of supporting roles in the logic or processing performed by applications. Examples include an object that performs certain calculations in a biology simulation; one that is responsible for synchronizing values between a dial control and a volume readout in a music player application; one that manages the rules in a video game; or one that loads a saved picture in a drawing application.
2. Decide the specific functionality that the class will need. The different types of functionality often become the methods of the class.
3. If the class is intended to serve as a value object, decide the data that the instances will include. These items are good candidates for properties.
4. Since your class is being designed specifically for your project, what's most important is that you provide the functionality that your application needs. It might help to answer these questions for yourself:

- What pieces of information will your application be storing, tracking, and manipulating? Deciding this helps you identify any value objects and properties you may want.
  - What sets of actions will need to be performed—for example, when the application first loads, when a particular button is clicked, when a movie stops playing, and so forth? These are good candidates for methods (or properties, if the “actions” just involve changing individual values).
  - For any given action, what information will the class need to know in order to perform that action? Those pieces of information become the parameters of the method.
  - As the application proceeds to do its work, what things will change in your class that other parts of your application will need to know about? These are good candidates for events.
5. If there is an existing object that is similar to the object you need, except that it’s lacking some additional functionality you want to add, consider creating a subclass (a class which builds on the functionality of an existing class, rather than defining all of its own functionality). For example, if you want to create a class that will be a visual object on the screen, you’ll want to use the behavior of one of the existing display objects (for example, `Sprite` or `MovieClip`) as a basis for your class. In that case, `MovieClip` (or `Sprite`) would be the *base class*, and your class would extend that class. For more information about creating a subclass, see [“Inheritance” on page 162](#).

## Writing the code for a class

Once you have a design plan for your class, or at least some idea of what information it will need to keep track of and what actions it will need to carry out, the actual syntax of writing a class is fairly straightforward.

Here are the minimum steps to create your own ActionScript class:

1. Open a new text document, in an ActionScript-specific program such as Flex Builder or Flash, in a general programming tool such as Dreamweaver, or in any program that allows you to work with plain text documents.
2. Enter a `class` statement to define the name of the class. To do this, enter the words `public class`, and then the class’s name, followed by opening and closing curly braces that will surround the contents of the class (the method and property definitions). For example:

```
public class MyClass
{
}
```

The word `public` indicates that the class can be accessed from any other code. For other alternatives, see [“Access control namespace attributes” on page 144](#).

3. Type a `package` statement to indicate the name of the package in which your class will be found. The syntax is the word `package`, followed by the full package name, followed by opening and closing curly braces (which will surround the `class` statement block). For example, we’d change the code in the previous step to this:

```
package mypackage
{
    public class MyClass
    {
    }
}
```

4. Define each property in the class using the `var` statement within the class body; the syntax is the same as you use to declare any variable (with the addition of the `public` modifier). For example, adding these lines between the opening and closing curly braces of the class definition will create properties named `textVariable`, `numericVariable`, and `dateVariable`:

```
public var textVariable:String = "some default value";
public var numericVariable:Number = 17;
public var dateVariable:Date;
```

5. Define each method in the class using the same syntax that’s used to define a function. For example:

- To create a `myMethod()` method, enter:

```
public function myMethod(param1:String, param2:Number):void
{
    // do something with parameters
}
```

- To create a constructor (the special method that is called as part of the process of creating an instance of a class), create a method whose name matches exactly the name of the class:

```
public function MyClass()
{
    // do stuff to set initial values for properties
    // and otherwise set up the object
    textVariable = "Hello there!";
    dateVariable = new Date(2001, 5, 11);
}
```

If you don’t include a constructor method in your class, the compiler will automatically create an empty constructor (one with no parameters and no statements) in your class.

There are a few more class elements that you can define. These elements are more involved.

- *Accessors* are a special cross between a method and a property. When you write the code to define the class, you write the accessor like a method so you can perform multiple actions (rather than just reading or assigning a value, which is all you can do when you define a property). However, when you create an instance of your class, you treat the accessor like a property—using just the name to read or assign the value. For more information, see [“Get and set accessor methods” on page 153](#).
- Events in ActionScript aren’t defined using a specific syntax. Instead, you define events in your class by using the functionality of the `EventDispatcher` class to keep track of event listeners and notify them of events. For more on creating events in your own classes, see [Chapter 10, “Handling events,” on page 313](#).

## Suggestions for organizing your classes

Unlike previous ActionScript versions, ActionScript 3.0 does not have the one file, one class restriction that limits you to using only one class per file. Using ActionScript 3.0, you can save the source code for more than one class in a single `.as` file. In some cases, it might seem more convenient to pack multiple classes into a single source file, but in general, this is considered a bad programming practice, for a couple of reasons:

- It is difficult to reuse individual classes if they are packed together into a single large file.
- It is difficult to locate the source code for a specific class when its filename does not correspond to the class name.

For these reasons, Adobe recommends that you always save the source code for each individual class in its own file, and give the file the same name as the class.

## Example: Creating a basic application

You can create external ActionScript source files with an `.as` extension using Flash, Flex Builder, Dreamweaver, or any text editor.

ActionScript 3.0 can be used within a number of application development environments, including the Flash authoring and Flex Builder tools.

This section walks through the steps in creating and enhancing a simple ActionScript 3.0 application using the Flash authoring tool or the Flex Builder 2 tool. The application you’ll build presents a simple pattern for using external ActionScript 3.0 class files in Flash and Flex applications. That pattern will apply to all of the other sample applications in this manual.



## Designing your ActionScript application

You should have some idea about the application you want to build before you start building it.

The representation of your design can be as simple as the name of the application and a brief statement of its purpose, or as complicated as a set of requirements documents containing numerous Unified Modeling Language (UML) diagrams. This manual doesn't discuss the discipline of software design in detail, but it's important to keep in mind that application design is an essential step in the development of ActionScript applications.

Our first example of an ActionScript application will be a standard "Hello World" application, so its design is very simple:

- The application will be called HelloWorld.
- It will display a single text field containing the words "Hello World!"
- In order to be easily reused, it will use a single object-oriented class, named Greeter, which can be used from within a Flash document or a Flex application.
- After you create a basic version of the application, you will add new functionality to have the user enter a user name and have the application check the name against a list of known users.

With that concise definition in place, you can start building the application itself.

## Creating the HelloWorld project and the Greeter class

The design statement for the Hello World application said that its code should be easy to reuse. With this goal in mind, the application uses a single object-oriented class, named Greeter, which is used from within an application that you create in Flex Builder or the Flash authoring tool.

### To create the Greeter class in the Flash authoring tool:

1. In the Flash authoring tool, select File > New.
2. In the New Document dialog box, select ActionScript file, and click OK.  
A new ActionScript editing window is displayed.
3. Select File > Save. Select a folder to contain your application, name the ActionScript file **Greeter.as**, and then click OK.

Continue with ["Adding code to the Greeter class"](#) on page 58.

## Adding code to the Greeter class

The Greeter class defines an object, `Greeter`, that you will be able to use in your `HelloWorld` application.

### To add code to the Greeter class:

1. Type the following code into the new file:

```
package
{
    public class Greeter
    {
        public function sayHello():String
        {
            var greeting:String;
            greeting = "Hello World!";
            return greeting;
        }
    }
}
```

The Greeter class includes a single `sayHello()` method, which returns a string that says “Hello” to the user name that is given.

2. Select `File > Save` to save this ActionScript file.

The Greeter class is now ready to be used in a Flash or Flex application.

## Creating an application that uses your ActionScript code

The Greeter class that you have built defines a self-contained set of software functions, but it does not represent a complete application. To use the class, you need to create a Flash document or Flex application.

The `HelloWorld` application creates a new instance of the Greeter class. Here’s how to attach the Greeter class to your application.

### To create an ActionScript application using the Flash authoring tool:

1. Select `File > New`.
2. In the New Document dialog box, select `Flash Document`, and click `OK`.  
A new Flash window is displayed.
3. Select `File > Save`. Select the same folder that contains the `Greeter.as` class file, name the Flash document `HelloWorld.fla`, and click `OK`.

4. In the Flash Tools palette, select the Text tool, and drag across the Stage to define a new text field, approximately 300 pixels wide and 100 pixels high.
5. In the Properties window, with the text field still selected on the Stage, type `mainText` as the instance name of the text field.
6. Click the first frame of the main timeline.
7. In the Actions panel, type the following script:

```
var myGreeter:Greeter = new Greeter();
mainText.text = myGreeter.sayHello("Bob");
```

8. Save the file.

Continue with [“Publishing and testing your ActionScript application” on page 59](#).

## Publishing and testing your ActionScript application

Software development is an iterative process. You write some code, try to compile it, and edit the code until it compiles cleanly. You run the compiled application, test it to see if it fulfills the intended design, and if it doesn't, you edit the code again until it does. The Flash and Flex Builder development environments offer a number of ways to publish, test, and debug your applications.

Here are the basic steps for testing the HelloWorld application in each environment.

### **To publish and test an ActionScript application using the Flash authoring tool:**

1. Publish your application and watch for compilation errors. In the Flash authoring tool, select **Control > Test Movie** to compile your ActionScript code and run the HelloWorld application.
2. If any errors or warnings are displayed in the Output window when you test your application, fix the causes of these errors in the HelloWorld.fla or HelloWorld.as files, and then try testing the application again.
3. If there are no compilation errors, you will see a Flash Player window showing the HelloWorld application. The “Hello, Bob” text is displayed.

You have just created a simple but complete object-oriented application that uses ActionScript

- 3.0. Continue with [“Enhancing the HelloWorld application” on page 60](#).

## Enhancing the HelloWorld application

To make the application a little more interesting, you'll now make it ask for and validate a user name against a predefined list of names.

First, you will update the Greeter class to add new functionality. Then you will update the Flex or Flash application to use the new functionality.

### To update the Greeter.as file:

1. Open the Greeter.as file.
2. Change the contents of the file to the following (new and changed lines are shown in boldface):

```
package
{
    public class Greeter
    {
        /**
         * Defines the names that should receive a proper greeting.
         */
        public static var validNames:Array = ["Sammy", "Frank", "Dean"];

        /**
         * Builds a greeting string using the given name.
         */
        public function sayHello(userName:String = ""):String
        {
            var greeting:String;
            if (userName == "")
            {
                greeting = "Hello. Please type your user name, and then press
the Enter key.";
            }
            else if (validName(userName))
            {
                greeting = "Hello, " + userName + ".";
            }
            else
            {
                greeting = "Sorry, " + userName + ", you are not on the list.";
            }
            return greeting;
        }

        /**
         * Checks whether a name is in the validNames list.
         */
        public static function validName(inputName:String = ""):Boolean
        {
```

```

        if (validNames.indexOf(inputName) > -1)
        {
            return true;
        }
        else
        {
            return false;
        }
    }
}
}

```

The Greeter class now has a number of new features:

- The `validNames` array lists valid user names. The array is initialized to a list of three names when the Greeter class is loaded.
- The `sayHello()` method now accepts a user name and changes the greeting based on some conditions. If the `userName` is an empty string (""), the `greeting` property is set to prompt the user for a name. If the user name is valid, the greeting becomes "Hello, *userName*." Finally, if either of those two conditions are not met, the `greeting` variable is set to "Sorry, *userName*, you are not on the list."
- The `validName()` method returns `true` if the `inputName` is found in the `validNames` array, and `false` if it is not found. The statement `validNames.indexOf(inputName)` checks each of the strings in the `validNames` array against the `inputName` string. The `Array.indexOf()` method returns the index position of the first instance of an object in an array, or the value `-1` if the object is not found in the array.

Next you will edit the Flash or Flex file that references this ActionScript class.

### To modify the application using the Flash authoring tool:

1. Open the `HelloWorld.fla` file.
2. Modify the script in Frame 1 so that an empty string ("") is passed to the Greeter class's `sayHello()` method:

```

var myGreeter:Greeter = new Greeter();
mainText.text = myGreeter.sayHello("");

```
3. Select the Text tool in the Tools palette, and then create two new text fields on the Stage, side-by-side and directly under the existing `mainText` text field.
4. In the first new text field, type the text **User Name:** to serve as a label.
5. Select the other new text field, and in the Property inspector, select `InputText` as the type of text field. Type `textInput` as the instance name.
6. Click the first frame of the main timeline.
7. In the Actions panel, add the following lines to the end of the existing script:

```

mainText.border = true;
textIn.border = true;

textIn.addEventListener(KeyboardEvent.KEY_UP, keyPressed);

function keyPressed(event:Event):void
{
    if (event.keyCode == Keyboard.ENTER)
    {
        mainText.text = myGreeter.sayHello(textIn.text);
    }
}

```

The new code adds the following functionality:

- The first two lines simply define borders for two text fields.
- An input text field, such as the `textIn` field, has a set of events that it can dispatch. The `addEventListener()` method lets you define a function that runs when a type of event occurs. In this case, that event is the pressing of the Enter key on the keyboard.
- The `keyPressed()` custom function calls the `sayHello()` method of the `myGreeter` object, passing the text from the `textIn` text field as a parameter. That method returns a string greeting based on the value passed in. The returned string is then assigned to the `text` property of the `mainText` text field.

The complete script for Frame 1 is the following:

```

mainText.border = true;
textIn.border = true;

var myGreeter:Greeter = new Greeter();
mainText.text = myGreeter.sayHello("");

textIn.addEventListener(KeyboardEvent.KEY_UP, keyPressed);

function keyPressed(event:Event):void
{
    if (event.keyCode == Keyboard.ENTER)
    {
        mainText.text = myGreeter.sayHello(textIn.text);
    }
}

```

8. Save the file.
9. Select Control > Test Movie to run the application.

When you run the application, you will be prompted to enter a user name. If it is valid (Sammy, Frank, or Dean), the application displays the “hello” confirmation message.

# Running subsequent examples

Now that you've developed and run the "Hello World" ActionScript 3.0 application, you should have the basic knowledge you need to run the other code examples presented in this manual.

## Testing in-chapter example code listings

As you're working through this manual, you may want to try out the example code listings that are used to illustrate the various topics. That testing may involve displaying the value of variables at certain points in the program, or it may involve viewing or interacting with on-screen content. For testing visual content or interaction, the necessary elements will be described before or within the code listing—you'll just need to create a document with the elements as described in order to test the code. In the case where you want to view the value of a variable at a given point in the program, there are a few ways you can accomplish this. One way is to use a debugger, such as the ones built into Flex Builder and Flash. For simple testing, however, it might be easiest to just print variable values out to some place where you can view them.

The following steps will help you create a Flash document that you can use for testing a code listing and viewing variable values:

### To create a Flash document for testing in-chapter examples:

1. Create a new Flash document and save it on your hard drive.
2. To display test values in a text field on the Stage, activate the Text tool and create a new Dynamic text field on the Stage. A wide, tall text field with the Line type set to Multiline and the border turned on will be most useful. In the Property inspector, give the text field an instance name (for example "outputText"). To write values into the text field, you will add code that calls the `appendText()` method to the example code (described below).
3. Alternatively, you can add a `trace()` function call to the code listing (as described below) to view the results of the example.
4. To test a given example, copy the code listing into the Actions panel; if necessary, add a `trace()` function call or add a value to the text field using its `appendText()` method.
5. From the main menu, choose **Control > Test Movie** to create a SWF file and view the results.

Since this approach is for viewing values of variables, there are two ways that you can easily view the values of variables as you're trying out the examples: write values into a text field instance on the Stage, or use the `trace()` function to print values to the Output panel.

- **The `trace()` function:** The ActionScript `trace()` function writes the values of any parameters passed to it (either variables or literal expressions) to the Output panel. Many of the example listings in this manual already include a `trace()` function call, so for those listings you'll only need to copy the code into your document and test the project. If you want to use `trace()` to test the value of a variable in a code listing that doesn't already include it, just add a `trace()` call to the code listing, passing the variable as a parameter. For example, if you encountered a code listing such as this one in the chapter,

```
var albumName:String = "Three for the money";
```

you could copy the code into the Actions panel, then add a call to the `trace()` function such as this one to test the outcome of the code listing:

```
var albumName:String = "Three for the money";  
trace("albumName =", albumName);
```

When you run the program, this line will print out:

```
albumName = Three for the money
```

Each `trace()` function call can take multiple parameters, which are all strung together as a single printed line. A line break is added to the end of each `trace()` function call, so separate `trace()` calls print out on separate lines.

- **A text field on the Stage:** If you prefer not to use the `trace()` function, you can add a Dynamic text field to the Stage using the Text tool, and write out values to that text field to view the results of a code listing. The `appendText()` method of the `TextField` class can be used to add a String value to the end of the text field's contents. To access the text field using ActionScript, you must give it an instance name in the Property inspector. For instance, if your text field has the instance name `outputText`, the following code could be used to check the value of the variable `albumName`:

```
var albumName:String = "Three for the money";  
outputText.appendText("albumName = ");  
outputText.appendText(albumName);
```

This code would write the following text to the text field named `outputText`:

```
albumName = Three for the money
```

As the example shows, the `appendText()` method will add the text to the same line as the previous contents, so multiple values can be added to the same line of text using multiple `appendText()` calls. To force the text to the next line you can append a newline character ("`\n`");

```
outputText.appendText("\n"); // adds a line break to the text field
```



Unlike the `trace()` function, the `appendText()` method only accepts one value as a parameter. That value must be a string (either a `String` instance or a string literal). To print out the value of a non-string variable, you must first convert the value to a `String`. The easiest way to do that is to call the object's `toString()` method:

```
var albumYear:int = 1999;
outputText.appendText("albumYear = ");
outputText.appendText(albumYear.toString());
```

## Working with end-of-chapter examples

Like this chapter, most chapters in this manual include a significant end-of-chapter example that ties together many of the concepts discussed in the chapter. However, unlike the Hello World example in this chapter, those examples will not be presented in a step-by-step tutorial format. The relevant `ActionScript 3.0` code in each example will be highlighted and discussed, but instructions about running the examples in specific development environments won't be provided. However, the example files distributed with this manual will include all of the files you need to compile and run the examples easily in your chosen development environment.



# ActionScript language and syntax

ActionScript 3.0 comprises both the core ActionScript language and the Adobe Flash Player Application Programming Interface (API). The core language is the part of ActionScript that implements the draft ECMAScript (ECMA-262), Edition 4 draft language specification. The Flash Player API provides programmatic access to Flash Player.

This chapter provides a brief introduction to the core ActionScript language and syntax. After reading this chapter, you should have a basic understanding of how to work with data types and variables, how to use proper syntax, and how to control the flow of data in your program.

## Contents

Language overview .....	68
Objects and classes .....	69
Packages and namespaces .....	70
Variables .....	83
Data types .....	87
Syntax .....	103
Operators .....	109
Conditionals .....	117
Looping .....	119
Functions .....	122

# Language overview

Objects lie at the heart of the ActionScript 3.0 language—they are its fundamental building blocks. Every variable you declare, every function you write, and every class instance you create is an object. You can think of an ActionScript 3.0 program as a group of objects that carry out tasks, respond to events, and communicate with one another.

Programmers familiar with object-oriented programming (OOP) in Java or C++ may think of objects as modules that contain two kinds of members: data stored in member variables or properties, and behavior accessible through methods. The ECMAScript edition 4 draft, the standard upon which ActionScript 3.0 is based, defines objects in a similar but slightly different way. In the ECMAScript draft, objects are simply collections of properties. These properties are containers that can hold not only data, but also functions or other objects. If a function is attached to an object in this way, it is called a method.

While the ECMAScript draft definition may seem a little odd to programmers with a Java or C++ background, in practice, defining object types with ActionScript 3.0 classes is very similar to the way classes are defined in Java or C++. The distinction between the two definitions of object is important when discussing the ActionScript object model and other advanced topics, but in most other situations the term *properties* means class member variables as opposed to methods. The *ActionScript 3.0 Language and Components Reference*, for example, uses the term *properties* to mean variables or getter-setter properties. It uses the term *methods* to mean functions that are part of a class.

One subtle difference between classes in ActionScript and classes in Java or C++ is that in ActionScript, classes are not just abstract entities. ActionScript classes are represented by *class objects* that store the class's properties and methods. This allows for techniques that may seem alien to Java and C++ programmers, such as including statements or executable code at the top level of a class or package.

Another difference between ActionScript classes and Java or C++ classes is that every ActionScript class has something called a *prototype object*. In previous versions of ActionScript, prototype objects, linked together into *prototype chains*, served collectively as the foundation of the entire class inheritance hierarchy. In ActionScript 3.0, however, prototype objects play only a small role in the inheritance system. The prototype object can still be useful, however, as an alternative to static properties and methods if you want to share a property and its value among all the instances of a class.

In the past, advanced ActionScript programmers could directly manipulate the prototype chain with special built-in language elements. Now that the language provides a more mature implementation of a class-based programming interface, many of these special language elements, such as `__proto__` and `__resolve`, are no longer part of the language. Moreover, optimizations of the internal inheritance mechanism that provide significant Flash Player performance improvements preclude direct access to the inheritance mechanism.

## Objects and classes

In ActionScript 3.0, every object is defined by a class. A class can be thought of as a template or a blueprint for a type of object. Class definitions can include variables and constants, which hold data values, and methods, which are functions that encapsulate behavior bound to the class. The values stored in properties can be *primitive values* or other objects. Primitive values are numbers, strings, or Boolean values.

ActionScript contains a number of built-in classes that are part of the core language. Some of these built-in classes, such as `Number`, `Boolean` and `String`, represent the primitive values available in ActionScript. Others, such as the `Array`, `Math`, and `XML` classes, define more complex objects that are part of the ECMAScript standard.

All classes, whether built-in or user-defined, derive from the `Object` class. For programmers with previous ActionScript experience, it is important to note that the `Object` data type is no longer the default data type, even though all other classes still derive from it. In ActionScript 2.0, the following two lines of code were equivalent because the lack of a type annotation meant that a variable would be of type `Object`:

```
var someObj:Object;  
var someObj;
```

ActionScript 3.0, however, introduces the concept of untyped variables, which can be designated in the following two ways:

```
var someObj:*;  
var someObj;
```

An untyped variable is not the same as a variable of type `Object`. The key difference is that untyped variables can hold the special value `undefined`, while a variable of type `Object` cannot hold that value.

You can define your own classes using the `class` keyword. You can declare class properties in three ways: constants can be defined with the `const` keyword, variables are defined with the `var` keyword, and getter and setter properties are defined by using the `get` and `set` attributes in a method declaration. You can declare methods with the `function` keyword.

You create an instance of a class by using the `new` operator. The following example creates an instance of the `Date` class called `myBirthday`.

```
var myBirthday:Date = new Date();
```

## Packages and namespaces

Packages and namespaces are related concepts. Packages allow you to bundle class definitions together in a way that facilitates code sharing and minimizes naming conflicts. Namespaces allow you to control the visibility of identifiers, such as property and method names, and can be applied to code whether it resides inside or outside a package. Packages let you organize your class files, and namespaces let you manage the visibility of individual properties and methods.

### Packages

Packages in ActionScript 3.0 are implemented with namespaces, but are not synonymous with them. When you declare a package, you are implicitly creating a special type of namespace that is guaranteed to be known at compile time. Namespaces, when created explicitly, are not necessarily known at compile time.

The following example uses the `package` directive to create a simple package containing one class:

```
package samples
{
    public class SampleCode
    {
        public var sampleGreeting:String;
        public function sampleFunction()
        {
            trace(sampleGreeting + " from sampleFunction()");
        }
    }
}
```

The name of the class in this example is `SampleCode`. Because the class is inside the `samples` package, the compiler automatically qualifies the class name at compile time into its fully qualified name: `samples.SampleCode`. The compiler also qualifies the names of any properties or methods, so that `sampleGreeting` and `sampleFunction()` become `samples.SampleCode.sampleGreeting` and `samples.SampleCode.sampleFunction()`, respectively.

Many developers, especially those with Java programming backgrounds, may choose to place only classes at the top level of a package. ActionScript 3.0, however, supports not only classes at the top level of a package, but also variables, functions, and even statements. One advanced use of this feature is to define a namespace at the top level of a package so that it will be available to all classes in that package. Note, however, that only two access specifiers, `public` and `internal`, are allowed at the top level of a package. Unlike Java, which allows you to declare nested classes as `private`, ActionScript 3.0 supports neither nested nor private classes.

In many other ways, however, ActionScript 3.0 packages are similar to packages in the Java programming language. As you can see in the previous example, fully qualified package references are expressed using the dot operator (`.`), just as they are in Java. You can use packages to organize your code into an intuitive hierarchical structure for use by other programmers. This facilitates code sharing by allowing you to create your own package to share with others, and to use packages created by others in your code.

The use of packages also helps to ensure that the identifier names that you use are unique and do not conflict with other identifier names. In fact, some would argue that this is the primary benefit of packages. For example, two programmers who wish to share their code with each other may have each created a class called `SampleCode`. Without packages, this would create a name conflict, and the only resolution would be to rename one of the classes. With packages, however, the name conflict is easily avoided by placing one, or preferably both, of the classes in packages with unique names.

You can also include embedded dots in your package name to create nested packages. This allows you to create a hierarchical organization of packages. A good example of this is the `flash.xml` package provided by the Flash Player API. The `flash.xml` package is nested inside the `flash` package.

The `flash.xml` package contains the legacy XML parser that was used in previous versions of ActionScript. One reason that it now resides in the `flash.xml` package is that the name of the legacy XML class conflicts with the name of the new XML class that implements the XML for ECMAScript (E4X) specification functionality available in ActionScript 3.0.

Although moving the legacy XML class into a package is a good first step, most users of the legacy XML classes will import the `flash.xml` package, which will generate the same name conflict unless you remember to always use the fully qualified name of the legacy XML class (`flash.xml.XML`). To avoid this situation, the legacy XML class is now named `XMLDocument`, as the following example shows:

```
package flash.xml
{
    class XMLDocument {}
    class XMLNode {}
    class XMLSocket {}
}
```

Most of the Flash Player API is organized under the flash package. For example, the flash.display package contains the display list API, and the flash.events package contains the new event model.

## Creating packages

ActionScript 3.0 provides significant flexibility in the way you organize your packages, classes, and source files. Previous versions of ActionScript allowed only one class per source file and required that the name of the source file match the name of the class. ActionScript 3.0 allows you to include multiple classes in one source file, but only one class in each file can be made available to code that is external to that file. In other words, only one class in each file can be declared inside a package declaration. You must declare any additional classes outside your package definition, which makes those classes invisible to code outside that source file. The name of the class declared inside the package definition must match the name of the source file.

ActionScript 3.0 also provides more flexibility in the way you declare packages. In previous versions of ActionScript, packages merely represented directories in which you placed source files, and you didn't declare packages with the `package` statement, but rather included the package name as part of the fully qualified class name in your class declaration. Although packages still represent directories in ActionScript 3.0, packages can contain more than just classes. In ActionScript 3.0, you use the `package` statement to declare a package, which means that you can also declare variables, functions, and namespaces at the top level of a package. You can even include executable statements at the top level of a package. If you do declare variables, functions, or namespaces at the top level of a package, the only attributes available at that level are `public` and `internal`, and only one package-level declaration per file can use the `public` attribute, whether that declaration is a class, variable, function, or namespace.

Packages are useful for organizing your code and for preventing name conflicts. You should not confuse the concept of packages with the unrelated concept of class inheritance. Two classes that reside in the same package will have a namespace in common, but are not necessarily related to each other in any other way. Likewise, a nested package may have no semantic relationship to its parent package.



## Importing packages

If you want to use a class that is inside a package, you must import either the package or the specific class. This differs from ActionScript 2.0, where importing classes was optional.

For example, consider the `SampleCode` class example from earlier in this chapter. If the class resides in a package named `samples`, you must use one of the following import statements before using the `SampleCode` class:

```
import samples.*;
```

or

```
import samples.SampleCode;
```

In general, `import` statements should be as specific as possible. If you plan to use only the `SampleCode` class from the `samples` package, you should import only the `SampleCode` class rather than the entire package to which it belongs. Importing entire packages may lead to unexpected name conflicts.

You must also place the source code that defines the package or class within your *classpath*. The classpath is a user-defined list of local directory paths that determines where the compiler will search for imported packages and classes. The classpath is sometimes called the *build path* or *source path*.

After you have properly imported the class or package, you can use either the fully qualified name of the class (`samples.SampleCode`) or merely the class name by itself (`SampleCode`).

Fully qualified names are useful when identically named classes, methods, or properties result in ambiguous code, but can be difficult to manage if used for all identifiers. For example, the use of the fully qualified name results in verbose code when you instantiate a `SampleCode` class instance:

```
var mySample:samples.SampleCode = new samples.SampleCode();
```

As the levels of nested packages increase, the readability of your code decreases. In situations where you are confident that ambiguous identifiers will not be a problem, you can make your code easier to read by using simple identifiers. For example, instantiating a new instance of the `SampleCode` class is much less verbose if you use only the class identifier:

```
var mySample:SampleCode = new SampleCode();
```

If you attempt to use identifier names without first importing the appropriate package or class, the compiler will not be able to find the class definitions. On the other hand, if you do import a package or class, any attempt to define a name that conflicts with an imported name will generate an error.

When a package is created, the default access specifier for all members of that package is `internal`, which means that, by default, package members are only visible to other members of that package. If you want a class to be available to code outside the package, you must declare that class to be `public`. For example, the following package contains two classes, `SampleCode` and `CodeFormatter`:

```
// SampleCode.as file
package samples
{
    public class SampleCode {}
}
```

```
// CodeFormatter.as file
package samples
{
    class CodeFormatter {}
}
```

The `SampleCode` class is visible outside the package because it is declared as a `public` class. The `CodeFormatter` class, however, is visible only within the `samples` package itself. If you attempt to access the `CodeFormatter` class outside the `samples` package, you will generate an error, as the following example shows:

```
import samples.SampleCode;
import samples.CodeFormatter;
var mySample:SampleCode = new SampleCode(); // okay, public class
var myFormatter:CodeFormatter = new CodeFormatter(); // error
```

If you want both classes to be available outside the package, you must declare both classes to be `public`. You cannot apply the `public` attribute to the package declaration.

Fully qualified names are useful for resolving name conflicts that may occur when using packages. Such a scenario may arise if you import two packages that define classes with the same identifier. For example, consider the following package, which also has a class named `SampleCode`:

```
package langref.samples
{
    public class SampleCode {}
}
```

If you import both classes, as follows, you will have a name conflict when referring to the `SampleCode` class:

```
import samples.SampleCode;
import langref.samples.SampleCode;
var mySample:SampleCode = new SampleCode(); // name conflict
```

The compiler has no way of knowing which `SampleCode` class to use. To resolve this conflict, you must use the fully qualified name of each class, as follows:

```
var sample1:samples.SampleCode = new samples.SampleCode();
var sample2:langref.samples.SampleCode = new langref.samples.SampleCode();
```

NOTE

Programmers with a C++ background often confuse the `import` statement with `#include`. The `#include` directive is necessary in C++ because C++ compilers process one file at a time, and will not look in other files for class definitions unless a header file is explicitly included. ActionScript 3.0 has an `include` directive, but it is not designed to import classes and packages. To import classes or packages in ActionScript 3.0, you must use the `import` statement and place the source file that contains the package in the class path.

## Namespaces

Namespaces give you control over the visibility of the properties and methods that you create. Think of the `public`, `private`, `protected`, and `internal` access control specifiers as built-in namespaces. If these predefined access control specifiers do not suit your needs, you can create your own namespaces.

If you are familiar with XML namespaces, much of this discussion will not be new to you, although the syntax and details of the ActionScript implementation are slightly different from those of XML. If you have never worked with namespaces before, the concept itself is straightforward, but the implementation has specific terminology that you will need to learn.

To understand how namespaces work, it helps to know that the name of a property or method always contains two parts: an identifier and a namespace. The identifier is what you generally think of as a name. For example, the identifiers in the following class definition are

`sampleGreeting` and `sampleFunction()`:

```
class SampleCode
{
    var sampleGreeting:String;
    function sampleFunction () {
        trace(sampleGreeting + " from sampleFunction()");
    }
}
```

Whenever definitions are not preceded by a namespace attribute, their names are qualified by the default `internal` namespace, which means they are visible only to callers in the same package. If the compiler is set to strict mode, the compiler issues a warning that the `internal` namespace applies to any identifier without a namespace attribute. To ensure that an identifier is available everywhere, you must specifically precede the identifier name with the `public` attribute. In the previous example code, both `sampleGreeting` and `sampleFunction()` have a namespace value of `internal`.

There are three basic steps to follow when using namespaces. First, you must define the namespace using the `namespace` keyword. For example, the following code defines the `version1` namespace:

```
namespace version1;
```

Second, you apply your namespace by using it instead of an access control specifier in a property or method declaration. The following example places a function named `myFunction()` into the `version1` namespace:

```
version1 function myFunction() {}
```

Third, once you've applied the namespace, you can reference it with the `use` directive or by qualifying the name of an identifier with a namespace. The following example references the `myFunction()` function through the `use` directive:

```
use namespace version1;  
myFunction();
```

You can also use a qualified name to reference the `myFunction()` function, as the following example shows:

```
version1::myFunction();
```

## Defining namespaces

Namespaces contain one value, the Uniform Resource Identifier (URI), which is sometimes called the *namespace name*. A URI allows you to ensure that your namespace definition is unique.

You create a namespace by declaring a namespace definition in one of two ways. You can either define a namespace with an explicit URI, as you would define an XML namespace, or you can omit the URI. The following example shows how a namespace can be defined using a URI:

```
namespace flash_proxy = "http://www.adobe.com/flash/proxy";
```

The URI serves as a unique identification string for that namespace. If you omit the URI, as in the following example, the compiler will create a unique internal identification string in place of the URI. You do not have access to this internal identification string.

```
namespace flash_proxy;
```

Once you define a namespace, with or without a URI, that namespace cannot be redefined in the same scope. An attempt to define a namespace that has been defined earlier in the same scope results in a compiler error.

If a namespace is defined within a package or a class, the namespace may not be visible to code outside that package or class unless the appropriate access control specifier is used. For example, the following code shows the `flash_proxy` namespace defined within the `flash.utils` package. In the following example, the lack of an access control specifier means that the `flash_proxy` namespace would be visible only to code within the `flash.utils` package and would not be visible to any code outside the package:

```
package flash.utils
{
    namespace flash_proxy;
}
```

The following code uses the `public` attribute to make the `flash_proxy` namespace visible to code outside the package:

```
package flash.utils
{
    public namespace flash_proxy;
}
```

## Applying namespaces

Applying a namespace means placing a definition into a namespace. Definitions that can be placed into namespaces include functions, variables, and constants (you cannot place a class into a custom namespace).

Consider, for example, a function declared using the `public` access control namespace. Using the `public` attribute in a function definition places the function into the public namespace, which makes the function available to all code. Once you have defined a namespace, you can use the namespace that you defined the same way you would use the `public` attribute, and the definition will be available to code that can reference your custom namespace. For example, if you define a namespace `example1`, you can add a method called `myFunction()` using `example1` as an attribute, as the following example shows:

```
namespace example1;
class someClass
{
    example1 myFunction() {}
}
```

Declaring the `myFunction()` method using the namespace `example1` as an attribute means that the method belongs to the `example1` namespace.

You should bear in mind the following when applying namespaces:

- You can apply only one namespace to each declaration.
- There is no way to apply a namespace attribute to more than one definition at a time. In other words, if you want to apply your namespace to ten different functions, you must add your namespace as an attribute to each of the ten function definitions.
- If you apply a namespace, you cannot also specify an access control specifier because namespaces and access control specifiers are mutually exclusive. In other words, you cannot declare a function or property as `public`, `private`, `protected`, or `internal` in addition to applying your namespace.

## Referencing namespaces

There is no need to explicitly reference a namespace when you use a method or property declared with any of the access control namespaces, such as `public`, `private`, `protected`, and `internal`. This is because access to these special namespaces is controlled by context. For example, definitions placed into the `private` namespace are automatically available to code within the same class. For namespaces that you define, however, such context sensitivity does not exist. In order to use a method or property that you have placed into a custom namespace, you must reference the namespace.

You can reference namespaces with the `use namespace` directive or you can qualify the name with the namespace using the name qualifier (`::`) punctuator. Referencing a namespace with the `use namespace` directive “opens” the namespace, so that it can apply to any identifiers that are not qualified. For example, if you have defined the `example1` namespace, you can access names in that namespace by using `use namespace example1`:

```
use namespace example1;
myFunction();
```

You can open more than one namespace at a time. Once you open a namespace with `use namespace`, it remains open throughout the block of code in which it was opened. There is no way to explicitly close a namespace.

Having more than one open namespace, however, increases the likelihood of name conflicts. If you prefer not to open a namespace, you can avoid the `use namespace` directive by qualifying the method or property name with the namespace and the name qualifier punctuator. For example, the following code shows how you can qualify the name `myFunction()` with the `example1` namespace:

```
example1::myFunction();
```

## Using namespaces

You can find a real-world example of a namespace that is used to prevent name conflicts in the `flash.utils.Proxy` class that is part of the Flash Player API. The `Proxy` class, which is the replacement for the `Object.__resolve` property from ActionScript 2.0, allows you to intercept references to undefined properties or methods before an error occurs. All of the methods of the `Proxy` class reside in the `flash_proxy` namespace in order to prevent name conflicts.

To better understand how the `flash_proxy` namespace is used, you need to understand how to use the `Proxy` class. The functionality of the `Proxy` class is available only to classes that inherit from it. In other words, if you want to use the methods of the `Proxy` class on an object, the object's class definition must extend the `Proxy` class. For example, if you want to intercept attempts to call an undefined method, you would extend the `Proxy` class and then override the `callProperty()` method of the `Proxy` class.

You may recall that implementing namespaces is usually a three-step process of defining, applying, and then referencing a namespace. Because you never explicitly call any of the `Proxy` class methods, however, the `flash_proxy` namespace is only defined and applied, but never referenced. The Flash Player API defines the `flash_proxy` namespace and applies it in the `Proxy` class. Your code only needs to apply the `flash_proxy` namespace to classes that extend the `Proxy` class.

The `flash_proxy` namespace is defined in the `flash.utils` package in a manner similar to the following:

```
package flash.utils
{
    public namespace flash_proxy;
}
```

The namespace is applied to the methods of the `Proxy` class as shown in the following excerpt from the `Proxy` class:

```
public class Proxy
{
    flash_proxy function callProperty(name:*, ... rest):*
    flash_proxy function deleteProperty(name:*):Boolean
    ...
}
```

As the following code shows, you must first import both the `Proxy` class and the `flash_proxy` namespace. You must then declare your class such that it extends the `Proxy` class (you must also add the `dynamic` attribute if you are compiling in strict mode). When you override the `callProperty()` method, you must use the `flash_proxy` namespace.

```

package
{
    import flash.utils.Proxy;
    import flash.utils.flash_proxy;

    dynamic class MyProxy extends Proxy
    {
        flash_proxy override function callProperty(name:*, ...rest):*
        {
            trace("method call intercepted: " + name);
        }
    }
}

```

If you create an instance of the `MyProxy` class and call an undefined method, such as the `testing()` method called in the following example, your `Proxy` object intercepts the method call and executes the statements inside the overridden `callProperty()` method (in this case, a simple `trace()` statement).

```

var mySample:MyProxy = new MyProxy();
mySample.testing(); // method call intercepted: testing

```

There are two advantages to having the methods of the `Proxy` class inside the `flash_proxy` namespace. First, having a separate namespace reduces clutter in the public interface of any class that extends the `Proxy` class. (There are about a dozen methods in the `Proxy` class that you can override, all of which are not designed to be called directly. Placing all of them in the public namespace could be confusing.) Second, use of the `flash_proxy` namespace avoids name conflicts in case your `Proxy` subclass contains instance methods with names that match any of the `Proxy` class methods. For example, you may want to name one of your own methods `callProperty()`. The following code is acceptable, because your version of the `callProperty()` method is in a different namespace:

```

dynamic class MyProxy extends Proxy
{
    public function callProperty() {}
    flash_proxy override function callProperty(name:*, ...rest):*
    {
        trace("method call intercepted: " + name);
    }
}

```

Namespaces can also be helpful when you want to provide access to methods or properties in a way that cannot be accomplished with the four access control specifiers (`public`, `private`, `internal`, and `protected`). For example, you may have a few utility methods that are spread out across several packages. You want these methods available to all of your packages, but you don't want the methods to be public. To accomplish this, you can create a new namespace and use it as your own special access control specifier.



The following example uses a user-defined namespace to group together two functions that reside in different packages. By grouping them into the same namespace, you can make both functions visible to a class or package through a single `use namespace` statement.

This example uses four files to demonstrate the technique. All of the files must be within your classpath. The first file, `myInternal.as`, is used to define the `myInternal` namespace. Because the file is in a package named `example`, you must place the file into a folder named `example`. The namespace is marked as `public` so that it can be imported into other packages.

```
// myInternal.as in folder example
package example
{
    public namespace myInternal = "http://www.adobe.com/2006/actionscript/
    examples";
}
```

The second and third files, `Utility.as` and `Helper.as`, define the classes that contain methods that should be available to other packages. The `Utility` class is in the `example.alpha` package, which means that the file should be placed inside a folder named `alpha` that is a subfolder of the `example` folder. The `Helper` class is in the `example.beta` package, which means that the file should be placed inside a folder named `beta` that is also a subfolder of the `example` folder. Both of these packages, `example.alpha` and `example.beta`, must import the namespace before using it.

```
// Utility.as in the example/alpha folder
package example.alpha
{
    import example.myInternal;

    public class Utility
    {
        private static var _taskCounter:int = 0;

        public static function someTask()
        {
            _taskCounter++;
        }

        myInternal static function get taskCounter():int
        {
            return _taskCounter;
        }
    }
}
```

```
// Helper.as in the example/beta folder
package example.beta
{
    import example.myInternal;

    public class Helper
    {
        private static var _timeStamp:Date;

        public static function someTask()
        {
            _timeStamp = new Date();
        }

        myInternal static function get lastCalled():Date
        {
            return _timeStamp;
        }
    }
}
```

The fourth file, `NamespaceUseCase.as`, is the main application class, and should be a sibling to the `example` folder. In Adobe Flash CS3 Professional, this class would be used as the document class for the FLA. The `NamespaceUseCase` class also imports the `myInternal` namespace and uses it to call the two static methods that reside in the other packages. The example uses static methods only to simplify the code. Both static and instance methods can be placed in the `myInternal` namespace.

```
// NamespaceUseCase.as
package
{
    import flash.display.MovieClip;
    import example.myInternal; // import namespace
    import example.alpha.Utility; // import Utility class
    import example.beta.Helper; // import Helper class

    public class NamespaceUseCase extends MovieClip
    {
        public function NamespaceUseCase()
        {
            use namespace myInternal;

            Utility.someTask();
            Utility.someTask();
            trace(Utility.taskCounter); // 2
        }
    }
}
```

```
        Helper.someTask();
        trace(Helper.lastCalled);    // [time someTask() was last called]
    }
}
```

## Variables

Variables allow you to store values that you use in your program. To declare a variable, you must use the `var` statement with the variable name. In ActionScript 2.0, use of the `var` statement is only required if you use type annotations. In ActionScript 3.0, use of the `var` statement is always required. For example, the following line of ActionScript declares a variable named `i`:

```
var i;
```

If you omit the `var` statement when declaring a variable, you will get a compiler error in strict mode and run-time error in standard mode. For example, the following line of code will result in an error if the variable `i` has not been previously defined:

```
i; // error if i was not previously defined
```

To associate a variable with a data type, you must do so when you declare the variable. Declaring a variable without designating the variable's type is legal, but will generate a compiler warning in strict mode. You designate a variable's type by appending the variable name with a colon (`:`), followed by the variable's type. For example, the following code declares a variable `i` that is of type `int`:

```
var i:int;
```

You can assign a value to a variable using the assignment operator (`=`). For example, the following code declares a variable `i` and assigns the value 20 to it:

```
var i:int;
i = 20;
```

You may find it more convenient to assign a value to a variable at the same time that you declare the variable, as in the following example:

```
var i:int = 20;
```

The technique of assigning a value to a variable at the time it is declared is commonly used not only when assigning primitive values such as integers and strings, but also when creating an array or instantiating an instance of a class. The following example shows an array that is declared and assigned a value using one line of code.

```
var numArray:Array = ["zero", "one", "two"];
```

You can create an instance of a class by using the `new` operator. The following example creates an instance of a named `CustomClass`, and assigns a reference to the newly created class instance to the variable named `customItem`:

```
var customItem:CustomClass = new CustomClass();
```

If you have more than one variable to declare, you can declare them all on one line of code by using the comma operator (`,`) to separate the variables. For example, the following code declares three variables on one line of code:

```
var a:int, b:int, c:int;
```

You can also assign values to each of the variables on the same line of code. For example, the following code declares three variables (`a`, `b`, and `c`) and assigns each a value:

```
var a:int = 10, b:int = 20, c:int = 30;
```

Although you can use the comma operator to group variable declarations into one statement, doing so may reduce the readability of your code.

## Understanding variable scope

The *scope* of a variable is the area of your code where the variable can be accessed by a lexical reference. A *global* variable is one that is defined in all areas of your code, whereas a *local* variable is one that is defined in only one part of your code. In ActionScript 3.0, variables are always assigned the scope of the function or class in which they are declared. A global variable is a variable that you define outside of any function or class definition. For example, the following code creates a global variable `strGlobal` by declaring it outside of any function. The example shows that a global variable is available both inside and outside the function definition.

```
var strGlobal:String = "Global";
function scopeTest()
{
    trace(strGlobal); // Global
}
scopeTest();
trace(strGlobal); // Global
```

You declare a local variable by declaring the variable inside a function definition. The smallest area of code for which you can define a local variable is a function definition. A local variable declared within a function will exist only in that function. For example, if you declare a variable named `str2` within a function named `localScope()`, that variable will not be available outside the function.

```
function localScope()
{
    var strLocal:String = "local";
```

```

}
localScope();
trace(strLocal); // error because strLocal is not defined globally

```

If the variable name you use for your local variable is already declared as a global variable, the local definition hides (or shadows) the global definition while the local variable is in scope. The global variable will still exist outside of the function. For example, the following code creates a global string variable named `str1`, and then creates a local variable of the same name inside the `scopeTest()` function. The `trace` statement inside the function outputs the local value of the variable, but the `trace` statement outside the function outputs the global value of the variable.

```

var str1:String = "Global";
function scopeTest ()
{
    var str1:String = "Local";
    trace(str1); // Local
}
scopeTest();
trace(str1); // Global

```

ActionScript variables, unlike variables in C++ and Java, do not have block-level scope. A block of code is any group of statements between an opening curly brace ( `{` ) and a closing curly brace ( `}` ). In some programming languages, such as C++ and Java, variables declared inside a block of code are not available outside that block of code. This restriction of scope is called block-level scope, and does not exist in ActionScript. If you declare a variable inside a block of code, that variable will be available not only in that block of code, but also in any other parts of the function to which the code block belongs. For example, the following function contains variables that are defined in various block scopes. All the variables are available throughout the function.

```

function blockTest (testArray:Array)
{
    var numElements:int = testArray.length;
    if (numElements > 0)
    {
        var elemStr:String = "Element #";
        for (var i:int = 0; i < numElements; i++)
        {
            var valueStr:String = i + ": " + testArray[i];
            trace(elemStr + valueStr);
        }
        trace(elemStr, valueStr, i); // all still defined
    }
    trace(elemStr, valueStr, i); // all defined if numElements > 0
}

blockTest(["Earth", "Moon", "Sun"]);

```

An interesting implication of the lack of block-level scope is that you can read or write to a variable before it is declared, as long as it is declared before the function ends. This is because of a technique called *hoisting*, which means that the compiler moves all variable declarations to the top of the function. For example, the following code compiles even though the initial `trace()` function for the `num` variable happens before the `num` variable is declared:

```
trace(num); // NaN
var num:Number = 10;
trace(num); // 10
```

The compiler will not, however, hoist any assignment statements. This explains why the initial `trace()` of `num` results in `NaN` (not a number), which is the default value for variables of the `Number` data type. This means that you can assign values to variables even before they are declared, as shown in the following example:

```
num = 5;
trace(num); // 5
var num:Number = 10;
trace(num); // 10
```

## Default values

A *default value* is the value that a variable contains before you set its value. You *initialize* a variable when you set its value for the first time. If you declare a variable, but do not set its value, that variable is *uninitialized*. The value of an uninitialized variable depends on its data type. The following table describes the default values of variables, organized by data type:

Data type	Default value
Boolean	false
int	0
Number	NaN
Object	null
String	null
uint	0
Not declared (equivalent to type annotation *)	undefined
All other classes, including user-defined classes.	null

For variables of type `Number`, the default value is `NaN` (not a number), which is a special value defined by the IEEE-754 standard to mean a value that does not represent a number.

If you declare a variable, but do not declare its data type, the default data type `*` will apply, which actually means that the variable is untyped. If you also do not initialize an untyped variable with a value, its default value is `undefined`.

For data types other than `Boolean`, `Number`, `int`, and `uint`, the default value of any uninitialized variable is `null`. This applies to all the classes defined by the Flash Player API, as well as any custom classes that you create.

The value `null` is not a valid value for variables of type `Boolean`, `Number`, `int`, or `uint`. If you attempt to assign a value of `null` to a such a variable, the value is converted to the default value for that data type. For variables of type `Object`, you can assign a value of `null`. If you attempt to assign the value `undefined` to a variable of type `Object`, the value is converted to `null`.

For variables of type `Number`, there is a special top-level function named `isNaN()` that returns the Boolean value `true` if the variable is not a number, and `false` otherwise.

## Data types

A *data type* defines a set of values. For example, the `Boolean` data type is the set of exactly two values: `true` and `false`. In addition to the `Boolean` data type, ActionScript 3.0 defines several more commonly used data types, such as `String`, `Number`, and `Array`. You can define your own data types by using classes or interfaces to define a custom set of values. All values in ActionScript 3.0, whether they are primitive or complex, are objects.

A *primitive value* is a value that belongs to one of the following data types: `Boolean`, `int`, `Number`, `String`, and `uint`. Working with primitive values is usually faster than working with complex values, because ActionScript stores primitive values in a special way that makes memory and speed optimizations possible.

### NOTE

For readers interested in the technical details, ActionScript stores primitive values internally as immutable objects. The fact that they are stored as immutable objects means that passing by reference is effectively the same as passing by value. This cuts down on memory usage and increases execution speed, because references are usually significantly smaller than the values themselves.

A *complex value* is a value that is not a primitive value. Data types that define sets of complex values include `Array`, `Date`, `Error`, `Function`, `RegExp`, `XML`, and `XMLList`.

Many programming languages distinguish between primitive values and their wrapper objects. Java, for example, has an `int` primitive and the `java.lang.Integer` class that wraps it. Java primitives are not objects, but their wrappers are, which makes primitives useful for some operations, and wrapper objects better suited for other operations. In ActionScript 3.0, primitive values and their wrapper objects are, for practical purposes, indistinguishable. All values, even primitive values, are objects. Flash Player treats these primitive types as special cases that behave like objects but that don't require the normal overhead associated with creating objects. This means that the following two lines of code are equivalent:

```
var someInt:int = 3;
var someInt:int = new int(3);
```

All the primitive and complex data types listed above are defined by the ActionScript 3.0 core classes. The core classes allow you to create objects using literal values instead of using the `new` operator. For example, you can create an array using a literal value or the `Array` class constructor, as follows:

```
var someArray:Array = [1, 2, 3]; // literal value
var someArray:Array = new Array(1,2,3); // Array constructor
```

## Type checking

Type checking can occur at either compile time or run time. Statically typed languages, such as C++ and Java, do type checking at compile time. Dynamically typed languages, such as Smalltalk and Python, handle type checking at run time. As a dynamically typed language, ActionScript 3.0 has run-time type checking, but also supports compile-time type checking with a special compiler mode called *strict mode*. In strict mode, type checking occurs at both compile time and run time, but in standard mode, type checking occurs only at run time.

Dynamically typed languages offer tremendous flexibility when you structure your code, but at the cost of allowing type errors to manifest at run time. Statically typed languages report type errors at compile time, but at the cost of requiring that type information be known at compile time.

## Compile-time type checking

Compile-time type checking is often favored in larger projects because as the size of a project grows, data type flexibility usually becomes less important than catching type errors as early as possible. This is why, by default, the ActionScript compiler in Adobe Flash CS3 Professional and Adobe Flex Builder 2 is set to run in strict mode.



In order to provide compile-time type checking, the compiler needs to know the data type information for the variables or expressions in your code. To explicitly declare a data type for a variable, add the colon operator (:) followed by the data type as a suffix to the variable name. To associate a data type with a parameter, use the colon operator followed by the data type. For example, the following code adds data type information to the `xParam` parameter, and declares a variable `myParam` with an explicit data type:

```
function runtimeTest(xParam:String)
{
    trace(xParam);
}
var myParam:String = "hello";
runtimeTest(myParam);
```

In strict mode, the `ActionScript` compiler reports type mismatches as compiler errors. For example, the following code declares a function parameter `xParam`, of type `Object`, but later attempts to assign values of type `String` and `Number` to that parameter. This produces a compiler error in strict mode.

```
function dynamicTest(xParam:Object)
{
    if (xParam is String)
    {
        var myStr:String = xParam; // compiler error in strict mode
        trace("String: " + myStr);
    }
    else if (xParam is Number)
    {
        var myNum:Number = xParam; // compiler error in strict mode
        trace("Number: " + myNum);
    }
}
```

Even in strict mode, however, you can selectively opt out of compile-time type checking by leaving the right side of an assignment statement untyped. You can mark a variable or expression as untyped by either omitting a type annotation, or using the special asterisk (\*) type annotation. For example, if the `xParam` parameter in the previous example is modified so that it no longer has a type annotation, the code will compile in strict mode:

```
function dynamicTest(xParam)
{
    if (xParam is String)
    {
        var myStr:String = xParam;
        trace("String: " + myStr);
    }
    else if (xParam is Number)
    {
```

```

        var myNum:Number = xParam;
        trace("Number: " + myNum);
    }
}
dynamicTest(100)
dynamicTest("one hundred");

```

## Run-time type checking

Run-time type checking occurs in ActionScript 3.0 whether you compile in strict mode or standard mode. Consider a situation in which the value 3 is passed as an argument to a function that expects an array. In strict mode, the compiler will generate an error, because the value 3 is not compatible with the data type Array. If you disable strict mode, and run in standard mode, the compiler does not complain about the type mismatch, but run-time type checking by Flash Player results in a run-time error.

The following example shows a function named `typeTest()` that expects an Array argument but is passed a value of 3. This causes a run-time error in standard mode, because the value 3 is not a member of the parameter's declared data type (Array).

```

function typeTest(xParam:Array)
{
    trace(xParam);
}
var myNum:Number = 3;
typeTest(myNum);
// run-time error in ActionScript 3.0 standard mode

```

There may also be situations where you get a run-time type error even when you are operating in strict mode. This is possible if you use strict mode, but opt out of compile-time type checking by using an untyped variable. When you use an untyped variable, you are not eliminating type checking but rather deferring it until run time. For example, if the `myNum` variable in the previous example does not have a declared data type, the compiler cannot detect the type mismatch, but Flash Player will generate a run-time error because it compares the run-time value of `myNum`, which is set to 3 as a result of the assignment statement, with the type of `xParam`, which is set to the Array data type.

```

function typeTest(xParam:Array)
{
    trace(xParam);
}
var myNum = 3;
typeTest(myNum);
// run-time error in ActionScript 3.0

```

Run-time type checking also allows more flexible use of inheritance than does compile-time checking. By deferring type checking to run time, standard mode allows you to reference properties of a subclass even if you *upcast*. An upcast occurs when you use a base class to declare the type of a class instance but use a subclass to instantiate it. For example, you can create a class named `ClassBase` that can be extended (classes with the `final` attribute cannot be extended):

```
class ClassBase
{
}
```

You can subsequently create a subclass of `ClassBase` named `ClassExtender`, which has one property named `someString`, as follows:

```
class ClassExtender extends ClassBase
{
    var someString:String;
}
```

Using both classes, you can create a class instance that is declared using the `ClassBase` data type, but instantiated using the `ClassExtender` constructor. An upcast is considered a safe operation, because the base class does not contain any properties or methods that are not in the subclass.

```
var myClass:ClassBase = new ClassExtender();
```

A subclass, however, does contain properties or methods that its base class does not. For example, the `ClassExtender` class contains the `someString` property, which does not exist in the `ClassBase` class. In ActionScript 3.0 standard mode, you can reference this property using the `myClass` instance without generating a compile-time error, as shown in the following example:

```
var myClass:ClassBase = new ClassExtender();
myClass.someString = "hello";
// no error in ActionScript 3.0 standard mode
```

## The `is` operator

The `is` operator, which is new for ActionScript 3.0, allows you to test whether a variable or expression is a member of a given data type. In previous versions of ActionScript, the `instanceof` operator provided this functionality, but in ActionScript 3.0 the `instanceof` operator should not be used to test for data type membership. The `is` operator should be used instead of the `instanceof` operator for manual type checking, because the expression `x instanceof y` merely checks the prototype chain of `x` for the existence of `y` (and in ActionScript 3.0, the prototype chain does not provide a complete picture of the inheritance hierarchy).

The `is` operator examines the proper inheritance hierarchy and can be used to check not only whether an object is an instance of a particular class, but also whether an object is an instance of a class that implements a particular interface. The following example creates an instance of the `Sprite` class named `mySprite` and uses the `is` operator to test whether `mySprite` is an instance of the `Sprite` and `DisplayObject` classes, and whether it implements the `IEventDispatcher` interface:

```
var mySprite:Sprite = new Sprite();
trace(mySprite is Sprite);           // true
trace(mySprite is DisplayObject);   // true
trace(mySprite is IEventDispatcher); // true
```

The `is` operator checks the inheritance hierarchy and properly reports that `mySprite` is compatible with the `Sprite` and `DisplayObject` classes (the `Sprite` class is a subclass of the `DisplayObject` class). The `is` operator also checks whether `mySprite` inherits from any classes that implement the `IEventDispatcher` interface. Because the `Sprite` class inherits from the `EventDispatcher` class, which implements the `IEventDispatcher` interface, the `is` operator correctly reports that `mySprite` implements the same interface.

The following example shows the same tests from the previous example, but with `instanceof` instead of the `is` operator. The `instanceof` operator correctly identifies that `mySprite` is an instance of `Sprite` or `DisplayObject`, but it returns `false` when used to test whether `mySprite` implements the `IEventDispatcher` interface.

```
trace(mySprite instanceof Sprite);   // true
trace(mySprite instanceof DisplayObject); // true
trace(mySprite instanceof IEventDispatcher); // false
```

## The `as` operator

The `as` operator, which is new in ActionScript 3.0, also allows you to check whether an expression is a member of a given data type. Unlike the `is` operator, however, the `as` operator does not return a Boolean value. Rather, the `as` operator returns the value of the expression instead of `true`, and `null` instead of `false`. The following example shows the results of using the `as` operator instead of the `is` operator in the simple case of checking whether a `Sprite` instance is a member of the `DisplayObject`, `IEventDispatcher`, and `Number` data types.

```
var mySprite:Sprite = new Sprite();
trace(mySprite as Sprite); // [object Sprite]
trace(mySprite as DisplayObject); // [object Sprite]
trace(mySprite as IEventDispatcher); // [object Sprite]
trace(mySprite as Number); // null
```

When you use the `as` operator, the operand on the right must be a data type. An attempt to use an expression other than a data type as the operand on the right will result in an error.

## Dynamic classes

A *dynamic* class defines an object that can be altered at run time by adding or changing properties and methods. A class that is not dynamic, such as the `String` class, is a *sealed* class. You cannot add properties or methods to a sealed class at run time.

You create dynamic classes by using the `dynamic` attribute when you declare a class. For example, the following code creates a dynamic class named `Protean`:

```
dynamic class Protean
{
    private var privateGreeting:String = "hi";
    public var publicGreeting:String = "hello";
    function Protean()
    {
        trace("Protean instance created");
    }
}
```

If you subsequently instantiate an instance of the `Protean` class, you can add properties or methods to it outside the class definition. For example, the following code creates an instance of the `Protean` class and adds a property named `aString` and a property named `aNumber` to the instance:

```
var myProtean:Protean = new Protean();
myProtean.aString = "testing";
myProtean.aNumber = 3;
trace(myProtean.aString, myProtean.aNumber); // testing 3
```

Properties that you add to an instance of a dynamic class are run-time entities, so any type checking is done at run time. You cannot add a type annotation to a property that you add in this manner.

You can also add a method to the `myProtean` instance by defining a function and attaching the function to a property of the `myProtean` instance. The following code moves the `trace` statement into a method named `traceProtean()`:

```
var myProtean:Protean = new Protean();
myProtean.aString = "testing";
myProtean.aNumber = 3;
myProtean.traceProtean = function ()
{
    trace(this.aString, this.aNumber);
};
myProtean.traceProtean(); // testing 3
```

Methods created in this way, however, do not have access to any private properties or methods of the Protean class. Moreover, even references to public properties or methods of the Protean class must be qualified with either the `this` keyword or the class name. The following example shows the `traceProtean()` method attempting to access the private and public variables of the Protean class.

```
myProtean.traceProtean = function ()
{
    trace(myProtean.privateGreeting); // undefined
    trace(myProtean.publicGreeting); // hello
};
myProtean.traceProtean();
```

## Data type descriptions

The primitive data types include Boolean, int, Null, Number, String, uint, and void. The ActionScript core classes also define the following complex data types: Object, Array, Date, Error, Function, RegExp, XML, and XMLList.

### Boolean data type

The Boolean data type comprises two values: `true` and `false`. No other values are valid for variables of Boolean type. The default value of a Boolean variable that has been declared but not initialized is `false`.

### int data type

The int data type is stored internally as a 32-bit integer and comprises the set of integers from  $-2,147,483,648$  ( $-2^{31}$ ) to  $2,147,483,647$  ( $2^{31} - 1$ ), inclusive. Previous versions of ActionScript offered only the Number data type, which was used for both integers and floating-point numbers. In ActionScript 3.0, you now have access to low-level machine types for 32-bit signed and unsigned integers. If your variable will not use floating-point numbers, using the int data type instead of the Number data type should be faster and more efficient.

For integer values outside the range of the minimum and maximum int values, use the Number data type, which can handle values between positive and negative  $9,007,199,254,740,992$  (53-bit integer values). The default value for variables that are of the data type int is 0.

## Null data type

The Null data type contains only one value, `null`. This is the default value for the String data type and all classes that define complex data types, including the Object class. None of the other primitive data types, such as Boolean, Number, int and uint, contain the value `null`. Flash Player will convert the value `null` to the appropriate default value if you attempt to assign `null` to variables of type Boolean, Number, int, or uint. You cannot use this data type as a type annotation.

## Number data type

In ActionScript 3.0, the Number data type can represent integers, unsigned integers, and floating-point numbers. However, to maximize performance, you should use the Number data type only for integer values larger than the 32-bit `int` and `uint` types can store or for floating-point numbers. To store a floating-point number, include a decimal point in the number. If you omit a decimal point, the number will be stored as an integer.

The Number data type uses the 64-bit double-precision format as specified by the IEEE Standard for Binary Floating-Point Arithmetic (IEEE-754). This standard dictates how floating-point numbers are stored using the 64 available bits. One bit is used to designate whether the number is positive or negative. Eleven bits are used for the exponent, which is stored as base 2. The remaining 52 bits are used to store the *significand* (also called the *mantissa*), which is the number that is raised to the power indicated by the exponent.

By using some of its bits to store an exponent, the Number data type can store floating-point numbers significantly larger than if it used all of its bits for the significand. For example, if the Number data type used all 64 bits to store the significand, it could store a number as large as  $2^{65} - 1$ . By using 11 bits to store an exponent, the Number data type can raise its significand to a power of  $2^{1023}$ .

The maximum and minimum values that the Number type can represent are stored in static properties of the Number class called `Number.MAX_VALUE` and `Number.MIN_VALUE`.

```
Number.MAX_VALUE == 1.79769313486231e+308  
Number.MIN_VALUE == 4.940656458412467e-324
```

Although this range of numbers is enormous, the cost of this range is precision. The Number data type uses 52 bits to store the significand, with the result that numbers that require more than 52 bits to represent precisely, such as the fraction  $1/3$ , are only approximations. If your application requires absolute precision with decimal numbers, you need to use software that implements decimal floating-point arithmetic as opposed to binary floating-point arithmetic.

When you store integer values with the Number data type, only the 52 bits of the significand are used. The Number data type uses these 52 bits and a special hidden bit to represent integers from -9,007,199,254,740,992 ( $-2^{53}$ ) to 9,007,199,254,740,992 ( $2^{53}$ ).

Flash Player uses the NaN value not only as the default value for variables of type Number, but also as the result of any operation that should return a number but does not. For example, if you attempt to calculate the square root of a negative number, the result will be NaN. Other special Number values include *positive infinity* and *negative infinity*.

NOTE

The result of division by 0 is only NaN if the divisor is also 0. Division by 0 produces infinity when the dividend is positive or -infinity when the dividend is negative.

## String data type

The String data type represents a sequence of 16-bit characters. Strings are stored internally as Unicode characters, using the UTF-16 format. Strings are immutable values, just as they are in the Java programming language. An operation on a String value returns a new instance of the string. The default value for a variable declared with the String data type is null. The value null is not the same as the empty string (" "), even though they both represent the absence of any characters.

## uint data type

The uint data type is stored internally as a 32-bit unsigned integer and comprises the set of integers from 0 to 4,294,967,295 ( $2^{32} - 1$ ), inclusive. Use the uint data type for special circumstances that call for non-negative integers. For example, you must use the uint data type to represent pixel color values, because the int data type has an internal sign bit that is not appropriate for handling color values. For integer values larger than the maximum uint value, use the Number data type, which can handle 53-bit integer values. The default value for variables that are of data type uint is 0.

## void data type

The void data type contains only one value, *undefined*. In previous versions of ActionScript, *undefined* was the default value for instances of the Object class. In ActionScript 3.0, the default value for Object instances is null. If you attempt to assign the value *undefined* to an instance of the Object class, Flash Player will convert the value to null. You can only assign a value of *undefined* to variables that are untyped. Untyped variables are variables that either lack any type annotation, or use the asterisk (\*) symbol for type annotation. You can use void only as a return type annotation.



## Object data type

The Object data type is defined by the Object class. The Object class serves as the base class for all class definitions in ActionScript. The ActionScript 3.0 version of the Object data type differs from that of previous versions in three ways. First, the Object data type is no longer the default data type assigned to variables with no type annotation. Second, the Object data type no longer includes the value `undefined`, which used to be the default value of Object instances. Third, in ActionScript 3.0, the default value for instances of the Object class is `null`.

In previous versions of ActionScript, a variable with no type annotation was automatically assigned the Object data type. This is no longer true in ActionScript 3.0, which now includes the idea of a truly untyped variable. Variables with no type annotation are now considered untyped. If you prefer to make it clear to readers of your code that your intention is to leave a variable untyped, you can use the new asterisk (\*) symbol for the type annotation, which is equivalent to omitting a type annotation. The following example shows two equivalent statements, both of which declare an untyped variable `x`:

```
var x
var x:*
```

Only untyped variables can hold the value `undefined`. If you attempt to assign the value `undefined` to a variable that has a data type, Flash Player will convert the value `undefined` to the default value of that data type. For instances of the Object data type, the default value is `null`, which means that Flash Player will convert the value `undefined` to `null` if you attempt to assign `undefined` to an Object instance.

## Type conversions

A type conversion is said to occur when a value is transformed into a value of a different data type. Type conversions can be either *implicit* or *explicit*. Implicit conversion, which is also called *coercion*, is sometimes performed by Flash Player at run time. For example, if the value `2` is assigned to a variable of the Boolean data type, Flash Player converts the value `2` to the Boolean value `true` before assigning the value to the variable. Explicit conversion, which is also called *casting*, occurs when your code instructs the compiler to treat a variable of one data type as if it belongs to a different data type. When primitive values are involved, casting actually converts values from one data type to another. To cast an object to a different type, you wrap the object name in parentheses and precede it with the name of the new type. For example, the following code takes a Boolean value and casts it to an integer:

```
var myBoolean:Boolean = true;
var myINT:int = int(myBoolean);
trace(myINT); // 1
```

## Implicit conversions

Implicit conversions happen at run time in a number of contexts:

- In assignment statements
- When values are passed as function arguments
- When values are returned from functions
- In expressions using certain operators, such as the addition (+) operator

For user-defined types, implicit conversions succeed when the value to be converted is an instance of the destination class or a class that derives from the destination class. If an implicit conversion is unsuccessful, an error occurs. For example, the following code contains a successful implicit conversion and an unsuccessful implicit conversion:

```
class A {}
class B extends A {}

var objA:A = new A();
var objB:B = new B();
var arr:Array = new Array();

objA = objB; // Conversion succeeds.
objB = arr; // Conversion fails.
```

For primitive types, implicit conversions are handled by calling the same internal conversion algorithms that are called by the explicit conversion functions. The following sections discuss these primitive type conversions in detail.

## Explicit conversions

It's helpful to use explicit conversions, or casting, when you compile in strict mode, because there may be times when you do not want a type mismatch to generate a compile-time error. This may be the case when you know that coercion will convert your values correctly at run time. For example, when working with data received from a form, you may want to rely on coercion to convert certain string values to numeric values. The following code generates a compile-time error even though the code would run correctly in standard mode:

```
var quantityField:String = "3";
var quantity:int = quantityField; // compile time error in strict mode
```

If you want to continue using strict mode, but would like the string converted to an integer, you can use explicit conversion, as follows:

```
var quantityField:String = "3";
var quantity:int = int(quantityField); // Explicit conversion succeeds.
```

## Casting to int, uint, and Number

You can cast any data type into one of the three number types: `int`, `uint`, and `Number`. If Flash Player is unable to convert the number for some reason, the default value of 0 is assigned for the `int` and `uint` data types, and the default value of `NaN` is assigned for the `Number` data type. If you convert a `Boolean` value to a number, `true` becomes the value 1 and `false` becomes the value 0.

```
var myBoolean:Boolean = true;
var myUINT:uint = uint(myBoolean);
var myINT:int = int(myBoolean);
var myNum:Number = Number(myBoolean);
trace(myUINT, myINT, myNum); // 1 1 1
myBoolean = false;
myUINT = uint(myBoolean);
myINT = int(myBoolean);
myNum = Number(myBoolean);
trace(myUINT, myINT, myNum); // 0 0 0
```

String values that contain only digits can be successfully converted into one of the number types. The number types can also convert strings that look like negative numbers or strings that represent a hexadecimal value (for example, `0x1A`). The conversion process ignores leading and trailing white space characters in the string value. You can also cast strings that look like floating-point numbers using `Number()`. The inclusion of a decimal point causes `uint()` and `int()` to return an integer, truncating the decimal and the characters following it. For example, the following string values can be cast into numbers:

```
trace(uint("5")); // 5
trace(uint("-5")); // 4294967291. It wraps around from MAX_VALUE
trace(uint(" 27 ")); // 27
trace(uint("3.7")); // 3
trace(int("3.7")); // 3
trace(int("0x1A")); // 26
trace(Number("3.7")); // 3.7
```

String values that contain non-numeric characters return 0 when cast with `int()` or `uint()` and `NaN` when cast with `Number()`. The conversion process ignores leading and trailing white space, but returns 0 or `NaN` if a string has white space separating two numbers.

```
trace(uint("5a")); // 0
trace(uint("ten")); // 0
trace(uint("17 63")); // 0
```

In ActionScript 3.0, the `Number()` function no longer supports octal, or base 8, numbers. If you supply a string with a leading zero to the ActionScript 2.0 `Number()` function, the number is interpreted as an octal number, and converted to its decimal equivalent. This is not true with the `Number()` function in ActionScript 3.0, which instead ignores the leading zero. For example, the following code generates different output when compiled using different versions of ActionScript:

```
trace(Number("044"));
// ActionScript 3.0 44
// ActionScript 2.0 36
```

Casting is not necessary when a value of one numeric type is assigned to a variable of a different numeric type. Even in strict mode, the numeric types are implicitly converted to the other numeric types. This means that in some cases, unexpected values may result when the range of a type is exceeded. The following examples all compile in strict mode, though some will generate unexpected values:

```
var myUInt:uint = -3; // Assign int/Number value to uint variable
trace(myUInt); // 4294967293

var myNum:Number = sampleUINT; // Assign int/uint value to Number variable
trace(myNum) // 4294967293

var myInt:int = uint.MAX_VALUE + 1; // Assign Number value to uint variable
trace(myInt); // 0

myInt = int.MAX_VALUE + 1; // Assign uint/Number value to int variable
trace(myInt); // -2147483648
```

The following table summarizes the results of casting to the `Number`, `int`, or `uint` data type from other data types.

Data type or value	Result of conversion to <code>Number</code> , <code>int</code> or <code>uint</code>
Boolean	If the value is <code>true</code> , 1; otherwise, 0.
Date	The internal representation of the <code>Date</code> object, which is the number of milliseconds since midnight January 1, 1970, universal time.
<code>null</code>	0
Object	If the instance is <code>null</code> and converted to <code>Number</code> , <code>NaN</code> ; otherwise, 0.
String	A number if Flash Player can convert the string to a number; otherwise, <code>NaN</code> if converted to <code>Number</code> , or 0 if converted to <code>int</code> or <code>uint</code> .
<code>undefined</code>	If converted to <code>Number</code> , <code>NaN</code> ; if converted to <code>int</code> or <code>uint</code> , 0.

## Casting to Boolean

Casting to Boolean from any of the numeric data types (`uint`, `int`, and `Number`) results in `false` if the numeric value is 0, and `true` otherwise. For the `Number` data type, the value `NaN` also results in `false`. The following example shows the results of casting the numbers -1, 0, and 1:

```
var myNum:Number;
for (myNum = -1; myNum<2; myNum++)
{
    trace("Boolean(" + myNum + ") is " + Boolean(myNum));
}
```

The output from the example shows that, of the three numbers, only 0 returns a value of `false`:

```
Boolean(-1) is true
Boolean(0) is false
Boolean(1) is true
```

Casting to Boolean from a `String` value returns `false` if the string is either `null` or an empty string (`"`). Otherwise, it returns `true`.

```
var str1:String;           // Uninitialized string is null.
trace(Boolean(str1));     // false

var str2:String = "";     // empty string
trace(Boolean(str2));     // false

var str3:String = " ";   // white space only
trace(Boolean(str3));     // true
```

Casting to Boolean from an instance of the `Object` class returns `false` if the instance is `null`; otherwise, it returns `true`:

```
var myObj:Object;        // Uninitialized object is null.
trace(Boolean(myObj));   // false

myObj = new Object();    // instantiate
trace(Boolean(myObj));   // true
```

Boolean variables get special treatment in strict mode in that you can assign values of any data type to a Boolean variable without casting. Implicit coercion from all data types to the Boolean data type occurs even in strict mode. In other words, unlike almost all other data types, casting to Boolean is not necessary to avoid strict mode errors. The following examples all compile in strict mode and behave as expected at run time:

```
var myObj:Object = new Object(); // instantiate
var bool:Boolean = myObj;
trace(bool); // true
bool = "random string";
trace(bool); // true
bool = new Array();
trace(bool); // true
bool = NaN;
trace(bool); // false
```

The following table summarizes the results of casting to the Boolean data type from other data types:

---

<b>Data type or value</b>	<b>Result of conversion to Boolean</b>
String	false if the value is null or the empty string (""); true otherwise.
null	false
Number, int or uint	false if the value is NaN or 0; true otherwise.
Object	false if the instance is null; true otherwise.

---

## Casting to String

Casting to the String data type from any of the numeric data types returns a string representation of the number. Casting to the String data type from a Boolean value returns the string “true” if the value is true, and returns the string “false” if the value is false.

Casting to the String data type from an instance of the Object class returns the string “null” if the instance is null. Otherwise, casting to the String type from the Object class returns the string “[object Object]”.

Casting to String from an instance of the Array class returns a string comprising a comma-delimited list of all the array elements. For example, the following cast to the String data type returns one string containing all three elements of the array:

```
var myArray:Array = ["primary", "secondary", "tertiary"];
trace(String(myArray)); // primary,secondary,tertiary
```

Casting to String from an instance of the Date class returns a string representation of the date that the instance contains. For example, the following example returns a string representation of the Date class instance (the output shows result for Pacific Daylight Time):

```
var myDate:Date = new Date(2005,6,1);
trace(String(myDate)); // Fri Jul 1 00:00:00 GMT-0700 2005
```

The following table summarizes the results of casting to the String data type from other data types.

Data type or value	Result of conversion to string
Array	A string comprising all array elements.
Boolean	"true" or "false"
Date	A string representation of the Date object.
null	"null"
Number, int or uint	A string representation of the number.
Object	If the instance is null, "null"; otherwise, "[object Object]".

## Syntax

The syntax of a language defines a set of rules that must be followed when writing executable code.

### Case sensitivity

ActionScript 3.0 is a case-sensitive language. Identifiers that differ only in case are considered different identifiers. For example, the following code creates two different variables:

```
var num1:int;
var Num1:int;
```

### Dot syntax

The dot operator (.) provides a way to access the properties and methods of an object. Using dot syntax, you can refer to a class property or method by using an instance name, followed by the dot operator and name of the property or method. For example, consider the following class definition:

```
class DotExample
{
```

```
public var prop1:String;
public function method1():void {}
}
```

Using dot syntax, you can access the `prop1` property and the `method1()` method by using the instance name created in the following code:

```
var myDotEx:DotExample = new DotExample();
myDotEx.prop1 = "hello";
myDotEx.method1();
```

You can use dot syntax when you define packages. You use the dot operator to refer to nested packages. For example, the `EventDispatcher` class resides in a package named `events` that is nested within the package named `flash`. You can refer to the `events` package using the following expression:

```
flash.events
```

You can also refer to the `EventDispatcher` class using this expression:

```
flash.events.EventDispatcher
```

## Slash syntax

Slash syntax is not supported in ActionScript 3.0. Slash syntax was used in earlier versions of ActionScript to indicate the path of a movie clip or variable.

## Literals

A *literal* is a value that appears directly in your code. The following examples are all literals:

```
17
"hello"
-3
9.4
null
undefined
true
false
```

Literals can also be grouped to form compound literals. Array literals are enclosed in bracket characters (`[]`) and use the comma to separate array elements.



An array literal can be used to initialize an array. The following examples show two arrays that are initialized using array literals. You can use the `new` statement and pass the compound literal as a parameter to the `Array` class constructor, but you can also assign literal values directly when instantiating instances of the following `ActionScript` core classes: `Object`, `Array`, `String`, `Number`, `int`, `uint`, `XML`, `XMLList` and `Boolean`.

```
// Use new statement.
var myStrings:Array = new Array(["alpha", "beta", "gamma"]);
var myNums:Array = new Array([1,2,3,5,8]);

// Assign literal directly.
var myStrings:Array = ["alpha", "beta", "gamma"];
var myNums:Array = [1,2,3,5,8];
```

Literals can also be used to initialize a generic object. A generic object is an instance of the `Object` class. Object literals are enclosed in curly braces (`{}`) and use the comma to separate object properties. Each property is declared with the colon character (`:`), which separates the name of the property from the value of the property.

You can create a generic object using the `new` statement, and pass the object literal as a parameter to the `Object` class constructor, or you can assign the object literal directly to the instance you are declaring. The following example creates a new generic object and initializes the object with three properties (`propA`, `propB`, and `propC`), each with values set to 1, 2, and 3, respectively:

```
// Use new statement.
var myObject:Object = new Object({propA:1, propB:2, propC:3});

// Assign literal directly.
var myObject:Object = {propA:1, propB:2, propC:3};
```

For more information, see [“Basics of strings” on page 204](#), [“Basics of regular expressions” on page 286](#), and [“Initializing XML variables” on page 354](#).

## Semicolons

You can use the semicolon character (`;`) to terminate a statement. Alternatively, if you omit the semicolon character, the compiler will assume that each line of code represents a single statement. Because many programmers are accustomed to using the semicolon to denote the end of a statement, your code may be easier to read if you consistently use semicolons to terminate your statements.

Using a semicolon to terminate a statement allows you to place more than one statement on a single line, but this may make your code more difficult to read.

## Parentheses

You can use parentheses (`()`) in three ways in ActionScript 3.0. First, you can use parentheses to change the order of operations in an expression. Operations that are grouped inside parentheses are always executed first. For example, parentheses are used to alter the order of operations in the following code:

```
trace(2 + 3 * 4);    // 14
trace( (2 + 3) * 4); // 20
```

Second, you can use parentheses with the comma operator (`,`) to evaluate a series of expressions and return the result of the final expression, as shown in the following example:

```
var a:int = 2;
var b:int = 3;
trace((a++, b++, a+b)); // 7
```

Third, you can use parentheses to pass one or more parameters to functions or methods, as shown in the following example, which passes a `String` value to the `trace()` function:

```
trace("hello"); // hello
```

## Comments

ActionScript 3.0 code supports two types of comments: single-line comments and multiline comments. These commenting mechanisms are similar to the commenting mechanisms in C++ and Java. The compiler will ignore text that is marked as a comment.

Single-line comments begin with two forward slash characters (`//`) and continue until the end of the line. For example, the following code contains a single-line comment:

```
var someNumber:Number = 3; // a single line comment
```

Multiline comments begin with a forward slash and asterisk (`/*`) and end with an asterisk and forward slash (`*/`).

```
/* This is multiline comment that can span
more than one line of code. */
```

## Keywords and reserved words

*Reserved words* are words that you cannot use as identifiers in your code because the words are reserved for use by ActionScript. Reserved words include *lexical keywords*, which are removed from the program namespace by the compiler. The compiler will report an error if you use a lexical keyword as an identifier. The following table lists ActionScript 3.0 lexical keywords.

---

as	break	case	catch
class	const	continue	default
delete	do	else	extends
false	finally	for	function
if	implements	import	in
instanceof	interface	internal	is
native	new	null	package
private	protected	public	return
super	switch	this	throw
to	true	try	typeof
use	var	void	while
with			

---

There is a small set of keywords, called *syntactic keywords*, that can be used as identifiers, but that have special meaning in certain contexts. The following table lists ActionScript 3.0 syntactic keywords.

---

each	get	set	namespace
include	dynamic	final	native
override	static		

---

There are also several identifiers that are sometimes referred to as *future reserved words*. These identifiers are not reserved by ActionScript 3.0, though some of them may be treated as keywords by software that incorporates ActionScript 3.0. You might be able to use many of these identifiers in your code, but Adobe recommends that you do not use them because they may appear as keywords in a subsequent version of the language.

---

abstract	boolean	byte	cast
char	debugger	double	enum
export	float	goto	intrinsic

---

---

long	prototype	short	synchronized
throws	to	transient	type
virtual	volatile		

---

## Constants

ActionScript 3.0 supports the `const` statement, which you can use to create constants.

Constants are properties with a fixed value that cannot be altered. You can assign a value to a constant only once, and the assignment must occur in close proximity to the declaration of the constant. For example, if a constant is declared as a member of a class, you can assign a value to that constant only as part of the declaration or inside the class constructor.

The following code declares two constants. The first constant, `MINIMUM`, has a value assigned as part of the declaration statement. The second constant, `MAXIMUM`, has a value assigned in the constructor.

```
class A
{
    public const MINIMUM:int = 0;
    public const MAXIMUM:int;

    public function A()
    {
        MAXIMUM = 10;
    }
}

var a:A = new A();
trace(a.MINIMUM); // 0
trace(a.MAXIMUM); // 10
```

An error results if you attempt to assign an initial value to a constant in any other way. For example, if you attempt to set the initial value of `MAXIMUM` outside the class, a run-time error will occur.

```
class A
{
    public const MINIMUM:int = 0;
    public const MAXIMUM:int;
}

var a:A = new A();
a["MAXIMUM"] = 10; // run-time error
```

The Flash Player API defines a wide range of constants for your use. By convention, constants in ActionScript use all capital letters, with words separated by the underscore character (\_). For example, the MouseEvent class definition uses this naming convention for its constants, each of which represents an event related to mouse input:

```
package flash.events
{
    public class MouseEvent extends Event
    {
        public static const CLICK:String           = "click";
        public static const DOUBLE_CLICK:String   = "doubleClick";
        public static const MOUSE_DOWN:String     = "mouseDown";
        public static const MOUSE_MOVE:String     = "mouseMove";
        ...
    }
}
```

## Operators

Operators are special functions that take one or more operands and return a value. An *operand* is a value—usually a literal, a variable, or an expression—that an operator uses as input. For example, in the following code, the addition (+) and multiplication (\*) operators are used with three literal operands (2, 3, and 4) to return a value. This value is then used by the assignment (=) operator to assign the returned value, 14, to the variable sumNumber.

```
var sumNumber:uint = 2 + 3 * 4; // uint = 14
```

Operators can be unary, binary, or ternary. A *unary* operator takes one operand. For example, the increment (++) operator is a unary operator, because it takes only one operand. A *binary* operator takes two operands. For example, the division (/) operator takes two operands. A *ternary* operator takes three operands. For example, the conditional (?:) operator takes three operands.

Some operators are *overloaded*, which means that they behave differently depending on the type or quantity of operands passed to them. The addition (+) operator is an example of an overloaded operator that behaves differently depending on the data type of the operands. If both operands are numbers, the addition operator returns the sum of the values. If both operands are strings, the addition operator returns the concatenation of the two operands. The following example code shows how the operator behaves differently depending on the operands:

```
trace(5 + 5); // 10
trace("5" + "5"); // 55
```

Operators can also behave differently based on the number of operands supplied. The subtraction (-) operator is both a unary and binary operator. When supplied with only one operand, the subtraction operator negates the operand and returns the result. When supplied with two operands, the subtraction operator returns the difference between the operands. The following example shows the subtraction operator used first as a unary operator, and then as a binary operator.

```
trace(-3); // -3
trace(7-2); // 5
```

## Operator precedence and associativity

Operator precedence and associativity determine the order in which operators are processed. Although it may seem natural to those familiar with arithmetic that the compiler processes the multiplication (\*) operator before the addition (+) operator, the compiler needs explicit instructions about which operators to process first. Such instructions are collectively referred to as *operator precedence*. ActionScript defines a default operator precedence that you can alter using the parentheses (()) operator. For example, the following code alters the default precedence in the previous example to force the compiler to process the addition operator before the multiplication operator:

```
var sumNumber:uint = (2 + 3) * 4; // uint == 20
```

You may encounter situations in which two or more operators of the same precedence appear in the same expression. In these cases, the compiler uses the rules of *associativity* to determine which operator to process first. All of the binary operators, except the assignment operators, are *left-associative*, which means that operators on the left are processed before operators on the right. The assignment operators and the conditional (?:) operator are *right-associative*, which means that the operators on the right are processed before operators on the left.

For example, consider the less-than (<) and greater-than (>) operators, which have the same precedence. If both operators are used in the same expression, the operator on the left is processed first because both operators are left-associative. This means that the following two statements produce the same output:

```
trace(3 > 2 < 1); // false
trace((3 > 2) < 1); // false
```

The greater-than operator is processed first, which results in a value of `true`, because the operand 3 is greater than the operand 2. The value `true` is then passed to the less-than operator along with the operand 1. The following code represents this intermediate state:

```
trace((true) < 1);
```

The less-than operator converts the value `true` to the numeric value 1 and compares that numeric value to the second operand 1 to return the value `false` (the value 1 is not less than 1).

```
trace(1 < 1); // false
```

You can alter the default left associativity with the parentheses operator. You can instruct the compiler to process the less-than operator first by enclosing that operator and its operands in parentheses. The following example uses the parentheses operator to produce a different output using the same numbers as the previous example:

```
trace(3 > (2 < 1)); // true
```

The less-than operator is processed first, which results in a value of `false` because the operand 2 is not less than the operand 1. The value `false` is then passed to the greater-than operator along with the operand 3. The following code represents this intermediate state:

```
trace(3 > (false));
```

The greater-than operator converts the value `false` to the numeric value 0 and compares that numeric value to the other operand 3 to return `true` (the value 3 is greater than 0).

```
trace(3 > 0); // true
```

The following table lists the operators for ActionScript 3.0 in order of decreasing precedence. Each row of the table contains operators of the same precedence. Each row of operators has higher precedence than the row appearing below it in the table.

---

Group	Operators
Primary	[ ] {x:y} () f(x) new x.y x[y] <></> @ :: ..
Postfix	x++ x--
Unary	++x --x + - ~ ! delete typeof void
Multiplicative	* / %
Additive	+ -
Bitwise shift	<< >> >>>
Relational	< > <= >= as in instanceof is
Equality	== != === !==
Bitwise AND	&
Bitwise XOR	^
Bitwise OR	
Logical AND	&&
Logical OR	

---

Group	Operators
Conditional	?:
Assignment	= *= /= %= += -= <<= >>= >>>= &= ^=  =
Comma	,

## Primary operators

The primary operators include those used for creating Array and Object literals, grouping expressions, calling functions, instantiating class instances, and accessing properties.

All the primary operators, as listed in the following table, have equal precedence. Operators that are part of the E4X specification are indicated by the (E4X) notation.

Operator	Operation performed
[]	Initializes an array
{x:y}	Initializes an object
()	Groups expressions
f(x)	Calls a function
new	Calls a constructor
x.y x[y]	Accesses a property
<></>	Initializes an XMLList object (E4X)
@	Accesses an attribute (E4X)
::	Qualifies a name (E4X)
..	Accesses a descendant XML element (E4X)

## Postfix operators

The postfix operators take one operator and either increment or decrement the value. Although these operators are unary operators, they are classified separately from the rest of the unary operators because of their higher precedence and special behavior. When a postfix operator is used as part of a larger expression, the expression's value is returned before the postfix operator is processed. For example, the following code shows how the value of the expression `xNum++` is returned before the value is incremented:

```
var xNum:Number = 0;
trace(xNum++); // 0
trace(xNum);   // 1
```



All the postfix operators, as listed in the following table, have equal precedence:

Operator	Operation performed
++	Increments (postfix)
--	Decrements (postfix)

## Unary operators

The unary operators take one operand. The increment (++) and decrement (--) operators in this group are *prefix operators*, which means that they appear before the operand in an expression. The prefix operators differ from their postfix counterparts in that the increment or decrement operation is completed before the value of the overall expression is returned. For example, the following code shows how the value of the expression ++xNum is returned after the value is incremented:

```
var xNum:Number = 0;
trace(++xNum); // 1
trace(xNum);   // 1
```

All the unary operators, as listed in the following table, have equal precedence:

Operator	Operation performed
++	Increments (prefix)
--	Decrements (prefix)
+	Unary +
-	Unary - (negation)
!	Logical NOT
~	Bitwise NOT
delete	Deletes a property
typeof	Returns type information
void	Returns undefined value

## Multiplicative operators

The multiplicative operators take two operands and perform multiplication, division, or modulo calculations.

All the multiplicative operators, as listed in the following table, have equal precedence:

Operator	Operation performed
*	Multiplication
/	Division
%	Modulo

## Additive operators

The additive operators take two operands and perform addition or subtraction calculations.

All the additive operators, as listed in the following table, have equal precedence:

Operator	Operation performed
+	Addition
-	Subtraction

## Bitwise shift operators

The bitwise shift operators take two operands and shift the bits of the first operand to the extent specified by the second operand. All the bitwise shift operators, as listed in the following table, have equal precedence:

Operator	Operation performed
<<	Bitwise left shift
>>	Bitwise right shift
>>>	Bitwise unsigned right shift

## Relational operators

The relational operators take two operands, compare their values, and return a Boolean value. All the relational operators, as listed in the following table, have equal precedence:

Operator	Operation performed
<	Less than
>	Greater than
<=	Less than or equal to
>=	Greater than or equal to
as	Checks data type
in	Checks for object properties
instanceof	Checks prototype chain
is	Checks data type

## Equality operators

The equality operators take two operands, compare their values, and return a Boolean value. All the equality operators, as listed in the following table, have equal precedence:

Operator	Operation performed
==	Equality
!=	Inequality
===	Strict equality
!==	Strict inequality

## Bitwise logical operators

The bitwise logical operators take two operands and perform bit-level logical operations. The bitwise logical operators differ in precedence and are listed in the following table in order of decreasing precedence:

Operator	Operation performed
&	Bitwise AND
^	Bitwise XOR
	Bitwise OR

## Logical operators

The logical operators take two operands and return a Boolean result. The logical operators differ in precedence and are listed in the following table in order of decreasing precedence:

Operator	Operation performed
&&	Logical AND
	Logical OR

## Conditional operator

The conditional operator is a ternary operator, which means that it takes three operands. The conditional operator is a shorthand method of applying the `if..else` conditional statement.

Operator	Operation performed
?:	Conditional

## Assignment operators

The assignment operators take two operands and assign a value to one operand, based on the value of the other operand. All the assignment operators, as listed in the following table, have equal precedence:

Operator	Operation performed
=	Assignment
*=	Multiplication assignment
/=	Division assignment
%=	Modulo assignment
+=	Addition assignment
-=	Subtraction assignment
<<=	Bitwise left shift assignment
>>=	Bitwise right shift assignment
>>>=	Bitwise unsigned right shift assignment
&=	Bitwise AND assignment
^=	Bitwise XOR assignment
=	Bitwise OR assignment

# Conditionals

ActionScript 3.0 provides three basic conditional statements that you can use to control program flow.

## if..else

The `if..else` conditional statement allows you to test a condition and execute a block of code if that condition exists, or execute an alternative block of code if the condition does not exist. For example, the following code tests whether the value of `x` exceeds 20, generates a `trace()` function if it does, or generates a different `trace()` function if it does not:

```
if (x > 20)
{
    trace("x is > 20");
}
else
{
    trace("x is <= 20");
}
```

If you do not want to execute an alternative block of code, you can use the `if` statement without the `else` statement.

## if..else if

You can test for more than one condition using the `if..else if` conditional statement. For example, the following code not only tests whether the value of `x` exceeds 20, but also tests whether the value of `x` is negative:

```
if (x > 20)
{
    trace("x is > 20");
}
else if (x < 0)
{
    trace("x is negative");
}
```

If an `if` or `else` statement is followed by only one statement, the statement does not need to be enclosed in braces. For example, the following code does not use braces:

```
if (x > 0)
    trace("x is positive");
else if (x < 0)
```

```
    trace("x is negative");
else
    trace("x is 0");
```

However, Adobe recommends that you always use braces, because unexpected behavior can occur if statements are later added to a conditional statement that lacks braces. For example, in the following code the value of `positiveNums` increases by 1 whether or not the condition evaluates to `true`:

```
var x:int;
var positiveNums:int = 0;

if (x > 0)
    trace("x is positive");
    positiveNums++;

trace(positiveNums); // 1
```

## switch

The `switch` statement is useful if you have several execution paths that depend on the same condition expression. It provides functionality similar to a long series of `if..else if` statements, but is somewhat easier to read. Instead of testing a condition for a Boolean value, the `switch` statement evaluates an expression and uses the result to determine which block of code to execute. Blocks of code begin with a `case` statement and end with a `break` statement. For example, the following `switch` statement prints the day of the week, based on the day number returned by the `Date.getDay()` method:

```
var someDate:Date = new Date();
var dayNum:uint = someDate.getDay();
switch(dayNum)
{
    case 0:
        trace("Sunday");
        break;
    case 1:
        trace("Monday");
        break;
    case 2:
        trace("Tuesday");
        break;
    case 3:
        trace("Wednesday");
        break;
    case 4:
        trace("Thursday");
        break;
```

```
case 5:
    trace("Friday");
    break;
case 6:
    trace("Saturday");
    break;
default:
    trace("Out of range");
    break;
}
```

## Looping

Looping statements allow you to perform a specific block of code repeatedly using a series of values or variables. Adobe recommends that you always enclose the block of code in braces (`{}`). Although you can omit the braces if the block of code contains only one statement, this practice is not recommended for the same reason that it is not recommended for conditionals: it increases the likelihood that statements added later will be inadvertently excluded from the block of code. If you later add a statement that you want to include in the block of code, but forget to add the necessary braces, the statement will not be executed as part of the loop.

### for

The `for` loop allows you to iterate through a variable for a specific range of values. You must supply three expressions in a `for` statement: a variable that is set to an initial value, a conditional statement that determines when the looping ends, and an expression that changes the value of the variable with each loop. For example, the following code loops five times. The value of the variable `i` starts at 0 and ends at 4, and the output will be the numbers 0 through 4, each on its own line.

```
var i:int;
for (i = 0; i < 5; i++)
{
    trace(i);
}
```

### for..in

The `for..in` loop iterates through the properties of an object, or the elements of an array. For example, you can use a `for..in` loop to iterate through the properties of a generic object (object properties are not kept in any particular order, so properties may appear in a seemingly random order):

```

var myObj:Object = {x:20, y:30};
for (var i:String in myObj)
{
    trace(i + ": " + myObj[i]);
}
// output:
// x: 20
// y: 30

```

You can also iterate through the elements of an array:

```

var myArray:Array = ["one", "two", "three"];
for (var i:String in myArray)
{
    trace(myArray[i]);
}
// output:
// one
// two
// three

```

What you cannot do is iterate through the properties of an object if it is an instance of a user-defined class, unless the class is a dynamic class. Even with instances of dynamic classes, you will be able to iterate only through properties that are added dynamically.

## for each..in

The `for each..in` loop iterates through the items of a collection, which can be tags in an XML or XMLList object, the values held by object properties, or the elements of an array. For example, as the following excerpt shows, you can use a `for each..in` loop to iterate through the properties of a generic object, but unlike the `for..in` loop, the iterator variable in a `for each..in` loop contains the value held by the property instead of the name of the property:

```

var myObj:Object = {x:20, y:30};
for each (var num in myObj)
{
    trace(num);
}
// output:
// 20
// 30

```

You can iterate through an XML or XMLList object, as the following example shows:

```

var myXML:XML = <users>
    <fname>Jane</fname>
    <fname>Susan</fname>
    <fname>John</fname>
</users>;

```



```
for each (var item in myXML.fname)
{
    trace(item);
}
/* output
Jane
Susan
John
*/
```

You can also iterate through the elements of an array, as this example shows:

```
var myArray:Array = ["one", "two", "three"];
for each (var item in myArray)
{
    trace(item);
}
// output:
// one
// two
// three
```

You cannot iterate through the properties of an object if the object is an instance of a sealed class. Even for instances of dynamic classes, you cannot iterate through any fixed properties, which are properties defined as part of the class definition.

## while

The `while` loop is like an `if` statement that repeats as long as the condition is `true`. For example, the following code produces the same output as the `for` loop example:

```
var i:int = 0;
while (i < 5)
{
    trace(i);
    i++;
}
```

One disadvantage of using a `while` loop instead of a `for` loop is that infinite loops are easier to write with `while` loops. The `for` loop example code does not compile if you omit the expression that increments the counter variable, but the `while` loop example does compile if you omit that step. Without the expression that increments `i`, the loop becomes an infinite loop.

## do..while

The `do..while` loop is a `while` loop that guarantees that the code block is executed at least once, because the condition is checked after the code block is executed. The following code shows a simple example of a `do..while` loop that generates output even though the condition is not met:

```
var i:int = 5;
do
{
    trace(i);
    i++;
} while (i < 5);
// output: 5
```

## Functions

*Functions* are blocks of code that carry out specific tasks and can be reused in your program. There are two types of functions in ActionScript 3.0: *methods* and *function closures*. Whether a function is called a method or a function closure depends on the context in which the function is defined. A function is called a method if you define it as part of a class definition or attach it to an instance of an object. A function is called a function closure if it is defined in any other way.

Functions have always been extremely important in ActionScript. In ActionScript 1.0, for example, the `class` keyword did not exist, so “classes” were defined by constructor functions. Although the `class` keyword has since been added to the language, a solid understanding of functions is still important if you want to take full advantage of what the language has to offer. This can be a challenge for programmers who expect ActionScript functions to behave similarly to functions in languages such as C++ or Java. Although basic function definition and invocation should not present a challenge to experienced programmers, some of the more advanced features of ActionScript functions require some explanation.

## Basic function concepts

This section discusses basic function definition and invocation techniques.

## Calling functions

You call a function by using its identifier followed by the parentheses operator (`()`). You use the parentheses operator to enclose any function parameters you want to send to the function. For example, the `trace()` function, which is a top-level function in the Flash Player API, is used throughout this book:

```
trace("Use trace to help debug your script");
```

If you are calling a function with no parameters, you must use an empty pair of parentheses. For example, you can use the `Math.random()` method, which takes no parameters, to generate a random number:

```
var randomNum:Number = Math.random();
```

## Defining your own functions

There are two ways to define a function in ActionScript 3.0: you can use a function statement or a function expression. The technique you choose depends on whether you prefer a more static or dynamic programming style. Define your functions with function statements if you prefer static, or strict mode, programming. Define your functions with function expressions if you have a specific need to do so. Function expressions are more often used in dynamic, or standard mode, programming.

## Function statements

Function statements are the preferred technique for defining functions in strict mode. A function statement begins with the `function` keyword, followed by:

- The function name
- The parameters, in a comma-delimited list enclosed in parentheses
- The function body—that is, the ActionScript code to be executed when the function is invoked, enclosed in curly braces

For example, the following code creates a function that defines a parameter and then invokes the function using the string “hello” as the parameter value:

```
function traceParameter(aParam:String)
{
    trace(aParam);
}

traceParameter("hello"); // hello
```

## Function expressions

The second way to declare a function is to use an assignment statement with a function expression, which is also sometimes called a function literal or an anonymous function. This is a more verbose method that is widely used in earlier versions of ActionScript.

An assignment statement with a function expression begins with the `var` keyword, followed by:

- The function name
- The colon operator (`:`)
- The `Function` class to indicate the data type
- The assignment operator (`=`)
- The `function` keyword
- The parameters, in a comma-delimited list enclosed in parentheses
- The function body—that is, the ActionScript code to be executed when the function is invoked, enclosed in curly braces

For example, the following code declares the `traceParameter` function using a function expression:

```
var traceParameter:Function = function (aParam:String)
{
    trace(aParam);
};
traceParameter("hello"); // hello
```

Notice that you do not specify a function name, as you do in a function statement. Another important difference between function expressions and function statements is that a function expression is an expression rather than a statement. This means that a function expression cannot stand on its own as a function statement can. A function expression can be used only as a part of a statement, usually an assignment statement. The following example shows a function expression assigned to an array element:

```
var traceArray:Array = new Array();
traceArray[0] = function (aParam:String)
{
    trace(aParam);
};
traceArray[0]("hello");
```

## Choosing between statements and expressions

As a general rule, use a function statement unless specific circumstances call for the use of an expression. Function statements are less verbose, and they provide a more consistent experience between strict mode and standard mode than function expressions.

Function statements are easier to read than assignment statements that contain function expressions. Function statements make your code more concise; they are less confusing than function expressions, which require you to use both the `var` and `function` keywords.

Function statements provide a more consistent experience between the two compiler modes in that you can use dot syntax in both strict and standard mode to invoke a method declared using a function statement. This is not necessarily true for methods declared with a function expression. For example, the following code defines a class named `Example` with two methods: `methodExpression()`, which is declared with a function expression, and `methodStatement()`, which is declared with a function statement. In strict mode, you cannot use dot syntax to invoke the `methodExpression()` method.

```
class Example
{
  var methodExpression = function() {}
  function methodStatement() {}
}
```

```
var myEx:Example = new Example();
myEx.methodExpression(); // error in strict mode; okay in standard mode
myEx.methodStatement(); // okay in strict and standard modes
```

Function expressions are considered better suited to programming that focuses on run-time, or dynamic, behavior. If you prefer to use strict mode, but also need to call a method declared with a function expression, you can use either of two techniques. First, you can call the method using square brackets (`[]`) instead of the dot (`.`) operator. The following method call succeeds in both strict mode and standard mode:

```
myExample["methodLiteral"]();
```

Second, you can declare the entire class as a dynamic class. Although this allows you to call the method using the dot operator, the downside is that you sacrifice some strict mode functionality for all instances of that class. For example, the compiler does not generate an error if you attempt to access an undefined property on an instance of a dynamic class.

There are some circumstances in which function expressions are useful. One common use of function expressions is for functions that are used only once and then discarded. Another less common use is for attaching a function to a prototype property. For more information, see [“The prototype object” on page 177](#).

There are two subtle differences between function statements and function expressions that you should take into account when choosing which technique to use. The first difference is that function expressions do not exist independently as objects with regard to memory management and garbage collection. In other words, when you assign a function expression to another object, such as an array element or an object property, you create the only reference to that function expression in your code. If the array or object to which your function expression is attached goes out of scope or is otherwise no longer available, you will no longer have access to the function expression. If the array or object is deleted, the memory that the function expression uses will become eligible for garbage collection, which means that the memory is eligible to be reclaimed and reused for other purposes.

The following example shows that for a function expression, once the property to which the expression is assigned is deleted, the function is no longer available. The class `Test` is dynamic, which means that you can add a property named `functionExp` that holds a function expression. The `functionExp()` function can be called with the dot operator, but once the `functionExp` property is deleted, the function is no longer accessible.

```
dynamic class Test {}
var myTest:Test = new Test();

// function expression
myTest.functionExp = function () { trace("Function expression") };
myTest.functionExp(); // Function expression
delete myTest.functionExp;
myTest.functionExp(); // error
```

If, on the other hand, the function is first defined with a function statement, it exists as its own object and continues to exist even after you delete the property to which it is attached. The `delete` operator only works on properties of objects, so even a call to delete the function `stateFunc()` itself does not work.

```
dynamic class Test {}
var myTest:Test = new Test();

// function statement
function stateFunc() { trace("Function statement") }
myTest.statement = stateFunc;
myTest.statement(); // Function statement
delete myTest.statement;
delete stateFunc; // no effect
stateFunc(); // Function statement
myTest.statement(); // error
```

The second difference between function statements and function expressions is that function statements exist throughout the scope in which they are defined, including in statements that appear before the function statement. Function expressions, by contrast, are defined only for subsequent statements. For example, the following code successfully calls the `scopeTest()` function before it is defined:

```
statementTest(); // statementTest

function statementTest():void
{
    trace("statementTest");
}
```

Function expressions are not available before they are defined, so the following code results in a run-time error:

```
expressionTest(); // run-time error

var expressionTest:Function = function ()
{
    trace("expressionTest");
}
```

## Returning values from functions

To return a value from your function, use the `return` statement followed by the expression or literal value that you want to return. For example, the following code returns an expression representing the parameter:

```
function doubleNum(baseNum:int):int
{
    return (baseNum * 2);
}
```

Notice that the `return` statement terminates the function, so that any statements below a `return` statement will not be executed, as follows:

```
function doubleNum(baseNum:int):int {
    return (baseNum * 2);
    trace("after return"); // This trace statement will not be executed.
}
```

In strict mode, you must return a value of the appropriate type if you choose to specify a return type. For example, the following code generates an error in strict mode, because it does not return a valid value:

```
function doubleNum(baseNum:int):int
{
    trace("after return");
}
```

## Nested functions

You can nest functions, which means that functions can be declared within other functions. A nested function is available only within its parent function unless a reference to the function is passed to external code. For example, the following code declares two nested functions inside the `getNameAndVersion()` function:

```
function getNameAndVersion():String
{
    function getVersion():String
    {
        return "9";
    }
    function getProductName():String
    {
        return "Flash Player";
    }
    return (getProductName() + " " + getVersion());
}
trace(getNameAndVersion()); // Flash Player 9
```

When nested functions are passed to external code, they are passed as function closures, which means that the function retains any definitions that are in scope when the function is defined. For more information, see [“Function closures” on page 136](#).

## Function parameters

ActionScript 3.0 provides some functionality for function parameters that may seem novel for programmers new to the language. Although the idea of passing parameters by value or reference should be familiar to most programmers, the `arguments` object and the `...` (rest) parameter may be new to many of you.



## Passing arguments by value or by reference

In many programming languages, it's important to understand the distinction between passing arguments by value or by reference; the distinction can affect the way code is designed.

To be passed by value means that the value of the argument is copied into a local variable for use within the function. To be passed by reference means that only a reference to the argument is passed instead of the actual value. No copy of the actual argument is made. Instead, a reference to the variable passed as an argument is created and assigned to a local variable for use within the function. As a reference to a variable outside the function, the local variable gives you the ability to change the value of the original variable.

In ActionScript 3.0, all arguments are passed by reference, because all values are stored as objects. However, objects that belong to the primitive data types, which includes Boolean, Number, int, uint, and String, have special operators that make them behave as if they were passed by value. For example, the following code creates a function named `passPrimitives()` that defines two parameters named `xParam` and `yParam`, both of type `int`. These parameters are similar to local variables declared inside the body of the `passPrimitives()` function. When the function is called with the arguments `xValue` and `yValue`, the parameters `xParam` and `yParam` are initialized with references to the `int` objects represented by `xValue` and `yValue`. Because the arguments are primitives, they behave as if passed by value. Although `xParam` and `yParam` initially contain only references to the `xValue` and `yValue` objects, any changes to the variables within the function body generate new copies of the values in memory.

```
function passPrimitives(xParam:int, yParam:int):void
{
    xParam++;
    yParam++;
    trace(xParam, yParam);
}
```

```
var xValue:int = 10;
var yValue:int = 15;
trace(xValue, yValue);           // 10 15
passPrimitives(xValue, yValue); // 11 16
trace(xValue, yValue);           // 10 15
```

Within the `passPrimitives()` function, the values of `xParam` and `yParam` are incremented, but this does not affect the values of `xValue` and `yValue`, as shown in the last `trace` statement. This would be true even if the parameters were named identically to the variables, `xValue` and `yValue`, because the `xValue` and `yValue` inside the function would point to new locations in memory that exist separately from the variables of the same name outside the function.

All other objects—that is, objects that do not belong to the primitive data types—are always passed by reference, which gives you ability to change the value of the original variable. For example, the following code creates an object named `objVar` with two properties, `x` and `y`. The object is passed as an argument to the `passByRef()` function. Because the object is not a primitive type, the object is not only passed by reference, but also stays a reference. This means that changes made to the parameters within the function will affect the object properties outside the function.

```
function passByRef(objParam:Object):void
{
    objParam.x++;
    objParam.y++;
    trace(objParam.x, objParam.y);
}
var objVar:Object = {x:10, y:15};
trace(objVar.x, objVar.y); // 10 15
passByRef(objVar);        // 11 16
trace(objVar.x, objVar.y); // 11 16
```

The `objParam` parameter references the same object as the global `objVar` variable. As you can see from the `trace` statements in the example, changes to the `x` and `y` properties of the `objParam` object are reflected in the `objVar` object.

## Default parameter values

New in ActionScript 3.0 is the ability to declare *default parameter values* for a function. If a call to a function with default parameter values omits a parameter with default values, the value specified in the function definition for that parameter is used. All parameters with default values must be placed at the end of the parameter list. The values assigned as default values must be compile-time constants. The existence of a default value for a parameter effectively makes that parameter an *optional parameter*. A parameter without a default value is considered a *required parameter*.

For example, the following code creates a function with three parameters, two of which have default values. When the function is called with only one parameter, the default values for the parameters are used.

```
function defaultValues(x:int, y:int = 3, z:int = 5):void
{
    trace(x, y, z);
}
defaultValues(1); // 1 3 5
```

## The arguments object

When parameters are passed to a function, you can use the `arguments` object to access information about the parameters passed to your function. Some important aspects of the `arguments` object include the following:

- The `arguments` object is an array that includes all the parameters passed to the function.
- The `arguments.length` property reports the number of parameters passed to the function.
- The `arguments.callee` property provides a reference to the function itself, which is useful for recursive calls to function expressions.

NOTE

The `arguments` object is not available if any parameter is named `arguments` or if you use the `... (rest)` parameter.

ActionScript 3.0 allows function calls to include more parameters than those defined in the function definition, but will generate a compiler error in strict mode if the number of parameters is less than the number of required parameters. You can use the array aspect of the `arguments` object to access any parameter passed to the function, whether or not that parameter is defined in the function definition. The following example uses the `arguments` array along with the `arguments.length` property to trace all the parameters passed to the `traceArgArray()` function:

```
function traceArgArray(x:int):void
{
    for (var i:uint = 0; i < arguments.length; i++)
    {
        trace(arguments[i]);
    }
}
```

```
traceArgArray(1, 2, 3);
```

```
// output:
// 1
// 2
// 3
```

The `arguments.callee` property is often used in anonymous functions to create recursion. You can use it to add flexibility to your code. If the name of a recursive function changes over the course of your development cycle, you need not worry about changing the recursive call in your function body if you use `arguments.callee` instead of the function name. The `arguments.callee` property is used in the following function expression to enable recursion:

```
var factorial:Function = function (x:uint)
{
    if(x == 0)
    {
        return 1;
    }
    else
    {
        return (x * arguments.callee(x - 1));
    }
}
```

```
trace(factorial(5)); // 120
```

If you use the ... (rest) parameter in your function declaration, the `arguments` object will not be available to you. Instead, you must access the parameters using the parameter names that you declared for them.

You should also be careful to avoid using the string “arguments” as a parameter name, because it will shadow the `arguments` object. For example, if the function `traceArgArray()` is rewritten so that an `arguments` parameter is added, the references to `arguments` in the function body refer to the parameter rather than the `arguments` object. The following code produces no output:

```
function traceArgArray(x:int, arguments:int):void
{
    for (var i:uint = 0; i < arguments.length; i++)
    {
        trace(arguments[i]);
    }
}
```

```
traceArgArray(1, 2, 3);
```

```
// no output
```

The `arguments` object in previous versions of ActionScript also contained a property named `caller`, which is a reference to the function that called the current function. The `caller` property is not present in ActionScript 3.0, but if you need a reference to the calling function, you can alter the calling function so that it passes an extra parameter that is a reference to itself.

## The ... (rest) parameter

ActionScript 3.0 introduces a new parameter declaration called the ... (rest) parameter. This parameter allows you to specify an array parameter that accepts any number of comma-delimited arguments. The parameter can have any name that is not a reserved word. This parameter declaration must be the last parameter specified. Use of this parameter makes the `arguments` object unavailable. Although the ... (rest) parameter gives you the same functionality as the `arguments` array and `arguments.length` property, it does not provide functionality similar to that provided by `arguments.callee`. You should ensure that you do not need to use `arguments.callee` before using the ... (rest) parameter.

The following example rewrites the `traceArgArray()` function using the ... (rest) parameter instead of the `arguments` object:

```
function traceArgArray(... args):void
{
    for (var i:uint = 0; i < args.length; i++)
    {
        trace(args[i]);
    }
}
```

```
traceArgArray(1, 2, 3);
```

```
// output:
// 1
// 2
// 3
```

The ... (rest) parameter can also be used with other parameters, as long as it is the last parameter listed. The following example modifies the `traceArgArray()` function so that its first parameter, `x`, is of type `int`, and the second parameter uses the ... (rest) parameter. The output skips the first value, because the first parameter is no longer part of the array created by the ... (rest) parameter.

```
function traceArgArray(x: int, ... args)
{
    for (var i:uint = 0; i < args.length; i++)
    {
        trace(args[i]);
    }
}
```

```
traceArgArray(1, 2, 3);
```

```
// output:
// 2
// 3
```

## Functions as objects

Functions in ActionScript 3.0 are objects. When you create a function, you are creating an object that can not only be passed as a parameter to another function, but also have properties and methods attached to it.

Functions passed as arguments to another function are passed by reference and not by value. When you pass a function as an argument, you use only the identifier and not the parentheses operator that you use to call the method. For example, the following code passes a function named `clickListener()` as an argument to the `addEventListener()` method:

```
addEventListener(MouseEvent.CLICK, clickListener);
```

The `Array.sort()` method also defines a parameter that accepts a function. For an example of a custom sort function that is used as an argument to the `Array.sort()` function, see [“Sorting an array” on page 229](#).

Although it may seem strange to programmers new to ActionScript, functions can have properties and methods, just as any other object can. In fact, every function has a read-only property named `length` that stores the number of parameters defined for the function. This is different from the `arguments.length` property, which reports the number of arguments sent to the function. Recall that in ActionScript, the number of arguments sent to a function can exceed the number of parameters defined for that function. The following example, which compiles only in standard mode because strict mode requires an exact match between the number of arguments passed and the number of parameters defined, shows the difference between the two properties:

```
function traceLength(x:uint, y:uint):void
{
    trace("arguments received: " + arguments.length);
    trace("arguments expected: " + traceLength.length);
}
```

```
traceLength(3, 5, 7, 11);
/* output:
arguments received: 4
arguments expected: 2 */
```

You can define your own function properties by defining them outside your function body. Function properties can serve as quasi-static properties that allow you to save the state of a variable related to the function. For example, you may want to track the number of times a particular function is called. Such functionality could be useful if you are writing a game and want to track the number of times a user uses a specific command, although you could also use a static class property for this. The following code creates a function property outside the function declaration and increments the property each time the function is called:

```
someFunction.counter = 0;

function someFunction():void
{
    someFunction.counter++;
}

someFunction();
someFunction();
trace(someFunction.counter); // 2
```

## Function scope

A function's scope determines not only where in a program that function can be called, but also what definitions the function can access. The same scope rules that apply to variable identifiers apply to function identifiers. A function declared in the global scope is available throughout your code. For example, ActionScript 3.0 contains global functions, such as `isNaN()` and `parseInt()`, that are available anywhere in your code. A nested function—a function declared within another function—can be used anywhere in the function in which it was declared.

## The scope chain

Any time a function begins execution, a number of objects and properties are created. First, a special object called an *activation object* is created that stores the parameters and any local variables or functions declared in the function body. You cannot access the activation object directly, because it is an internal mechanism. Second, a *scope chain* is created that contains an ordered list of objects that Flash Player checks for identifier declarations. Every function that executes has a scope chain that is stored in an internal property. For a nested function, the scope chain starts with its own activation object, followed by its parent function's activation object. The chain continues in this manner until it reaches the global object. The global object is created when an ActionScript program begins, and contains all global variables and functions.

## Function closures

A *function closure* is an object that contains a snapshot of a function and its *lexical environment*. A function's lexical environment includes all the variables, properties, methods, and objects in the function's scope chain, along with their values. Function closures are created any time a function is executed apart from an object or a class. The fact that function closures retain the scope in which they were defined creates interesting results when a function is passed as an argument or a return value into a different scope.

For example, the following code creates two functions: `foo()`, which returns a nested function named `rectArea()` that calculates the area of a rectangle, and `bar()`, which calls `foo()` and stores the returned function closure in a variable named `myProduct`. Even though the `bar()` function defines its own local variable `x` (with a value of 2), when the function closure `myProduct()` is called, it retains the variable `x` (with a value of 40) defined in function `foo()`. The `bar()` function therefore returns the value 160 instead of 8.

```
function foo():Function
{
    var x:int = 40;
    function rectArea(y:int):int // function closure defined
    {
        return x * y
    }
    return rectArea;
}
function bar():void
{
    var x:int = 2;
    var y:int = 4;
    var myProduct:Function = foo();
    trace(myProduct(4)); // function closure called
}
bar(); // 160
```

Methods behave similarly in that they also retain information about the lexical environment in which they were created. This characteristic is most noticeable when a method is extracted from its instance, which creates a bound method. The main difference between a function closure and a bound method is that the value of the `this` keyword in a bound method always refers to the instance to which it was originally attached, whereas in a function closure the value of the `this` keyword can change. For more information, see [“Bound methods” on page 154](#).



# Object-oriented programming in ActionScript

This chapter describes the elements of ActionScript that support object-oriented programming (OOP). The chapter does not describe general OOP principles such as object design, abstraction, encapsulation, inheritance, and polymorphism. The chapter focuses on how to apply these principles using ActionScript 3.0.

Because of ActionScript's roots as a scripting language, ActionScript 3.0 OOP support is optional. This affords programmers flexibility in choosing the best approach for projects of varying scope and complexity. For small tasks, you may find that using ActionScript with a procedural programming paradigm is all you need. For larger projects, applying OOP principles can make your code easier to understand, maintain, and extend.

## Contents

Basics of object-oriented programming .....	138
Classes .....	140
Interfaces .....	158
Inheritance .....	162
Advanced topics .....	171
Example: GeometricShapes .....	180

# Basics of object-oriented programming

## Introduction to object-oriented programming

Object-oriented programming (OOP) is a way of organizing the code in a program by grouping it into objects—individual elements that include information (data values) and functionality. Using an object-oriented approach to organizing a program allows you to group particular pieces of information (for example, music information like album title, track title, or artist name) together with common functionality or actions associated with that information (such as “add track to playlist” or “play all songs by this artist”). These items are combined into a single item, an object (for example, an “Album” or “MusicTrack”). Being able to bundle these values and functions together provides several benefits, including only needing to keep track of a single variable rather than multiple ones, organizing related functionality together, and being able to structure programs in ways that more closely match the real world.

## Common object-oriented programming tasks

In practice, object-oriented programming has two parts. One part is the strategies and techniques for designing a program (often called *object-oriented design*). This is a broad subject and is not discussed in this chapter. The other part of OOP is the actual programming structures that are available in a given programming language to build a program using an object-oriented approach. This chapter covers the following common tasks in OOP:

- Defining classes
- Creating properties, methods, and get and set accessors (accessor methods)
- Controlling access to classes, properties, methods, and accessors
- Creating static properties and methods
- Creating enumeration-like structures
- Defining and using interfaces
- Working with inheritance, including overriding class elements

## Important concepts and terms

The following reference list contains important terms that you will encounter in this chapter:

- **Attribute:** A characteristic assigned to a class element (such as a property or method) in the class definition. Attributes are commonly used to define whether the property or method will be available for access by code in other parts of the program. For example, `private` and `public` are attributes. A private method can be called only by code within the class, while a public method can be called by any code in the program.
- **Class:** The definition of the structure and behavior of objects of a certain type (like a template or blueprint for objects of that data type).
- **Class hierarchy:** The structure of multiple related classes, specifying which classes inherit functionality from other classes.
- **Constructor:** A special method you can define in a class, which is called when an instance of the class is created. A constructor is commonly used to specify default values or otherwise perform setup operations for the object.
- **Data type:** The type of information that a particular variable can store. In general, *data type* means the same thing as *class*.
- **Dot operator:** The period sign (`.`), which in ActionScript (and many other programming languages) is used to indicate that a name refers to a child element of an object (such as a property or method). For instance, in the expression `myObject.myProperty`, the dot operator indicates that the term `myProperty` is referring to some value that is an element of the object named `myObject`.
- **Enumeration:** A set of related constant values, grouped together for convenience as properties of a single class.
- **Inheritance:** The OOP mechanism that allows one class definition to include all the functionality of a different class definition (and generally add to that functionality).
- **Instance:** An actual object created in a program.
- **Namespace:** Essentially a custom attribute, allowing more refined control over which code can access other code.

## Working through in-chapter examples

As you're working through the chapter, you may want to test some of the example code listings for yourself. Because the code listings in this chapter deal primarily with defining and manipulating data types, testing the examples will involve creating an instance of the class being defined, manipulating that instance using its properties or methods, and then viewing the values of the that instance's properties. For viewing those values, you'll want to write values into a text field instance on the Stage, or use the `trace()` function to print values to the Output panel. These techniques are described in detail in [“Testing in-chapter example code listings” on page 63](#).

## Classes

A class is an abstract representation of an object. A class stores information about the types of data that an object can hold and the behaviors that an object can exhibit. The usefulness of such an abstraction may not be apparent when you write small scripts that contain only a few objects interacting with one another. As the scope of a program grows, however, and the number of objects that must be managed increases, you may find that classes allow you to better control how objects are created and how they interact with one another.

As far back as ActionScript 1.0, ActionScript programmers could use Function objects to create constructs that resembled classes. ActionScript 2.0 added formal support for classes with keywords such as `class` and `extends`. ActionScript 3.0 not only continues to support the keywords introduced in ActionScript 2.0, but also adds some new capabilities, such as enhanced access control with the `protected` and `internal` attributes, and better control over inheritance with the `final` and `override` keywords.

If you have ever created classes in programming languages like Java, C++, or C#, you will find that ActionScript provides a familiar experience. ActionScript shares many of the same keywords and attribute names, such as `class`, `extends`, and `public`, all of which are discussed in the following sections.

### NOTE

In this chapter, the term *property* means any member of an object or class, including variables, constants, and methods. In addition, although the terms *class* and *static* are often used interchangeably, in this chapter these terms are distinct. For example, in this chapter the phrase *class properties* refers to all the members of a class, rather than only the static members.

## Class definitions

ActionScript 3.0 class definitions use syntax that is similar to that used in ActionScript 2.0 class definitions. Proper syntax for a class definition calls for the `class` keyword followed by the class name. The class body, which is enclosed by curly braces (`{}`), follows the class name. For example, the following code creates a class named `Shape` that contains one variable, named `visible`:

```
public class Shape
{
    var visible:Boolean = true;
}
```

One significant syntax change involves class definitions that are inside a package. In ActionScript 2.0, if a class is inside a package, the package name must be included in the class declaration. In ActionScript 3.0, which introduces the `package` statement, the package name must be included in the package declaration instead of in the class declaration. For example, the following class declarations show how the `BitmapData` class, which is part of the `flash.display` package, is defined in ActionScript 2.0 and ActionScript 3.0:

```
// ActionScript 2.0
class flash.display.BitmapData {}

// ActionScript 3.0
package flash.display
{
    public class BitmapData {}
}
```

## Class attributes

ActionScript 3.0 allows you to modify class definitions using one of the following four attributes:

Attribute	Definition
<code>dynamic</code>	Allow properties to be added to instances at run time.
<code>final</code>	Must not be extended by another class.
<code>internal</code> (default)	Visible to references inside the current package.
<code>public</code>	Visible to references everywhere.

For each of these attributes, except for `internal`, you must explicitly include the attribute to get the associated behavior. For example, if you do not include the `dynamic` attribute when defining a class, you will not be able to add properties to a class instance at run time. You explicitly assign an attribute by placing it at the beginning of the class definition, as the following code demonstrates:

```
dynamic class Shape {}
```

Notice that the list does not include an attribute named `abstract`. This is because abstract classes are not supported in ActionScript 3.0. Notice also that the list does not include attributes named `private` and `protected`. These attributes have meaning only inside a class definition, and cannot be applied to classes themselves. If you do not want a class to be publicly visible outside a package, place the class inside a package and mark the class with the `internal` attribute. Alternatively, you can omit both the `internal` and `public` attributes, and the compiler will automatically add the `internal` attribute for you. If you do not want a class to be visible outside the source file in which it is defined, place the class at the bottom of your source file, below the closing curly brace of the package definition.

## Class body

The class body, which is enclosed by curly braces, is used to define the variables, constants, and methods of your class. The following example shows the declaration for the Accessibility class in the Adobe Flash Player API:

```
public final class Accessibility
{
    public static function get active():Boolean;
    public static function updateProperties():void;
}
```

You can also define a namespace inside a class body. The following example shows how a namespace can be defined within a class body and used as an attribute of a method in that class:

```
public class SampleClass
{
    public namespace sampleNamespace;
    sampleNamespace function doSomething():void;
}
```

ActionScript 3.0 allows you to include not only definitions in a class body, but also statements. Statements that are inside a class body, but outside a method definition, are executed exactly once—when the class definition is first encountered and the associated class object is created. The following example includes a call to an external function, `hello()`, and a trace statement that outputs a confirmation message when the class is defined:

```
function hello():String
{
    trace("hola");
}
class SampleClass
{
    hello();
    trace("class created");
}
// output when class is created
hola
class created
```

In contrast to previous versions of ActionScript, in ActionScript 3.0 it is permissible to define a static property and an instance property with the same name in the same class body. For example, the following code declares a static variable named `message` and an instance variable of the same name:

```
class StaticTest
{
    static var message:String = "static variable";
    var message:String = "instance variable";
}
```

```

}
// In your script
var myST:StaticTest = new StaticTest();
trace(StaticTest.message); // output: static variable
trace(myST.message);      // output: instance variable

```

## Class property attributes

In discussions of the ActionScript object model, the term *property* means anything that can be a member of a class, including variables, constants, and methods. This differs from the way the term is used in the *ActionScript 3.0 Language and Components Reference*, where the term is used more narrowly and includes only class members that are variables or are defined by a getter or setter method. In ActionScript 3.0, there is a set of attributes that can be used with any property of a class. The following table lists this set of attributes.

Attribute	Definition
<code>internal</code> (default)	Visible to references inside the same package.
<code>private</code>	Visible to references in the same class.
<code>protected</code>	Visible to references in the same class and derived classes.
<code>public</code>	Visible to references everywhere.
<code>static</code>	Specifies that a property belongs to the class, as opposed to instances of the class.
<code>UserDefinedNamespace</code>	Custom namespace name defined by user.

## Access control namespace attributes

ActionScript 3.0 provides four special attributes that control access to properties defined inside a class: `public`, `private`, `protected`, and `internal`.

The `public` attribute makes a property visible anywhere in your script. For example, to make a method available to code outside its package, you must declare the method with the `public` attribute. This is true for any property, whether it is declared using the `var`, `const`, or `function` keywords.

The `private` attribute makes a property visible only to callers within the property's defining class. This behavior differs from that of the `private` attribute in ActionScript 2.0, which allowed a subclass to access a private property in a superclass. Another significant change in behavior has to do with run-time access. In ActionScript 2.0, the `private` keyword prohibited access only at compile time and was easily circumvented at run time. In ActionScript 3.0, this is no longer true. Properties that are marked as `private` are unavailable at both compile time and run time.



For example, the following code creates a simple class named `PrivateExample` with one private variable, and then attempts to access the private variable from outside the class. In ActionScript 2.0, compile-time access was prohibited, but the prohibition was easily circumvented by using the property access operator (`[]`), which does the property lookup at run time rather than at compile time.

```
class PrivateExample
{
    private var privVar:String = "private variable";
}

var myExample:PrivateExample = new PrivateExample();
trace(myExample.privVar); // compile-time error in strict mode
trace(myExample["privVar"]); // ActionScript 2.0 allows access, but in
    ActionScript 3.0, this is a run-time error.
```

In ActionScript 3.0, an attempt to access a private property using the dot operator (`myExample.privVar`) results in a compile-time error if you are using strict mode. Otherwise, the error is reported at run time, just as it is when you use the property access operator (`myExample["privVar"]`).

The following table summarizes the results of attempting to access a private property that belongs to a sealed (not dynamic) class:

---

	<b>Strict mode</b>	<b>Standard mode</b>
dot operator ( <code>.</code> )	compile-time error	run-time error
bracket operator ( <code>[]</code> )	run-time error	run-time error

---

In classes declared with the `dynamic` attribute, attempts to access a private variable will not result in a run-time error. Instead, the variable is simply not visible, so Flash Player returns the value `undefined`. A compile-time error occurs, however, if you use the dot operator in strict mode. The following example is the same as the previous example, except that the `PrivateExample` class is declared as a dynamic class:

```
dynamic class PrivateExample
{
    private var privVar:String = "private variable";
}

var myExample:PrivateExample = new PrivateExample();
trace(myExample.privVar); // compile-time error in strict mode
trace(myExample["privVar"]); // output: undefined
```

Dynamic classes generally return the value `undefined` instead of generating an error when code external to a class attempts to access a private property. The following table shows that an error is generated only when the dot operator is used to access a private property in strict mode:

	Strict mode	Standard mode
dot operator (.)	compile-time error	undefined
bracket operator ([ ])	undefined	undefined

The `protected` attribute, which is new for ActionScript 3.0, makes a property visible to callers within its own class or in a subclass. In other words, a protected property is available within its own class or to classes that lie anywhere below it in the inheritance hierarchy. This is true whether the subclass is in the same package or in a different package.

For those familiar with ActionScript 2.0, this functionality is similar to the `private` attribute in ActionScript 2.0. The ActionScript 3.0 `protected` attribute is also similar to the `protected` attribute in Java, but differs in that the Java version also permits access to callers within the same package. The `protected` attribute is useful when you have a variable or method that your subclasses need but that you want to hide from code that is outside the inheritance chain.

The `internal` attribute, which is new for ActionScript 3.0, makes a property visible to callers within its own package. This is the default attribute for code inside a package, and it applies to any property that does not have any of the following attributes:

- `public`
- `private`
- `protected`
- a user-defined namespace

The `internal` attribute is similar to the default access control in Java, although in Java there is no explicit name for this level of access, and it can be achieved only through the omission of any other access modifier. The `internal` attribute is available in ActionScript 3.0 to give you the option of explicitly signifying your intent to make a property visible only to callers within its own package.

## static attribute

The `static` attribute, which can be used with properties declared with the `var`, `const`, or `function` keywords, allows you to attach a property to the class rather than to instances of the class. Code external to the class must call static properties by using the class name instead of an instance name.

Static properties are not inherited by subclasses, but the properties are part of a subclass's scope chain. This means that within the body of a subclass, a static variable or method can be used without referencing the class in which it was defined. For more information, see [“Static properties not inherited” on page 169](#).

## User-defined namespace attributes

As an alternative to the predefined access control attributes, you can create a custom namespace for use as an attribute. Only one namespace attribute can be used per definition, and you cannot use a namespace attribute in combination with any of the access control attributes (`public`, `private`, `protected`, `internal`). For more information about using namespaces, see [“Namespaces” on page 75](#).

## Variables

Variables can be declared with either the `var` or `const` keywords. Variables declared with the `var` keyword can have their values changed multiple times throughout the execution of a script. Variables declared with the `const` keyword are called *constants*, and can have values assigned to them only once. An attempt to assign a new value to an initialized constant results in an error. For more information, see [“Constants” on page 108](#).

## Static variables

Static variables are declared using a combination of the `static` keyword and either the `var` or `const` statement. Static variables, which are attached to a class rather than an instance of a class, are useful for storing and sharing information that applies to an entire class of objects. For example, a static variable is appropriate if you want to keep a tally of the number of times a class is instantiated or if you want to store the maximum number of class instances that are allowed.

The following example creates a `totalCount` variable to track the number of class instantiations and a `MAX_NUM` constant to store the maximum number of instantiations. The `totalCount` and `MAX_NUM` variables are static, because they contain values that apply to the class as a whole rather than to a particular instance.

```
class StaticVars
{
    public static var totalCount:int = 0;
    public static const MAX_NUM:uint = 16;
}
```

Code that is external to the `StaticVars` class and any of its subclasses can reference the `totalCount` and `MAX_NUM` properties only through the class itself. For example, the following code works:

```
trace(StaticVars.totalCount); // output: 0
trace(StaticVars.MAX_NUM); // output: 16
```

You cannot access static variables through an instance of the class, so the following code returns errors:

```
var myStaticVars:StaticVars = new StaticVars();
trace(myStaticVars.totalCount); // error
trace(myStaticVars.MAX_NUM); // error
```

Variables that are declared with both the `static` and `const` keywords must be initialized at the same time as you declare the constant, as the `StaticVars` class does for `MAX_NUM`. You cannot assign a value to `MAX_NUM` inside the constructor or an instance method. The following code will generate an error, because it is not a valid way to initialize a static constant:

```
// !! Error to initialize static constant this way
class StaticVars2
{
    public static const UNIQUESORT:uint;
    function initializeStatic():void
    {
        UNIQUESORT = 16;
    }
}
```

## Instance variables

Instance variables include properties declared with the `var` and `const` keywords, but without the `static` keyword. Instance variables, which are attached to class instances rather than to an entire class, are useful for storing values that are specific to an instance. For example, the `Array` class has an instance property named `length`, which stores the number of array elements that a particular instance of the `Array` class holds.

Instance variables, whether declared as `var` or `const`, cannot be overridden in a subclass. You can, however, achieve functionality that is similar to overriding variables by overriding getter and setter methods. For more information, see [“Get and set accessor methods” on page 153](#).

## Methods

Methods are functions that are part of a class definition. Once an instance of the class is created, a method is bound to that instance. Unlike a function declared outside a class, a method cannot be used apart from the instance to which it is attached.

Methods are defined using the `function` keyword. You can use a function statement such as the following:

```
public function sampleFunction():String {}
```

Or you can use a variable to which you assign a function expression, as follows:

```
public var sampleFunction:Function = function () {}
```

In most cases you will want to use a function statement instead of a function expression for the following reasons:

- Function statements are more concise and easier to read.
- Function statements allow you to use the `override` and `final` keywords. For more information, see [“Overriding methods” on page 167](#).
- Function statements create a stronger bond between the identifier—that is, the name of the function—and the code within the method body. Because the value of a variable can be changed with an assignment statement, the connection between a variable and its function expression can be severed at any time. Although you can work around this issue by declaring the variable with `const` instead of `var`, such a technique is not considered a best practice, because it makes the code hard to read and prevents the use of the `override` and `final` keywords.

One case in which you must use a function expression is when you choose to attach a function to the prototype object. For more information, see [“The prototype object” on page 177](#).

## Constructor methods

Constructor methods, sometimes simply called *constructors*, are functions that share the same name as the class in which they are defined. Any code that you include in a constructor method is executed whenever an instance of the class is created with the `new` keyword. For example, the following code defines a simple class named `Example` that contains a single property named `status`. The initial value of the `status` variable is set inside the constructor function.

```
class Example
{
    public var status:String;
    public function Example()
    {
        status = "initialized";
    }
}

var myExample:Example = new Example();
trace(myExample.status); // output: initialized
```

Constructor methods can only be public, but the use of the `public` attribute is optional. You cannot use any of the other access control specifiers, including `private`, `protected`, or `internal`, on a constructor. You also cannot use a user-defined namespace with a constructor method.

A constructor can make an explicit call to the constructor of its direct superclass by using the `super()` statement. If the superclass constructor is not explicitly called, the compiler automatically inserts a call before the first statement in the constructor body. You can also call methods of the superclass by using the `super` prefix as a reference to the superclass. If you decide to use both `super()` and `super` in the same constructor body, be sure to call `super()` first. Otherwise, the `super` reference will not behave as expected. The `super()` constructor should also be called before any `throw` or `return` statement.

The following example demonstrates what happens if you attempt to use the `super` reference before calling the `super()` constructor. A new class, `ExampleEx`, extends the `Example` class. The `ExampleEx` constructor attempts to access the status variable defined in its superclass, but does so before calling `super()`. The `trace()` statement inside the `ExampleEx` constructor produces the value `null`, because the `status` variable is not available until the `super()` constructor executes.

```
class ExampleEx extends Example
{
    public function ExampleEx()
    {
        trace(super.status);
        super();
    }
}

var mySample:ExampleEx = new ExampleEx(); // output: null
```

Although it is legal to use the `return` statement inside a constructor, it is not permissible to return a value. In other words, `return` statements must not have associated expressions or values. Accordingly, constructor methods are not allowed to return values, which means that no return type may be specified.

If you do not define a constructor method in your class, the compiler will automatically create an empty constructor for you. If your class extends another class, the compiler will include a `super()` call in the constructor it generates.

## Static methods

Static methods, also called *class methods*, are methods that are declared with the `static` keyword. Static methods, which are attached to a class rather than to an instance of a class, are useful for encapsulating functionality that affects something other than the state of an individual instance. Because static methods are attached to a class as a whole, static methods can be accessed only through a class and not through an instance of the class.

Static methods are useful for encapsulating functionality that is not limited to affecting the state of class instances. In other words, a method should be static if it provides functionality that does not directly affect the value of a class instance. For example, the `Date` class has a static method named `parse()`, which takes a string and converts it to a number. The method is static because it does not affect an individual instance of the class. Instead, the `parse()` method takes a string that represents a date value, parses the string, and returns a number in a format compatible with the internal representation of a `Date` object. This method is not an instance method, because it does not make sense to apply the method to an instance of the `Date` class.

Contrast the static `parse()` method with one of the instance methods of the `Date` class, such as `getMonth()`. The `getMonth()` method is an instance method, because it operates directly on the value of an instance by retrieving a specific component, the month, of a `Date` instance.

Because static methods are not bound to individual instances, you cannot use the keywords `this` or `super` within the body of a static method. Both the `this` reference and the `super` reference have meaning only within the context of an instance method.

In contrast with some other class-based programming languages, static methods in ActionScript 3.0 are not inherited. For more information, see [“Static properties not inherited” on page 169](#).

## Instance methods

Instance methods are methods that are declared without the `static` keyword. Instance methods, which are attached to instances of a class instead of the class as a whole, are useful for implementing functionality that affects individual instances of a class. For example, the `Array` class contains an instance method named `sort()`, which operates directly on `Array` instances.

Within the body of an instance method, both static and instance variables are in scope, which means that variables defined in the same class can be referenced using a simple identifier. For example, the following class, `CustomArray`, extends the `Array` class. The `CustomArray` class defines a static variable named `arrayCountTotal` to track the total number of class instances, an instance variable named `arrayNumber` that tracks the order in which the instances were created, and an instance method named `getPosition()` that returns the values of these variables.

```
public class CustomArray extends Array
{
    public static var arrayCountTotal:int = 0;
    public var arrayNumber:int;

    public function CustomArray()
    {
        arrayNumber = ++arrayCountTotal;
    }

    public function getArrayPosition():String
    {
        return ("Array " + arrayNumber + " of " + arrayCountTotal);
    }
}
```

Although code external to the class must refer to the `arrayCountTotal` static variable through the class object using `CustomArray.arrayCountTotal`, code that resides inside the body of the `getPosition()` method can refer directly to the static `arrayCountTotal` variable. This is true even for static variables in superclasses. Though static properties are not inherited in ActionScript 3.0, static properties in superclasses are in scope. For example, the `Array` class has a few static variables, one of which is a constant named `DESCENDING`. Code that resides in an `Array` subclass can refer to the static constant `DESCENDING` using a simple identifier:

```
public class CustomArray extends Array
{
    public function testStatic():void
    {
        trace(DESCENDING); // output: 2
    }
}
```

The value of the `this` reference within the body of an instance method is a reference to the instance to which the method is attached. The following code demonstrates that the `this` reference points to the instance that contains the method:

```
class ThisTest
{
```



```

function thisValue():ThisTest
{
    return this;
}
}

var myTest:ThisTest = new ThisTest();
trace(myTest.thisValue() == myTest); // output: true

```

Inheritance of instance methods can be controlled with the keywords `override` and `final`. You can use the `override` attribute to redefine an inherited method, and the `final` attribute to prevent subclasses from overriding a method. For more information, see [“Overriding methods” on page 167](#).

## Get and set accessor methods

Get and set accessor functions, also called *getters* and *setters*, allow you to adhere to the programming principles of information hiding and encapsulation while providing an easy-to-use programming interface for the classes that you create. Get and set functions allow you to keep your class properties private to the class, but allow users of your class to access those properties as if they were accessing a class variable instead of calling a class method.

The advantage of this approach is that it allows you to avoid the traditional accessor functions with unwieldy names, such as `getPropertyName()` and `setPropertyName()`. Another advantage of getters and setters is that you can avoid having two public-facing functions for each property that allows both read and write access.

The following example class, named `GetSet`, includes get and set accessor functions named `publicAccess()` that provide access to the private variable named `privateProperty`:

```

class GetSet
{
    private var privateProperty:String;

    public function get publicAccess():String
    {
        return privateProperty;
    }

    public function set publicAccess(setValue:String):void
    {
        privateProperty = setValue;
    }
}

```

If you attempt to access the property `privateProperty` directly, an error will result, as follows:

```
var myGetSet:GetSet = new GetSet();
trace(myGetSet.privateProperty); // error occurs
```

Instead, a user of the `GetSet` class will use something that appears to be a property named `publicAccess`, but that is really a pair of get and set accessor functions that operate on the private property named `privateProperty`. The following example instantiates the `GetSet` class, and then sets the value of the `privateProperty` using the public accessor named `publicAccess`:

```
var myGetSet:GetSet = new GetSet();
trace(myGetSet.publicAccess); // output: null
myGetSet.publicAccess = "hello";
trace(myGetSet.publicAccess); // output: hello
```

Getter and setter functions also make it possible to override properties that are inherited from a superclass, something that is not possible when you use regular class member variables. Class member variables that are declared using the `var` keyword cannot be overridden in a subclass. Properties that are created using getter and setter functions, however, do not have this restriction. You can use the `override` attribute on getter and setter functions that are inherited from a superclass.

## Bound methods

A bound method, sometimes called a *method closure*, is simply a method that is extracted from its instance. Examples of bound methods include methods that are passed as arguments to a function or returned as values from a function. New in ActionScript 3.0, a bound method is similar to a function closure in that it retains its lexical environment even when extracted from its instance. The key difference, however, between a bound method and a function closure is that the `this` reference for a bound method remains linked, or bound, to the instance that implements the method. In other words, the `this` reference in a bound method always points to the original object that implemented the method. For function closures, the `this` reference is generic, which means that it points to whatever object the function is associated with at the time it is invoked.

Understanding bound methods is important if you use the `this` keyword. Recall that the `this` keyword provides a reference to a method's parent object. Most ActionScript programmers expect that the `this` keyword always refers to the object or class that contains the definition of a method. Without method binding, however, this would not always be true. In previous versions of ActionScript, for example, the `this` reference did not always refer to the instance that implemented the method. When methods are extracted from an instance in ActionScript 2.0, not only is the `this` reference not bound to the original instance, but also the member variables and methods of the instance's class are not available. This is not a problem in ActionScript 3.0, because bound methods are automatically created when you pass a method as a parameter. Bound methods ensure that the `this` keyword always references the object or class in which a method is defined.

The following code defines a class named `ThisTest`, which contains a method named `foo()` that defines the bound method, and a method named `bar()` that returns the bound method. Code external to the class creates an instance of the `ThisTest` class, calls the `bar()` method, and stores the return value in a variable named `myFunc`.

```
class ThisTest
{
    private var num:Number = 3;
    function foo():void // bound method defined
    {
        trace("foo's this: " + this);
        trace("num: " + num);
    }
    function bar():Function
    {
        return foo; // bound method returned
    }
}
```

```
var myTest:ThisTest = new ThisTest();
var myFunc:Function = myTest.bar();
trace(this); // output: [object global]
myFunc();
/* output:
foo's this: [object ThisTest]
output: num: 3 */
```

The last two lines of code show that the `this` reference in the bound method `foo()` still points to an instance of `ThisTest` class, even though the `this` reference in the line just before it points to the global object. Moreover, the bound method stored in the `myFunc` variable still has access to the member variables of the `ThisTest` class. If this same code is run in ActionScript 2.0, the `this` references would match, and the `num` variable would be undefined.

One area where the addition of bound methods is most noticeable is with event handlers, because the `addEventListener()` method requires that you pass a function or method as an argument. For more information, see [“Listener function defined as a class method” on page 329](#).

## Enumerations with classes

*Enumerations* are custom data types that you create to encapsulate a small set of values. ActionScript 3.0 does not support a specific enumeration facility, unlike C++ with its `enum` keyword or Java with its Enumeration interface. You can, however, create enumerations using classes and static constants. For example, the `PrintJob` class in the Flash Player API uses an enumeration named `PrintJobOrientation` to store the set of values comprising "landscape" and "portrait", as shown in the following code:

```
public final class PrintJobOrientation
{
    public static const LANDSCAPE:String = "landscape";
    public static const PORTRAIT:String = "portrait";
}
```

By convention, an enumeration class is declared with the `final` attribute, because there is no need to extend the class. The class comprises only static members, which means that you do not create instances of the class. Instead, you access the enumeration values directly through the class object, as shown in the following code excerpt:

```
var pj:PrintJob = new PrintJob();
if(pj.start())
{
    if (pj.orientation == PrintJobOrientation.PORTRAIT)
    {
        ...
    }
    ...
}
```

All of the enumeration classes in the Flash Player API contain only variables of type `String`, `int`, or `uint`. The advantage of using enumerations instead of literal string or number values is that typographical mistakes are easier to find with enumerations. If you mistype the name of an enumeration, the ActionScript compiler generates an error. If you use literal values, the compiler does not complain if you spell a word incorrectly or use the wrong number. In the previous example, the compiler generates an error if the name of the enumeration constant is incorrect, as the following excerpt shows:

```
if (pj.orientation == PrintJobOrientation.PORTRAI) // compiler error
```

However, the compiler does not generate an error if you misspell a string literal value, as follows:

```
if (pj.orientation == "portrai") // no compiler error
```

A second technique for creating enumerations also involves creating a separate class with static properties for the enumeration. This technique differs, however, in that each of the static properties contains an instance of the class instead of a string or integer value. For example, the following code creates an enumeration class for the days of the week:

```
public final class Day
{
    public static const MONDAY:Day = new Day();
    public static const TUESDAY:Day = new Day();
    public static const WEDNESDAY:Day = new Day();
    public static const THURSDAY:Day = new Day();
    public static const FRIDAY:Day = new Day();
    public static const SATURDAY:Day = new Day();
    public static const SUNDAY:Day = new Day();
}
```

This technique is not used by the Flash Player API but is used by many developers who prefer the improved type checking that the technique provides. For example, a method that returns an enumeration value can restrict the return value to the enumeration data type. The following code shows not only a function that returns a day of the week, but also a function call that uses the enumeration type as a type annotation:

```
function getDay():Day
{
    var date:Date = new Date();
    var retDay:Day;
    switch (date.day)
    {
        case 0:
            retDay = Day.MONDAY;
            break;
        case 1:
            retDay = Day.TUESDAY;
            break;
        case 2:
            retDay = Day.WEDNESDAY;
            break;
        case 3:
            retDay = Day.THURSDAY;
            break;
        case 4:
            retDay = Day.FRIDAY;
            break;
        case 5:
            retDay = Day.SATURDAY;
    }
}
```

```

        break;
    case 6:
        retDay = Day.SUNDAY;
        break;
    }
    return retDay;
}

var dayOfWeek:Day = getDay();

```

You can also enhance the `Day` class so that it associates an integer with each day of the week, and provides a `toString()` method that returns a string representation of the day. You might want to enhance the `Day` class in this manner as an exercise.

## Embedded asset classes

ActionScript 3.0 uses special classes, called *embedded asset classes*, to represent embedded assets. An *embedded asset* is an asset, such as a sound, image, or font, that is included in a SWF file at compile time. Embedding an asset instead of loading it dynamically ensures that it will be available at run time, but at the cost of increased SWF file size.

### Using embedded asset classes in Flash

To embed an asset, first place the asset into a FLA file's library. Next, use the asset's linkage property to provide a name for the asset's embedded asset class. If a class by that name cannot be found in the classpath, a class is automatically generated for you. You can then create an instance of the embedded asset class and use any properties and methods defined or inherited by that class. For example, the following code can be used to play an embedded sound that is linked to an embedded asset class named `PianoMusic`:

```

var piano:PianoMusic = new PianoMusic();
var sndChannel:SoundChannel = piano.play();

```

## Interfaces

An interface is a collection of method declarations that allows unrelated objects to communicate with one another. For example, the Flash Player API defines the `IEventDispatcher` interface, which contains method declarations that a class can use to handle event objects. The `IEventDispatcher` interface establishes a standard way for objects to pass event objects to one another. The following code shows the definition of the `IEventDispatcher` interface:

```

public interface IEventDispatcher
{
    function addEventListener(type:String, listener:Function,
        useCapture:Boolean=false, priority:int=0,
        useWeakReference:Boolean = false):void;
    function removeEventListener(type:String, listener:Function,
        useCapture:Boolean=false):void;
    function dispatchEvent(event:Event):Boolean;
    function hasEventListener(type:String):Boolean;
    function willTrigger(type:String):Boolean;
}

```

Interfaces are based on the distinction between a method's interface and its implementation. A method's interface includes all the information necessary to invoke that method, including the name of the method, all of its parameters, and its return type. A method's implementation includes not only the interface information, but also the executable statements that carry out the method's behavior. An interface definition contains only method interfaces, and any class that implements the interface is responsible for defining the method implementations.

In the Flash Player API, the `EventDispatcher` class implements the `IEventDispatcher` interface by defining all of the `IEventDispatcher` interface methods and adding method bodies to each of the methods. The following code is an excerpt from the `EventDispatcher` class definition:

```

public class EventDispatcher implements IEventDispatcher
{
    function dispatchEvent(event:Event):Boolean
    {
        /* implementation statements */
    }

    ...
}

```

The `IEventDispatcher` interface serves as a protocol that `EventDispatcher` instances use to process event objects and pass them to other objects that have also implemented the `IEventDispatcher` interface.

Another way to describe an interface is to say that it defines a data type just as a class does. Accordingly, an interface can be used as a type annotation, just as a class can. As a data type, an interface can also be used with operators, such as the `is` and `as` operators, that require a data type. Unlike a class, however, an interface cannot be instantiated. This distinction has led many programmers to think of interfaces as abstract data types and classes as concrete data types.

## Defining an interface

The structure of an interface definition is similar to that of a class definition, except that an interface can contain only methods with no method bodies. Interfaces cannot include variables or constants but can include getters and setters. To define an interface, use the `interface` keyword. For example, the following interface, `IExternalizable`, is part of the `flash.utils` package in the Flash Player API. The `IExternalizable` interface defines a protocol for serializing an object, which means converting an object into a format suitable for storage on a device or for transport across a network.

```
public interface IExternalizable
{
    function writeExternal(output:IDataOutput):void;
    function readExternal(input:IDataInput):void;
}
```

Note that the `IExternalizable` interface is declared with the `public` access control modifier. Interface definitions may only be modified by the `public` and `internal` access control specifiers. The method declarations inside an interface definition cannot have any access control specifiers.

The Flash Player API follows a convention in which interface names begin with an uppercase `I`, but you can use any legal identifier as an interface name. Interface definitions are often placed at the top level of a package. Interface definitions cannot be placed inside a class definition or inside another interface definition.

Interfaces can extend one or more other interfaces. For example, the following interface, `IExample`, extends the `IExternalizable` interface:

```
public interface IExample extends IExternalizable
{
    function extra():void;
}
```

Any class that implements the `IExample` interface must include implementations not only for the `extra()` method, but also for the `writeExternal()` and `readExternal()` methods inherited from the `IExternalizable` interface.



## Implementing an interface in a class

A class is the only ActionScript 3.0 language element that can implement an interface. Use the `implements` keyword in a class declaration to implement one or more interfaces. The following example defines two interfaces, `IAlpha` and `IBeta`, and a class, `Alpha`, that implements them both:

```
interface IAlpha
{
    function foo(str:String):String;
}

interface IBeta
{
    function bar():void;
}

class Alpha implements IAlpha, IBeta
{
    public function foo(param:String):String {}
    public function bar():void {}
}
```

In a class that implements an interface, implemented methods must do the following:

- Use the `public` access control identifier.
- Use the same name as the interface method.
- Have the same number of parameters, each with data types that match the interface method parameter data types.
- Use the same return type.

You do have some flexibility, however, in how you name the parameters of methods that you implement. Although the number of parameters and the data type of each parameter in the implemented method must match that of the interface method, the parameter names do not need to match. For example, in the previous example the parameter of the `Alpha.foo()` method is named `param`:

```
public function foo(param:String):String {}
```

But the parameter is named `str` in the `IAlpha.foo()` interface method:

```
function foo(str:String):String;
```

You also have some flexibility with default parameter values. An interface definition can include function declarations with default parameter values. A method that implements such a function declaration must have a default parameter value that is a member of the same data type as the value specified in the interface definition, but the actual value does not have to match. For example, the following code defines an interface that contains a method with a default parameter value of 3:

```
interface IGamma
{
    function doSomething(param:int = 3):void;
}
```

The following class definition implements the Igamma interface but uses a different default parameter value:

```
class Gamma implements IGamma
{
    public function doSomething(param:int = 4):void {}
}
```

The reason for this flexibility is that the rules for implementing an interface are designed specifically to ensure data type compatibility, and requiring identical parameter names and default parameter values is not necessary to achieve that objective.

## Inheritance

Inheritance is a form of code reuse that allows programmers to develop new classes that are based on existing classes. The existing classes are often referred to as *base classes* or *superclasses*, while the new classes are usually called *subclasses*. A key advantage of inheritance is that it allows you to reuse code from a base class yet leave the existing code unmodified. Moreover, inheritance requires no changes to the way that other classes interact with the base class. Rather than modifying an existing class that may have been thoroughly tested or may already be in use, using inheritance you can treat that class as an integrated module that you can extend with additional properties or methods. Accordingly, you use the `extends` keyword to indicate that a class inherits from another class.

Inheritance also allows you to take advantage of *polymorphism* in your code. Polymorphism is the ability to use a single method name for a method that behaves differently when applied to different data types. A simple example is a base class named `Shape` with two subclasses named `Circle` and `Square`. The `Shape` class defines a method named `area()`, which returns the area of the shape. If polymorphism is implemented, you can call the `area()` method on objects of type `Circle` and `Square` and have the correct calculations done for you. Inheritance enables polymorphism by allowing subclasses to inherit and redefine, or *override*, methods from the base class. In the following example, the `area()` method is redefined by the `Circle` and `Square` classes:

```
class Shape
{
    public function area():Number
    {
        return NaN;
    }
}

class Circle extends Shape
{
    private var radius:Number = 1;
    override public function area():Number
    {
        return (Math.PI * (radius * radius));
    }
}

class Square extends Shape
{
    private var side:Number = 1;
    override public function area():Number
    {
        return (side * side);
    }
}

var cir:Circle = new Circle();
trace(cir.area()); // output: 3.141592653589793
var sq:Square = new Square();
trace(sq.area()); // output: 1
```

Because each class defines a data type, the use of inheritance creates a special relationship between a base class and a class that extends it. A subclass is guaranteed to possess all the properties of its base class, which means that an instance of a subclass can always be substituted for an instance of the base class. For example, if a method defines a parameter of type `Shape`, it is legal to pass an argument of type `Circle` because `Circle` extends `Shape`, as in the following:

```
function draw(shapeToDraw:Shape) {}

var myCircle:Circle = new Circle();
draw(myCircle);
```

## Instance properties and inheritance

An instance property, whether defined with the `function`, `var`, or `const` keywords, is inherited by all subclasses as long as the property is not declared with the `private` attribute in the base class. For example, the `Event` class in the Flash Player API has a number of subclasses that inherit properties common to all event objects.

For some types of events, the `Event` class contains all the properties necessary to define the event. These types of events do not require instance properties beyond those defined in the `Event` class. Examples of such events are the `complete` event, which occurs when data has loaded successfully, and the `connect` event, which occurs when a network connection has been established.

The following example is an excerpt from the `Event` class that shows some of the properties and methods that are inherited by subclasses. Because the properties are inherited, an instance of any subclass can access these properties.

```
public class Event
{
    public function get type():String;
    public function get bubbles():Boolean;
    ...

    public function stopPropagation():void {}
    public function stopImmediatePropagation():void {}
    public function preventDefault():void {}
    public function isDefaultPrevented():Boolean {}
    ...
}
```

Other types of events require unique properties not available in the `Event` class. These events are defined using subclasses of the `Event` class so that new properties can be added to the properties defined in the `Event` class. An example of such a subclass is the `MouseEvent` class, which adds properties unique to events associated with mouse movement or mouse clicks, such as the `mouseMove` and `click` events. The following example is an excerpt from the `MouseEvent` class that shows the definition of properties that exist on the subclass but not on the base class:

```
public class MouseEvent extends Event
{
    public static const CLICK:String = "click";
    public static const MOUSE_MOVE:String = "mouseMove";
```

```

...
public function get stageX():Number {}
public function get stageY():Number {}
...
}

```

## Access control specifiers and inheritance

If a property is declared with the `public` keyword, the property is visible to code anywhere. This means that the `public` keyword, unlike the `private`, `protected`, and `internal` keywords, places no restrictions on property inheritance.

If a property is declared with `private` keyword, it is visible only in the class that defines it, which means that it is not inherited by any subclasses. This behavior is different from previous versions of ActionScript, where the `private` keyword behaved more like the ActionScript 3.0 `protected` keyword.

The `protected` keyword indicates that a property is visible not only within the class that defines it, but also to all subclasses. Unlike the `protected` keyword in the Java programming language, the `protected` keyword in ActionScript 3.0 does not make a property visible to all other classes in the same package. In ActionScript 3.0, only subclasses can access a property declared with the `protected` keyword. Moreover, a `protected` property is visible to a subclass whether the subclass is in the same package as the base class or in a different package.

To limit the visibility of a property to the package in which it is defined, use the `internal` keyword or do not use any access control specifier. The `internal` access control specifier is the default access control specifier that applies when one is not specified. A property marked as `internal` will be inherited only by a subclass that resides in the same package.

You can use the following example to see how each of the access control specifiers affects inheritance across package boundaries. The following code defines a main application class named `AccessControl` and two other classes named `Base` and `Extender`. The `Base` class is in a package named `foo` and the `Extender` class, which is a subclass of the `Base` class, is in a package named `bar`. The `AccessControl` class imports only the `Extender` class and creates an instance of `Extender` that attempts to access a variable named `str` that is defined in the `Base` class. The `str` variable is declared as `public` so that the code compiles and runs as shown in the following excerpt:

```

// Base.as in a folder named foo
package foo
{
    public class Base
    {
        public var str:String = "hello"; // change public on this line
    }
}

```

```

}

// Extender.as in a folder named bar
package bar
{
    import foo.Base;
    public class Extender extends Base
    {
        public function getString():String {
            return str;
        }
    }
}

// main application class in file named ProtectedExample.as
import flash.display.MovieClip;
import bar.Extender;
public class AccessControl extends MovieClip
{
    public function AccessControl()
    {
        var myExt:Extender = new Extender();
        trace(myExt.testString); // error if str is not public
        trace(myExt.getString()); // error if str is private or internal
    }
}
}

```

To see how the other access control specifiers affect compilation and execution of the preceding example, change the `str` variable's access control specifier to `private`, `protected`, or `internal` after deleting or commenting out the following line from the `AccessControl` class:

```
trace(myExt.testString); // error if str is not public
```

## Overriding variables not permitted

Properties that are declared with the `var` or `const` keywords are inherited but cannot be overridden. To override a property means to redefine the property in a subclass. The only type of property that can be overridden are methods—that is, properties declared with the `function` keyword. Although you cannot override an instance variable, you can achieve similar functionality by creating getter and setter methods for the instance variable and overriding the methods. For more information, see [“Overriding getters and setters” on page 168](#).

## Overriding methods

To override a method means to redefine the behavior of an inherited method. Static methods are not inherited and cannot be overridden. Instance methods, however, are inherited by subclasses and can be overridden as long as the following two criteria are met:

- The instance method is not declared with the `final` keyword in the base class. When used with an instance method, the `final` keyword indicates the programmer's intent to prevent subclasses from overriding the method.
- The instance method is not declared with the `private` access control specifier in the base class. If a method is marked as `private` in the base class, there is no need to use the `override` keyword when defining an identically named method in the subclass, because the base class method will not be visible to the subclass.

To override an instance method that meets these criteria, the method definition in the subclass must use the `override` keyword and must match the superclass version of the method in the following ways:

- The override method must have the same level of access control as the base class method. Methods marked as `internal` have the same level of access control as methods that have no access control specifier.
- The override method must have the same number of parameters as the base class method.
- The override method parameters must have the same data type annotations as the parameters in the base class method.
- The override method must have the same return type as the base class method.

The names of the parameters in the override method, however, do not have to match the names of the parameters in the base class, as long as the number of parameters and the data type of each parameter matches.

## The super statement

When overriding a method, programmers often want to add to the behavior of the superclass method they are overriding instead of completely replacing the behavior. This requires a mechanism that allows a method in a subclass to call the superclass version of itself. The `super` statement provides such a mechanism, in that it contains a reference to the immediate superclass. The following example defines a class named `Base` that contains a method named `thanks()` and a subclass of the `Base` class named `Extender` that overrides the `thanks()` method. The `Extender.thanks()` method uses the `super` statement to call `Base.thanks()`.

```
package {
    import flash.display.MovieClip;
    public class SuperExample extends MovieClip
    {
```

```

        public function SuperExample()
        {
            var myExt:Extender = new Extender()
            trace(myExt.thanks()); // output: Mahalo nui loa
        }
    }
}

class Base {
    public function thanks():String
    {
        return "Mahalo";
    }
}

class Extender extends Base
{
    override public function thanks():String
    {
        return super.thanks() + " nui loa";
    }
}

```

## Overriding getters and setters

Although you cannot override variables defined in a superclass, you can override getters and setters. For example, the following code overrides a getter named `currentLabel` that is defined in the `MovieClip` class in the Flash Player API.:

```

package
{
    import flash.display.MovieClip;
    public class OverrideExample extends MovieClip
    {
        public function OverrideExample()
        {
            trace(currentLabel)
        }
        override public function get currentLabel():String
        {
            var str:String = "Override: ";
            str += super.currentLabel;
            return str;
        }
    }
}

```



The output of the `trace()` statement in the `OverrideExample` class constructor is `Override: null`, which shows that the example was able to override the inherited `currentLabel` property.

## Static properties not inherited

Static properties are not inherited by subclasses. This means that static properties cannot be accessed through an instance of a subclass. A static property can be accessed only through the class object on which it is defined. For example, the following code defines a base class named `Base` and a subclass that extends `Base` named `Extender`. A static variable named `test` is defined in the `Base` class. The code as written in the following excerpt does not compile in strict mode and generates a run-time error in standard mode.

```
package {
    import flash.display.MovieClip;
    public class StaticExample extends MovieClip
    {
        public function StaticExample()
        {
            var myExt:Extender = new Extender();
            trace(myExt.test); // error
        }
    }
}

class Base {
    public static var test:String = "static";
}

class Extender extends Base { }
```

The only way to access the static variable `test` is through the class object, as shown in the following code:

```
Base.test;
```

It is permissible, however, to define an instance property using the same name as a static property. Such an instance property can be defined in the same class as the static property or in a subclass. For example, the `Base` class in the preceding example could have an instance property named `test`. The following code compiles and executes because the instance property is inherited by the `Extender` class. The code would also compile and execute if the definition of the `test` instance variable is moved, but not copied, to the `Extender` class.

```
package
{
    import flash.display.MovieClip;
    public class StaticExample extends MovieClip
    {
```

```

        public function StaticExample()
        {
            var myExt:Extender = new Extender();
            trace(myExt.test); // output: instance
        }
    }
}

class Base
{
    public static var test:String = "static";
    public var test:String = "instance";
}

class Extender extends Base {}

```

## Static properties and the scope chain

Although static properties are not inherited, they are within the scope chain of the class that defines them and any subclass of that class. As such, static properties are said to be *in scope* of both the class in which they are defined and any subclasses. This means that a static property is directly accessible within the body of the class that defines the static property and any subclass of that class.

The following example modifies the classes defined in the previous example to show that the static `test` variable defined in the `Base` class is in scope of the `Extender` class. In other words, the `Extender` class can access the static `test` variable without prefixing the variable with the name of the class that defines `test`.

```

package
{
    import flash.display.MovieClip;
    public class StaticExample extends MovieClip
    {
        public function StaticExample()
        {
            var myExt:Extender = new Extender();
        }
    }
}

class Base {
    public static var test:String = "static";
}

class Extender extends Base
{
    public function Extender()

```

```

    {
        trace(test); // output: static
    }
}

```

If an instance property is defined that uses the same name as a static property in the same class or a superclass, the instance property has higher precedence in the scope chain. The instance property is said to *shadow* the static property, which means that the value of the instance property is used instead of the value of the static property. For example, the following code shows that if the `Extender` class defines an instance variable named `test`, the `trace()` statement uses the value of the instance variable instead of the value of the static variable.:

```

package
{
    import flash.display.MovieClip;
    public class StaticExample extends MovieClip
    {
        public function StaticExample()
        {
            var myExt:Extender = new Extender();
        }
    }
}

class Base
{
    public static var test:String = "static";
}

class Extender extends Base
{
    public var test:String = "instance";
    public function Extender()
    {
        trace(test); // output: instance
    }
}

```

## Advanced topics

This section begins with a brief history of ActionScript and OOP and continues with a discussion of the ActionScript 3.0 object model and how it enables the new ActionScript Virtual Machine (AVM2) to perform significantly faster than previous versions of Flash Player that contain the old ActionScript Virtual Machine (AVM1).

# History of ActionScript OOP support

Because ActionScript 3.0 builds upon previous versions of ActionScript, it may be helpful to understand how the ActionScript object model has evolved. ActionScript began as a simple scripting mechanism for early versions of the Flash authoring tool. Subsequently, programmers began building increasingly complex applications with ActionScript. In response to the needs of such programmers, each subsequent release has added language features that facilitate the creation of complex applications.

## ActionScript 1.0

ActionScript 1.0 refers to the version of the language used in Flash Player 6 and earlier. Even at this early stage of development, the ActionScript object model was based on the concept of the object as a fundamental data type. An ActionScript object is a compound data type with a group of *properties*. When discussing the object model, the term *properties* includes everything that is attached to an object, such as variables, functions, or methods.

Although this first generation of ActionScript does not support the definition of classes with a `class` keyword, you can define a class using a special kind of object called a prototype object. Instead of using a `class` keyword to create an abstract class definition that you instantiate into concrete objects, as you do in class-based languages like Java and C++, prototype-based languages like ActionScript 1.0 use an existing object as a model (or prototype) for other objects. While objects in a class-based language may point to a class that serves as its template, objects in a prototype-based language point instead to another object, its prototype, that serves as its template.

To create a class in ActionScript 1.0, you define a constructor function for that class. In ActionScript, functions are actual objects, not just abstract definitions. The constructor function that you create serves as the prototypical object for instances of that class. The following code creates a class named `Shape` and defines one property named `visible` that is set to `true` by default:

```
// base class
function Shape() {}
// Create a property named visible.
Shape.prototype.visible = true;
```

This constructor function defines a `Shape` class that you can instantiate with the `new` operator, as follows:

```
myShape = new Shape();
```

Just as the `Shape()` constructor function object serves as the prototype for instances of the `Shape` class, it can also serve as the prototype for subclasses of `Shape`—that is, other classes that extend the `Shape` class.

The creation of a class that is a subclass of the Shape class is a two-step process. First, create the class by defining a constructor function for the class, as follows:

```
// child class
function Circle(id, radius)
{
    this.id = id;
    this.radius = radius;
}
```

Second, use the `new` operator to declare that the Shape class is the prototype for the Circle class. By default, any class you create uses the Object class as its prototype, which means that `Circle.prototype` currently contains a generic object (an instance of the Object class). To specify that Circle's prototype is Shape instead of Object, use the following code to change the value of `Circle.prototype` so that it contains a Shape object instead of a generic object:

```
// Make Circle a subclass of Shape.
Circle.prototype = new Shape();
```

The Shape class and the Circle class are now linked together in an inheritance relationship that is commonly known as the *prototype chain*. The diagram illustrates the relationships in a prototype chain:

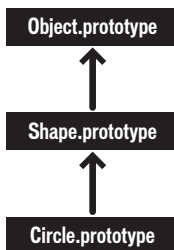

The base class at the end of every prototype chain is the Object class. The Object class contains a static property named `Object.prototype` that points to the base prototype object for all objects created in ActionScript 1.0. The next object in our example prototype chain is the Shape object. This is because the `Shape.prototype` property was never explicitly set, so it still holds a generic object (an instance of the Object class). The final link in this chain is the Circle class, which is linked to its prototype, the Shape class (the `Circle.prototype` property holds a Shape object).

If we create an instance of the Circle class, as in the following example, the instance inherits the prototype chain of the Circle class:

```
// Create an instance of the Circle class.
myCircle = new Circle();
```

Recall that we created a property named `visible` as a member of the `Shape` class. In our example, the `visible` property does not exist as a part of the `myCircle` object, only as a member of the `Shape` object, yet the following line of code outputs `true`:

```
trace(myCircle.visible); // output: true
```

Flash Player is able to ascertain that the `myCircle` object inherits the `visible` property by walking up the prototype chain. When executing this code, Flash Player first searches through the properties of the `myCircle` object for a property named `visible`, but does not find such a property. Flash Player looks next in the `Circle.prototype` object, but still does not find a property named `visible`. Continuing up the prototype chain, Flash Player finally finds the `visible` property defined on the `Shape.prototype` object and outputs the value of that property.

In the interest of simplicity, this section omits many of the details and intricacies of the prototype chain, and aims instead to provide enough information to help you understand the ActionScript 3.0 object model.

## ActionScript 2.0

ActionScript 2.0 introduced new keywords such as `class`, `extends`, `public`, and `private`, that allowed you to define classes in a way that is familiar to anyone who works with class-based languages like Java and C++. It's important to understand that the underlying inheritance mechanism did not change between ActionScript 1.0 and ActionScript 2.0. ActionScript 2.0 merely added a new syntax for defining classes. The prototype chain works the same way in both versions of the language.

The new syntax introduced by ActionScript 2.0, shown in the following excerpt, allows you to define classes in a way that many programmers find more intuitive:

```
// base class
class Shape
{
    var visible:Boolean = true;
}
```

Note that ActionScript 2.0 also introduced type annotations for use with compile-time type checking. This allows you to declare that the `visible` property in the previous example should contain only a Boolean value. The new `extends` keyword also simplifies the process of creating a subclass. In the following example, the two-step process necessary in ActionScript 1.0 is accomplished in one step with the `extends` keyword:

```
// child class
class Circle extends Shape
{
    var id:Number;
    var radius:Number;
```

```
function Circle(id, radius)
{
    this.id = id;
    this.radius = radius;
}
```

The constructor is now declared as part of the class definition, and the class properties `id` and `radius` must also be declared explicitly.

ActionScript 2.0 also added support for the definition of interfaces, which allow you to further refine your object-oriented programs with formally defined protocols for inter-object communication.

## The ActionScript 3.0 class object

A common object-oriented programming paradigm, most commonly associated with Java and C++, uses classes to define types of objects. Programming languages that adopt this paradigm also tend to use classes to construct instances of the data type that the class defines.

ActionScript uses classes for both of these purposes, but its roots as a prototype-based language add an interesting characteristic. ActionScript creates for each class definition a special class object that allows sharing of both behavior and state. For many ActionScript programmers, however, this distinction may have no practical coding implications.

ActionScript 3.0 is designed such that you can create sophisticated object-oriented ActionScript applications without using, or even understanding, these special class objects. For advanced programmers who want to take advantage of class objects, this section discusses the issues in depth.

The following diagram shows the structure of a class object that represents a simple class named A that is defined with the statement `class A {}`:

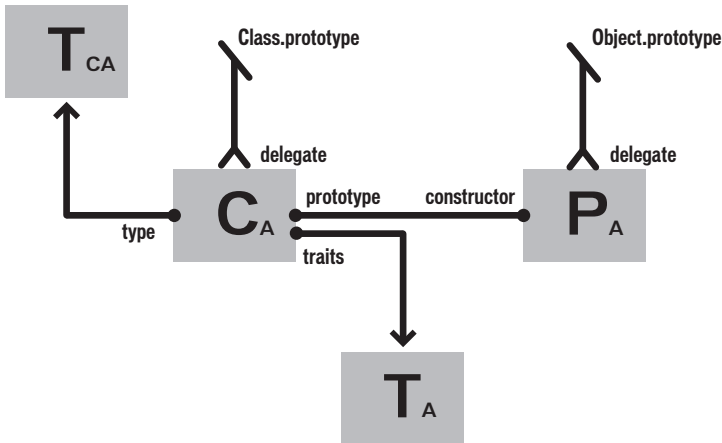

Each rectangle in the diagram represents an object. Each object in the diagram has a subscript character A to represent that it belongs to class A. The class object ( $C_A$ ) contains references to a number of other important objects. An instance traits object ( $T_A$ ) stores the instance properties that are defined within a class definition. A class traits object ( $T_{CA}$ ) represents the internal type of the class and stores the static properties defined by the class (the subscript character C stands for “class”). The prototype object ( $P_A$ ) always refers to the class object to which it was originally attached through the `constructor` property.

## The traits object

The traits object, which is new in ActionScript 3.0, was implemented with performance in mind. In previous versions of ActionScript, name lookup could be a time-consuming process as Flash Player walked the prototype chain. In ActionScript 3.0, name lookup is much more efficient and less time consuming, because inherited properties are copied down from superclasses into the traits object of subclasses.

The traits object is not directly accessible to programmer code, but its presence can be felt by the improvements in performance and memory usage. The traits object provides the AVM2 with detailed information about the layout and contents of a class. With such knowledge, the AVM2 is able to significantly reduce execution time, because it can often generate direct machine instructions to access properties or call methods directly without a time-consuming name lookup.



Thanks to the traits object, an object's memory footprint can be significantly smaller than a similar object in previous versions of ActionScript. For example, if a class is sealed (that is, the class is not declared dynamic), an instance of the class does not need a hash table for dynamically added properties, and can hold little more than a pointer to the traits objects and some slots for the fixed properties defined in the class. As a result, an object that required 100 bytes of memory in ActionScript 2.0 could require as little as 20 bytes of memory in ActionScript 3.0.

NOTE

The traits object is an internal implementation detail, and there is no guarantee that it will not change or even disappear in future versions of ActionScript.

## The prototype object

Every ActionScript class object has a property named `prototype`, which is a reference to the class's prototype object. The prototype object is a legacy of ActionScript's roots as prototype-based language. For more information, see [“ActionScript 1.0” on page 172](#).

The `prototype` property is read-only, which means that it cannot be modified to point to different objects. This differs from the class `prototype` property in previous versions of ActionScript, where the prototype could be reassigned so that it pointed to a different class. Although the `prototype` property is read-only, the prototype object that it references is not. In other words, new properties can be added to the prototype object. Properties added to the prototype object are shared among all instances of the class.

The prototype chain, which was the only inheritance mechanism in previous versions of ActionScript, serves only a secondary role in ActionScript 3.0. The primary inheritance mechanism, fixed property inheritance, is handled internally by the traits object. A fixed property is a variable or method that is defined as part of a class definition. Fixed property inheritance is also called class inheritance, because it is the inheritance mechanism that is associated with keywords such as `class`, `extends`, and `override`.

The prototype chain provides an alternative inheritance mechanism that is more dynamic than fixed property inheritance. You can add properties to a class's prototype object not only as part of the class definition, but also at run time through the class object's `prototype` property. Note, however, that if you set the compiler to strict mode, you may not be able to access properties added to a prototype object unless you declare a class with the `dynamic` keyword.

A good example of a class with several properties attached to the prototype object is the `Object` class. The `Object` class's `toString()` and `valueOf()` methods are actually functions assigned to properties of the `Object` class's prototype object. The following is an example of how the declaration of these methods could, in theory, look (the actual implementation differs slightly because of implementation details):

```
public dynamic class Object
{
    prototype.toString = function()
    {
        // statements
    };
    prototype.valueOf = function()
    {
        // statements
    };
}
```

As mentioned previously, you can attach a property to a class's prototype object outside the class definition. For example, the `toString()` method can also be defined outside the `Object` class definition, as follows:

```
Object.prototype.toString = function()
{
    // statements
};
```

Unlike fixed property inheritance, however, prototype inheritance does not require the `override` keyword if you want to redefine a method in a subclass. For example, if you want to redefine the `valueOf()` method in a subclass of the `Object` class, you have three options. First, you can define a `valueOf()` method on the subclass's prototype object inside the class definition. The following code creates a subclass of `Object` named `Foo` and redefines the `valueOf()` method on `Foo`'s prototype object as part of the class definition. Because every class inherits from `Object`, it is not necessary to use the `extends` keyword.

```
dynamic class Foo
{
    prototype.valueOf = function()
    {
        return "Instance of Foo";
    };
}
```

Second, you can define a `valueOf()` method on `Foo`'s prototype object outside the class definition, as shown in the following code:

```
Foo.prototype.valueOf = function()
{
```

```
    return "Instance of Foo";  
};
```

Third, you can define a fixed property named `valueOf()` as part of the `Foo` class. This technique differs from the others in that it mixes fixed property inheritance with prototype inheritance. Any subclass of `Foo` that wants to redefine `valueOf()` must use the `override` keyword. The following code shows `valueOf()` defined as a fixed property in `Foo`:

```
class Foo  
{  
    function valueOf():String  
    {  
        return "Instance of Foo";  
    }  
}
```

## The AS3 namespace

The existence of two separate inheritance mechanisms, fixed property inheritance and prototype inheritance, creates an interesting compatibility challenge with respect to the properties and methods of the core classes. Compatibility with the ECMAScript, Edition 4 draft language specification requires the use of prototype inheritance, which means that the properties and methods of a core class are defined on the prototype object of that class. On the other hand, compatibility with the Flash Player API calls for the use of fixed property inheritance, which means that the properties and methods of a core class are defined in the class definition using the `const`, `var`, and `function` keywords. Moreover, the use of fixed properties instead of the prototype versions can lead to significant increases in run-time performance.

ActionScript 3.0 solves this problem by using both prototype inheritance and fixed property inheritance for the core classes. Each core class contains two sets of properties and methods. One set is defined on the prototype object for compatibility with the ECMAScript specification, and the other set is defined with fixed properties and the AS3 namespace for compatibility with the Flash Player API.

The AS3 namespace provides a convenient mechanism for choosing between the two sets of properties and methods. If you do not use the AS3 namespace, an instance of a core class inherits the properties and methods defined on the core class's prototype object. If you decide to use the AS3 namespace, an instance of a core class inherits the AS3 versions because fixed properties are always preferred over prototype properties. In other words, whenever a fixed property is available, it is always used instead of an identically named prototype property.

You can selectively use the AS3 namespace version of a property or method by qualifying it with the AS3 namespace. For example, the following code uses the AS3 version of the `Array.pop()` method:

```
var nums:Array = new Array(1, 2, 3);
nums.AS3::pop();
trace(nums); // output: 1,2
```

Alternatively, you can use the `use namespace` directive to open the AS3 namespace for all the definitions within a block of code. For example, the following code uses the `use namespace` directive to open the AS3 namespace for both the `pop()` and `push()` methods:

```
use namespace AS3;

var nums:Array = new Array(1, 2, 3);
nums.pop();
nums.push(5);
trace(nums) // output: 1,2,5
```

ActionScript 3.0 also provides compiler options for each set of properties so that you can apply the AS3 namespace to your entire program. The `-as3` compiler option represents the AS3 namespace, and the `-es` compiler option represents the prototype inheritance option (`es` stands for ECMAScript). To open the AS3 namespace for your entire program, set the `-as3` compiler option to `true` and the `-es` compiler option to `false`. To use the prototype versions, set the compiler options to the opposite values. The default compiler settings for Adobe Flex Builder 2 and Adobe Flash CS3 Professional are `-as3 = true` and `-es = false`.

If you plan to extend any of the core classes and override any methods, you should understand how the AS3 namespace can affect how you must declare an overridden method. If you are using the AS3 namespace, any method override of a core class method must also use the AS3 namespace along with the `override` attribute. If you are not using the AS3 namespace and want to redefine a core class method in a subclass, you should not use the AS3 namespace or the `override` keyword.

## Example: GeometricShapes

The `GeometricShapes` sample application shows how a number of object-oriented concepts and features can be applied using ActionScript 3.0, including:

- Defining classes
- Extending classes
- Polymorphism and the `override` keyword
- Defining, extending and implementing interfaces

It also includes a “factory method” that creates class instances, showing how to declare a return value as an instance of an interface, and use that returned object in a generic way.

To get the application files for this sample, see [www.adobe.com/go/learn\\_programmingAS3samples\\_flash](http://www.adobe.com/go/learn_programmingAS3samples_flash). The GeometricShapes application files can be found in the folder Samples/GeometricShapes. The application consists of the following files:

File	Description
GeometricShapes.mxml or GeometricShapes fla	The main application file in Flash (FLA) or Flex (MXML).
com/example/programmingas3/ geometricshapes/IGeometricShape.as	The base interface defining methods to be implemented by all GeometricShapes application classes.
com/example/programmingas3/ geometricshapes/IPolygon.as	An interface defining methods to be implemented by GeometricShapes application classes that have multiple sides.
com/example/programmingas3/ geometricshapes/RegularPolygon.as	A type of geometric shape that has sides of equal length positioned symmetrically around the shape’s center.
com/example/programmingas3/ geometricshapes/Circle.as	A type of geometric shape that defines a circle.
com/example/programmingas3/ geometricshapes/EquilateralTriangle.as	A subclass of RegularPolygon that defines a triangle with all sides the same length.
com/example/programmingas3/ geometricshapes/Square.as	A subclass of RegularPolygon defining a rectangle with all four sides the same length.
com/example/programmingas3/ geometricshapes/ GeometricShapeFactory.as	A class containing a factory method for creating shapes given a shape type and size.

## Defining the GeometricShapes classes

The GeometricShapes application lets the user specify a type of geometric shape and a size. It then responds with a description of the shape, its area, and distance around its perimeter.

The application user interface is trivial, including a few controls for selecting the type of shape, setting the size, and displaying the description. The most interesting part of this application is under the surface, in the structure of the classes and interfaces themselves.

This application deals with geometric shapes, but it doesn't display them graphically. It provides a small library of classes and interfaces that will be reused in a later chapter's example (see "Example: SpriteArranger" on page 423). The SpriteArranger example displays the shapes graphically and lets the user manipulate them, based on the class framework provided here in the GeometricShapes application.

The classes and interfaces that define the geometric shapes in this example are shown in the following diagram using Unified Modeling Language (UML) notation:

### GeometricShapes Example Classes

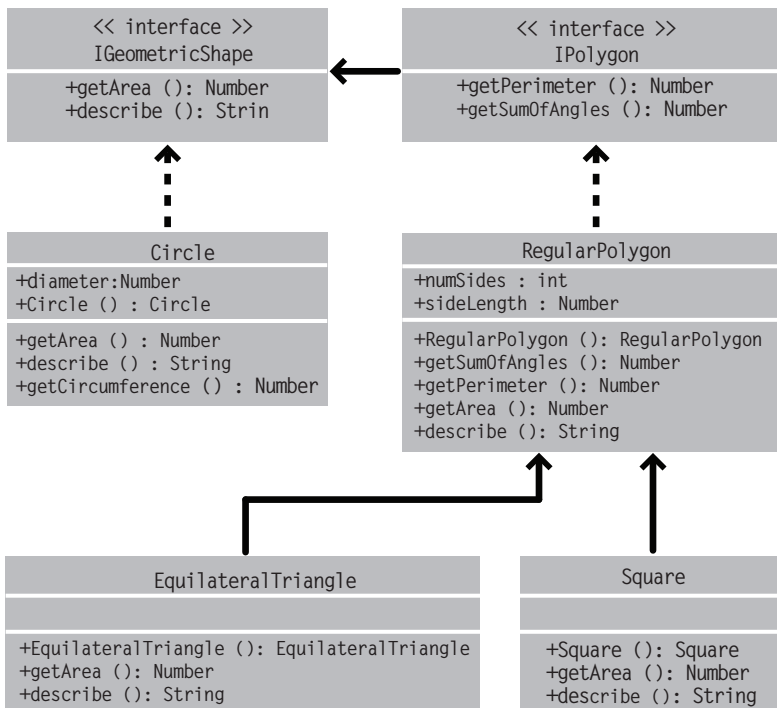

## Defining common behavior with interfaces

This GeometricShapes application deals with three types of shapes: circles, squares, and equilateral triangles. The GeometricShapes class structure begins with a very simple interface, IGeometricShape, that lists methods common to all three types of shapes:

```

package com.example.programmingas3.geometricshapes
{
    public interface IGeometricShape
    {
        function getArea():Number;
        function describe():String;
    }
}

```

The interface defines two methods: the `getArea()` method, which calculates and returns the area of the shape, and the `describe()` method, which assembles a text description of the shape's properties.

We also want to know the distance around the perimeter of each shape. However, the perimeter of a circle is called the circumference, and it's calculated in a unique way, so the behavior diverges from that of a triangle or a square. Still there is enough similarity between triangles, squares, and other polygons that it makes sense to define a new interface class just for them: `IPolygon`. The `IPolygon` interface is also rather simple, as shown here:

```

package com.example.programmingas3.geometricshapes
{
    public interface IPolygon extends IGeometricShape
    {
        function getPerimeter():Number;
        function getSumOfAngles():Number;
    }
}

```

This interface defines two methods common to all polygons: the `getPerimeter()` method that measures the combined distance of all the sides, and the `getSumOfAngles()` method that adds up all the interior angles.

The `IPolygon` interface extends the `IGeometricShape` interface, which means that any class that implements the `IPolygon` interface must declare all four methods—the two from the `IGeometricShape` interface, and the two from the `IPolygon` interface.

## Defining the shape classes

Once you have a good idea about the methods common to each type of shape, you can define the shape classes themselves. In terms of how many methods you need to implement, the simplest shape is the `Circle` class, shown here:

```

package com.example.programmingas3.geometricshapes
{
    public class Circle implements IGeometricShape
    {
        public var diameter:Number;
    }
}

```

```

public function Circle(diam:Number = 100):void
{
    this.diameter = diam;
}

public function getArea():Number
{
    // The formula is Pi * radius * radius.
    var radius:Number = diameter / 2;
    return Math.PI * radius * radius;
}

public function getCircumference():Number
{
    // The formula is Pi * diameter.
    return Math.PI * diameter;
}

public function describe():String
{
    var desc:String = "This shape is a Circle.\n";
    desc += "Its diameter is " + diameter + " pixels.\n";
    desc += "Its area is " + getArea() + ".\n";
    desc += "Its circumference is " + getCircumference() + ".\n";
    return desc;
}
}
}

```

The `Circle` class implements the `IGeometricShape` interface, so it must provide code for both the `getArea()` method and the `describe()` method. In addition, it defines the `getCircumference()` method, which is unique to the `Circle` class. The `Circle` class also declares a property, `diameter`, which won't be found in the other polygon classes.

The other two types of shapes, squares and equilateral triangles, have some other things in common: they each have sides of equal length, and there are common formulas you can use to calculate the perimeter and sum of interior angles for both. In fact, those common formulas will apply to any other regular polygons that you need to define in the future as well.

The `RegularPolygon` class will be the superclass for both the `Square` class and the `EquilateralTriangle` class. A superclass lets you define common methods in one place, so you don't have to define them separately in each subclass. Here is the code for the `RegularPolygon` class:

```

package com.example.programmingas3.geometricshapes
{
    public class RegularPolygon implements IPolygon
    {
        public var numSides:int;
    }
}

```



```

public var sideLength:Number;

public function RegularPolygon(len:Number = 100, sides:int = 3):void
{
    this.sideLength = len;
    this.numSides = sides;
}

public function getArea():Number
{
    // This method should be overridden in subclasses.
    return 0;
}

public function getPerimeter():Number
{
    return sideLength * numSides;
}

public function getSumOfAngles():Number
{
    if (numSides >= 3)
    {
        return ((numSides - 2) * 180);
    }
    else
    {
        return 0;
    }
}

public function describe():String
{
    var desc:String = "Each side is " + sideLength + " pixels long.\n";
    desc += "Its area is " + getArea() + " pixels square.\n";
    desc += "Its perimeter is " + getPerimeter() + " pixels long.\n";
    desc += "The sum of all interior angles in this shape is " +
getSumOfAngles() + " degrees.\n";
    return desc;
}
}

```

First, the `RegularPolygon` class declares two properties that are common to all regular polygons: the length of each side (the `sideLength` property) and the number of sides (the `numSides` property).

The `RegularPolygon` class implements the `IPolygon` interface and declares all four of the `IPolygon` interface methods. It implements two of these—the `getPerimeter()` and `getSumOfAngles()` methods—using common formulas.

Because the formula for the `getArea()` method will differ from shape to shape, the base class version of the method cannot include common logic that can be inherited by the subclass methods. Instead, it simply returns a 0 default value to indicate that the area was not calculated. To calculate the area of each shape correctly, the subclasses of the `RegularPolygon` class will have to override the `getArea()` method themselves.

The following code for the `EquilateralTriangle` class show how the `getArea()` method is overridden:

```
package com.example.programmingas3.geometricshapes
{
    public class EquilateralTriangle extends RegularPolygon
    {
        public function EquilateralTriangle(len:Number = 100):void
        {
            super(len, 3);
        }

        public override function getArea():Number
        {
            // The formula is ((sideLength squared) * (square root of 3)) / 4.
            return ( (this.sideLength * this.sideLength) * Math.sqrt(3) ) / 4;
        }

        public override function describe():String
        {
            /* starts with the name of the shape, then delegates the rest
            of the description work to the RegularPolygon superclass */
            var desc:String = "This shape is an equilateral Triangle.\n";
            desc += super.describe();
            return desc;
        }
    }
}
```

The `override` keyword indicates that the `EquilateralTriangle.getArea()` method intentionally overrides the `getArea()` method from the `RegularPolygon` superclass. When the `EquilateralTriangle.getArea()` method is called, it calculates the area using the formula in the preceding code, and the code in the `RegularPolygon.getArea()` method never executes.

In contrast, the `EquilateralTriangle` class doesn't define its own version of the `getPerimeter()` method. When the `EquilateralTriangle.getPerimeter()` method is called, the call goes up the inheritance chain and executes the code in the `getPerimeter()` method of the `RegularPolygon` superclass.

The `EquilateralTriangle()` constructor uses the `super()` statement to explicitly invoke the `RegularPolygon()` constructor of its superclass. If both constructors had the same set of parameters, you could have omitted the `EquilateralTriangle()` constructor completely, and the `RegularPolygon()` constructor would be executed instead. However, the `RegularPolygon()` constructor needs an extra parameter, `numSides`. So the `EquilateralTriangle()` constructor calls `super(len, 3)`, which passes along the `len` input parameter and the value `3` to indicate that the triangle will have 3 sides.

The `describe()` method also uses the `super()` statement, but in a different way—to invoke the `RegularPolygon` superclass' version of the `describe()` method. The `EquilateralTriangle.describe()` method first sets the `desc` string variable to a statement about the type of shape. Then it gets the results of the `RegularPolygon.describe()` method by calling `super.describe()`, and it appends that result to the `desc` string.

The `Square` class won't be described in detail here, but it is similar to the `EquilateralTriangle` class, providing a constructor and its own implementations of the `getArea()` and `describe()` methods.

## Polymorphism and the factory method

A set of classes that make good use of interfaces and inheritance can be used in many interesting ways. For example, all of the shape classes described so far either implement the `IGeometricShape` interface or extend a superclass that does. So if you define a variable to be an instance of `IGeometricShape`, you don't have to know whether it is actually an instance of the `Circle` or the `Square` class in order to call its `describe()` method.

The following code shows how this works:

```
var myShape:IGeometricShape = new Circle(100);
trace(myShape.describe());
```

When `myShape.describe()` is called, it executes the method `Circle.describe()`, because even though the variable is defined as an instance of the `IGeometricShape` interface, `Circle` is its underlying class.

This example shows the principle of polymorphism in action: the exact same method call results in different code being executed, depending on the class of the object whose method is being invoked.

The `GeometricShapes` application applies this kind of interface-based polymorphism using a simplified version of a design pattern known as the factory method. The term *factory method* refers to a function that returns an object whose underlying data type or contents can differ depending on the context.

The `GeometricShapeFactory` class shown here defines a factory method named `createShape()`:

```
package com.example.programmingas3.geometricshapes
{
    public class GeometricShapeFactory
    {
        public static var currentShape:IGeometricShape;

        public static function createShape(shapeName:String,
                                           len:Number):IGeometricShape
        {
            switch (shapeName)
            {
                case "Triangle":
                    return new EquilateralTriangle(len);

                case "Square":
                    return new Square(len);

                case "Circle":
                    return new Circle(len);
            }
            return null;
        }

        public static function describeShape(shapeType:String,
                                             shapeSize:Number):String
        {
            GeometricShapeFactory.currentShape =
                GeometricShapeFactory.createShape(shapeType, shapeSize);
            return GeometricShapeFactory.currentShape.describe();
        }
    }
}
```

The `createShape()` factory method lets the shape subclass constructors define the details of the instances that they create, while returning the new objects as `IGeometricShape` instances so that they can be handled by the application in a more general way.

The `describeShape()` method in the preceding example shows how an application can use the factory method to get a generic reference to a more specific object. The application can get the description for a newly created `Circle` object like this:

```
GeometricShapeFactory.describeShape("Circle", 100);
```

The `describeShape()` method then calls the `createShape()` factory method with the same parameters, storing the new `Circle` object in a static variable named `currentShape`, which was typed as an `IGeometricShape` object. Next, the `describe()` method is called on the `currentShape` object, and that call is automatically resolved to execute the `Circle.describe()` method, returning a detailed description of the circle.

## Enhancing the sample application

The real power of interfaces and inheritance becomes apparent when you enhance or change your application.

Say that you wanted to add a new shape, a pentagon, to this sample application. You would create a new `Pentagon` class that extends the `RegularPolygon` class and defines its own versions of the `getArea()` and `describe()` methods. Then you would add a new `Pentagon` option to the combo box in the application's user interface. But that's it. The `Pentagon` class would automatically get the functionality of the `getPerimeter()` method and the `getSumOfAngles()` method from the `RegularPolygon` class by inheritance. Because it inherits from a class that implements the `IGeometricShape` interface, a `Pentagon` instance can be treated as an `IGeometricShape` instance too. That means you do not need to change any of the methods in the `GeometricShapeFactory` class, making it much easier to add new types of shapes when needed.

You may want to add a `Pentagon` class to the `Geometric Shapes` example as an exercise, to see how interfaces and inheritance can ease the workload of adding new features to an application.



Timing might not be everything, but it's usually a key factor in software applications. ActionScript 3.0 provides powerful ways to manage calendar dates, times, and time intervals. Two main classes provide most of this timing functionality: the Date class and the new Timer class in the flash.utils package.

## Contents

Basics of dates and times .....	191
Managing calendar dates and times .....	193
Controlling time intervals .....	196
Example: Simple analog clock .....	199

## Basics of dates and times

### Introduction to working with dates and times

Dates and times are a common type of information used in ActionScript programs. For instance, you might need to know the current day of the week or to measure how much time a user spends on a particular screen, among many other possibilities. In ActionScript, you can use the Date class to represent a single moment in time, including date and time information. Within a Date instance are values for the individual date and time units, including year, month, date, day of the week, hour, minutes, seconds, milliseconds, and time zone. For more advanced uses, ActionScript also includes the Timer class, which you can use to perform actions after a certain delay or at repeated intervals.

## Common date and time tasks

This chapter describes the following common tasks for working with date and time information:

- Working with Date objects
- Getting the current date and time
- Accessing individual date and time units (days, years, hours, minutes, and so on)
- Performing arithmetic with dates and times
- Converting between time zones
- Performing repeating actions
- Performing actions after a set time interval

## Important concepts and terms

The following reference list contains important terms that you will encounter in this chapter:

- UTC time: Coordinated Universal Time—the “zero hour” reference time zone. All other time zones are defined as a number of hours relative to (ahead of or behind) UTC time.

## Working through in-chapter examples

As you’re working through the chapter, you may want to test some of the example code listings for yourself. Because the code listings in this chapter deal primarily with Date objects, testing the examples will involve viewing the values of the variables used in the examples, either by writing values into a text field instance on the Stage, or by using the `trace()` function to print values to the Output panel. These techniques are described in detail in [“Testing in-chapter example code listings” on page 63](#).



# Managing calendar dates and times

All of the calendar date and time management functions in ActionScript 3.0 are concentrated in the top-level `Date` class. The `Date` class contains methods and properties that let you handle dates and times in either Coordinated Universal Time (UTC) or in local time specific to a time zone. UTC is a standard time definition that is essentially the same as Greenwich Mean Time (GMT).

## Creating Date objects

The `Date` class boasts one of the most versatile constructor methods of all the core classes. You can invoke it four different ways.

First, if given no parameters, the `Date()` constructor returns a `Date` object containing the current date and time, in local time based on your time zone. Here's an example:

```
var now:Date = new Date();
```

Second, if given a single numeric parameter, the `Date()` constructor treats that as the number of milliseconds since January 1, 1970, and returns a corresponding `Date` object. Note that the millisecond value you pass in is treated as milliseconds since January 1, 1970, in UTC.

However, the `Date` object shows values in your local time zone, unless you use the UTC-specific methods to retrieve and display them. If you create a new `Date` object using a single milliseconds parameter, make sure you account for the time zone difference between your local time and UTC. The following statements create a `Date` object set to midnight on the day of January 1, 1970, in UTC:

```
var millisecondsPerDay:int = 1000 * 60 * 60 * 24;  
// gets a Date one day after the start date of 1/1/1970  
var startTime:Date = new Date(millisecondsPerDay);
```

Third, you can pass multiple numeric parameters to the `Date()` constructor. It treats those parameters as the year, month, day, hour, minute, second, and millisecond, respectively, and returns a corresponding `Date` object. Those input parameters are assumed to be in local time rather than UTC. The following statements get a `Date` object set to midnight at the start of January 1, 2000, in local time:

```
var millenium:Date = new Date(2000, 0, 1, 0, 0, 0, 0);
```

Fourth, you can pass a single string parameter to the `Date()` constructor. It will try to parse that string into date or time components and then return a corresponding `Date` object. If you use this approach, it's a good idea to enclose the `Date()` constructor in a `try...catch` block to trap any parsing errors. The `Date()` constructor accepts a number of different string formats, as listed in the *ActionScript 3.0 Language and Components Reference*. The following statement initializes a new `Date` object using a string value:

```
var nextDay:Date = new Date("Mon May 1 2006 11:30:00 AM");
```

If the `Date()` constructor cannot successfully parse the string parameter, it will not raise an exception. However, the resulting `Date` object will contain an invalid date value.

## Getting time unit values

You can extract the values for various units of time within a `Date` object using properties or methods of the `Date` class. Each of the following properties gives you the value of a time unit in the `Date` object:

- The `fullYear` property
- The `month` property, which is in a numeric format with 0 for January up to 11 for December
- The `date` property, which is the calendar number of the day of the month, in the range of 1 to 31
- The `day` property, which is the day of the week in numeric format, with 0 standing for Sunday
- The `hours` property, in the range of 0 to 23
- The `minutes` property
- The `seconds` property
- The `milliseconds` property

In fact, the `Date` class gives you a number of ways to get each of these values. For example, you can get the month value of a `Date` object in four different ways:

- The `month` property
- The `getMonth()` method
- The `monthUTC` property
- The `getMonthUTC()` method

All four ways are essentially equivalent in terms of efficiency, so you can use whichever approach suits your application best.

The properties just listed all represent components of the total date value. For example, the milliseconds property will never be greater than 999, since when it reaches 1000 the seconds value increases by 1 and the milliseconds property resets to 0.

If you want to get the value of the Date object in terms of milliseconds since January 1, 1970 (UTC), you can use the `getTime()` method. Its counterpart, the `setTime()` method, lets you change the value of an existing Date object using milliseconds since January 1, 1970 (UTC).

## Performing date and time arithmetic

You can perform addition and subtraction on dates and times with the Date class. Date values are kept internally in terms of milliseconds, so you should convert other values to milliseconds before adding them to or subtracting them from Date objects.

If your application will perform a lot of date and time arithmetic, you might find it useful to create constants that hold common time unit values in terms of milliseconds, like the following:

```
public static const millisecondsPerMinute:int = 1000 * 60;
public static const millisecondsPerHour:int = 1000 * 60 * 60;
public static const millisecondsPerDay:int = 1000 * 60 * 60 * 24;
```

Now it is easy to perform date arithmetic using standard time units. The following code sets a date value to one hour from the current time using the `getTime()` and `setTime()` methods:

```
var oneHourFromNow:Date = new Date();
oneHourFromNow.setTime(oneHourFromNow.getTime() + millisecondsPerHour);
```

Another way to set a date value is to create a new Date object using a single milliseconds parameter. For example, the following code adds 30 days to one date to calculate another:

```
// sets the invoice date to today's date
var invoiceDate:Date = new Date();

// adds 30 days to get the due date
var dueDate:Date = new Date(invoiceDate.getTime() + (30 *
    millisecondsPerDay));
```

Next, the `millisecondsPerDay` constant is multiplied by 30 to represent 30 days' time and the result is added to the `invoiceDate` value and used to set the `dueDate` value.

## Converting between time zones

Date and time arithmetic comes in handy when you want to convert dates from one time zone to another. So does the `getTimezoneOffset()` method, which returns the value in minutes by which the Date object's time zone differs from UTC. It returns a value in minutes because not all time zones are set to even-hour increments—some have half-hour offsets from neighboring zones.

The following example uses the time zone offset to convert a date from local time to UTC. It does the conversion by first calculating the time zone value in milliseconds and then adjusting the Date value by that amount:

```
// creates a Date in local time
var nextDay:Date = new Date("Mon May 1 2006 11:30:00 AM");

// converts the Date to UTC by adding or subtracting the time zone offset
var offsetMilliseconds:Number = nextDay.getTimezoneOffset() * 60 * 1000;
nextDay.setTime(nextDay.getTime() + offsetMilliseconds);
```

## Controlling time intervals

When you develop applications using Adobe Flash CS3 Professional, you have access to the timeline, which provides a steady, frame-by-frame progression through your application. In pure ActionScript projects, however, you must rely on other timing mechanisms.

## Loops versus timers

In some programming languages, you must devise your own timing schemes using loop statements like `for` or `do..while`.

Loop statements generally execute as fast as the local machine allows, which means that the application runs faster on some machines and slower on others. If your application needs a consistent timing interval, you need to tie it to an actual calendar or clock time. Many applications, such as games, animations, and real-time controllers, need regular, time-driven ticking mechanisms that are consistent from machine to machine.

The ActionScript 3.0 Timer class provides a powerful solution. Using the ActionScript 3.0 event model, the Timer class dispatches timer events whenever a specified time interval is reached.

## The Timer class

The preferred way to handle timing functions in ActionScript 3.0 is to use the `Timer` class (`flash.utils.Timer`), which can be used to dispatch events whenever an interval is reached.

To start a timer, you first create an instance of the `Timer` class, telling it how often to generate a timer event and how many times to do so before stopping.

For example, the following code creates a `Timer` instance that dispatches an event every second and continues for 60 seconds:

```
var oneMinuteTimer:Timer = new Timer(1000, 60);
```

The `Timer` object dispatches a `TimerEvent` object each time the given interval is reached. A `TimerEvent` object's event type is `timer` (defined by the constant `TimerEvent.TIMER`). A `TimerEvent` object contains the same properties as a standard `Event` object.

If the `Timer` instance is set to a fixed number of intervals, it will also dispatch a `timerComplete` event (defined by the constant `TimerEvent.TIMER_COMPLETE`) when it reaches the final interval.

Here is a small sample application showing the `Timer` class in action:

```
package
{
    import flash.display.Sprite;
    import flash.events.TimerEvent;
    import flash.utils.Timer;

    public class ShortTimer extends Sprite
    {
        public function ShortTimer()
        {
            // creates a new five-second Timer
            var minuteTimer:Timer = new Timer(1000, 5);

            // designates listeners for the interval and completion events
            minuteTimer.addEventListener(TimerEvent.TIMER, onTick);
            minuteTimer.addEventListener(TimerEvent.TIMER_COMPLETE,
            onTimerComplete);

            // starts the timer ticking
            minuteTimer.start();
        }

        public function onTick(event:TimerEvent):void
        {
            // displays the tick count so far
            // The target of this event is the Timer instance itself.
            trace("tick " + event.target.currentCount);
        }
    }
}
```

```

        public function onTimerComplete(event:TimerEvent):void
        {
            trace("Time's Up!");
        }
    }
}

```

When the `ShortTimer` class is created, it creates a `Timer` instance that will tick once per second for five seconds. Then it adds two listeners to the timer: one that listens to each tick, and one that listens for the `timerComplete` event.

Next, it starts the timer ticking, and from that point forward, the `onTick()` method executes at one-second intervals.

The `onTick()` method simply displays the current tick count. After five seconds have passed, the `onTimerComplete()` method executes, telling you that the time is up.

When you run this sample, you should see the following lines appear in your console or trace window at the rate of one line per second:

```

tick 1
tick 2
tick 3
tick 4
tick 5
Time's Up!

```

## Timing functions in the `flash.utils` package

ActionScript 3.0 contains a number of timing functions similar to those that were available in ActionScript 2.0. These functions are provided as package-level functions in the `flash.utils` package, and they operate just as they did in ActionScript 2.0.

Function	Description
<code>clearInterval(id:uint):void</code>	Cancels a specified <code>setInterval()</code> call.
<code>clearTimeout(id:uint):void</code>	Cancels a specified <code>setTimeout()</code> call.
<code>getTimer():int</code>	Returns the number of milliseconds that have elapsed since Adobe Flash Player was initialized.
<code>setInterval(closure:Function, delay:Number, ... arguments):uint</code>	Runs a function at a specified interval (in milliseconds).
<code>setTimeout(closure:Function, delay:Number, ... arguments):uint</code>	Runs a specified function after a specified delay (in milliseconds).

These functions remain in ActionScript 3.0 for backward compatibility. Adobe does not recommend that you use them in new ActionScript 3.0 applications. In general, it is easier and more efficient to use the Timer class in your applications.

## Example: Simple analog clock

A simple analog clock example illustrates two of the date and time concepts discussed in this chapter:

- Getting the current date and time and extracting values for the hours, minutes, and seconds
- Using a Timer to set the pace of an application

To get the application files for this sample, see [www.adobe.com/go/learn\\_programmingAS3samples\\_flash](http://www.adobe.com/go/learn_programmingAS3samples_flash). The SimpleClock application files can be found in the folder Samples/SimpleClock. The application consists of the following files:

File	Description
SimpleClockApp.mxml or SimpleClockApp fla	The main application file in Flash (FLA) or Flex (MXML).
com/example/programmingas3/ simpleclock/SimpleClock.as	The main application file.
com/example/programmingas3/ simpleclock/AnalogClockFace.as	Draws a round clock face and hour, minute, and seconds hands based on the time.

## Defining the SimpleClock class

The clock example is simple, but it's a good idea to organize even simple applications well so you could easily expand them in the future. To that end, the SimpleClock application uses the SimpleClock class to handle the startup and time-keeping tasks, and then uses another class named AnalogClockFace to actually display the time.

Here is the code that defines and initializes the SimpleClock class (note that in the Flash version, SimpleClock extends the Sprite class instead):

```
public class SimpleClock extends UIComponent
{
    /**
     * The time display component.
     */
    private var face:AnalogClockFace;
```

```
/**
 * The Timer that acts like a heartbeat for the application.
 */
private var ticker:Timer;
```

The class has two important properties:

- The `face` property, which is an instance of the `AnalogClockFace` class
- The `ticker` property, which is an instance of the `Timer` class

The `SimpleClock` class uses a default constructor. The `initClock()` method takes care of the real setup work, creating the clock face and starting the `Timer` instance ticking.

## Creating the clock face

The next lines in the `SimpleClock` code create the clock face that is used to display the time:

```
/**
 * Sets up a SimpleClock instance.
 */
public function initClock(faceSize:Number = 200)
{
    // creates the clock face and adds it to the display list
    face = new AnalogClockFace(Math.max(20, faceSize));
    face.init();
    addChild(face);

    // draws the initial clock display
    face.draw();
```

The size of the face can be passed in to the `initClock()` method. If no `faceSize` value is passed, a default size of 200 pixels is used.

Next, the application initializes the face and then adds it to the display list using the `addChild()` method inherited from the `DisplayObject` class. Then it calls the `AnalogClockFace.draw()` method to display the clock face once, showing the current time.

## Starting the timer

After creating the clock face, the `initClock()` method sets up a timer:

```
// creates a Timer that fires an event once per second
ticker = new Timer(1000);

// designates the onTick() method to handle Timer events
ticker.addEventListener(TimerEvent.TIMER, onTick);

// starts the clock ticking
ticker.start();
```



First this method instantiates a `Timer` instance that will dispatch an event once per second (every 1000 milliseconds). Since no second `repeatCount` parameter is passed to the `Timer()` constructor, the `Timer` will keep repeating indefinitely.

The `SimpleClock.onTick()` method will execute once per second when the timer event is received:

```
public function onTick(event:TimerEvent):void
{
    // updates the clock display
    face.draw();
}
```

The `AnalogClockFace.draw()` method simply draws the clock face and hands.

## Displaying the current time

Most of the code in the `AnalogClockFace` class involves setting up the clock face's display elements. When the `AnalogClockFace` is initialized, it draws a circular outline, places a numeric text label at each hour mark, and then creates three `Shape` objects, one each for the hour hand, the minute hand, and the second hand on the clock.

Once the `SimpleClock` application is running, it calls the `AnalogClockFace.draw()` method each second, as follows:

```
/**
 * Called by the parent container when the display is being drawn.
 */
public override function draw():void
{
    // stores the current date and time in an instance variable
    currentTime = new Date();
    showTime(currentTime);
}
```

This method saves the current time in a variable, so the time can't change in the middle of drawing the clock hands. Then it calls the `showTime()` method to display the hands, as the following shows:

```
/**
 * Displays the given Date/Time in that good old analog clock style.
 */
public function showTime(time:Date):void
{
    // gets the time values
    var seconds:uint = time.getSeconds();
    var minutes:uint = time.getMinutes();
    var hours:uint = time.getHours();
```

```
// multiplies by 6 to get degrees
this.secondHand.rotation = 180 + (seconds * 6);
this.minuteHand.rotation = 180 + (minutes * 6);

// Multiply by 30 to get basic degrees, then
// add up to 29.5 degrees (59 * 0.5)
// to account for the minutes.
this.hourHand.rotation = 180 + (hours * 30) + (minutes * 0.5);
}
```

First, this method extracts the values for the hours, minutes, and seconds of the current time. Then it uses these values to calculate the angle for each hand. Since the second hand makes a full rotation in 60 seconds, it rotates 6 degrees each second ( $360/60$ ). The minute hand rotates the same amount each minute.

The hour hand updates every minute, too, so it can show some progress as the minutes tick by. It rotates 30 degrees each hour ( $360/12$ ), but it also rotates half a degree each minute (30 degrees divided by 60 minutes).

The `String` class contains methods that let you work with text strings. Strings are important in working with many objects. The methods described in this chapter are useful in working with strings used in objects such as `TextField`, `StaticText`, `XML`, `ContextMenu`, and `FileReference` objects.

Strings are sequences of characters. ActionScript 3.0 supports ASCII and Unicode characters.

## Contents

Basics of strings .....	204
Creating strings .....	205
The length property .....	207
Working with characters in strings .....	208
Comparing strings .....	208
Obtaining string representations of other objects .....	209
Concatenating strings .....	209
Finding substrings and patterns in strings .....	210
Converting strings between uppercase and lowercase .....	215
Example: ASCII art .....	216

# Basics of strings

## Introduction to working with strings

In programming parlance, a string is a text value—a sequence of letters, numbers, or other characters strung together into a single value. For instance, this line of code creates a variable with the data type `String` and assigns a literal string value to that variable:

```
var albumName:String = "Three for the money";
```

As this example shows, in ActionScript you can denote a string value by surrounding text with double or single quotation marks. Here are several more examples of strings:

```
"Hello"  
"555-7649"  
"http://www.adobe.com/"
```

Any time you manipulate a piece of text in ActionScript, you are working with a string value. The ActionScript `String` class is the data type you can use to work with text values. String instances are frequently used for properties, method parameters, and so forth in many other ActionScript classes.

## Common tasks for working with strings

The following are common string-related tasks that are explored in this chapter:

- Creating String objects
- Working with special characters such as carriage-return, tab, and non-keyboard characters
- Measuring string length
- Isolating individual characters in a string
- Joining strings
- Comparing strings
- Finding, extracting, and replacing portions of a string
- Making strings uppercase or lowercase

## Important concepts and terms

The following reference list contains important terms that you will encounter in this chapter:

- **ASCII:** A system for representing text characters and symbols in computer programs. The ASCII system supports the 26-letter English alphabet, plus a limited set of additional characters.
- **Character:** The smallest unit of text data (a single letter or symbol).
- **Concatenation:** Joining multiple string values together by adding one to the end of the other, creating a new string value.
- **Empty string:** A string that contains no text, white space, or other characters, written as `""`. An empty string value is different from a `String` variable with a null value—a null `String` variable is a variable that does not have a `String` instance assigned to it, whereas an empty string has an instance with a value that contains no characters.
- **String:** A textual value (sequence of characters).
- **String literal (or “literal string”):** A string value written explicitly in code, written as a text value surrounded by double quotation marks or single quotation marks.
- **Substring:** A string that is a portion of another string.
- **Unicode:** A standard system for representing text characters and symbols in computer programs. The Unicode system allows for the use of any character in any writing system.

## Working through in-chapter examples

As you’re working through the chapter, you may want to test some of the example code listings for yourself. Because the code listings in this chapter deal primarily with manipulating text, testing the examples will involve viewing the values of the variables used in the examples, either by writing values into a text field instance on the Stage or by using the `trace()` function to print values to the Output panel. These techniques are described in detail in [“Testing in-chapter example code listings” on page 63](#).

## Creating strings

The `String` class is used to represent string (textual) data in ActionScript 3.0. ActionScript strings support both ASCII and Unicode characters. The simplest way to create a string is to use a string literal. To declare a string literal, use straight double quotation mark (`"`) or single quotation mark (`'`) characters. For example, the following two strings are equivalent:

```
var str1:String = "hello";  
var str2:String = 'hello';
```

You can also declare a string by using the `new` operator, as follows:

```
var str1:String = new String("hello");
var str2:String = new String(str1);
var str3:String = new String();          // str3 == ""
```

The following two strings are equivalent:

```
var str1:String = "hello";
var str2:String = new String("hello");
```

To use single quotation marks (') within a string literal defined with single quotation mark (') delimiters, use the backslash escape character (\). Similarly, to use double quotation marks (") within a string literal defined with double quotation marks (") delimiters, use the backslash escape character (\). The following two strings are equivalent:

```
var str1:String = "That's \"A-OK\"";
var str2:String = 'That\'s "A-OK"';
```

You may choose to use single quotation marks or double quotation marks based on any single or double quotation marks that exist in a string literal, as in the following:

```
var str1:String = "ActionScript <span class='heavy'>3.0</span>";
var str2:String = '<item id="155">banana</item>';
```

Keep in mind that ActionScript distinguishes between a straight single quotation mark (') and a left or right single quotation mark (‘ or ’). The same is true for double quotation marks. Use straight quotation marks to delineate string literals. When pasting text from another source into ActionScript, be sure to use the correct characters.

As the following table shows, you can use the backslash escape character (`\`) to define other characters in string literals:

---

Escape sequence	Character
<code>\b</code>	Backspace
<code>\f</code>	Form feed
<code>\n</code>	Newline
<code>\r</code>	Carriage return
<code>\t</code>	Tab
<code>\unnnn</code>	The Unicode character with the character code specified by the hexadecimal number <i>nnnn</i> ; for example, <code>\u263a</code> is the smiley character.
<code>\xnn</code>	The ASCII character with the character code specified by the hexadecimal number <i>nn</i>
<code>\'</code>	Single quotation mark
<code>\"</code>	Double quotation mark
<code>\\</code>	Single backslash character

---

## The length property

Every string has a `length` property, which is equal to the number of characters in the string:

```
var str:String = "Adobe";
trace(str.length);           // output: 5
```

An empty string and a null string both have a length of 0, as the following example shows:

```
var str1:String = new String();
trace(str1.length);         // output: 0

str2:String = '';
trace(str2.length);         // output: 0
```

# Working with characters in strings

Every character in a string has an index position in the string (an integer). The index position of the first character is 0. For example, in the following string, the character *y* is in position 0 and the character *w* is in position 5:

```
"yellow"
```

You can examine individual characters in various positions in a string using the `charAt()` method and the `charCodeAt()` method, as in this example:

```
var str:String = "hello world!";
for (var:i = 0; i < str.length; i++)
{
    trace(str.charAt(i), "-", str.charCodeAt(i));
}
```

When you run this code, the following output is produced:

```
h - 104
e - 101
l - 108
l - 108
o - 111
  - 32
w - 119
o - 111
r - 114
l - 108
d - 100
! - 33
```

You can also use character codes to define a string using the `fromCharCode()` method, as the following example shows:

```
var myStr:String =
    String.fromCharCode(104,101,108,108,111,32,119,111,114,108,100,33);
    // Sets myStr to "hello world!"
```

# Comparing strings

You can use the following operators to compare strings: `<`, `<=`, `!=`, `==`, `=>`, and `>`. These operators can be used with conditional statements, such as `if` and `while`, as the following example shows:

```
var str1:String = "Apple";
var str2:String = "apple";
if (str1 < str2)
{
    trace("A < a, B < b, C < c, ...");
}
```



```
}
```

When using these operators with strings, ActionScript considers the character code value of each character in the string, comparing characters from left to right, as in the following:

```
trace("A" < "B"); // true
trace("A" < "a"); // true
trace("Ab" < "az"); // true
trace("abc" < "abza"); // true
```

Use the `==` and `!=` operators to compare strings with each other and to compare strings with other types of objects, as the following example shows:

```
var str1:String = "1";
var str1b:String = "1";
var str2:String = "2";
trace(str1 == str1b); // true
trace(str1 == str2); // false
var total:uint = 1;
trace(str1 == total); // true
```

## Obtaining string representations of other objects

You can obtain a `String` representation for any kind of object. All objects have a `toString()` method for this purpose:

```
var n:Number = 99.47;
var str:String = n.toString();
// str == "99.47"
```

When using the `+` concatenation operator with a combination of `String` objects and objects that are not strings, you do not need to use the `toString()` method. For details on concatenation, see the next section.

The `String()` global function returns the same value for a given object as the value returned by the object calling the `toString()` method.

## Concatenating strings

Concatenation of strings means taking two strings and joining them sequentially into one.

For example, you can use the `+` operator to concatenate two strings:

```
var str1:String = "green";
var str2:String = "ish";
var str3:String = str1 + str2; // str3 == "greenish"
```

You can also use the `+=` operator to produce the same result, as the following example shows:

```
var str:String = "green";
str += "ish"; // str == "greenish"
```

Additionally, the `String` class includes a `concat()` method, which can be used as follows:

```
var str1:String = "Bonjour";
var str2:String = "from";
var str3:String = "Paris";
var str4:String = str1.concat(" ", str2, " ", str3);
// str4 == "Bonjour from Paris"
```

If you use the `+` operator (or the `+=` operator) with a `String` object and an object that is *not* a string, `ActionScript` automatically converts the nonstring object to a `String` object in order to evaluate the expression, as shown in this example:

```
var str:String = "Area = ";
var area:Number = Math.PI * Math.pow(3, 2);
str = str + area; // str == "Area = 28.274333882308138"
```

However, you can use parentheses for grouping to provide context for the `+` operator, as the following example shows:

```
trace("Total: $" + 4.55 + 1.45); // output: Total: $4.551.45
trace("Total: $" + (4.55 + 1.45)); // output: Total: $6
```

## Finding substrings and patterns in strings

Substrings are sequential characters within a string. For example, the string "abc" has the following substrings: "", "a", "ab", "abc", "b", "bc", "c". You can use `ActionScript` methods to locate substrings of a string.

Patterns are defined in `ActionScript` by strings or by regular expressions. For example, the following regular expression defines a specific pattern—the letters A, B, and C followed by a digit character (the forward slashes are regular expression delimiters):

```
/ABC\d/
```

`ActionScript` includes methods for finding patterns in strings and for replacing found matches with replacement substrings. These methods are described in the following sections.

Regular expressions can define intricate patterns. For more information, see [Chapter 9, “Using regular expressions,” on page 285](#).

## Finding a substring by character position

The `substr()` and `substring()` methods are similar. Both return a substring of a string. Both take two parameters. In both methods, the first parameter is the position of the starting character in the given string. However, in the `substr()` method, the second parameter is the *length* of the substring to return, and in the `substring()` method, the second parameter is the position of the character at the *end* of the substring (which is not included in the returned string). This example shows the difference between these two methods:

```
var str:String = "Hello from Paris, Texas!!!";
trace(str.substr(11,15)); // output: Paris, Texas!!!
trace(str.substring(11,15)); // output: Pari
```

The `slice()` method functions similarly to the `substring()` method. When given two non-negative integers as parameters, it works exactly the same. However, the `slice()` method can take negative integers as parameters, in which case the character position is taken from the end of the string, as shown in the following example:

```
var str:String = "Hello from Paris, Texas!!!";
trace(str.slice(11,15)); // output: Pari
trace(str.slice(-3,-1)); // output: !!
trace(str.slice(-3,26)); // output: !!!
trace(str.slice(-3,str.length)); // output: !!!
trace(str.slice(-8,-3)); // output: Texas
```

You can combine non-negative and negative integers as the parameters of the `slice()` method.

## Finding the character position of a matching substring

You can use the `indexOf()` and `lastIndexOf()` methods to locate matching substrings within a string, as the following example shows:

```
var str:String = "The moon, the stars, the sea, the land";
trace(str.indexOf("the")); // output: 10
```

Notice that the `indexOf()` method is case-sensitive.

You can specify a second parameter to indicate the index position in the string from which to start the search, as follows:

```
var str:String = "The moon, the stars, the sea, the land"
trace(str.indexOf("the", 11)); // output: 21
```

The `lastIndexOf()` method finds the last occurrence of a substring in the string:

```
var str:String = "The moon, the stars, the sea, the land"
trace(str.lastIndexOf("the")); // output: 30
```

If you include a second parameter with the `lastIndexOf()` method, the search is conducted from that index position in the string working backward (from right to left):

```
var str:String = "The moon, the stars, the sea, the land"
trace(str.lastIndexOf("the", 29)); // output: 21
```

## Creating an array of substrings segmented by a delimiter

You can use the `split()` method to create an array of substrings, which is divided based on a delimiter. For example, you can segment a comma-delimited or tab-delimited string into multiple strings.

The following example shows how to split an array into substrings with the ampersand (&) character as the delimiter:

```
var queryStr:String = "first=joe&last=cheng&title=manager&StartDate=3/6/65";
var params:Array = queryStr.split("&", 2); // params == ["first=joe", "last=cheng"]
```

The second parameter of the `split()` method, which is optional, defines the maximum size of the array that is returned.

You can also use a regular expression as the delimiter character:

```
var str:String = "Give me\t5."
var a:Array = str.split(/\s+/); // a == ["Give", "me", "5."]
```

For more information, see [Chapter 9, “Using regular expressions,” on page 285](#) and the *ActionScript 3.0 Language and Components Reference*.

## Finding patterns in strings and replacing substrings

The `String` class includes the following methods for working with patterns in strings:

- Use the `match()` and `search()` methods to locate substrings that match a pattern.
- Use the `replace()` method to find substrings that match a pattern and replace them with a specified substring.

These methods are described in the following sections.

You can use strings or regular expressions to define patterns used in these methods. For more information on regular expressions, see [Chapter 9, “Using regular expressions,” on page 285](#).

## Finding matching substrings

The `search()` method returns the index position of the first substring that matches a given pattern, as shown in this example:

```
var str:String = "The more the merrier.";
// (This search is case-sensitive.)
trace(str.search("the")); // output: 9
```

You can also use regular expressions to define the pattern to match, as this example shows:

```
var pattern:RegExp = /the/i;
var str:String = "The more the merrier.";
trace(str.search(pattern)); // 0
```

The output of the `trace()` method is 0, because the first character in the string is index position 0. The `i` flag is set in the regular expression, so the search is not case-sensitive.

The `search()` method finds only one match and returns its starting index position, even if the `g` (global) flag is set in the regular expression.

The following example shows a more intricate regular expression, one that matches a string in double quotation marks:

```
var pattern:RegExp = /"[^"]*" /;
var str:String = "The \"more\" the merrier.";
trace(str.search(pattern)); // output: 4
```

```
str = "The \"more the merrier.";
trace(str.search(pattern)); // output: -1
// (Indicates no match, since there is no closing double quotation mark.)
```

The `match()` method works similarly. It searches for a matching substring. However, when you use the global flag in a regular expression pattern, as in the following example, `match()` returns an array of matching substrings:

```
var str:String = "bob@example.com, omar@example.org";
var pattern:RegExp = /\w*\w*\.[org|com]+/g;
var results:Array = str.match(pattern);
```

The results array is set to the following:

```
["bob@example.com", "omar@example.org"]
```

For more information on regular expressions, see [Chapter 9, “Using regular expressions,” on page 285](#).

## Replacing matched substrings

You can use the `replace()` method to search for a specified pattern in a string and replace matches with the specified replacement string, as the following example shows:

```
var str:String = "She sells seashells by the seashore.";
var pattern:RegExp = /sh/gi;
trace(str.replace(pattern, "sch"));
//sche sells seaschells by the seaschore.
```

Note that in this example, the matched strings are not case-sensitive because the `i` (`ignoreCase`) flag is set in the regular expression, and multiple matches are replaced because the `g` (`global`) flag is set. For more information, see [Chapter 9, “Using regular expressions,” on page 285](#).

You can include the following `$` replacement codes in the replacement string. The replacement text shown in the following table is inserted in place of the `$` replacement code:

<b>\$ Code</b>	<b>Replacement Text</b>
<code>\$\$</code>	<code>\$</code>
<code>&amp;</code>	The matched substring.
<code>`</code>	The portion of the string that precedes the matched substring. This code uses the straight left single quotation mark character ( <code>`</code> ), not the straight single quotation mark ( <code>'</code> ) or the left curly single quotation mark ( <code>'</code> ).
<code>'</code>	The portion of the string that follows the matched substring. This code uses the straight single quotation mark ( <code>'</code> ).
<code>\$n</code>	The <i>n</i> th captured parenthetical group match, where <i>n</i> is a single digit, 1-9, and <code>\$n</code> is not followed by a decimal digit.
<code>\$nn</code>	The <i>nn</i> th captured parenthetical group match, where <i>nn</i> is a two-digit decimal number, 01-99. If the <i>nn</i> th capture is undefined, the replacement text is an empty string.

For example, the following shows the use of the `$2` and `$1` replacement codes, which represent the first and second capturing group matched:

```
var str:String = "flip-flop";
var pattern:RegExp = /(\w+)-(\w+)/g;
trace(str.replace(pattern, "$2-$1")); // flop-flip
```

You can also use a function as the second parameter of the `replace()` method. The matching text is replaced by the returned value of the function.

```
var str:String = "Now only $9.95!";
var price:RegExp = /\$([\d,]+\d+)/i;
trace(str.replace(price, usdToEuro));
```

```
function usdToEuro(matchedSubstring:String,
                   capturedMatch1:String,
                   index:int,
                   str:String):String
{
    var usd:String = capturedMatch1;
    usd = usd.replace(",", "");
    var exchangeRate:Number = 0.853690;
    var euro:Number = usd * exchangeRate;
    const euroSymbol:String = String.fromCharCode(8364);
    return euro.toFixed(2) + " " + euroSymbol;
}
```

When you use a function as the second parameter of the `replace()` method, the following arguments are passed to the function:

- The matching portion of the string.
- Any capturing parenthetical group matches. The number of arguments passed this way will vary depending on the number of parenthetical matches. You can determine the number of parenthetical matches by checking `arguments.length - 3` within the function code.
- The index position in the string where the match begins.
- The complete string.

## Converting strings between uppercase and lowercase

As the following example shows, the `toLowerCase()` method and the `toUpperCase()` method convert alphabetical characters in the string to lowercase and uppercase, respectively:

```
var str:String = "Dr. Bob Roberts, #9."
trace(str.toLowerCase()); // dr. bob roberts, #9.
trace(str.toUpperCase()); // DR. BOB ROBERTS, #9.
```

After these methods are executed, the source string remains unchanged. To transform the source string, use the following code:

```
str = str.toUpperCase();
```

These methods work with extended characters, not simply a–z and A–Z:

```
var str:String = "José Barça";
trace(str.toUpperCase(), str.toLowerCase()); // JOSÉ BARÇA josé barça
```

# Example: ASCII art

This ASCII Art example shows a number of features of working with the String class in ActionScript 3.0, including the following:

- The `split()` method of the String class is used to extract values from a character-delimited string (image information in a tab-delimited text file).
- Several string-manipulation techniques, including `split()`, concatenation, and extracting a portion of the string using `substring()` and `substr()`, are used to capitalize the first letter of each word in the image titles.
- The `getCharAt()` method is used to get a single character from a string (to determine the ASCII character corresponding to a grayscale bitmap value).
- String concatenation is used to build up the ASCII art representation of an image one character at a time.

The term *ASCII art* refers to a text representations of an image, in which a grid of monospaced font characters, such as Courier New characters, plots the image. The following image shows an example of ASCII art produced by the application:



*The ASCII art version of the graphic is shown on the right.*



To get the application files for this sample, see [www.adobe.com/go/learn\\_programmingAS3samples\\_flash](http://www.adobe.com/go/learn_programmingAS3samples_flash). The ASCII Art application files can be found in the folder Samples/AsciiArt. The application consists of the following files:

File	Description
AsciiArtApp.mxml or AsciiArtApp fla	The main application file in Flash (FLA) or Flex (MXML)
com/example/programmingas3/asciiArt/ AsciiArtBuilder.as	The class that provides the main functionality of the application, including extracting image metadata from a text file, loading the images, and managing the image-to-text conversion process.
com/example/programmingas3/asciiArt/ BitmapToAsciiConverter.as	A class that provides the <code>parseBitmapData()</code> method for converting image data into a String version.
com/example/programmingas3/asciiArt/ Image.as	A class which represents a loaded bitmap image.
com/example/programmingas3/asciiArt/ ImageInfo.as	A class representing metadata for an ASCII art image (such as title, image file URL, and so on).
image/	A folder containing images used by the application.
txt/ImageData.txt	A tab-delimited text file, containing information on the images to be loaded by the application.

## Extracting tab-delimited values

This example uses the common practice of storing application data separate from the application itself; that way, if the data changes (for example, if another image is added or an image's title changes), there is no need to recreate the SWF file. In this case, the image metadata, including the image title, the URL of the actual image file, and some values that are used to manipulate the image, are stored in a text file (the `txt/ImageData.txt` file in the project). The contents of the text file are as follows:

```
FILENAME|TITLE|WHITE_THRESHOLD|BLACK_THRESHOLD
FruitBasket.jpg|Pear, apple, orange, and bananad|810
Banana.jpg|A picture of a banana|C820
Orange.jpg|orange|FF20
Apple.jpg|picture of an apple|6E10
```

The file uses a specific tab-delimited format. The first line (row) is a heading row. The remaining lines contain the following data for each bitmap to be loaded:

- The filename of the bitmap.
- The display name of the bitmap.
- The white-threshold and black-threshold values for the bitmaps. These are hex values above which and below which a pixel is to be considered completely white or completely black.

As soon as the application starts, the `AsciiArtBuilder` class loads and parses the contents of the text file in order to create the “stack” of images that it will display, using the following code from the `AsciiArtBuilder` class’s `parseImageInfo()` method:

```
var lines:Array = _imageInfoLoader.data.split("\n");
var numLines:uint = lines.length;
for (var i:uint = 1; i < numLines; i++)
{
    var imageInfoRaw:String = lines[i];
    ...
    if (imageInfoRaw.length > 0)
    {
        // Create a new image info record and add it to the array of image info.
        var imageInfo:ImageInfo = new ImageInfo();

        // Split the current line into values (separated by tab (\t)
        // characters) and extract the individual properties:
        var imageProperties:Array = imageInfoRaw.split("\t");
        imageInfo.fileName = imageProperties[0];
        imageInfo.title = normalizeTitle(imageProperties[1]);
        imageInfo.whiteThreshold = parseInt(imageProperties[2], 16);
        imageInfo.blackThreshold = parseInt(imageProperties[3], 16);
        result.push(imageInfo);
    }
}
```

The entire contents of the text file are contained in a single `String` instance, the `_imageInfoLoader.data` property. Using the `split()` method with the newline character (`"\n"`) as a parameter, the `String` instance is divided into an `Array` (`lines`) whose elements are the individual lines of the text file. Next, the code uses a loop to work with each of the lines (except the first, because it contains only headers rather than actual content). Inside the loop, the `split()` method is used once again to divide the contents of the single line into a set of values (the `Array` object named `imageProperties`). The parameter used with the `split()` method in this case is the tab (`"\t"`) character, because the values in each line are delineated by tab characters.

## Using String methods to normalize image titles

One of the design decisions for this application is that all the image titles are displayed using a standard format, with the first letter of each word capitalized (except for a few words that are commonly not capitalized in English titles). Rather than assume that the text file contains properly formatted titles, the application formats the titles while they're being extracted from the text file.

In the previous code listing, as part of extracting individual image metadata values, the following line of code is used:

```
imageInfo.title = normalizeTitle(imageProperties[1]);
```

In that code, the image's title from the text file is passed through the `normalizeTitle()` method before it is stored in the `ImageInfo` object:

```
private function normalizeTitle(title:String):String
{
    var words:Array = title.split(" ");
    var len:uint = words.length;
    for (var i:uint; i < len; i++)
    {
        words[i] = capitalizeFirstLetter(words[i]);
    }

    return words.join(" ");
}
```

This method uses the `split()` method to divide the title into individual words (separated by the space character), passes each word through the `capitalizeFirstLetter()` method, and then uses the `Array` class's `join()` method to combine the words back into a single string again.

As its name suggests, the `capitalizeFirstLetter()` method actually does the work of capitalizing the first letter of each word:

```
/**
 * Capitalizes the first letter of a single word, unless it's one of
 * a set of words that are normally not capitalized in English.
 */
private function capitalizeFirstLetter(word:String):String
{
    switch (word)
    {
```

```

    case "and":
    case "the":
    case "in":
    case "an":
    case "or":
    case "at":
    case "of":
    case "a":
        // Don't do anything to these words.
        break;
    default:
        // For any other word, capitalize the first character.
        var firstLetter:String = word.substr(0, 1);
        firstLetter = firstLetter.toUpperCase();
        var otherLetters:String = word.substring(1);
        word = firstLetter + otherLetters;
    }
    return word;
}

```

In English, the initial character of each word in a title is *not* capitalized if it is one of the following words: “and,” “the,” “in,” “an,” “or,” “at,” “of,” or “a.” (This is a simplified version of the rules.) To execute this logic, the code first uses a `switch` statement to check if the word is one of the words that should not be capitalized. If so, the code simply jumps out of the `switch` statement. On the other hand, if the word should be capitalized, that is done in several steps, as follows:

1. The first letter of the word is extracted using `substr(0, 1)`, which extracts a substring starting with the character at index 0 (the first letter in the string, as indicated by the first parameter 0). The substring will be one character in length (indicated by the second parameter 1).
2. That character is capitalized using the `toUpperCase()` method.
3. The remaining characters of the original word are extracted using `substring(1)`, which extracts a substring starting at index 1 (the second letter) through the end of the string (indicated by leaving off the second parameter of the `substring()` method).
4. The final word is created by combining the newly capitalized first letter with the remaining letters using string concatenation: `firstLetter + otherLetters`.

## Generating the ASCII art text

The `BitmapToAsciiConverter` class provides the functionality of converting a bitmap image to its ASCII text representation. This process is performed by the `parseBitmapData()` method, which is partially shown here:

```
var result:String = "";

// Loop through the rows of pixels top to bottom:
for (var y:uint = 0; y < _data.height; y += verticalResolution)
{
    // Within each row, loop through pixels left to right:
    for (var x:uint = 0; x < _data.width; x += horizontalResolution)
    {
        ...

        // Convert the gray value in the 0-255 range to a value
        // in the 0-64 range (since that's the number of "shades of
        // gray" in the set of available characters):
        index = Math.floor(grayVal / 4);
        result += palette.charAt(index);
    }
    result += "\n";
}
return result;
```

This code first defines a `String` instance named `result` that will be used to build up the ASCII art version of the bitmap image. Next, it loops through individual pixels of the source bitmap image. Using several color-manipulation techniques (omitted here for brevity), it converts the red, green, and blue color values of an individual pixel to a single grayscale value (a number from 0 to 255). The code then divides that value by 4 (as shown) to convert it to a value in the 0-63 scale, which is stored in the variable `index`. (The 0-63 scale is used because the “palette” of available ASCII characters used by this application contains 64 values.) The palette of characters is defined as a `String` instance in the `BitmapToAsciiConverter` class:

```
// The characters are in order from darkest to lightest, so that their
// position (index) in the string corresponds to a relative color value
// (0 = black).
private static const palette:String =
    "@#$$%&8BMW*mqpdkhao000ZXYUJCLtFjzxnuvcr[]{}|!~><+_-;,. ";
```

Since the `index` variable defines which ASCII character in the palette corresponds to the current pixel in the bitmap image, that character is retrieved from the `palette` `String` using the `charAt()` method. It is then appended to the `result` `String` instance using the concatenation assignment operator (`+=`). In addition, at the end of each row of pixels, a newline character is concatenated to the end of the `result` `String`, forcing the line to wrap to create a new row of character “pixels.”



Arrays allow you to store multiple values in a single data structure. You can use simple indexed arrays that store values using fixed ordinal integer indexes or complex associative arrays that store values using arbitrary keys. Arrays can also be multidimensional, containing elements that are themselves arrays. This chapter discusses how to create and manipulate various types of arrays.

## Contents

Basics of arrays . . . . .	223
Indexed arrays . . . . .	225
Associative arrays . . . . .	234
Multidimensional arrays . . . . .	239
Cloning arrays . . . . .	241
Advanced topics . . . . .	241
Example: Playlist . . . . .	247

## Basics of arrays

### Introduction to working with arrays

Often in programming you'll need to work with a set of items rather than a single object; for example, in a music player application, you might want to have a list of songs waiting to be played. You wouldn't want to have to create a separate variable for each song on that list—it would be preferable to have all the Song objects together in a bundle, and be able to work with them as a group.

An array is a programming element that acts as a container for a set of items, such as a list of songs. Most commonly all the items in an array will be instances of the same class, but that is not a requirement in ActionScript. The individual items in an array are known as the array's *elements*. You might think of an array as a file drawer for variables. Variables can be added as elements in the array, which is like putting a folder into the file drawer. Once several files are in the drawer, you can work with the array as a single variable (like carrying the whole drawer to a different location); you can work with the variables as a group (like flipping through the folders one by one searching for a piece of information); or you can access them individually (like opening the drawer and selecting a single folder).

For example, imagine you're creating a music player application where a user can select multiple songs and add them to a playlist. In your ActionScript code, you might have a method named `addSongsToPlaylist()`, which accepts a single array as a parameter. No matter how many songs are to be added to the list (a few, a lot, or even only one), you have to call the `addSongsToPlaylist()` method only one time, passing it the array containing the `Song` objects. Inside the `addSongsToPlaylist()` method, you can use a loop to go through the array's elements (the songs) one by one and actually add them to the playlist.

The most common type of ActionScript array is an *indexed array*, which is an array where each item is stored in a numbered slot (known as an *index*), and items are accessed using the number, like an address. The `Array` class is used to represent an indexed array. Indexed arrays work well for most programming needs. A special use of an indexed array is a multidimensional array, which is an indexed array whose elements are indexed arrays (which in turn contain other elements). Another type of array is an *associative array*, which uses a string *key* instead of a numeric index to identify individual elements. Finally, for advanced users, ActionScript 3.0 also includes the `Dictionary` class, which represents a *dictionary*—an array that allows you to use any type of object as a key to distinguish between elements.

## Common array tasks

The following common activities for working with arrays are described in this chapter:

- Creating indexed arrays
- Adding and removing array elements
- Sorting array elements
- Extracting portions of an array
- Working with associative arrays and dictionaries
- Working with multidimensional arrays
- Copying array elements
- Creating an array subclass



## Important concepts and terms

The following reference list contains important terms that you will encounter in this chapter:

- **Array:** An object that serves as a container to group multiple objects together.
- **Associative array:** An array that uses string keys to identify individual elements.
- **Dictionary:** An array whose items consist of pairs of objects, known as the key and the value. The key is used instead of a numeric index to identify a single element.
- **Element:** A single item in an array.
- **Index:** The numeric “address” used to identify a single element in an indexed array.
- **Indexed array:** The standard type of array that stores each element in a numbered element, and uses the number (index) to identify individual elements.
- **Key:** The string or object used to identify a single element in an associative array or a dictionary.
- **Multidimensional array:** An array containing items that are arrays rather than single values.

## Working through in-chapter examples

As you’re working through the chapter, you may want to test some of the example code listings for yourself. Essentially all the code listings in this chapter include the appropriate `trace()` function call. To test the code listings in this chapter:

1. Create an empty Flash document.
2. Select a keyframe in the timeline.
3. Open the Actions panel and copy the code listing into the Script pane.
4. Run the program using `Control > Test Movie`.

You will see the results of the `trace()` function in the Output panel.

This and other techniques for testing example code listings are described in detail in [“Testing in-chapter example code listings” on page 63](#).

## Indexed arrays

Indexed arrays store a series of one or more values organized such that each value can be accessed using an unsigned integer value. The first index is always the number 0, and the index increments by 1 for each subsequent element added to the array. As the following code shows, you can create an indexed array by calling the `Array` class constructor or by initializing the array with an array literal:

```
// Use Array constructor.
var myArray:Array = new Array();
myArray.push("one");
myArray.push("two");
myArray.push("three");
trace(myArray); // output: one,two,three
```

```
// Use Array literal.
var myArray:Array = ["one", "two", "three"];
trace(myArray); // output: one,two,three
```

The Array class also contains properties and methods that allow you to modify indexed arrays. These properties and methods apply almost exclusively to indexed arrays rather than associative arrays.

Indexed arrays use an unsigned 32-bit integer for the index number. The maximum size of an indexed array is  $2^{32} - 1$  or 4,294,967,295. An attempt to create an array that is larger than the maximum size results in a run-time error.

An array element can hold a value of any data type. ActionScript 3.0 does not support the concept of *typed arrays*, which means that you cannot specify that all the elements of an array belong to a specific data type.

This section explains how to create and modify indexed arrays using the Array class, starting with how to create an array. The methods that modify arrays are grouped into three categories that cover how to insert elements, remove elements, and sort arrays. Methods in a final group treat an existing array as read-only; these methods merely query arrays. Rather than modifying an existing array, the query methods all return a new array. The section concludes with a discussion about extending the Array class.

## Creating arrays

The Array constructor function can be used in three ways. First, if you call the constructor with no arguments, you get an empty array. You can use the `length` property of the Array class to verify that the array has no elements. For example, the following code calls the Array constructor with no arguments:

```
var names:Array = new Array();
trace(names.length); // output: 0
```

Second, if you use a number as the only parameter to the Array constructor, an array of that length is created, with each element's value set to `undefined`. The argument must be an unsigned integer between the values 0 and 4,294,967,295. For example, the following code calls the Array constructor with a single numeric argument:

```
var names:Array = new Array(3);
trace(names.length); // output: 3
trace(names[0]); // output: undefined
trace(names[1]); // output: undefined
trace(names[2]); // output: undefined
```

Third, if you call the constructor and pass a list of elements as parameters, an array is created, with elements corresponding to each of the parameters. The following code passes three arguments to the Array constructor:

```
var names:Array = new Array("John", "Jane", "David");
trace(names.length); // output: 3
trace(names[0]); // output: John
trace(names[1]); // output: Jane
trace(names[2]); // output: David
```

You can also create arrays with array literals or object literals. An array literal can be assigned directly to an array variable, as shown in the following example:

```
var names:Array = ["John", "Jane", "David"];
```

## Inserting array elements

Three of the Array class methods—`push()`, `unshift()`, and `splice()`—allow you to insert elements into an array. The `push()` method appends one or more elements to the end of an array. In other words, the last element inserted into the array using the `push()` method will have the highest index number. The `unshift()` method inserts one or more elements at the beginning of an array, which is always at index number 0. The `splice()` method will insert any number of items at a specified index in the array.

The following example demonstrates all three methods. An array named `planets` is created to store the names of the planets in order of proximity to the Sun. First, the `push()` method is called to add the initial item, Mars. Second, the `unshift()` method is called to insert the item that belongs at the front of the array, Mercury. Finally, the `splice()` method is called to insert the items Venus and Earth after Mercury, but before Mars. The first argument sent to `splice()`, the integer 1, directs the insertion to begin at index 1. The second argument sent to `splice()`, the integer 0, indicates that no items should be deleted. Finally, the third and fourth arguments sent to `splice()`, Venus and Earth, are the items to be inserted.

```
var planets:Array = new Array();
planets.push("Mars"); // array contents: Mars
planets.unshift("Mercury"); // array contents: Mercury,Mars
planets.splice(1, 0, "Venus", "Earth");
trace(planets); // array contents: Mercury,Venus,Earth,Mars
```

The `push()` and `unshift()` methods both return an unsigned integer that represents the length of the modified array. The `splice()` method returns an empty array when used to insert elements, which may seem strange, but makes more sense in light of the `splice()` method's versatility. You can use the `splice()` method not only to insert elements into an array, but also to remove elements from an array. When used to remove elements, the `splice()` method returns an array containing the elements removed.

## Removing array elements

Three methods of the `Array` class—`pop()`, `shift()`, and `splice()`—allow you to remove elements from an array. The `pop()` method removes an element from the end of the array. In other words, it removes the element at the highest index number. The `shift()` method removes an element from the beginning of the array, which means that it always removes the element at index number 0. The `splice()` method, which can also be used to insert elements, removes an arbitrary number of elements starting at the index number specified by the first argument sent to the method.

The following example uses all three methods to remove elements from an array. An array named `oceans` is created to store the names of large bodies of water. Some of the names in the array are lakes rather than oceans, so they need to be removed.

First, the `splice()` method is used to remove the items `Aral` and `Superior`, and insert the items `Atlantic` and `Indian`. The first argument sent to `splice()`, the integer `2`, indicates that the operation should start with the third item in the list, which is at index `2`. The second argument, `2`, indicates that two items should be removed. The remaining arguments, `Atlantic` and `Indian`, are values to be inserted at index `2`.

Second, the `pop()` method is used to remove last element in the array, `Huron`. And third, the `shift()` method is used to remove the first item in the array, `Victoria`.

```
var oceans:Array = ["Victoria", "Pacific", "Aral", "Superior", "Indian",
    "Huron"];
oceans.splice(2, 2, "Arctic", "Atlantic"); // replaces Aral and Superior
oceans.pop(); // removes Huron
oceans.shift(); // removes Victoria
trace(oceans); // output: Pacific,Arctic,Atlantic,Indian
```

The `pop()` and `shift()` methods both return the item that was removed. The data type of the return value is `Object` because arrays can hold values of any data type. The `splice()` method returns an array containing the values removed. You can change the `oceans` array example so that the call to `splice()` assigns the array to a new array variable, as shown in the following example:

```
var lakes:Array = oceans.splice(2, 2, "Arctic", "Atlantic");
trace(lakes); // output: Aral,Superior
```

You may come across code that uses the `delete` operator on an array element. The `delete` operator sets the value of an array element to `undefined`, but it does not remove the element from the array. For example, the following code uses the `delete` operator on the third element in the `oceans` array, but the length of the array remains 5:

```
var oceans:Array = ["Arctic", "Pacific", "Victoria", "Indian", "Atlantic"];
delete oceans[2];
trace(oceans);           // output: Arctic,Pacific,,Indian,Atlantic
trace(oceans[2]);       // output: undefined
trace(oceans.length);  // output: 5
```

You can truncate an array using an array's `length` property. If you set the `length` property of an array to a length that is less than the current length of the array, the array is truncated, removing any elements stored at index numbers higher than the new value of `length` minus 1. For example, if the `oceans` array were sorted such that all valid entries were at the beginning of the array, you could use the `length` property to remove the entries at the end of the array, as shown in the following code:

```
var oceans:Array = ["Arctic", "Pacific", "Victoria", "Aral", "Superior"];
oceans.length = 2;
trace(oceans); // output: Arctic,Pacific
```

## Sorting an array

There are three methods—`reverse()`, `sort()`, and `sortOn()`—that allow you to change the order of an array, either by sorting or reversing the order. All of these methods modify the existing array. The `reverse()` method changes the order of the array such that the last element becomes the first element, the penultimate element becomes the second element, and so on. The `sort()` method allows you to sort an array in a variety of predefined ways, and even allows you to create custom sorting algorithms. The `sortOn()` method allows you to sort an indexed array of objects that have one or more common properties that can be used as sort keys.

The `reverse()` method takes no parameters and does not return a value, but allows you to toggle the order of your array from its current state to the reverse order. The following example reverses the order of the oceans listed in the `oceans` array:

```
var oceans:Array = ["Arctic", "Atlantic", "Indian", "Pacific"];
oceans.reverse();
trace(oceans); // output: Pacific,Indian,Atlantic,Arctic
```

The `sort()` method rearranges the elements in an array using the *default sort order*. The default sort order has the following characteristics:

- The sort is case-sensitive, which means that uppercase characters precede lowercase characters. For example, the letter D precedes the letter b.
- The sort is ascending, which means that lower character codes (such as A) precede higher character codes (such as B).
- The sort places identical values adjacent to each other but in no particular order.
- The sort is string-based, which means that elements are converted to strings before they are compared (for example, 10 precedes 3 because the string "1" has a lower character code than the string "3" has).

You may find that you need to sort your array without regard to case, or in descending order, or perhaps your array contains numbers that you want to sort numerically instead of alphabetically. The `sort()` method has an `options` parameter that allows you to alter each characteristic of the default sort order. The options are defined by a set of static constants in the `Array` class, as shown in the following list:

- `Array.CASEINSENSITIVE`: This option makes the sort disregard case. For example, the lowercase letter b precedes the uppercase letter D.
- `Array.DESENDING`: This reverses the default ascending sort. For example, the letter B precedes the letter A.
- `Array.UNIQUESORT`: This causes the sort to abort if two identical values are found.
- `Array.NUMERIC`: This causes numerical sorting, so that 3 precedes 10.

The following example highlights some of these options. An array named `poets` is created that is sorted using several different options.

```
var poets:Array = ["Blake", "cumings", "Angelou", "Dante"];
poets.sort(); // default sort
trace(poets); // output: Angelou,Blake,Dante,cummings

poets.sort(Array.CASEINSENSITIVE);
trace(poets); // output: Angelou,Blake,cummings,Dante

poets.sort(Array.DESENDING);
trace(poets); // output: cumings,Dante,Blake,Angelou

poets.sort(Array.DESENDING | Array.CASEINSENSITIVE); // use two options
trace(poets); // output: Dante,cummings,Blake,Angelou
```

You can also write your own custom sort function, which you can pass as a parameter to the `sort()` method. For example, if you have a list of names in which each list element contains a person's full name, but you want to sort the list by last name, you must use a custom sort function to parse each element and use the last name in the sort function. The following code shows how this can be done with a custom function that is used as a parameter to the `Array.sort()` method:

```
var names:Array = new Array("John Q. Smith", "Jane Doe", "Mike Jones");
function orderLastName(a, b):int
{
    var lastName:RegExp = /\b\S+$/;
    var name1 = a.match(lastName);
    var name2 = b.match(lastName);
    if (name1 < name2)
    {
        return -1;
    }
    else if (name1 > name2)
    {
        return 1;
    }
    else
    {
        return 0;
    }
}

trace(names); // output: John Q. Smith,Jane Doe,Mike Jones
names.sort(orderLastName);
trace(names); // output: Jane Doe,Mike Jones,John Q. Smith
```

The custom sort function `orderLastName()` uses a regular expression to extract the last name from each element to use for the comparison operation. The function identifier `orderLastName` is used as the sole parameter when calling the `sort()` method on the `names` array. The sort function accepts two parameters, `a` and `b`, because it works on two array elements at a time. The sort function's return value indicates how the elements should be sorted:

- A return value of `-1` indicates that the first parameter, `a`, precedes the second parameter, `b`.
- A return value of `1` indicates that the second parameter, `b`, precedes the first, `a`.
- A return value of `0` indicates that the elements have equal sorting precedence.

The `sortOn()` method is designed for indexed arrays with elements that contain objects. These objects are expected to have at least one common property that can be used as the sort key. The use of the `sortOn()` method for arrays of any other type yields unexpected results. The following example revises the `poets` array so that each element is an object instead of a string. Each object holds both the poet's last name and year of birth.

```

var poets:Array = new Array();
poets.push({name:"Angelou", born:"1928"});
poets.push({name:"Blake", born:"1757"});
poets.push({name:"cumings", born:"1894"});
poets.push({name:"Dante", born:"1265"});
poets.push({name:"Wang", born:"701"});

```

You can use the `sortOn()` method to sort the array by the `born` property. The `sortOn()` method defines two parameters, `fieldName` and `options`. The `fieldName` argument must be specified as a string. In the following example, `sortOn()` is called with two arguments, `"born"` and `Array.NUMERIC`. The `Array.NUMERIC` argument is used to ensure that the sort is done numerically instead of alphabetically. This is a good practice even when all the numbers have the same number of digits because it ensures that the sort will continue to behave as expected if a number with fewer or more digits is later added to the array.

```

poets.sortOn("born", Array.NUMERIC);
for (var i:int = 0; i < poets.length; ++i)
{
    trace(poets[i].name, poets[i].born);
}
/* output:
Wang 701
Dante 1265
Blake 1757
cumings 1894
Angelou 1928
*/

```

Generally, the `sort()` and `sortOn()` methods modify an array. If you wish to sort an array without modifying the existing array, pass the `Array.RETURNINDEXEDARRAY` constant as part of the `options` parameter. This option directs the methods to return a new array that reflects the sort and to leave the original array unmodified. The array returned by the methods is a simple array of index numbers that reflects the new sort order and does not contain any elements from the original array. For example, to sort the `poets` array by birth year without modifying the array, include the `Array.RETURNINDEXEDARRAY` constant as part of the argument passed for the `options` parameter.

The following example stores the returned index information in an array named `indices` and uses the `indices` array in conjunction with the unmodified `poets` array to output the poets in order of birth year:

```

var indices:Array;
indices = poets.sortOn("born", Array.NUMERIC | Array.RETURNINDEXEDARRAY);
for (var i:int = 0; i < indices.length; ++i)
{
    var index:int = indices[i];
    trace(poets[index].name, poets[index].born);
}

```



```
/* output:  
Wang 701  
Dante 1265  
Blake 1757  
cummings 1894  
Angelou 1928  
*/
```

## Querying an array

The remaining four methods of the `Array` class—`concat()`, `join()`, `slice()`, `toString()`—all query the array for information, but do not modify the array. The `concat()` and `slice()` methods both return new arrays, while the `join()` and `toString()` methods both return strings. The `concat()` method takes a new array or list of elements as arguments and combines it with the existing array to create a new array. The `slice()` method has two parameters, aptly named `startIndex` and an `endIndex`, and returns a new array containing a copy of the elements “sliced” from the existing array. The slice begins with the element at `startIndex` and ends with the element just before `endIndex`. That bears repeating: the element at `endIndex` is not included in the return value.

The following example uses `concat()` and `slice()` to create new arrays using elements of other arrays:

```
var array1:Array = ["alpha", "beta"];  
var array2:Array = array1.concat("gamma", "delta");  
trace(array2); // output: alpha,beta,gamma,delta  
  
var array3:Array = array1.concat(array2);  

```

You can use the `join()` and `toString()` methods to query the array and return its contents as a string. If no parameters are used for the `join()` method, the two methods behave identically—they return a string containing a comma-delimited list of all elements in the array. The `join()` method, unlike the `toString()` method, accepts a parameter named `delimiter`, which allows you to choose the symbol to use as a separator between each element in the returned string.

The following example creates an array called `rivers` and calls both `join()` and `toString()` to return the values in the array as a string. The `toString()` method is used to return comma-separated values (`riverCSV`), while the `join()` method is used to return values separated by the `+` character.

```
var rivers:Array = ["Nile", "Amazon", "Yangtze", "Mississippi"];
var riverCSV:String = rivers.toString();
trace(riverCSV); // output: Nile,Amazon,Yangtze,Mississippi
var riverPSV:String = rivers.join("+");
trace(riverPSV); // output: Nile+Amazon+Yangtze+Mississippi
```

One issue to be aware of with the `join()` method is that any nested arrays are always returned with comma-separated values, no matter what separator you specify for the main array elements, as the following example shows:

```
var nested:Array = ["b","c","d"];
var letters:Array = ["a",nested,"e"];
var joined:String = letters.join("+");
trace(joined); // output: a+b,c,d+e
```

## Associative arrays

An associative array, sometimes called a *hash* or *map*, uses *keys* instead of a numeric index to organize stored values. Each key in an associative array is a unique string that is used to access a stored value. An associative array is an instance of the `Object` class, which means that each key corresponds to a property name. Associative arrays are unordered collections of key and value pairs. Your code should not expect the keys of an associative array to be in a specific order.

ActionScript 3.0 introduces an advanced type of associative array called a *dictionary*. Dictionaries, which are instances of the `Dictionary` class in the `flash.utils` package, use keys that can be of any data type but are usually instances of the `Object` class. In other words, dictionary keys are not limited to values of type `String`.

This section describes how to create associative arrays that use strings for keys and how to use the `Dictionary` class.

### Associative arrays with string keys

There are two ways to create associative arrays in ActionScript 3.0. The first way is to use the `Object` constructor, which has the advantage of allowing you to initialize your array with an object literal. An instance of the `Object` class, also called a *generic object*, is functionally identical to an associative array. Each property name of the generic object serves as the key that provides access to a stored value.

The following example creates an associative array named `monitorInfo`, using an object literal to initialize the array with two key and value pairs:

```
var monitorInfo:Object = {type:"Flat Panel", resolution:"1600 x 1200"};
trace(monitorInfo["type"], monitorInfo["resolution"]);
// output: Flat Panel 1600 x 1200
```

If you do not need to initialize the array at declaration time, you can use the `Object` constructor to create the array, as follows:

```
var monitorInfo:Object = new Object();
```

After the array is created using either an object literal or the `Object` class constructor, you can add new values to the array using either the bracket operator (`[]`) or the dot operator (`.`). The following example adds two new values to `monitorArray`:

```
monitorInfo["aspect ratio"] = "16:10"; // bad form, do not use spaces
monitorInfo.colors = "16.7 million";
trace(monitorInfo["aspect ratio"], monitorInfo.colors);
// output: 16:10 16.7 million
```

Note that the key named `aspect ratio` contains a space character. This is possible with the bracket operator, but generates an error if attempted with the dot operator. Using spaces in your key names is not recommended.

The second way to create an associative array is to use the `Array` constructor (or the constructor of any dynamic class) and then use either the bracket operator (`[]`) or the dot operator (`.`) to add key and value pairs to the array. If you declare your associative array to be of type `Array`, you cannot use an object literal to initialize the array. The following example creates an associative array named `monitorInfo` using the `Array` constructor and adds a key called `type` and a key called `resolution`, along with their values:

```
var monitorInfo:Array = new Array();
monitorInfo["type"] = "Flat Panel";
monitorInfo["resolution"] = "1600 x 1200";
trace(monitorInfo["type"], monitorInfo["resolution"]);
// output: Flat Panel 1600 x 1200
```

There is no advantage in using the `Array` constructor to create an associative array. You cannot use the `Array.length` property or any of the methods of the `Array` class with associative arrays, even if you use the `Array` constructor or the `Array` data type. The use of the `Array` constructor is best left for the creation of indexed arrays.

## Associative arrays with object keys

You can use the Dictionary class to create an associative array that uses objects for keys rather than strings. Such arrays are sometimes called dictionaries, hashes, or maps. For example, consider an application that determines the location of a Sprite object based on its association with a specific container. You can use a Dictionary object to map each Sprite object to a container.

The following code creates three instances of the Sprite class that serve as keys for the Dictionary object. Each key is assigned a value of either GroupA or GroupB. The values can be of any data type, but in this example both GroupA and GroupB are instances of the Object class. Subsequently, you can access the value associated with each key with the property access ([ ]) operator, as shown in the following code:

```
import flash.display.Sprite;
import flash.utils.Dictionary;

var groupMap:Dictionary = new Dictionary();

// objects to use as keys
var spr1:Sprite = new Sprite();
var spr2:Sprite = new Sprite();
var spr3:Sprite = new Sprite();

// objects to use as values
var groupA:Object = new Object();
var groupB:Object = new Object();

// Create new key-value pairs in dictionary.
groupMap[spr1] = groupA;
groupMap[spr2] = groupB;
groupMap[spr3] = groupB;

if (groupMap[spr1] == groupA)
{
    trace("spr1 is in groupA");
}
if (groupMap[spr2] == groupB)
{
    trace("spr2 is in groupB");
}
if (groupMap[spr3] == groupB)
{
    trace("spr3 is in groupB");
}
```

## Iterating with object keys

You can iterate through the contents of a Dictionary object with either a `for..in` loop or a `for each..in` loop. A `for..in` loop allows you to iterate based on the keys, whereas a `for each..in` loop allows you to iterate based on the values associated with each key.

Use the `for..in` loop for direct access to the object keys of a Dictionary object. You can also access the values of the Dictionary object with the property access (`[]`) operator. The following code uses the previous example of the `groupMap` dictionary to show how to iterate through a Dictionary object with the `for..in` loop:

```
for (var key:Object in groupMap)
{
    trace(key, groupMap[key]);
}
/* output:
[object Sprite] [object Object]
[object Sprite] [object Object]
[object Sprite] [object Object]
*/
```

Use the `for each..in` loop for direct access to the values of a Dictionary object. The following code also uses the `groupMap` dictionary to show how to iterate through a Dictionary object with the `for each..in` loop:

```
for each (var item:Object in groupMap)
{
    trace(item);
}
/* output:
[object Object]
[object Object]
[object Object]
*/
```

## Object keys and memory management

Adobe Flash Player uses a garbage collection system to recover memory that is no longer used. When an object has no references pointing to it, the object becomes eligible for garbage collection, and the memory is recovered the next time the garbage collection system executes. For example, the following code creates a new object and assigns a reference to the object to the variable `myObject`:

```
var myObject:Object = new Object();
```

As long as any reference to the object exists, the garbage collection system will not recover the memory that the object occupies. If the value of `myObject` is changed such that it points to a different object or is set to the value `null`, the memory occupied by the original object becomes eligible for garbage collection, but only if there are no other references to the original object.

If you use `myObject` as a key in a Dictionary object, you are creating another reference to the original object. For example, the following code creates two references to an object—the `myObject` variable, and the key in the `myMap` object:

```
import flash.utils.Dictionary;

var myObject:Object = new Object();
var myMap:Dictionary = new Dictionary();
myMap[myObject] = "foo";
```

To make the object referenced by `myObject` eligible for garbage collection, you must remove all references to it. In this case, you must change the value of `myObject` and delete the `myObject` key from `myMap`, as shown in the following code:

```
myObject = null;
delete myMap[myObject];
```

Alternatively, you can use the `useWeakReference` parameter of the Dictionary constructor to make all of the dictionary keys *weak references*. The garbage collection system ignores weak references, which means that an object that has only weak references is eligible for garbage collection. For example, in the following code, you do not need to delete the `myObject` key from `myMap` in order to make the object eligible for garbage collection:

```
import flash.utils.Dictionary;

var myObject:Object = new Object();
var myMap:Dictionary = new Dictionary(true);
myMap[myObject] = "foo";
myObject = null; // Make object eligible for garbage collection.
```

# Multidimensional arrays

Multidimensional arrays contain other arrays as elements. For example, consider a list of tasks that is stored as an indexed array of strings:

```
var tasks:Array = ["wash dishes", "take out trash"];
```

If you want to store a separate list of tasks for each day of the week, you can create a multidimensional array with one element for each day of the week. Each element contains an indexed array, similar to the `tasks` array, that stores the list of tasks. You can use any combination of indexed or associative arrays in multidimensional arrays. The examples in the following sections use either two indexed arrays or an associative array of indexed arrays. You might want to try the other combinations as exercises.

## Two indexed arrays

When you use two indexed arrays, you can visualize the result as a table or spreadsheet. The elements of the first array represent the rows of the table, while the elements of the second array represent the columns.

For example, the following multidimensional array uses two indexed arrays to track task lists for each day of the week. The first array, `masterTaskList`, is created using the `Array` class constructor. Each element of the array represents a day of the week, with index 0 representing Monday, and index 6 representing Sunday. These elements can be thought of as the rows in the table. You can create each day's task list by assigning an array literal to each of the seven elements that you create in the `masterTaskList` array. The array literals represent the columns in the table.

```
var masterTaskList:Array = new Array();
masterTaskList[0] = ["wash dishes", "take out trash"];
masterTaskList[1] = ["wash dishes", "pay bills"];
masterTaskList[2] = ["wash dishes", "dentist", "wash dog"];
masterTaskList[3] = ["wash dishes"];
masterTaskList[4] = ["wash dishes", "clean house"];
masterTaskList[5] = ["wash dishes", "wash car", "pay rent"];
masterTaskList[6] = ["mow lawn", "fix chair"];
```

You can access individual items on any of the task lists using bracket notation. The first set of brackets represents the day of the week, and the second set of brackets represents the task list for that day. For example, to retrieve the second task from Wednesday's list, first use index 2 for Wednesday, and then use index 1 for the second task in the list.

```
trace(masterTaskList[2][1]); // output: dentist
```

To retrieve the first task from Sunday's list, use index 6 for Sunday and index 0 for the first task on the list.

```
trace(masterTaskList[6][0]); // output: mow lawn
```

## Associative array with an indexed array

To make the individual arrays easier to access, you can use an associative array for the days of the week and an indexed array for the task lists. Using an associative array allows you to use dot syntax when referring to a particular day of the week, but at the cost of extra run-time processing to access each element of the associative array. The following example uses an associative array as the basis of a task list, with a key and value pair for each day of the week:

```
var masterTaskList:Object = new Object();
masterTaskList["Monday"] = ["wash dishes", "take out trash"];
masterTaskList["Tuesday"] = ["wash dishes", "pay bills"];
masterTaskList["Wednesday"] = ["wash dishes", "dentist", "wash dog"];
masterTaskList["Thursday"] = ["wash dishes"];
masterTaskList["Friday"] = ["wash dishes", "clean house"];
masterTaskList["Saturday"] = ["wash dishes", "wash car", "pay rent"];
masterTaskList["Sunday"] = ["mow lawn", "fix chair"];
```

Dot syntax makes the code more readable by making it possible to avoid multiple sets of brackets.

```
trace(masterTaskList.Wednesday[1]); // output: dentist
trace(masterTaskList.Sunday[0]);    // output: mow lawn
```

You can iterate through the task list using a `for...in` loop, but you must use bracket notation instead of dot syntax to access the value associated with each key. Because `masterTaskList` is an associative array, the elements are not necessarily retrieved in the order that you may expect, as the following example shows:

```
for (var day:String in masterTaskList)
{
    trace(day + ": " + masterTaskList[day])
}
/* output:
Sunday: mow lawn,fix chair
Wednesday: wash dishes,dentist,wash dog
Friday: wash dishes,clean house
Thursday: wash dishes
Monday: wash dishes,take out trash
Saturday: wash dishes,wash car,pay rent
Tuesday: wash dishes,pay bills
*/
```



# Cloning arrays

The Array class has no built-in method for making copies of arrays. You can create a *shallow copy* of an array by calling either the `concat()` or `slice()` methods with no arguments. In a shallow copy, if the original array has elements that are objects, only the references to the objects are copied rather than the objects themselves. The copy points to the same objects as the original does. Any changes made to the objects are reflected in both arrays.

In a *deep copy*, any objects found in the original array are also copied so that the new array does not point to the same objects as does the original array. Deep copying requires more than one line of code, which usually calls for the creation of a function. Such a function could be created as a global utility function or as a method of an Array subclass.

The following example defines a function named `clone()` that does deep copying. The algorithm is borrowed from a common Java programming technique. The function creates a deep copy by serializing the array into an instance of the `ByteArray` class, and then reading the array back into a new array. This function accepts an object so that it can be used with both indexed arrays and associative arrays, as shown in the following code:

```
import flash.utils.ByteArray;

function clone(source:Object):*
{
    var myBA:ByteArray = new ByteArray();
    myBA.writeObject(source);
    myBA.position = 0;
    return(myBA.readObject());
}
```

## Advanced topics

### Extending the Array class

The Array class is one of the few core classes that is not final, which means that you can create your own subclass of Array. This section provides an example of how to create a subclass of Array and discusses some of the issues that can arise during the process.

As mentioned previously, arrays in ActionScript are not typed, but you can create a subclass of Array that accepts elements of only a specific data type. The example in the following sections defines an Array subclass named TypedArray that limits its elements to values of the data type specified in the first parameter. The TypedArray class is presented merely as an example of how to extend the Array class and may not be suitable for production purposes for several reasons. First, type checking occurs at run time rather than at compile time. Second, when a TypedArray method encounters a mismatch, the mismatch is ignored and no exception is thrown, although the methods can be easily modified to throw exceptions. Third, the class cannot prevent the use of the array access operator to insert values of any type into the array. Fourth, the coding style favors simplicity over performance optimization.

## Declaring the subclass

Use the `extends` keyword to indicate that a class is a subclass of Array. A subclass of Array should use the `dynamic` attribute, just as the Array class does. Otherwise, your subclass will not function properly.

The following code shows the definition of the TypedArray class, which contains a constant to hold the data type, a constructor method, and the four methods that are capable of adding elements to the array. The code for each method is omitted in this example, but is delineated and explained fully in the sections that follow:

```
public dynamic class TypedArray extends Array
{
    private const dataType:Class;

    public function TypedArray(...args) {}

    AS3 override function concat(...args):Array {}

    AS3 override function push(...args):uint {}

    AS3 override function splice(...args) {}

    AS3 override function unshift(...args):uint {}
}
```

The four overridden methods all use the AS3 namespace instead of the `public` attribute because this example assumes that the compiler option `-as3` is set to `true` and the compiler option `-es` is set to `false`. These are the default settings for Adobe Flex Builder 2 and for Adobe Flash CS3 Professional. For more information, see [“The AS3 namespace” on page 179](#).

**TIP**

If you are an advanced developer who prefers to use prototype inheritance, you can make two minor changes to the `TypedArray` class to make it compile with the compiler option `-es` set to `true`. First, remove all occurrences of the `override` attribute and replace the AS3 namespace with the `public` attribute. Second, substitute `Array.prototype` for all four occurrences of `super`.

## TypedArray constructor

The subclass constructor poses an interesting challenge because the constructor must accept a list of arguments of arbitrary length. The challenge is how to pass the arguments on to the superconstructor to create the array. If you pass the list of arguments as an array, the superconstructor considers it a single argument of type `Array` and the resulting array is always 1 element long. The traditional way to handle pass-through argument lists is to use the `Function.apply()` method, which takes an array of arguments as its second parameter but converts it to a list of arguments when executing the function. Unfortunately, the `Function.apply()` method cannot be used with constructors.

The only option left is to recreate the logic of the `Array` constructor in the `TypedArray` constructor. The following code shows the algorithm used in the `Array` class constructor, which you can reuse in your `Array` subclass constructor:

```
public dynamic class Array
{
    public function Array(...args)
    {
        var n:uint = args.length
        if (n == 1 && (args[0] is Number))
        {
            var dlen:Number = args[0];
            var ulen:uint = dlen;
            if (ulen != dlen)
            {
                throw new RangeError("Array index is not a 32-bit unsigned integer
("+dlen+)");
            }
            length = ulen;
        }
        else
        {
            length = n;
            for (var i:int=0; i < n; i++)
```

```

        {
            this[i] = args[i]
        }
    }
}

```

The `TypedArray` constructor shares most of the code from the `Array` constructor, with only four changes to the code. First, the parameter list includes a new required parameter of type `Class` that allows specification of the array's data type. Second, the data type passed to the constructor is assigned to the `dataType` variable. Third, in the `else` statement, the value of the `length` property is assigned after the `for` loop so that `length` includes only arguments that are the proper type. Fourth, the body of the `for` loop uses the overridden version of the `push()` method so that only arguments of the correct data type are added to the array. The following example shows the `TypedArray` constructor function:

```

public dynamic class TypedArray extends Array
{
    private var dataType:Class;
    public function TypedArray(typeParam:Class, ...args)
    {
        dataType = typeParam;
        var n:uint = args.length
        if (n == 1 && (args[0] is Number))
        {
            var dlen:Number = args[0];
            var ulen:uint = dlen
            if (ulen != dlen)
            {
                throw new RangeError("Array index is not a 32-bit unsigned integer
("+dlen+")")
            }
            length = ulen;
        }
        else
        {
            for (var i:int=0; i < n; i++)
            {
                // type check done in push()
                this.push(args[i])
            }
            length = this.length;
        }
    }
}

```

## TypedArray overridden methods

The `TypedArray` class overrides the four methods of the `Array` class that are capable of adding elements to an array. In each case, the overridden method adds a type check that prevents the addition of elements that are not the correct data type. Subsequently, each method calls the superclass version of itself.

The `push()` method iterates through the list of arguments with a `for...in` loop and does a type check on each argument. Any argument that is not the correct type is removed from the `args` array with the `splice()` method. After the `for...in` loop ends, the `args` array contains values only of type `dataType`. The superclass version of `push()` is then called with the updated `args` array, as the following code shows:

```
AS3 override function push(...args):uint
{
    for (var i:* in args)
    {
        if (!(args[i] is dataType))
        {
            args.splice(i,1);
        }
    }
    return (super.push.apply(this, args));
}
```

The `concat()` method creates a temporary `TypedArray` named `passArgs` to store the arguments that pass the type check. This allows the reuse of the type check code that exists in the `push()` method. A `for...in` loop iterates through the `args` array, and calls `push()` on each argument. Because `passArgs` is typed as `TypedArray`, the `TypedArray` version of `push()` is executed. The `concat()` method then calls its own superclass version, as the following code shows:

```
AS3 override function concat(...args):Array
{
    var passArgs:TypedArray = new TypedArray(dataType);
    for (var i:* in args)
    {
        // type check done in push()
        passArgs.push(args[i]);
    }
    return (super.concat.apply(this, passArgs));
}
```

The `splice()` method takes an arbitrary list of arguments, but the first two arguments always refer to an index number and the number of elements to delete. This is why the overridden `splice()` method does type checking only for `args` array elements in index positions 2 or higher. One point of interest in the code is that there appears to be a recursive call to `splice()` inside the `for` loop, but this is not a recursive call because `args` is of type `Array` rather than `TypedArray`, which means that the call to `args.splice()` is a call to the superclass version of the method. After the `for..in` loop concludes, the `args` array contains only values of the correct type in index positions 2 or higher, and `splice()` calls its own superclass version, as shown in the following code:

```
AS3 override function splice(...args):*
{
    if (args.length > 2)
    {
        for (var i:int=2; i< args.length; i++)
        {
            if (!(args[i] is dataType))
            {
                args.splice(i,1);
            }
        }
    }
    return (super.splice.apply(this, args));
}
```

The `unshift()` method, which adds elements to the beginning of an array, also accepts an arbitrary list of arguments. The overridden `unshift()` method uses an algorithm very similar to that used by the `push()` method, as shown in the following example code:

```
AS3 override function unshift(...args):uint
{
    for (var i:* in args)
    {
        if (!(args[i] is dataType))
        {
            args.splice(i,1);
        }
    }
    return (super.unshift.apply(this, args));
}
```

# Example: PlayList

The PlayList example demonstrates techniques for working with arrays, in the context of a music playlist application that manages a list of songs. These techniques are:

- Creating an indexed array
- Adding items to an indexed array
- Sorting an array of objects by different properties, using different sorting options
- Converting an array to a character-delimited string

To get the application files for this sample, see [www.adobe.com/go/learn\\_programmingAS3samples\\_flash](http://www.adobe.com/go/learn_programmingAS3samples_flash). The PlayList application files can be found in the Samples/PlayList folder. The application consists of the following files:

File	Description
PlayList.mxml or PlayList.fla	The main application file in Flash (FLA) or Flex (MXML).
com/example/programmingas3/playlist/ Song.as	A value object representing information about a single song. The items that are managed by the PlayList class are Song instances.
com/example/programmingas3/playlist/ SortProperty.as	A pseudo-enumeration whose available values represent the properties of the Song class by which a list of Song objects can be sorted.

## PlayList class overview

The PlayList class manages a set of Song objects. It has public methods with functionality for adding a song to the playlist (the `addSong()` method) and sorting the songs in the list (the `sortList()` method). In addition, the class includes a read-only accessor property, `songList`, which provides access to the actual set of songs in the playlist. Internally, the PlayList class keeps track of its songs using a private Array variable:

```
public class PlayList
{
    private var _songs:Array;
    private var _currentSort:SortProperty = null;
    private var _needToSort:Boolean = false;
    ...
}
```

In addition to the `_songs` Array variable, which is used by the `PlayList` class to keep track of its list of songs, two other private variables keep track of whether the list needs to be sorted (`_needToSort`) and which property the song list is sorted by at a given time (`_currentSort`). As with all objects, declaring an Array instance is only half the job of creating an Array. Before accessing an Array instance's properties or methods, it must be instantiated, which is done in the `PlayList` class's constructor.

```
public function PlayList()
{
    this._songs = new Array();
    // Set the initial sorting.
    this.sortList(SortProperty.TITLE);
}
```

The first line of the constructor instantiates the `_songs` variable, so that it is ready to be used. In addition, the `sortList()` method is called to set the initial sort-by property.

## Adding a song to the list

When a user enters a new song into the application, the code in the data entry form calls the `PlayList` class's `addSong()` method.

```
/**
 * Adds a song to the playlist.
 */
public function addSong(song:Song):void
{
    this._songs.push(song);
    this._needToSort = true;
}
```

Inside `addSong()`, the `_songs` array's `push()` method is called, adding the `Song` object that was passed to `addSong()` as a new element in that array. With the `push()` method, the new element is added to the end of the array, regardless of any sorting that might have been applied previously. This means that after the `push()` method has been called, the list of songs is likely to no longer be sorted correctly, so the `_needToSort` variable is set to `true`. In theory, the `sortList()` method could be called immediately, removing the need to keep track of whether the list is sorted or not at a given time. In practice, however, there is no need for the list of songs to be sorted until immediately before it is retrieved. By deferring the sorting operation, the application doesn't perform sorting that is unnecessary if, for example, several songs are added to the list before it is retrieved.



## Sorting the list of songs

Because the Song instances that are managed by the playlist are complex objects, users of the application may wish to sort the playlist according to different properties, such as song title or year of publication. In the PlayList application, the task of sorting the list of songs has three parts: identifying the property by which the list should be sorted, indicating what sorting options need to be used when sorting by that property, and performing the actual sort operation.

### Properties for sorting

A Song object keeps track of several properties, including song title, artist, publication year, filename, and a user-selected set of genres in which the song belongs. Of these, only the first three are practical for sorting. As a matter of convenience for developers, the example includes the SortProperty class, which acts as an enumeration with values representing the properties available for sorting.

```
public static const TITLE:SortProperty = new SortProperty("title");
public static const ARTIST:SortProperty = new SortProperty("artist");
public static const YEAR:SortProperty = new SortProperty("year");
```

The SortProperty class contains three constants, TITLE, ARTIST, and YEAR, each of which stores a String containing the actual name of the associated Song class property that can be used for sorting. Throughout the rest of the code, whenever a sort property is indicated, it is done using the enumeration member. For instance, in the PlayList constructor, the list is sorted initially by calling the sortList() method, as follows:

```
// Set the initial sorting.
this.sortList(SortProperty.TITLE);
```

Because the property for sorting is specified as SortProperty.TITLE, the songs are sorted according to their title.

## Sorting by property and specifying sort options

The work of actually sorting the list of songs is performed by the `Playlist` class in the `sortList()` method, as follows:

```
/**
 * Sorts the list of songs according to the specified property.
 */
public function sortList(sortProperty:SortProperty):void
{
    ...
    var sortOptions:uint;
    switch (sortProperty)
    {
        case SortProperty.TITLE:
            sortOptions = Array.CASEINSENSITIVE;
            break;
        case SortProperty.ARTIST:
            sortOptions = Array.CASEINSENSITIVE;
            break;
        case SortProperty.YEAR:
            sortOptions = Array.NUMERIC;
            break;
    }

    // Perform the actual sorting of the data.
    this._songs.sortOn(sortProperty.propertyName, sortOptions);

    // Save the current sort property.
    this._currentSort = sortProperty;

    // Record that the list is sorted.
    this._needToSort = false;
}
```

When sorting by title or artist, it makes sense to sort alphabetically, but when sorting by year, it's most logical to perform a numeric sort. The `switch` statement is used to define the appropriate sorting option, stored in the variable `sortOptions`, according to the value specified in the `sortProperty` parameter. Here again the named enumeration members are used to distinguish between properties, rather than hard-coded values.

With the sort property and sort options determined, the `_songs` array is actually sorted by calling its `sortOn()` method, passing those two values as parameters. The current sort property is recorded, as is the fact that the song list is currently sorted.

## Combining array elements into a character-delimited string

In addition to using an array to maintain the song list in the `PlayList` class, in this example arrays are also used in the `Song` class to help manage the list of genres to which a given song belongs. Consider this snippet from the `Song` class's definition:

```
private var _genres:String;

public function Song(title:String, artist:String, year:uint,
    filename:String, genres:Array)
{
    ...
    // Genres are passed in as an array
    // but stored as a semicolon-separated string.
    this._genres = genres.join(";");
}
```

When creating a new `Song` instance, the `genres` parameter that is used to specify the genre (or genres) the song belongs to is defined as an `Array` instance. This makes it convenient to group multiple genres together into a single variable that can be passed to the constructor. However, internally the `Song` class maintains the genres in the private `_genres` variable as a semicolon-separated `String` instance. The `Array` parameter is converted into a semicolon-separated string by calling its `join()` method with the literal string value  `";"` as the specified delimiter.

By the same token, the `genres` accessors allow genres to be set or retrieved as an `Array`:

```
public function get genres():Array
{
    // Genres are stored as a semicolon-separated String,
    // so they need to be transformed into an Array to pass them back out.
    return this._genres.split(";");
}

public function set genres(value:Array):void
{
    // Genres are passed in as an array,
    // but stored as a semicolon-separated string.
    this._genres = value.join(";");
}
```

The `genres` set accessor behaves exactly the same as the constructor; it accepts an `Array` and calls the `join()` method to convert it to a semicolon-separated `String`. The `get` accessor performs the opposite operation: the `_genres` variable's `split()` method is called, splitting the `String` into an array of values using the specified delimiter (the literal string value  `";"` as before).



To “handle” an error means you build logic into your application that responds to, or fixes, an error, generated either when an application is compiled or when a compiled application is running. When your application handles errors, *something* occurs as a response when the error is encountered, as opposed to no response and whatever process created the error failing silently. Used correctly, error handling helps shield your application and its users from otherwise unexpected behavior.

However, error handling is a broad category that includes responding to many kinds of errors that are thrown during compilation or at run time. This chapter focuses on how to handle run-time errors, the different types of errors that can be generated, and the advantages of the new error-handling system in ActionScript 3.0. This chapter also explains how to implement your own custom error-handling strategies for your applications.

## Contents

Basics of error handling .....	254
Types of errors .....	257
Error handling in ActionScript 3.0 .....	259
Working with the debugger version of Flash Player .....	261
Handling synchronous errors in an application .....	262
Creating custom error classes .....	267
Responding to error events and status .....	268
Comparing the Error classes .....	272
Example: CustomErrors application .....	278

# Basics of error handling

## Introduction to error handling

A run-time error is something that goes wrong in your ActionScript code that stops the ActionScript content from running in Adobe Flash Player. To ensure that your ActionScript code runs smoothly for users, you must write code in your application that handles the error—that fixes it, works around it, or at least lets the user know that it’s happened. This process is called *error handling*.

Error handling is a broad category that includes responding to many kinds of errors that are thrown during compilation or at run time. Errors that happen at compile time are often easier to identify—you must fix them in order to complete the process of creating a SWF file. This chapter doesn’t discuss compile-time errors; for more information on writing code that doesn’t contain compile-time errors, see [Chapter 3, “ActionScript language and syntax,” on page 67](#) and [Chapter 4, “Object-oriented programming in ActionScript,” on page 137](#). This chapter focuses on run-time errors.

Run-time errors can be more difficult to detect, because in order for them to occur the erroneous code must actually be run. If a segment of your program has several branches of code, like an `if...then...else` statement, you must test every possible condition, with all the possible input values that real users might use, in order to confirm that your code is error-free.

Run-time errors can be divided into two categories: *program errors* are mistakes in your ActionScript code, such as specifying the wrong data type for a method parameter; *logical errors* are mistakes in the logic (the data checking and value manipulation) of your program, such as using the wrong formula to calculate interest rates in a banking application. Again, both of these types of errors can often be detected and corrected ahead of time by diligently testing your application.

Ideally, you’ll want to identify and remove all errors from your application before it is released to end users. However, not all errors can be foreseen or prevented. For example, suppose your ActionScript application loads information from a particular website that is outside of your control. If at some point that website isn’t available, the part of your application that depends on that external data won’t behave correctly. The most important aspect of error handling involves preparing for these unknown cases and handling them gracefully so that users can continue to use your application, or at least get a friendly error message explaining why it isn’t working.

Run-time errors are represented in two ways in ActionScript:

- **Error classes:** Many errors have an error class associated with them. When an error occurs, Flash Player creates an instance of the specific error class that is associated with that particular error. Your code can use the information contained in that error object to make an appropriate response to the error.
- **Error events:** Sometimes an error occurs when Flash Player would normally trigger an event. In those cases, Flash Player triggers an error event instead. Like other events, each error event has a class associated with it, and Flash Player passes an instance of that class to the methods that are subscribed to the error event.

To determine whether a particular method can trigger an error or error event, see the method's entry in the *ActionScript 3.0 Language and Components Reference*.

## Common error-handling tasks

These are common error-related tasks you might need to perform with your code:

- Writing code to handle errors
- Testing for, catching, and re-throwing errors
- Defining your own error class
- Responding to error and status events

## Important concepts and terms

The following reference list contains important terms that you will encounter in this chapter:

- **Asynchronous:** A program command such as a method call that doesn't provide an immediate result; instead it gives a result (or error) in the form of an event.
- **Catch:** When an exception (a run-time error) occurs and your code becomes aware of the exception, that code is said to *catch* the exception. Once an exception is caught, Flash Player stops notifying other ActionScript code of the exception.
- **Debugger version:** A special version of Flash Player that contains code for notifying users of run-time errors. In the standard version of Flash Player (the one that most users have), errors that aren't handled by your ActionScript code are ignored by Flash Player. In the debugger version (which is included with Adobe Flash CS3 Professional and Adobe Flex), a warning message appears when an unhandled error happens.
- **Exception:** An error that happens while a program is running and that the run-time environment (that is, Flash Player) can't resolve on its own.

- **Re-throw:** When your code catches an exception, Flash Player no longer notifies other objects of the exception. If it's important for other objects to be notified of the exception, your code must *re-throw* the exception to start the notification process again.
- **Synchronous:** A program command, such as a method call, that provides an immediate result (or immediately throws an error), meaning the response can be used within the same code block.
- **Throw:** The act of notifying Flash Player (and consequently, notifying other objects and ActionScript code) that an error has occurred is known as *throwing* an error.

## Working through in-chapter examples

As you're working through the chapter, you may want to test some of the example code listings for yourself. Essentially all the code listings in this chapter include the appropriate `trace()` function call. To test the code listings in this chapter:

1. Create an empty Flash document.
2. Select a keyframe in the timeline.
3. Open the Actions panel and copy the code listing into the Script pane.
4. Run the program using Control > Test Movie.

You will see the results of the code listing's `trace()` functions in the Output panel.

Some of the later code listings are more complex and are written as a class. To test these examples:

1. Create an empty Flash document and save it to your computer.
2. Create a new ActionScript file and save it in the same directory as the Flash document. The file's name should match the name of the class in the code listing. For instance, if the code listing defines a class named `ErrorTest`, use the name `ErrorTest.as` to save the ActionScript file.
3. Copy the code listing into the ActionScript file and save the file.
4. In the Flash document, click a blank part of the Stage or work space to activate the document Property inspector.
5. In the Property inspector, in the Document Class field, enter the name of the ActionScript class you copied from the text.
6. Run the program using Control > Test Movie

You will see the results of the example in the Output panel (if the example uses the `trace()` function) or in a text field created by the example code.



These techniques for testing example code listings are described in more detail in [“Testing in-chapter example code listings” on page 63](#).

## Types of errors

When you develop and run applications, you encounter different types of errors and error terminology. The following list introduces the major error types and terms:

- *Compile-time errors* are raised by the ActionScript compiler during code compilation. Compile-time errors occur when syntactical problems in your code prevent your application from being built.
- *Run-time errors* occur when you run your application after you compile it. Run-time errors represent errors that are caused while a SWF file plays in Adobe Flash Player 9. In most cases, you will be able to handle run-time errors as they occur, reporting them to the user and taking steps to keep your application running. If the error is a fatal error, such as not being able to connect to a remote website or load required data, you can use error handling to allow your application to finish gracefully.
- *Synchronous errors* are run-time errors that occur at the time a function is invoked—for example, when you try to use a specific method and the argument you pass to the method is invalid, so Flash Player throws an exception. Most errors occur synchronously—at the time the statement executes—and the flow of control passes immediately to the most applicable `catch` statement.

For example, the following code excerpt throws a run-time error because the `browse()` method is not called before the program attempts to upload a file:

```
var fileRef:FileReference = new FileReference();
try
{
    fileRef.upload("http://www.yourdomain.com/fileupload.cfm");
}
catch (error:IllegalOperationError)
{
    trace(error);
    // Error #2037: Functions called in incorrect sequence, or earlier
    // call was unsuccessful.
}
```

In this case, a run-time error is thrown synchronously because Flash Player determined that the `browse()` method was not called before the file upload was attempted.

For detailed information on synchronous error handling, see [“Handling synchronous errors in an application” on page 262](#).

- *Asynchronous errors* are run-time errors that occur at various points during run time; they generate events and are caught by event listeners. An asynchronous operation is one in which a function initiates an operation, but doesn't wait for it to complete. You can create an error event listener to wait for the application or user to try some operation, and if the operation fails, you catch the error with an event listener and respond to the error event. Then, the event listener calls an event handler function to respond to the error event in a useful manner. For example, the event handler could launch a dialog box that prompts the user to resolve the error.

Consider the file-upload synchronous error example presented earlier. If you successfully call the `browse()` method before beginning a file upload, Flash Player would dispatch several events. For example, when an upload starts, the `open` event is dispatched. When the file upload operation completes successfully, the `complete` event is dispatched. Because event handling is asynchronous (that is, it does not occur at specific, known, predesignated times), you need to use the `addEventListener()` method to listen for these specific events, as the following code shows:

```
var fileRef:FileReference = new FileReference();
fileRef.addEventListener(Event.SELECT, selectHandler);
fileRef.addEventListener(Event.OPEN, openHandler);
fileRef.addEventListener(Event.COMPLETE, completeHandler);
fileRef.browse();

function selectHandler(event:Event):void
{
    trace("...select...");
    var request:URLRequest = new URLRequest("http://www.yourdomain.com/
fileupload.cfm");
    request.method = URLRequestMethod.POST;
    event.target.upload(request.url);
}
function openHandler(event:Event):void
{
    trace("...open...");
}
function completeHandler(event:Event):void
{
    trace("...complete...");
}
```

For detailed information on asynchronous error handling, see [“Responding to error events and status” on page 268](#).

- *Uncaught exceptions* are errors thrown with no corresponding logic (like a `catch` statement) to respond to them. If your application throws an error, and no appropriate `catch` statement or event handler can be found at the current or higher level to handle the error, the error is considered an uncaught exception.

At run time, Flash Player ignores, by design, uncaught errors and tries to continue playing if the error doesn't stop the current SWF file, because users can't necessarily resolve an error themselves. The process of ignoring an uncaught error is called “failing silently” and can complicate debugging applications. The debugger version of Flash Player responds to an uncaught error by terminating the current script and displaying the uncaught error in `trace` statement output or writing the error message to a log file. If the exception object is an instance of the `Error` class or one of its subclasses, the `getStackTrace()` method is invoked, and the stack trace information will also be displayed in `trace` statement output or in a log file. For more information about using the debugger version of Flash Player, see [“Working with the debugger version of Flash Player” on page 261](#).

## Error handling in ActionScript 3.0

Since many applications can run without building the logic to handle errors, developers are tempted to postpone building error handling into their applications. However, without error handling, an application may easily stall or frustrate the user if something doesn't work as expected. ActionScript 2.0 has an `Error` class that allows you to build logic into custom functions to throw an exception with a specific message. Because error handling is critical for making a user-friendly application, ActionScript 3.0 includes an expanded architecture for catching errors.

NOTE

While the *ActionScript 3.0 Language and Components Reference* documents the exceptions thrown by many methods, it may not include all possible exceptions for each method. A method may throw an exception for syntax errors or other problems that are not noted explicitly in the method description, even when the description does list some of the exceptions a method throws.

## ActionScript 3.0 error-handling elements

ActionScript 3.0 includes many tools for error handling, including:

- **Error classes.** In compliance with the ECMAScript (ECMA-262) edition 4 draft language specification, ActionScript 3.0 includes a broad range of Error classes to expand the scope of situations that may produce error objects. Each Error class helps applications handle and respond to specific error conditions, whether they are related to system errors (like a `MemoryError` condition), coding errors (like an `ArgumentError` condition), networking and communication errors (like a `URIError` condition), or other situations. For more information on each class, see [“Comparing the Error classes” on page 272](#).
- **Fewer silent failures.** In earlier versions of Flash Player, errors were generated and reported only if you explicitly used the `throw` statement. For Flash Player 9, native ActionScript methods and properties throw run-time errors that allow you to handle these exceptions more effectively when they occur, and then individually react to each exception.
- **Clear error messages displayed during debugging.** When you are using the debugger version of Flash Player, problematic code or situations will generate robust error messages, which help you easily identify reasons why a particular block of code fails. This makes fixing errors more efficient. For more information, see [“Working with the debugger version of Flash Player” on page 261](#).
- **Precise errors allow for clear error messages displayed to users at run time.** In previous versions of Flash Player, the `FileReference.upload()` method returned a Boolean value of `false` if the `upload()` call was unsuccessful, indicating one of five possible errors. If an error occurs when you call the `upload()` method in ActionScript 3.0, you can throw one of four specific errors, which helps you display more accurate error messages to end users.
- **Refined error handling.** Distinct errors are thrown for many common situations. For example, in ActionScript 2.0, before a `FileReference` object has been populated, the `name` property has the value `null` (so, before you can use or display the `name` property, you need to ensure that the value is set and not `null`). In ActionScript 3.0, if you attempt to access the `name` property before it has been populated, Flash Player throws an `IllegalOperationError`, which informs you that the value has not been set, and you can use `try..catch..finally` blocks to handle the error. For more information see [“Using try..catch..finally statements” on page 262](#).
- **No significant performance drawbacks.** Using `try..catch..finally` blocks to handle errors takes little or no additional resources compared to previous versions of ActionScript.
- **An `ErrorEvent` class that allows you to build listeners for specific asynchronous error events.** For more information see [“Responding to error events and status” on page 268](#).

## Error-handling strategies

As long as your application doesn't encounter a problematic condition, it may still run successfully if you don't build error-handling logic into your code. However, if you don't actively handle errors and your application does encounter a problem, your users will never know why your application fails when it does.

There are different ways you can approach error handling in your application. The following list summarizes the three major options for handling errors:

- Use `try..catch..finally` statements. These will catch synchronous errors as they occur. You can nest your statements into a hierarchy to catch exceptions at various levels of code execution. For more information, see [“Using try..catch..finally statements” on page 262](#).
- Create your own custom error objects. You can use the `Error` class to create your own custom error objects to track specific operations in your application that are not covered by built-in error types. Then you can use `try..catch..finally` statements on your custom error objects. For more information see [“Creating custom error classes” on page 267](#).
- Write event listeners and handlers to respond to error events. By using this strategy, you can create global error handlers that let you handle similar events without duplicating a lot of code in `try..catch..finally` blocks. You are also more likely to catch asynchronous errors using this approach. For more information, see [“Responding to error events and status” on page 268](#).

## Working with the debugger version of Flash Player

Adobe provides developers with a special edition of the Flash Player to assist debugging efforts. You obtain a copy of the debugger version of Flash Player when you install Adobe Flash CS3 Professional or Adobe Flex Builder 2.

There is a notable difference in how the debugger version and the release version of Flash Player indicate errors. The debugger version shows the error type (such as a generic `Error`, `IOError`, or `EOFError`), error number, and a human-readable error message. The release version shows only the error type and error number. For example, consider the following code:

```
try
{
    tf.text = myByteArray.readBoolean();
}
```

```
catch (error:EOFError)
{
    tf.text = error.toString();
}
```

If the `readBoolean()` method threw an `EOFError` in the debugger version of Flash Player, the following message would be displayed in the `tf` text field: “`EOFError: Error #2030: End of file was encountered.`”

The same code in a release version of Flash Player would display the following text: “`EOFError: Error #2030.`”

In order to keep Flash Player’s resources and size to a minimum in the release version, error message strings are not present. You can look up the error number in the documentation (the appendixes of the *ActionScript 3.0 Language and Components Reference*) to correlate to an error message. Alternatively, you can reproduce the error using the debugger version of Flash Player to see the full message.

## Handling synchronous errors in an application

The most common error handling is synchronous error-handling logic, where you insert statements into your code to catch synchronous errors at run time. This type of error handling lets your application notice and recover from run-time errors when functions fail. The logic for catching a synchronous error includes `try..catch..finally` statements, which literally try an operation, catch any error response from Flash Player, and finally execute some other operation to handle the failed operation.

### Using `try..catch..finally` statements

When you work with synchronous run-time errors, use the `try..catch..finally` statements to catch errors. When a run-time error occurs, Flash Player throws an exception, which means that Flash Player suspends normal execution and creates a special object of type `Error`. The `Error` object is then thrown to the first available `catch` block.

The `try` statement encloses statements that have the potential to create errors. You always use the `catch` statement with a `try` statement. If an error is detected in one of the statements in the `try` statement block, the `catch` statements that are attached to that `try` statement will execute.

The `finally` statement encloses statements that will execute whether or not an error occurs in the `try` block. If there is no error, the statements within the `finally` block execute after the `try` block statements complete. If there is an error, the appropriate `catch` statement executes first, followed by the statements in the `finally` block.

The following code demonstrates the syntax for using the `try..catch..finally` statements:

```
try
{
    // some code that could throw an error
}
catch (err:Error)
{
    // code to react to the error
}
finally
{
    // Code that runs whether or not an error was thrown. This code can clean
    // up after the error, or take steps to keep the application running.
}
```

Each `catch` statement identifies a specific type of exception that it handles. The `catch` statement can specify only error classes that are subclasses of the `Error` class. Each `catch` statement is checked in order. Only the first `catch` statement that matches the type of error thrown will execute. In other words, if you first check the higher-level `Error` class and then a subclass of the `Error` class, only the higher-level `Error` class will match. The following code illustrates this point:

```
try
{
    throw new ArgumentError("I am an ArgumentError");
}
catch (error:Error)
{
    trace("<Error> " + error.message);
}
catch (error:ArgumentError)
{
    trace("<ArgumentError> " + error.message);
}
```

The previous code displays the following output:

```
<Error> I am an ArgumentError
```

In order to correctly catch the `ArgumentError`, you need to make sure that the most specific error types are listed first and the more generic error types are listed later, as the following code shows:

```
try
{
```

```

        throw new ArgumentError("I am an ArgumentError");
    }
    catch (error:ArgumentError)
    {
        trace("<ArgumentError> " + error.message);
    }
    catch (error:Error)
    {
        trace("<Error> " + error.message);
    }
}

```

Several methods and properties in the Flash Player API throw run-time errors if they encounter errors while they execute. For example, the `close()` method in the `Sound` class throws an `IOError` if the method is unable to close the audio stream, as demonstrated in the following code:

```

var mySound:Sound = new Sound();
try
{
    mySound.close();
}
catch (error:IOError)
{
    // Error #2029: This URLStream object does not have an open stream.
}

```

As you become more familiar with the *ActionScript 3.0 Language and Components Reference*, you'll notice which methods throw exceptions, as detailed in each method's description.

## The throw statement

Flash Player throws exceptions when it encounters errors in your application at run time. In addition, you can explicitly throw exceptions yourself using the `throw` statement. When explicitly throwing errors, Adobe recommends that you throw instances of the `Error` class or its subclasses. The following code demonstrates a `throw` statement that throws an instance of the `Error` class, `MyErr`, and eventually calls a function, `myFunction()`, to respond after the error is thrown:

```

var MyError:Error = new Error("Encountered an error with the numUsers
    value", 99);
var numUsers:uint = 0;
try
{
    if (numUsers == 0)
    {
        trace("numUsers equals 0");
    }
}
}

```



```

catch (error:uint)
{
    throw MyError; // Catch unsigned integer errors.
}
catch (error:int)
{
    throw MyError; // Catch integer errors.
}
catch (error:Number)
{
    throw MyError; // Catch number errors.
}
catch (error:*)
{
    throw MyError; // Catch any other error.
}
finally
{
    myFunction(); // Perform any necessary cleanup here.
}

```

Notice that the `catch` statements are ordered so that the most specific data types are listed first. If the `catch` statement for the `Number` data type was listed first, neither the `catch` statement for the `uint` data type nor the `catch` statement for the `int` data type would ever get executed.

**NOTE**

In the Java programming language, each function that can throw an exception must declare this fact, listing the exception classes it can throw in a `throws` clause attached to the function declaration. `ActionScript` does not require you to declare the exceptions that can be thrown by a function.

## Displaying a simple error message

One of the biggest benefits of the new exception and error event model is that it allows you to tell users when and why an action has failed. Your part is to write the code to display the message and offer options in response.

The following code shows a simple `try..catch` statement to display the error in a text field:

```

package
{
    import flash.display.Sprite;
    import flash.text.TextField;

    public class SimpleError extends Sprite
    {
        public var employee:XML =
            <EmpCode>
                <costCenter>1234</costCenter>
            </EmpCode>
    }
}

```

```

        <costCenter>1-234</costCenter>
    </EmpCode>;

    public function SimpleError()
    {
        try
        {
            if (employee.costCenter.length() != 1)
            {
                throw new Error("Error, employee must have exactly one cost
center assigned.");
            }
        }
        catch (error:Error)
        {
            var errorMessage:TextField = new TextField();
            errorMessage.autoSize = TextFieldAutoSize.LEFT;
            errorMessage.textColor = 0xFF0000;
            errorMessage.text = error.message;
            addChild(errorMessage);
        }
    }
}

```

Using a wider range of error classes and built-in compiler errors, ActionScript 3.0 offers more information than previous versions of ActionScript about why something has failed. This enables you to build more stable applications with better error handling.

## Rethrowing errors

When you build applications, there are several occasions in which you may need to rethrow an error if you are unable to handle the error properly. For example, the following code shows a nested `try..catch` block, which rethrows a custom `ApplicationError` if the nested `catch` block is unable to handle the error:

```

try
{
    try
    {
        trace("<< try >>");
        throw new ArgumentError("some error which will be rethrown");
    }
    catch (error:ApplicationError)
    {
        trace("<< catch >> " + error);
        trace("<< throw >>");
        throw error;
    }
}

```

```

    }
    catch (error:Error)
    {
        trace("<< Error >> " + error);
    }
}
catch (error:ApplicationError)
{
    trace("<< catch >> " + error);
}

```

The output from the previous snippet would be the following:

```

<< try >>
<< catch >> ApplicationError: some error which will be rethrown
<< throw >>
<< catch >> ApplicationError: some error which will be rethrown

```

The nested `try` block throws a custom `ApplicationError` error that is caught by the subsequent `catch` block. This nested `catch` block can try to handle the error, and if unsuccessful, throw the `ApplicationError` object to the enclosing `try..catch` block.

## Creating custom error classes

You can extend one of the standard `Error` classes to create your own specialized error classes in `ActionScript`. There are a number of reasons to create your own error classes:

- To identify specific errors or groups of errors that are unique to your application.  
For example, you may want to take different actions for errors thrown by your own code, in addition to those trapped by `Flash Player`. You can create a subclass of the `Error` class to track the new error data type in `try..catch` blocks.
- To provide unique error display capabilities for errors generated by your application.  
For example, you can create a new `toString()` method that formats your error messages in a certain way. You can also define a `lookupErrorMessage()` method that takes an error code and retrieves the proper message based on the user's language preference.

A specialized error class must extend the core `ActionScript` `Error` class. Here is an example of a specialized `AppError` class that extends the `Error` class:

```

public class AppError extends Error
{
    public function AppError(message:String, errorID:int)
    {
        super(message, errorID);
    }
}

```

The following shows an example of using `AppError` in your project:

```
try
{
    throw new AppError("Encountered Custom AppError", 29);
}
catch (error:AppError)
{
    trace(error.errorID + ": " + error.message)
}
```

NOTE

If you want to override the `Error.toString()` method in your subclass, you need to give it one `... (rest)` parameter. The ECMAScript (ECMA-262) edition 3 language specification defines the `Error.toString()` method that way, and ActionScript 3.0 defines it the same way for backward compatibility with that specification. Therefore, when you override the `Error.toString()` method, you must match the parameters exactly. You will not want to pass any parameters to your `toString()` method at run time, because those parameters are ignored.

## Responding to error events and status

One of the most noticeable improvements to error handling in ActionScript 3.0 is the support for error event handling for responding to asynchronous run-time errors. (For a definition of asynchronous errors, see [“Types of errors” on page 257.](#))

You can create event listeners and event handlers to respond to the error events. Many classes dispatch error events the same way they dispatch other events. For example, an instance of the `XMLSocket` class normally dispatches three types of events: `Event.CLOSE`, `Event.CONNECT`, and `DataEvent.DATA`. However, when a problem occurs, the `XMLSocket` class can dispatch the `IOErrorEvent.IOError` or the `SecurityErrorEvent.SECURITY_ERROR`. For more information about event listeners and event handlers, see [Chapter 10, “Handling events,” on page 313.](#)

Error events fit into one of two categories:

- Error events that extend the `ErrorEvent` class  
The `flash.events.ErrorEvent` class contains the properties and methods for managing Flash Player run-time errors related to networking and communication operations. The `AsyncErrorEvent`, `IOErrorEvent`, and `SecurityErrorEvent` classes extend the `ErrorEvent` class. If you're using the debugger version of Flash Player, a dialog box will inform you at run-time of any error events without listener functions that the player encounters.

- Status-based error events

The status-based error events are related to the `netStatus` and `status` properties of the networking and communication classes. If Flash Player encounters a problem when reading or writing data, the value of the `netStatus.info.level` or `status.level` properties (depending on the class object you're using) is set to the value "error". You respond to this error by checking if the `level` property contains the value "error" in your event handler function.

## Working with error events

The `ErrorEvent` class and its subclasses contain error types for handling errors dispatched by Flash Player as it tries to read or write data.

The following example uses both a `try..catch` statement and error event handlers to display any errors detected while trying to read a local file. You can add more sophisticated handling code to provide a user with options or otherwise handle the error automatically in the places indicated by the comment "your error-handling code here":

```
package
{
    import flash.display.Sprite;
    import flash.errors.IOError;
    import flash.events.IOErrorEvent;
    import flash.events.TextEvent;
    import flash.media.Sound;
    import flash.media.SoundChannel;
    import flash.net.URLRequest;
    import flash.text.TextField;

    public class LinkEventExample extends Sprite
    {
        private var myMP3:Sound;
        public function LinkEventExample()
        {
            myMP3 = new Sound();
            var list:TextField = new TextField();
            list.autoSize = TextFieldAutoSize.LEFT;
            list.multiline = true;
            list.htmlText = "<a href=\"event:track1.mp3\">Track 1</a><br>";
            list.htmlText += "<a href=\"event:track2.mp3\">Track 2</a><br>";
            addEventListener(TextEvent.LINK, linkHandler);
            addChild(list);
        }

        private function playMP3(mp3:String):void
        {
            try
```

```

    {
        myMP3.load(new URLRequest(mp3));
        myMP3.play();
    }
    catch (err:Error)
    {
        trace(err.message);
        // your error-handling code here
    }
    myMP3.addEventListener(IOErrorEvent.IO_ERROR, errorHandler);
}

private function linkHandler(linkEvent:TextEvent):void
{
    playMP3(linkEvent.text);
    // your error-handling code here
}

private function errorHandler(errorEvent:IOErrorEvent):void
{
    trace(errorEvent.text);
    // your error-handling code here
}
}
}

```

## Working with status change events

Flash Player dynamically changes the value of the `netStatus.info.level` or `status.level` properties for the classes that support the `level` property. The classes that have the `netStatus.info.level` property are `NetConnection`, `NetStream`, and `SharedObject`. The classes that have the `status.level` property are `HTTPStatusEvent`, `Camera`, `Microphone`, and `LocalConnection`. You can write a handler function to respond to the change in `level` value and track communication errors.

The following example uses a `netStatusHandler()` function to test the value of the `level` property. If the `level` property indicates that an error has been encountered, the code traces the message “Video stream failed”.

```

package
{
    import flash.display.Sprite;
    import flash.events.NetStatusEvent;
    import flash.events.SecurityErrorEvent;
    import flash.media.Video;
    import flash.net.NetConnection;
    import flash.net.NetStream;

```

```

public class VideoExample extends Sprite
{
    private var videoUrl:String = "Video.flv";
    private var connection:NetConnection;
    private var stream:NetStream;

    public function VideoExample()
    {
        connection = new NetConnection();
        connection.addEventListener(NetStatusEvent.NET_STATUS,
netStatusHandler);
        connection.addEventListener(SecurityErrorEvent.SECURITY_ERROR,
securityErrorHandler);
        connection.connect(null);
    }

    private function netStatusHandler(event:NetStatusEvent):void
    {
        if (event.info.level = "error")
        {
            trace("Video stream failed")
        }
        else
        {
            connectStream();
        }
    }

    private function securityErrorHandler(event:SecurityErrorEvent):void
    {
        trace("securityErrorHandler: " + event);
    }

    private function connectStream():void
    {
        var stream:NetStream = new NetStream(connection);
        var video:Video = new Video();
        video.attachNetStream(stream);
        stream.play(videoUrl);
        addChild(video);
    }
}
}

```

# Comparing the Error classes

ActionScript provides a number of predefined Error classes. Many of these classes are used by Flash Player, but you can also use the same Error classes in your own code. There are two main types of Error classes in ActionScript 3.0: ActionScript core Error classes and `flash.error` package Error classes. The core Error classes are prescribed by the ECMAScript (ECMA-262) edition 4 draft language specification. The `flash.error` package contents are additional classes introduced to aid ActionScript 3.0 application development and debugging.

## ECMAScript core Error classes

The ECMAScript core error classes include the `Error`, `EvalError`, `RangeError`, `ReferenceError`, `SyntaxError`, `TypeError`, and `URIError` classes. Each of these classes are located in the top-level namespace.

Class name	Description	Notes
<code>Error</code>	The <code>Error</code> class can be used for throwing exceptions, and is the base class for the other exception classes defined in ECMAScript: <code>EvalError</code> , <code>RangeError</code> , <code>ReferenceError</code> , <code>SyntaxError</code> , <code>TypeError</code> , and <code>URIError</code> .	The <code>Error</code> class serves as the base class for all run-time errors thrown by Flash Player, and is the recommended base class for any custom error classes.
<code>EvalError</code>	An <code>EvalError</code> exception is thrown if any parameters are passed to the <code>Function</code> class's constructor or if user code calls the <code>eval()</code> function.	In ActionScript 3.0, support for the <code>eval()</code> function has been removed and attempts to use the function cause an error to be thrown. Earlier versions of Flash Player used the <code>eval()</code> function to access variables, properties, objects, or movie clips by name.
<code>RangeError</code>	A <code>RangeError</code> exception is thrown if a numeric value falls outside of an acceptable range.	For example, a <code>RangeError</code> would be thrown by the <code>Timer</code> class if a delay was either negative or was not finite. A <code>RangeError</code> could also be thrown if you attempted to add a display object at an invalid depth.



Class name	Description	Notes
ReferenceError	<p>A ReferenceError exception is thrown when a reference to an undefined property is attempted on a sealed (nondynamic) object. Versions of the ActionScript compiler before ActionScript 3.0 did not throw an error when access was attempted to a property that was <code>undefined</code>. However, because the new ECMAScript specification specifies that an error should be thrown in this condition, ActionScript 3.0 throws the ReferenceError exception.</p>	<p>Exceptions for undefined variables point to potential bugs, helping you improve software quality. However, if you are not used to having to initialize your variables, this new ActionScript behavior may require some changes in your coding habits.</p>
SyntaxError	<p>A SyntaxError exception is thrown when a parsing error occurs in your ActionScript code. For more information, see Section 15.11.6.4 of the ECMAScript (ECMA-262) edition 3 (until edition 4 is available) language specification at <a href="http://www.ecma-international.org/publications/standards/Ecma-262.htm">www.ecma-international.org/publications/standards/Ecma-262.htm</a>, as well as Section 10.3.1 of the ECMAScript for XML (E4X) specification (ECMA-357 edition 2) at <a href="http://www.ecma-international.org/publications/standards/Ecma-357.htm">www.ecma-international.org/publications/standards/Ecma-357.htm</a>.</p>	<p>A SyntaxError can be thrown under the following circumstances:</p> <ul style="list-style-type: none"> <li>• ActionScript throws SyntaxError exceptions when an invalid regular expression is parsed by the RegExp class.</li> <li>• ActionScript throws SyntaxError exceptions when invalid XML is parsed by the XMLDocument class.</li> </ul>

Class name	Description	Notes
TypeError	<p>The <code>TypeError</code> exception is thrown when the actual type of an operand is different from the expected type.</p> <p>For more information, see Section 15.11.6.5 of the ECMAScript specification at <a href="http://www.ecma-international.org/publications/standards/Ecma-262.htm">www.ecma-international.org/publications/standards/Ecma-262.htm</a>, as well as Section 10.3 of the E4X specification at <a href="http://www.ecma-international.org/publications/standards/Ecma-357.htm">www.ecma-international.org/publications/standards/Ecma-357.htm</a>.</p>	<p>A <code>TypeError</code> can be thrown under the following circumstances:</p> <ul style="list-style-type: none"> <li>• An actual parameter of a function or method could not be coerced to the formal parameter type.</li> <li>• A value is assigned to a variable and cannot be coerced to the variable's type.</li> <li>• The right side of the <code>is</code> or <code>instanceof</code> operator is not a valid type.</li> <li>• The <code>super</code> keyword is used illegally.</li> <li>• A property lookup results in more than one binding, and is therefore ambiguous.</li> <li>• A method is invoked on an incompatible object. For example, a <code>TypeError</code> exception is thrown if a method in the <code>RegExp</code> class is “grafted” onto a generic object and then invoked.</li> </ul>
URIError	<p>The <code>URIError</code> exception is thrown when one of the global URI handling functions is used in a way that is incompatible with its definition.</p> <p>For more information, see Section 15.11.6.6 of the ECMAScript specification at <a href="http://www.ecma-international.org/publications/standards/Ecma-262.htm">www.ecma-international.org/publications/standards/Ecma-262.htm</a>.</p>	<p>A <code>URIError</code> can be thrown under the following circumstances:</p> <p>An invalid URI is specified for a Flash Player API function that expects a valid URI, such as <code>Socket.connect()</code>.</p>

# ActionScript core Error classes

In addition to the core ECMAScript Error classes, ActionScript adds several classes of its own for ActionScript-specific error conditions and error-handling functionality.

Because these classes are ActionScript language extensions to ECMAScript edition 4 draft language specification that could potentially be interesting additions to the draft specification, they are kept at the top level instead of being placed in a package like `flash.error`.

Class name	Description	Notes
ArgumentError	The ArgumentError class represents an error that occurs when the parameter values supplied during a function call do not match the parameters defined for that function.	Some examples of argument errors include the following: <ul style="list-style-type: none"><li>• Too few or too many arguments are supplied to a method.</li><li>• An argument was expected to be a member of an enumeration and was not.</li></ul>
SecurityError	The SecurityError exception is thrown when a security violation takes place and access is denied.	Some examples of security errors include the following: <ul style="list-style-type: none"><li>• An unauthorized property access or method call is made across a security sandbox boundary.</li><li>• An attempt was made to access a URL not permitted by the security sandbox.</li><li>• A socket connection was attempted to an unauthorized port number—for example, a port below 1024—without a policy file present.</li><li>• An attempt was made to access the user's camera or microphone, and the request to access the device was denied by the user.</li></ul>
VerifyError	A VerifyError exception is thrown when a malformed or corrupted SWF file is encountered.	When a SWF file loads another SWF file, the parent SWF can catch a VerifyError generated by the loaded SWF.

## flash.error package Error classes

The `flash.error` package contains Error classes that are considered part of the Flash Player API. In contrast to the Error classes just described, the `flash.error` package communicates errors events that are specific to Flash Player.

Class name	Description	Notes
<code>EOFError</code>	An <code>EOFError</code> exception is thrown when you attempt to read past the end of the available data.	For example, an <code>EOFError</code> is thrown when one of the read methods in the <code>IDataInput</code> interface is called and there is insufficient data to satisfy the read request.
<code>IllegalOperationError</code>	An <code>IllegalOperationError</code> exception is thrown when a method is not implemented or the implementation doesn't cover the current usage.	Examples of illegal operation error exceptions include the following: <ul style="list-style-type: none"><li>• A base class, such as <code>DisplayObjectContainer</code>, provides more functionality than the Stage can support. For example, if you attempt to get or set a mask on the Stage (using <code>stage.mask</code>), Flash Player will throw an <code>IllegalOperationError</code> with the message "The Stage class does not implement this property or method."</li><li>• A subclass inherits a method it does not require and does not want to support.</li><li>• Certain accessibility methods are called when Flash Player is compiled without accessibility support.</li><li>• Authoring-only features are invoked from a run-time version of Flash Player.</li><li>• You attempt to set the name of an object placed on the timeline.</li></ul>
<code>IOError</code>	An <code>IOError</code> exception is thrown when some type of I/O exception occurs.	You get this error, for example, when a read-write operation is attempted on a socket that is not connected or that has become disconnected.

Class name	Description	Notes
MemoryError	A MemoryError exception is thrown when a memory allocation request fails.	By default, ActionScript Virtual Machine 2 does not impose a limit on how much memory an ActionScript program may allocate. On a desktop PC, memory allocation failures are infrequent. You see an error thrown when the system is unable to allocate the memory required for an operation. So, on a desktop PC, this exception is rare unless an allocation request is extremely large; for example, a request for 3 billion bytes is impossible because a 32-bit Microsoft® Windows® program can access only 2 GB of address space.
ScriptTimeoutError	A ScriptTimeoutError exception is thrown when a script timeout interval of 15 seconds is reached. By catching a ScriptTimeoutError exception, you can handle the script timeout more gracefully. If there is no exception handler, the uncaught exception handler will display a dialog box with an error message.	To prevent a malicious developer from catching the exception and staying in an infinite loop, only the first ScriptTimeoutError exception thrown in the course of a particular script can be caught. A subsequent ScriptTimeoutError exception cannot be caught by your code and will immediately go to the uncaught exception handler.
StackOverflowError	The StackOverflowError exception is thrown when the stack available to the script has been exhausted.	A StackOverflowError exception might indicate that infinite recursion has occurred.

# Example: CustomErrors application

The CustomErrors application demonstrates techniques for working with custom errors when building an application. These techniques are:

- Validating an XML packet
- Writing a custom error
- Throwing custom errors
- Notifying users when an error is thrown

To get the application files for this sample, see [www.adobe.com/go/learn\\_programmingAS3samples\\_flash](http://www.adobe.com/go/learn_programmingAS3samples_flash). The CustomErrors application files can be found in the Samples/CustomError folder. The application consists of the following files:

File	Description
CustomErrors.mxml or CustomErrors.fla	The main application file in Flash (FLA) or Flex (MXML)
com/example/programmingas3/errors/ ApplicationError.as	A class that serves as the base error class for both the FatalError and WarningError classes.
com/example/programmingas3/errors/ FatalError.as	A class that defines a FatalError error that can be thrown by the application. This class extends the custom ApplicationError class.
com/example/programmingas3/errors/ Validator.as	A class that defines a single method that validates a user-supplied employee XML packet.
com/example/programmingas3/errors/ WarningError.as	A class that defines a WarningError error that can be thrown by the application. This class extends the custom ApplicationError class.

## CustomErrors application overview

The CustomErrors.mxml file contains the user interface and some logic for the custom error application. Once the application's `creationComplete` event is dispatched, the `initApp()` method is invoked. This method defines a sample XML packet that will be verified by the `Validator` class. The following code shows the `initApp()` method:

```
private function initApp():void
{
    employeeXML =
        <employee id="12345">
            <firstName>John</firstName>
```

```

        <lastName>Doe</lastName>
        <costCenter>12345</costCenter>
        <costCenter>67890</costCenter>
    </employee>;
}

```

The XML packet is later displayed in a `TextArea` component instance on the Stage. This allows you to modify the XML packet before attempting to revalidate it.

When the user clicks the Validate button, the `validateData()` method is called. This method validates the employee XML packet using the `validateEmployeeXML()` method in the `Validator` class. The following code shows the `validateData()` method:

```

public function validateData():void
{
    try
    {
        var tempXML:XML = XML(xmlText.text);
        Validator.validateEmployeeXML(tempXML);
        status.text = "The XML was successfully validated.";
    }
    catch (error:FatalError)
    {
        showFatalError(error);
    }
    catch (error:WarningError)
    {
        showWarningError(error);
    }
    catch (error:Error)
    {
        showGenericError(error);
    }
}

```

First, a temporary XML object is created using the contents of the `TextArea` component instance `xmlText`. Next, the `validateEmployeeXML()` method in the custom `Validator` class (`com.example.programmingas3/errors/Validator.as`) is invoked and passes the temporary XML object as a parameter. If the XML packet is valid, the `status` Label component instance displays a success message and the application exits. If the `validateEmployeeXML()` method threw a custom error (that is, a `FatalError`, `WarningError`, or a generic `Error` occurred), the appropriate `catch` statement executes and calls either the `showFatalError()`, `showWarningError()`, or `showGenericError()` methods. Each of these methods displays an appropriate message in an `Alert` component to notify the user of the specific error that occurred. Each method also updates the `status` Label component instance with a specific message.

If a fatal error occurs during an attempt to validate the employee XML packet, the error message is displayed in an Alert component, and the `xmlText` TextArea component instance and `validateBtn` Button component instance are disabled, as the following code shows:

```
public function showFatalError(error:FatalError):void
{
    var message:String = error.message + "\n\n" + "Click OK to end.";
    var title:String = error.getTitle();
    Alert.show(message, title);
    status.text = "This application has ended.";
    this.xmlText.enabled = false;
    this.validateBtn.enabled = false;
}
```

If a warning error instead of a fatal error occurs, the error message is displayed in an Alert component instance, but the TextField and Button component instances aren't disabled. The `showWarningError()` method displays the custom error message in the Alert component instance. The message also asks the user to decide if they want to proceed with validating the XML or abort the script. The following excerpt shows the `showWarningError()` method:

```
public function showWarningError(error:WarningError):void
{
    var message:String = error.message + "\n\n" + "Do you want to exit this
application?";
    var title:String = error.getTitle();
    Alert.show(message, title, Alert.YES | Alert.NO, null, closeHandler);
    status.text = message;
}
```

When the user closes the Alert component instance by using either the Yes or No button, the `closeHandler()` method is invoked. The following excerpt shows the `closeHandler()` method:

```
private function closeHandler(event:CloseEvent):void
{
    switch (event.detail)
    {
        case Alert.YES:
            showFatalError(new FatalError(9999));
            break;
        case Alert.NO:
            break;
    }
}
```

If the user chooses to abort the script by clicking Yes in the warning error Alert dialog, a `FatalError` is thrown, causing the application to terminate.



## Building a custom validator

The custom `Validator` class contains a single method, `validateEmployeeXML()`. The `validateEmployeeXML()` method takes a single argument, `employee`, which is the XML packet that you wish to validate. The `validateEmployeeXML()` method is as follows:

```
public static function validateEmployeeXML(employee:XML):void
{
    // checks for the integrity of items in the XML
    if (employee.costCenter.length() < 1)
    {
        throw new FatalError(9000);
    }
    if (employee.costCenter.length() > 1)
    {
        throw new WarningError(9001);
    }
    if (employee.ssn.length() != 1)
    {
        throw new FatalError(9002);
    }
}
```

To be validated, an employee must belong to one (and only one) cost center. If the employee doesn't belong to any cost centers, the method throws a `FatalError`, which bubbles up to the `validateData()` method in the main application file. If the employee belongs to more than one cost center, a `WarningError` is thrown. The final check in the XML validator is that the user has exactly one social security number defined (the `ssn` node in the XML packet). If there is not exactly one `ssn` node, a `FatalError` error is thrown.

You can add additional checks to the `validateEmployeeXML()` method—for instance, to ensure that the `ssn` node contains a valid number, or that the employee has at least one phone number and e-mail address defined, and that both values are valid. You can also modify the XML so that each employee has a unique ID and specifies the ID of their manager.

## Defining the `ApplicationError` class

The `ApplicationError` class serves as the base class for both the `FatalError` and `WarningError` classes. The `ApplicationError` class extends the `Error` class, and defines its own custom methods and properties, including defining an error ID, severity, and an XML object that contains the custom error codes and messages. This class also defines two static constants that are used to define the severity of each error type.

The `ApplicationError` class's constructor method is as follows:

```
public function ApplicationError()
{
    messages =
        <errors>
            <error code="9000">
                <![CDATA[Employee must be assigned to a cost center.]]>
            </error>
            <error code="9001">
                <![CDATA[Employee must be assigned to only one cost center.]]>
            </error>
            <error code="9002">
                <![CDATA[Employee must have one and only one SSN.]]>
            </error>
            <error code="9999">
                <![CDATA[The application has been stopped.]]>
            </error>
        </errors>;
}
```

Each error node in the XML object contains a unique numeric code and an error message. Error messages can be easily looked up by their error code using E4X, as seen in the following `getMessageText()` method:

```
public function getMessageText(id:int):String
{
    var message:XMLList = messages.error.@code == id;
    return message[0].text();
}
```

The `getMessageText()` method takes a single integer argument, `id`, and returns a string. The `id` argument is the error code for the error to look up. For example, passing an `id` of 9001 retrieves the error saying that employees must be assigned to only one cost center. If more than one error has the same error code, ActionScript returns the error message only for the first result found (`message[0]` in the returned XMLList object).

The next method in this class, `getTitle()`, doesn't take any parameters and returns a string value that contains the error ID for this specific error. This value is used in the Alert component's title to help you easily identify the exact error that occurred during validation of the XML packet. The following excerpt shows the `getTitle()` method:

```
public function getTitle():String
{
    return "Error #" + id;
}
```

The final method in the `ApplicationError` class is `toString()`. This method overrides the function defined in the `Error` class so that you can customize the presentation of the error message. The method returns a string that identifies the specific error number and message that occurred.

```
public override function toString():String
{
    return "[APPLICATION ERROR #" + id + "] " + message;
}
```

## Defining the `FatalError` class

The `FatalError` class extends the custom `ApplicationError` class and defines three methods: the `FatalError` constructor, `getTitle()`, and `toString()`. The first method, the `FatalError` constructor, takes a single integer argument, `errorID`, and sets the error's severity using the static constant values defined in the `ApplicationError` class, and gets the specific error's error message by calling the `getMessageText()` method in the `ApplicationError` class. The `FatalError` constructor is as follows:

```
public function FatalError(errorID:int)
{
    id = errorID;
    severity = ApplicationError.FATAL;
    message = getMessageText(errorID);
}
```

The next method in the `FatalError` class, `getTitle()`, overrides the `getTitle()` method defined earlier in the `ApplicationError` class, and appends the text "-- FATAL" in the title to inform the user that a fatal error has occurred. The `getTitle()` method is as follows:

```
public override function getTitle():String
{
    return "Error #" + id + " -- FATAL";
}
```

The final method in this class, `toString()`, overrides the `toString()` method defined in the `ApplicationError` class. The `toString()` method is

```
public override function toString():String
{
    return "[FATAL ERROR #" + id + "] " + message;
}
```

## Defining the WarningError class

The `WarningError` class extends the `ApplicationError` class and is nearly identical to the `FatalError` class, except for a couple minor string changes and sets the error severity to `ApplicationError.WARNING` instead of `ApplicationError.FATAL`, as seen in the following code:

```
public function WarningError(errorID:int)
{
    id = errorID;
    severity = ApplicationError.WARNING;
    message = super.getMessageText(errorID);
}
```

A regular expression describes a pattern that is used to find and manipulate matching text in strings. Regular expressions resemble strings, but they can include special codes to describe patterns and repetition. For example, the following regular expression matches a string that starts with the character A followed by one or more sequential digits:

```
/A\d+/
```

This chapter describes the basic syntax for constructing regular expressions. However, regular expressions can have many complexities and nuances. You can find detailed resources on regular expressions on the web and in bookstores. Keep in mind that different programming environments implement regular expressions in different ways. ActionScript 3.0 implements regular expressions as defined in the ECMAScript edition 3 language specification (ECMA-262).

## Contents

Basics of regular expressions .....	286
Regular expression syntax .....	288
Methods for using regular expressions with strings .....	305
Example: A Wiki parser .....	306

# Basics of regular expressions

## Introduction to using regular expressions

A regular expression describes a pattern of characters. Regular expressions are typically used to verify that a text value conforms to a particular pattern (such as verifying that a user-entered phone number has the proper number of digits) or to replace portions of a text value that matches a particular pattern.

Regular expressions can be simple. For example, suppose you wanted to confirm that a particular string matches “ABC,” or wanted to replace every occurrence of “ABC” in a string with some other text. In that case, you could use the following regular expression, which defines the pattern consisting of the letters A, B, and C in sequence:

```
/ABC/
```

Note that the regular expression literal is delineated with the forward slash (/) character.

Regular expression patterns can also be complex, and sometimes cryptic in appearance, such as the following expression to match a valid e-mail address:

```
/([0-9a-zA-Z]+[._+&])*[0-9a-zA-Z]+@[(-0-9a-zA-Z)+[. ]+[a-zA-Z]{2,6}/
```

Most commonly you will use regular expressions to search for patterns in strings and to replace characters. In those cases, you will create a regular expression object and use it as a parameter for one of several String class methods. The following methods of the String class take regular expressions as parameters: `match()`, `replace()`, `search()`, and `split()`. For more information on these methods, see [“Finding patterns in strings and replacing substrings” on page 212](#).

The `RegExp` class includes the following methods: `test()` and `exec()`. For more information, see [“Methods for using regular expressions with strings” on page 305](#).

## Common regular expression tasks

There are several common uses for regular expressions, which are described in detail in this chapter:

- Creating a regular expression pattern
- Using special characters in patterns
- Identifying sequences of multiple characters (such as “a two-digit number” or “between seven and ten letters”)
- Identifying any character in a range of letters or numbers (such as “any letter from *a* to *m*”)
- Identifying a character in a set of possible characters

- Identifying subsequences (segments within a pattern)
- Matching and replacing text based on patterns

## Important concepts and terms

The following reference list contains important terms used in this chapter:

- **Escape character:** A character indicating that the character that follows should be treated as a metacharacter rather than a literal character. In regular expression syntax, the backslash character (`\`) is the escape character, so a backslash followed by another character is a special code rather than just the character itself.
- **Flag:** A character that specifies some option about how the regular expression pattern should be used, such as whether to distinguish between uppercase and lowercase characters.
- **Metacharacter:** A character that has special meaning in a regular expression pattern, as opposed to literally representing that character in the pattern.
- **Quantifier:** A character (or several characters) indicating how many times a part of the pattern should repeat. For example, a quantifier would be used to designate that a United States postal code should contain five or nine numbers.
- **Regular expression:** A program statement defining a pattern of characters that can be used to confirm whether other strings match that pattern or to replace portions of a string.

## Working through in-chapter examples

As you're working through the chapter, you may want to test some of the example code listings for yourself. Because the code listings in this chapter consist primarily of regular expression patterns, testing the examples involves a few steps:

1. Create a new Flash document.
2. Select a keyframe and open the Actions panel.
3. Create a RegExp (regular expression) variable such as this one:  

```
var pattern:RegExp = /ABC/;
```
4. Copy the pattern from the example and assign it as the value of your RegExp variable. For instance, in the previous line of code, the pattern is the part of the code to the right of the equals sign, not including the semicolon (`/ABC/`).
5. Create one or more String variables containing strings appropriate for testing your regular expression. For instance, if you are creating a regular expression to test for valid e-mail addresses, create a few String variables containing valid and bad e-mail addresses:

```
var goodEmail:String = "bob@example.com";
var badEmail:String = "5@$2.99";
```

6. Add lines of code to test the String variables to determine whether they match the regular expression pattern. These will be the values that you'll want to output to the screen using the `trace()` function or by writing them to a text field on the Stage.

```
trace(goodEmail, " is valid:", pattern.test(goodEmail));
trace(badEmail, " is valid:", pattern.test(badEmail));
```

For instance, assuming `pattern` defines the regular expression pattern for a valid e-mail address, the preceding lines of code writes this text to the Output panel:

```
bob@example.com is valid: true
5@$2.99 is valid: false
```

For more information about testing values by writing the values into a text field instance on the Stage or by using the `trace()` function to print the values to the Output panel, see [“Testing in-chapter example code listings” on page 63](#).

## Regular expression syntax

This section describes all of the elements of ActionScript regular expression syntax. As you'll see, regular expressions can have many complexities and nuances. You can find detailed resources on regular expressions on the web and in bookstores. Keep in mind that different programming environments implement regular expressions in different ways. ActionScript 3.0 implements regular expressions as defined in the ECMAScript edition 3 language specification (ECMA-262).

Generally, you use regular expressions that match more complicated patterns than a simple string of characters. For example, the following regular expression defines the pattern consisting of the letters A, B, and C in sequence followed by any digit:

```
/ABC\d/
```

The `\d` code represents “any digit.” The backslash (`\`) character is called the escape character, and combined with the character that follows it (in this case the letter `d`), it has special meaning in the regular expression. This chapter describes these escape character sequences and other regular expression syntax features.

The following regular expression defines the pattern of the letters ABC followed by any number of digits (note the asterisk):

```
/ABC\d*/
```



The asterisk character (\*) is a *metacharacter*. A metacharacter is a character that has special meaning in regular expressions. The asterisk is a specific type of metacharacter called a *quantifier*, which is used to quantify the amount of repetition of a character or group of characters. For more information, see [“Quantifiers” on page 295](#).

In addition to its pattern, a regular expression can contain flags, which specify how the regular expression is to be matched. For example, the following regular expression uses the `i` flag, which specifies that the regular expression ignores case sensitivity in matching strings:

```
/ABC\d*/i
```

For more information, see [“Flags and properties” on page 301](#).

You can use regular expressions with the following methods of the `String` class: `match()`, `replace()`, and `search()`. For more information on these methods, see [“Finding patterns in strings and replacing substrings” on page 212](#).

## Creating an instance of a regular expression

There are two ways to create a regular expression instance. One way uses forward slash characters (/) to delineate the regular expression; the other uses the `new` constructor. For example, the following regular expressions are equivalent:

```
var pattern1:RegExp = /bob/i;  
var pattern2:RegExp = new RegExp("bob", "i");
```

Forward slashes delineate a regular expression literal in the same way as quotation marks delineate a string literal. The part of the regular expression within the forward slashes defines the *pattern*. The regular expression can also include *flags* after the final delineating slash. These flags are considered to be part of the regular expression, but they are separate from its pattern.

When using the `new` constructor, you use two strings to define the regular expression. The first string defines the pattern, and the second string defines the flags, as in the following example:

```
var pattern2:RegExp = new RegExp("bob", "i");
```

When including a forward slash *within* a regular expression that is defined by using the forward slash delineators, you must precede the forward slash with the backslash (\) escape character. For example, the following regular expression matches the pattern `1/2`:

```
var pattern:RegExp = /1\/2/;
```

To include quotation marks *within* a regular expression that is defined with the `new` constructor, you must add backslash (\) escape character before the quotation marks (just as you would when defining any `String` literal). For example, the following regular expressions match the pattern `eat at "joe's"`:

```
var pattern1:RegExp = new RegExp("eat at \"joe's\"", "");
var pattern2:RegExp = new RegExp('eat at "joe\'s"', "");
```

Do not use the backslash escape character with quotation marks in regular expressions that are defined by using the forward slash delineators. Similarly, do not use the escape character with forward slashes in regular expressions that are defined with the `new` constructor. The following regular expressions are equivalent, and they define the pattern `1/2 "joe's"`:

```
var pattern1:RegExp = /1\2 "joe's"/;
var pattern2:RegExp = new RegExp("1/2 \"joe's\"", "");
var pattern3:RegExp = new RegExp('1/2 "joe\'s"', '');
```

Also, in a regular expression that is defined with the `new` constructor, to use a metasequence that begins with the backslash (`\`) character, such as `\d` (which matches any digit), type the backslash character twice:

```
var pattern:RegExp = new RegExp("\\d+", ""); // matches one or more digits
```

You must type the backslash character twice in this case, because the first parameter of the `RegExp()` constructor method is a string, and in a string literal you must type a backslash character twice to have it recognized as a single backslash character.

The sections that follow describe syntax for defining regular expression patterns.

For more information on flags, see [“Flags and properties” on page 301](#).

## Characters, metacharacters, and metasequences

The simplest regular expression is one that matches a sequence of characters, as in the following example:

```
var pattern:RegExp = /hello/;
```

However, the following characters, known as metacharacters, have special meanings in regular expressions:

```
^ $ \ . * + ? ( ) [ ] { } |
```

For example, the following regular expression matches the letter `A` followed by zero or more instances of the letter `B` (the asterisk metacharacter indicates this repetition), followed by the letter `C`:

```
/AB*C/
```

To include a metacharacter without its special meaning in a regular expression pattern, you must use the backslash (`\`) escape character. For example, the following regular expression matches the letter `A` followed by the letter `B`, followed by an asterisk, followed by the letter `C`:

```
var pattern:RegExp = /AB\C/;
```

A *metasequence*, like a metacharacter, has special meaning in a regular expression. A metasequence is made up of more than one character. The following sections provide details on using metacharacters and metasequences.

## About metacharacters

The following table summarizes the metacharacters that you can use in regular expressions:

Metacharacter	Description
<code>^</code> (caret)	Matches at the start of the string. With the <code>m</code> ( <code>multiline</code> ) flag set, the caret matches the start of a line as well (see <a href="#">“The <code>m</code> (multiline) flag” on page 302</a> ). Note that when used at the start of a character class, the caret indicates negation, not the start of a string. For more information, see <a href="#">“Character classes” on page 293</a> .
<code>\$</code> (dollar sign)	Matches at the end of the string. With the <code>m</code> ( <code>multiline</code> ) flag set, <code>\$</code> matches the position before a newline ( <code>\n</code> ) character as well. For more information, see <a href="#">“The <code>m</code> (multiline) flag” on page 302</a> .
<code>\</code> (backslash)	Escapes the special metacharacter meaning of special characters. Also, use the backslash character if you want to use a forward slash character in a regular expression literal, as in <code>/1\/2/</code> (to match the character 1, followed by the forward slash character, followed by the character 2).
<code>.</code> (dot)	Matches any single character. A dot matches a newline character ( <code>\n</code> ) only if the <code>s</code> ( <code>dotall</code> ) flag is set. For more information, see <a href="#">“The <code>s</code> (dotall) flag” on page 303</a> .
<code>*</code> (star)	Matches the previous item repeated zero or more times. For more information, see <a href="#">“Quantifiers” on page 295</a> .
<code>+</code> (plus)	Matches the previous item repeated one or more times. For more information, see <a href="#">“Quantifiers” on page 295</a> .
<code>?</code> (question mark)	Matches the previous item repeated zero times or one time. For more information, see <a href="#">“Quantifiers” on page 295</a> .
<code>( and )</code>	Defines groups within the regular expression. Use groups for the following: <ul style="list-style-type: none"><li>• To confine the scope of the <code> </code> alternator: <code>/(a b c)d/</code></li><li>• To define the scope of a quantifier: <code>/(walla.){1,2}/</code></li><li>• In backreferences. For example, the <code>\1</code> in the following regular expression matches whatever matched the first parenthetical group of the pattern: <code>/(w*) is repeated: \1/</code> For more information, see <a href="#">“Groups” on page 297</a>.</li></ul>

Metacharacter	Description
[ and ]	<p>Defines a character class, which defines possible matches for a single character:</p> <p><code>/[aeiou]/</code> matches any one of the specified characters.</p> <p>Within character classes, use the hyphen (-) to designate a range of characters:</p> <p><code>/[A-Z0-9]/</code> matches uppercase A through Z or 0 through 9.</p> <p>Within character classes, insert a backslash to escape the ] and - characters:</p> <p><code>/[+\-\]\d+/</code> matches either + or - before one or more digits.</p> <p>Within character classes, other characters, which are normally metacharacters, are treated as normal characters (not metacharacters), without the need for a backslash:</p> <p><code>/[\$£]/</code> matches either \$ or £.</p> <p>For more information, see <a href="#">“Character classes” on page 293</a>.</p>
( <i>pipe</i> )	<p>Used for alternation, to match either the part on the left side or the part on the right side:</p> <p><code>/abc xyz/</code> matches either <code>abc</code> or <code>xyz</code>.</p>

## About metasequences

Metasequences are sequences of characters that have special meaning in a regular expression pattern. The following table describes these metasequences:

Metasequence	Description
{ <i>n</i> }	Specifies a numeric quantifier or quantifier range for the previous item:
{ <i>n</i> , }	<code>/A{27}/</code> matches the character <code>A</code> repeated 27 times.
and	<code>/A{3,}/</code> matches the character <code>A</code> repeated 3 or more times.
{ <i>n</i> , <i>n</i> }	<code>/A{3,5}/</code> matches the character <code>A</code> repeated 3 to 5 times.
	For more information, see <a href="#">“Quantifiers” on page 295</a> .
\b	Matches at the position between a word character and a nonword character. If the first or last character in the string is a word character, also matches the start or end of the string.
\B	Matches at the position between two word characters. Also matches the position between two nonword characters.
\d	Matches a decimal digit.
\D	Matches any character other than a digit.
\f	Matches a form feed character.
\n	Matches the newline character.
\r	Matches the return character.

Metasequence	Description
<code>\s</code>	Matches any white-space character (a space, tab, newline, or return character).
<code>\S</code>	Matches any character other than a white-space character.
<code>\t</code>	Matches the tab character.
<code>\unnnn</code>	Matches the Unicode character with the character code specified by the hexadecimal number <i>nnnn</i> . For example, <code>\u263a</code> is the smiley character.
<code>\v</code>	Matches a vertical feed character.
<code>\w</code>	Matches a word character (A-Z, a-z, 0-9, or <code>_</code> ). Note that <code>\w</code> does not match non-English characters, such as <code>é</code> , <code>ñ</code> , or <code>ç</code> .
<code>\W</code>	Matches any character other than a word character.
<code>\xnn</code>	Matches the character with the specified ASCII value, as defined by the hexadecimal number <i>nn</i> .

## Character classes

You use character classes to specify a list of characters to match one position in the regular expression. You define character classes with square brackets ( `[` and `]` ). For example, the following regular expression defines a character class that matches `bag`, `beg`, `big`, `bog`, or `bug`:

```
/b[aeiou]g/
```

## Escape sequences in character classes

Most metacharacters and metasequences that normally have special meanings in a regular expression *do not* have those same meanings inside a character class. For example, in a regular expression, the asterisk is used for repetition, but this is not the case when the asterisk appears in a character class. The following character class matches the asterisk literally, along with any of the other characters listed:

```
/[abc*123]/
```

However, the three characters listed in the following table do function as metacharacters, with special meaning, in character classes:

Metacharacter	Meaning in character classes
]	Defines the end of the character class.
-	Defines a range of characters (see <a href="#">“Ranges of characters in character classes” on page 294</a> ).
\	Defines metasequences and undoes the special meaning of metacharacters.

For any of these characters to be recognized as literal characters (without the special metacharacter meaning), you must precede the character with the backslash escape character. For example, the following regular expression includes a character class that matches any one of four symbols (`$`, `\`, `]`, or `-`):

```
/[$\\]\-]/
```

In addition to the metacharacters that retain their special meanings, the following metasequences function as metasequences within character classes:

Metasequence	Meaning in character classes
\n	Matches a newline character.
\r	Matches a return character.
\t	Matches a tab character.
\unnnn	Matches the character with the specified Unicode code point value (as defined by the hexadecimal number <i>nnnn</i> ).
\xnn	Matches the character with the specified ASCII value (as defined by the hexadecimal number <i>nn</i> ).

Other regular expression metasequences and metacharacters are treated as normal characters within a character class.

## Ranges of characters in character classes

Use the hyphen to specify a range of characters, such as `A-Z`, `a-z`, or `0-9`. These characters must constitute a valid range in the character set. For example, the following character class matches any one of the characters in the range `a-z` or any digit:

```
/[a-z0-9]/
```

You can also use the `\xnn` ASCII character code to specify a range by ASCII value. For example, the following character class matches any character from a set of extended ASCII characters (such as `é` and `ê`):

```
/[\x80-\x9A]/
```

## Negated character classes

When you use a caret (^) character at the beginning of a character class, it negates that class—any character not listed is considered a match. The following character class matches any character *except* for a lowercase letter (a-z) or a digit:

```
/[^a-z0-9]/
```

You must type the caret (^) character at the *beginning* of a character class to indicate negation. Otherwise, you are simply adding the caret character to the characters in the character class. For example, the following character class matches any one of a number of symbol characters, including the caret:

```
/[!.,#+*%$&^]/
```

## Quantifiers

You use quantifiers to specify repetitions of characters or sequences in patterns, as follows:

Quantifier metacharacter	Description
* (star)	Matches the previous item repeated zero or more times.
+ (plus)	Matches the previous item repeated one or more times.
? (question mark)	Matches the previous item repeated zero times or one time.
{n}	Specifies a numeric quantifier or quantifier range for the previous item:
{n,}	<code>/A{27}/</code> matches the character A repeated 27 times.
and	<code>/A{3,}/</code> matches the character A repeated 3 or more times.
{n,n}	<code>/A{3,5}/</code> matches the character A repeated 3 to 5 times.

You can apply a quantifier to a single character, to a character class, or to a group:

- `/a+/` matches the character a repeated one or more times.
- `/\d+/` matches one or more digits.
- `/[abc]+/` matches a repetition of one or more character, each of which is either a, b, or c.
- `/(very, )*/` matches the word `very` followed by a comma and a space repeated zero or more times.

You can use quantifiers within parenthetical groupings that have quantifiers applied to them. For example, the following quantifier matches strings such as `word` and `word-word-word`:

```
/\w+(-\w+)*/
```

By default, regular expressions perform what is known as *greedy matching*. Any subpattern in the regular expression (such as `.*`) tries to match as many characters in the string as possible before moving forward to the next part of the regular expression. For example, consider the following regular expression and string:

```
var pattern:RegExp = /<p>.*<\p>/;  
str:String = "<p>Paragraph 1</p> <p>Paragraph 2</p>";
```

The regular expression matches the entire string:

```
<p>Paragraph 1</p> <p>Paragraph 2</p>
```

Suppose, however, that you want to match only one `<p>...</p>` grouping. You can do this with the following:

```
<p>Paragraph 1</p>
```

Add a question mark (`?`) after any quantifier to change it to what is known as a *lazy quantifier*.

For example, the following regular expression, which uses the lazy `*?` quantifier, matches `<p>` followed by the minimum number of characters possible (lazy), followed by `</p>`:

```
/<p>.*?<\p>/
```

Keep in mind the following points about quantifiers:

- The quantifiers `{0}` and `{0,0}` do not exclude an item from a match.
- Do not combine multiple quantifiers, as in `/abc+*/`.
- The dot (`.`) does not span lines unless the `s (dotall)` flag is set, even if it is followed by a `*` quantifier. For example, consider the following code:

```
var str:String = "<p>Test\n";  
str += "Multiline</p>";  
var re:RegExp = /<p>.*<\p>/;  
trace(str.match(re)); // null;
```

```
re = /<p>.*<\p>/s;  
trace(str.match(re));  
// output: <p>Test  
//           Multiline</p>
```

For more information, see [“The `s \(dotall\)` flag”](#) on page 303.



## Alternation

Use the | (pipe) character in a regular expression to have the regular expression engine consider alternatives for a match. For example, the following regular expression matches any one of the words `cat`, `dog`, `pig`, `rat`:

```
var pattern:RegExp = /cat|dog|pig|rat/;
```

You can use parentheses to define groups to restrict the scope of the | alternator. The following regular expression matches `cat` followed by `nap` or `nip`:

```
var pattern:RegExp = /cat(nap|nip)/;
```

For more information, see [“Groups” on page 297](#).

The following two regular expressions, one using the | alternator, the other using a character class (defined with [ and ] ), are equivalent:

```
/1|3|5|7|9/  
/[13579]/
```

For more information, see [“Character classes” on page 293](#).

## Groups

You can specify a group in a regular expression by using parentheses, as follows:

```
/class-(\d*)/
```

A group is a subsection of a pattern. You can use groups to do the following things:

- Apply a quantifier to more than one character.
- Delineate subpatterns to be applied with alternation (by using the | character).
- Capture substring matches (for example, by using `\1` in a regular expression to match a previously matched group, or by using `$1` similarly in the `replace()` method of the `String` class).

The following sections provide details on these uses of groups.

### Using groups with quantifiers

If you do not use a group, a quantifier applies to the character or character class that precedes it, as the following shows:

```
var pattern:RegExp = /ab*/ ;  
// matches the character a followed by  
// zero or more occurrences of the character b  
  
pattern = /a\d+/  
// matches the character a followed by  
// one or more digits
```

```
pattern = /a[123]{1,3}/;
// matches the character a followed by
// one to three occurrences of either 1, 2, or 3
```

However, you can use a group to apply a quantifier to more than one character or character class:

```
var pattern:RegExp = /(ab)*;/
// matches zero or more occurrences of the character a
// followed by the character b, such as ababab

pattern = /(a\d)+/;
// matches one or more occurrences of the character a followed by
// a digit, such as ala5a8a3

pattern = /(spam ){1,3}/;
// matches 1 to 3 occurrences of the word spam followed by a space
```

For more information on quantifiers, see [“Quantifiers” on page 295](#).

## Using groups with the alternator (|) character

You can use groups to define the group of characters to which you want to apply an alternator (|) character, as follows:

```
var pattern:RegExp = /cat|dog/;
// matches cat or dog

pattern = /ca(t|d)og/;
// matches catog or cadog
```

## Using groups to capture substring matches

When you define a standard parenthetical group in a pattern, you can later refer to it in the regular expression. This is known as a *backreference*, and these sorts of groups are known as *capturing groups*. For example, in the following regular expression, the sequence `\1` matches whatever substring matched the capturing parenthetical group:

```
var pattern:RegExp = /(\d+)-by-\1/;
// matches the following: 48-by-48
```

You can specify up to 99 of these backreferences in a regular expression by typing `\1, \2, ... , \99`.

Similarly, in the `replace()` method of the `String` class, you can use `$1-$99` to insert captured group substrings matches in the replacement string:

```
var pattern:RegExp = /Hi, (\w+)\./;
var str:String = "Hi, Bob.";
trace(str.replace(pattern, "$1, hello."));
// output: Bob, hello.
```

Also, if you use capturing groups, the `exec()` method of the `RegExp` class and the `match()` method of the `String` class return substrings that match the capturing groups:

```
var pattern:RegExp = /(\w+)@(\w+)\.(\w+)/;
var str:String = "bob@example.com";
trace(pattern.exec(str));
// bob@example.com,bob,example,com
```

## Using noncapturing groups and lookahead groups

A noncapturing group is one that is used for grouping only; it is not “collected,” and it does not match numbered backreferences. Use `(?:` and `)` to define noncapturing groups, as follows:

```
var pattern = /(?:com|org|net);
```

For example, note the difference between putting `(com|org)` in a capturing versus a noncapturing group (the `exec()` method lists capturing groups after the complete match):

```
var pattern:RegExp = /(\w+)@(\w+)\.(com|org)/;
var str:String = "bob@example.com";
trace(pattern.exec(str));
// bob@example.com,bob,example,com

//noncapturing:
var pattern:RegExp = /(\w+)@(\w+)\.(?:com|org)/;
var str:String = "bob@example.com";
trace(pattern.exec(str));
// bob@example.com,bob,example
```

A special type of noncapturing group is the *lookahead group*, of which there are two types: the *positive lookahead group* and the *negative lookahead group*.

Use `(?=` and `)` to define a positive lookahead group, which specifies that the subpattern in the group must match at the position. However, the portion of the string that matches the positive lookahead group can match remaining patterns in the regular expression. For example, because `(?=e)` is a positive lookahead group in the following code, the character `e` that it matches can be matched by a subsequent part of the regular expression—in this case, the capturing group, `\w*`):

```
var pattern:RegExp = /sh(?:e)(\w*)/i;
var str:String = "Shelly sells seashells by the seashore";
trace(pattern.exec(str));
// Shelly,elly
```

Use `(?!` and `)` to define a negative lookahead group that specifies that the subpattern in the group must *not* match at the position. For example:

```
var pattern:RegExp = /sh(?:!e)(\w*)/i;
var str:String = "She sells seashells by the seashore";
trace(pattern.exec(str));
// shore,ore
```

## Using named groups

A named group is a type of group in a regular expression that is given a named identifier. Use `(?P<name>` and `)` to define the named group. For example, the following regular expression includes a named group with the identifier named `digits`:

```
var pattern = /[a-z]+(?P<digits>\d+)[a-z]+/;
```

When you use the `exec()` method, a matching named group is added as a property of the result array:

```
var myPattern:RegExp = /([a-z]+)(?P<digits>\d+)[a-z]+/;
var str:String = "a123bcd";
var result:Array = myPattern.exec(str);
trace(result.digits); // 123
```

Here is another example, which uses two named groups, with the identifiers `name` and `dom`:

```
var emailPattern:RegExp =
    /(?:P<name>(\w|[_.\-])+)@(?:P<dom>((\w|-)+))\.\w{2,4}+;/;
var address:String = "bob@example.com";
var result:Array = emailPattern.exec(address);
trace(result.name); // bob
trace(result.dom); // example
```

**NOTE**

Named groups are not part of the ECMAScript language specification. They are an added feature in ActionScript 3.0.

# Flags and properties

The following table lists the five flags that you can set for regular expressions. Each flag can be accessed as a property of the regular expression object.

Flag	Property	Description
g	global	Matches more than one match.
i	ignoreCase	Case-insensitive matching. Applies to the A–Z and a–z characters, but not to extended characters such as É and é.
m	multiline	With this flag set, \$ and ^ can match the beginning of a line and end of a line, respectively.
s	dotall	With this flag set, . (dot) can match the newline character (\n).
x	extended	Allows extended regular expressions. You can type spaces in the regular expression, which are ignored as part of the pattern. This lets you type regular expression code more legibly.

Note that these properties are read-only. You can set the flags (g, i, m, s, x) when you set a regular expression variable, as follows:

```
var re:RegExp = /abc/gimsx;
```

However, you cannot directly set the named properties. For instance, the following code results in an error:

```
var re:RegExp = /abc/;  
re.global = true; // This generates an error.
```

By default, unless you specify them in the regular expression declaration, the flags are not set, and the corresponding properties are also set to `false`.

Additionally, there are two other properties of a regular expression:

- The `lastIndex` property specifies the index position in the string to use for the next call to the `exec()` or `test()` method of a regular expression.
- The `source` property specifies the string that defines the pattern portion of the regular expression.

## The g (global) flag

When the `g (global)` flag is *not* included, a regular expression matches no more than one match. For example, with the `g` flag not included in the regular expression, the `String.match()` method returns only one matching substring:

```
var str:String = "she sells seashells by the seashore.";  
var pattern:RegExp = /sh\\w*/;  
trace(str.match(pattern)) // output: she
```

When the `g` flag is set, the `String.match()` method returns multiple matches, as follows:

```
var str:String = "she sells seashells by the seashore.";
var pattern:RegExp = /sh\w*/g;
// The same pattern, but this time the g flag IS set.
trace(str.match(pattern)); // output: she,shells,shore
```

## The `i` (`ignoreCase`) flag

By default, regular expression matches are case-sensitive. When you set the `i` (`ignoreCase`) flag, case sensitivity is ignored. For example, the lowercase `s` in the regular expression does not match the uppercase letter `S`, the first character of the string:

```
var str:String = "She sells seashells by the seashore.";
trace(str.search(/sh/)); // output: 13 -- Not the first character
```

With the `i` flag set, however, the regular expression does match the capital letter `S`:

```
var str:String = "She sells seashells by the seashore.";
trace(str.search(/sh/i)); // output: 0
```

The `i` flag ignores case sensitivity only for the `A–Z` and `a–z` characters, but not for extended characters such as `É` and `é`.

## The `m` (`multiline`) flag

If the `m` (`multiline`) flag is not set, the `^` matches the beginning of the string and the `$` matches the end of the string. If the `m` flag is set, these characters match the beginning of a line and end of a line, respectively. Consider the following string, which includes a newline character:

```
var str:String = "Test\n";
str += "Multiline";
trace(str.match(/^w*/g)); // Match a word at the beginning of the string.
```

Even though the `g` (`global`) flag is set in the regular expression, the `match()` method matches only one substring, since there is only one match for the `^`—the beginning of the string. The output is:

```
Test
```

Here is the same code with the `m` flag set:

```
var str:String = "Test\n";
str += "Multiline";
trace(str.match(/^w*/gm)); // Match a word at the beginning of lines.
```

This time, the output includes the words at the beginning of both lines:

```
Test,Multiline
```

Note that only the `\n` character signals the end of a line. The following characters do not:

- Return (`\r`) character
- Unicode line-separator (`\u2028`) character
- Unicode paragraph-separator (`\u2029`) character

## The `s` (dotall) flag

If the `s` (dotall or “dot all”) flag is not set, a dot (`.`) in a regular expression pattern does not match a newline character (`\n`). So for the following example, there is no match:

```
var str:String = "<p>Test\n";
str += "Multiline</p>";
var re:RegExp = /<p>.*?<\p>/;
trace(str.match(re));
```

However, if the `s` flag is set, the dot matches the newline character:

```
var str:String = "<p>Test\n";
str += "Multiline</p>";
var re:RegExp = /<p>.*?<\p>/s;
trace(str.match(re));
```

In this case, the match is the entire substring within the `<p>` tags, including the newline character:

```
<p>Test
Multiline</p>
```

## The `x` (extended) flag

Regular expressions can be difficult to read, especially when they include a lot of metasympols and metasequences. For example:

```
/<p(>|(\s*[^>]*>))\..*?<\p>/gi
```

When you use the `x` (extended) flag in a regular expression, any blank spaces that you type in the pattern are ignored. For example, the following regular expression is identical to the previous example:

```
/ <p (> | (\s* [^>]* >)) \. * ? < \p > / g i x
```

If you have the `x` flag set and do want to match a blank space character, precede the blank space with a backslash. For example, the following two regular expressions are equivalent:

```
/foo bar/
/foo \ bar/x
```

## The lastIndex property

The `lastIndex` property specifies the index position in the string at which to start the next search. This property affects the `exec()` and `test()` methods called on a regular expression that has the `g` flag set to `true`. For example, consider the following code:

```
var pattern:RegExp = /p\w*/gi;
var str:String = "Pedro Piper picked a peck of pickled peppers.";
trace(pattern.lastIndex);
var result:Object = pattern.exec(str);
while (result != null)
{
    trace(pattern.lastIndex);
    result = pattern.exec(str);
}
```

The `lastIndex` property is set to 0 by default (to start searches at the beginning of the string). After each match, it is set to the index position following the match. Therefore, the output for the preceding code is the following:

```
0
5
11
18
25
36
44
```

If the `global` flag is set to `false`, the `exec()` and `test()` methods do not use or set the `lastIndex` property.

The `match()`, `replace()`, and `search()` methods of the `String` class start all searches from the beginning of the string, regardless of the setting of the `lastIndex` property of the regular expression used in the call to the method. (However, the `match()` method does set `lastIndex` to 0.)

You can set the `lastIndex` property to adjust the starting position in the string for regular expression matching.

## The source property

The `source` property specifies the string that defines the pattern portion of a regular expression. For example:

```
var pattern:RegExp = /foo/gi;
trace(pattern.source); // foo
```



# Methods for using regular expressions with strings

The `RegExp` class includes two methods: `exec()` and `test()`.

In addition to the `exec()` and `test()` methods of the `RegExp` class, the `String` class includes the following methods that let you match regular expressions in strings: `match()`, `replace()`, `search()`, and `splice()`.

## The `test()` method

The `test()` method of the `RegExp` class simply checks the supplied string to see if it contains a match for the regular expression, as the following example shows:

```
var pattern:RegExp = /Class-\w/;
var str = "Class-A";
trace(pattern.test(str)); // output: true
```

## The `exec()` method

The `exec()` method of the `RegExp` class checks the supplied string for a match of the regular expression and returns an array with the following:

- The matching substring
- Substring matches for any parenthetical groups in the regular expression

The array also includes an `index` property, indicating the index position of the start of the substring match.

For example, consider the following code:

```
var pattern:RegExp = /\d{3}\-\d{3}-\d{4}/; //U.S phone number
var str:String = "phone: 415-555-1212";
var result:Array = pattern.exec(str);
trace(result.index, " - ", result);
// 7 - 415-555-1212
```

Use the `exec()` method multiple times to match multiple substrings when the `g` (`global`) flag is set for the regular expression:

```
var pattern:RegExp = /\w*sh\w*/gi;
var str:String = "She sells seashells by the seashore";
var result:Array = pattern.exec(str);
```

```
while (result != null)
{
```

```

    trace(result.index, "\t", pattern.lastIndex, "\t", result);
    result = pattern.exec(str);
}
//output:
// 0 3 She
// 10 19 seashells
// 27 35 seashore

```

## String methods that use RegExp parameters

The following methods of the String class take regular expressions as parameters: `match()`, `replace()`, `search()`, and `split()`. For more information on these methods, see [“Finding patterns in strings and replacing substrings” on page 212](#).

## Example: A Wiki parser

This simple Wiki text conversion example illustrates a number of uses for regular expressions:

- Converting lines of text that match a source Wiki pattern to the appropriate HTML output strings.
- Using a regular expression to convert URL patterns to HTML `<a>` hyperlink tags.
- Using a regular expression to convert U.S. dollar strings (such as "\$9.95") to euro strings (such as "8.24 €").

To get the application files for this sample, see [www.adobe.com/go/learn\\_programmingAS3samples\\_flash](http://www.adobe.com/go/learn_programmingAS3samples_flash). The WikiEditor application files can be found in the folder Samples/WikiEditor. The application consists of the following files:

File	Description
WikiEditor.mxml or WikiEditor fla	The main application file in Flash (FLA) or Flex (MXML).
com/example/programmingas3/ regExpExamples/WikiParser.as	A class that includes methods that use regular expressions to convert Wiki input text patterns to the equivalent HTML output.
com/example/programmingas3/ regExpExamples/URLParser.as	A class that includes methods that use regular expressions to convert URL strings to HTML <code>&lt;a&gt;</code> hyperlink tags.
com/example/programmingas3/ regExpExamples/CurrencyConverter.as	A class that includes methods that use regular expressions to convert U.S. dollar strings to euro strings.

## Defining the WikiParser class

The WikiParser class includes methods that convert Wiki input text into the equivalent HTML output. This is not a very robust Wiki conversion application, but it does illustrate some good uses of regular expressions for pattern matching and string conversion.

The constructor function, along with the `setWikiData()` method, simply initializes a sample string of Wiki input text, as follows:

```
public function WikiParser()
{
    wikiData = setWikiData();
}
```

When the user clicks the Test button in the sample application, the application invokes the `parseWikiString()` method of the WikiParser object. This method calls a number of other methods, which in turn assemble the resulting HTML string.

```
public function parseWikiString(wikiString:String):String
{
    var result:String = parseBold(wikiString);
    result = parseItalic(result);
    result = linesToParagraphs(result);
    result = parseBullets(result);
    return result;
}
```

Each of the methods called—`parseBold()`, `parseItalic()`, `linesToParagraphs()`, and `parseBullets()`—uses the `replace()` method of the string to replace matching patterns, defined by a regular expression, in order to transform the input Wiki text into HTML-formatted text.

## Converting boldface and italic patterns

The `parseBold()` method looks for a Wiki boldface text pattern (such as `'''foo'''`) and transforms it into its HTML equivalent (such as `<b>foo</b>`), as follows:

```
private function parseBold(input:String):String
{
    var pattern:RegExp = /'''(?:.*?)'''/g;
    return input.replace(pattern, "<b>$1</b>");
}
```

Note that the `(.*?)` portion of the regular expression matches any number of characters (\*) between the two defining `'''` patterns. The `?` quantifier makes the match nongreedy, so that for a string such as `'''aaa''' bbb '''ccc'''`, the first matched string will be `'''aaa'''` and not the entire string (which starts and ends with the `'''` pattern).

The parentheses in the regular expression define a capturing group, and the `replace()` method refers to this group by using the `$1` code in the replacement string. The `g` (global) flag in the regular expression ensures that the `replace()` method replaces all matches in the string (not simply the first one).

The `parseItalic()` method works similarly to the `parseBold()` method, except that it checks for two apostrophes ( `'` ) as the delimiter for italic text (not three):

```
private function parseItalic(input:String):String
{
    var pattern:RegExp = /'(.*)'/g;
    return input.replace(pattern, "<i>$1</i>");
}
```

## Converting bullet patterns

As the following example shows, the `parseBullet()` method looks for the Wiki bullet line pattern (such as `* foo`) and transforms it into its HTML equivalent (such as `<li>foo</li>`):

```
private function parseBullets(input:String):String
{
    var pattern:RegExp = /^\"(.*)/gm;
    return input.replace(pattern, "<li>$1</li>");
}
```

The `^` symbol at the beginning of the regular expression matches the beginning of a line. The `m` (multiline) flag in the regular expression causes the regular expression to match the `^` symbol against the start of a line, not simply the start of the string.

The `\*` pattern matches an asterisk character (the backslash is used to signal a literal asterisk instead of a `*` quantifier).

The parentheses in the regular expression define a capturing group, and the `replace()` method refers to this group by using the `$1` code in the replacement string. The `g` (global) flag in the regular expression ensures that the `replace()` method replaces all matches in the string (not simply the first one).

## Converting paragraph Wiki patterns

The `linesToParagraphs()` method converts each line in the input Wiki string to an HTML `<p>` paragraph tag. These lines in the method strip out empty lines from the input Wiki string:

```
var pattern:RegExp = /^$/gm;
var result:String = input.replace(pattern, "");
```

The `^` and `$` symbols the regular expression match the beginning and end of a line. The `m` (multiline) flag in the regular expression causes the regular expression to match the `^` symbol against the start of a line, not simply the start of the string.

The `replace()` method replaces all matching substrings (empty lines) with an empty string (`""`). The `g` (global) flag in the regular expression ensures that the `replace()` method replaces all matches in the string (not simply the first one).

## Converting URLs to HTML `<a>` tags

When the user clicks the Test button in the sample application, if the user selected the `urlToATag` check box, the application calls the `URLParser.urlToATag()` static method to convert URL strings from the input Wiki string into HTML `<a>` tags.

```
var protocol:String = "((?:http|ftp)://)";
var urlPart:String = "([a-z0-9_-]+\.[a-z0-9_-]+)";
var optionalUrlPart:String = "(\\.[a-z0-9_-]*)";
var urlPattern:RegExp = new RegExp(protocol + urlPart + optionalUrlPart,
    "ig");
var result:String = input.replace(urlPattern,
    "<a href='$1$2$3'><u>$1$2$3</u></a>");
```

The `RegExp()` constructor function is used to assemble a regular expression (`urlPattern`) from a number of constituent parts. These constituent parts are each strings that define part of the regular expression pattern.

The first part of the regular expression pattern, defined by the `protocol` string, defines an URL protocol: either `http://` or `ftp://`. The parentheses define a noncapturing group, indicated by the `?` symbol. This means that the parentheses are simply used to define a group for the `|` alternation pattern; the group will not match backreference codes (`$1`, `$2`, `$3`) in the replacement string of the `replace()` method.

The other constituent parts of the regular expression each use capturing groups (indicated by parentheses in the pattern), which are then used in the backreference codes (`$1`, `$2`, `$3`) in the replacement string of the `replace()` method.

The part of the pattern defined by the `urlPart` string matches *at least* one of the following characters: `a-z`, `0-9`, `_`, or `-`. The `+` quantifier indicates that at least one character is matched. The `\.` indicates a required dot (`.`) character. And the remainder matches another string of at least one of these characters: `a-z`, `0-9`, `_`, or `-`.

The part of the pattern defined by the `optionalUrlPart` string matches *zero or more* of the following: a dot (`.`) character followed by any number of alphanumeric characters (including `_` and `-`). The `*` quantifier indicates that zero or more characters are matched.

The call to the `replace()` method employs the regular expression and assembles the replacement HTML string, using backreferences.

The `urlToATag()` method then calls the `emailToATag()` method, which uses similar techniques to replace e-mail patterns with HTML `<a>` hyperlink strings. The regular expressions used to match HTTP, FTP, and e-mail URLs in this sample file are fairly simple, for the purposes of exemplification; there are much more complicated regular expressions for matching such URLs more correctly.

## Converting U.S. dollar strings to euro strings

When the user clicks the Test button in the sample application, if the user selected the `dollarToEuro` check box, the application calls the `CurrencyConverter.usdToEuro()` static method to convert U.S. dollar strings (such as "\$9.95") to euro strings (such as "8.24 €"), as follows:

```
var usdPrice:RegExp = /\$([\d,]+\d+)/g;
return input.replace(usdPrice, usdToStrToEuroStr);
```

The first line defines a simple pattern for matching U.S. dollar strings. Notice that the `$` character is preceded with the backslash (`\`) escape character.

The `replace()` method uses the regular expression as the pattern matcher, and it calls the `usdToStrToEuroStr()` function to determine the replacement string (a value in euros).

When a function name is used as the second parameter of the `replace()` method, the following are passed as parameters to the called function:

- The matching portion of the string.
- Any captured parenthetical group matches. The number of arguments passed this way varies depending on the number of captured parenthetical group matches. You can determine the number of captured parenthetical group matches by checking `arguments.length - 3` within the function code.
- The index position in the string where the match begins.
- The complete string.

The `usdToStrToEuroStr()` method converts U.S. dollar string patterns to euro strings, as follows:

```
private function usdToEuro(...args):String
{
    var usd:String = args[1];
    usd = usd.replace(",", "");
    var exchangeRate:Number = 0.828017;
    var euro:Number = Number(usd) * exchangeRate;
    trace(usd, Number(usd), euro);
}
```

```
    const euroSymbol:String = String.fromCharCode(8364); // €
    return euro.toFixed(2) + " " + euroSymbol;
}
```

Note that `args[1]` represents the captured parenthetical group matched by the `usdPrice` regular expression. This is the numerical portion of the U.S. dollar string: that is, the dollar amount without the \$ sign. The method applies an exchange rate conversion and returns the resulting string (with a trailing € symbol instead of a leading \$ symbol).





An event-handling system allows programmers to respond to user input and system events in a convenient way. The ActionScript 3.0 event model is not only convenient, but also standards-compliant, and well integrated with the Adobe Flash Player 9 display list. Based on the Document Object Model (DOM) Level 3 Events Specification, an industry-standard event-handling architecture, the new event model provides a powerful yet intuitive event-handling tool for ActionScript programmers.

This chapter is organized in five sections. The first two sections provide background information about event handling in ActionScript. The last three sections describe the main concepts behind the event model: the event flow, the event object, and event listeners. The ActionScript 3.0 event-handling system interacts closely with the display list, and this chapter assumes that you have a basic understanding of the display list. For more information, see [“Display programming” on page 371](#).

## Contents

Basics of handling events . . . . .	314
How ActionScript 3.0 event handling differs from earlier versions . . . . .	317
The event flow . . . . .	320
Event objects . . . . .	322
Event listeners . . . . .	327
Example: Alarm Clock . . . . .	335

# Basics of handling events

## Introduction to handling events

You can think of events as occurrences of any kind in your SWF file that are of interest to you as a programmer. For example, most SWF files support user interaction of some sort—whether it's something as simple as responding to a mouse click or something more complex, such as accepting and processing data entered into a form. Any such user interaction with your SWF file is considered an event. Events can also occur without any direct user interaction, such as when data has finished loading from a server or when an attached camera has become active.

In ActionScript 3.0, each event is represented by an event object, which is an instance of the Event class or one of its subclasses. An event object not only stores information about a specific event, but also contains methods that facilitate manipulation of the event object. For example, when Flash Player detects a mouse click, it creates an event object (an instance of the MouseEvent class) to represent that particular mouse click event.

After creating an event object, Flash Player *dispatches* it, which means that the event object is passed to the object that is the target of the event. An object that serves as the destination for a dispatched event object is called an *event target*. For example, when an attached camera becomes active, Flash Player dispatches an event object directly to the event target, which in this case is the object that represents the camera. If the event target is on the display list, however, the event object is passed down through the display list hierarchy until it reaches the event target. In some cases, the event object then “bubbles” back up the display list hierarchy along the same route. This traversal of the display list hierarchy is called the *event flow*.

You can “listen” for event objects in your code using event listeners. *Event listeners* are the functions or methods that you write to respond to specific events. To ensure that your program responds to events, you must add event listeners either to the event target or to any display list object that is part of an event object's event flow.

Any time you write event listener code, it follows this basic structure (elements in bold are placeholders you'd fill in for your specific case):

```
function eventResponse(eventObject:EventType):void
{
    // Actions performed in response to the event go here.
}

eventTarget.addEventListener(EventType.EVENT_NAME, eventResponse);
```

This code does two things. First, it defines a function, which is the way to specify the actions that will be performed in response to the event. Next, it calls the `addEventListener()` method of the source object, in essence “subscribing” the function to the specified event so that when the event happens, the function’s actions are carried out. When the event actually happens, the event target checks its list of all the functions and methods that are registered as event listeners. It then calls each one in turn, passing the event object as a parameter.

You need to alter four things in this code to create your own event listener. First, you must change the name of the function to the name you want to use (this must be changed in two places, where the code says `eventResponse`). Second, you must specify the appropriate class name of the event object that is dispatched by the event you want to listen for (`EventType` in the code), and you must specify the appropriate constant for the specific event (`EVENT_NAME` in the listing). Third, you must call the `addEventListener()` method on the object that will dispatch the event (`eventTarget` in this code). Optionally, you can change the name of the variable used as the function’s parameter (`eventObject` in this code).

## Common event-handling tasks

The following are common event-handling tasks, each of which is described in this chapter:

- Writing code to respond to events
- Stopping code from responding to events
- Working with event objects
- Working with event flow:
  - Identifying event flow information
  - Stopping event flow
  - Preventing default behavior
- Dispatching events from your classes
- Creating a custom event type

## Important concepts and terms

The following reference list contains important terms that you will encounter in this chapter:

- **Default behavior:** Some events include a behavior that normally happens along with the event, known as the default behavior. For example, when a user types text in a text field, a text input event is raised. The default behavior for that event is to actually display the character that was typed into the text field—but you can override that default behavior (if for some reason you don’t want the typed character to be displayed).
- **Dispatch:** To notify event listeners that an event has occurred.

- **Event:** Something that happens to an object that the object can tell other objects about.
- **Event flow:** When events happen to an object on the display list (an object displayed on the screen), all the objects that contain the object are notified of the event and notify their event listeners in turn. This process starts with the Stage and proceeds through the display list to the actual object where the event occurred, and then proceeds back to the Stage again. This process is known as the event flow.
- **Event object:** An object that contains information about a particular event's occurrence, which is sent to all listeners when an event is dispatched.
- **Event target:** The object that actually dispatches an event. For example, if the user clicks a button that is inside a Sprite that is in turn inside the Stage, all those objects dispatch events, but the event target is the one where the event actually happened—in this case, the clicked button.
- **Listener:** An object or function that has registered itself with an object, to indicate that it should be notified when a specific event takes place.

## Working through in-chapter examples

As you're working through the chapter, you may want to test some of the example code listings for yourself. Essentially, all the code listings in this chapter include a `trace()` function call for testing the results of the code. To test the code listings in this chapter:

1. Create an empty Flash document.
2. Select a keyframe in the timeline.
3. Open the Actions panel and copy the code listing into the Script pane.
4. Run the program using `Control > Test Movie`.

You will see the results of the code listing's `trace()` functions in the Output panel.

Some of the code listings are more complex and are written as a class. To test these examples:

1. Create an empty Flash document and save it to your computer.
2. Create a new ActionScript file and save it in the same directory as the Flash document. The file's name should match the name of the class in the code listing. For instance, if the code listing defines a class named `EventTest`, use the name `EventTest.as` to save the ActionScript file.
3. Copy the code listing into the ActionScript file and save the file.
4. In the Flash document, click a blank part of the Stage or work space to activate the document Property inspector.

5. In the Property inspector, in the Document Class field, enter the name of the ActionScript class you copied from the text.
6. Run the program using Control > Test Movie  
You will see the results of the example in the Output panel.

These techniques for testing example code listings are explained in more detail in [“Testing in-chapter example code listings” on page 63](#).

## How ActionScript 3.0 event handling differs from earlier versions

The most noticeable difference between event handling in ActionScript 3.0 and event handling in previous versions of ActionScript is that in ActionScript 3.0 there is only one system for event handling, whereas in previous versions of ActionScript there are several different event-handling systems. This section begins with an overview of how event handling worked in previous versions of ActionScript, and then discusses how event handling has changed for ActionScript 3.0.

### Event handling in previous versions of ActionScript

Versions of ActionScript before ActionScript 3.0 provided a number of different ways to handle events:

- `on()` event handlers that can be placed directly on Button and MovieClip instances
- `onClipEvent()` handlers that can be placed directly on MovieClip instances
- Callback function properties, such as `XML.onload` and `Camera.onActivity`
- Event listeners that you register using the `addListener()` method
- The `UIEventDispatcher` class that partially implemented the DOM event model.

Each of these mechanisms presents its own set of advantages and limitations. The `on()` and `onClipEvent()` handlers are easy to use, but make subsequent maintenance of projects more difficult because code placed directly on buttons and movie clips can be difficult to find. Callback functions are also simple to implement, but limit you to only one callback function for any given event. Event listeners are more difficult to implement—they require not only the creation of a listener object and function, but also the registration of the listener with the object that generates the event. This increased overhead, however, enables you to create several listener objects and register them all for the same event.

The development of components for ActionScript 2.0 engendered yet another event model. This new model, embodied in the `UIEventDispatcher` class, was based on a subset of the DOM Events Specification. Developers who are familiar with component event handling will find the transition to the new ActionScript 3.0 event model relatively painless.

Unfortunately, the syntax used by the various event models overlap in various ways, and differ in others. For example, in ActionScript 2.0, some properties, such as `TextField.onChanged`, can be used as either a callback function or an event listener. However, the syntax for registering listener objects differs depending on whether you are using one of the six classes that support listeners or the `UIEventDispatcher` class. For the `Key`, `Mouse`, `MovieClipLoader`, `Selection`, `Stage`, and `TextField` classes, you use the `addListener()` method, but for components event handling, you use a method called `addEventListener()`.

Another complexity introduced by the different event-handling models was that the scope of the event handler function varied widely depending on the mechanism used. In other words, the meaning of the `this` keyword was not consistent among the event-handling systems.

## Event handling in ActionScript 3.0

ActionScript 3.0 introduces a single event-handling model that replaces the many different event-handling mechanisms that existed in previous versions of the language. The new event model is based on the Document Object Model (DOM) Level 3 Events Specification. Although the SWF file format does not adhere specifically to the Document Object Model standard, there are sufficient similarities between the display list and the structure of the DOM to make implementation of the DOM event model possible. An object on the display list is analogous to a node in the DOM hierarchical structure, and the terms *display list object* and *node* are used interchangeably throughout this discussion.

The Flash Player implementation of the DOM event model includes a concept named default behaviors. A *default behavior* is an action that Flash Player executes as the normal consequence of certain events.

### Default behaviors

Developers are usually responsible for writing code that responds to events. In some cases, however, a behavior is so commonly associated with an event that Flash Player automatically executes the behavior unless the developer adds code to cancel it. Because Flash Player automatically exhibits the behavior, such behaviors are called default behaviors.

For example, when a user enters text into a `TextField` object, the expectation that the text will be displayed in that `TextField` object is so common that the behavior is built into Flash Player. If you do not want this default behavior to occur, you can cancel it using the new event-handling system. When a user inputs text into a `TextField` object, Flash Player creates an instance of the `TextEvent` class to represent that user input. To prevent Flash Player from displaying the text in the `TextField` object, you must access that specific `TextEvent` instance and call that instance's `preventDefault()` method.

Not all default behaviors can be prevented. For example, Flash Player generates a `MouseEvent` object when a user double-clicks a word in a `TextField` object. The default behavior, which cannot be prevented, is that the word under the cursor is highlighted.

Many types of event objects do not have associated default behaviors. For example, Flash Player dispatches a connect event object when a network connection is established, but there is no default behavior associated with it. The API documentation for the `Event` class and its subclasses lists each type of event and describes any associated default behavior, and whether that behavior can be prevented.

It is important to understand that default behaviors are associated only with event objects dispatched by Flash Player, and do not exist for event objects dispatched programmatically through `ActionScript`. For example, you can use the methods of the `EventDispatcher` class to dispatch an event object of type `textInput`, but that event object will not have a default behavior associated with it. In other words, Flash Player will not display a character in a `TextField` object as a result of a `textInput` event that you dispatched programmatically.

## What's new for event listeners in ActionScript 3.0

For developers with experience using the `ActionScript 2.0` `addListener()` method, it may be helpful to point out the differences between the `ActionScript 2.0` event listener model and the `ActionScript 3.0` event model. The following list describes a few major differences between the two event models:

- To add event listeners in `ActionScript 2.0`, you use `addListener()` in some cases and `addEventListener()` in others, whereas in `ActionScript 3.0`, you use `addEventListener()` in all situations.
- There is no event flow in `ActionScript 2.0`, which means that the `addListener()` method can be called only on the object that broadcasts the event, whereas in `ActionScript 3.0`, the `addEventListener()` method can be called on any object that is part of the event flow.
- In `ActionScript 2.0`, event listeners can be either functions, methods, or objects, whereas in `ActionScript 3.0`, only functions or methods can be event listeners.

# The event flow

Flash Player dispatches event objects whenever an event occurs. If the event target is not on the display list, Flash Player dispatches the event object directly to the event target. For example, Flash Player dispatches the progress event object directly to a `URLStream` object. If the event target is on the display list, however, Flash Player dispatches the event object into the display list, and the event object travels through the display list to the event target.

The *event flow* describes how an event object moves through the display list. The display list is organized in a hierarchy that can be described as a tree. At the top of the display list hierarchy is the Stage, which is a special display object container that serves as the root of the display list. The Stage is represented by the `flash.display.Stage` class and can only be accessed through a display object. Every display object has a property named `stage` that refers to the Stage for that application.

When Flash Player dispatches an event object, that event object makes a roundtrip journey from the Stage to the *target node*. The DOM Events Specification defines the target node as the node representing the event target. In other words, the target node is the display list object where the event occurred. For example, if a user clicks on a display list object named `child1`, Flash Player will dispatch an event object using `child1` as the target node.

The event flow is conceptually divided into three parts. The first part is called the capture phase; this phase comprises all of the nodes from the Stage to the parent of the target node. The second part is called the target phase, which consists solely of the target node. The third part is called the bubbling phase. The bubbling phase comprises the nodes encountered on the return trip from the parent of the target node back to the Stage.

The names of the phases make more sense if you conceive of the display list as a vertical hierarchy with the Stage at the top, as shown in the following diagram:

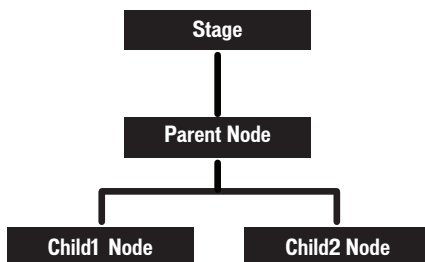



If a user clicks on `Child1 Node`, Flash Player dispatches an event object into the event flow. As the following image shows, the object's journey starts at `Stage`, moves down to `Parent Node`, then moves to `Child1 Node`, and then “bubbles” back up to `Stage`, moving through `Parent Node` again on its journey back to `Stage`.

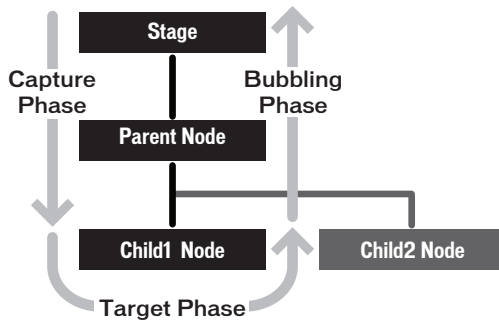

In this example, the capture phase comprises `Stage` and `Parent Node` during the initial downward journey. The target phase comprises the time spent at `Child1 Node`. The bubbling phase comprises `Parent Node` and `Stage` as they are encountered during the upward journey back to the root node.

The event flow contributes to a more powerful event-handling system than that previously available to ActionScript programmers. In previous versions of ActionScript, the event flow does not exist, which means that event listeners can be added only to the object that generates the event. In ActionScript 3.0, you can add event listeners not only to a target node, but also to any node along the event flow.

The ability to add event listeners along the event flow is useful when a user interface component comprises more than one object. For example, a button object often contains a text object that serves as the button's label. Without the ability to add a listener to the event flow, you would have to add a listener to both the button object and the text object to ensure that you receive notification about click events that occur anywhere on the button. The existence of the event flow, however, allows you to place a single event listener on the button object that handles click events that occur either on the text object or on the areas of the button object that are not obscured by the text object.

Not every event object, however, participates in all three phases of the event flow. Some types of events, such as the `enterFrame` and `init` event types, are dispatched directly to the target node and participate in neither the capture phase nor the bubbling phase. Other events may target objects that are not on the display list, such as events dispatched to an instance of the `Socket` class. These event objects will also flow directly to the target object, without participating in the capture and bubbling phases.

To find out how a particular event type behaves, you can either check the API documentation or examine the event object's properties. Examining the event object's properties is described in the following section.

## Event objects

Event objects serve two main purposes in the new event-handling system. First, event objects represent actual events by storing information about specific events in a set of properties. Second, event objects contain a set of methods that allow you to manipulate event objects and affect the behavior of the event-handling system.

To facilitate access to these properties and methods, the Flash Player API defines an `Event` class that serves as the base class for all event objects. The `Event` class defines a fundamental set of properties and methods that are common to all event objects.

This section begins with a discussion of the `Event` class properties, continues with a description of the `Event` class methods, and concludes with an explanation of why subclasses of the `Event` class exist.

## Understanding Event class properties

The `Event` class defines a number of read-only properties and constants that provide important information about an event object. The following are especially important:

- Event object types are represented by constants and stored in the `Event.type` property.
- Whether an event's default behavior can be prevented is represented by a Boolean value and stored in the `Event.cancelable` property.
- Event flow information is contained in the remaining properties.

## Event object types

Every event object has an associated event type. Event types are stored in the `Event.type` property as string values. It is useful to know the type of an event object so that your code can distinguish objects of different types from one another. For example, the following code specifies that the `clickHandler()` listener function should respond to any mouse click event objects that are passed to `myDisplayObject`:

```
myDisplayObject.addEventListener(MouseEvent.CLICK, clickHandler);
```

Some two dozen event types are associated with the `Event` class itself and are represented by `Event` class constants, some of which are shown in the following excerpt from the `Event` class definition:

```

package flash.events
{
    public class Event
    {
        // class constants
        public static const ACTIVATE:String = "activate";
        public static const ADDED:String    = "added";
        // remaining constants omitted for brevity
    }
}

```

These constants provide an easy way to refer to specific event types. You should use these constants instead of the strings they represent. If you misspell a constant name in your code, the compiler will catch the mistake, but if you instead use strings, a typographical error may not manifest at compile time and could lead to unexpected behavior that could be difficult to debug. For example, when adding an event listener, use the following code:

```
myDisplayObject.addEventListener(MouseEvent.CLICK, clickHandler);
```

rather than:

```
myDisplayObject.addEventListener("click", clickHandler);
```

## Default behavior information

Your code can check whether the default behavior for any given event object can be prevented by accessing the `cancelable` property. The `cancelable` property holds a Boolean value that indicates whether or not a default behavior can be prevented. You can prevent, or cancel, the default behavior associated with a small number of events using the `preventDefault()` method. For more information, see [“Cancelling default event behavior” on page 326](#).

## Event flow information

The remaining Event class properties contain important information about an event object and its relationship to the event flow, as described in the following list:

- The `bubbles` property contains information about the parts of the event flow in which the event object participates.
- The `eventPhase` property indicates the current phase in the event flow.
- The `target` property stores a reference to the event target.
- The `currentTarget` property stores a reference to the display list object that is currently processing the event object.

## The bubbles property

An event is said to bubble if its event object participates in the bubbling phase of the event flow, which means that the event object is passed from the target node back through its ancestors until it reaches the Stage. The `Event.bubbles` property stores a Boolean value that indicates whether the event object participates in the bubbling phase. Because all events that bubble also participate in the capture and target phases, any event that bubbles participates in all three of the event flow phases. If the value is `true`, the event object participates in all three phases. If the value is `false`, the event object does not participate in the bubbling phase.

## The eventPhase property

You can determine the event phase for any event object by investigating its `eventPhase` property. The `eventPhase` property contains an unsigned integer value that represents one of the three phases of the event flow. The Flash Player API defines a separate `EventPhase` class that contains three constants that correspond to the three unsigned integer values, as shown in the following code excerpt:

```
package flash.events
{
    public final class EventPhase
    {
        public static const CAPTURING_PHASE:uint = 1;
        public static const AT_TARGET:uint      = 2;
        public static const BUBBLING_PHASE:uint = 3;
    }
}
```

These constants correspond to the three valid values of the `eventPhase` property. You can use these constants to make your code more readable. For example, if you want to ensure that a function named `myFunc()` is called only if the event target is in the target stage, you can use the following code to test for this condition:

```
if (event.eventPhase == EventPhase.AT_TARGET)
{
    myFunc();
}
```

## The target property

The `target` property holds a reference to the object that is the target of the event. In some cases, this is straightforward, such as when a microphone becomes active, the target of the event object is the `Microphone` object. If the target is on the display list, however, the display list hierarchy must be taken into account. For example, if a user inputs a mouse click on a point that includes overlapping display list objects, Flash Player always chooses the object that is farthest away from the Stage as the event target.

For complex SWF files, especially those in which buttons are routinely decorated with smaller child objects, the `target` property may not be used frequently because it will often point to a button's child object instead of the button. In these situations, the common practice is to add event listeners to the button and use the `currentTarget` property because it points to the button, whereas the `target` property may point to a child of the button.

### The `currentTarget` property

The `currentTarget` property contains a reference to the object that is currently processing the event object. Although it may seem odd not to know which node is currently processing the event object that you are examining, keep in mind that you can add a listener function to any display object in that event object's event flow, and the listener function can be placed in any location. Moreover, the same listener function can be added to different display objects. As a project increases in size and complexity, the `currentTarget` property becomes more and more useful.

## Understanding Event class methods

There are three categories of Event class methods:

- Utility methods, which can create copies of an event object or convert it to a string
- Event flow methods, which remove event objects from the event flow
- Default behavior methods, which prevent default behavior or check whether it has been prevented

### Event class utility methods

There are two utility methods in the Event class. The `clone()` method allows you to create copies of an event object. The `toString()` method allows you to generate a string representation of the properties of an event object along with their values. Both of these methods are used internally by the event model system, but are exposed to developers for general use.

For advanced developers creating subclasses of the Event class, you must override and implement versions of both utility methods to ensure that the event subclass will work properly.

## Stopping event flow

You can call either the `Event.stopPropogation()` method or the `Event.stopImmediatePropogation()` method to prevent an event object from continuing on its way through the event flow. The two methods are nearly identical and differ only in whether the current node's other event listeners are allowed to execute:

- The `Event.stopPropogation()` method prevents the event object from moving on to the next node, but only after any other event listeners on the current node are allowed to execute.
- The `Event.stopImmediatePropogation()` method also prevents the event object from moving on to the next node, but does not allow any other event listeners on the current node to execute.

Calling either of these methods has no effect on whether the default behavior associated with an event occurs. Use the default behavior methods of the `Event` class to prevent default behavior.

## Cancelling default event behavior

The two methods that pertain to cancelling default behavior are the `preventDefault()` method and the `isDefaultPrevented()` method. Call the `preventDefault()` method to cancel the default behavior associated with an event. To check whether `preventDefault()` has already been called on an event object, call the `isDefaultPrevented()` method, which returns a value of `true` if the method has already been called and `false` otherwise.

The `preventDefault()` method will work only if the event's default behavior can be cancelled. You can check whether this is the case by referring to the API documentation for that event type, or by using `ActionScript` to examine the `cancelable` property of the event object.

Cancelling the default behavior has no effect on the progress of an event object through the event flow. Use the event flow methods of the `Event` class to remove an event object from the event flow.

## Subclasses of the Event class

For many events, the common set of properties defined in the Event class is sufficient. Other events, however, have unique characteristics that cannot be captured by the properties available in the Event class. For these events, the Flash Player API defines several subclasses of the Event class.

Each subclass provides additional properties and event types that are unique to that category of events. For example, events related to mouse input have several unique characteristics that cannot be captured by the properties defined in the Event class. The MouseEvent class extends the Event class by adding ten properties that contain information such as the location of the mouse event and whether specific keys were pressed during the mouse event.

An Event subclass also contains constants that represent the event types that are associated with the subclass. For example, the MouseEvent class defines constants for several mouse event types, include the `click`, `doubleClick`, `mouseDown`, and `mouseUp` event types.

As described in the section [“Event class utility methods” on page 325](#), when creating an Event subclass you must override the `clone()` and `toString()` methods to provide functionality specific to the subclass.

## Event listeners

Event listeners, which are also called event handlers, are functions that Flash Player executes in response to specific events. Adding an event listener is a two-step process. First, you create a function or class method for Flash Player to execute in response to the event. This is sometimes called the listener function or the event handler function. Second, you use the `addEventListener()` method to register your listener function with the target of the event or any display list object that lies along the appropriate event flow.

## Creating a listener function

The creation of listener functions is one area where the ActionScript 3.0 event model deviates from the DOM event model. In the DOM event model, there is a clear distinction between an event listener and a listener function: an event listener is an instance of a class that implements the `EventListener` interface, whereas a listener function is a method of that class named `handleEvent()`. In the DOM event model, you register the class instance that contains the listener function rather than the actual listener function.

In the ActionScript 3.0 event model, there is no distinction between an event listener and a listener function. ActionScript 3.0 does not have an `EventListener` interface, and listener functions can be defined outside a class or as part of a class. Moreover, listener functions do not have to be named `handleEvent()`—they can be named with any valid identifier. In ActionScript 3.0, you register the name of the actual listener function.

## Listener function defined outside of a class

The following code creates a simple SWF file that displays a red square shape. A listener function named `clickHandler()`, which is not part of a class, listens for mouse click events on the red square.

```
package
{
    import flash.display.Sprite;

    public class ClickExample extends Sprite
    {
        public function ClickExample()
        {
            var child:ChildSprite = new ChildSprite();
            addChild(child);
        }
    }
}

import flash.display.Sprite;
import flash.events.MouseEvent;

class ChildSprite extends Sprite
{
    public function ChildSprite()
    {
        graphics.beginFill(0xFF0000);
        graphics.drawRect(0,0,100,100);
        graphics.endFill();
        addEventListener(MouseEvent.CLICK, clickHandler);
    }
}

function clickHandler(event:MouseEvent):void
{
    trace("clickHandler detected an event of type: " + event.type);
    trace("the this keyword refers to: " + this);
}
```

When a user interacts with the resulting SWF file by clicking on the square, Flash Player generates the following trace output:



```
clickHandler detected an event of type: click
the this keyword refers to: [object global]
```

Notice that the event object is passed as an argument to `clickHandler()`. This allows your listener function to examine the event object. In this example, you use the event object's `type` property to ascertain that the event is a click event.

The example also checks the value of the `this` keyword. In this case, `this` represents the global object, which makes sense because the function is defined outside of any custom class or object.

## Listener function defined as a class method

The following example is identical to the previous example that defines the `ClickExample` class except that the `clickHandler()` function is defined as a method of the `ChildSprite` class:

```
package
{
    import flash.display.Sprite;

    public class ClickExample extends Sprite
    {
        public function ClickExample()
        {
            var child:ChildSprite = new ChildSprite();
            addChild(child);
        }
    }
}

import flash.display.Sprite;
import flash.events.MouseEvent;

class ChildSprite extends Sprite
{
    public function ChildSprite()
    {
        graphics.beginFill(0xFF0000);
        graphics.drawRect(0,0,100,100);
        graphics.endFill();
        addEventListener(MouseEvent.CLICK, clickHandler);
    }
    private function clickHandler(event:MouseEvent):void
    {
        trace("clickHandler detected an event of type: " + event.type);
        trace("the this keyword refers to: " + this);
    }
}
```

When a user interacts with the resulting SWF file by clicking on the red square, Flash Player generates the following trace output:

```
clickHandler detected an event of type: click  
the this keyword refers to: [object ChildSprite]
```

Note that the `this` keyword refers to the `ChildSprite` instance named `child`. This is a change in behavior from ActionScript 2.0. If you used components in ActionScript 2.0, you may remember that when a class method was passed in to

`UIEventDispatcher.addEventListener()`, the scope of the method was bound to the component that broadcast the event instead of the class in which the listener method was defined. In other words, if you used this technique in ActionScript 2.0, the `this` keyword would refer to the component broadcasting the event instead of the `ChildSprite` instance.

This was a significant issue for some programmers because it meant that they could not access other methods and properties of the class containing the listener method. As a workaround, ActionScript 2.0 programmers could use the `mx.util.Delegate` class to change the scope of the listener method. This is no longer necessary, however, because ActionScript 3.0 creates a bound method when `addEventListener()` is called. As a result, the `this` keyword refers to the `ChildSprite` instance named `child`, and the programmer has access to the other methods and properties of the `ChildSprite` class.

## Event listener that should not be used

There is a third technique in which you create a generic object with a property that points to a dynamically assigned listener function, but it is not recommended. It is discussed here because it was commonly used in ActionScript 2.0, but should not be used in ActionScript 3.0. This technique is not recommended because the `this` keyword will refer to the global object instead of your listener object.

The following example is identical to the previous `ClickExample` class example, except that the listener function is defined as part of a generic object named `myListenerObj`:

```
package  
{  
    import flash.display.Sprite;  
  
    public class ClickExample extends Sprite  
    {  
        public function ClickExample()  
        {  
            var child:ChildSprite = new ChildSprite();  
            addChild(child);  
        }  
    }  
}
```

```

import flash.display.Sprite;
import flash.events.MouseEvent;

class ChildSprite extends Sprite
{
    public function ChildSprite()
    {
        graphics.beginFill(0xFF0000);
        graphics.drawRect(0,0,100,100);
        graphics.endFill();
        addEventListener(MouseEvent.CLICK, myListenerObj.clickHandler);
    }
}

var myListenerObj:Object = new Object();
myListenerObj.clickHandler = function (event:MouseEvent):void
{
    trace("clickHandler detected an event of type: " + event.type);
    trace("the this keyword refers to: " + this);
}

```

The results of the trace will look like this:

```

clickHandler detected an event of type: click
the this keyword refers to: [object global]

```

You would expect that this would refer to `myListenerObj` and that the trace output would be `[object Object]`, but instead it refers to the global object. When you pass in a dynamic property name as an argument to `addEventListener()`, Flash Player is unable to create a bound method. This is because what you are passing as the `listener` parameter is nothing more than the memory address of your listener function, and Flash Player has no way to link that memory address with the `myListenerObj` instance.

## Managing event listeners

You can manage your listener functions using the methods of the `IEventDispatcher` interface. The `IEventDispatcher` interface is the ActionScript 3.0 version of the `EventTarget` interface of the DOM event model. Although the name `IEventDispatcher` may seem to imply that its main purpose is to send (or dispatch) event objects, the methods of this class are actually used much more frequently to register event listeners, check for event listeners, and remove event listeners. The `IEventDispatcher` interface defines five methods, as shown in the following code:

```

package flash.events
{
    public interface IEventDispatcher
    {

```

```

function addEventListener(eventName:String,
    listener:Object,
    useCapture:Boolean=false,
    priority:Integer=0,
    useWeakReference:Boolean=false):Boolean;

function removeEventListener(eventName:String,
    listener:Object,
    useCapture:Boolean=false):Boolean;

function dispatchEvent(eventObject:Event):Boolean;

function hasEventListener(eventName:String):Boolean;
function willTrigger(eventName:String):Boolean;
}
}

```

The Flash Player API implements the `IEventDispatcher` interface with the `EventDispatcher` class, which serves as a base class for all classes that can be event targets or part of an event flow. For example, the `DisplayObject` class inherits from the `EventDispatcher` class. This means that any object on the display list has access to the methods of the `IEventDispatcher` interface.

## Adding event listeners

The `addEventListener()` method is the workhorse of the `IEventDispatcher` interface. You use it to register your listener functions. The two required parameters are `type` and `listener`. You use the `type` parameter to specify the type of event. You use the `listener` parameter to specify the listener function that will execute when the event occurs. The `listener` parameter can be a reference to either a function or a class method.

**NOTE**

Do not use parentheses when you specify the `listener` parameter. For example, the `clickHandler()` function is specified without parentheses in the following call to the `addEventListener()` method:  
`addEventListener(MouseEvent.CLICK, clickHandler).`

The `useCapture` parameter of the `addEventListener()` method allows you to control the event flow phase on which your listener will be active. If `useCapture` is set to `true`, your listener will be active during the capture phase of the event flow. If `useCapture` is set to `false`, your listener will be active during the target and bubbling phases of the event flow. To listen for an event during all phases of the event flow, you must call `addEventListener()` twice, once with `useCapture` set to `true`, and then again with `useCapture` set to `false`.

The `priority` parameter of the `addEventListener()` method is not an official part of the DOM Level 3 event model. It is included in ActionScript 3.0 to provide you with more flexibility in organizing your event listeners. When you call `addEventListener()`, you can set the priority for that event listener by passing an integer value as the `priority` parameter. The default value is 0, but you can set it to negative or positive integer values. The higher the number, the sooner that event listener will be executed. Event listeners with the same priority are executed in the order that they were added, so the earlier a listener is added, the sooner it will be executed.

The `useWeakReference` parameter allows you to specify whether the reference to the listener function is weak or normal. Setting this parameter to `true` allows you to avoid situations in which listener functions persist in memory even though they are no longer needed. Flash Player uses a technique called *garbage collection* to clear objects from memory that are no longer in use. An object is considered no longer in use if no references to it exist. The garbage collector disregards weak references, which means that a listener function that has only a weak reference pointing to it is eligible for garbage collection.

One important consequence of this parameter involves working with display objects' events. Normally, you might expect a display object to be removed from memory when it is removed from the display list. However, if other objects have subscribed as listeners to that display object, with the `useWeakReference` parameter set to `false` (the default), the display object will continue to exist in Flash Player's memory even though it no longer appears on the screen. To work around this issue, either have all the listeners subscribe to the display object with the `useWeakReference` parameter set to `true`, or else remove all the event listeners from the display object using the `removeEventListener()` method.

## Removing event listeners

You can use the `removeEventListener()` method to remove an event listener that you no longer need. It is a good idea to remove any listeners that will no longer be used. Required parameters include the `eventName` and `listener` parameters, which are the same as the required parameters for the `addEventListener()` method. Recall that you can listen for events during all event phases by calling `addEventListener()` twice, once with `useCapture` set to `true`, and then again with it set to `false`. To remove both event listeners, you would need to call `removeEventListener()` twice, once with `useCapture` set to `true`, and then again with it set to `false`.

## Dispatching events

The `dispatchEvent()` method can be used by advanced programmers to dispatch a custom event object into the event flow. The only parameter accepted by this method is a reference to an event object, which must be an instance of the `Event` class or a subclass of the `Event` class. Once dispatched, the `target` property of the event object is set to the object on which `dispatchEvent()` was called.

## Checking for existing event listeners

The final two methods of the `IEventDispatcher` interface provide useful information about the existence of event listeners. The `hasEventListener()` method returns `true` if an event listener is found for a specific event type on a particular display list object. The `willTrigger()` method also returns `true` if a listener is found for a particular display list object, but `willTrigger()` checks for listeners not only on that display object, but also on all of that display list object's ancestors for all phases of the event flow.

## Error events without listeners

Exceptions, rather than events, are the primary mechanism for error handling in ActionScript 3.0, but exception handling does not work for asynchronous operations such as loading files. If an error occurs during such an asynchronous operation, Flash Player dispatches an error event object. If you do not create a listener for the error event, the debugger version of Flash Player will bring up a dialog box with information about the error. For example, using an invalid URL when loading a file produces this dialog box in the debugger version of Flash Player:

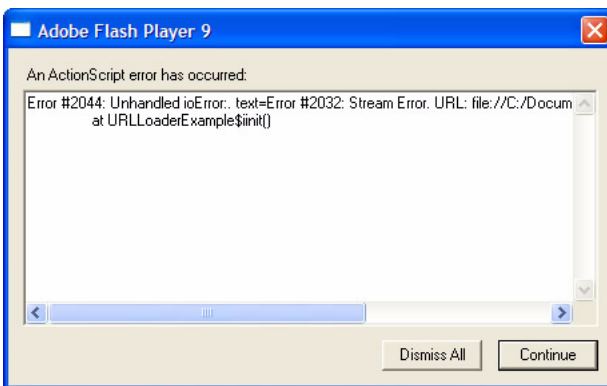

Most error events are based on the `ErrorEvent` class, and as such will have a property named `text` that is used to store the error message that Flash Player displays. The two exceptions are the `StatusEvent` and `NetStatusEvent` classes. Both of these classes have a `level` property (`StatusEvent.level` and `NetStatusEvent.info.level`). When the value of the `level` property is "error", these event types are considered to be error events.

An error event will not cause a SWF file to stop running. It will manifest only as a dialog box on the debugger versions of the browser plug-ins and stand-alone players, as a message in the output panel in the authoring player, and as an entry in the log file for Adobe Flex Builder 2. It will not manifest at all in the release versions of Flash Player.

## Example: Alarm Clock

The Alarm Clock example consists of a clock that allows the user to specify a time at which an alarm will go off, as well as a message to be displayed at that time. The Alarm Clock example builds on the `SimpleClock` application from [Chapter 5, “Working with dates and times.”](#) Alarm Clock illustrates several aspects of working with events in ActionScript 3.0, including:

- Listening and responding to an event
- Notifying listeners of an event
- Creating a custom event type

To get the application files for this sample, see [www.adobe.com/go/learn\\_programmingAS3samples\\_flash](http://www.adobe.com/go/learn_programmingAS3samples_flash). The Alarm Clock application files can be found in the `Samples/AlarmClock` folder. The application includes these files:

File	Description
<code>AlarmClockApp.mxml</code> or <code>AlarmClockApp fla</code>	The main application file in Flash (FLA) or Flex (MXML).
<code>com/example/programmingas3/clock/AlarmClock.as</code>	A class which extends the <code>SimpleClock</code> class, adding alarm clock functionality.
<code>com/example/programmingas3/clock/AlarmEvent.as</code>	A custom event class (a subclass of <code>flash.events.Event</code> ) which serves as the event object for the <code>AlarmClock</code> class's <code>alarm</code> event.
<code>com/example/programmingas3/clock/AnalogClockFace.as</code>	Draws a round clock face and hour, minute, and seconds hands based on the time (described in the <code>SimpleClock</code> example).
<code>com/example/programmingas3/clock/SimpleClock.as</code>	A clock interface component with simple timekeeping functionality (described in the <code>SimpleClock</code> example).

## Alarm Clock overview

The primary functionality of the clock in this example, including tracking the time and displaying the clock face, reuses the SimpleClock application code, which is described in [“Example: Simple analog clock” on page 199](#). The AlarmClock class extends the SimpleClock class from that example by adding the functionality required for an alarm clock, including setting the alarm time and providing notification when the alarm “goes off.”

Providing notification when something happens is the job that events are made for. The AlarmClock class exposes the Alarm event, which other objects can listen for in order to perform desired actions. In addition, the AlarmClock class uses an instance of the Timer class to determine when to trigger its alarm. Like the AlarmClock class, the Timer class provides an event to notify other objects (an AlarmClock instance, in this case) when a certain amount of time has passed. As with most ActionScript applications, events form an important part of the functionality of the Alarm Clock sample application.

## Triggering the alarm

As mentioned previously, the only functionality that the AlarmClock class actually provides relates to setting and triggering the alarm. The built-in Timer class (`flash.utils.Timer`) provides a way for a developer to define code that will be executed after a specified amount of time. The AlarmClock class uses a Timer instance to determine when to set off the alarm.

```
import flash.events.TimerEvent;
import flash.utils.Timer;

/**
 * The Timer that will be used for the alarm.
 */
public var alarmTimer:Timer;
...
/**
 * Instantiates a new AlarmClock of a given size.
 */
public override function initClock(faceSize:Number = 200):void
{
    super.initClock(faceSize);
    alarmTimer = new Timer(0, 1);
    alarmTimer.addEventListener(TimerEvent.TIMER, onAlarm);
}
```



The `Timer` instance defined in the `AlarmClock` class is named `alarmTimer`. The `initClock()` method, which performs necessary setup operations for the `AlarmClock` instance, does two things with the `alarmTimer` variable. First, the variable is instantiated with parameters instructing the `Timer` instance to wait 0 milliseconds and only trigger its timer event one time. After instantiating `alarmTimer`, the code calls that variable's `addEventListener()` method to indicate that it wants to listen to that variable's timer event. A `Timer` instance works by dispatching its timer event after a specified amount of time has passed. The `AlarmClock` class will need to know when the timer event is dispatched in order to set off its own alarm. By calling `addEventListener()`, the `AlarmClock` code registers itself as a listener with `alarmTimer`. The two parameters indicate that the `AlarmClock` class wants to listen for the timer event (indicated by the constant `TimerEvent.TIMER`), and that when the event happens, the `AlarmClock` class's `onAlarm()` method should be called in response to the event.

In order to actually set the alarm, the `AlarmClock` class's `setAlarm()` method is called, as follows:

```
/**
 * Sets the time at which the alarm should go off.
 * @param hour The hour portion of the alarm time.
 * @param minutes The minutes portion of the alarm time.
 * @param message The message to display when the alarm goes off.
 * @return The time at which the alarm will go off.
 */
public function setAlarm(hour:Number = 0, minutes:Number = 0,
message:String = "Alarm!"):Date
{
    this.alarmMessage = message;
    var now:Date = new Date();
    // Create this time on today's date.
    alarmTime = new Date(now.fullYear, now.month, now.date, hour, minutes);

    // Determine if the specified time has already passed today.
    if (alarmTime <= now)
    {
        alarmTime.setTime(alarmTime.time + MILLISECONDS_PER_DAY);
    }

    // Stop the alarm timer if it's currently set.
    alarmTimer.reset();
    // Calculate how many milliseconds should pass before the alarm should
    // go off (the difference between the alarm time and now) and set that
    // value as the delay for the alarm timer.
    alarmTimer.delay = Math.max(1000, alarmTime.time - now.time);
    alarmTimer.start();
}
```

```

        return alarmTime;
    }

```

This method does several things, including storing the alarm message and creating a `Date` object (`alarmTime`) representing the actual moment in time when the alarm is to go off. Of most relevance to the current discussion, in the final several lines of the method, the `alarmTimer` variable's timer is set and activated. First, its `reset()` method is called, stopping the timer and resetting it in case it is already running. Next, the current time (represented by the `now` variable) is subtracted from the `alarmTime` variable's value to determine how many milliseconds need to pass before the alarm goes off. The `Timer` class doesn't trigger its `timer` event at an absolute time, so it is this relative time difference that is assigned to the `delay` property of `alarmTimer`. Finally, the `start()` method is called to actually start the timer.

Once the specified amount of time has passed, `alarmTimer` dispatches the `timer` event. Because the `AlarmClock` class registered its `onAlarm()` method as a listener for that event, when the `timer` event happens, `onAlarm()` is called.

```

/**
 * Called when the timer event is dispatched.
 */
public function onAlarm(event:TimerEvent):void
{
    trace("Alarm!");
    var alarm:AlarmEvent = new AlarmEvent(this.alarmMessage);
    this.dispatchEvent(alarm);
}

```

A method that is registered as an event listener must be defined with the appropriate signature (that is, the set of parameters and return type of the method). To be a listener for the `Timer` class's `timer` event, a method must define one parameter whose data type is `TimerEvent` (`flash.events.TimerEvent`), a subclass of the `Event` class. When the `Timer` instance calls its event listeners, it passes a `TimerEvent` instance as the event object.

## Notifying others of the alarm

Like the `Timer` class, the `AlarmClock` class provides an event that allows other code to receive notifications when the alarm goes off. For a class to use the event-handling framework built into `ActionScript`, that class must implement the `flash.events.IEventDispatcher` interface. Most commonly, this is done by extending the `flash.events.EventDispatcher` class, which provides a standard implementation of `IEventDispatcher` (or by extending one of `EventDispatcher`'s subclasses). As described previously, the `AlarmClock` class extends the `SimpleClock` class, which in turn extends the `Sprite` class, which (through a chain of inheritance) extends the `EventDispatcher` class. All of this means that the `AlarmClock` class already has built-in functionality to provide its own events.

Other code can register to be notified of the `AlarmClock` class's `alarm` event by calling the `addEventListener()` method that `AlarmClock` inherits from `EventDispatcher`. When an `AlarmClock` instance is ready to notify other code that its `alarm` event has been raised, it does so by calling the `dispatchEvent()` method, which is also inherited from `EventDispatcher`.

```
var alarm:AlarmEvent = new AlarmEvent(this.alarmMessage);
this.dispatchEvent(alarm);
```

These lines of code are taken from the `AlarmClock` class's `onAlarm()` method (shown in its entirety previously). The `AlarmClock` instance's `dispatchEvent()` method is called, which in turn notifies all the registered listeners that the `AlarmClock` instance's `alarm` event has been triggered. The parameter that is passed to `dispatchEvent()` is the event object that will be passed along to the listener methods. In this case, it is an instance of the `AlarmEvent` class, an `Event` subclass created specifically for this example.

## Providing a custom alarm event

All event listeners receive an event object parameter with information about the particular event being triggered. In many cases, the event object is an instance of the `Event` class. However, in some cases it is useful to provide additional information to event listeners. As described earlier in the chapter, a common way to accomplish this is to define a new class, a subclass of the `Event` class, and use an instance of that class as the event object. In this example, an `AlarmEvent` instance is used as the event object when the `AlarmClock` class's `alarm` event is dispatched. The `AlarmEvent` class, shown here, provides additional information about the `alarm` event, specifically the alarm message:

```
import flash.events.Event;

/**
 * This custom Event class adds a message property to a basic Event.
 */
public class AlarmEvent extends Event
{
    /**
     * The name of the new AlarmEvent type.
     */
    public static const ALARM:String = "alarm";

    /**
     * A text message that can be passed to an event handler
     * with this event object.
     */
    public var message:String;
```

```

/**
 * Constructor.
 * @param message The text to display when the alarm goes off.
 */
public function AlarmEvent(message:String = "ALARM!")
{
    super(ALARM);
    this.message = message;
}
...
}

```

The best way to create a custom event object class is to define a class that extends the `Event` class, as shown in the preceding example. To supplement the inherited functionality, the `AlarmEvent` class defines a property `message` that contains the text of the alarm message associated with the event; the `message` value is passed in as a parameter in the `AlarmEvent` constructor. The `AlarmEvent` class also defines the constant `ALARM`, which can be used to refer to the specific event (`alarm`) when calling the `AlarmClock` class's `addEventListener()` method.

In addition to adding custom functionality, every `Event` subclass must override the inherited `clone()` method as part of the `ActionScript` event-handling framework. Event subclasses can also optionally override the inherited `toString()` method to include the custom event's properties in the value returned when the `toString()` method is called.

```

/**
 * Creates and returns a copy of the current instance.
 * @return A copy of the current instance.
 */
public override function clone():Event
{
    return new AlarmEvent(message);
}

/**
 * Returns a String containing all the properties of the current
 * instance.
 * @return A string representation of the current instance.
 */
public override function toString():String
{
    return formatToString("AlarmEvent", "type", "bubbles", "cancelable",
    "eventPhase", "message");
}

```

The overridden `clone()` method needs to return a new instance of the custom Event subclass, with all the custom properties set to match the current instance. In the overridden `toString()` method, the utility method `formatToString()` (inherited from Event) is used to provide a string with the name of the custom type, as well as the names and values of all its properties.



ActionScript 3.0 includes a group of classes based on the ECMAScript for XML (E4X) specification (ECMA-357 edition 2). These classes include powerful and easy-to-use functionality for working with XML data. Using E4X, you will be able to develop code with XML data faster than was possible with previous programming techniques. As an added benefit, the code you produce will be easier to read.

This chapter describes how to use E4X to process XML data.

## Contents

Basics of XML .....	344
The E4X approach to XML processing .....	348
XML objects .....	350
XMLList objects .....	353
Initializing XML variables .....	354
Assembling and transforming XML objects .....	356
Traversing XML structures .....	358
Using XML namespaces .....	363
XML type conversion .....	364
Reading external XML documents .....	366
Example: Loading RSS data from the Internet .....	367

# Basics of XML

## Introduction to working with XML

XML is a standard way of representing structured information so that it is easy for computers to work with and reasonably easy for people to write and understand. XML is an abbreviation for eXtensible Markup Language. The XML standard is available at [www.w3.org/XML/](http://www.w3.org/XML/).

XML offers a standard and convenient way to categorize data, to make it easier to read, access, and manipulate. XML uses a tree structure and tag structure that is similar to HTML. Here is a simple example of XML data:

```
<song>
  <title>What you know?</title>
  <artist>Steve and the flubberblubs</artist>
  <year>1989</year>
  <lastplayed>2006-10-17-08:31</lastplayed>
</song>
```

XML data can also be more complex, with tags nested in other tags as well as attributes and other structural components. Here is a more complex example of XML data:

```
<album>
  <title>Questions, unanswered</title>
  <artist>Steve and the flubberblubs</artist>
  <year>1989</year>
  <tracks>
    <song tracknumber="1" length="4:05">
      <title>What do you know?</title>
      <artist>Steve and the flubberblubs</artist>
      <lastplayed>2006-10-17-08:31</lastplayed>
    </song>
    <song tracknumber="2" length="3:45">
      <title>Who do you know?</title>
      <artist>Steve and the flubberblubs</artist>
      <lastplayed>2006-10-17-08:35</lastplayed>
    </song>
    <song tracknumber="3" length="5:14">
      <title>When do you know?</title>
      <artist>Steve and the flubberblubs</artist>
      <lastplayed>2006-10-17-08:39</lastplayed>
    </song>
    <song tracknumber="4" length="4:19">
      <title>Do you know?</title>
      <artist>Steve and the flubberblubs</artist>
      <lastplayed>2006-10-17-08:44</lastplayed>
  </tracks>
</album>
```



```
    </song>
  </tracks>
</album>
```

Notice that this XML document contains other complete XML structures within it (such as the `song` tags with their children). It also demonstrates other XML structures such as attributes (`tracknumber` and `length` in the `song` tags), and tags that contain other tags rather than containing data (such as the `tracks` tag).

## Getting started with XML

If you have little or no experience with XML, here is a brief description of the most common aspects of XML data. XML data is written in plain-text form, with a specific syntax for organizing the information into a structured format. Generally, a single set of XML data is known as an *XML document*. In XML format, data is organized into *elements* (which can be single data items or containers for other elements) using a hierarchical structure. Every XML document has a single element as the top level or main item; inside this root element there may be a single piece of information, although there are more likely to be other elements, which in turn contain other elements, and so forth. For example, this XML document contains the information about a music album:

```
<song tracknumber="1" length="4:05">
  <title>What do you know?</title>
  <artist>Steve and the flubberblubs</artist>
  <mood>Happy</mood>
  <lastplayed>2006-10-17-08:31</lastplayed>
</song>
```

Each element is distinguished by a set of *tags*—the element's name wrapped in angle brackets (less-than and greater-than signs). The opening tag, indicating the start of the element, has the element name:

```
<title>
```

The closing tag, which marks the end of the element, has a forward slash before the element's name:

```
</title>
```

If an element contains no content, it can be written as an empty element (sometimes called a self-closing element). In XML, this element:

```
<lastplayed/>
```

is identical to this element:

```
<lastplayed></lastplayed>
```

In addition to the element's content contained between the opening and closing tags, an element can also include other values, known as *attributes*, defined in the element's opening tag. For example, this XML element defines a single attribute named `length`, with the value "4:19":

```
<song length="4:19"></song>
```

Each XML element has content, which is either a single value, one or more XML elements, or nothing (for an empty element).

## Learning more about XML

To learn more about working with XML, there are a number of additional books and resources for learning more about XML, including these web sites:

- W3Schools XML Tutorial: <http://w3schools.com/xml/>
- XML.com: <http://www.xml.com/>
- XMLpitstop tutorials, discussion lists, and more: <http://xmlpitstop.com/>

## ActionScript classes for working with XML

ActionScript 3.0 includes several classes that are used for working with XML-structured information. The two main classes are as follows:

- XML: Represents a single XML element, which can be an XML document with multiple children or a single-value element within a document.
- XMLList: Represents a set of XML elements. An XMLList object is used when there are multiple XML elements that are "siblings" (at the same level, and contained by the same parent, in the XML document's hierarchy). For instance, an XMLList instance would be the easiest way to work with this set of XML elements (presumably contained in an XML document):

```
<artist type="composer">Fred Wilson</artist>  
<artist type="conductor">James Schmidt</artist>  
<artist type="soloist">Susan Harriet Thurndon</artist>
```

For more advanced uses involving XML namespaces, ActionScript also includes the Namespace and QName classes. For more information, see "Using XML namespaces" on page 363.

In addition to the built-in classes for working with XML, ActionScript 3.0 also includes several operators that provide specific functionality for accessing and manipulating XML data. This approach to working with XML using these classes and operators is known as ECMAScript for XML (E4X), as defined by the ECMA-357 edition 2 specification.

## Common XML tasks

When you work with XML in ActionScript, you are likely to do the following tasks:

- Constructing XML documents (adding elements and values)
- Accessing XML elements, values, and attributes
- Filtering (searching in) XML elements
- Looping over a set of XML elements
- Converting data between XML classes and the String class
- Working with XML namespaces
- Loading external XML files

## Important concepts and terms

The following reference list contains important terms used in this chapter:

- **Element:** A single item in an XML document, identified as the content contained between a starting tag and an ending tag (including the tags). XML elements can contain text data or other elements, or can be empty.
- **Empty element:** An XML element that contains no child elements. Empty elements are often written as self-closing tags (such as `<element/>`).
- **Document:** A single XML structure. An XML document can contain any number of elements (or can consist only of a single empty element); however, an XML document must have a single top-level element that contains all the other elements in the document.
- **Node:** Another name for an XML element.
- **Attribute:** A named value associated with an element that is written into the opening tag of the element in `attributename="value"` format, rather than being written as a separate child element nested inside the element.

## Working through in-chapter examples

As you're working through the chapter, you may want to test some of the example code listings for yourself. Essentially all the code listings in this chapter already include the appropriate `trace()` function call. To test the code listings in this chapter:

1. Create an empty Flash document.
2. Select a keyframe in the timeline.
3. Open the Actions panel and copy the code listing into the Script pane.
4. Run the program using `Control > Test Movie`.

You will see the results of the `trace()` function in the Output panel.

This and other techniques for testing example code listings are described in more detail in “Testing in-chapter example code listings” on page 63.

## The E4X approach to XML processing

The ECMAScript for XML specification defines a set of classes and functionality for working with XML data. These classes and functionality are known collectively as *E4X*. ActionScript 3.0 includes the following E4X classes: XML, XMLList, QName, and Namespace.

The methods, properties, and operators of the E4X classes are designed with the following goals:

- **Simplicity**—Where possible, E4X makes it easier to write and understand code for working with XML data.
- **Consistency**—The methods and reasoning behind E4X are internally consistent and consistent with other parts of ActionScript.
- **Familiarity**—You manipulate XML data with well-known operators, such as the dot (`.`) operator.

NOTE

There was an XML class in ActionScript 2.0. In ActionScript 3.0 it has been renamed XMLDocument, so that it does not conflict with the ActionScript 3.0 XML class that is part of E4X. In ActionScript 3.0, the legacy classes—XMLDocument, XMLNode, XMLParser, and XMLTag—are included in the `flash.xml` package primarily for legacy support. The new E4X classes are core classes; you need not import a package to use them. This chapter does not go into detail on the legacy ActionScript 2.0 XML classes. For details on these, see the [flash.xml](#) package in the *ActionScript 3.0 Language and Components Reference*.

Here is an example of manipulating data with E4X:

```
var myXML:XML =
  <order>
    <item id='1'>
      <menuName>burger</menuName>
      <price>3.95</price>
    </item>
    <item id='2'>
      <menuName>fries</menuName>
      <price>1.45</price>
    </item>
  </order>
```

Often, your application will load XML data from an external source, such as a web service or a RSS feed. However, for clarity, the examples in this chapter assign XML data as literals.

As the following code shows, E4X includes some intuitive operators, such as the dot (.) and attribute identifier (@) operators, for accessing properties and attributes in the XML:

```
trace(myXML.item[0].menuName); // Output: burger
trace(myXML.item.@id==2).menuName); // Output: fries
trace(myXML.item.(menuName=="burger").price); // Output: 3.95
```

Use the `appendChild()` method to assign a new child node to the XML, as the following snippet shows:

```
var newItem:XML =
    <item id="3">
        <menuName>medium cola</menuName>
        <price>1.25</price>
    </item>
```

```
myXML.appendChild(newItem);
```

Use the @ and . operators not only to read data, but also to assign data, as in the following:

```
myXML.item[0].menuName="regular burger";
myXML.item[1].menuName="small fries";
myXML.item[2].menuName="medium cola";

myXML.item.(menuName=="regular burger").@quantity = "2";
myXML.item.(menuName=="small fries").@quantity = "2";
myXML.item.(menuName=="medium cola").@quantity = "2";
```

Use a for loop to iterate through nodes of the XML, as follows:

```
var total:Number = 0;
for each (var property:XML in myXML.item)
{
    var q:int = Number(property.@quantity);
    var p:Number = Number(property.price);
    var itemTotal:Number = q * p;
    total += itemTotal;
    trace(q + " " + property.menuName + " $" + itemTotal.toFixed(2))
}
trace("Total: $", total.toFixed(2));
```

# XML objects

An XML object may represent an XML element, attribute, comment, processing instruction, or text element.

An XML object is classified as having either *simple content* or *complex content*. An XML object that has child nodes is classified as having complex content. An XML object is said to have simple content if it is any one of the following: an attribute, a comment, a processing instruction, or a text node.

For example, the following XML object contains complex content, including a comment and a processing instruction:

```
XML.ignoreComments = false;
XML.ignoreProcessingInstructions = false;
var x1:XML =
    <order>
        <!--This is a comment. -->
        <?PROC_INSTR sample ?>
        <item id='1'>
            <menuName>burger</menuName>
            <price>3.95</price>
        </item>
        <item id='2'>
            <menuName>fries</menuName>
            <price>1.45</price>
        </item>
    </order>
```

As the following example shows, you can now use the `comments()` and `processingInstructions()` methods to create new XML objects, a comment and a processing instruction:

```
var x2:XML = x1.comments()[0];
var x3:XML = x1.processingInstructions()[0];
```

## XML properties

The XML class has five static properties:

- The `ignoreComments` and `ignoreProcessingInstructions` properties determine whether comments or processing instructions are ignored when the XML object is parsed.
- The `ignoreWhitespace` property determines whether white space characters are ignored in element tags and embedded expressions that are separated only by white space characters.
- The `prettyIndent` and `prettyPrinting` properties are used to format the text that is returned by the `toString()` and `toXMLString()` methods of the XML class.

For details on these properties, see the *ActionScript 3.0 Language and Components Reference*.

## XML methods

The following methods allow you to work with the hierarchical structure of XML objects:

- `appendChild()`
- `child()`
- `childIndex()`
- `children()`
- `descendants()`
- `elements()`
- `insertChildAfter()`
- `insertChildBefore()`
- `parent()`
- `prependChild()`

The following methods allow you to work with XML object attributes:

- `attribute()`
- `attributes()`

The following methods allow you to you work with XML object properties:

- `hasOwnProperty()`
- `propertyIsEnumerable()`
- `replace()`
- `setChildren()`

The following methods are for working with qualified names and namespaces:

- `addNamespace()`
- `inScopeNamespaces()`
- `localName()`
- `name()`
- `namespace()`
- `namespaceDeclarations()`
- `removeNamespace()`
- `setLocalName()`
- `setName()`
- `setNamespace()`

The following methods are for working with and determining certain types of XML content:

- `comments()`
- `hasComplexContent()`
- `hasSimpleContent()`
- `nodeKind()`
- `processingInstructions()`
- `text()`

The following methods are for conversion to strings and for formatting XML objects:

- `defaultSettings()`
- `setSettings()`
- `settings()`
- `normalize()`
- `toString()`
- `toXMLString()`

There are a few additional methods:

- `contains()`
- `copy()`
- `valueOf()`
- `length()`

For details on these methods, see the *ActionScript 3.0 Language and Components Reference*.



# XMLList objects

An XMLList instance represents an arbitrary collection of XML objects. It can contain full XML documents, XML fragments, or the results of an XML query.

The following methods allow you to work with the hierarchical structure of XMLList objects:

- `child()`
- `children()`
- `descendants()`
- `elements()`
- `parent()`

The following methods allow you to work with XMLList object attributes:

- `attribute()`
- `attributes()`

The following methods allow you to you work with XMLList properties:

- `hasOwnProperty()`
- `propertyIsEnumerable()`

The following methods are for working with and determining certain types of XML content:

- `comments()`
- `hasComplexContent()`
- `hasSimpleContent()`
- `processingInstructions()`
- `text()`

The following are for conversion to strings and for formatting the XMLList object:

- `normalize()`
- `toString()`
- `toXMLString()`

There are a few additional methods:

- `contains()`
- `copy()`
- `length()`
- `valueOf()`

For details on these methods, see the *ActionScript 3.0 Language and Components Reference*.

For an XMLList object that contains exactly one XML element, you can use all properties and methods of the XML class, because an XMLList with one XML element is treated the same as an XML object. For example, in the following code, because `doc.div` is an XMLList object containing one element, you can use the `appendChild()` method from the XML class:

```
var doc:XML =
    <body>
        <div>
            <p>Hello</p>
        </div>
    </body>;
doc.div.appendChild(<p>World</p>);
```

For a list of XML properties and methods, see [“XML objects” on page 350](#).

## Initializing XML variables

You can assign an XML literal to an XML object, as follows:

```
var myXML:XML =
    <order>
        <item id='1'>
            <menuName>burger</menuName>
            <price>3.95</price>
        </item>
        <item id='2'>
            <menuName>fries</menuName>
            <price>1.45</price>
        </item>
    </order>
```

As the following snippet shows, you can also use the `new` constructor to create an instance of an XML object from a string that contains XML data:

```
var str:String = "<order><item id='1'><menuName>burger</menuName>"
                + "<price>3.95</price></item></order>";
var myXML:XML = new XML(str);
```

If the XML data in the string is not well formed (for example, if a closing tag is missing), you will see a run-time error.

You can also pass data by reference (from other variables) into an XML object, as the following example shows:

```
var tagname:String = "item";
var attributename:String = "id";
var attributevalue:String = "5";
var content:String = "Chicken";
var x:XML = <{tagname} {attributename}={attributevalue}>{content}</
  {tagname}>;
trace(x.toXMLString())
// Output: <item id="5">Chicken</item>
```

To load XML data from a URL, use the `URLLoader` class, as the following example shows:

```
import flash.events.Event;
import flash.net.URLLoader;
import flash.net.URLRequest;

var externalXML:XML;
var loader:URLLoader = new URLLoader();
var request:URLRequest = new URLRequest("xmlFile.xml");
loader.load(request);
loader.addEventListener(Event.COMPLETE, onComplete);

function onComplete(event:Event):void
{
    var loader:URLLoader = event.target as URLLoader;
    if (loader != null)
    {
        externalXML = new XML(loader.data);
        trace(externalXML.toXMLString());
    }
    else
    {
        trace("loader is not a URLLoader!");
    }
}
```

To read XML data from a socket connection, use the `XMLSocket` class. For more information, see the [XMLSocket](#) entry in the *ActionScript 3.0 Language and Components Reference*.

# Assembling and transforming XML objects

Use the `prependChild()` method or the `appendChild()` method to add a property to the beginning or end of an XML object's list of properties, as the following example shows:

```
var x1:XML = <p>Line 1</p>
var x2:XML = <p>Line 2</p>
var x:XML = <body></body>
x = x.appendChild(x1);
x = x.appendChild(x2);
x = x.prependChild(<p>Line 0</p>);
// x == <body><p>Line 0</p><p>Line 1</p><p>Line 2</p></body>
```

Use the `insertChildBefore()` method or the `insertChildAfter()` method to add a property before or after a specified property, as follows:

```
var x:XML =
  <body>
    <p>Paragraph 1</p>
    <p>Paragraph 2</p>
  </body>
var newNode:XML = <p>Paragraph 1.5</p>
x = x.insertChildAfter(x.p[0], newNode)
x = x.insertChildBefore(x.p[2], <p>Paragraph 1.75</p>)
```

As the following example shows, you can also use curly brace operators ( `{` and `}` ) to pass data by reference (from other variables) when constructing XML objects:

```
var ids:Array = [121, 122, 123];
var names:Array = [{"Murphy","Pat"}, {"Thibaut","Jean"}, {"Smith","Vijay"}]
var x:XML = new XML("<employeeList></employeeList>");

for (var i:int = 0; i < 3; i++)
{
  var newnode:XML = new XML();
  newnode =
    <employee id={ids[i]}>
      <last>{names[i][0]}</last>
      <first>{names[i][1]}</first>
    </employee>;

  x = x.appendChild(newnode)
}
```

You can assign properties and attributes to an XML object by using the = operator, as in the following:

```
var x:XML =
  <employee>
    <lastname>Smith</lastname>
  </employee>
x.firstname = "Jean";
x.@id = "239";
```

This sets the XML object `x` to the following:

```
<employee id="239">
  <lastname>Smith</lastname>
  <firstname>Jean</firstname>
</employee>
```

You can use the + and += operators to concatenate XMLList objects:

```
var x1:XML = <a>test1</a>
var x2:XML = <b>test2</b>
var xList:XMLList = x1 + x2;
xList += <c>test3</c>
```

This sets the XMLList object `xList` to the following:

```
<a>test1</a>
<b>test2</b>
<c>test3</c>
```

# Traversing XML structures

One of the powerful features of XML is its ability to provide complex, nested data via a linear string of text characters. When you load data into an XML object, ActionScript parses the data and loads its hierarchical structure into memory (or it sends a run-time error if the XML data is not well formed).

The operators and methods of the XML and XMLList objects make it easy to traverse the structure of XML data.

Use the dot (.) operator and the descendent accessor (..) operator to access child properties of an XML object. Consider the following XML object:

```
var myXML:XML =
  <order>
    <book ISBN="0942407296">
      <title>Baking Extravagant Pastries with Kumquats</title>
      <author>
        <lastName>Contino</lastName>
        <firstName>Chuck</firstName>
      </author>
      <pageCount>238</pageCount>
    </book>
    <book ISBN="0865436401">
      <title>Emu Care and Breeding</title>
      <editor>
        <lastName>Case</lastName>
        <firstName>Justin</firstName>
      </editor>
      <pageCount>115</pageCount>
    </book>
  </order>
```

The object `myXML.book` is an XMLList object containing child properties of the `myXML` object that have the name `book`. These are two XML objects, matching the two `book` properties of the `myXML` object.

The object `myXML..lastName` is an XMLList object containing any descendent properties with the name `lastName`. These are two XML objects, matching the two `lastName` of the `myXML` object.

The object `myXML.book.editor.lastName` is an XMLList object containing any children with the name `lastName` of children with the name `editor` of children with the name `book` of the `myXML` object: in this case, an XMLList object containing only one XML object (the `lastName` property with the value "Case").

## Accessing parent and child nodes

The `parent()` method returns the parent of an XML object.

You can use the ordinal index values of a child list to access specific child objects. For example, consider an XML object `myXML` that has two child properties named `book`. Each child property named `book` has an index number associated with it:

```
myXML.book[0]
myXML.book[1]
```

To access a specific grandchild, you can specify index numbers for both the child and grandchild names:

```
myXML.book[0].title[0]
```

However, if there is only one child of `x.book[0]` that has the name `title`, you can omit the index reference, as follows:

```
myXML.book[0].title
```

Similarly, if there is only one book child of the object `x`, and if that child object has only one title object, you can omit both index references, like this:

```
myXML.book.title
```

You can use the `child()` method to navigate to children with names based on a variable or expression, as the following example shows:

```
var myXML:XML =
    <order>
        <book>
            <title>Dictionary</title>
        </book>
    </order>;

var childName:String = "book";

trace(myXML.child(childName).title) // output: Dictionary
```

## Accessing attributes

Use the @ symbol (the attribute identifier operator) to access attributes in an XML or XMLList object, as shown in the following code:

```
var employee:XML =
    <employee id="6401" code="233">
        <lastName>Wu</lastName>
        <firstName>Erin</firstName>
    </employee>;
trace(employee.@id); // 6401
```

You can use the \* wildcard symbol with the @ symbol to access all attributes of an XML or XMLList object, as in the following code:

```
var employee:XML =
    <employee id="6401" code="233">
        <lastName>Wu</lastName>
        <firstName>Erin</firstName>
    </employee>;
trace(employee.*.toXMLString());
// 6401
// 233
```

You can use the attribute() or attributes() method to access a specific attribute or all attributes of an XML or XMLList object, as in the following code:

```
var employee:XML =
    <employee id="6401" code="233">
        <lastName>Wu</lastName>
        <firstName>Erin</firstName>
    </employee>;
trace(employee.attribute("id")); // 6401
trace(employee.attribute("*").toXMLString());
// 6401
// 233
trace(employee.attributes().toXMLString());
// 6401
// 233
```

Note that you can also use the following syntax to access attributes, as the following example shows:

```
employee.attribute("id")
employee["@id"]
employee.@"id"
```

These are each equivalent to employee.@id. However, the syntax employee.@id is the preferred approach.



## Filtering by attribute or element value

You can use the parentheses operators— ( and ) —to filter elements with a specific element name or attribute value. Consider the following XML object:

```
var x:XML =
  <employeeList>
    <employee id="347">
      <lastName>Zmed</lastName>
      <firstName>Sue</firstName>
      <position>Data analyst</position>
    </employee>
    <employee id="348">
      <lastName>McGee</lastName>
      <firstName>Chuck</firstName>
      <position>Jr. data analyst</position>
    </employee>
  </employeeList>
```

The following expressions are all valid:

- `x.employee.(lastName == "McGee")`—This is the second employee node.
- `x.employee.(lastName == "McGee").firstName`—This is the firstName property of the second employee node.
- `x.employee.(lastName == "McGee").@id`—This is the value of the id attribute of the second employee node.
- `x.employee.@id == 347`—The first employee node.
- `x.employee.@id == 347).lastName`—This is the lastName property of the first employee node.
- `x.employee.@id > 300`—This is an XMLList with both employee properties.
- `x.employee.(position.toString().search("analyst") > -1)`—This is an XMLList with both position properties.

If you try to filter on attributes or elements that may not exist, Adobe Flash Player will throw an exception. For example, the final line of following code generates an error, because there is no id attribute in the second p element:

```
var doc:XML =
  <body>
    <p id='123'>Hello, <b>Bob</b>.</p>
    <p>Hello.</p>
  </body>;
trace(doc.p.@id == '123');
```

Similarly, the final line of following code generates an error because there is no `b` property of the second `p` element:

```
var doc:XML =
    <body>
        <p id='123'>Hello, <b>Bob</b>.</p>
        <p>Hello.</p>
    </body>;
trace(doc.p.(b == 'Bob'));
```

To avoid these errors, you can identify the properties that have the matching attributes or elements by using the `attribute()` and `elements()` methods, as in the following code:

```
var doc:XML =
    <body>
        <p id='123'>Hello, <b>Bob</b>.</p>
        <p>Hello.</p>
    </body>;
trace(doc.p.(attribute('id') == '123'));
trace(doc.p.(elements('b') == 'Bob'));
```

You can also use the `hasOwnProperty()` method, as in the following code:

```
var doc:XML =
    <body>
        <p id='123'>Hello, <b>Bob</b>.</p>
        <p>Hello.</p>
    </body>;
trace(doc.p.(hasOwnProperty('@id') && @id == '123'));
trace(doc.p.(hasOwnProperty('b') && b == 'Bob'));
```

## Using the `for..in` and the `for each..in` statements

ActionScript 3.0 includes the `for..in` statement and the `for each..in` statement for iterating through `XMLList` objects. For example, consider the following XML object, `myXML`, and the `XMLList` object, `myXML.item`. The `XMLList` object, `myXML.item`, consists of the two `item` nodes of the XML object.

```
var myXML:XML =
    <order>
        <item id='1' quantity='2'>
            <menuName>burger</menuName>
            <price>3.95</price>
        </item>
        <item id='2' quantity='2'>
            <menuName>fries</menuName>
            <price>1.45</price>
        </item>
    </order>;
```

The `for..in` statement lets you iterate over a set of property names in an `XMLList`:

```
var total:Number = 0;
for (var pname:String in myXML.item)
{
    total += myXML.item.@quantity[pname] * myXML.item.price[pname];
}
```

The `for each..in` statement lets you iterate through the properties in the `XMLList`:

```
var total2:Number = 0;
for each (var prop:XML in myXML.item)
{
    total2 += prop.@quantity * prop.price;
}
```

## Using XML namespaces

Namespaces in an XML object (or document) identify the type of data that the object contains. For example, in sending and delivering XML data to a web service that uses the SOAP messaging protocol, you declare the namespace in the opening tag of the XML:

```
var message:XML =
    <soap:Envelope xmlns:soap="http://schemas.xmlsoap.org/soap/envelope/"
        soap:encodingStyle="http://schemas.xmlsoap.org/soap/encoding/">
        <soap:Body xmlns:w="http://www.test.com/weather/">
            <w:getWeatherResponse>
                <w:tempurature >78</w:tempurature>
            </w:getWeatherResponse>
        </soap:Body>
    </soap:Envelope>;
```

The namespace has a prefix, `soap`, and a URI that defines the namespace, `http://schemas.xmlsoap.org/soap/envelope/`.

ActionScript 3.0 includes the `Namespace` class for working with XML namespaces. For the XML object in the previous example, you can use the `Namespace` class as follows:

```
var soapNS:Namespace = message.namespace("soap");
trace(soapNS); // Output: http://schemas.xmlsoap.org/soap/envelope/

var wNS:Namespace = new Namespace("w", "http://www.test.com/weather/");
message.addNamespace(wNS);
var encodingStyle:XMLList = message.@soapNS::encodingStyle;
var body:XMLList = message.soapNS::Body;

message.soapNS::Body.wNS::GetWeatherResponse.wNS::tempurature = "78";
```

The XML class includes the following methods for working with namespaces:

```
addNamespace(), inScopeNamespaces(), localName(), name(), namespace(),  
namespaceDeclarations(), removeNamespace(), setLocalName(), setName(), and  
setNamespace().
```

The default `xml namespace` directive lets you assign a default namespace for XML objects.

For example, in the following, both `x1` and `x2` have the same default namespace:

```
var ns1:Namespace = new Namespace("http://www.example.com/namespaces/");  
default xml namespace = ns1;  
var x1:XML = <test1 />;  
var x2:XML = <test2 />;
```

## XML type conversion

You can convert XML objects and XMLList objects to String values. Similarly, you can convert strings to XML objects and XMLList objects. Also, keep in mind that all XML attribute values, names, and text values are strings. The following sections discuss all these forms of XML type conversion.

### Converting XML and XMLList objects to strings

The XML and XMLList classes include a `toString()` method and a `toXMLString()` method. The `toXMLString()` method returns a string that includes all tags, attributes, namespace declarations, and content of the XML object. For XML objects with complex content (child elements), the `toString()` method does exactly the same as the `toXMLString()` method. For XML objects with simple content (those that contain only one text element), the `toString()` method returns only the text content of the element, as the following example shows:

```
var myXML:XML =  
    <order>  
        <item id='1' quantity='2'>  
            <menuName>burger</menuName>  
            <price>3.95</price>  
        </item>  
    </order>;  
  
trace(myXML.item[0].menuName.toXMLString());  
// <menuName>burger</menuName>  
trace(myXML.item[0].menuName.toString());  
// burger
```

If you use the `trace()` method without specifying `toString()` or `toXMLString()`, the data is converted using the `toString()` method by default, as this code shows:

```
var myXML:XML =
    <order>
        <item id='1' quantity='2'>
            <menuName>burger</menuName>
            <price>3.95</price>
        </item>
    </order>;

trace(myXML.item[0].menuName);
// burger
```

When using the `trace()` method to debug code, you will often want to use the `toXMLString()` method so that the `trace()` method outputs more complete data.

## Converting strings to XML objects

You can use the new `XML()` constructor to create an XML object from a string, as follows:

```
var x:XML = new XML("<a>test</a>");
```

If you attempt to convert a string to XML from a string that represents invalid XML or XML that is not well formed, a run-time error is thrown, as follows:

```
var x:XML = new XML("<a>test"); // throws an error
```

## Converting attribute values, names, and text values from strings

All XML attribute values, names, and text values are `String` data types, and you may need to convert these to other data types. For example, the following code uses the `Number()` function to convert text values to numbers:

```
var myXML:XML =
    <order>
        <item>
            <price>3.95</price>
        </item>
        <item>
            <price>1.00</price>
        </item>
    </order>;
```

```

var total:XML = <total>0</total>;
myXML.appendChild(total);

for each (var item:XML in myXML.item)
{
    myXML.total.children()[0] = Number(myXML.total.children()[0])
                                + Number(item.price.children()[0]);
}
trace(myXML.total); // 4.35;

```

If this code did not use the `Number()` function, the code would interpret the `+` operator as the string concatenation operator, and the `trace()` method in the last line would output the following:

```
01.003.95
```

## Reading external XML documents

You can use the `URLLoader` class to load XML data from a URL. To use the following code in your applications, replace the `XML_URL` value in the example with a valid URL:

```

var myXML:XML = new XML();
var XML_URL:String = "http://www.example.com/Sample3.xml";
var myXMLURL:URLRequest = new URLRequest(XML_URL);
var myLoader:URLLoader = new URLLoader(myXMLURL);
myLoader.addEventListener("complete", xmlLoaded);

function xmlLoaded(event:Event):void
{
    myXML = XML(myLoader.data);
    trace("Data loaded.");
}

```

You can also use the `XMLSocket` class to set up an asynchronous XML socket connection with a server. For more information, see the *ActionScript 3.0 Language and Components Reference*.

# Example: Loading RSS data from the Internet

The RSSViewer sample application shows a number of features of working with XML in ActionScript, including the following:

- Using XML methods to traverse XML data in the form of an RSS feed.
- Using XML methods to assemble XML data in the form of HTML to use in a text field.

The RSS format is widely used to syndicate news via XML. A simple RSS data file may look like the following:

```
<?xml version="1.0" encoding="UTF-8" ?>
<rss version="2.0" xmlns:dc="http://purl.org/dc/elements/1.1/">
<channel>
  <title>Alaska - Weather</title>
  <link>http://www.nws.noaa.gov/alerts/ak.html</link>
  <description>Alaska - Watches, Warnings and Advisories</description>

  <item>
    <title>
      Short Term Forecast - Taiya Inlet, Klondike Highway (Alaska)
    </title>
    <link>
      http://www.nws.noaa.gov/alerts/ak.html#A18.AJKNK.1900
    </link>
    <description>
      Short Term Forecast Issued At: 2005-04-11T19:00:00
      Expired At: 2005-04-12T01:00:00 Issuing Weather Forecast Office
      Homepage: http://pajk.arh.noaa.gov
    </description>
  </item>
  <item>
    <title>
      Short Term Forecast - Haines Borough (Alaska)
    </title>
    <link>
      http://www.nws.noaa.gov/alerts/ak.html#AKZ019.AJKNOWAJK.190000
    </link>
    <description>
      Short Term Forecast Issued At: 2005-04-11T19:00:00
      Expired At: 2005-04-12T01:00:00 Issuing Weather Forecast Office
      Homepage: http://pajk.arh.noaa.gov
    </description>
  </item>
</channel>
</rss>
```

The SimpleRSS application reads RSS data from the Internet, parses the data for headlines (titles), links, and descriptions, and returns that data. The SimpleRSSUI class provides the UI and calls the SimpleRSS class, which does all of the XML processing.

To get the application files for this sample, see [www.adobe.com/go/learn\\_programmingAS3samples\\_flash](http://www.adobe.com/go/learn_programmingAS3samples_flash). The RSSViewer application files can be found in the folder Samples/RSSViewer. The application consists of the following files:

---

File	Description
RSSViewer.mxml or RSSViewer fla	The main application file in Flash (FLA) or Flex (MXML).
com/example/programmingas3/rssViewer/ RSSParser.as	A class that contains methods that use E4X to traverse RSS (XML) data and generate a corresponding HTML representation.
RSSData/ak.rss	A sample RSS file. The application is set up to read RSS data from the web, at a Flex RSS feed hosted by Adobe. However, you can easily change the application to read RSS data from this document, which uses a slightly different schema than that of the Flex RSS feed.

---

## Reading and parsing XML data

The RSSParser class includes an `xmlLoaded()` method that converts the input RSS data, stored in the `rssXML` variable, into a string containing HTML-formatted output, `rssOutput`.

Near the beginning of the method, code sets the default XML namespace if the source RSS data includes a default namespace:

```
if (rssXML.namespace("") != undefined)
{
    default xml namespace = rssXML.namespace("");
}
```

The next lines then loop through the contents of the source XML data, examining each descendant property named `item`:

```
for each (var item:XML in rssXML..item)
{
```



```

    var itemTitle:String = item.title.toString();
    var itemDescription:String = item.description.toString();
    var itemLink:String = item.link.toString();
    outXML += buildItemHTML(itemTitle,
        itemDescription,
        itemLink);
}

```

The first three lines simply set string variables to represent the title, description and link properties of the `item` property of the XML data. The next line then calls the `buildItemHTML()` method to get HTML data in the form of an `XMLList` object, using the three new string variables as parameters.

## Assembling XMLList data

The HTML data (an `XMLList` object) is of the following form:

```

<b>itemTitle</b>
<p>
  itemDescription
  <br />
  <a href="link">
    <font color="#008000">More...</font>
  </a>
</p>

```

The first lines of the method clear the default `xml` namespace:

```
default xml namespace = new Namespace();
```

The default `xml namespace` directive has function block-level scope. This means that the scope of this declaration is the `buildItemHTML()` method.

The lines that follow assemble the `XMLList`, based on the string arguments passed to the function:

```

var body:XMLList = new XMLList();
body += new XML("<b>" + itemTitle + "</b>");
var p:XML = new XML("<p>" + itemDescription + "</p>");

var link:XML = <a></a>;
link.@href = itemLink; // <link href="itemLinkString"></link>
link.font.@color = "#008000";
    // <font color="#008000"></font></a>
    // 0x008000 = green
link.font = "More...";

p.appendChild(<br/>);
p.appendChild(link);
body += p;

```

This XMLList object represents string data suitable for an ActionScript HTML text field.

The `xmlLoaded()` method uses the return value of the `buildItemHTML()` method and converts it to a string:

```
XML.prettyPrinting = false;  
rssOutput = outXML.toXMLString();
```

## Extracting the title of the RSS feed and sending a custom event

The `xmlLoaded()` method sets a `rssTitle` string variable, based on information in the source RSS XML data:

```
rssTitle = rssXML.channel.title.toString();
```

Finally, the `xmlLoaded()` method generates an event, which notifies the application that the data is parsed and available:

```
dataWritten = new Event("dataWritten", true);
```

Display programming in ActionScript 3.0 allows you to work with elements that appear on the Stage of Adobe Flash Player 9. This chapter describes the basic concepts for working with on-screen elements. You'll learn the details about programmatically organizing visual elements. You'll also learn about creating your own custom classes for display objects.

## Contents

Basics of display programming .....	372
Core display classes .....	377
Advantages of the display list approach .....	379
Working with display objects .....	382
Manipulating display objects .....	395
Masking display objects .....	414
Animating objects .....	416
Example: SpriteArranger .....	423

# Basics of display programming

## Introduction to display programming

Each application built with ActionScript 3.0 has a hierarchy of displayed objects known as the *display list*. The display list contains all the visible elements in the application. Display elements fall into one or more of the following groups:

- The Stage

The Stage is the base container of display objects. Each application has one Stage object, which contains all on-screen display objects. The Stage is the top-level container and is at the top of the display list hierarchy:

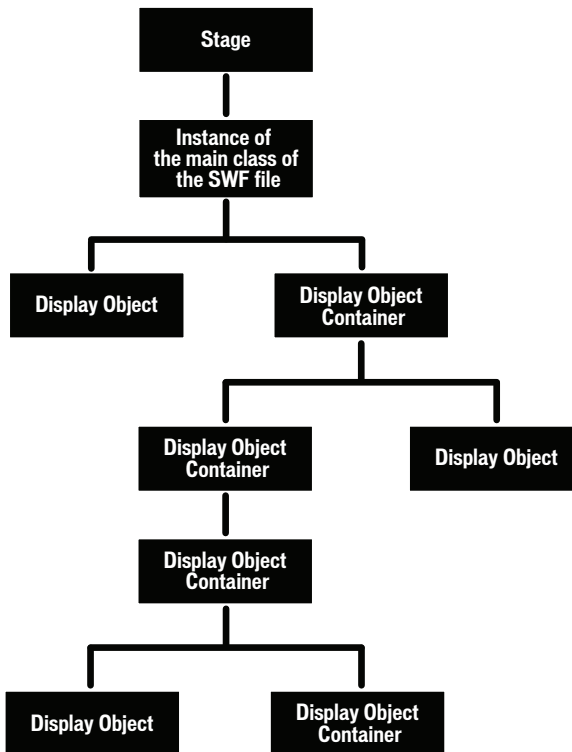

Each SWF file has an associated ActionScript class, known as *the main class of the SWF file*. When Flash Player opens a SWF file in an HTML page, Flash Player calls the constructor function for that class and the instance that is created (which is always a type of display object) is added as a child of the Stage object. The main class of a SWF file always extends the Sprite class (for more information, see [“Advantages of the display list approach” on page 379](#)).

You can access the Stage through the `stage` property of any DisplayObject instance. For more information, see [“Setting Stage properties” on page 389](#).

- Display objects

In ActionScript 3.0, all elements that appear on screen in an application are types of *display objects*. The `flash.display` package includes a DisplayObject class, which is a base class extended by a number of other classes. These different classes represent different types of display objects, such as vector shapes, movie clips, and text fields, to name a few. For an overview of these classes, see [“Advantages of the display list approach” on page 379](#).

- Display object containers

Display object containers are special types of display objects that, in addition to having their own visual representation, can also contain child objects that are also display objects. The DisplayObjectContainer class is a subclass of the DisplayObject class. A DisplayObjectContainer object can contain multiple display objects in its *child list*. For example, the following illustration shows a type of DisplayObjectContainer object known as a Sprite that contains various display objects:

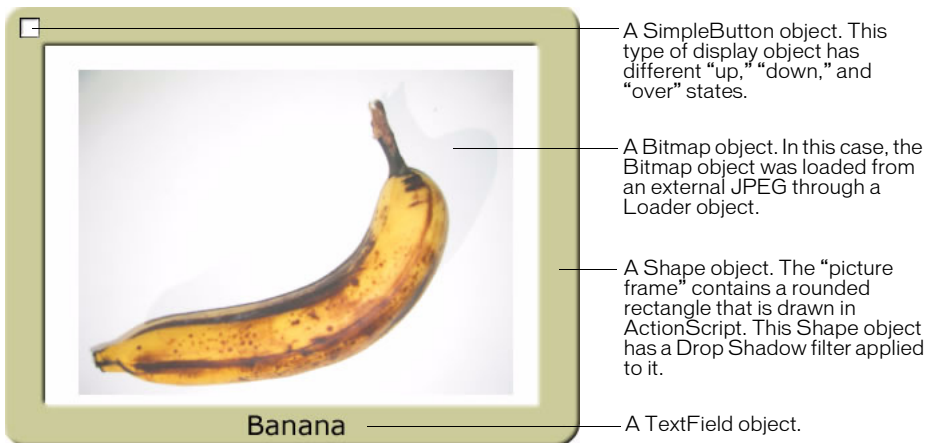

In the context of discussing display objects, DisplayObjectContainer objects are also known as *display object containers* or simply *containers*.

Although all visible display objects inherit from the `DisplayObject` class, the type of each is of a specific subclass of `DisplayObject` class. For example, there is a constructor function for the `Shape` class or the `Video` class, but there is no constructor function for the `DisplayObject` class.

As noted earlier, the `Stage` is a display object container.

## Common display programming tasks

Since so much of ActionScript programming involves creating and manipulating visual elements, there are numerous tasks that are related to display programming. This chapter describes common tasks that apply to all display objects, including:

- Working with the display list and display object containers
  - Adding display objects to the display list
  - Removing objects from the display list
  - Moving objects among display containers
  - Moving objects in front of or behind other objects
- Working with the `Stage`
  - Setting the frame rate
  - Controlling `Stage` scaling
  - Working with full-screen mode
- Handling display object events
- Positioning display objects, including creating drag-and-drop interaction
- Resizing, scaling, and rotating display objects
- Applying blending modes, color transformations, and transparency to display objects
- Masking display objects
- Animating display objects
- Loading external display content (such as SWF files or images)

Later chapters in this manual describe additional tasks for working with display objects. These tasks include both tasks that apply to any display object and tasks associated with specific types of display objects:

- Drawing vector graphics with ActionScript on display objects, described in [Chapter 14](#), “Using the drawing API,” on page 447
- Applying geometric transformations to display objects, described in [Chapter 13](#), “Working with geometry,” on page 431

- Applying graphical filter effects such as blur, glow, drop shadow and more to display objects, described in [Chapter 15, “Filtering display objects,”](#) on page 465
- Working with MovieClip-specific characteristics, described in [Chapter 16, “Working with movie clips,”](#) on page 491
- Working with TextField objects, described in [Chapter 17, “Working with text,”](#) on page 509
- Working with bitmap graphics, described in [Chapter 18, “Working with bitmaps,”](#) on page 539
- Working with video elements, described in [Chapter 19, “Working with video,”](#) on page 555

## Important concepts and terms

The following reference list contains important terms that you will encounter in this chapter:

- Alpha: The color value representing the amount of transparency (or more correctly, the amount of opacity) in a color. For example, a color with an alpha channel value of 60% only shows 60% of its full strength, and is 40% transparent.
- Bitmap graphic: A graphic that is defined in the computer as a grid (rows and columns) of colored pixels. Commonly bitmap graphics include digital photos and similar images.
- Blending mode: A specification of how the contents of two overlapping images should interact. Commonly an opaque image on top of another image simply blocks the image underneath so that it isn't visible at all; however, different blending modes cause the colors of the images to blend together in different ways so the resulting content is some combination of the two images.
- Display list: The hierarchy of display objects that will be rendered as visible screen content by Flash Player. The Stage is the root of the display list, and all the display objects that are attached to the Stage or one of its children form the display list (even if the object isn't actually rendered, for example if it's outside the boundaries of the Stage).
- Display object: An object which represents some type of visual content in Flash Player. Only display objects can be included in the display list, and all display object classes are subclasses of the DisplayObject class.
- Display object container: A special type of display object which can contain child display objects in addition to (generally) having its own visual representation.
- Main class of the SWF file: The class that defines the behavior for the outermost display object in a SWF file, which conceptually is the class for the SWF file itself. For instance, a SWF created in Flash authoring has a “main timeline” which contains all other timelines; the main class of the SWF file is the class of which the main timeline is an instance.

- **Masking:** A technique of hiding from view certain parts of an image (or conversely, only allowing certain parts of an image to display). The hidden portions of the image become transparent, so content underneath shows through. The term is related to painter’s masking tape that is used to prevent paint from being applied to certain areas.
- **Stage:** The visual container that is the base or background of all visual content in a SWF.
- **Transformation:** An adjustment to a visual characteristic of a graphic, such as rotating the object, altering its scale, skewing or distorting its shape, or altering its color.
- **Vector graphic:** A graphic that is defined in the computer as lines and shapes drawn with particular characteristics (such as thickness, length, size, angle, and position).

## Working through in-chapter examples

As you’re working through the chapter, you may want to test some of the example code listings for yourself. Because this chapter is about creating and manipulating visual content, essentially all the code listings in this chapter create visual objects and display them on the screen; testing the sample will involve viewing the result in Flash Player rather than viewing values of variables as in previous chapters. To test the code listings in this chapter:

1. Create an empty Flash document.
2. Select a keyframe in the Timeline.
3. Open the Actions panel and copy the code listing into the Script pane.
4. Run the program using Control > Test Movie.

You will see the results of the code displayed on the screen, and any `trace()` function calls will display in the Output panel.

Techniques for testing example code listings are explained in more detail in [“Testing in-chapter example code listings” on page 63](#).



# Core display classes

The ActionScript 3.0 `flash.display` package includes classes for visual objects that can appear in Flash Player. The following illustration shows the subclass relationships of these core display object classes.

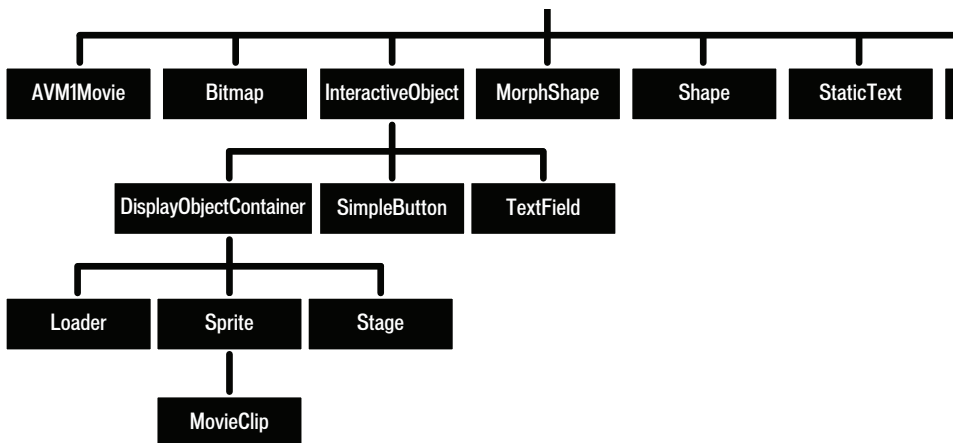

The illustration shows the class inheritance of display object classes. Note that some of these classes, specifically `StaticText`, `TextField`, and `Video`, are not in the `flash.display` package, but they still inherit from the `DisplayObject` class.

All classes that extend the `DisplayObject` class inherit its methods and properties. For more information, see [“Properties and methods of the DisplayObject class” on page 382](#).

You can instantiate objects of the following classes contained in the `flash.display` package:

- **Bitmap**—You use the `Bitmap` class to define bitmap objects, either loaded from external files or rendered through ActionScript. You can load bitmaps from external files through the `Loader` class. You can load GIF, JPG, or PNG files. You can also create a `BitmapData` object with custom data and then create a `Bitmap` object that uses that data. You can use the methods of the `BitmapData` class to alter bitmaps, whether they are loaded or created in ActionScript. For more information, see [“Loading display objects” on page 419](#) and [Chapter 18, “Working with bitmaps,” on page 539](#).
- **Loader**—You use the `Loader` class to load external assets (either SWF files or graphics). For more information, see [“Loading display content dynamically” on page 418](#).
- **Shape**—You use the `Shape` class to create vector graphics, such as rectangles, lines, circles, and so on. For more information, see [Chapter 14, “Using the drawing API,” on page 447](#).
- **SimpleButton**—A `SimpleButton` object is the ActionScript representation of a Flash button symbol. A `SimpleButton` instance has three button states: up, down, and over.

- **Sprite**—A Sprite object can contain graphics of its own, and it can contain child display objects. (The Sprite class extends the DisplayObjectContainer class). For more information, see [“Working with display object containers” on page 383](#) and [Chapter 14, “Using the drawing API,” on page 447](#).
- **MovieClip**—A MovieClip object is the ActionScript form of a movie clip symbol created in Flash authoring. In practice, a MovieClip is similar to a Sprite object, except that it also has a timeline. For more information, see [Chapter 16, “Working with movie clips,” on page 491](#).

The following classes, which are not in the flash.display package, are subclasses of the DisplayObject class:

- The TextField class, included in the flash.text package, is a display object for text display and input. For more information, see [Chapter 17, “Working with text,” on page 509](#).
- The Video class, included in the flash.media package, is the display object used for displaying video files. For more information, see [Chapter 19, “Working with video,” on page 555](#).

The following classes in the flash.display package extend the DisplayObject class, but you cannot create instances of them. Instead, they serve as parent classes for other display objects, combining common functionality into a single class.

- **AVM1Movie**—The AVM1Movie class is used to represent loaded SWF files that are authored in ActionScript 1.0 and 2.0.
- **DisplayObjectContainer**—The Loader, Stage, Sprite, and MovieClip classes each extend the DisplayObjectContainer class. For more information, see [“Working with display object containers” on page 383](#).
- **InteractiveObject**—InteractiveObject is the base class for all objects used to interact with the mouse and keyboard. SimpleButton, TextField, Video, Loader, Sprite, Stage, and MovieClip objects are all subclasses of the InteractiveObject class. For more information on creating mouse and keyboard interaction, see [Chapter 21, “Capturing user input,” on page 631](#).
- **MorphShape**—These objects are created when you create a shape tween in the Flash authoring tool. You cannot instantiate them using ActionScript, but they can be accessed from the display list.
- **Stage**—The Stage class extends the DisplayObjectContainer class. There is one Stage instance for an application, and it is at the top of the display list hierarchy. To access the Stage, use the `stage` property of any DisplayObject instance. For more information, see [“Setting Stage properties” on page 389](#).

Also, the `StaticText` class, in the `flash.text` package, extends the `DisplayObject` class, but you cannot create an instance of it in code. Static text fields are created only in Adobe Flash CS3 Professional.

## Advantages of the display list approach

In ActionScript 3.0, there are separate classes for different types of display objects. In ActionScript 1.0 and 2.0, many of the same types of objects are all included in one class: the `MovieClip` class.

This individualization of classes and the hierarchical structure of display lists have the following benefits:

- More efficient rendering and reduced memory usage
- Improved depth management
- Full traversal of the display list
- Off-list display objects
- Easier subclassing of display objects

These benefits are described in the next sections.

### More efficient rendering and smaller file sizes

In ActionScript 1.0 and 2.0, you could draw shapes only in a `MovieClip` object. In ActionScript 3.0, there are simpler display object classes in which you can draw shapes. Because these ActionScript 3.0 display object classes do not include the full set of methods and properties that a `MovieClip` object includes, they are less taxing on memory and processor resources.

For example, each `MovieClip` object includes properties for the timeline of the movie clip, whereas a `Shape` object does not. The properties for managing the timeline can use a lot of memory and processor resources. In ActionScript 3.0, using the `Shape` object results in better performance. The `Shape` object has less overhead than the more complex `MovieClip` object. Flash Player does not need to manage unused `MovieClip` properties, which improves speed and reduces the memory footprint the object uses.

## Improved depth management

In ActionScript 1.0 and 2.0, depth was managed through a linear depth management scheme and methods such as `getNextHighestDepth()`.

ActionScript 3.0 includes the `DisplayObjectContainer` class, which has more convenient methods and properties for managing the depth of display objects.

In ActionScript 3.0, when you move a display object to a new position in the child list of a `DisplayObjectContainer` instance, the other children in the display object container are repositioned automatically and assigned appropriate child index positions in the display object container.

Also, in ActionScript 3.0 it is always possible to discover all of the child objects of any display object container. Every `DisplayObjectContainer` instance has a `numChildren` property, which lists the number of children in the display object container. And since the child list of a display object container is always an indexed list, you can examine every object in the list from index position 0 through the last index position (`numChildren - 1`). This was not possible with the methods and properties of a `MovieClip` object in ActionScript 1.0 and 2.0.

In ActionScript 3.0, you can easily traverse the display list sequentially; there are no gaps in the index numbers of a child list of a display object container. Traversing the display list and managing the depth of objects is much easier than was possible in ActionScript 1.0 and 2.0. In ActionScript 1.0 and 2.0, a movie clip could contain objects with intermittent gaps in the depth order, which could make it difficult to traverse the list of object. In ActionScript 3.0, each child list of a display object container is cached internally as an array, resulting in very fast lookups (by index). Looping through all children of a display object container is also very fast.

In ActionScript 3.0, you can also access children in a display object container by using the `getChildByName()` method of the `DisplayObjectContainer` class.

## Full traversal of the display list

In ActionScript 1.0 and 2.0, you could not access some objects, such as vector shapes, that were drawn in the Flash authoring tool. In ActionScript 3.0, you can access all objects on the display list—both those created using ActionScript and all display objects created in the Flash authoring tool. For details, see [“Traversing the display list” on page 387](#).

## Off-list display objects

In ActionScript 3.0, you can create display objects that are not on the visible display list. These are known as *off-list* display objects. A display object is added to the visible display list only when you call the `addChild()` or `addChildAt()` method of a `DisplayObjectContainer` instance that has already been added to the display list.

You can use off-list display objects to assemble complex display objects, such as those that have multiple display object containers containing multiple display objects. By keeping display objects off-list, you can assemble complicated objects without using the processing time to render these display objects. You can then add an off-list display object to the display list when it is needed. Also, you can move a child of a display object container on and off the display list and to any desired position in the display list at will.

## Easier subclassing of display objects

In ActionScript 1.0 and 2.0, you would often have to add new `MovieClip` objects to a SWF file to create basic shapes or to display bitmaps. In ActionScript 3.0, the `DisplayObject` class includes many built-in subclasses, including `Shape` and `Bitmap`. Because the classes in ActionScript 3.0 are more specialized for specific types of objects, it is easier to create basic subclasses of the built-in classes.

For example, in order to draw a circle in ActionScript 2.0, you could create a `CustomCircle` class that extends the `MovieClip` class when an object of the custom class is instantiated. However, that class would also include a number of properties and methods from the `MovieClip` class (such as `totalFrames`) that do not apply to the class. In ActionScript 3.0, however, you can create a `CustomCircle` class that extends the `Shape` object, and as such does not include the unrelated properties and methods that are contained in the `MovieClip` class. The following code shows an example of a `CustomCircle` class:

```
import flash.display.*;

private class CustomCircle extends Shape
{
```

```

var xPos:Number;
var yPos:Number;
var radius:Number;
var color:uint;
public function CustomCircle(xInput:Number,
                             yInput:Number,
                             rInput:Number,
                             colorInput:uint)
{
    xPos = xInput;
    yPos = yInput;
    radius = rInput;
    color = colorInput;
    this.graphics.beginFill(color);
    this.graphics.drawCircle(xPos, yPos, radius);
}
}

```

## Working with display objects

Now that you understand the basic concepts of the Stage, display objects, display object containers, and the display list, this section provides you with some more specific information about working with display objects in ActionScript 3.0.

### Properties and methods of the DisplayObject class

All display objects are subclasses of the DisplayObject class, and as such they inherit the properties and methods of the DisplayObject class. The properties inherited are basic properties that apply to all display objects. For example, each display object has an *x* property and a *y* property that specifies the object's position in its display object container.

You cannot create a DisplayObject instance using the DisplayObject class constructor. You must create another type of object (an object that is a subclass of the DisplayObject class), such as a Sprite, to instantiate an object with the *new* operator. Also, if you want to create a custom display object class, you must create a subclass of one of the display object subclasses that has a usable constructor function (such as the Shape class or the Sprite class). For more information, see the DisplayObject class description in the *ActionScript 3.0 Language and Components Reference*.

## Adding display objects to the display list

When you instantiate a display object, it will not appear on-screen (on the Stage) until you add the display object instance to a display object container that is on the display list. For example, in the following code, the `myText` `TextField` object would not be visible if you omitted the last line of code. In the last line of code, the `this` keyword must refer to a display object container that is already added to the display list.

```
import flash.display.*;
import flash.text.TextField;
var myText:TextField = new TextField();
myText.text = "Buenos dias.";
this.addChild(myText);
```

When you add any visual element to the Stage, that element becomes a *child* of the Stage object. The first SWF file loaded in an application (for example, the one that you embed in an HTML page) is automatically added as a child of the Stage. It can be an object of any type that extends the `Sprite` class.

Any display objects that you create *without* using ActionScript—for example, by adding an MXML tag in Adobe Flex Builder 2 or by placing an item on the Stage in Flash—are added to the display list. Although you do not add these display objects through ActionScript, you can access them through ActionScript. For example, the following code adjusts the width of an object named `button1` that was added in the authoring tool (not through ActionScript):

```
button1.width = 200;
```

## Working with display object containers

If a `DisplayObjectContainer` object is deleted from the display list, or if it is moved or transformed in some other way, each display object in the `DisplayObjectContainer` is also deleted, moved, or transformed.

A display object container is itself a type of display object—it can be added to another display object container. For example, the following image shows a display object container, `pictureScreen`, that contains one outline shape and four other display object containers (of type `PictureFrame`):

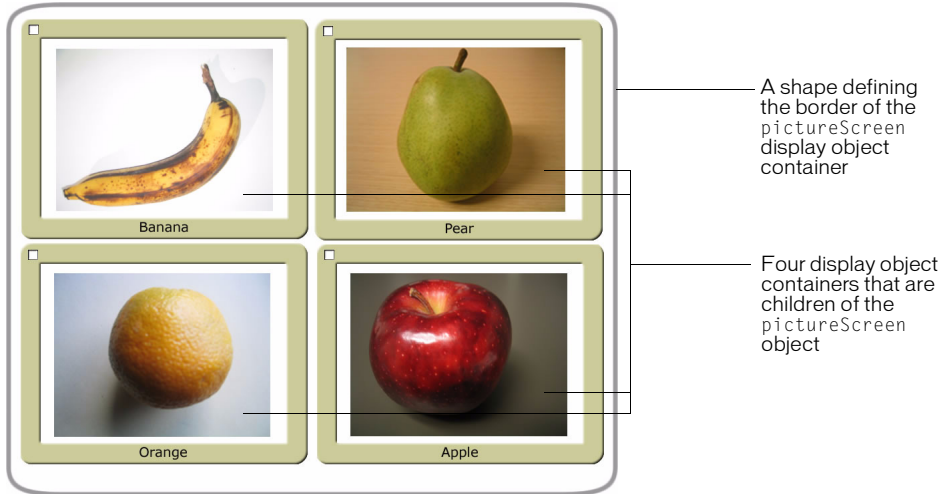

In order to have a display object appear in the display list, you must add it to a display object container that is on the display list. You do this by using the `addChild()` method or the `addChildAt()` method of the container object. For example, without the final line of the following code, the `myTextField` object would not be displayed:

```
var myTextField:TextField = new TextField();  
myTextField.text = "hello";  
this.root.addChild(myTextField);
```

In this code sample, `this.root` points to the `MovieClip` display object container that contains the code. In your actual code, you may specify a different container.

Use the `addChildAt()` method to add the child to a specific position in the child list of the display object container. These zero-based index positions in the child list relate to the layering (the front-to-back order) of the display objects. For example, consider the following three display objects. Each object was created from a custom class called `Ball`.





The layering of these display objects in their container can be adjusted using the `addChildAt()` method. For example, consider the following code:

```
ball_A = new Ball(0xFFCC00, "a");
ball_A.name = "ball_A";
ball_A.x = 20;
ball_A.y = 20;
container.addChild(ball_A);

ball_B = new Ball(0xFFCC00, "b");
ball_B.name = "ball_B";
ball_B.x = 70;
ball_B.y = 20;
container.addChild(ball_B);

ball_C = new Ball(0xFFCC00, "c");
ball_C.name = "ball_C";
ball_C.x = 40;
ball_C.y = 60;
container.addChildAt(ball_C, 1);
```

After executing this code, the display objects are positioned as follows in the `container DisplayObjectContainer` object. Notice the layering of the objects.



To reposition an object to the top of the display list, simply re-add it to the list. For example, after the previous code, to move `ball_A` to the top of the stack, use this line of code:

```
container.addChild(ball_A);
```

This code effectively removes `ball_A` from its location in `container`'s display list, and re-adds it to the top of the list—which has the end result of moving it to the top of the stack.

You can use the `getChildAt()` method to verify the layer order of the display objects. The `getChildAt()` method returns child objects of a container based on the index number you pass it. For example, the following code reveals names of display objects at different positions in the child list of the `container DisplayObjectContainer` object:

```
trace(container.getChildAt(0).name); // ball_A
trace(container.getChildAt(1).name); // ball_C
trace(container.getChildAt(2).name); // ball_B
```

If you remove a display object from the parent container's child list, the higher elements on the list each move down a position in the child index. For example, continuing with the previous code, the following code shows how the display object that was at position 2 in the container `DisplayObjectContainer` moves to position 1 if a display object that is lower in the child list is removed:

```
container.removeChild(ball_C);
trace(container.getChildAt(0).name); // ball_A
trace(container.getChildAt(1).name); // ball_B
```

The `removeChild()` and `removeChildAt()` methods do not delete a display object instance entirely. They simply remove it from the child list of the container. The instance can still be referenced by another variable. (Use the `delete` operator to completely remove an object.)

Because a display object has only one parent container, you can add an instance of a display object to only one display object container. For example, the following code shows that the display object `tf1` can exist in only one container (in this case, a `Sprite`, which extends the `DisplayObjectContainer` class):

```
tf1:TextField = new TextField();
tf2:TextField = new TextField();
tf1.name = "text 1";
tf2.name = "text 2";

container1:Sprite = new Sprite();
container2:Sprite = new Sprite();

container1.addChild(tf1);
container1.addChild(tf2);
container2.addChild(tf1);

trace(container1.numChildren); // 1
trace(container1.getChildAt(0).name); // text 2
trace(container2.numChildren); // 1
trace(container2.getChildAt(0).name); // text 1
```

If you add a display object that is contained in one display object container to another display object container, it is removed from the first display object container's child list.

In addition to the methods described above, the `DisplayObjectContainer` class defines several methods for working with child display objects, including the following:

- `contains()`: Determines whether a display object is a child of a `DisplayObjectContainer`.
- `getChildByName()`: Retrieves a display object by name.
- `getChildIndex()`: Returns the index position of a display object.
- `setChildIndex()`: Changes the position of a child display object.

- `swapChildren()`: Swaps the front-to-back order of two display objects.
- `swapChildrenAt()`: Swaps the front-to-back order of two display objects, specified by their index values.

For more information, see the relevant entries in the *ActionScript 3.0 Language and Components Reference*.

Recall that a display object that is off the display list—one that is not included in a display object container that is a child of the Stage—is known as an *off-list* display object.

## Traversing the display list

As you've seen, the display list is a tree structure. At the top of the tree is the Stage, which can contain multiple display objects. Those display objects that are themselves display object containers can contain other display objects, or display object containers.

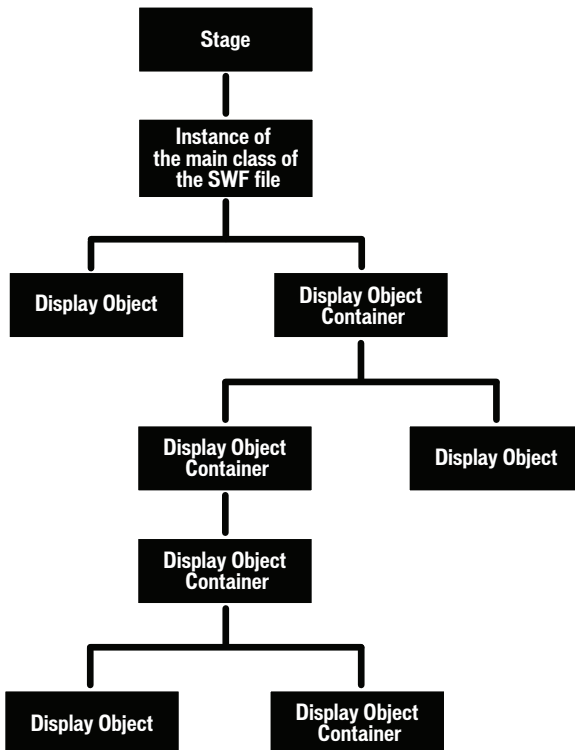

The `DisplayObjectContainer` class includes properties and methods for traversing the display list, by means of the child lists of display object containers. For example, consider the following code, which adds two display objects, `title` and `pict`, to the container object (which is a `Sprite`, and the `Sprite` class extends the `DisplayObjectContainer` class):

```
var container:Sprite = new Sprite();
var title:TextField = new TextField();
title.text = "Hello";
var pict:Loader = new Loader();
var url:URLRequest = new URLRequest("banana.jpg");
pict.load(url);
pict.name = "banana loader";
container.addChild(title);
container.addChild(pict);
```

The `getChildAt()` method returns the child of the display list at a specific index position:

```
trace(container.getChildAt(0) is TextField); // true
```

You can also access child objects by name. Each display object has a name property, and if you don't assign it, Flash Player assigns a default value, such as `instance1`. For example, the following code shows how to use the `getChildByName()` method to access a child display object with the name `"banana loader"`:

```
trace(container.getChildByName("banana loader") is Loader); // true
```

Using the `getChildByName()` method can result in slower performance than using the `getChildAt()` method.

Since a display object container can contain other display object containers as child objects in its display list, you can traverse the full display list of the application as a tree. For example, in the code excerpt shown earlier, once the load operation for the `pict Loader` object is complete, the `pict` object will have one child display object, which is the bitmap, loaded. To access this bitmap display object, you can write `pict.getChildAt(0)`. You can also write `container.getChildAt(0).getChildAt(0)` (since `container.getChildAt(0) == pict`).

The following function provides an indented `trace()` output of the display list from a display object container:

```
function traceDisplayList(container:DisplayObjectContainer,
                          indentString:String = ""):void
{
    var child:DisplayObject;
    for (var i:uint=0; i < container.numChildren; i++)
    {
        child = container.getChildAt(i);
        trace(indentString, child, child.name);
        if (container.getChildAt(i) is DisplayObjectContainer)
        {
```

```
        traceDisplayList(DisplayObjectContainer(child), indentString + "")
    }
}
```

## Setting Stage properties

The Stage class overrides most properties and methods of the DisplayObject class. If you call one of these overridden properties or methods, Flash Player throws an exception. For example, the Stage object does not have `x` or `y` properties, since its position is fixed as the main container for the application. The `x` and `y` properties refer to the position of a display object relative to its container, and since the Stage is not contained in another display object container, these properties do not apply.

### NOTE

Some properties and methods of the Stage class are not available to display objects that are not in the same security sandbox as the first SWF file loaded. For details, see [“Stage security” on page 781](#).

## Controlling the playback frame rate

The `framerate` property of the Stage class is used to set the frame rate for all SWF files loaded into the application. For more information, see the *ActionScript 3.0 Language and Components Reference*.

## Controlling Stage scaling

When a Flash Player screen is resized, Flash Player automatically adjusts the Stage contents to compensate. The Stage class’s `scaleMode` property determines how the Stage contents are adjusted. This property can be set to four different values, defined as constants in the `flash.display.StageScaleMode` class.

For three of the `scaleMode` values (`StageScaleMode.EXACT_FIT`, `StageScaleMode.SHOW_ALL`, and `StageScaleMode.NO_BORDER`), Flash Player will scale the contents of the Stage to fit within its boundaries. The three options differ in determining how the scaling is accomplished:

- `StageScaleMode.EXACT_FIT` scales the SWF proportionally.
- `StageScaleMode.SHOW_ALL` determines whether a border appears, like the black bars that appear when viewing a wide-screen movie on a standard television.
- `StageScaleMode.NO_BORDER` determines whether the content can be partially cropped or not.

Alternatively, if `scaleMode` is set to `StageScaleMode.NO_SCALE`, the Stage contents maintain their defined size when the viewer resizes the Flash Player window. In this scale mode only, the `width` and `height` properties of the Stage class can be used to determine the actual pixel dimensions of the resized Flash Player window. (In the other scale modes, the `stageWidth` and `stageHeight` properties always reflect the original width and height of the SWF.) In addition, when `scaleMode` is set to `StageScaleMode.NO_SCALE` and the SWF file is resized, the Stage class's `resize` event is dispatched, allowing you to make adjustments accordingly.

Consequently, having `scaleMode` set to `StageScaleMode.NO_SCALE` allows you to have greater control over how the screen contents adjust to the window resizing if you desire. For example, in a SWF containing a video and a control bar, you might want to make the control bar stay the same size when the Stage is resized, and only change the size of the video window to accommodate the Stage size change. This is demonstrated in the following example:

```
// videoScreen is a display object (e.g. a Video instance) containing a
// video; it is positioned at the top-left corner of the Stage, and
// it should resize when the SWF resizes.

// controlBar is a display object (e.g. a Sprite) containing several
// buttons; it should stay positioned at the bottom-left corner of the
// Stage (below videoScreen) and it should not resize when the SWF
// resizes.

import flash.display.Stage;
import flash.display.StageAlign;
import flash.display.StageScaleMode;
import flash.events.Event;

var swfStage:Stage = videoScreen.stage;
swfStage.scaleMode = StageScaleMode.NO_SCALE;
swfStage.align = StageAlign.TOP_LEFT;

function resizeDisplay(event:Event):void
{
    var swfWidth:int = swfStage.stageWidth;
    var swfHeight:int = swfStage.stageHeight;

    // Resize the video window.
    var newVideoHeight:Number = swfHeight - controlBar.height;
    videoScreen.height = newVideoHeight;
    videoScreen.scaleX = videoScreen.scaleY;

    // Reposition the control bar.
    controlBar.y = newVideoHeight;
}

swfStage.addEventListener(Event.RESIZE, resizeDisplay);
```

## Working with full-screen mode

Full-screen mode allows you to make a SWF fill a viewer's entire monitor, without any borders, menu bars, and so forth. The Stage class's `displayState` property is used to toggle full-screen mode on and off for a SWF. The `displayState` property can be set to one of the values defined by the constants in the `flash.display.StageDisplayState` class. To turn on full-screen mode, set `displayState` to `StageDisplayState.FULL_SCREEN`:

```
// mySprite is a Sprite instance, already added to the display list
mySprite.stage.displayState = StageDisplayState.FULL_SCREEN;
```

To exit full-screen mode, set the `displayState` property to `StageDisplayState.NORMAL`:

```
mySprite.stage.displayState = StageDisplayState.NORMAL;
```

In addition, a user can choose to leave full-screen mode by switching focus to a different window or by using one of several key combinations: the Esc key (all platforms), Ctrl-W (Windows), Command-W (Mac), or Alt-F4 (Windows).

Stage scaling behavior for full-screen mode is the same as under normal mode; the scaling is controlled by the Stage class's `scaleMode` property. As always, if the `scaleMode` property is set to `StageScaleMode.NO_SCALE`, the Stage's `stageWidth` and `stageHeight` properties change to reflect the size of the screen area occupied by the SWF (the entire screen, in this case).

You can use the Stage class's `fullScreen` event to detect and respond when full-screen mode is turned on or off. For example, you might want to reposition, add, or remove items from the screen when entering or leaving full-screen mode, as in this example:

```
import flash.events.FullScreenEvent;

function fullScreenRedraw(event:FullScreenEvent):void
{
    if (event.fullScreen)
    {
        // Remove input text fields.
        // Add a button that closes full-screen mode.
    }
    else
    {
        // Re-add input text fields.
        // Remove the button that closes full-screen mode.
    }
}

mySprite.stage.addEventListener(FullScreenEvent.FULL_SCREEN,
    fullScreenRedraw);
```

As this code shows, the event object for the `fullScreen` event is an instance of the `flash.events.FullScreenEvent` class, which includes a `fullScreen` property indicating whether full-screen mode is enabled (`true`) or not (`false`).

When working with full-screen mode in ActionScript, you'll want to keep the following considerations in mind:

- Full-screen mode can only be initiated through ActionScript in response to a mouse click (including right-click) or keypress.
- For users with multiple monitors, the SWF content will expand to fill only one monitor. Flash Player uses a metric to determine which monitor contains the greatest portion of the SWF, and uses that monitor for full-screen mode.
- For a SWF file embedded in an HTML page, the HTML code to embed Flash Player must include a `param` tag and `embed` attribute with the name `allowFullScreen` and value `true`, like this:

```
<object>
  ...
  <param name="allowFullScreen" value="true" />
  <embed ... allowfullscreen="true" />
</object>
```

If you are using JavaScript in a web page to generate the SWF-embedding tags, you must alter the JavaScript to add the `allowFullScreen` `param` tag and attribute. For example, if your HTML page uses the `AC_FL_RunContent()` function (which is used by both Flex Builder and Flash-generated HTML pages), you should add the `allowFullScreen` parameter to that function call as follows:

```
AC_FL_RunContent(
  ...
  'allowFullScreen','true',
  ...
); //end AC code
```

This does not apply to SWF files running in the stand-alone Flash Player.

- All keyboard-related ActionScript, such as keyboard events and text entry in `TextField` instances, is disabled in full-screen mode. The exception is the keyboard shortcuts that close full-screen mode.

There are a few additional security-related restrictions you'll want to understand, too. These are described in [“Security sandboxes” on page 770](#).

## Handling events for display objects

The `DisplayObject` class inherits from the `EventDispatcher` class. This means that every display object can participate fully in the event model (described in [Chapter 10, “Handling events,” on page 313](#)). Every display object can use its `addEventListener()` method—inherited from the `EventDispatcher` class—to listen for a particular event, but only if the listening object is part of the event flow for that event.



When Flash Player dispatches an event object, that event object makes a round-trip journey from the Stage to the display object where the event occurred. For example, if a user clicks on a display object named `child1`, Flash Player dispatches an event object from the Stage through the display list hierarchy down to the `child1` display object.

The event flow is conceptually divided into three phases, as illustrated in this diagram:

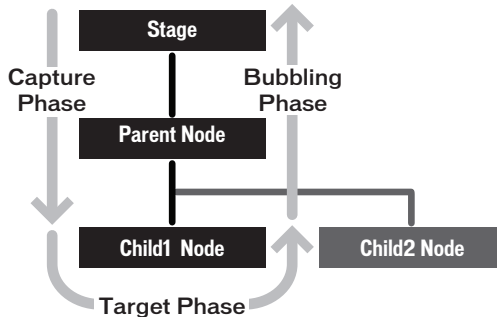

For more information, see [Chapter 10, “Handling events,”](#) on page 313.

One important issue to keep in mind when working with display object events is the effect that event listeners can have on whether display objects are automatically removed from memory (garbage collected) when they’re removed from the display list. If a display object has objects subscribed as listeners to its events, that display object will not be removed from memory even when it’s removed from the display list, because it will still have references to those listener objects. For more information, see [“Managing event listeners”](#) on page 331.

## Choosing a DisplayObject subclass

With several options to choose from, one of the important decisions you’ll make when you’re working with display objects is which display object to use for what purpose. Here are some guidelines to help you decide. These same suggestions apply whether you need an instance of a class or you’re choosing a base class for a class you’re creating:

- If you don’t need an object that can be a container for other display objects (that is, you just need one that serves as a stand-alone screen element), choose one of these DisplayObject or InteractiveObject subclasses, depending on what it will be used for:
  - Bitmap for displaying a bitmap image.
  - TextField for adding text.
  - Video for displaying video.

- Shape for a “canvas” for drawing content on-screen. In particular, if you want to create an instance for drawing shapes on the screen, and it won’t be a container for other display objects, you’ll gain significant performance benefits using Shape instead of Sprite or MovieClip.
- MorphShape, StaticText, or SimpleButton for Flash authoring-specific items. (You can’t create instances of these classes programmatically, but you can create variables with these data types to refer to items created using the Flash authoring program.)
- If you need a variable to refer to the main Stage, use the Stage class as its data type.
- If you need a container for loading an external SWF file or image file, use a Loader instance. The loaded content will be added to the display list as a child of the Loader instance. Its data type will depend on the nature of the loaded content, as follows:
  - A loaded image will be a Bitmap instance.
  - A loaded SWF file written in ActionScript 3.0 will be a Sprite or MovieClip instance (or an instance of a subclass of those classes, as specified by the content creator).
  - A loaded SWF file written in ActionScript 1.0 or ActionScript 2.0 will be an AVM1Movie instance.
- If you need an object to serve as a container for other display objects (whether or not you’ll also be drawing onto the display object using ActionScript), choose one of the DisplayObjectContainer subclasses:
  - Sprite if the object will be created using only ActionScript, or as the base class for a custom display object that will be created and manipulated solely with ActionScript.
  - MovieClip if you’re creating a variable to refer to a movie clip symbol created in the Flash authoring tool.
- If you are creating a class that will be associated with a movie clip symbol in the Flash library, choose one of these DisplayObjectContainer subclasses as your class’s base class:
  - MovieClip if the associated movie clip symbol has content on more than one frame
  - Sprite if the associated movie clip symbol has content only on the first frame

# Manipulating display objects

Regardless of which display object you choose to use, there are a number of manipulations that all display objects have in common as elements that are displayed on the screen. For example, they can all be positioned on the screen, moved forward or backward in the stacking order of display objects, scaled, rotated, and so forth. Because all display objects inherit this functionality from their common base class (`DisplayObject`), this functionality behaves the same whether you're manipulating a `TextField` instance, a `Video` instance, a `Shape` instance, or any other display object. The following sections detail several of these common display object manipulations.

## Changing position

The most basic manipulation to any display object is positioning it on the screen. To set a display object's position, change the object's `x` and `y` properties.

```
myShape.x = 17;  
myShape.y = 212;
```

The display object positioning system treats the Stage as a Cartesian coordinate system (the common grid system with a horizontal `x` axis and vertical `y` axis). The origin of the coordinate system (the 0,0 coordinate where the `x` and `y` axes meet) is at the top-left corner of the Stage. From there, `x` values are positive going right and negative going left, while (in contrast to typical graphing systems) `y` values are positive going down and negative going up. For example, the previous lines of code move the object `myShape` to the `x` coordinate 17 (17 pixels to the right of the origin) and `y` coordinate 212 (212 pixels below the origin).

By default, when a display object is created using `ActionScript`, the `x` and `y` properties are both set to 0, placing the object at the top-left corner of its parent content.

## Changing position relative to the Stage

It's important to remember that the `x` and `y` properties always refer to the position of the display object relative to the 0,0 coordinate of its parent display object's axes. So for a `Shape` instance (such as a circle) contained inside a `Sprite` instance, setting the `Shape` object's `x` and `y` properties to 0 will place the circle at the top-left corner of the `Sprite`, which is not necessarily the top-left corner of the Stage. To position an object relative to the global Stage coordinates, you can use the `globalToLocal()` method of any display object to convert coordinates from global (Stage) coordinates to local (display object container) coordinates, like this:

```
// Position the shape at the top-left corner of the Stage,  
// regardless of where its parent is located.
```

```

// Create a Sprite, positioned at x:200 and y:200.
var mySprite:Sprite = new Sprite();
mySprite.x = 200;
mySprite.y = 200;
this.addChild(mySprite);

// Draw a dot at the Sprite's 0,0 coordinate, for reference.
mySprite.graphics.lineStyle(1, 0x000000);
mySprite.graphics.beginFill(0x000000);
mySprite.graphics.moveTo(0, 0);
mySprite.graphics.lineTo(1, 0);
mySprite.graphics.lineTo(1, 1);
mySprite.graphics.lineTo(0, 1);
mySprite.graphics.endFill();

// Create the circle Shape instance.
var circle:Shape = new Shape();
mySprite.addChild(circle);

// Draw a circle with radius 50 and center point at x:50, y:50 in the Shape.
circle.graphics.lineStyle(1, 0x000000);
circle.graphics.beginFill(0xff0000);
circle.graphics.drawCircle(50, 50, 50);
circle.graphics.endFill();

// Move the Shape so its top-left corner is at the Stage's 0, 0 coordinate.
var stagePoint:Point = new Point(0, 0);
var targetPoint:Point = mySprite.globalToLocal(stagePoint);
circle.x = targetPoint.x;
circle.y = targetPoint.y;

```

You can likewise use the `DisplayObject` class's `localToGlobal()` method to convert local coordinates to Stage coordinates.

## Creating drag-and-drop interaction

One common reason for moving a display object is to create a drag-and-drop interaction, so that when the user clicks an object, the object moves as the mouse moves, until the mouse button is released. Drag-and-drop interaction can be created in two ways in ActionScript. In either case, two mouse events are used: when the mouse button is pressed down, the object is told to follow the mouse cursor, and when it's released, the object is told to stop following the mouse cursor.

The first way, using the `startDrag()` method, is simpler, but more limited. When the mouse button is pressed, the `startDrag()` method of the display object to be dragged is called.

When the mouse button is released, the `stopDrag()` method is called.

```
// This code creates a drag-and-drop interaction using the startDrag()
```

```

// technique.
// square is a DisplayObject (e.g. a MovieClip or Sprite instance).

import flash.events.MouseEvent;

// This function is called when the mouse button is pressed.
function startDragging(event:MouseEvent):void
{
    square.startDrag();
}

// This function is called when the mouse button is released.
function stopDragging(event:MouseEvent):void
{
    square.stopDrag();
}

square.addEventListener(MouseEvent.MOUSE_DOWN, startDragging);
square.addEventListener(MouseEvent.MOUSE_UP, stopDragging);

```

This technique suffers from one fairly significant limitation: only one item at a time can be dragged using `startDrag()`. If one display object is being dragged and the `startDrag()` method is called on another display object, the first display object stops following the mouse immediately. For example, if the `startDragging()` function is changed as shown here, only the circle object will be dragged, in spite of the `square.startDrag()` method call:

```

function startDragging(event:MouseEvent):void
{
    square.startDrag();
    circle.startDrag();
}

```

As a consequence of the fact that only one object can be dragged at a time using `startDrag()`, the `stopDrag()` method can be called on any display object and it stops whatever object is currently being dragged.

If you need to drag more than one display object, or to avoid the possibility of conflicts where more than one object might potentially use `startDrag()`, it's best to use the mouse-following technique to create the dragging effect. With this technique, when the mouse button is pressed, a function is subscribed as a listener to the `mouseMove` event of the Stage. This function, which is then called every time the mouse moves, causes the dragged object to jump to the x, y coordinate of the mouse. Once the mouse button is released, the function is unsubscribed as a listener, meaning it is no longer called when the mouse moves and the object stops following the mouse cursor. Here is some code that demonstrates this technique:

```

// This code creates a drag-and-drop interaction using the mouse-following
// technique.
// circle is a DisplayObject (e.g. a MovieClip or Sprite instance).

```

```

import flash.events.MouseEvent;

var offsetX:Number;
var offsetY:Number;

// This function is called when the mouse button is pressed.
function startDragging(event:MouseEvent):void
{
    // Record the difference (offset) between where
    // the cursor was when the mouse button was pressed and the x, y
    // coordinate of the circle when the mouse button was pressed.
    offsetX = event.stageX - circle.x;
    offsetY = event.stageY - circle.y;

    // tell Flash Player to start listening for the mouseMove event
    stage.addEventListener(MouseEvent.MOUSE_MOVE, dragCircle);
}

// This function is called when the mouse button is released.
function stopDragging(event:MouseEvent):void
{
    // Tell Flash Player to stop listening for the mouseMove event.
    stage.removeEventListener(MouseEvent.MOUSE_MOVE, dragCircle);
}

// This function is called every time the mouse moves,
// as long as the mouse button is pressed down.
function dragCircle(event:MouseEvent):void
{
    // Move the circle to the location of the cursor, maintaining
    // the offset between the cursor's location and the
    // location of the dragged object.
    circle.x = event.stageX - offsetX;
    circle.y = event.stageY - offsetY;

    // Instruct Flash Player to refresh the screen after this event.
    event.updateAfterEvent();
}

circle.addEventListener(MouseEvent.MOUSE_DOWN, startDragging);
circle.addEventListener(MouseEvent.MOUSE_UP, stopDragging);

```

In addition to making a display object follow the mouse cursor, a common part of drag-and-drop interaction includes moving the dragged object to the front of the display, so that it appears to be floating above all the other objects. For example, suppose you have two objects, a circle and a square, that both have a drag-and-drop interaction. If the circle happens to be below the square on the display list, and you click and drag the circle so that the cursor is over the square, the circle will appear to slide behind the square, which breaks the drag-and-drop illusion. Instead, you can make it so that when the circle is clicked, it moves to the top of the display list, and thus always appears on top of any other content.

The following code (adapted from the previous example) creates a drag-and-drop interaction for two display objects, a circle and a square. Whenever the mouse button is pressed over either one, that item is moved to the top of the Stage's display list, so that the dragged item always appears on top. Code that is new or changed from the previous listing appears in boldface.

```
// This code creates a drag-and-drop interaction using the mouse-following
// technique.
// circle and square are DisplayObjects (e.g. MovieClip or Sprite
// instances).

import flash.display.DisplayObject;
import flash.events.MouseEvent;

var offsetX:Number;
var offsetY:Number;
var draggedObject:DisplayObject;

// This function is called when the mouse button is pressed.
function startDragging(event:MouseEvent):void
{
    // remember which object is being dragged
    draggedObject = DisplayObject(event.target);

    // Record the difference (offset) between where the cursor was when
    // the mouse button was pressed and the x, y coordinate of the
    // dragged object when the mouse button was pressed.
    offsetX = event.stageX - draggedObject.x;
    offsetY = event.stageY - draggedObject.y;

    // move the selected object to the top of the display list
    stage.addChild(draggedObject);

    // Tell Flash Player to start listening for the mouseMove event.
    stage.addEventListener(MouseEvent.MOUSE_MOVE, dragObject);
}

// This function is called when the mouse button is released.
function stopDragging(event:MouseEvent):void
```

```

{
    // Tell Flash Player to stop listening for the mouseMove event.
    stage.removeEventListener(MouseEvent.MOUSE_MOVE, dragObject);
}

// This function is called every time the mouse moves,
// as long as the mouse button is pressed down.
function dragObject(event:MouseEvent):void
{
    // Move the dragged object to the location of the cursor, maintaining
    // the offset between the cursor's location and the location
    // of the dragged object.
    draggedObject.x = event.stageX - offsetX;
    draggedObject.y = event.stageY - offsetY;

    // Instruct Flash Player to refresh the screen after this event.
    event.updateAfterEvent();
}

circle.addEventListener(MouseEvent.MOUSE_DOWN, startDragging);
circle.addEventListener(MouseEvent.MOUSE_UP, stopDragging);

square.addEventListener(MouseEvent.MOUSE_DOWN, startDragging);
square.addEventListener(MouseEvent.MOUSE_UP, stopDragging);

```

To extend this effect further, such as for a game where tokens or cards are moved among piles, you could add the dragged object to the Stage's display list when it's "picked up," and then add it to another display list—such as the "pile" where it is dropped—when the mouse button is released.

Finally, to enhance the effect, you could apply a drop shadow filter to the display object when it is clicked (when you start dragging it) and remove the drop shadow when the object is released. For details on using the drop shadow filter and other display object filters in ActionScript, see [Chapter 15, "Filtering display objects," on page 465](#).

## Panning and scrolling display objects

If you have a display object that is too large for the area in which you want it to display it, you can use the `scrollRect` property to define the viewable area of the display object. In addition, by changing the `scrollRect` property in response to user input, you can cause the content to pan left and right or scroll up and down.



The `scrollRect` property is an instance of the `Rectangle` class, which is a class that combines the values needed to define a rectangular area as a single object. To initially define the viewable area of the display object, create a new `Rectangle` instance and assign it to the display object's `scrollRect` property. Later, to scroll or pan, you read the `scrollRect` property into a separate `Rectangle` variable, and change the desired property (for instance, change the `Rectangle` instance's `x` property to pan or `y` property to scroll). Then you reassign that `Rectangle` instance to the `scrollRect` property to notify the display object of the changed value.

For example, the following code defines the viewable area for a `TextField` object named `bigText` that is too tall to fit in the SWF file's boundaries. When the two buttons named `up` and `down` are clicked, they call functions that cause the contents of the `TextField` object to scroll up or down by modifying the `y` property of the `scrollRect` `Rectangle` instance.

```
import flash.events.MouseEvent;
import flash.geom.Rectangle;

// Define the initial viewable area of the TextField instance:
// left: 0, top: 0, width: TextField's width, height: 350 pixels.
bigText.scrollRect = new Rectangle(0, 0, bigText.width, 350);

// Cache the TextField as a bitmap to improve performance.
bigText.cacheAsBitmap = true;

// called when the "up" button is clicked
function scrollUp(event:MouseEvent):void
{
    // Get access to the current scroll rectangle.
    var rect:Rectangle = bigText.scrollRect;
    // Decrease the y value of the rectangle by 20, effectively
    // shifting the rectangle down by 20 pixels.
    rect.y -= 20;
    // Reassign the rectangle to the TextField to "apply" the change.
    bigText.scrollRect = rect;
}

// called when the "down" button is clicked
function scrollDown(event:MouseEvent):void
{
    // Get access to the current scroll rectangle.
    var rect:Rectangle = bigText.scrollRect;
    // Increase the y value of the rectangle by 20, effectively
    // shifting the rectangle up by 20 pixels.
    rect.y += 20;
    // Reassign the rectangle to the TextField to "apply" the change.
    bigText.scrollRect = rect;
}
```

```
up.addEventListener(MouseEvent.CLICK, scrollUp);
down.addEventListener(MouseEvent.CLICK, scrollDown);
```

As this example illustrates, when you work with the `scrollRect` property of a display object, it's best to specify that Flash Player should cache the display object's content as a bitmap, using the `cacheAsBitmap` property. When you do so, Flash Player doesn't have to re-draw the entire contents of the display object each time it is scrolled, and can instead use the cached bitmap to render the necessary portion directly to the screen. For details, see [“Caching display objects” on page 405](#).

## Manipulating size and scaling objects

You can measure and manipulate the size of a display object in two ways, using either the dimension properties (`width` and `height`) or the scale properties (`scaleX` and `scaleY`).

Every display object has a `width` property and a `height` property, which are initially set to the size of the object in pixels. You can read the values of those properties to measure the size of the display object. You can also specify new values to change the size of the object, as follows:

```
// Resize a display object.
square.width = 420;
square.height = 420;

// Determine the radius of a circle display object.
var radius:Number = circle.width / 2;
```

Changing the `height` or `width` of a display object causes the object to scale, meaning its contents stretch or squeeze to fit in the new area. If the display object contains only vector shapes, those shapes will be redrawn at the new scale, with no loss in quality. Any bitmap graphic elements in the display object will be scaled rather than redrawn. So, for example, a digital photo whose width and height are increased beyond the actual dimensions of the pixel information in the image will be pixelated, making it look jagged.

When you change the `width` or `height` properties of a display object, Flash Player updates the `scaleX` and `scaleY` properties of the object as well. These properties represent the relative size of the display object compared to its original size. The `scaleX` and `scaleY` properties use fraction (decimal) values to represent percentage. For example, if a display object's `width` has been changed so that it's half as wide as its original size, the object's `scaleX` property will have the value `.5`, meaning 50 percent. If its height has been doubled, its `scaleY` property will have the value `2`, meaning 200 percent.

```
// circle is a display object whose width and height are 150 pixels.
// At original size, scaleX and scaleY are 1 (100%).
trace(circle.scaleX); // output: 1
trace(circle.scaleY); // output: 1
```

```
// When you change the width and height properties,  
// Flash Player changes the scaleX and scaleY properties accordingly.  
circle.width = 100;  
circle.height = 75;  
trace(circle.scaleX); // output: 0.6622516556291391  
trace(circle.scaleY); // output: 0.4966887417218543
```

Size changes are not proportional. In other words, if you change the height of a square but not its width, its proportions will no longer be the same, and it will be a rectangle instead of a square. If you want to make relative changes to the size of a display object, you can set the values of the `scaleX` and `scaleY` properties to resize the object, as an alternative to setting the width or height properties. For example, this code changes the width of the display object named `square`, and then alters the vertical scale (`scaleY`) to match the horizontal scale, so that the size of the square stays proportional.

```
// Change the width directly.  
square.width = 150;  
  
// Change the vertical scale to match the horizontal scale,  
// to keep the size proportional.  
square.scaleY = square.scaleX;
```

## Controlling distortion when scaling

Normally when a display object is scaled (for example, stretched horizontally), the resulting distortion is spread equally across the object, so that each part is stretched the same amount. For graphics and design elements, this is probably what you want. However, sometimes it's preferable to have control over which portions of the display object stretch and which portions remain unchanged. One common example of this is a button that's a rectangle with rounded corners. With normal scaling, the corners of the button will stretch, making the corner radius change as the button resizes.



However, in this case it would be preferable to have control over the scaling—to be able to designate certain areas which should scale (the straight sides and middle) and areas which shouldn't (the corners)—so that scaling happens without visible distortion.



You can use 9-slice scaling (Scale-9) to create display objects where you have control over how the objects scale. With 9-slice scaling, the display object is divided into nine separate rectangles (a 3 by 3 grid, like the grid of a tic-tac-toe board). The rectangles aren't necessarily the same size—you designate where the grid lines are placed. Any content that lies in the four corner rectangles (such as the rounded corners of a button) will not be stretched or compressed when the display object scales. The top-center and bottom-center rectangles will scale horizontally but not vertically, while the left-middle and right-middle rectangles will scale vertically but not horizontally. The center rectangle will scale both horizontally and vertically.

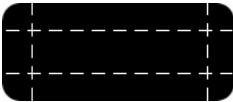

Keeping this in mind, if you're creating a display object and you want certain content to never scale, you just have to make sure that the dividing lines of the 9-slice scaling grid are placed so that the content ends up in one of the corner rectangles.

In ActionScript, setting a value for the `scale9Grid` property of a display object turns on 9-slice scaling for the object and defines the size of the rectangles in the object's Scale-9 grid. You use an instance of the `Rectangle` class as the value for the `scale9Grid` property, as follows:

```
myButton.scale9Grid = new Rectangle(32, 27, 71, 64);
```

The four parameters of the Rectangle constructor are the x coordinate, y coordinate, width, and height. In this example, the rectangle's top-left corner is placed at the point x: 32, y: 27 on the display object named `myButton`. The rectangle is 71 pixels wide and 65 pixels tall (so its right edge is at the x coordinate 103 on the display object and its bottom edge is at the y coordinate 92 on the display object).

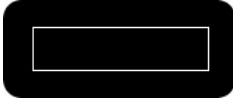

The actual area contained in the region defined by the Rectangle instance represents the center rectangle of the Scale-9 grid. The other rectangles are calculated by Flash Player by extending the sides of the Rectangle instance, as shown here:



In this case, as the button scales up or down, the rounded corners will not stretch or compress, but the other areas will adjust to accommodate the scaling.

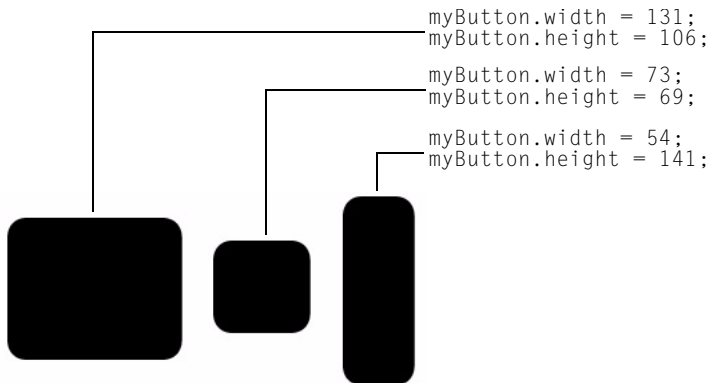

## Caching display objects

As your designs in Flash grow in size, whether you are creating an application or complex scripted animations, you need to consider performance and optimization. When you have content that remains static (such as a rectangle Shape instance), Flash does not optimize the content. Therefore, when you change the position of the rectangle, Flash redraws the entire Shape instance.

You can cache specified display objects to improve the performance of your SWF file. The display object is a *surface*, essentially a bitmap version of the instance’s vector data, which is data that you do not intend to change much over the course of your SWF file. Therefore, instances with caching turned on are not continually redrawn as the SWF file plays, letting the SWF file render quickly.

NOTE

You can update the vector data, at which time the surface is recreated. Therefore, the vector data cached in the surface does not need to remain the same for the entire SWF file.

Setting a display object’s `cacheAsBitmap` property to `true` makes the display object cache a bitmap representation of itself. Flash creates a surface object for the instance, which is a cached bitmap instead of vector data. If you change the bounds of the display object, the surface is recreated instead of resized. Surfaces can nest within other surfaces. The child surface copies its bitmap onto its parent surface. For more information, see [“Enabling bitmap caching” on page 408](#).

The `DisplayObject` class’s `opaqueBackground` property and `scrollRect` property are related to bitmap caching using the `cacheAsBitmap` property. Although these three properties are independent of each other, the `opaqueBackground` and `scrollRect` properties work best when an object is cached as a bitmap—you see performance benefits for the `opaqueBackground` and `scrollRect` properties only when you set `cacheAsBitmap` to `true`. For more information about scrolling display object content, see [“Panning and scrolling display objects” on page 400](#). For more information about setting an opaque background, see [“Setting an opaque background color” on page 409](#).

For information on alpha channel masking, which requires you to set the `cacheAsBitmap` property to `true`, see [“Alpha channel masking” on page 415](#).

## When to enable caching

Enabling caching for a display object creates a surface, which has several advantages, such as helping complex vector animations to render fast. There are several scenarios in which you will want to enable caching. It might seem as though you would always want to enable caching to improve the performance of your SWF files; however, there are situations in which enabling caching does not improve performance, or can even decrease it. This section describes scenarios in which caching should be used, and when to use regular display objects.

Overall performance of cached data depends on how complex the vector data of your instances are, how much of the data you change, and whether or not you set the `opaqueBackground` property. If you are changing small regions, the difference between using a surface and using vector data could be negligible. You might want to test both scenarios with your work before you deploy the application.

## When to use bitmap caching

The following are typical scenarios in which you might see significant benefits when you enable bitmap caching.

- **Complex background image:** An application that contains a detailed and complex background image of vector data (perhaps an image where you applied the trace bitmap command, or artwork that you created in Adobe Illustrator®). You might animate characters over the background, which slows the animation because the background needs to continuously regenerate the vector data. To improve performance, you can set the `opaqueBackground` property of the background display object to `true`. The background is rendered as a bitmap and can be redrawn quickly, so that your animation plays much faster.
- **Scrolling text field:** An application that displays a large amount of text in a scrolling text field. You can place the text field in a display object that you set as scrollable with scrolling bounds (the `scrollRect` property). This enables fast pixel scrolling for the specified instance. When a user scrolls the display object instance, Flash shifts the scrolled pixels up and generates the newly exposed region instead of regenerating the entire text field.
- **Windowing system:** An application with a complex system of overlapping windows. Each window can be open or closed (for example, web browser windows). If you mark each window as a surface (by setting the `cacheAsBitmap` property to `true`), each window is isolated and cached. Users can drag the windows so that they overlap each other, and each window doesn't need to regenerate the vector content.
- **Alpha channel masking:** When you are using alpha channel masking, you must set the `cacheAsBitmap` property to `true`. For more information, see [“Alpha channel masking” on page 415](#).

Enabling bitmap caching in all of these scenarios improves the responsiveness and interactivity of the application by optimizing the vector graphics.

In addition, whenever you apply a filter to a display object, `cacheAsBitmap` is automatically set to `true` by Flash Player, even if you explicitly set it to `false`. If you clear all the filters from the display object, the `cacheAsBitmap` property returns to the value it was last set to.

## When to avoid using bitmap caching

Misusing this feature could negatively affect your SWF file. When you use bitmap caching, remember the following guidelines:

- Do not overuse surfaces (display objects with caching enabled). Each surface uses more memory than a regular display object, which means that you should only enable surfaces when you need to improve rendering performance.  
A cached bitmap can use significantly more memory than a regular display object. For example, if a Sprite instance on the Stage is 250 pixels by 250 pixels in size, when cached it might use 250 KB instead of 1 KB when it's a regular (un-cached) Sprite instance.
- Avoid zooming into cached surfaces. If you overuse bitmap caching, a large amount of memory is consumed (see previous bullet), especially if you zoom in on the content.
- Use surfaces for display object instances that are largely static (non-animating). You can drag or move the instance, but the contents of the instance should not animate or change a lot. (Animation or changing content are more likely with a MovieClip instance containing animation or a Video instance.) For example, if you rotate or transform an instance, the instance changes between the surface and vector data, which is difficult to process and negatively affects your SWF file.
- If you mix surfaces with vector data, it increases the amount of processing that Flash Player (and sometimes the computer) needs to do. Group surfaces together as much as possible—for example, when you create windowing applications.

## Enabling bitmap caching

To enable bitmap caching for a display object, you set its `cacheAsBitmap` property to `true`:

```
mySprite.cacheAsBitmap = true;
```

After you set the `cacheAsBitmap` property to `true`, you might notice that the display object automatically pixel-snaps to whole coordinates. When you test the SWF file, you should notice that any animation performed on a complex vector image renders much faster.

A surface (cached bitmap) is not created, even if `cacheAsBitmap` is set to `true`, if one or more of the following occurs:

- The bitmap is greater than 2880 pixels in height or width.
- The bitmap fails to allocate (because of an out-of-memory error).



## Setting an opaque background color

You can set an opaque background for a display object. For example, when your SWF has a background that contains complex vector art, you can set the `opaqueBackground` property to a specified color (typically the same color as the Stage). The color is specified as a number (commonly a hexadecimal color value). The background is then treated as a bitmap, which helps optimize performance.

When you set `cacheAsBitmap` to `true`, and also set the `opaqueBackground` property to a specified color, the `opaqueBackground` property allows the internal bitmap to be opaque and rendered faster. If you do not set `cacheAsBitmap` to `true`, the `opaqueBackground` property adds an opaque vector-square shape to the background of the display object. It does not create a bitmap automatically.

The following example shows how to set the background of a display object to optimize performance:

```
myShape.cacheAsBitmap = true;
myShape.opaqueBackground = 0xFF0000;
```

In this case, the background color of the Shape named `myShape` is set to red (`0xFF0000`). Assuming the Shape instance contains a drawing of a green triangle, on a Stage with a white background, this would show up as a green triangle with red in the empty space in the Shape instance's bounding box (the rectangle that completely encloses the Shape).

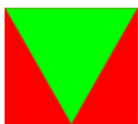

Of course, this code would make more sense if it were used with a Stage with a solid red background. On another colored background, that color would be specified instead. For example, in a SWF with a white background, the `opaqueBackground` property would most likely be set to `0xFFFFFFFF`, or pure white.

## Applying blending modes

Blending modes involve combining the colors of one image (the base image) with the colors of another image (the blend image) to produce a third image—the resulting image is the one that is actually displayed on the screen. Each pixel value in an image is processed with the corresponding pixel value of the other image to produce a pixel value for that same position in the result.

Every display object has a `blendMode` property that can be set to one of the following blending modes. These are constants defined in the `BlendMode` class. Alternatively, you can use the String values (in parentheses) that are the actual values of the constants.

- `BlendMode.ADD ("add")`: Commonly used to create an animated lightening dissolve effect between two images.
- `BlendMode.ALPHA ("alpha")`: Commonly used to apply the transparency of the foreground on the background.
- `BlendMode.DARKEN ("darken")`: Commonly used to superimpose type.
- `BlendMode.DIFFERENCE ("difference")`: Commonly used to create more vibrant colors.
- `BlendMode.ERASE ("erase")`: Commonly used to cut out (erase) part of the background using the foreground alpha.
- `BlendMode.HARDLIGHT ("hardlight")`: Commonly used to create shading effects.
- `BlendMode.INVERT ("invert")`: Used to invert the background.
- `BlendMode.LAYER ("layer")`: Used to force the creation of a temporary buffer for precomposition for a particular display object.
- `BlendMode.LIGHTEN ("lighten")`: Commonly used to superimpose type.
- `BlendMode.MULTIPLY ("multiply")`: Commonly used to create shadows and depth effects.
- `BlendMode.NORMAL ("normal")`: Used to specify that the pixel values of the blend image override those of the base image.
- `BlendMode.OVERLAY ("overlay")`: Commonly used to create shading effects.
- `BlendMode.SCREEN ("screen")`: Commonly used to create highlights and lens flares.
- `BlendMode.SUBTRACT ("subtract")`: Commonly used to create an animated darkening dissolve effect between two images.

## Adjusting DisplayObject colors

You can use the methods of the `ColorTransform` class (`flash.geom.ColorTransform`) to adjust the color of a display object. Each display object has a `transform` property, which is an instance of the `Transform` class, and contains information about various transformations that are applied to the display object (such as rotation, changes in scale or position, and so forth). In addition to its information about geometric transformations, the `Transform` class also includes a `colorTransform` property, which is an instance of the `ColorTransform` class, and provides access to make color adjustments to the display object. To access the color transformation information of a display object, you can use code such as this:

```
var colorInfo:ColorTransform = myDisplayObject.transform.colorTransform;
```

Once you've created a `ColorTransform` instance, you can read its property values to find out what color transformations have already been applied, or you can set those values to make color changes to the display object. To update the display object after any changes, you must reassign the `ColorTransform` instance back to the `transform.colorTransform` property.

```
var colorInfo:ColorTransform = my DisplayObject.transform.colorTransform;

// Make some color transformations here.

// Commit the change.
myDisplayObject.transform.colorTransform = colorInfo;
```

## Setting color values with code

The `color` property of the `ColorTransform` class can be used to assign a specific red, green, blue (RGB) color value to the display object. The following example uses the `color` property to change the color of the display object named `square` to blue, when the user clicks a button named `blueBtn`:

```
// square is a display object on the Stage.
// blueBtn, redBtn, greenBtn, and blackBtn are buttons on the Stage.

import flash.events.MouseEvent;
import flash.geom.ColorTransform;

// Get access to the ColorTransform instance associated with square.
var colorInfo:ColorTransform = square.transform.colorTransform;

// This function is called when blueBtn is clicked.
function makeBlue(event:MouseEvent):void
{
    // Set the color of the ColorTransform object.
    colorInfo.color = 0x003399;
    // apply the change to the display object
    square.transform.colorTransform = colorInfo;
}

blueBtn.addEventListener(MouseEvent.CLICK, makeBlue);
```

Note that when you change a display object's color using the `color` property, it completely changes the color of the entire object, regardless of whether the object previously had multiple colors. For example, if there is a display object containing a green circle with black text on top, setting the `color` property of that object's associated `ColorTransform` instance to a shade of red will make the entire object, circle and text, turn red (so the text will no longer be distinguishable from the rest of the object).

## Altering color and brightness effects with code

Suppose you have a display object with multiple colors (for example, a digital photo) and you don't want to completely recolor the object; you just want to adjust the color of a display object based on the existing colors. In this scenario, the `ColorTransform` class includes a series of multiplier and offset properties that you can use to make this type of adjustment. The multiplier properties, named `redMultiplier`, `greenMultiplier`, `blueMultiplier`, and `alphaMultiplier`, work like colored photographic filters (or colored sunglasses), amplifying or diminishing certain colors in the display object. The offset properties (`redOffset`, `greenOffset`, `blueOffset`, and `alphaOffset`) can be used to add extra amounts of a certain color to the object, or to specify the minimum value that a particular color can have.

These multiplier and offset properties are identical to the advanced color settings that are available for movie clip symbols in the Flash authoring tool when you choose *Advanced* from the *Color* pop-up menu on the *Property* inspector.

The following code loads a JPEG image and applies a color transformation to it, which adjusts the red and green channels as the mouse pointer moves along the x axis and y axis. In this case, because no offset values are specified, the color value of each color channel displayed on screen will be a percentage of the original color value in the image—meaning that the most red or green displayed in any given pixel will be the original amount of red or green in that pixel.

```
import flash.display.Loader;
import flash.events.MouseEvent;
import flash.geom.Transform;
import flash.geom.ColorTransform;
import flash.net.URLRequest;

// Load an image onto the Stage.
var loader:Loader = new Loader();
var url:URLRequest = new URLRequest("http://www.helpexamples.com/flash/
  images/image1.jpg");
loader.load(url);
this.addChild(loader);

// This function is called when the mouse moves over the loaded image.
function adjustColor(event:MouseEvent):void
{
    // Access the ColorTransform object for the Loader (containing the image)
    var colorTransformer:ColorTransform = loader.transform.colorTransform;

    // Set the red and green multipliers according to the mouse position.
    // The red value ranges from 0% (no red) when the cursor is at the left
    // to 100% red (normal image appearance) when the cursor is at the right.
    // The same applies to the green channel, except it's controlled by the
    // position of the mouse in the y axis.
```

```

colorTransformer.redMultiplier = (loader.mouseX / loader.width) * 1;
colorTransformer.greenMultiplier = (loader.mouseY / loader.height) * 1;

// Apply the changes to the display object.
loader.transform.colorTransform = colorTransformer;
}

loader.addEventListener(MouseEvent.MOUSE_MOVE, adjustColor);

```

## Rotating objects

Display objects can be rotated using the `rotation` property. You can read this value to find out whether an object has been rotated, or to rotate the object you can set this property to a number (in degrees) representing the amount of rotation to be applied to the object. For instance, this line of code rotates the object named `square` 45 degrees (one eighth of one complete revolution):

```
square.rotation = 45;
```

Alternatively, you can rotate a display object using a transformation matrix, described in [Chapter 13, “Working with geometry,” on page 431](#).

## Fading objects

You can control the transparency of a display object to make it partially (or completely transparent), or change the transparency to make the object appear to fade in or out. The `DisplayObject` class’s `alpha` property defines the transparency (or more accurately, the opacity) of a display object. The `alpha` property can be set to any value between 0 and 1, where 0 is completely transparent, and 1 is completely opaque. For example, these lines of code make the object named `myBall` partially (50 percent) transparent when it is clicked with the mouse:

```

function fadeBall(event:MouseEvent):void
{
    myBall.alpha = .5;
}
myBall.addEventListener(MouseEvent.CLICK, fadeBall);

```

You can also alter the transparency of a display object using the color adjustments available through the `ColorTransform` class. For more information, see [“Adjusting DisplayObject colors” on page 410](#).

## Masking display objects

You can use a display object as a mask to create a hole through which the contents of another display object are visible.

### Defining a mask

To indicate that a display object will be the mask for another display object, set the mask object as the `mask` property of the display object to be masked:

```
// Make the object maskSprite be a mask for the object mySprite.  
mySprite.mask = maskSprite;
```

The masked display object is revealed under all opaque (nontransparent) areas of the display object acting as the mask. For instance, the following code creates a `Shape` instance containing a red 100 by 100 pixel square and a `Sprite` instance containing a blue circle with a radius of 25 pixels. When the circle is clicked, it is set as the mask for the square, so that the only part of the square that shows is the part that is covered by the solid part of the circle. In other words, only a red circle will be visible.

```
// This code assumes it's being run within a display object container  
// such as a MovieClip or Sprite instance.
```

```
import flash.display.Shape;  
  
// Draw a square and add it to the display list.  
var square:Shape = new Shape();  
square.graphics.lineStyle(1, 0x000000);  
square.graphics.beginFill(0xff0000);  
square.graphics.drawRect(0, 0, 100, 100);  
square.graphics.endFill();  
this.addChild(square);  
  
// Draw a circle and add it to the display list.  
var circle:Sprite = new Sprite();  
circle.graphics.lineStyle(1, 0x000000);  
circle.graphics.beginFill(0x0000ff);  
circle.graphics.drawCircle(25, 25, 25);  
circle.graphics.endFill();  
this.addChild(circle);  
  
function maskSquare(event:MouseEvent):void  
{  
    square.mask = circle;  
    circle.removeEventListener(MouseEvent.CLICK, maskSquare);  
}
```

```
circle.addEventListener(MouseEvent.CLICK, maskSquare);
```

The display object that is acting as a mask can be draggable, animated, resized dynamically, and can use separate shapes within a single mask. The mask display object doesn't necessarily need to be added to the display list. However, if you want the mask object to scale when the Stage is scaled or if you want to enable user interaction with the mask (such as user-controlled dragging and resizing), the mask object must be added to the display list. The actual z-index (front-to-back order) of the display objects doesn't matter, as long as the mask object is added to the display list. (The mask object will not appear on the screen except as a mask.) If the mask object is a `MovieClip` instance with multiple frames, it plays all the frames in its timeline, the same as it would if it were not serving as a mask. You can remove a mask by setting the `mask` property to `null`:

```
// remove the mask from mySprite  
mySprite.mask = null;
```

You cannot use a mask to mask another mask. You cannot set the `alpha` property of a mask display object. Only fills are used in a display object that is used as a mask; strokes are ignored.

## About masking device fonts

You can use a display object to mask text that is set in a device font. When you use a display object to mask text set in a device font, the rectangular bounding box of the mask is used as the masking shape. That is, if you create a non-rectangular display object mask for device font text, the mask that appears in the SWF file is the shape of the rectangular bounding box of the mask, not the shape of the mask itself.

## Alpha channel masking

Alpha channel masking is supported if both the mask and the masked display objects use bitmap caching, as shown here:

```
// maskShape is a Shape instance which includes a gradient fill.  
mySprite.cacheAsBitmap = true;  
maskShape.cacheAsBitmap = true;  
mySprite.mask = maskShape;
```

For instance, one application of alpha channel masking is to use a filter on the mask object independently of a filter that is applied to the masked display object.

In the following example, an external image file is loaded onto the Stage. That image (or more accurately, the `Loader` instance it is loaded into) will be the display object that is masked. A gradient oval (solid black center fading to transparent at the edges) is drawn over the image; this will be the alpha mask. Both display objects have bitmap caching turned on. The oval is set as a mask for the image, and it is then made draggable.

```

// This code assumes it's being run within a display object container
// such as a MovieClip or Sprite instance.

import flash.display.GradientType;
import flash.display.Loader;
import flash.display.Sprite;
import flash.geom.Matrix;
import flash.net.URLRequest;

// Load an image and add it to the display list.
var loader:Loader = new Loader();
var url:URLRequest = new URLRequest("http://www.helpexamples.com/flash/
  images/image1.jpg");
loader.load(url);
this.addChild(loader);

// Create a Sprite.
var oval:Sprite = new Sprite();
// Draw a gradient oval.
var colors:Array = [0x000000, 0x000000];
var alphas:Array = [1, 0];
var ratios:Array = [0, 255];
var matrix:Matrix = new Matrix();
matrix.createGradientBox(200, 100, 0, -100, -50);
oval.graphics.beginGradientFill(GradientType.RADIAL,
    colors,
    alphas,
    ratios,
    matrix);
oval.graphics.drawEllipse(-100, -50, 200, 100);
oval.graphics.endFill();
// add the Sprite to the display list
this.addChild(oval);

// Set cacheAsBitmap = true for both display objects.
loader.cacheAsBitmap = true;
oval.cacheAsBitmap = true;
// Set the oval as the mask for the loader (and its child, the loaded image)
loader.mask = oval;

// Make the oval draggable.
oval.startDrag(true);

```

## Animating objects

Animation is the process of making something move, or alternatively, of making something change over time. Scripted animation is a fundamental part of video games, and is often used to add polish and useful interaction clues to other applications.



The fundamental idea behind scripted animation is that a change needs to take place, and that change needs to be divided into increments over time. It's easy to make something repeat in ActionScript, using a common looping statement. However, a loop will run through all its iterations before updating the display. To create scripted animation, you need to write ActionScript that performs some action repeatedly over time and also updates the screen each time it runs.

For example, imagine you want to create a simple animation, such as making a ball travel across the screen. ActionScript includes a simple mechanism that allows you to track the passage of time and update the screen accordingly—meaning you could write code that moves the ball a small amount each time, until it reaches its destination. After each move the screen would update, making the cross-Stage motion visible to the viewer.

From a practical standpoint, it makes sense to synchronize scripted animation with the SWF file's frame rate (in other words, make one animation change each time a new frame displays or would display), since that is how fast Flash Player updates the screen. Each display object has an `enterFrame` event that is dispatched according to the frame rate of the SWF file—one event per frame. Most developers who create scripted animation use the `enterFrame` event as a way to create actions that repeat over time. You could write code that listens to the `enterFrame` event, moving the animated ball a certain amount each frame, and as the screen is updated (each frame), the ball would be redrawn in its new location, creating motion.

NOTE

Another way to perform an action repeatedly over time is to use the `Timer` class. A `Timer` instance triggers an event notification each time a specified amount of time has past. You could write code that performs animation by handling the `Timer` class's `timer` event, setting the time interval to a small one (some fraction of a second). For more information about using the `Timer` class, see [“Controlling time intervals” on page 196](#).

In the following example, a circle `Sprite` instance, named `circle`, is created on the Stage. When the user clicks the circle, a scripted animation sequence begins, causing `circle` to fade (its `alpha` property is decreased) until it is completely transparent:

```
import flash.display.Sprite;
import flash.events.Event;
import flash.events.MouseEvent;

// draw a circle and add it to the display list
var circle:Sprite = new Sprite();
circle.graphics.beginFill(0x990000);
circle.graphics.drawCircle(50, 50, 50);
circle.graphics.endFill();
addChild(circle);

// When this animation starts, this function is called every frame.
// The change made by this function (updated to the screen every
```

```
// frame) is what causes the animation to occur.
function fadeCircle(event:Event):void
{
    circle.alpha -= .05;

    if (circle.alpha <= 0)
    {
        circle.removeEventListener(Event.ENTER_FRAME, fadeCircle);
    }
}

function startAnimation(event:MouseEvent):void
{
    circle.addEventListener(Event.ENTER_FRAME, fadeCircle);
}

circle.addEventListener(MouseEvent.CLICK, startAnimation);
```

When the user clicks the circle, the function `fadeCircle()` is subscribed as a listener of the `enterFrame` event, meaning it begins to be called once per frame. That function fades `circle` by changing its `alpha` property, so once per frame the circle's `alpha` decreases by `.05` (5 percent) and the screen is updated. Eventually, when the `alpha` value is `0` (`circle` is completely transparent), the `fadeCircle()` function is removed as an event listener, ending the animation.

The same code could be used, for example, to create animated motion instead of fading. By substituting a different property for `alpha` in the function that is an `enterFrame` event listener, that property will be animated instead. For example, changing this line

```
circle.alpha -= .05;
```

to this code

```
circle.x += 5;
```

will animate the `x` property, causing the circle to move to the right across the Stage. The condition that ends the animation could be changed to end the animation (that is, unsubscribe the `enterFrame` listener) when the desired `x` coordinate is reached.

## Loading display content dynamically

You can load any of the following external display assets into an ActionScript 3.0 application:

- A SWF file authored in ActionScript 3.0—This file can be a `Sprite`, `MovieClip`, or any class that extends `Sprite`.
- An image file—This includes `JPG`, `PNG`, and `GIF` files.
- An `AVM1` SWF file—This is a SWF file written in ActionScript 1.0 or 2.0.

You load these assets by using the Loader class.

## Loading display objects

Loader objects are used to load SWF files and graphics files into an application. The Loader class is a subclass of the DisplayObjectContainer class. A Loader object can contain only one child display object in its display list—the display object representing the SWF or graphic file that it loads. When you add a Loader object to the display list, as in the following code, you also add the loaded child display object to the display list once it loads:

```
var pictLdr:Loader = new Loader();
var pictURL:String = "banana.jpg"
var pictURLReq:URLRequest = new URLRequest(pictURL);
pictLdr.load(pictURLReq);
this.addChild(pictLdr);
```

Once the SWF file or image is loaded, you can move the loaded display object to another display object container, such as the container DisplayObjectContainer object in this example:

```
import flash.display.*;
import flash.net.URLRequest;
import flash.events.Event;
var container:Sprite = new Sprite();
addChild(container);
var pictLdr:Loader = new Loader();
var pictURL:String = "banana.jpg"
var pictURLReq:URLRequest = new URLRequest(pictURL);
pictLdr.load(pictURLReq);
pictLdr.contentLoaderInfo.addEventListener(Event.COMPLETE, imgLoaded);
function imgLoaded(event:Event):void
{
    container.addChild(pictLdr.content);
}
```

## Monitoring loading progress

Once the file has started loading, a LoaderInfo object is created. A LoaderInfo object provides information such as load progress, the URLs of the loader and loadede, the number of bytes total for the media, and the nominal height and width of the media. A LoaderInfo object also dispatches events for monitoring the progress of the load.

The following diagram shows the different uses of the LoaderInfo object—for the instance of the main class of the SWF file, for a Loader object, and for an object loaded by the Loader object:

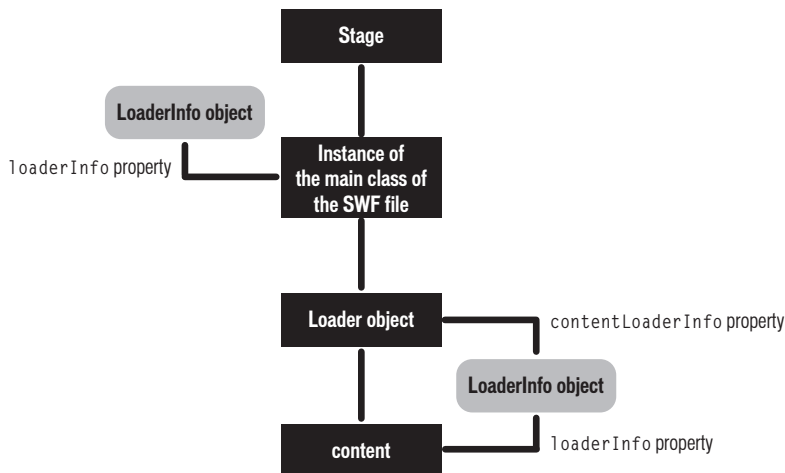

The LoaderInfo object can be accessed as a property of both the Loader object and the loaded display object. As soon as loading begins, the LoaderInfo object can be accessed through the `contentLoaderInfo` property of the Loader object. Once the display object has finished loading, the LoaderInfo object can also be accessed as a property of the loaded display object through the display object's `loaderInfo` property. The `loaderInfo` property of the loaded display object refers to the same LoaderInfo object as the `contentLoaderInfo` property of the Loader object. In other words, a LoaderInfo object is shared between a loaded object and the Loader object that loaded it (between loader and loadede).

In order to access properties of loaded content, you will want to add an event listener to the LoaderInfo object, as in the following code:

```
import flash.display.Loader;
import flash.display.Sprite;
import flash.events.Event;
```

```

var ldr:Loader = new Loader();
var urlReq:URLRequest = new URLRequest("Circle.swf");
ldr.load(urlReq);
ldr.contentLoaderInfo.addEventListener(Event.COMPLETE, loaded);
addChild(ldr);

function loaded(event:Event):void
{
    var content:Sprite = event.target.content;
    content.scaleX = 2;
}

```

For more information, see [Chapter 10, “Handling events,”](#) on page 313.

## Specifying loading context

When you load an external file into Flash Player through the `load()` or `loadBytes()` method of the `Loader` class, you can optionally specify a `context` parameter. This parameter is a `LoaderContext` object.

The `LoaderContext` class includes three properties that let you define the context of how the loaded content can be used:

- checkPolicyFile:** Use this property only when loading an image file (not a SWF file). If you set this property to `true`, the `Loader` checks the origin server for a cross-domain policy file (see [“Website controls \(cross-domain policy files\)”](#) on page 765). This is necessary only for content originating from domains other than that of the SWF file containing the `Loader` object. If the server grants permission to the `Loader` domain, ActionScript from SWF files in the `Loader` domain can access data in the loaded image; in other words, you can use the `BitmapData.draw()` command to access data in the loaded image.

Note that a SWF file from other domains than that of the `Loader` object can call `Security.allowDomain()` to permit a specific domain.

- securityDomain:** Use this property only when loading a SWF file (not an image). Specify this for a SWF file from a domain other than that of the file containing the `Loader` object. When you specify this option, Flash Player checks for the existence of a cross-domain policy file, and if one exists, SWF files from the domains permitted in the cross-policy file can cross-script the loaded SWF content. You can specify `flash.system.SecurityDomain.currentDomain` as this parameter.

- `applicationDomain`: Use this property only when loading a SWF file written in ActionScript 3.0 (not an image or a SWF file written in ActionScript 1.0 or 2.0). When loading the file, you can specify that the file be included in the same application domain as that of the Loader object, by setting the `applicationDomain` parameter to `flash.system.ApplicationDomain.currentDomain`. By putting the loaded SWF file in the same application domain, you can access its classes directly. This can be useful if you are loading a SWF file that contains embedded media, which you can access via their associated class names. For more information, see [“Using the ApplicationDomain class” on page 700](#).

Here’s an example of checking for a cross-domain policy file when loading a bitmap from another domain:

```
var context:LoaderContext = new LoaderContext();
context.checkPolicyFile = true;
var urlReq:URLRequest = new URLRequest("http://www.[your_domain_here].com/
    photo11.jpg");
var ldr:Loader = new Loader();
ldr.load(urlReq, context);
```

Here’s an example of checking for a cross-domain policy file when loading a SWF from another domain, in order to place the file in the same security sandbox as the Loader object. Additionally, the code adds the classes in the loaded SWF file to the same application domain as that of the Loader object:

```
var context:LoaderContext = new LoaderContext();
context.securityDomain = SecurityDomain.currentDomain;
context.applicationDomain = ApplicationDomain.currentDomain;
var urlReq:URLRequest = new URLRequest("http://www.[your_domain_here].com/
    library.swf");
var ldr:Loader = new Loader();
ldr.load(urlReq, context);
```

For more information, see the `LoaderContext` class in the *ActionScript 3.0 Language and Components Reference*.

# Example: SpriteArranger

The SpriteArranger sample application builds upon the Geometric Shapes sample application described separately (see “[Example: GeometricShapes](#)” on page 180).

The SpriteArranger sample application illustrates a number of concepts for dealing with display objects:

- Extending display object classes
- Adding objects to the display list
- Layering display objects and working with display object containers
- Responding to display object events
- Using properties and methods of display objects

To get the application files for this sample, see [www.adobe.com/go/learn\\_programmingAS3samples\\_flash](http://www.adobe.com/go/learn_programmingAS3samples_flash). The SpriteArranger application files can be found in the folder Examples/SpriteArranger. The application consists of the following files:

File	Description
SpriteArranger.mxml or SpriteArranger fla	The main application file in Flash (FLA) or Flex (MXML).
com/example/programmingas3/ SpriteArranger/CircleSprite.as	A class defining a type of Sprite object that renders a circle on-screen.
com/example/programmingas3/ SpriteArranger/DrawingCanvas.as	A class defining the canvas, which is a display object container that contains GeometricSprite objects.
com/example/programmingas3/ SpriteArranger/SquareSprite.as	A class defining a type of Sprite object that renders a square on-screen.
com/example/programmingas3/ SpriteArranger/TriangleSprite.as	A class defining a type of Sprite object that renders a triangle on-screen.
com/example/programmingas3/ SpriteArranger/GeometricSprite.as	A class that extends the Sprite object, used to define an on-screen shape. The CircleSprite, SquareSprite, and TriangleSprite each extend this class.
com/example/programmingas3/ geometricshapes/IGeometricShape.as	The base interface defining methods to be implemented by all geometric shape classes.
com/example/programmingas3/ geometricshapes/IPolygon.as	An interface defining methods to be implemented by geometric shape classes that have multiple sides.

File	Description
com/example/programmingas3/geometricshapes/RegularPolygon.as	A type of geometric shape that has sides of equal length positioned symmetrically around the shape's center.
com/example/programmingas3/geometricshapes/Circle.as	A type of geometric shape that defines a circle.
com/example/programmingas3/geometricshapes/EquilateralTriangle.as	A subclass of RegularPolygon that defines a triangle with all sides the same length.
com/example/programmingas3/geometricshapes/Square.as	A subclass of RegularPolygon defining a rectangle with all four sides the same length.
com/example/programmingas3/geometricshapes/GeometricShapeFactory.as	A class containing a "factory method" for creating shapes given a shape type and size.

## Defining the SpriteArranger classes

The SpriteArranger application lets the user add a variety of display objects to the on-screen "canvas."

The DrawingCanvas class defines a drawing area, a type of display object container, to which the user can add on-screen shapes. These on-screen shapes are instances of one of the subclasses of the GeometricSprite class.

### The DrawingCanvas class

The DrawingCanvas class extends the Sprite class, and this inheritance is defined in the DrawingCanvas class declaration, as follows:

```
public class DrawingCanvas extends Sprite
```

The Sprite class is a subclass of the DisplayObjectContainer and DisplayObject classes, and the DrawingCanvas class uses methods and properties of those classes.

The DrawingCanvas() constructor method sets up a Rectangle object, bounds, which is property that is later used in drawing the outline of the canvas. It then calls the initCanvas() method, as follows:

```
this.bounds = new Rectangle(0, 0, w, h);
initCanvas(fillColor, lineColor);
```



As the following example shows, the `initCanvas()` method defines various properties of the `DrawingCanvas` object, which were passed as arguments to the constructor function:

```
this.lineColor = lineColor;
this.fillColor = fillColor;
this.width = 500;
this.height = 200;
```

The `initCanvas()` method then calls the `drawBounds()` method, which draws the canvas using the `DrawingCanvas` class's `graphics` property. The `graphics` property is inherited from the `Shape` class.

```
this.graphics.clear();
this.graphics.strokeStyle(1.0, this.lineColor, 1.0);
this.graphics.beginFill(this.fillColor, 1.0);
this.graphics.drawRect(bounds.left - 1,
                       bounds.top - 1,
                       bounds.width + 2,
                       bounds.height + 2);
this.graphics.endFill();
```

The following additional methods of the `DrawingCanvas` class are invoked based on user interactions with the application:

- The `addShape()` and `describeChildren()` methods, which are described in [“Adding display objects to the canvas” on page 426](#)
- The `moveToBack()`, `moveDown()`, `moveToFront()`, and `moveUp()` methods, which are described in [“Rearranging display object layering” on page 429](#)
- The `onMouseUp()` method, which is described in [“Clicking and dragging display objects” on page 428](#)

## The GeometricSprite class and its subclasses

Each display object the user can add to the canvas is an instance of one of the following subclasses of the GeometricSprite class:

- CircleSprite
- SquareSprite
- TriangleSprite

The GeometricSprite class extends the flash.display.Sprite class:

```
public class GeometricSprite extends Sprite
```

The GeometricSprite class includes a number of properties common to all GeometricSprite objects. These are set in the constructor function based on parameters passed to the function.

For example:

```
this.size = size;  
this.lineColor = lColor;  
this.fillColor = fColor;
```

The `geometricShape` property of the GeometricSprite class defines an IGeometricShape interface, which defines the mathematical properties, but not the visual properties, of the shape. The classes that implement the IGeometricShape interface are defined in the GeometricShapes sample application (see [“Example: GeometricShapes” on page 180](#)).

The GeometricSprite class defines the `drawShape()` method, which is further refined in the override definitions in each subclass of GeometricSprite. For more information, see the [“Adding display objects to the canvas”](#) section, which follows.

The GeometricSprite class also provides the following methods:

- The `onMouseDown()` and `onMouseUp()` methods, which are described in [“Clicking and dragging display objects” on page 428](#)
- The `showSelected()` and `hideSelected()` methods, which are described in [“Clicking and dragging display objects” on page 428](#)

## Adding display objects to the canvas

When the user clicks the Add Shape button, the application calls the `addShape()` method of the DrawingCanvas class. It instantiates a new GeometricSprite by calling the appropriate constructor function of one of the GeometricSprite subclasses, as the following example shows:

```

public function addShape(shapeName:String, len:Number):void
{
    var newShape:GeometricSprite;
    switch (shapeName)
    {
        case "Triangle":
            newShape = new TriangleSprite(len);
            break;

        case "Square":
            newShape = new SquareSprite(len);
            break;

        case "Circle":
            newShape = new CircleSprite(len);
            break;
    }
    newShape.alpha = 0.8;
    this.addChild(newShape);
}

```

Each constructor method calls the `drawShape()` method, which uses the `graphics` property of the class (inherited from the `Sprite` class) to draw the appropriate vector graphic. For example, the `drawShape()` method of the `CircleSprite` class includes the following code:

```

this.graphics.clear();
this.graphics.lineStyle(1.0, this.lineColor, 1.0);
this.graphics.beginFill(this.fillColor, 1.0);
var radius:Number = this.size / 2;
this.graphics.drawCircle(radius, radius, radius);

```

The second to last line of the `addShape()` function sets the `alpha` property of the display object (inherited from the `DisplayObject` class), so that each display object added to the canvas is slightly transparent, letting the user see the objects behind it.

The final line of the `addChild()` method adds the new display object to the child list of the instance of the `DrawingCanvas` class, which is already on the display list. This causes the new display object to appear on the Stage.

The interface for the application includes two text fields, `selectedSpriteTxt` and `outputTxt`. The text properties of these text fields are updated with information about the `GeometricSprite` objects that have been added to the canvas or selected by the user. The `GeometricSprite` class handles this information-reporting task by overriding the `toString()` method, as follows:

```

public override function toString():String
{
    return this.shapeType + " of size " + this.size + " at " + this.x + ", "
        + this.y;
}

```

The `shapeType` property is set to the appropriate value in the constructor method of each `GeometricSprite` subclass. For example, the `toString()` method might return the following value for a `CircleSprite` instance recently added to the `DrawingCanvas` instance:

```
Circle of size 50 at 0, 0
```

The `describeChildren()` method of the `DrawingCanvas` class loops through the canvas's child list, using the `numChildren` property (inherited from the `DisplayObjectContainer` class) to set the limit of the `for` loop. It generates a string listing each child, as follows:

```
var desc:String = "";
var child:DisplayObject;
for (var i:int=0; i < this.numChildren; i++)
{
    child = this.getChildAt(i);
    desc += i + ": " + child + '\n';
}
```

The resulting string is used to set the `text` property of the `outputTxt` text field.

## Clicking and dragging display objects

When the user clicks on a `GeometricSprite` instance, the application calls the `onMouseDown()` event handler. As the following shows, this event handler is set to listen for mouse down events in the constructor function of the `GeometricSprite` class:

```
this.addEventListener(MouseEvent.CLICK, onMouseDown);
```

The `onMouseDown()` method then calls the `showSelected()` method of the `GeometricSprite` object. If it is the first time this method has been called for the object, the method creates a new `Shape` object named `selectionIndicator` and it uses the `graphics` property of the `Shape` object to draw a red highlight rectangle, as follows:

```
this.selectionIndicator = new Shape();
this.selectionIndicator.graphics.lineStyle(1.0, 0xFF0000, 1.0);
this.selectionIndicator.graphics.drawRect(-1, -1, this.size + 1,
    this.size + 1);
this.addChild(this.selectionIndicator);
```

If this is not the first time the `onMouseDown()` method is called, the method simply sets the `selectionIndicator` shape's `visible` property (inherited from the `DisplayObject` class), as follows:

```
this.selectionIndicator.visible = true;
```

The `hideSelected()` method hides the `selectionIndicator` shape of the previously selected object by setting its `visible` property to `false`.

The `onMouseDown()` event handler method also calls the `startDrag()` method (inherited from the `Sprite` class), which includes the following code:

```
var boundsRect:Rectangle = this.parent.getRect(this.parent);
boundsRect.width -= this.size;
boundsRect.height -= this.size;
this.startDrag(false, boundsRect);
```

This lets the user drag the selected object around the canvas, within the boundaries set by the `boundsRect` rectangle.

When the user releases the mouse button, the `mouseUp` event is dispatched. The constructor method of the `DrawingCanvas` sets up the following event listener:

```
this.addEventListener(MouseEvent.CLICK, onMouseUp);
```

This event listener is set for the `DrawingCanvas` object, rather than for the individual `GeometricSprite` objects. This is because when the `GeometricSprite` object is dragged, it could end up behind another display object (another `GeometricSprite` object) when the mouse is released. The display object in the foreground would receive the mouse up event but the display object the user is dragging would not. Adding the listener to the `DrawingCanvas` object ensures that the event is always handled.

The `onMouseUp()` method calls the `onMouseUp()` method of the `GeometricSprite` object, which in turn calls the `stopDrag()` method of the `GeometricSprite` object.

## Rearranging display object layering

The user interface for the application includes buttons labeled `Move Back`, `Move Down`, `Move Up`, and `Move to Front`. When the user clicks one of these buttons, the application calls the corresponding method of the `DrawingCanvas` class: `moveToBack()`, `moveDown()`, `moveUp()`, or `moveToFront()`. For example, the `moveToBack()` method includes the following code:

```
public function moveToBack(shape:GeometricSprite):void
{
    var index:int = this.getChildIndex(shape);
    if (index > 0)
    {
        this.setChildIndex(shape, 0);
    }
}
```

The method uses the `setChildIndex()` method (inherited from the `DisplayObjectContainer` class) to position the display object in index position 0 in the child list of the `DrawingCanvas` instance (`this`).

The `moveDown()` method works similarly, except that it decrements the index position of the display object by 1 in the child list of the `DrawingCanvas` instance:

```
public function moveDown(shape:GeometricSprite):void
{
    var index:int = this.getChildIndex(shape);
    if (index > 0)
    {
        this.setChildIndex(shape, index - 1);
    }
}
```

The `moveUp()` and `moveToFront()` methods work similarly to the `moveToBack()` and `moveDown()` methods.

The `flash.geom` package contains classes that define geometric objects such as points, rectangles, and transformation matrixes. You use these classes to define the properties of objects that are used in other classes.

## Contents

Basics of geometry .....	431
Using Point objects .....	434
Using Rectangle objects .....	436
Using Matrix objects .....	440
Example: Applying a matrix transformation to a display object .....	442

## Basics of geometry

### Introduction to working with geometry

Geometry may be a subject many people try to get through in school while retaining as little as possible, but a little geometry knowledge can be a powerful tool in ActionScript.

The `flash.geom` package contains classes that define geometric objects such as points, rectangles, and transformation matrixes. These classes don't necessarily provide functionality by themselves; however, they are used to define the properties of objects that are used in other classes.

All the geometry classes are based around the notion that locations on the screen are represented as a two-dimensional plane. The screen is treated like a flat graph with a horizontal (*x*) axis and a vertical (*y*) axis. Any location (or *point*) on the screen can be represented as a pair of *x* and *y* values—the *coordinates* of that location.

Every display object, include the Stage, has its own *coordinate space*—essentially its own graph for plotting the locations of child display objects, drawings, and so forth. Commonly, the *origin* (the place with the coordinate 0, 0 where the x and y axes meet) is placed at the top-left corner of the display object. While this is always true for the Stage, it is not necessarily true for any other display object. As in standard two-dimensional coordinate systems, values on the x axis get bigger going toward the right, and smaller going toward the left—for locations to the left of the origin, the x coordinate is negative. However, contrary to traditional coordinate systems, in ActionScript values on the y axis get bigger going down and smaller going up the screen (with values above the origin having a negative y coordinate). Since the top-left corner of the Stage is the origin of its coordinate space, any object on the Stage will have an x coordinate greater than 0 and smaller than the Stage width, and will have a y coordinate larger than 0 and smaller than the Stage height.

You can use Point class instances to represent individual points in a coordinate space. You can create a Rectangle instance to represent a rectangular region in a coordinate space. For advanced users, you can use a Matrix instance to apply multiple or complex transformations to a display object. Many simple transformations, such as rotation, position, and scale changes, can be applied directly to a display object using that object's properties. For more information on applying transformations using display object properties, see [“Manipulating display objects” on page 395](#).

## Common geometry tasks

The following tasks are things you'll likely want to accomplish using the geometry classes in ActionScript:

- Calculating distance between two points
- Determining coordinates of a point in different coordinate spaces
- Moving a display object using angle and distance
- Working with Rectangle instances:
  - Repositioning a Rectangle instance
  - Resizing a Rectangle instance
  - Determining combined size or overlapping areas of Rectangle instances
- Creating Matrix objects
- Using a Matrix object to apply transformations to a display object



## Important concepts and terms

The following reference list contains important terms that you will encounter in this chapter:

- **Cartesian coordinates:** Coordinates are commonly written as a pair of number (like 5, 12 or 17, -23). The two numbers are the x coordinate and the y coordinate, respectively.
- **Coordinate space:** The graph of coordinates contained in a display object, on which its child elements are positioned.
- **Origin:** The point in a coordinate space where the x axis meets the y axis. This point has the coordinate 0, 0.
- **Point:** A single location in a coordinate space. In the 2-d coordinate system used in ActionScript, a point is defined by its location along the x axis and the y axis (the point's coordinates).
- **Registration point:** In a display object, the origin (0, 0 coordinate) of its coordinate space.
- **Scale:** The size of an object relative to its original size. When used as a verb, to scale an object means to change its size by stretching or shrinking the object.
- **Translate:** To change a point's coordinates from one coordinate space to another.
- **Transformation:** An adjustment to a visual characteristic of a graphic, such as rotating the object, altering its scale, skewing or distorting its shape, or altering its color.
- **X axis:** The horizontal axis in the 2-d coordinate system used in ActionScript.
- **Y axis:** The vertical axis in the 2-d coordinate system used in ActionScript.

## Working through in-chapter examples

Many of the examples in this chapter demonstrate calculations or changing values; most of those examples include the appropriate `trace()` function calls to demonstrate the results of the code. To test these examples, do the following:

1. Create an empty Flash document.
2. Select a keyframe in the Timeline.
3. Open the Actions panel and copy the code listing into the Script pane.
4. Run the program using Control > Test Movie.

You will see the results of the code listing's `trace()` functions in the Output panel.

Some of the chapter's examples demonstrate applying transformations to display objects. For those examples, the results of the example will be seen visually rather than through text output. To test the transformation examples, do the following:

1. Create an empty Flash document.
2. Select a keyframe in the Timeline.

3. Open the Actions panel and copy the code listing into the Script pane.
4. Create a movie clip symbol instance on the Stage. For example, draw a shape, select it, choose **Modify > Convert to symbol**, and give the symbol a name.
5. With the Stage movie clip selected, in the Property inspector, give the instance an instance name. The name should match the name used for the display object in the example code listing—for example, if the code listing applies a transformation to an object named `myDisplayObject`, you should name your movie clip instance `myDisplayObject` as well.
6. Run the program using **Control > Test Movie**.  
On the screen you will see the results of the transformations applied to the object as specified in the code listing.

Techniques for testing example code listings are explained in more detail in [“Testing in-chapter example code listings” on page 63](#).

## Using Point objects

A `Point` object defines a Cartesian pair of coordinates. It represents location in a two-dimensional coordinate system, where  $x$  represents the horizontal axis and  $y$  represents the vertical axis.

To define a `Point` object, you set its  $x$  and  $y$  properties, as follows:

```
import flash.geom.*;
var pt1:Point = new Point(10, 20); // x == 10; y == 20
var pt2:Point = new Point();
pt2.x = 10;
pt2.y = 20;
```

## Finding the distance between two points

You can use the `distance()` method of the `Point` class to find the distance between two points in a coordinate space. For example, the following code finds the distance between the registration points of two display objects, `circle1` and `circle2`, in the same display object container:

```
import flash.geom.*;
var pt1:Point = new Point(circle1.x, circle1.y);
var pt2:Point = new Point(circle2.x, circle2.y);
var distance:Number = Point.distance(pt1, pt2);
```

## Translating coordinate spaces

If two display objects are in different display object containers, they may be in different coordinate spaces. You can use the `localToGlobal()` method of the `DisplayObject` class to translate the coordinates to the same (global) coordinate space, that of the Stage. For example, the following code finds the distance between the registration points of two display objects, `circle1` and `circle2`, in the different display object containers:

```
import flash.geom.*;
var pt1:Point = new Point(circle1.x, circle1.y);
pt1 = circle1.localToGlobal(pt1);
var pt2:Point = new Point(circle1.x, circle1.y);
pt2 = circle2.localToGlobal(pt2);
var distance:Number = Point.distance(pt1, pt2);
```

Similarly, to find the distance of the registration point of a display object named `target` from a specific point on the Stage, you can use the `localToGlobal()` method of the `DisplayObject` class:

```
import flash.geom.*;
var stageCenter:Point = new Point();
stageCenter.x = this.stage.stageWidth / 2;
stageCenter.y = this.stage.stageHeight / 2;
var targetCenter:Point = new Point(target.x, target.y);
targetCenter = target.localToGlobal(targetCenter);
var distance:Number = Point.distance(stageCenter, targetCenter);
```

## Moving a display object by a specified angle and distance

You can use the `polar()` method of the `Point` class to move a display object a specific distance by a specific angle. For example, the following code moves the `myDisplayObject` object 100 pixels by 60 degrees:

```
import flash.geom.*;
var distance:Number = 100;
var angle:Number = 2 * Math.PI * (90 / 360);
var translatePoint:Point = Point.polar(distance, angle);
myDisplayObject.x += translatePoint.x;
myDisplayObject.y += translatePoint.y;
```

## Other uses of the Point class

You can use Point objects with the following methods and properties:

Class	Methods or properties	Description
DisplayObjectContainer	<code>areInaccessibleObjectsUnderPoint()</code> <code>getObjectsUnderPoint()</code>	Used to return a list of objects under a point in a display object container.
BitmapData	<code>hitTest()</code>	Used to define the pixel in the BitmapData object as well as the point that you are checking for a hit.
BitmapData	<code>applyFilter()</code> <code>copyChannel()</code> <code>merge()</code> <code>paletteMap()</code> <code>pixelDissolve()</code> <code>threshold()</code>	Used to define the positions of rectangles that define the operations.
Matrix	<code>deltaTransformPoint()</code> <code>transformPoint()</code>	Used to define points for which you want to apply a transformation.
Rectangle	<code>bottomRight</code> <code>size</code> <code>topLeft</code>	Used to define these properties.

## Using Rectangle objects

A Rectangle object defines a rectangular area. A Rectangle object has a position, defined by the `x` and `y` coordinates of its top-left corner, a `width` property, and a `height` property. You can define these properties for a new Rectangle object by invoking the `Rectangle()` constructor function, as follows:

```
import flash.geom.Rectangle;
var rx:Number = 0;
var ry:Number = 0;
var rwidth:Number = 100;
var rheight:Number = 50;
var rect1:Rectangle = new Rectangle(rx, ry, rwidth, rheight);
```

## Resizing and repositioning Rectangle objects

There are a number of ways to resize and reposition Rectangle objects.

You can directly reposition the Rectangle object by changing its `x` and `y` properties. This has no effect on the width or height of the Rectangle object.

```
import flash.geom.Rectangle;
var x1:Number = 0;
var y1:Number = 0;
var width1:Number = 100;
var height1:Number = 50;
var rect1:Rectangle = new Rectangle(x1, y1, width1, height1);
trace(rect1) // (x=0, y=0, w=100, h=50)
rect1.x = 20;
rect1.y = 30;
trace(rect1); // (x=20, y=30, w=100, h=50)
```

As the following code shows, if you change the `left` or `top` property of a Rectangle object, it is also repositioned, with its `x` and `y` properties matching the `left` and `top` properties, respectively. However, the position of the bottom-left corner of the Rectangle object does not change, so it is resized.

```
import flash.geom.Rectangle;
var x1:Number = 0;
var y1:Number = 0;
var width1:Number = 100;
var height1:Number = 50;
var rect1:Rectangle = new Rectangle(x1, y1, width1, height1);
trace(rect1) // (x=0, y=0, w=100, h=50)
rect1.left = 20;
rect1.top = 30;
trace(rect1); // (x=30, y=20, w=70, h=30)
```

Similarly, as the following example shows, if you change the `bottom` or `right` property of a Rectangle object, the position of its top-left corner does not change, so it is resized accordingly:

```
import flash.geom.Rectangle;
var x1:Number = 0;
var y1:Number = 0;
var width1:Number = 100;
var height1:Number = 50;
var rect1:Rectangle = new Rectangle(x1, y1, width1, height1);
trace(rect1) // (x=0, y=0, w=100, h=50)
rect1.right = 60;
rect1.bottom = 20;
trace(rect1); // (x=0, y=0, w=60, h=20)
```

You can also reposition a `Rectangle` object by using the `offset()` method, as follows:

```
import flash.geom.Rectangle;
var x1:Number = 0;
var y1:Number = 0;
var width1:Number = 100;
var height1:Number = 50;
var rect1:Rectangle = new Rectangle(x1, y1, width1, height1);
trace(rect1) // (x=0, y=0, w=100, h=50)
rect1.offset(20, 30);
trace(rect1); // (x=20, y=30, w=100, h=50)
```

The `offsetPt()` method works similarly, except that it takes a `Point` object as its parameter, rather than *x* and *y* offset values.

You can also resize a `Rectangle` object by using the `inflate()` method, which includes two parameters, *dx* and *dy*. The *dx* parameter represents the number of pixels that the left and right sides of the rectangle will move from the center, and the *dy* parameter represents the number of pixels that the top and bottom of the rectangle will move from the center:

```
import flash.geom.Rectangle;
var x1:Number = 0;
var y1:Number = 0;
var width1:Number = 100;
var height1:Number = 50;
var rect1:Rectangle = new Rectangle(x1, y1, width1, height1);
trace(rect1) // (x=0, y=0, w=100, h=50)
rect1.inflate(6,4);
trace(rect1); // (x=-6, y=-4, w=112, h=58)
```

The `inflatePt()` method works similarly, except that it takes a `Point` object as its parameter, rather than *dx* and *dy* values.

## Finding unions and intersections of `Rectangle` objects

You use the `union()` method to find the rectangular region formed by the boundaries of two rectangles:

```
import flash.display.*;
import flash.geom.Rectangle;
var rect1:Rectangle = new Rectangle(0, 0, 100, 100);
trace(rect1); // (x=0, y=0, w=100, h=100)
var rect2:Rectangle = new Rectangle(120, 60, 100, 100);
trace(rect2); // (x=120, y=60, w=100, h=100)
trace(rect1.union(rect2)); // (x=0, y=0, w=220, h=160)
```

You use the `intersection()` method to find the rectangular region formed by the overlapping region of two rectangles:

```
import flash.display.*;
import flash.geom.Rectangle;
var rect1:Rectangle = new Rectangle(0, 0, 100, 100);
trace(rect1); // (x=0, y=0, w=100, h=100)
var rect2:Rectangle = new Rectangle(80, 60, 100, 100);
trace(rect2); // (x=120, y=60, w=100, h=100)
trace(rect1.intersection(rect2)); // (x=80, y=60, w=20, h=40)
```

You use the `intersects()` method to find out whether two rectangles intersect. You can also use the `intersects()` method to find out whether a display object is in a certain region of the Stage. For example, in the following code, assume that the coordinate space of the display object container that contains the `circle` object is the same as that of the Stage. The example shows how to use the `intersects()` method to determine if a display object, `circle`, intersects specified regions of the Stage, defined by the `target1` and `target2` `Rectangle` objects:

```
import flash.display.*;
import flash.geom.Rectangle;
var circle:Shape = new Shape();
circle.graphics.lineStyle(2, 0xFF0000);
circle.graphics.drawCircle(250, 250, 100);
addChild(circle);
var circleBounds:Rectangle = circle.getBounds(stage);
var target1:Rectangle = new Rectangle(0, 0, 100, 100);
trace(circleBounds.intersects(target1)); // false
var target2:Rectangle = new Rectangle(0, 0, 300, 300);
trace(circleBounds.intersects(target2)); // true
```

Similarly, you can use the `intersects()` method to find out whether the bounding rectangles of two display objects overlap. You can use the `getRect()` method of the `DisplayObject` class to include any additional space that the strokes of a display object may add to a bounding region.

## Other uses of Rectangle objects

Rectangle objects are used in the following methods and properties:

Class	Methods or properties	Description
BitmapData	applyFilter(), colorTransform(), copyChannel(), copyPixels(), draw(), fillRect(), generateFilterRect(), getColorBoundsRect(), getPixels(), merge(), paletteMap(), pixelDissolve(), setPixels(), and threshold()	Used as the type for some parameters to define a region of the BitmapData object.
DisplayObject	getBounds(), getRect(), scrollRect, scale9Grid	Used as the data type for the property or the data type returned.
PrintJob	addPage()	Used to define the printArea parameter.
Sprite	startDrag()	Used to define the bounds parameter.
TextField	getCharBoundaries()	Used as the return value type.
Transform	pixelBounds	Used as the data type.

## Using Matrix objects

The Matrix class represents a transformation matrix that determines how to map points from one coordinate space to another. You can perform various graphical transformations on a display object by setting the properties of a Matrix object, applying that Matrix object to the `matrix` property of a Transform object, and then applying that Transform object as the `transform` property of the display object. These transformation functions include translation ( $x$  and  $y$  repositioning), rotation, scaling, and skewing.



## Defining Matrix objects

Although you could define a matrix by directly adjusting the properties (*a*, *b*, *c*, *d*, *tx*, *ty*) of a Matrix object, it is easier to use the `createBox()` method. This method includes parameters that let you directly define the scaling, rotation, and translation effects of the resulting matrix. For example, the following code creates a Matrix object that has the effect of scaling an object horizontally by 2.0, scaling it vertically by 3.0, rotating it by 45 degrees, moving (translating) it 10 pixels to the right, and moving it 20 pixels down:

```
var matrix:Matrix = new Matrix();
var scaleX:Number = 2.0;
var scaleY:Number = 3.0;
var rotation:Number = 2 * Math.PI * (45 / 360);
var tx:Number = 10;
var ty:Number = 20;
matrix.createBox(scaleX, scaleY, rotation, tx, ty);
```

You can also adjust the scaling, rotation, and translation effects of a Matrix object by using the `scale()`, `rotate()`, and `translate()` methods. Note that these methods combine with the values of the existing Matrix object. For instance, the following code sets a Matrix object that scales an object by a factor of 4 and rotates it 60 degrees, since the `scale()` and `rotate()` methods are called twice:

```
var matrix:Matrix = new Matrix();
var rotation:Number = 2 * Math.PI * (30 / 360); // 30°
var scaleFactor:Number = 2;
matrix.scale(scaleFactor, scaleFactor);
matrix.rotate(rotation);
matrix.scale(scaleX, scaleY);
matrix.rotate(rotation);
```

```
myDisplayObject.transform.matrix = matrix;
```

To apply a skew transformation to a Matrix object, adjust its *b* or *c* property. Adjusting the *b* property skews the matrix vertically, and adjusting the *c* property skews the matrix horizontally. The following code skews the `myMatrix` Matrix object vertically by a factor of 2:

```
var skewMatrix:Matrix = new Matrix();
skewMatrix.b = Math.tan(2);
myMatrix.concat(skewMatrix);
```

You can apply a Matrix transformation to the `transform` property of a display object. For example, the following code applies a matrix transformation to a display object named `myDisplayObject`:

```
var matrix:Matrix = myDisplayObject.transform.matrix;
var scaleFactor:Number = 2;
var rotation:Number = 2 * Math.PI * (60 / 360); // 60°
matrix.scale(scaleFactor, scaleFactor);
matrix.rotate(rotation);
```

```
myDisplayObject.transform.matrix = matrix;
```

The first line sets a Matrix object to the existing transformation matrix used by the `myDisplayObject` display object (the `matrix` property of the `transform` property of the `myDisplayObject` display object). This way, the Matrix class methods that you call will have a cumulative effect on the display object's existing position, scale, and rotation.

NOTE

The `ColorTransform` class is also included in the `flash.geometry` package. This class is used to set the `colorTransform` property of a Transform object. Since it does not apply any sort of geometrical transformation, it is not discussed in this chapter. For more information, see the `ColorTransform` class in the *ActionScript 3.0 Language and Components Reference*.

## Example: Applying a matrix transformation to a display object

The `DisplayObjectTransformer` sample application shows a number of features of using the Matrix class to transform a display object, including the following:

- Rotating the display object
- Scaling the display object
- Translating (repositioning) the display object
- Skewing the display object

The application provides an interface for adjusting the parameters of the matrix transformation, as follows:

**Scale, Move, Rotate and Skew**

Set the values below, then click Transform to see their combined effect on the image to the right.

Scale X (%): 0 100 200

Scale Y (%): 0 100 200

Move X (Pixels): -100 0 100

Move Y (Pixels): -100 0 100

Rotate (°): -360 0 360

Skew Mode:  Slide right-hand side down  
 Slide bottom side to right

Skew angle (°): -90 0 90

**Transform** **Reset**

When the user clicks the Transform button, the application applies the appropriate transformation.



*The original display object, and the display object rotated by  $-45^\circ$  and scaled by 50%*

To get the application files for this sample, see [www.adobe.com/go/learn\\_programmingAS3samples\\_flash](http://www.adobe.com/go/learn_programmingAS3samples_flash). The DisplayObjectTransformer application files can be found in the folder Samples/DisplayObjectTransformer. The application consists of the following files:

File	Description
DisplayObjectTransformer.mxml or DisplayObjectTransformer.fla	The main application file in Flash (FLA) or Flex (MXML)
com/example/programmingas3/geometry/ MatrixTransformer.as	A class that contains methods for applying matrix transformations.
img/	A directory containing sample image files used by the application.

## Defining the MatrixTransformer class

The MatrixTransformer class includes static methods that apply geometric transformations of Matrix objects.

### The transform() method

The transform() method includes parameters for each of the following:

- `sourceMatrix`—The input matrix, which the method transforms
- `xScale` and `yScale`—The *x* and *y* scale factor
- `dx` and `dy`—The *x* and *y* translation amounts, in pixels
- `rotation`—The rotation amount, in degrees
- `skew`—The skew factor, as a percentage
- `skewType`—The direction in which the skew, either "right" or "left"

The return value is the resulting matrix.

The transform() method calls the following static methods of the class:

- `skew()`
- `scale()`
- `translate()`
- `rotate()`

Each returns the source matrix with the applied transformation.

## The skew() method

The `skew()` method skews the matrix by adjusting the `b` and `c` properties of the matrix. An optional parameter, `unit`, determines the units used to define the skew angle, and if necessary, the method converts the `angle` value to radians:

```
if (unit == "degrees")
{
    angle = Math.PI * 2 * angle / 360;
}
if (unit == "gradients")
{
    angle = Math.PI * 2 * angle / 100;
}
```

A `skewMatrix` `Matrix` object is created and adjusted to apply the skew transformation.

Initially, it is the identity matrix, as follows:

```
var skewMatrix:Matrix = new Matrix();
```

The `skewSide` parameter determines the side to which the skew is applied. If it is set to "right", the following code sets the `b` property of the matrix:

```
skewMatrix.b = Math.tan(angle);
```

Otherwise, the bottom side is skewed by adjusting the `c` property of the `Matrix`, as follows:

```
skewMatrix.c = Math.tan(angle);
```

The resulting skew is then applied to the existing matrix by concatenating the two matrixes, as the following example shows:

```
sourceMatrix.concat(skewMatrix);
return sourceMatrix;
```

## The scale() method

As the following example shows, the `scale()` method first adjusts the scale factor if it is provided as a percentage, and then uses the `scale()` method of the matrix object:

```
if (percent)
{
    xScale = xScale / 100;
    yScale = yScale / 100;
}
sourceMatrix.scale(xScale, yScale);
return sourceMatrix;
```

## The translate() method

The `translate()` method simply applies the `dx` and `dy` translation factors by calling the `translate()` method of the matrix object, as follows:

```
sourceMatrix.translate(dx, dy);
return sourceMatrix;
```

## The rotate() method

The `rotate()` method converts the input rotation factor to radians (if it is provided in degrees or gradients), and then calls the `rotate()` method of the matrix object:

```
if (unit == "degrees")
{
    angle = Math.PI * 2 * angle / 360;
}
if (unit == "gradients")
{
    angle = Math.PI * 2 * angle / 100;
}
sourceMatrix.rotate(angle);
return sourceMatrix;
```

## Calling the `MatrixTransformer.transform()` method from the application

The application contains a user interface for getting the transformation parameters from the user. It then passes these, along with the `matrix` property of the `transform` property of the display object, to the `Matrix.transform()` method, as follows:

```
tempMatrix = MatrixTransformer.transform(tempMatrix,
                                         xScaleSlider.value,
                                         yScaleSlider.value,
                                         dxSlider.value,
                                         dySlider.value,
                                         rotationSlider.value,
                                         skewSlider.value,
                                         skewSide );
```

The application then applies the return value to the `matrix` property of the `transform` property of the display object, thereby triggering the transformation:

```
img.content.transform.matrix = tempMatrix;
```

Although imported images and artwork are important, the functionality known as the drawing API, which allows you to draw lines and shapes in ActionScript, gives you the freedom to start an application with the computer equivalent of a blank canvas, on which you can create whatever images you wish. The ability to create your own graphics opens up broad possibilities for your applications. With the techniques covered in this chapter you can create a drawing program, make animated, interactive art, or programmatically create your own user interface elements, among many possibilities.

## Contents

Basics of using the drawing API .....	448
Understanding the Graphics class .....	450
Drawing lines and curves .....	450
Drawing shapes using built-in methods .....	453
Creating gradient lines and fills .....	454
Using the Math class with drawing methods .....	460
Animating with the drawing API .....	461
Example: Algorithmic Visual Generator .....	462

# Basics of using the drawing API

## Introduction to using the drawing API

The drawing API is the name for the functionality built into ActionScript that allows you to create vector graphics—lines, curves, shapes, fills, and gradients—and display them on the screen using ActionScript. The `flash.display.Graphics` class provides this functionality. You can draw with ActionScript on any `Shape`, `Sprite`, or `MovieClip` instance, using the `graphics` property defined in each of those classes. (Each of those classes' `graphics` property is in fact an instance of the `Graphics` class.)

If you're just getting started with drawing with code, the `Graphics` class includes several methods that make it easy to draw common shapes like circles, ellipses, rectangles, and rectangles with rounded corners. You can draw them as empty lines or filled shapes. When you need more advanced functionality, the `Graphics` class also includes methods for drawing lines and quadratic Bézier curves, which you can use in conjunction with the trigonometry functions in the `Math` class to create any shape you need.

## Common drawing API tasks

The following tasks are things you'll likely want to accomplish using the drawing API in ActionScript, which are described in this chapter:

- Defining line styles and fill styles for drawing shapes
- Drawing straight lines and curves
- Using methods for drawing shapes such as circles, ellipses, and rectangles
- Drawing with gradient lines and fills
- Defining a matrix for creating a gradient
- Using trigonometry with the drawing API
- Incorporating the drawing API into animation

## Important concepts and terms

The following reference list contains important terms that you will encounter in this chapter:

- **Anchor point:** One of the two end points of a quadratic Bézier curve.
- **Control point:** The point that defines the direction and amount of curve of a quadratic Bézier curve. The curved line never reaches the control point; however, the line curves as though being drawn toward the control point.



- **Coordinate space:** The graph of coordinates contained in a display object, on which its child elements are positioned.
- **Fill:** The solid inner portion of a shape that has a line filled in with color, or all of a shape that has no outline.
- **Gradient:** A color that consists of a gradual transition from one color to one or more other colors (as opposed to a solid color).
- **Point:** A single location in a coordinate space. In the 2-d coordinate system used in ActionScript, a point is defined by its location along the x axis and the y axis (the point's coordinates).
- **Quadratic Bézier curve:** A type of curve defined by a particular mathematical formula. In this type of curve, the shape of the curve is calculated based on the positions of the anchor points (the end points of the curve) and a control point that defines the amount and direction of the curve.
- **Scale:** The size of an object relative to its original size. When used as a verb, to scale an object means to change its size by stretching or shrinking the object.
- **Stroke:** The outline portion of a shape that has a line filled in with color, or the lines of an un-filled shape.
- **Translate:** To change a point's coordinates from one coordinate space to another.
- **X axis:** The horizontal axis in the 2-d coordinate system used in ActionScript.
- **Y axis:** The vertical axis in the 2-d coordinate system used in ActionScript.

## Working through in-chapter examples

While you're working through the chapter you may want to test some of the example code listings. Because this chapter deals with drawing visual content, testing the code listings involves running the code and viewing the results in the SWF that's created. To test the code listings:

1. Create an empty Flash document.
2. Select a keyframe in the Timeline.
3. Open the Actions panel and copy the code listing into the Script pane.
4. Run the program using Control > Test Movie.

You will see the results of the code listing in the SWF file that's created.

# Understanding the Graphics class

Each Shape, Sprite, and MovieClip object has a `graphics` property, which is an instance of the Graphics class. The Graphics class includes properties and methods for drawing lines, fills, and shapes. If you want a display object to use solely as a canvas for drawing content, you can use a Shape instance. A Shape instance will perform better than other display objects for drawing, because it doesn't have the overhead of the additional functionality in the Sprite and MovieClip classes. If you want a display object on which you can draw graphical content and also want that object to contain other display objects, you can use a Sprite instance. For more information on determining which display object to use for various tasks, see [“Choosing a DisplayObject subclass” on page 393](#).

## Drawing lines and curves

All drawing that you do with a Graphics instance is based on basic drawing with lines and curves. Consequently, all ActionScript drawing must be performed using the same series of steps:

- Define line and fill styles
- Set the initial drawing position
- Draw lines, curves, and shapes (optionally moving the drawing point)
- If necessary, finish creating a fill

## Defining line and fill styles

To draw with the `graphics` property of a Shape, Sprite, or MovieClip instance, you must first define the style (line size and color, fill color) to use when drawing. Just like when you use the drawing tools in Adobe Flash CS3 Professional or another drawing application, when you're using ActionScript to draw you can draw with or without a stroke, and with or without a fill color. You specify the appearance of the stroke using the `lineStyle()` or `lineGradientStyle()` method. To create a solid line, use the `lineStyle()` method. When calling this method, the most common values you'll specify are the first three parameters: line thickness, color, and alpha. For example, this line of code tells the Shape named `myShape` to draw lines that are 2 pixels thick, red (0x990000), and 75% opaque:

```
myShape.graphics.lineStyle(2, 0x990000, .75);
```

The default value for the alpha parameter is 1.0 (100%), so you can leave that parameter off if you want a completely opaque line. The `LineStyle()` method also accepts two additional parameters for pixel hinting and scale mode; for more information about using those parameters see the description of the `Graphics.LineStyle()` method in the *ActionScript 3.0 Language and Components Reference*.

To create a gradient line, use the `lineGradientStyle()` method. This method is described in [“Creating gradient lines and fills” on page 454](#).

If you want to create a filled shape, you call the `beginFill()`, `beginGradientFill()`, or `beginBitmapFill()` methods before starting the drawing. The most basic of these, the `beginFill()` method, accepts two parameters: the fill color, and (optionally) an alpha value for the fill color. For example, if you want to draw a shape with a solid green fill, you would use the following code (assuming you’re drawing on an object named `myShape`):

```
myShape.graphics.beginFill(0x00FF00);
```

Calling any fill method implicitly ends any previous fill before starting a new one. Calling any method that specifies a stroke style replaces the previous stroke, but does not alter a previously specified fill, and vice versa.

Once you have specified the line style and fill properties, the next step is to indicate the starting point for your drawing. The `Graphics` instance has a drawing point, like the tip of a pen on a piece of paper. Wherever the drawing point is located, that is where the next drawing action will begin. Initially a `Graphics` object begins with its drawing point at the point 0, 0 in the coordinate space of the object on which it’s drawing. To start the drawing at a different point, you can first call the `moveTo()` method before calling one of the drawing methods. This is analogous to lifting the pen tip off of the paper and moving it to a new position.

With the drawing point in place you draw using a series of calls to the drawing methods `lineTo()` (for drawing straight lines) and `curveTo()` (for drawing curved lines).

**TIP**

While you are drawing, you can call the `moveTo()` method at any time to move the drawing point to a new position without drawing.

While drawing, if you have specified a fill color, you can tell Adobe Flash Player to close off the fill by calling the `endFill()` method. If you have not drawn a closed shape (in other words, if at the time you call `endFill()` the drawing point is not at the starting point of the shape), when you call the `endFill()` method Flash Player automatically closes the shape by drawing a straight line from the current drawing point to the location specified in the most recent `moveTo()` call. If you have started a fill and not called `endFill()`, calling `beginFill()` (or one of the other fill methods) closes the current fill and starts the new one.

## Drawing straight lines

When you call the `lineTo()` method, the `Graphics` object draws a straight line from the current drawing point to the coordinates you specify as the two parameters in the method call, drawing with the line style you have specified. For example, this line of code puts the drawing point at the point 100, 100 then draws a line to the point 200, 200:

```
myShape.graphics.moveTo(100, 100);
myShape.graphics.lineTo(200, 200);
```

The following example draws red and green triangles with a height of 100 pixels:

```
var triangleHeight:uint = 100;
var triangle:Shape = new Shape();

// red triangle, starting at point 0, 0
triangle.graphics.beginFill(0xFF0000);
triangle.graphics.moveTo(triangleHeight/2, 0);
triangle.graphics.lineTo(triangleHeight, triangleHeight);
triangle.graphics.lineTo(0, triangleHeight);
triangle.graphics.lineTo(triangleHeight/2, 0);

// green triangle, starting at point 200, 0
triangle.graphics.beginFill(0x00FF00);
triangle.graphics.moveTo(200 + triangleHeight/2, 0);
triangle.graphics.lineTo(200 + triangleHeight, triangleHeight);
triangle.graphics.lineTo(200, triangleHeight);
triangle.graphics.lineTo(200 + triangleHeight/2, 0);

this.addChild(triangle);
```

## Drawing curves

The `curveTo()` method draws a quadratic Bézier curve. This draws an arc that connects two points (called anchor points) while bending toward a third point (called the control point). The `Graphics` object uses the current drawing position as the first anchor point. When you call the `curveTo()` method, you pass four parameters: the *x* and *y* coordinates of the control point, followed by the *x* and *y* coordinates of the second anchor point. For example, the following code draws a curve starting at point 100, 100 and ending at point 200, 200. Because the control point is at point 175, 125, this creates a curve that moves to the right and then downward:

```
myShape.graphics.moveTo(100, 100);
myShape.graphics.curveTo(175, 125, 200, 200);
```

The following example draws red and green circular objects with a width and height of 100 pixels. Note that due to the nature of the quadratic Bézier equation, these are not perfect circles:

```

var size:uint = 100;
var roundObject:Shape = new Shape();

// red circular shape
roundObject.graphics.beginFill(0xFF0000);
roundObject.graphics.moveTo(size / 2, 0);
roundObject.graphics.curveTo(size, 0, size, size / 2);
roundObject.graphics.curveTo(size, size, size / 2, size);
roundObject.graphics.curveTo(0, size, 0, size / 2);
roundObject.graphics.curveTo(0, 0, size / 2, 0);

// green circular shape
roundObject.graphics.beginFill(0x00FF00);
roundObject.graphics.moveTo(200 + size / 2, 0);
roundObject.graphics.curveTo(200 + size, 0, 200 + size, size / 2);
roundObject.graphics.curveTo(200 + size, size, 200 + size / 2, size);
roundObject.graphics.curveTo(200, size, 200, size / 2);
roundObject.graphics.curveTo(200, 0, 200 + size / 2, 0);

this.addChild(roundObject);

```

## Drawing shapes using built-in methods

For convenience when drawing common shapes such as circles, ellipses, rectangles, and rectangles with rounded corners, ActionScript 3.0 has methods that draw these common shapes for you. These are the `drawCircle()`, `drawEllipse()`, `drawRect()`, `drawRoundRect()`, and `drawRoundRectComplex()` methods of the `Graphics` class. These methods may be used in place of the `lineTo()` and `curveTo()` methods. Note, however, that you must still specify line and fill styles before calling these methods.

The following example recreates the example of drawing red, green, and blue squares with width and height of 100 pixels. This code uses the `drawRect()` method, and additionally specifies that the fill color has an alpha of 50% (0.5):

```

var squareSize:uint = 100;
var square:Shape = new Shape();
square.graphics.beginFill(0xFF0000, 0.5);
square.graphics.drawRect(0, 0, squareSize, squareSize);
square.graphics.beginFill(0x00FF00, 0.5);
square.graphics.drawRect(200, 0, squareSize, squareSize);
square.graphics.beginFill(0x0000FF, 0.5);
square.graphics.drawRect(400, 0, squareSize, squareSize);
square.graphics.endFill();
this.addChild(square);

```

In a `Sprite` or `MovieClip` object, the drawing content created with the `graphics` property always appears behind all child display objects that are contained by the object. Also, the `graphics` property content is not a separate display object so it does not appear in the list of a `Sprite` or `MovieClip` object's children. For example, the following `Sprite` object has a circle drawn with its `graphics` property, and it has a `TextField` object in its list of child display objects:

```
var mySprite:Sprite = new Sprite();
mySprite.graphics.beginFill(0xFFCC00);
mySprite.graphics.drawCircle(30, 30, 30);
var label:TextField = new TextField();
label.width = 200;
label.text = "They call me mellow yellow...";
label.x = 20;
label.y = 20;
mySprite.addChild(label);
this.addChild(mySprite);
```

Note that the `TextField` appears on top of the circle drawn with the `graphics` object.

## Creating gradient lines and fills

The `graphics` object can also draw strokes and fills with gradients rather than solid colors. A gradient stroke is created with the `lineGradientStyle()` method and a gradient fill is created with the `beginGradientFill()` method.

Both methods accept the same parameters. The first four are required: type, colors, alphas, and ratios. The remaining four are optional but are useful for advanced customization.

- The first parameter specifies the type of gradient you are creating. Acceptable values are `GradientFill.LINEAR` or `GradientFill.RADIAL`.
- The second parameter specifies the array of the color values to use. In a linear gradient, the colors will be arranged from left to right. In a radial gradient, they will be arranged from inside to outside. The order of the colors of the array represents the order that the colors will be drawn in the gradient.
- The third parameter specifies the alpha transparency values of the corresponding colors in the previous parameter.
- The fourth parameter specifies ratios, or the emphasis each color has within the gradient. Acceptable values range from 0-255. These values do not represent any width or height, but rather the position within the gradient; 0 represents the beginning of the gradient, 255 represents the end of the gradient. The array of ratios must increase sequentially and have the same number of entries as both the color and alpha arrays specified in the second and third parameters.

Although the fifth parameter, the transformation matrix, is optional, it is commonly used because it provides an easy and powerful way to control the gradient's appearance. This parameter accepts a `Matrix` instance. The easiest way to create a `Matrix` object for a gradient is to use the `Matrix` class's `createGradientBox()` method.

## Defining a `Matrix` object for use with a gradient

You use the `beginGradientFill()` and `lineGradientStyle()` methods of the `flash.display.Graphics` class to define gradients for use in shapes. When you define a gradient, you supply a matrix as one of the parameters of these methods.

The easiest way to define the matrix is by using the `Matrix` class's `createGradientBox()` method, which creates a matrix that is used to define the gradient. You define the scale, rotation, and position of the gradient using the parameters passed to the `createGradientBox()` method. The `createGradientBox()` method accepts the following parameters:

- Gradient box width: the width (in pixels) to which the gradient will spread
- Gradient box height: the height (in pixels) to which the gradient will spread
- Gradient box rotation: the rotation (in radians) that will be applied to the gradient
- Horizontal translation: how far (in pixels) the gradient is shifted horizontally
- Vertical translation: how far (in pixels) the gradient is shifted vertically

For example, consider a gradient with the following characteristics:

- `GradientType.LINEAR`
- Two colors, green and blue, with the `ratios` array set to `[0, 255]`
- `SpreadMethod.PAD`
- `InterpolationMethod.LINEAR_RGB`

The following examples show gradients in which the `rotation` parameter of the `createGradientBox()` method differs as indicated, but all other settings stay the same:

---

```
width = 100;  
height = 100;  
rotation = 0;  
tx = 0;  
ty = 0;
```



```
width = 100;  
height = 100;  
rotation = Math.PI/4; // 45°  
tx = 0;  
ty = 0;
```

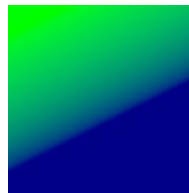

```
width = 100;  
height = 100;  
rotation = Math.PI/2; // 90°  
tx = 0;  
ty = 0;
```





The following examples show the effects on a green-to-blue linear gradient in which the rotation, tx, and ty parameters of the createGradientBox() method differ as indicated, but all other settings stay the same:

---

```
width = 50;
height = 100;
rotation = 0;
tx = 0;
ty = 0;
```

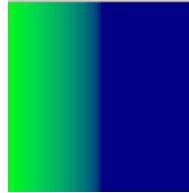

```
width = 50;
height = 100;
rotation = 0;
tx = 50;
ty = 0;
```

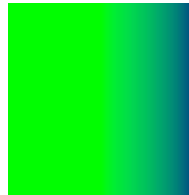

```
width = 100;
height = 50;
rotation = Math.PI/2; // 90°
tx = 0;
ty = 0;
```

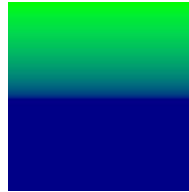

```
width = 100;
height = 50;
rotation = Math.PI/2; // 90°
tx = 0;
ty = 50;
```

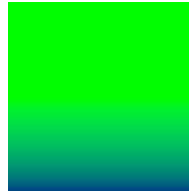

---

The width, height, tx, and ty parameters of the createGradientBox() method affect the size and position of a *radial* gradient fill as well, as the following example shows:

---

```
width = 50;
height = 100;
rotation = 0;
tx = 25;
ty = 0;
```

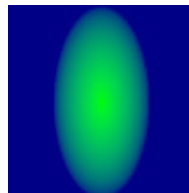

The following code produces the last radial gradient illustrated:

```
import flash.display.Shape;
import flash.display.GradientType;
import flash.geom.Matrix;

var type:String = GradientType.RADIAL;
var colors:Array = [0x00FF00, 0x000088];
var alphas:Array = [1, 1];
var ratios:Array = [0, 255];
var spreadMethod:String = SpreadMethod.PAD;
var interp:String = InterpolationMethod.LINEAR_RGB;
var focalPtRatio:Number = 0;

var matrix:Matrix = new Matrix();
var boxWidth:Number = 50;
var boxHeight:Number = 100;
var boxRotation:Number = Math.PI/2; // 90°
var tx:Number = 25;
var ty:Number = 0;
matrix.createGradientBox(boxWidth, boxHeight, boxRotation, tx, ty);

var square:Shape = new Shape;
square.graphics.beginGradientFill(type,
    colors,
    alphas,
    ratios,
    matrix,
    spreadMethod,
    interp,
    focalPtRatio);
square.graphics.drawRect(0, 0, 100, 100);
addChild(square);
```

Note that the width and height of the gradient fill is determined by the width and height of the gradient matrix rather than the width or height that is drawn using the Graphics object. When drawing with the Graphics object, you draw what exists at those coordinates in the gradient matrix. Even if you use one of the shape methods of a Graphics object such as `drawRect()`, the gradient does not stretch itself to the size of the shape that is drawn—the gradient's size must be specified in the gradient matrix itself.

The following illustrates the visual difference between the dimensions of the gradient matrix and the dimensions of the draw itself:

```
var myShape:Shape = new Shape();
var gradientBoxMatrix:Matrix = new Matrix();
gradientBoxMatrix.createGradientBox(100, 40, 0, 0, 0);
myShape.graphics.beginGradientFill(GradientType.LINEAR, [0xFF0000,
    0x00FF00, 0x0000FF], [1, 1, 1], [0, 128, 255], gradientBoxMatrix);
myShape.graphics.drawRect(0, 0, 50, 40);
myShape.graphics.drawRect(0, 50, 100, 40);
myShape.graphics.drawRect(0, 100, 150, 40);
myShape.graphics.endFill();
this.addChild(myShape);
```

This code draws three gradients with the same fill style, specified with an equal distribution of red, green, and blue. The gradients are drawn using the `drawRect()` method with pixel widths of 50, 100, and 150 respectively. The gradient matrix which is specified in the `beginGradientFill()` method is created with a width of 100 pixels. This means that the first gradient will encompass only half of the gradient spectrum, the second will encompass all of it, and the third will encompass all of it and have an additional 50 pixels of blue extending to the right.

The `lineGradientStyle()` method works similarly to `beginGradientFill()` except that in addition to defining the gradient, you must specify the thickness of the stroke using the `lineStyle()` method before drawing. The following code draws a box with a red, green, and blue gradient stroke:

```
var myShape:Shape = new Shape();
var gradientBoxMatrix:Matrix = new Matrix();
gradientBoxMatrix.createGradientBox(200, 40, 0, 0, 0);
myShape.graphics.lineStyle(5, 0);
myShape.graphics.lineGradientStyle(GradientType.LINEAR, [0xFF0000,
    0x00FF00, 0x0000FF], [1, 1, 1], [0, 128, 255], gradientBoxMatrix);
myShape.graphics.drawRect(0, 0, 200, 40);
this.addChild(myShape);
```

For more information on the `Matrix` class, see [“Using Matrix objects” on page 440](#).

# Using the Math class with drawing methods

A Graphics object draws circles and squares, but can also draw more complex forms, particularly when the drawing methods are used in combination with the properties and methods of the Math class. The Math class contains constants of common mathematical interest, such as `Math.PI` (approximately 3.14159265...), a constant for the ratio of the circumference of a circle to its diameter. It also contains methods for trigonometry functions, including `Math.sin()`, `Math.cos()`, and `Math.tan()` among others. Drawing shapes using these methods and constants create more dynamic visual effects, particularly when used with repetition or recursion.

Many methods of the Math class expect circular measurements in units of radians rather than degrees. Converting between these two types of units is a common use of the Math class:

```
var degrees = 121;
var radians = degrees * Math.PI / 180;
trace(radians) // 2.111848394913139
```

The following example creates a sine wave and a cosine wave, to highlight the difference between the `Math.sin()` and `Math.cos()` methods for a given value.

```
var sinWavePosition = 100;
var cosWavePosition = 200;
var sinWaveColor:uint = 0xFF0000;
var cosWaveColor:uint = 0x00FF00;
var waveMultiplier:Number = 10;
var waveStretcher:Number = 5;

var i:uint;
for(i = 1; i < stage.stageWidth; i++)
{
    var sinPosY:Number = Math.sin(i / waveStretcher) * waveMultiplier;
    var cosPosY:Number = Math.cos(i / waveStretcher) * waveMultiplier;

    graphics.beginFill(sinWaveColor);
    graphics.drawRect(i, sinWavePosition + sinPosY, 2, 2);
    graphics.beginFill(cosWaveColor);
    graphics.drawRect(i, cosWavePosition + cosPosY, 2, 2);
}
```

# Animating with the drawing API

One advantage of creating content with the drawing API is that you are not limited to positioning your content once. What you draw can be modified by maintaining and modifying the variables you use to draw. You can convey animation by changing variables and redrawing, either over a period of frames or with a timer.

For example, the following code changes the display with each passing frame (by listening to the `Event.ENTER_FRAME` event), incrementing the current degree count, and directs the graphics object to clear and redraw with the updated position.

```
stage.frameRate = 31;

var currentDegrees:Number = 0;
var radius:Number = 40;
var satelliteRadius:Number = 6;

var container:Sprite = new Sprite();
container.x = stage.stageWidth / 2;
container.y = stage.stageHeight / 2;
addChild(container);
var satellite:Shape = new Shape();
container.addChild(satellite);

addEventListener(Event.ENTER_FRAME, doEveryFrame);

function doEveryFrame(event:Event):void
{
    currentDegrees += 4;
    var radians:Number = getRadians(currentDegrees);
    var posX:Number = Math.sin(radians) * radius;
    var posY:Number = Math.cos(radians) * radius;
    satellite.graphics.clear();
    satellite.graphics.beginFill(0);
    satellite.graphics.drawCircle(posX, posY, satelliteRadius);
}

function getRadians(degrees:Number):Number
{
    return degrees * Math.PI / 180;
}
```

To produce a significantly different result, you can experiment by modifying the initial seed variables at the beginning of the code, `currentDegrees`, `radius`, and `satelliteRadius`. For example, try shrinking the radius variable and/or increasing the `totalSatellites` variable. This is only one example of how the drawing API can create a visual display whose complexity conceals the simplicity of its creation.

# Example: Algorithmic Visual Generator

The Algorithmic Visual Generator example dynamically draws to the stage several “satellites”, or circles moving in a circular orbit. Among the features explored are:

- Using the drawing API to draw a basic shape with dynamic appearances
- Connecting user interaction with the properties that are used in a draw
- Conveying animation by clearing the stage on each frame and redrawing

The example in the previous subsection animated a solitary “satellite” using the `Event.ENTER_FRAME` event. This example expands upon this, building a control panel with series of sliders that immediately update the visual display of several satellites. This example formalizes the code into external classes and wraps the satellite creation code into a loop, storing a reference to each satellite in a `satellites` array.

To get the application files for this sample, see [www.adobe.com/go/learn\\_programmingAS3samples\\_flash](http://www.adobe.com/go/learn_programmingAS3samples_flash). The application files can be found in the folder `Samples/AlgorithmicVisualGenerator`. This folder contains the following files:

File	Description
<code>AlgorithmicVisualGenerator.fla</code>	The main application file in Flash (FLA).
<code>com/example/programmingas3/algorithmic/AlgorithmicVisualGenerator.as</code>	The class that provides the main functionality of the application, including drawing satellites on the stage and responding to events from the control panel to update the variables that affect the drawing of satellites.
<code>com/example/programmingas3/algorithmic/ControlPanel.as</code>	A class that manages user interaction with several sliders and dispatching events when this occurs.
<code>com/example/programmingas3/algorithmic/Satellite.as</code>	A class which represents the display object that rotates in an orbit around a central point and contains properties related to its current draw state.

## Setting the listeners

The application first creates three listeners. The first listens for a dispatched event from the control panel that a rebuild of the satellites is necessary. The second listens to changes to the size of the SWF file’s stage. The third listens for each passing frame in the SWF file and to redraw using the `doEveryFrame()` function.

## Creating the satellites

Once these listeners are set, the `build()` function is called. This function first calls the `clear()` function, which empties the `satellites` array and clears any previous draws to the stage. This is necessary since the `build()` function could be recalled whenever the control panel sends an event to do so, such as when the color settings have been changed. In such a case, the satellites must be removed and recreated.

The function then creates the satellites, setting the initial properties needed for creation, such as a the `position` variable, which starts at a random position in the orbit, and the `color` variable, which in this example does not change once the satellite has been created.

As each satellite is created, a reference to it is added to the `satellites` array. When the `doEveryFrame()` function is called, it will update to all satellites in this array.

## Updating the satellite position

The `doEveryFrame()` function is the heart of the application's animation process. It is called for every frame, at a rate equal the framerate of the SWF file. Because the variables of the draw change slightly, this conveys the appearance of animation.

The function first clears all previous draws and redraws the background. Then, it loops through each satellite container and increments the `position` property of each satellite, and updates the `radius` and `orbitRadius` properties that may have changed from user interaction with the control panel. Finally, the satellite updates to its new position by calling the `draw()` method of the `Satellite` class.

Note that the counter, `i`, only increments up to the `visibleSatellites` variable. This is because if the user has limited the amount of satellites that are displayed through the control panel, the remaining satellites in the loop should not be redrawn but should instead be hidden. This occurs in a loop which immediately follows the loop responsible for drawing.

When the `doEveryFrame()` function completes, the number of `visibleSatellites` update in position across the screen.

## Responding to user interaction

User interaction occurs via the control panel, which is managed by the `ControlPanel` class. This class sets a listener along with the individual minimum, maximum, and default values of each slider. As the user moves these sliders, the `changeSetting()` function is called. This function updates the properties of the control panel. If the change requires a rebuild of the display, an event is dispatched which is then handled in the main application file. As the control panel settings change, the `doEveryFrame()` function draws each satellite with the updated variables.

## Customizing further

This example is only a basic schematic of how to generate visuals using the drawing API. It uses relatively few lines of code to create an interactive experience that appears quite complex. Even so, this example could be extended with minor changes. A few ideas:

- The `doEveryFrame()` function could increment the color value of the satellite.
- The `doEveryFrame()` function could shrink or expand the satellite radius over time.
- The satellite radius does not have to be circular; it could use the `Math` class to move according to a sine wave, for example.
- Satellites could use hit detection with other satellites.

The drawing API can be used as an alternative to creating visual effects in the Flash authoring environment, drawing basic shapes at run time. But it can also be used to create visual effects of a variety and scope that are not possible to create by hand. Using the drawing API and a bit of mathematics, the ActionScript author can give life to many unexpected creations.



Historically, the application of filter effects to bitmap images has been the domain of specialized image editing software such as Adobe Photoshop® and Adobe Fireworks®. ActionScript 3.0 includes the [flash.filters](#) package, which contains a series of bitmap effect filter classes to allow developers to programmatically apply filters to bitmaps and display objects to achieve many of the same effects that are available in graphics manipulation applications.

## Contents

Basics of filtering display objects .....	465
Creating and applying filters .....	467
Available display filters .....	472
Example: Filter Workbench .....	490

## Basics of filtering display objects

### Introduction to filtering display objects

One of the ways to add polish to an application is to add simple graphic effects, such as a drop shadow behind a photo to create the illusion of 3-d, or a glow around a button to show that it is active. ActionScript 3.0 includes nine filters that you can apply to any display object or to a `BitmapData` instance. These range from basic filters, such as the drop shadow and glow filters, to complex filters for creating various effects, such as the displacement map filter and the convolution filter.

## Common filtering tasks

The following tasks are things you'll likely want to accomplish using filters in ActionScript:

- Creating a filter
- Applying a filter to a display object
- Applying a filter to the image data in a BitmapData instance
- Removing filters from an object
- Creating various filter effects, such as:
  - Glow
  - Blur
  - Drop shadow
  - Sharpness
  - Displacement
  - Edge detection
  - Embossing
  - and other effects

## Important concepts and terms

The following reference list contains important terms that you will encounter in this chapter:

- **Bevel:** An edge created by lightening pixels on two sides and darkening pixels on the opposite two sides, creating a three-dimensional border effect commonly used for raised or indented buttons and similar graphics.
- **Convolution:** Distorting pixels in an image by combining each pixel's value with the values of some or all of its neighboring pixels, using various ratios.
- **Displacement:** Shifting or moving pixels in an image to a new position.
- **Matrix:** A grid of numbers used to perform certain mathematical calculations by applying the numbers in the grid to various values, then combining the results.

## Working through in-chapter examples

While you're working through the chapter, you may want to test the example code listings that are provided. Because this chapter deals with creating and manipulating visual content, testing the code involves running the code and viewing the results in the SWF that's created. Nearly all the examples either create content using the drawing API or load images to which filters are applied.

To test the code in this chapter:

1. Create an empty Flash document.
2. Select a keyframe in the Timeline.
3. Open the Actions panel and copy the code into the Script pane.
4. Run the program using Control > Test Movie.

You see the results of the code in the SWF file that's created.

Nearly all the example code includes code that creates a bitmap image, so you can just test the code directly without needing to provide any bitmap content. Alternatively you can change the code listings to load your own images and use those in place of the ones in the examples.

## Creating and applying filters

Filters allow you to apply a range of effects to bitmap and display objects, ranging from drop shadows to bevels and blurs. Each filter is defined as a class, so applying filters involves creating instances of filter objects, which is no different from constructing any other object. Once you've created an instance of a filter object, it can easily be applied to a display object by using the object's `filters` property, or in the case of a `BitmapData` object, by using the `applyFilter()` method.

### Creating a new filter

To create a new filter object, simply call the constructor method of your selected filter class. For example, to create a new `DropShadowFilter` object, use the following code:

```
import flash.filters.DropShadowFilter;
var myFilter:DropShadowFilter = new DropShadowFilter();
```

Although not shown here, the `DropShadowFilter()` constructor (like all the filter classes' constructors) accepts several optional parameters that can be used to customize the appearance of the filter effect.

### Applying a filter

Once you've constructed a filter object, you can apply it to a display object or a `BitmapData` object; how you apply the filter depends on the object to which you're applying it.

## Applying a filter to a display object

When you apply filter effects to a display object, you apply them through the `filters` property. The `filters` property of a display object is an Array instance, whose elements are the filter objects applied to the display object. To apply a single filter to a display object, create the filter instance, add it to an Array instance, and assign that Array object to the display object's `filters` property:

```
import flash.display.Bitmap;
import flash.display.BitmapData;
import flash.filters.DropShadowFilter;

// Create a bitmapData object and render it to screen
var myBitmapData:BitmapData = new BitmapData(100,100,false,0xFFFF3300);
var myDisplayObject:Bitmap = new Bitmap(myBitmapData);
addChild(myDisplayObject);

// Create a DropShadowFilter instance.
var dropShadow:DropShadowFilter = new DropShadowFilter();

// Create the filters array, adding the filter to the array by passing it as
// a parameter to the Array() constructor.
var filtersArray:Array = new Array(dropShadow);

// Assign the filters array to the display object to apply the filter.
myDisplayObject.filters = filtersArray;
```

If you want to assign multiple filters to the object, simply add all the filters to the Array instance before assigning it to the `filters` property. You can add multiple objects to an Array by passing them as parameters to its constructor. For example, this code applies a bevel filter and a glow filter to the previously created display object:

```
import flash.filters.BevelFilter;
import flash.filters.GlowFilter;

// Create the filters and add them to an array.
var bevel:BevelFilter = new BevelFilter();
var glow:GlowFilter = new GlowFilter();
var filtersArray:Array = new Array(bevel, glow);

// Assign the filters array to the display object to apply the filter.
myDisplayObject.filters = filtersArray;
```

### NOTE

When you're creating the array containing the filters, you can create it using the new `Array()` constructor (as shown in the previous examples) or you can use `Array` literal syntax, wrapping the filters in square braces (`[]`). For instance, this line of code:  
`var filters:Array = new Array(dropShadow, blur);`  
does the same thing as this line of code:  
`var filters:Array = [dropShadow, blur];`

If you apply multiple filters to display objects, they are applied in a cumulative, sequential manner. For example, if a filters array has two elements, a bevel filter added first and a drop shadow filter added second, the drop shadow filter is applied to both the bevel filter and the display object. This is because of the drop shadow filter's second position in the filters array. If you want to apply filters in a noncumulative manner, you must apply each filter to a new copy of the display object.

If you're only assigning one or a few filters to a display object, you can create the filter instance and assign it to the object in a single statement. For instance, the following line of code applies a blur filter to a display object called `myDisplayObject`:

```
myDisplayObject.filters = [new BlurFilter()];
```

The previous code creates an Array instance using Array literal syntax (square braces), creates a new `BlurFilter` instance as an element in the Array, and assigns that Array to the `filters` property of the display object named `myDisplayObject`.

## Removing filters from a display object

Removing all filters from a display object is as simple as assigning a null value to the `filters` property:

```
myDisplayObject.filters = null;
```

If you've applied multiple filters to an object and want to remove only one of the filters, you must go through several steps to change the `filters` property array. For more information, see [“Changing filters at run time” on page 470](#).

## Applying a filter to a BitmapData object

Applying a filter to a `BitmapData` object requires the use of the `BitmapData` object's `applyFilter()` method:

```
myBitmapData.applyFilter(sourceBitmapData);
```

The `applyFilter()` method applies a filter to a source `BitmapData` object, producing a new, filtered image. This method does not modify the original source image; instead, the result of the filter being applied to the source image is stored in the `BitmapData` instance on which the `applyFilter()` method is called.

## How filters work

Display object filtering works by caching a copy of the original object as a transparent bitmap.

Once a filter has been applied to a display object, Adobe Flash Player caches the object as a bitmap for as long as the object has a valid filter list. This source bitmap is then used as the original image for all subsequently applied filter effects.

Each display object usually contains two bitmaps: one with the original unfiltered source display object and another for the final image after filtering. The final image is used when rendering. As long as the display object does not change, the final image does not need updating.

## Potential issues for working with filters

There are several potential sources of confusion or trouble to keep in mind when you're working with filters. These are described in the following sections.

### Filters and bitmap caching

To apply a filter to a display object, bitmap caching must be enabled for that object. When you apply a filter to a display object whose `cacheAsBitmap` property is set to `false`, Flash Player automatically sets the value of the object's `cacheAsBitmap` property to `true`. If you later remove all the filters from the display object, Flash Player resets the `cacheAsBitmap` property to the last value it was set to.

### Changing filters at run time

If a display object already has one or more filters applied to it, you can't add additional filters to the `filters` property array. Instead, to add or change the set of filters being applied, you create a copy of the entire `filters` array and make your modifications to this (temporary) array. You then reassign this array back to the `filters` property of the display object in order for the filters to be applied to the object. The following code demonstrates this process. Initially, a glow filter is applied to the display object named `myDisplayObject`; later, when the display object is clicked, the function `addFilters()` is called. In this function, two additional filters are applied to `myDisplayObject`:

```
import flash.events.MouseEvent;
import flash.filters.*;

myDisplayObject.filters = [new GlowFilter()];

function addFilters(event:MouseEvent):void
```

```

{
    // Make a copy of the filters array.
    var filtersCopy:Array = myDisplayObject.filters;

    // Make desired changes to the filters (in this case, adding filters).
    filtersCopy.push(new BlurFilter());
    filtersCopy.push(new DropShadowFilter());

    // Apply the changes by re-assigning the array to the filters property.
    myDisplayObject.filters = filtersCopy;
}

myDisplayObject.addEventListener(MouseEvent.CLICK, addFilters);

```

## Filters and object transformations

No filtered region—a drop shadow, for example—outside of a display object’s bounding box rectangle is considered to be part of the surface for the purposes of hit detection (determining if an instance overlaps or intersects with another instance). Because the `DisplayObject` class’s hit detection methods are vector-based, you cannot perform a hit detection on the bitmap result. For example, if you apply a bevel filter to a button instance, hit detection is not available on the beveled portion of the instance.

Scaling, rotating, and skewing are not supported by filters; if the filtered display object itself is scaled (if `scaleX` and `scaleY` are not 100%), the filter effect does not scale with the instance. This means that the original shape of the instance rotates, scales, or skews; however, the filter does not rotate, scale, or skew with the instance.

You can animate an instance with a filter to create realistic effects, or nest instances and use the `BitmapData` class to animate filters to achieve this effect.

## Filters and Bitmap objects

When you apply any filter to a `BitmapData` object, the `cacheAsBitmap` property is automatically set to `true`. In this way, the filter is actually applied to the copy of the object rather than the original.

This copy is then placed on the main display (over the original object) as close as possible to the nearest pixel. If the bounds of the original bitmap change, the filtered copy bitmap is recreated from scratch, rather than being stretched or distorted.

If you clear all filters for a display object, the `cacheAsBitmap` property is reset to what it was before the filter was applied.

# Available display filters

ActionScript 3.0 includes nine filter classes that you can apply to display objects and BitmapData objects:

- Bevel filter (BevelFilter class)
- Blur filter (BlurFilter class)
- Drop shadow filter (DropShadowFilter class)
- Glow filter (GlowFilter class)
- Gradient bevel filter (GradientBevelFilter class)
- Gradient glow filter (GradientGlowFilter class)
- Color matrix filter (ColorMatrixFilter class)
- Convolution filter (ConvolutionFilter class)
- Displacement map filter (DisplacementMapFilter class)

The first six filters are simple filters that can be used to create one specific effect, with some customization of the effect available. Those six filters can be applied using ActionScript, and can also be applied to objects in Adobe Flash CS3 Professional using the Filters panel. Consequently, even if you're applying filters using ActionScript, if you have the Flash authoring tool you can use the visual interface to quickly try out different filters and settings to figure out how to create a desired effect.

The final three filters are available in ActionScript only. Those filters, the color matrix filter, convolution filter, and displacement map filter, are much more flexible in the types of effects that they can be used to create; rather than being optimized for a single effect, they provide power and flexibility. For example, by selecting different values for its matrix, the convolution filter can be used to create effects such as blurring, embossing, sharpening, finding color edges, transformations, and more.

Each of the filters, whether simple or complex, can be customized using their properties. Generally, you have two choices for setting filter properties. All the filters let you set the properties by passing parameter values to the filter object's constructor. Alternatively, whether or not you set the filter properties by passing parameters, you can adjust the filters later by setting values for the filter object's properties. Most of the example code listings set the properties directly, in order to make the example easier to follow. Nevertheless, you could usually achieve the same result in fewer lines of code by passing the values as parameters in the filter object's constructor. For more details on the specifics of each filter, its properties and its constructor parameters, see the listings for the `flash.filters` package in the *ActionScript 3.0 Language and Components Reference*.



## Bevel filter

The `BevelFilter` class allows you to add a 3D beveled edge to the filtered object. This filter makes the hard corners or edges of your object look like they have been chiseled, or beveled, away.

The `BevelFilter` class properties allow you to customize the appearance of the bevel. You can set highlight and shadow colors, bevel edge blurs, bevel angles, and bevel edge placement; you can even create a knockout effect.

The following example loads an external image and applies a bevel filter to it.

```
import flash.display.*;
import flash.filters.BevelFilter;
import flash.filters.BitmapFilterQuality;
import flash.filters.BitmapFilterType;
import flash.net.URLRequest;

// Load an image onto the Stage.
var imageLoader:Loader = new Loader();
var url:String = "http://www.helpexamples.com/flash/images/image3.jpg";
var urlReq:URLRequest = new URLRequest(url);
imageLoader.load(urlReq);
addChild(imageLoader);

// Create the bevel filter and set filter properties.
var bevel:BevelFilter = new BevelFilter();

bevel.distance = 5;
bevel.angle = 45;
bevel.highlightColor = 0xFFFF00;
bevel.highlightAlpha = 0.8;
bevel.shadowColor = 0x666666;
bevel.shadowAlpha = 0.8;
bevel.blurX = 5;
bevel.blurY = 5;
bevel.strength = 5;
bevel.quality = BitmapFilterQuality.HIGH;
bevel.type = BitmapFilterType.INNER;
bevel.knockout = false;

// Apply filter to the image.
imageLoader.filters = [bevel];
```

## Blur filter

The `BlurFilter` class smears, or blurs, a display object and its contents. Blur effects are useful for giving the impression that an object is out of focus or for simulating fast movement, as in a motion blur. By setting the `quality` property of the blur filter to low, you can simulate a softly out-of-focus lens effect. Setting the `quality` property to high results in a smooth blur effect similar to a Gaussian blur.

The following example creates a circle object using the `drawCircle()` method of the `Graphics` class and applies a blur filter to it:

```
import flash.display.Sprite;
import flash.filters.BitmapFilterQuality;
import flash.filters.BlurFilter;

// Draw a circle.
var redDotCutout:Sprite = new Sprite();
redDotCutout.graphics.lineStyle();
redDotCutout.graphics.beginFill(0xFF0000);
redDotCutout.graphics.drawCircle(145, 90, 25);
redDotCutout.graphics.endFill();

// Add the circle to the display list.
addChild(redDotCutout);

// Apply the blur filter to the rectangle.
var blur:BlurFilter = new BlurFilter();
blur.blurX = 10;
blur.blurY = 10;
blur.quality = BitmapFilterQuality.MEDIUM;
redDotCutout.filters = [blur];
```

## Drop shadow filter

Drop shadows give the impression that there is a separate light source situated above a target object. The position and intensity of this light source can be modified to produce a variety of different drop shadow effects.

The drop shadow filter uses an algorithm that is similar to the blur filter's algorithm. The main difference is that the drop shadow filter has a few more properties that you can modify to simulate different light-source attributes (such as alpha, color, offset and brightness).

The drop shadow filter also allows you to apply custom transformation options on the style of the drop shadow, including inner or outer shadow and knockout (also known as cutout) mode.

The following code creates a square box sprite and applies a drop shadow filter to it:

```
import flash.display.Sprite;
import flash.filters.DropShadowFilter;

// Draw a box.
var boxShadow:Sprite = new Sprite();
boxShadow.graphics.lineStyle(1);
boxShadow.graphics.beginFill(0xFF3300);
boxShadow.graphics.drawRect(0, 0, 100, 100);
boxShadow.graphics.endFill();
addChild(boxShadow);

// Apply the drop shadow filter to the box.
var shadow:DropShadowFilter = new DropShadowFilter();
shadow.distance = 10;
shadow.angle = 25;

// You can also set other properties, such as the shadow color,
// alpha, amount of blur, strength, quality, and options for
// inner shadows and knockout effects.

boxShadow.filters = [shadow];
```

## Glow filter

The `GlowFilter` class applies a lighting effect to display objects, making it appear that a light is being shined up from underneath the object to create a soft glow.

Similar to the drop shadow filter, the glow filter includes properties to modify the distance, angle, and color of the light source to produce varying effects. The `GlowFilter` also has several options for modifying the style of the glow, including inner or outer glow and knockout mode.

The following code creates a cross using the `Sprite` class and applies a glow filter to it:

```
import flash.display.Sprite;
import flash.filters.BitmapFilterQuality;
import flash.filters.GlowFilter;

// Create a cross graphic.
var crossGraphic:Sprite = new Sprite();
crossGraphic.graphics.lineStyle();
crossGraphic.graphics.beginFill(0xCCCC00);
crossGraphic.graphics.drawRect(60, 90, 100, 20);
crossGraphic.graphics.drawRect(100, 50, 20, 100);
crossGraphic.graphics.endFill();
addChild(crossGraphic);
```

```

// Apply the glow filter to the cross shape.
var glow:GlowFilter = new GlowFilter();
glow.color = 0x009922;
glow.alpha = 1;
glow.blurX = 25;
glow.blurY = 25;
glow.quality = BitmapFilterQuality.MEDIUM;

crossGraphic.filters = [glow];

```

## Gradient bevel filter

The `GradientBevelFilter` class lets you apply an enhanced bevel effect to display objects or `BitmapData` objects. Using a gradient color on the bevel greatly improves the spatial depth of the bevel, giving edges a more realistic, 3D appearance.

The following code creates a rectangle object using the `drawRect()` method of the `Shape` class and applies a gradient bevel filter to it.

```

import flash.display.Shape;
import flash.filters.BitmapFilterQuality;
import flash.filters.GradientBevelFilter;

// Draw a rectangle.
var box:Shape = new Shape();
box.graphics.lineStyle();
box.graphics.beginFill(0xFFEF78);
box.graphics.drawRect(100, 50, 90, 200);
box.graphics.endFill();

// Apply a gradient bevel to the rectangle.
var gradientBevel:GradientBevelFilter = new GradientBevelFilter();

gradientBevel.distance = 8;
gradientBevel.angle = 225; // opposite of 45 degrees
gradientBevel.colors = [0xFFFFCC, 0xFFEF78, 0x8F8E01];
gradientBevel.alphas = [1, 0, 1];
gradientBevel.ratios = [0, 128, 255];
gradientBevel.blurX = 8;
gradientBevel.blurY = 8;
gradientBevel.quality = BitmapFilterQuality.HIGH;

// Other properties let you set the filter strength and set options
// for inner bevel and knockout effects.

box.filters = [gradientBevel];

// Add the graphic to the display list.
addChild(box);

```

## Gradient glow filter

The `GradientGlowFilter` class lets you apply an enhanced glow effect to display objects or `BitmapData` objects. The effect gives you greater color control of the glow, and in turn produces a more realistic glow effect. Additionally, the gradient glow filter allows you to apply a gradient glow to the inner, outer, or upper edges of an object.

The following example draws a circle on the Stage, and applies a gradient glow filter to it. As you move the mouse further to the right and down, the amount of blur increases in the horizontal and vertical directions respectively. In addition, any time you click on the Stage, the strength of the blur increases.

```
import flash.events.MouseEvent;
import flash.filters.BitmapFilterQuality;
import flash.filters.BitmapFilterType;
import flash.filters.GradientGlowFilter;

// Create a new Shape instance.
var shape:Shape = new Shape();

// Draw the shape.
shape.graphics.beginFill(0xFF0000, 100);
shape.graphics.moveTo(0, 0);
shape.graphics.lineTo(100, 0);
shape.graphics.lineTo(100, 100);
shape.graphics.lineTo(0, 100);
shape.graphics.lineTo(0, 0);
shape.graphics.endFill();

// Position the shape on the Stage.
addChild(shape);
shape.x = 100;
shape.y = 100;

// Define a gradient glow.
var gradientGlow:GradientGlowFilter = new GradientGlowFilter();
gradientGlow.distance = 0;
gradientGlow.angle = 45;
gradientGlow.colors = [0x000000, 0xFF0000];
gradientGlow.alphas = [0, 1];
gradientGlow.ratios = [0, 255];
gradientGlow.blurX = 10;
gradientGlow.blurY = 10;
gradientGlow.strength = 2;
gradientGlow.quality = BitmapFilterQuality.HIGH;
gradientGlow.type = BitmapFilterType.OUTER;
```

```

// Define functions to listen for two events.
function onClick(event:MouseEvent):void
{
    gradientGlow.strength++;
    shape.filters = [gradientGlow];
}

function onMouseMove(event:MouseEvent):void
{
    gradientGlow.blurX = (stage.mouseX / stage.stageWidth) * 255;
    gradientGlow.blurY = (stage.mouseY / stage.stageHeight) * 255;
    shape.filters = [gradientGlow];
}
stage.addEventListener(MouseEvent.CLICK, onClick);
stage.addEventListener(MouseEvent.MOUSE_MOVE, onMouseMove);

```

## Example: Combining basic filters

The following code example uses several basic filters, combined with a Timer for creating repeating actions, to create an animated traffic light simulation.

```

import flash.display.Shape;
import flash.events.TimerEvent;
import flash.filters.BitmapFilterQuality;
import flash.filters.BitmapFilterType;
import flash.filters.DropShadowFilter;
import flash.filters.GlowFilter;
import flash.filters.GradientBevelFilter;
import flash.utils.Timer;

var count:Number = 1;
var distance:Number = 8;
var angleInDegrees:Number = 225; // opposite of 45 degrees
var colors:Array = [0xFFFFCC, 0xFEFE78, 0x8F8E01];
var alphas:Array = [1, 0, 1];
var ratios:Array = [0, 128, 255];
var blurX:Number = 8;
var blurY:Number = 8;
var strength:Number = 1;
var quality:Number = BitmapFilterQuality.HIGH;
var type:String = BitmapFilterType.INNER;
var knockout:Boolean = false;

// Draw the rectangle background for the traffic light.
var box:Shape = new Shape();
box.graphics.lineStyle();
box.graphics.beginFill(0xFEFE78);
box.graphics.drawRect(100, 50, 90, 200);
box.graphics.endFill();

```

```

// Draw the 3 circles for the three lights.
var stopLight:Shape = new Shape();
stopLight.graphics.lineStyle();
stopLight.graphics.beginFill(0xFF0000);
stopLight.graphics.drawCircle(145,90,25);
stopLight.graphics.endFill();

var cautionLight:Shape = new Shape();
cautionLight.graphics.lineStyle();
cautionLight.graphics.beginFill(0xFF9900);
cautionLight.graphics.drawCircle(145,150,25);
cautionLight.graphics.endFill();

var goLight:Shape = new Shape();
goLight.graphics.lineStyle();
goLight.graphics.beginFill(0x00CC00);
goLight.graphics.drawCircle(145,210,25);
goLight.graphics.endFill();

// Add the graphics to the display list.
addChild(box);
addChild(stopLight);
addChild(cautionLight);
addChild(goLight);

// Apply a gradient bevel to the traffic light rectangle.
var gradientBevel:GradientBevelFilter = new GradientBevelFilter(distance,
    angleInDegrees, colors, alphas, ratios, blurX, blurY, strength, quality,
    type, knockout);
box.filters = [gradientBevel];

// Create the inner shadow (for lights when off) and glow
// (for lights when on).
var innerShadow:DropShadowFilter = new DropShadowFilter(5, 45, 0, 0.5, 3,
    3, 1, 1, true, false);
var redGlow:GlowFilter = new GlowFilter(0xFF0000, 1, 30, 30, 1, 1, false,
    false);
var yellowGlow:GlowFilter = new GlowFilter(0xFF9900, 1, 30, 30, 1, 1, false,
    false);
var greenGlow:GlowFilter = new GlowFilter(0x00CC00, 1, 30, 30, 1, 1, false,
    false);

// Set the starting state of the lights (green on, red/yellow off).
stopLight.filters = [innerShadow];
cautionLight.filters = [innerShadow];
goLight.filters = [greenGlow];

// Swap the filters based on the count value.
function trafficControl(event:TimerEvent):void

```

```

{
  if (count == 4)
  {
    count = 1;
  }

  switch (count)
  {
    case 1:
      stopLight.filters = [innerShadow];
      cautionLight.filters = [yellowGlow];
      goLight.filters = [innerShadow];
      break;
    case 2:
      stopLight.filters = [redGlow];
      cautionLight.filters = [innerShadow];
      goLight.filters = [innerShadow];
      break;
    case 3:
      stopLight.filters = [innerShadow];
      cautionLight.filters = [innerShadow];
      goLight.filters = [greenGlow];
      break;
  }

  count++;
}

// Create a timer to swap the filters at a 3 second interval.
var timer:Timer = new Timer(3000, 9);
timer.addEventListener(TimerEvent.TIMER, trafficControl);
timer.start();

```

## Color matrix filter

The `ColorMatrixFilter` class is used to manipulate the color and alpha values of the filtered object. This allows you to create saturation changes, hue rotation (shifting a palette from one range of colors to another), luminance-to-alpha changes, and other color manipulation effects using values from one color channel and potentially applying them to other channels.



Conceptually, the filter goes through the pixels in the source image one by one and separates each pixel into its red, green, blue, and alpha components. It then multiplies values provided in the color matrix by each of these values, adding the results together to determine the resulting color value that will be displayed on the screen for that pixel. The `matrix` property of the filter is an array of 20 numbers that are used in calculating the final color. For details of the specific algorithm used to calculate the color values, see the entry describing the `ColorMatrixFilter` class's `matrix` property in the *ActionScript 3.0 Language and Components Reference*.

Further information and examples of the color matrix filter can be found in the article [“Using Matrices for Transformations, Color Adjustments, and Convolution Effects in Flash”](#) on the Adobe Developer Center web site.

## Convolution filter

The `ConvolutionFilter` class can be used to apply a wide range of imaging transformations to `BitmapData` objects or display objects, such as blurring, edge detection, sharpening, embossing, and beveling.

The convolution filter conceptually goes through each pixel in the source image one by one and determines the final color of that pixel using the value of the pixel and its surrounding pixels. A matrix, specified as an array of numeric values, indicates to what degree the value of each particular neighboring pixel affects the final resulting value.

Consider the most commonly used type of matrix, which is a three by three matrix. The matrix includes nine values:

```
N N N
N P N
N N N
```

When Flash Player is applying the convolution filter to a certain pixel, it will look at the color value of the pixel itself (“P” in the example), as well as the values of the surrounding pixels (labelled “N” in the example). However, by setting values in the matrix, you specify how much priority certain pixels have in affecting the resulting image.

For example, the following matrix, applied using a convolution filter, will leave an image exactly as it was:

```
0 0 0
0 1 0
0 0 0
```

The reason the image is unchanged is because the original pixel's value has a relative strength of 1 in determining the final pixel color, while the surrounding pixels' values have relative strength of 0—meaning their colors don't affect the final image.

Similarly, this matrix will cause the pixels of an image to shift one pixel to the left:

```
0 0 0
0 0 1
0 0 0
```

Notice that in this case, the pixel itself has no effect on the final value of the pixel displayed in that location on the final image—only the value of the pixel to the right is used to determine the pixel's resulting value.

In ActionScript, you create the matrix as a combination of an Array instance containing the values and two properties specifying the number of rows and columns in the matrix. The following example loads an image and, when the image finishes loading, applies a convolution filter to the image using the matrix in the previous listing:

```
// Load an image onto the Stage.
var loader:Loader = new Loader();
var url:URLRequest = new URLRequest("http://www.helpexamples.com/flash/
  images/image1.jpg");
loader.load(url);
this.addChild(loader);

function applyFilter(event:MouseEvent):void
{
    // Create the convolution matrix.
    var matrix:Array = [ 0, 0, 0,
                        0, 0, 1,
                        0, 0, 0 ];

    var convolution:ConvolutionFilter = new ConvolutionFilter();
    convolution.matrixX = 3;
    convolution.matrixY = 3;
    convolution.matrix = matrix;
    convolution.divisor = 1;

    loader.filters = [convolution];
}

loader.addEventListener(MouseEvent.CLICK, applyFilter);
```

Something that isn't obvious in this code is the effect of using values other than 1 or 0 in the matrix. For example, the same matrix, with the number 8 instead of 1 in the right-hand position, performs the same action (shifting the pixels to the left). In addition, it affects the colors of the image, making them 8 times brighter. This is because the final pixel color values are calculated by multiplying the matrix values by the original pixel colors, adding the values together, and dividing by the value of the filter's `divisor` property. Notice that in the example code, the `divisor` property is set to 1. As a general rule, if you want the brightness of the colors to stay about the same as in the original image, you should make the divisor equal to the sum of the matrix values. So with a matrix where the values add up to 8, and a divisor of 1, the resulting image is going to be roughly 8 times brighter than the original image.

Although the effect of this matrix isn't very noticeable, other matrix values can be used to create various effects. Here are several standard sets of matrix values for different effects using a three by three matrix:

- Basic blur (divisor 5):

```
0 1 0
1 1 1
0 1 0
```

- Sharpening (divisor 1):

```
0, -1, 0
-1, 5, -1
0, -1, 0
```

- Edge detection (divisor 1):

```
0, -1, 0
-1, 4, -1
0, -1, 0
```

- Embossing effect (divisor 1):

```
-2, -1, 0
-1, 1, 1
0, 1, 2
```

Notice that with most of these effects, the divisor is 1. This is because the negative matrix values added to the positive matrix values result in 1 (or 0 in the case of edge detection, but the `divisor` property's value cannot be 0).

## Displacement map filter

The `DisplacementMapFilter` class uses pixel values from a `BitmapData` object (known as the displacement map image) to perform a displacement effect on a new object. The displacement map image is typically different than the actual display object or `BitmapData` instance to which the filter is being applied. A displacement effect involves displacing pixels in the filtered image—in other words, shifting them away from their original location to some extent. This filter can be used to create a shifted, warped, or mottled effect.

The location and amount of displacement applied to a given pixel is determined by the color value of the displacement map image. When working with the filter, in addition to specifying the map image, you specify the following values to control how the displacement is calculated from the map image:

- **Map point:** The location on the filtered image at which the top-left corner of the displacement filter will be applied. You can use this if you only want to apply the filter to part of an image.
- **X component:** Which color channel of the map image affects the x position of pixels.
- **Y component:** Which color channel of the map image affects the y position of pixels.
- **X scale:** A multiplier value that specifies how strong the x axis displacement is.
- **Y scale:** A multiplier value that specifies how strong the y axis displacement is.
- **Filter mode:** Determines what Flash Player should do in any empty spaces created by pixels being shifted away. The options, defined as constants in the `DisplacementMapFilterMode` class, are to display the original pixels (filter mode `IGNORE`), to wrap the pixels around from the other side of the image (filter mode `WRAP`, which is the default), to use the nearest shifted pixel (filter mode `CLAMP`), or to fill in the spaces with a color (filter mode `COLOR`).

To get a basic understanding of how the displacement map filter works, consider a basic example. In the following code, an image is loaded, and when it finishes loading it is centered on the Stage and a displacement map filter is applied to it, causing the pixels in the entire image to shift horizontally to the left.

```
import flash.display.BitmapData;
import flash.display.Loader;
import flash.events.MouseEvent;
import flash.filters.DisplacementMapFilter;
import flash.geom.Point;
import flash.net.URLRequest;
```

```

// Load an image onto the Stage.
var loader:Loader = new Loader();
var url:URLRequest = new URLRequest("http://www.helpexamples.com/flash/
  images/image3.jpg");
loader.load(url);
this.addChild(loader);

var mapImage:BitmapData;
var displacementMap:DisplacementMapFilter;

// This function is called when the image finishes loading.
function setupStage(event:Event):void
{
  // Center the loaded image on the Stage.
  loader.x = (stage.stageWidth - loader.width) / 2;
  loader.y = (stage.stageHeight - loader.height) / 2;

  // Create the displacement map image.
  mapImage = new BitmapData(loader.width, loader.height, false, 0xFF0000);

  // Create the displacement filter.
  displacementMap = new DisplacementMapFilter();
  displacementMap.mapBitmap = mapImage;
  displacementMap.mapPoint = new Point(0, 0);
  displacementMap.componentX = BitmapDataChannel.RED;
  displacementMap.scaleX = 250;
  loader.filters = [displacementMap];
}

loader.contentLoaderInfo.addEventListener(Event.COMPLETE, setupStage);

```

The properties used to define the displacement are as follows:

- **Map bitmap:** The displacement bitmap is a new `BitmapData` instance created by the code. Its dimensions match the dimensions of the loaded image (so the displacement is applied to the entire image). It is filled with solid red pixels.
- **Map point:** This value is set to the point 0, 0—again, causing the displacement to be applied to the entire image.
- **X component:** This value is set to the constant `BitmapDataChannel.RED`, meaning the red value of the map bitmap will determine how much the pixels are displaced (how much they move) along the x axis.
- **X scale:** This value is set to 250. The full amount of displacement (from the map image being completely red) only displaces the image by a small amount (roughly one-half of a pixel), so if this value was set to 1 the image would only shift .5 pixels horizontally. By setting it to 250, the image shifts by approximately 125 pixels.

These settings cause the filtered image's pixels to shift 250 pixels to the left. The direction (left or right) and amount of shift is based on the color value of the pixels in the map image. Conceptually, Flash Player goes through the pixels of the filtered image one by one (at least, the pixels in the region where the filter is applied, which in this case means all the pixels), and does the following with each pixel:

1. It finds the corresponding pixel in the map image. For example, when Flash Player is calculating the displacement amount for the pixel in the top-left corner of the filtered image, it looks at the pixel in the top-left corner of the map image.
2. It determines the value of the specified color channel in the map pixel. In this case, the x component color channel is the red channel, so Flash Player looks to see what the value of the red channel of the map image is at the pixel in question. Since the map image is solid red, the pixel's red channel is 0xFF, or 255. This is used as the displacement value.
3. It compares the displacement value to the “middle” value (127, which is halfway between 0 and 255). If the displacement value is lower than the middle value, the pixel shifts in a positive direction (to the right for x displacement; down for y displacement). On the other hand, if the displacement value is higher than the middle value (as in this example), the pixel shifts in a negative direction (to the left for x displacement; up for y displacement). To be more precise, Flash Player subtracts the displacement value from 127, and the result (positive or negative) is the relative amount of displacement that is applied.
4. Finally, it determines the actual amount of displacement by determining what percentage of full displacement the relative displacement value represents. In this case, full red means 100% displacement. That percentage is then multiplied by the x scale or y scale value to determine the number of pixels of displacement that will be applied. In this example, 100% times a multiplier of 250 determines the amount of displacement—roughly 125 pixels to the left.

Because no values were specified for y component and y scale, the defaults (which cause no displacement) were used—that's why the image doesn't shift at all in the vertical direction.

The default filter mode setting, `WRAP`, is used in the example, so as the pixels shift to the left the empty space on the right is filled in by the pixels that shifted off the left edge of the image. You can experiment with this value to see the different effects. For instance, if you add the following line to the portion of code where the displacement properties are being set (before the line `loader.filters = [displacementMap]`), it will make the image look as though it has been smeared across the Stage:

```
displacementMap.mode = DisplacementMapFilterMode.CLAMP;
```

For a more complex example, the following listing uses a displacement map filter to create a magnifying glass effect on an image:

```
import flash.display.Bitmap;
import flash.display.BitmapData;
import flash.display.BitmapDataChannel;
import flash.display.GradientType;
import flash.display.Loader;
import flash.display.Shape;
import flash.events.MouseEvent;
import flash.filters.DisplacementMapFilter;
import flash.filters.DisplacementMapFilterMode;
import flash.geom.Matrix;
import flash.geom.Point;
import flash.net.URLRequest;

// Create the gradient circles that will together form the
// displacement map image
var radius:uint = 50;

var type:String = GradientType.LINEAR;
var redColors:Array = [ 0xFF0000, 0x000000 ];
var blueColors:Array = [ 0x0000FF, 0x000000 ];
var alphas:Array = [ 1, 1 ];
var ratios:Array = [ 0, 255 ];
var xMatrix:Matrix = new Matrix();
xMatrix.createGradientBox(radius * 2, radius * 2);
var yMatrix:Matrix = new Matrix();
yMatrix.createGradientBox(radius * 2, radius * 2, Math.PI / 2);

var xCircle:Shape = new Shape();
xCircle.graphics.lineStyle(0, 0, 0);
xCircle.graphics.beginGradientFill(type, redColors, alphas, ratios,
    xMatrix);
xCircle.graphics.drawCircle(radius, radius, radius);

var yCircle:Shape = new Shape();
yCircle.graphics.lineStyle(0, 0, 0);
yCircle.graphics.beginGradientFill(type, blueColors, alphas, ratios,
    yMatrix);
yCircle.graphics.drawCircle(radius, radius, radius);

// Position the circles at the bottom of the screen, for reference.
this.addChild(xCircle);
xCircle.y = stage.stageHeight - xCircle.height;
this.addChild(yCircle);
yCircle.y = stage.stageHeight - yCircle.height;
yCircle.x = 200;
```

```

// Load an image onto the Stage.
var loader:Loader = new Loader();
var url:URLRequest = new URLRequest("http://www.helpexamples.com/flash/
    images/image1.jpg");
loader.load(url);
this.addChild(loader);

// Create the map image by combining the two gradient circles.
var map:BitmapData = new BitmapData(xCircle.width, xCircle.height, false,
    0x7F7F7F);
map.draw(xCircle);
var yMap:BitmapData = new BitmapData(yCircle.width, yCircle.height, false,
    0x7F7F7F);
yMap.draw(yCircle);
map.copyChannel(yMap, yMap.rect, new Point(0, 0), BitmapDataChannel.BLUE,
    BitmapDataChannel.BLUE);
yMap.dispose();

// Display the map image on the Stage, for reference.
var mapBitmap:Bitmap = new Bitmap(map);
this.addChild(mapBitmap);
mapBitmap.x = 400;
mapBitmap.y = stage.stageHeight - mapBitmap.height;

// This function creates the displacement map filter at the mouse location.
function magnify():void
{
    // Position the filter.
    var filterX:Number = (loader.mouseX) - (map.width / 2);
    var filterY:Number = (loader.mouseY) - (map.height / 2);
    var pt:Point = new Point(filterX, filterY);
    var xyFilter:DisplacementMapFilter = new DisplacementMapFilter();
    xyFilter.mapBitmap = map;
    xyFilter.mapPoint = pt;
    // The red in the map image will control x displacement.
    xyFilter.componentX = BitmapDataChannel.RED;
    // The blue in the map image will control y displacement.
    xyFilter.componentY = BitmapDataChannel.BLUE;
    xyFilter.scaleX = 35;
    xyFilter.scaleY = 35;
    xyFilter.mode = DisplacementMapFilterMode.IGNORE;
    loader.filters = [xyFilter];
}

// This function is called when the mouse moves. If the mouse is
// over the loaded image, it applies the filter.
function moveMagnifier(event:MouseEvent):void
{

```



```

    if (loader.hitTestPoint(loader.mouseX, loader.mouseY))
    {
        magnify();
    }
}
loader.addEventListener(MouseEvent.MOUSE_MOVE, moveMagnifier);

```

The code first generates two gradient circles, which are combined together to form the displacement map image. The red circle creates the x axis displacement (`xyFilter.componentX = BitmapDataChannel.RED`), and the blue circle creates the y axis displacement (`xyFilter.componentY = BitmapDataChannel.BLUE`). To help you understand what the displacement map image looks like, the code adds the original circles as well as the combined circle that serves as the map image to the bottom of the screen.

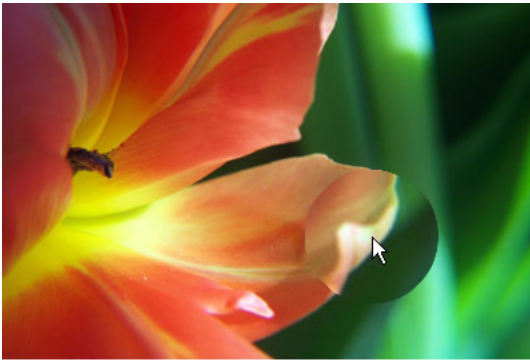

The code then loads an image and, as the mouse moves, applies the displacement filter to the portion of the image that's under the mouse. The gradient circles used as the displacement map image causes the displaced region to spread out away from the mouse pointer. Notice that the gray regions of the displacement map image don't cause any displacement. The gray color is `0x7F7F7F`. The blue and red channels of that shade of gray exactly match the middle shade of those color channels, so there is no displacement in a gray area of the map image. Likewise, in the center of the circle there is no displacement. Although the color there isn't gray, that color's blue channel and red channel are identical to the blue channel and red channel of medium gray, and since blue and red are the colors that cause displacement, no displacement happens there.

# Example: Filter Workbench

The Filter Workbench provides a simple user interface to apply different filters to an image and see the resulting code that can be used to generate the same effect by using ActionScript. For a description of this example and to download the source code, see [www.adobe.com/go/learn\\_fl\\_filters](http://www.adobe.com/go/learn_fl_filters).

The `MovieClip` class is the core class for animation and movie clip symbols created in Adobe Flash CS3 Professional. It has all the behaviors and functionality of display objects, but with additional properties and methods for controlling a movie clip's timeline. This chapter explains how to use ActionScript to control movie clip playback and to create a movie clip dynamically.

## Contents

Basics of movie clips . . . . .	491
Controlling movie clip playback . . . . .	494
Creating <code>MovieClip</code> objects with ActionScript . . . . .	498
Loading an external SWF file . . . . .	501
Example: <code>RuntimeAssetsExplorer</code> . . . . .	503

## Basics of movie clips

### Introduction to working with movie clips

Movie clips are a key element for people who create animated content with the Flash authoring tool and want to control that content with ActionScript. Whenever you create a movie clip symbol in Flash, Flash adds the symbol to the library of that Flash document. By default, this symbol becomes an instance of the `MovieClip` class, and as such has the properties and methods of the `MovieClip` class.

When an instance of a movie clip symbol is placed on the Stage, the movie clip automatically progresses through its timeline (if it has more than one frame) unless its playback is altered using ActionScript. It is this timeline that distinguishes the `MovieClip` class, allowing you to create animation through motion or shape tweens through the Flash authoring tool. By contrast, with a display object that is an instance of the `Sprite` class, you can create animation only by programmatically changing the object's values.

In previous versions of ActionScript, the `MovieClip` class was the base class of all instances on the Stage. In ActionScript 3.0, a movie clip is only one of many display objects that can appear on the screen. If a timeline is not necessary for the function of a display object, using the `Shape` class or `Sprite` class in lieu of the `MovieClip` class may improve rendering performance. For more information on choosing the appropriate display object for a task, see [“Choosing a DisplayObject subclass” on page 393](#).

## Common movie clip tasks

The following common movie clips tasks are described in this chapter:

- Making movie clips play and stop
- Playing movie clips in reverse
- Moving the playhead to specific points in a movie clip’s timeline
- Working with frame labels in ActionScript
- Accessing scene information in ActionScript
- Creating instances of library movie clip symbols using ActionScript
- Loading and controlling external SWF files, including files created for previous Flash Player versions
- Building an ActionScript system for creating graphical assets to be loaded and used at run time

## Important concepts and terms

The following reference list contains important terms used in this chapter:

- AVM1 SWF: A SWF file created using ActionScript 1.0 or ActionScript 2.0, usually targeting Flash Player 8 or earlier.
- AVM2 SWF: A SWF file created using ActionScript 3.0 for Adobe Flash Player 9.
- External SWF: A SWF file that is created separately from the project SWF file and is intended to be loaded into the project SWF file and played back within that SWF file.
- Frame: The smallest division of time on the timeline. As with a motion picture filmstrip, each frame is like a snapshot of the animation in time, and when frames are played quickly in sequence, the effect of animation is created.

- **Timeline:** The metaphorical representation of the series of frames that make up a movie clip's animation sequence. The timeline of a `MovieClip` object is equivalent to the timeline in the Flash authoring tool.
- **Playhead:** A marker identifying the location (frame) in the timeline that is being displayed at a given moment.

## Working through in-chapter examples

As you're working through the chapter, you may want to test some of the example code listings for yourself. Because this chapter is about working with movie clips in `ActionScript`, essentially all the code listings in this chapter are written with the idea of manipulating a movie clip symbol that has been created and placed on the Stage. Testing the sample will involve viewing the result in Flash Player to see the effects of the code on the symbol. To test the code listings in this chapter:

1. Create an empty Flash document.
2. Select a keyframe in the timeline.
3. Open the Actions panel and copy the code listing into the Script pane.
4. Create a movie clip symbol instance on the Stage. For example, draw a shape, select it, choose `Modify > Convert to symbol`, and give the symbol a name.
5. With the movie clip selected, in the Property inspector, give it an instance name. The name should match the name used for the movie clip in the example code listing—for example, if the code listing manipulates a movie clip named `myMovieClip`, you should name your movie clip instance `myMovieClip` as well.
6. Run the program using `Control > Test Movie`.  
On the screen you will see the results of the code manipulating the movie clip as specified in the code listing.

Other techniques for testing example code listings are explained in more detail in [“Testing in-chapter example code listings” on page 63](#).

# Working with MovieClip objects

When you publish a SWF file, Flash converts all movie clip symbol instances on the Stage to MovieClip objects. You can make a movie clip symbol available to ActionScript by giving it an instance name in the Instance Name field of the Property inspector. When the SWF file is created, Flash generates the code that creates the MovieClip instance on the Stage and declares a variable using the instance name. If you have named movie clips that are nested inside other named movie clips, those child movie clips are treated like properties of the parent movie clip—you can access the child movie clip using dot syntax. For example, if a movie clip with the instance name `childClip` is nested within another clip with the instance name `parentClip`, you can make the child clip's timeline animation play by calling this code:

```
parentClip.childClip.play()
```

While some legacy methods and properties of the ActionScript 2.0 MovieClip class remain the same, others have changed. All properties prefixed with an underscore have been renamed. For example, `_width` and `_height` properties are now accessed as `width` and `height`, while `_xscale` and `_yscale` are now accessed as `scaleX` and `scaleY`. For a complete list of the properties and methods of the MovieClip class, consult the *ActionScript 3.0 Language and Components Reference*.

## Controlling movie clip playback

Flash uses the metaphor of a timeline to convey animation or a change in state. Any visual element that employs a timeline must be either a MovieClip object or extend from the MovieClip class. While ActionScript can direct any movie clip to stop, play, or go to another point on the timeline, it cannot be used to dynamically create a timeline or add content at specific frames; this is only possible using the Flash authoring tool.

When a MovieClip is playing, it progresses along its timeline at a speed dictated by the frame rate of the SWF file. Alternatively, you can override this setting by setting the `Stage.frameRate` property in ActionScript.

## Playing movie clips and stopping playback

The `play()` and `stop()` methods allow basic control of a movie clip across its timeline. For example, suppose you have a movie clip symbol on the Stage which contains an animation of a bicycle moving across the screen, with its instance name set to `bicycle`. If the following code is attached to a keyframe on the main timeline,

```
bicycle.stop();
```

the bicycle will not move (its animation will not play). The bicycle's movement could start through some other user interaction. For example, if you had a button named `startButton`, the following code on a keyframe on the main timeline would make it so that clicking the button causes the animation to play:

```
// This function will be called when the button is clicked. It causes the
// bicycle animation to play.
function playAnimation(event:MouseEvent):void
{
    bicycle.play();
}
// Register the function as a listener with the button.
startButton.addEventListener(MouseEvent.CLICK, playAnimation);
```

## Fast-forwarding and rewinding

The `play()` and `stop()` methods are not the only way of controlling playback in a movie clip. You can also move the playhead forward or backward along the timeline manually by using the `nextFrame()` and `prevFrame()` methods. Calling either of these methods stops playback and moves the playhead one frame forward or backward, respectively.

Using the `play()` method is analogous to calling `nextFrame()` every time the movie clip object's `enterFrame` event is triggered. Along these lines, you could make the `bicycle` movie clip play backwards by creating an event listener for the `enterFrame` event and telling `bicycle` to go to its previous frame in the listener function, as follows:

```
// This function is called when the enterFrame event is triggered, meaning
// it's called once per frame.
function everyFrame(event:Event):void
{
    if (bicycle.currentFrame == 1)
    {
        bicycle.gotoAndStop(bicycle.totalFrames);
    }
    else
```

```

    {
        bicycle.prevFrame();
    }
}
bicycle.addEventListener(Event.ENTER_FRAME, everyFrame);

```

In normal playback, if a movie clip contains more than a single frame, it will loop indefinitely when playing; that is, it will return to Frame 1 if it progresses past its final frame. When you use `prevFrame()` or `nextFrame()`, this behavior does not happen automatically (calling `prevFrame()` when the playhead is on Frame 1 doesn't move the playhead to the last frame). The `if` condition in the example above checks to see if the playhead has progressed backwards to the first frame, and sets the playhead ahead to its final frame, effectively creating a continuous loop of the movie clip playing backwards.

## Jumping to a different frame and using frame labels

Sending a movie clip to a new frame is a simple affair. Calling either `gotoAndPlay()` or `gotoAndStop()` will jump the movie clip to the frame number specified as a parameter. Alternatively, you can pass a string that matches the name of a frame label. Any frame on the timeline can be assigned a label. To do this, select a frame on the timeline and then enter a name in the Frame Label field on the Property inspector.

The advantages of using frame labels instead of numbers are particularly evident when creating a complex movie clip. When the number of frames, layers, and tweens in an animation becomes large, consider labeling important frames with explanatory descriptions that represent shifts in the behavior of the movie clip (for example, “off,” “walking,” or “running”). This improves code readability and also provides flexibility, since ActionScript calls that go to a labeled frame are pointers to a single reference—the label—rather than a specific frame number. If later on you decide to move a particular segment of the animation to a different frame, you will not need to change your ActionScript code as long as you keep the same label for the frames in the new location.

To represent frame labels in code, ActionScript 3.0 includes the `FrameLabel` class. Each instance of this class represents a single frame label, and has a `name` property representing the name of the frame label as specified in the Property inspector, and a `frame` property representing the frame number of the frame where the label is placed on the timeline.

In order to get access to the `FrameLabel` instances associated with a movie clip instance, the `MovieClip` class includes two properties that directly return `FrameLabel` objects. The `currentLabels` property returns an array that consists of all `FrameLabel` objects across the entire timeline of a movie clip. The `currentLabel` property returns a single `FrameLabel` object representing the frame label encountered most recently along the timeline.



Suppose you were creating a movie clip named `robot` and had labeled the various states of its animation. You could set up a condition that checks the `currentLabel` property to access the current state of `robot`, as in the following code:

```
if (robot.currentLabel.name == "walking")
{
    // do something
}
```

## Working with scenes

In the Flash authoring environment, you can use scenes to demarcate a series of timelines that a SWF file will progress through. Using the second parameter of the `gotoAndPlay()` or `gotoAndStop()` methods, you can specify a scene to send the playhead to. All FLA files start with only the initial scene, but you can create new scenes.

Using scenes is not always the best approach because scenes have a number of drawbacks. A Flash document that contains multiple scenes can be difficult to maintain, particularly in multiauthor environments. Multiple scenes can also be inefficient in bandwidth, because the publishing process merges all scenes into a single timeline. This causes a progressive download of all scenes, even if they are never played. For these reasons, use of multiple scenes is often discouraged except for organizing lengthy multiple timeline-based animations.

The `scenes` property of the `MovieClip` class returns an array of `Scene` objects representing all the scenes in the SWF file. The `currentScene` property returns a `Scene` object that represents the scene that is currently playing.

The `Scene` class has several properties that give information about a scene. The `labels` property returns an array of `FrameLabel` objects representing the frame labels in that scene. The `name` property returns the scene's name as a string. The `numFrames` property returns an `int` representing the total number of frames in the scene.

# Creating MovieClip objects with ActionScript

One way of adding content to the screen in Flash is by dragging assets from the library onto the Stage, but that is not the only workflow. For complex projects, experienced developers commonly prefer to create movie clips programatically. This approach brings several advantages: easier re-use of code, faster compile-time speed, and more sophisticated modifications that are available only to ActionScript.

The display list API of ActionScript 3.0 streamlines the process of dynamically creating MovieClip objects. The ability to instantiate a MovieClip instance directly, separate from the process of adding it to the display list, provides flexibility and simplicity without sacrificing control.

In ActionScript 3.0, when you create a movie clip (or any other display object) instance programatically, it is not visible on the screen until it is added to the display list by calling the `addChild()` or the `addChildAt()` method on a display object container. This allows you to create a movie clip, set its properties, and even call methods before it is rendered to the screen. For more information on working with the display list, see [“Working with display object containers” on page 383](#).

## Exporting library symbols for ActionScript

By default, instances of movie clip symbols in a Flash document’s library cannot be dynamically created (that is, created using only ActionScript). This is because each symbol that is exported for use in ActionScript adds to the size of your SWF file, and it’s recognized that some symbols might not be intended for use on the stage. For this reason, in order to make a symbol available in ActionScript, you must specify that the symbol should be exported for ActionScript.

### **To export a symbol for ActionScript:**

1. Select the symbol in the Library panel and open its Symbol Properties dialog box.
2. If necessary, activate the Advanced settings.
3. In the Linkage section, activate the Export for ActionScript checkbox.

This will activate the Class and Base Class fields.

By default, the Class field is populated with the symbol name, with spaces removed (for example, a symbol named “Tree House” would become “TreeHouse”). To specify that the symbol should use a custom class for its behavior, enter the full name of the class including its package in this field. If you want to be able to create instances of the symbol in ActionScript, but don’t need to add any additional behavior, you can leave the class name as-is.

The Base Class field’s value defaults to `flash.display.MovieClip`. If you want your symbol to extend the functionality of another customer class, you can specify that class’s name instead, as long as that class extends the Sprite (or MovieClip) class.

4. Press the OK button to save the changes.

At this point, if Flash can’t find an external ActionScript file with a definition for the specified class (for instance, if you didn’t need to add additional behavior for the symbol), a warning is displayed:

*A definition for this class could not be found in the classpath, so one will be automatically generated in the SWF file upon export.*

You can disregard this warning if your library symbol does not require unique functionality beyond the functionality of the MovieClip class.

If you do not provide a class for your symbol, Flash will create a class for your symbol equivalent to this one:

```
package
{
    import flash.display.MovieClip;

    public class ExampleMovieClip extends MovieClip
    {
        public function ExampleMovieClip()
        {
        }
    }
}
```

If you do want to add extra ActionScript functionality to your symbol, add the appropriate properties and methods to this structure. For example, suppose you have a movie clip symbol containing a circle of 50 pixels width and 50 pixels height, and the symbol is specified to be exported for ActionScript with a class named Circle. The following code, when placed in a Circle.as file, extends the MovieClip class and provides the symbol with the additional methods `getArea()` and `getCircumference()`:

```
package
{
    import flash.display.MovieClip;
```

```

public class Circle extends MovieClip
{
    public function Circle()
    {
    }

    public function getArea():Number
    {
        // The formula is Pi times the radius squared.
        return Math.PI * Math.pow((width / 2), 2);
    }

    public function getCircumference():Number
    {
        // The formula is Pi times the diameter.
        return Math.PI * width;
    }
}
}

```

The following code, placed on a keyframe on Frame 1 of the Flash document, will create an instance of the symbol and display it on the screen:

```

var c:Circle = new Circle();
addChild(c);
trace(c.width);
trace(c.height);
trace(c.getArea());
trace(c.getCircumference());

```

This code demonstrates ActionScript-based instantiation as an alternative to dragging individual assets onto the Stage. It creates a circle that has all of the properties of a movie clip and also has the custom methods defined in the Circle class. This is a very basic example—your library symbol can specify any number of properties and methods in its class.

ActionScript-based instantiation is powerful, because it allows you to dynamically create large quantities of instances that would be tedious to arrange manually. It is also flexible, because you can customize each instance's properties as it is created. You can get a sense of both of these benefits by using a loop to dynamically create several Circle instances. With the Circle symbol and class described previously in your Flash document's library, place the following code on a keyframe on Frame 1:

```

import flash.geom.ColorTransform;

var totalCircles:uint = 10;
var i:uint;
for (i = 0; i < totalCircles; i++)
{

```

```

// Create a new Circle instance.
var c:Circle = new Circle();
// Place the new Circle at an x coordinate that will space the circles
// evenly across the Stage.
c.x = (stage.stageWidth / totalCircles) * i;
// Place the Circle instance at the vertical center of the Stage.
c.y = stage.stageHeight / 2;
// Change the Circle instance to a random color
c.transform.colorTransform = getRandomColor();
// Add the Circle instance to the current timeline.
addChild(c);
}

function getRandomColor():ColorTransform
{
// Generate random values for the red, green, and blue color channels.
var red:Number = (Math.random() * 512) - 255;
var green:Number = (Math.random() * 512) - 255;
var blue:Number = (Math.random() * 512) - 255;

// Create and return a ColorTransform object with the random colors.
return new ColorTransform(1, 1, 1, 1, red, green, blue, 0);
}

```

This demonstrates how you can create and customize multiple instances of a symbol quickly using code. Each instance is positioned based on the current count within the loop, and each instance is given a random color by setting its `transform` property (which `Circle` inherits by extending the `MovieClip` class).

## Loading an external SWF file

In ActionScript 3.0, SWF files are loaded using the `Loader` class. To load an external SWF file, your ActionScript needs to do four things:

1. Create a new `URLRequest` object with the url of the file.
2. Create a new `Loader` object.
3. Call the `Loader` object's `load()` method, passing the `URLRequest` instance as a parameter.
4. Call the `addChild()` method on a display object container (such as the main timeline of a Flash document) to add the `Loader` instance to the display list.

Ultimately, the code looks like this:

```

var request:URLRequest = new URLRequest("http://www.[yourdomain].com/
externalSwf.swf");
var loader:Loader = new Loader()
loader.load(request);
addChild(loader);

```

This same code can be used to load an external image file such as a JPEG, GIF, or PNG image, by specifying the image file's url rather than a SWF file's url. A SWF file, unlike an image file, may contain ActionScript. Thus, although the process of loading a SWF file may be identical to loading an image, when loading an external SWF file both the SWF file doing the loading and the SWF file being loaded must reside in the same security sandbox if you plan to use ActionScript to communicate in any way to the external SWF file. Additionally, if the external SWF file contains classes that share the same namespace as classes in the loading SWF file, you may need to create a new application domain for the loaded SWF file in order to avoid namespace conflicts. For more information on security and application domain considerations, see [“Using the ApplicationDomain class” on page 700](#) and [“Loading SWF files and images” on page 776](#).

When the external SWF file is successfully loaded, it can be accessed through the `Loader.content` property. If the external SWF file is published for ActionScript 3.0, this will be either a movie clip or a sprite, depending on which class it extends.

## Considerations for loading an older SWF file

If the external SWF file has been published with an older version of ActionScript, there are important limitations to consider. Unlike an ActionScript 3.0 SWF file that runs in AVM2 (ActionScript Virtual Machine 2), a SWF file published for ActionScript 1.0 or 2.0 runs in AVM1 (ActionScript Virtual Machine 1).

When an AVM1 SWF file is successfully loaded, the loaded object (the `Loader.content` property) will be an `AVM1Movie` object. An `AVM1Movie` instance is not the same as a `MovieClip` instance. It is a display object, but unlike a movie clip, it does not include timeline-related methods or properties. The parent AVM2 SWF file will not have access to the properties, methods, or objects of the loaded `AVM1Movie` object.

There are additional restrictions on an AVM1 SWF file loaded by an AVM2 SWF file. For details, see the `AVM1Movie` class listing in the *ActionScript 3.0 Language and Components Reference*.

# Example: RuntimeAssetsExplorer

The Export for ActionScript functionality can be especially advantageous for libraries that may be useful across more than one project. Symbols that have been exported to ActionScript are available not only to that SWF file alone but to any SWF file within the same security sandbox that loads it. In this way, a single Flash document can generate a SWF file that is designated for the sole purpose of holding graphical assets. This technique is particularly useful for larger projects where designers working on visual assets can work in parallel with developers who create a “wrapper” SWF file that then loads the graphical assets SWF file at run time. You can use this method to maintain a series of versioned files where graphical assets are not dependent upon the progress of programming development.

The RuntimeAssetsExplorer application loads any SWF file that is a subclass of RuntimeAsset and allows you to browse the available assets of that SWF file. The example illustrates the following:

- Loading an external SWF file using `Loader.load()`
- Dynamic creation of a library symbol exported for ActionScript
- ActionScript control of MovieClip playback

Before beginning, note that each of the SWF files must be located in the same security sandbox. For more information, see “[Security sandboxes](#)” on page 770.

To get the application files for this sample, see [www.adobe.com/go/learn\\_programmingAS3samples\\_flash](http://www.adobe.com/go/learn_programmingAS3samples_flash). The RuntimeAssetsExplorer application files can be found in the folder Samples/RuntimeAssetsExplorer. The application consists of the following files:

File	Description
RuntimeAssetsExample.mxml or RuntimeAssetsExample fla	The user interface for the application for Flex (MXML) or Flash (FLA).
GeometricAssets.as	An example class that implements the RuntimeAsset interface.
GeometricAssets fla	A FLA file linked to the GeometricAssets class (the document class of the FLA) containing symbols that are exported for ActionScript.
com/example/programmingas3/ runtimeassetsexplorer/RuntimeLibrary.as	An interface that defines the required methods expected of all run-time asset SWF files that will be loaded into the explorer container.

---

File	Description
com/example/programmingas3/runtimeassetexplorer/AnimatingBox.as	The class of the library symbol in the shape of a rotating box.
com/example/programmingas3/runtimeassetexplorer/AnimatingStar.as	The class of the library symbol in the shape of a rotating star.

---

## Establishing a run-time library interface

In order for the explorer to properly interact with a SWF library, the structure of the run-time asset libraries must be formalized. We will accomplish this by creating an interface, which is similar to a class in that it's a blueprint of methods that demarcate an expected structure, but unlike a class it includes no method bodies. The interface provides a way for both the run-time library and the explorer to communicate to one another. Each SWF of run-time assets that is loaded in our browser will implement this interface. For more information about interfaces and how they can be useful, see [“Interfaces” on page 158](#).

The `RuntimeLibrary` interface will be very simple—we merely require a function that can provide the explorer with an array of classpaths for the symbols to be exported and available in the run-time library. To this end, the interface has a single method: `getAssets()`.

```
package com.example.programmingas3.runtimeassetexplorer
{
    public interface RuntimeLibrary
    {
        function getAssets():Array;
    }
}
```

## Creating the asset library SWF file

By defining the `RuntimeLibrary` interface, it's possible to create multiple asset library SWF files that can be loaded into another SWF file. Making an individual SWF library of assets involves four tasks:

- Creating a class for the asset library SWF file
- Creating classes for individual assets contained in the library
- Creating the actual graphic assets
- Associating graphic elements with classes and publishing the library SWF



## Creating a class to implement the RuntimeLibrary interface

Next, we'll create the `GeometricAssets` class that will implement the `RuntimeLibrary` interface. This will be the document class of the FLA. The code for this class is very similar to the `RuntimeLibrary` interface—the difference between them is that in the class definition the `getAssets()` method has a method body.

```
package
{
    import flash.display.Sprite;
    import com.example.programmingas3.runtimeassetexplorer.RuntimeLibrary;

    public class GeometricAssets extends Sprite implements RuntimeLibrary
    {
        public function GeometricAssets() {
        }
        public function getAssets():Array {
            return [
                "com.example.programmingas3.runtimeassetexplorer.AnimatingBox",
                "com.example.programmingas3.runtimeassetexplorer.AnimatingStar" ];
        }
    }
}
```

If we were to create a second run-time library, we could create another FLA based upon another class (for example, `AnimationAssets`) that provides its own `getAssets()` implementation.

## Creating classes for each MovieClip asset

For this example, we'll merely extend the `MovieClip` class without adding any functionality to the custom assets. The following code for `AnimatingStar` is analogous to that of `AnimatingBox`:

```
package com.example.programmingas3.runtimeassetexplorer
{
    import flash.display.MovieClip;

    public class AnimatingStar extends MovieClip
    {
        public function AnimatingStar() {
        }
    }
}
```

## Publishing the library

We'll now connect the `MovieClip`-based assets to the new class by creating a new FLA and entering `GeometricAssets` into the `Document Class` field of the `Property inspector`. For the purposes of this example, we'll create two very basic shapes that use a `timeline tween` to make one clockwise rotation over 360 frames. Both the `animatingBox` and `animatingStar` symbols are set to `Export for ActionScript` and have the `Class` field set to the respective classpaths specified in the `getAssets()` implementation. The default base class of `flash.display.MovieClip` remains, as we want to subclass the standard `MovieClip` methods.

After setting up your symbol's export settings, publish the FLA. You now have your first run-time library. This SWF file could be loaded into another AVM2 SWF file and the `AnimatingBox` and `AnimatingStar` symbols would be available to the new SWF file.

## Loading the library into another SWF file

The last functional piece to deal with is the user interface for the asset explorer. In this example, the path to the run-time library is hard-coded as a variable named `ASSETS_PATH`. Alternatively, you could use the `FileReference` class—for example, to create an interface that browses for a particular SWF file on your hard drive.

When the run-time library is successfully loaded, Flash Player calls the `runtimeAssetsLoadComplete()` method:

```
private function runtimeAssetsLoadComplete(event:Event):void
{
    var rl:* = event.target.content;
    var assetList:Array = rl.getAssets();
    populateDropDown(assetList);
    stage.frameRate = 60;
}
```

In this method, the variable `rl` represents the loaded SWF file. The code calls the `getAssets()` method of the loaded SWF file, obtaining the list of assets that are available, and uses them to populate a `ComboBox` component with a list of available assets by calling the `populateDropDown()` method. That method in turn stores the full classpath of each asset. Clicking the `Add` button on the user interface triggers the `addAsset()` method:

```
private function addAsset():void
{
    var className:String = assetNameCbo.selectedItem.data;
    var AssetClass:Class = getDefinitionByName(className) as Class;
    var mc:MovieClip = new AssetClass();
    ...
}
```

which gets the classpath of whichever asset is currently selected in the `ComboBox` (`assetNameCbo.selectedItem.data`), and uses the `getDefinitionByName()` function (from the `flash.utils` package) to obtain an actual reference to the asset's class in order to create a new instance of that asset.



In ActionScript 3.0, text is usually displayed within a text field, but can occasionally appear as a property of an item on the display list (for example, as the label on a UI component). This chapter explains how to work with the script-defined contents of a text field and with user input, dynamic text from a remote file, or static text defined in Adobe Flash CS3 Professional. As an ActionScript 3.0 programmer, you can establish specific content for text fields, or designate the source for the text, and then set the appearance of that text using styles and formats. You can also respond to user events as the user inputs text or clicks a hyperlink.

## Contents

Basics of working with text.....	510
Displaying text.....	513
Selecting and manipulating text.....	517
Capturing text input.....	518
Restricting text input.....	520
Formatting text.....	520
Advanced text rendering.....	525
Working with static text.....	528
Example: Newspaper-style text formatting.....	529

# Basics of working with text

## Introduction to working with text

To display any text on the screen in Adobe Flash Player, you use an instance of the `TextField` class. The `TextField` class is the basis for other text-based components, like the `TextArea` components or the `TextInput` components, that are provided in the Adobe Flex framework and in the Flash authoring environment. For more information about using text components in the Flash authoring environment, please see “About text controls” in *Using Flash*.

Text field content can be pre-specified in the SWF file, loaded from an external source like a text file or database, or entered by users interacting with your application. Within a text field, the text can appear as rendered HTML content, with images embedded in the rendered HTML. Once you establish an instance of a text field, you can use `flash.text` package classes, like the `TextFormat` class and the `StyleSheet` class, to control the text’s appearance. The [flash.text](#) package contains nearly all the classes related to creating, managing, and formatting text in ActionScript.

You can format text by defining the formatting with a `TextFormat` object and assigning that object to the text field. If your text field contains HTML text, you can apply a `StyleSheet` object to the text field to assign styles to specific pieces of the text field content. The `TextFormat` object or `StyleSheet` object contains properties defining the appearance of the text, such as color, size, and weight. The `TextFormat` object assigns the properties to all the content within a text field or to a range of text. For example, within the same text field, one sentence can be bold red text and the next sentence can be blue italic text.

For more information on text formats, see [“Assigning text formats” on page 521](#).

For more information on HTML text in text fields, see [“Displaying HTML text” on page 514](#).

For more information on style sheets, see [“Applying cascading style sheets” on page 521](#).

In addition to the classes in the `flash.text` package, you can use the `flash.events.TextEvent` class to respond to user actions related to text.

## Common tasks for working with text

The following common text-related tasks are described in this chapter:

- Modifying text field contents
- Using HTML in text fields
- Using images in text fields
- Selecting text and working with user-selected text
- Capturing text input
- Restricting text input
- Applying formatting and CSS styles to text
- Fine-tuning text display with sharpness, thickness, and anti-aliasing
- Accessing and working with static text fields from ActionScript

## Important concepts and terms

The following reference list contains important terms that you will encounter in this chapter:

- Cascading style sheets: A standard syntax for specifying styles and formatting for content that's structured in XML (or HTML) format.
- Device font: A font that is installed on the user's machine.
- Dynamic text field: A text field whose contents can be changed by ActionScript but not by user input.
- Embedded font: A font that has data its character outline data stored in the application's SWF file.
- HTML text: Text content entered into a text field using ActionScript that includes HTML formatting tags along with actual text content.
- Input text field: A text field whose contents can be changed either by user input or by ActionScript.
- Static text field: A text field created in the Flash authoring tool, whose content cannot change when the SWF file is running.
- Text line metrics: Measurements of the size of various parts of the text content in a text field, such as the baseline of the text, the height of the top of the characters, size of descenders (the part of some lowercase letters that extends below the baseline), and so on.

## Working through in-chapter examples

As you're working through the chapter, you may want to test some of the example code listings for yourself. Because this chapter is about working with text fields in ActionScript, essentially all the code listings in this chapter involve manipulating a `TextField` object, either one that has been created and placed on the Stage in the Flash authoring tool, or one that's created using ActionScript. Testing a sample involves viewing the result in Flash Player to see the effects of the code on the text field.

The examples in this chapter fall into two groups. One type of example manipulates a `TextField` object without creating the object explicitly. To test these code listings in this chapter:

1. Create an empty Flash document.
2. Select a keyframe in the timeline.
3. Open the Actions panel and copy the code listing into the Script pane.
4. Using the Text tool, create a dynamic text field on the Stage.
5. With the text field selected, in the Property inspector, give it an instance name. The name should match the name used for the text field in the example code listing—for example, if the code listing manipulates a text field named `myTextField`, you should name your text field `myTextField` as well.
6. Run the program using `Control > Test Movie`.

On the screen you will see the results of the code manipulating the text field as specified in the code listing.

The other type of example code listing in this chapter consists of a class definition that is intended to be used as the document class for the SWF. In those listings, a `TextField` instance is created by the example code, so you will not need to create one separately. To test this type of code listing:

1. Create an empty Flash document and save it to your computer.
2. Create a new ActionScript file and save it in the same directory as the Flash document. The file's name should match the name of the class in the code listing. For instance, if the code listing defines a class named `TextFieldTest`, use the name `TextFieldTest.as` to save the ActionScript file.
3. Copy the code listing into the ActionScript file and save the file.
4. In the Flash document, click a blank part of the Stage or work space to activate the document Property inspector.



5. In the Property inspector, in the Document Class field, enter the name of the ActionScript class you copied from the text.
6. Run the program using Control > Test Movie.  
You will see the results of the example displayed on the screen.

Other techniques for testing example code listings are explained in more detail in [“Testing in-chapter example code listings” on page 63](#).

## Displaying text

Although authoring tools like Adobe Flex Builder and the Flash authoring tool provide several options for displaying text, including text-related components or text tools, the primary way to display text programmatically is through a text field.

## Types of text

The type of text within a text field is characterized by its source:

- **Dynamic text**  
Dynamic text includes content that is loaded from an external source, such as a text file, an XML file, or even a remote web service. For more information, see [“Types of text” on page 513](#).
- **Input text**  
Input text is any text entered by a user or dynamic text that a user can edit. You can set up a style sheet to format input text, or use the `flash.text.TextFormat` class to assign properties to the text field for the input content. For more information, see [“Capturing text input” on page 518](#).
- **Static text**  
Static text is created through the Flash authoring tool only. You cannot create a static text instance using ActionScript 3.0. However, you can use ActionScript classes like `StaticText` and `TextSnapshot` to manipulate an existing static text instance. For more information, see [“Working with static text” on page 528](#).

## Modifying the text field contents

You can define dynamic text by assigning a string to the `flash.text.TextField.text` property. You assign a string directly to the property, as follows:

```
myTextField.text = "Hello World";
```

You can also assign the `text` property a value from a variable defined in your script, as in the following example:

```
package
{
    import flash.display.Sprite;
    import flash.text.*;

    public class TextWithImage extends Sprite
    {
        private var myTextBox:TextField = new TextField();
        private var myText:String = "Hello World";

        public function TextWithImage()
        {
            addChild(myTextBox);
            myTextBox.text = myText;
        }
    }
}
```

Alternatively, you can assign the `text` property a value from a remote variable. You have three options for loading text values from remote sources:

- The `flash.net.URLLoader` and `flash.net.URLRequest` classes load variables for the text from a local or remote location.
- The `FlashVars` attribute is embedded in the HTML page hosting the SWF file and can contain values for text variables.
- The `flash.net.SharedObject` class manages persistent storage of values. For more information, see [“Storing local data” on page 668](#).

## Displaying HTML text

The `flash.text.TextField` class has an `htmlText` property that you can use to identify your text string as one containing HTML tags for formatting the content. As in the following example, you must assign your string value to the `htmlText` property (not the `text` property) for Flash Player to render the text as HTML:

```
var myText:String = "<p>This is <b>some</b> content to <i>render</i> as  
<u>HTML</u> text.</p>";  
myTextBox.htmlText = myText;
```

Flash Player supports a subset of HTML tags and entities for the `htmlText` property. The `flash.text.TextField.htmlText` property description in the *ActionScript 3.0 Language and Components Reference* provides detailed information about the supported HTML tags and entities.

Once you designate your content using the `htmlText` property, you can use style sheets or the `textFormat` tag to manage the formatting of your content. For more information, see [“Formatting text” on page 520](#).

## Using images in text fields

Another advantage to displaying your content as HTML text is that you can include images in the text field. You can reference an image, local or remote, using the `img` tag and have it appear within the associated text field.

The following example creates a text field named `myTextBox` and includes a JPG image of an eye, stored in the same directory as the SWF file, within the displayed text:

```
package
{
    import flash.display.Sprite;
    import flash.text.*;

    public class TextWithImage extends Sprite
    {
        private var myTextBox:TextField;
        private var myText:String = "<p>This is <b>some</b> content to
        <i>test</i> and <i>see</i></p><p><img src='eye.jpg' width='20'
        height='20'></p><p>what can be rendered.</p><p>You should see an eye
        image and some <u>HTML</u> text.</p>";

        public function TextWithImage()
        {
            myTextBox.width = 200;
            myTextBox.height = 200;
            myTextBox.multiline = true;
            myTextBox.wordWrap = true;
            myTextBox.border = true;

            addChild(myTextBox);
            myTextBox.htmlText = myText;
        }
    }
}
```

The `img` tag supports JPEG, GIF, PNG, and SWF files.

## Scrolling text in a text field

In many cases, your text will be longer than the text field displaying the text. Or you may have an input field that allows a user to input more text than can be displayed at one time. You can use the scroll-related properties of the `flash.text.TextField` class to manage lengthy content, either vertically or horizontally.

The scroll-related properties include `TextField.scrollV`, `TextField.scrollH` and `maxScrollV` and `maxScrollH`. Use these properties to respond to events, like a mouse click or a keypress.

The following example creates a text field that is a set size and contains more text than the field can display at one time. As the user clicks on the text field, the text scrolls vertically.

```
package
{
    import flash.display.Sprite;
    import flash.text.*;
    import flash.events.MouseEvent;

    public class TextScrollExample extends Sprite
    {
        private var myTextBox:TextField = new TextField();
        private var myText:String = "Hello world and welcome to the show. It's really nice to meet you. Take your coat off and stay a while. OK, show is over. Hope you had fun. You can go home now. Don't forget to tip your waiter. There are mints in the bowl by the door. Thank you. Please come again.";

        public function TextScrollExample()
        {
            myTextBox.text = myText;
            myTextBox.width = 200;
            myTextBox.height = 50;
            myTextBox.multiline = true;
            myTextBox.wordWrap = true;
            myTextBox.background = true;
            myTextBox.border = true;

            var format:TextFormat = new TextFormat();
            format.font = "Verdana";
            format.color = 0xFF0000;
            format.size = 10;

            myTextBox.defaultTextFormat = format;
            addChild(myTextBox);
            myTextBox.addEventListener(MouseEvent.CLICK, mouseDownScroll);
        }
    }
}
```

```

    public function mouseDownScroll(event:MouseEvent):void
    {
        myTextBox.scrollV++;
    }
}

```

## Selecting and manipulating text

You can select dynamic or input text. Since the text selection properties and methods of the `TextField` class use index positions to set the range of text to manipulate, you can programmatically select dynamic or input text even if you don't know the content.

**NOTE**

In the Flash authoring tool, if you choose the selectable option on a static text field, the text field that is exported and placed on the display list is a regular, dynamic text field.

### Selecting text

The `flash.text.TextField.selectable` property is true by default, and you can programmatically select text using the `setSelection()` method.

For example, you can set specific text within a text field to be selected when the user clicks on the text field:

```

var myTextField:TextField = new TextField();
myTextField.text = "No matter where you click on this text field the TEXT IN
    ALL CAPS is selected.";
myTextField.autoSize = TextFieldAutoSize.LEFT;
addChild(myTextField);
addEventListener(MouseEvent.CLICK, selectText);

function selectText(event:MouseEvent):void
{
    myTextField.setSelection(49, 65);
}

```

Similarly, if you want text within a text field to be selected as the text is initially displayed, create an event handler function that is called as the text field is added to the display list.

## Capturing user-selected text

The `TextField` class's `selectionBeginIndex` and `selectionEndIndex` properties, which are “read-only” so they can't be set to programmatically select text, can be used to capture whatever the user has currently selected. Additionally, input text fields can use the `caretIndex` property.

For example, the following code traces the index values of user-selected text:

```
var myTextField:TextField = new TextField();
myTextField.text = "Please select the TEXT IN ALL CAPS to see the index
    values for the first and last letters.";
myTextField.autoSize = TextFieldAutoSize.LEFT;
addChild(myTextField);
addEventListener(MouseEvent.CLICK, selectText);

function selectText(event:MouseEvent):void
{
    trace("First letter index position: " + myTextField.selectionBeginIndex);
    trace("Last letter index position: " + myTextField.selectionEndIndex);
}
```

You can apply a collection of `TextFormat` object properties to the selection to change the text's appearance. For more information about applying a collection of `TextFormat` properties to selected text, see [“Formatting ranges of text within a text field” on page 524](#).

## Capturing text input

By default, a text field's `type` property is set to `dynamic`. If you set the `type` property to `input` using the `TextFieldType` class, you can collect user input and save the value for use in other parts of your application. Input text fields are useful for forms and any application that wants the user to define a text value for use elsewhere in the program.

For example, the following code creates an input text field called `myTextBox`. As the user enters text in the field, the `textInput` event is triggered. An event handler called `textInputCapture` captures the string of text entered and assigns it a variable. Flash Player displays the new text in another text field, called `myOutputBox`.

```
package
{
    import flash.display.Sprite;
    import flash.display.Stage;
    import flash.text.*;
    import flash.events.*;

    public class CaptureUserInput extends Sprite
    {
```

```

private var myTextBox:TextField = new TextField();
private var myOutputBox:TextField = new TextField();
private var myText:String = "Type your text here.";

public function CaptureUserInput()
{
    captureText();
}

public function captureText():void
{
    myTextBox.type = TextFieldType.INPUT;
    myTextBox.background = true;
    addChild(myTextBox);
    myTextBox.text = myText;
    myTextBox.addEventListener(TextEvent.TEXT_INPUT, textInputCapture);
}

public function textInputCapture(event:TextEvent):void
{
    var str:String = myTextBox.text;
    createOutputBox(str);
}

public function createOutputBox(str:String):void
{
    myOutputBox.background = true;
    myOutputBox.x = 200;
    addChild(myOutputBox);
    myOutputBox.text = str;
}
}
}

```

# Restricting text input

Since input text fields are often used for forms or dialog boxes in applications, you may want to limit the types of characters a user can enter in a text field, or even keep the text hidden — for example, for a password. The `flash.text.TextField` class has a `displayAsPassword` property and a `restrict` property that you can set to control user input.

The `displayAsPassword` property simply hides the text (displaying it as a series of asterisks) as the user types it. When `displayAsPassword` is set to `true`, the Cut and Copy commands and their corresponding keyboard shortcuts will not function. As the following example shows, you assign the `displayAsPassword` property just as you would other properties, such as `background` and `color`:

```
myTextBox.type = TextFieldType.INPUT;
myTextBox.background = true;
myTextBox.displayAsPassword = true;
addChild(myTextBox);
```

The `restrict` property is a little more complicated since you need to specify what characters the user is allowed to type in an input text field. You can allow specific letters, numbers, or ranges of letters, numbers, and characters. The following code allows the user to enter only uppercase letters (and not numbers or special characters) in the text field:

```
myTextBox.restrict = "A-Z";
```

ActionScript 3.0 uses hyphens to define ranges, and carets to define excluded characters. For more information about defining what is restricted in an input text field, see the `flash.text.TextField.restrict` property entry in the *ActionScript 3.0 Language and Components Reference*.

# Formatting text

You have several options for programmatically formatting the display of text. You can set properties directly on the `TextField` instance—for example, the `TextField.thickness`, `TextField.textColor`, and `TextField.textHeight` properties. Or you can designate the content of the text field using the `htmlText` property and use the supported HTML tags, such as `b`, `i`, and `u`. But you can also apply `TextFormat` objects to text fields containing plain text, or `StyleSheet` objects to text fields containing the `htmlText` property. Using `TextFormat` and `StyleSheet` objects provides the most control and consistency over the appearance of text throughout your application. You can define a `TextFormat` or `StyleSheet` object and apply it to many or all text fields in your application.



## Assigning text formats

You can use the `TextFormat` class to set a number of different text display properties and to apply them to the entire contents of a `TextField` object, or to a range of text.

The following example applies one `TextFormat` object to an entire `TextField` object and applies a second `TextFormat` object to a range of text within that `TextField` object:

```
var tf:TextField = new TextField();
tf.text = "Hello Hello";

var format1:TextFormat = new TextFormat();
format1.color = 0xFF0000;

var format2:TextFormat = new TextFormat();
format2.font = "Courier";

tf.setTextFormat(format1);
var startRange:uint = 6;
tf.setTextFormat(format2, startRange);

addChild(tf);
```

The `TextField.setTextFormat()` method only affects text that is already displayed in the text field. If the content in the `TextField` changes, your application might need to call the `TextField.setTextFormat()` method again to reapply the formatting. You can also set the `TextField` object's `defaultTextFormat` property to specify the format to be used for user-entered text.

## Applying cascading style sheets

Text fields can contain either plain text or HTML-formatted text. Plain text is stored in the `text` property of the instance, and HTML text is stored in the `htmlText` property.

You can use CSS style declarations to define text styles that you can apply to many different text fields. CSS style declarations can be created in your application code or loaded in at run time from an external CSS file.

The `flash.text.StyleSheet` class handles CSS styles. The `StyleSheet` class recognizes a limited set of CSS properties. For a detailed list of the style properties that the `StyleSheet` class supports, see the `flash.text.Stylesheet` entry in the *ActionScript 3.0 Language and Components Reference*.

As the following example shows, you can create CSS in your code and apply those styles to HTML text by using a `StyleSheet` object:

```
var style:StyleSheet = new StyleSheet();

var styleObj:Object = new Object();
styleObj.fontSize = "bold";
styleObj.color = "#FF0000";
style.setStyle(".darkRed", styleObj);

var tf:TextField = new TextField();
tf.styleSheet = style;
tf.htmlText = "<span class = 'darkRed'>Red</span> apple";

addChild(tf);
```

After creating a `StyleSheet` object, the example code creates a simple object to hold a set of style declaration properties. Then it calls the `StyleSheet.setStyle()` method, which adds the new style to the stylesheet with the name “.darkred”. Next, it applies the stylesheet formatting by assigning the `StyleSheet` object to the `TextField` object’s `styleSheet` property. For CSS styles to take effect, the stylesheet should be applied to the a `TextField` object before the `htmlText` property is set.

By design, a text field with a style sheet is not editable. If you have an input text field and assign a style sheet to it, the text field shows the style sheet’s properties, but the text field will not allow users to enter new text into it. Also, you cannot use the following ActionScript APIs on a text field with an assigned style sheet:

- The `TextField.replaceText()` method
- The `TextField.replaceSelectedText()` method
- The `TextField.defaultTextFormat` property
- The `TextField.setTextFormat()` method

If a text field has a style sheet assigned to it, but later the `TextField.styleSheet` property is set to `null`, the contents of both `TextField.text` and `TextField.htmlText` properties will add tags and attributes to their content to incorporate the formatting from the previously assigned style sheet. To preserve the original `htmlText` property, save it in a variable before setting the style sheet to `null`.

## Loading an external CSS file

The CSS approach to formatting is more powerful when you can load CSS information from an external file at run time. When the CSS data is external to the application itself, you can change the visual style of text in your application without having to change your ActionScript 3.0 source code. After your application has been deployed, you can change an external CSS file to change the look of the application, without having to redeploy the application's SWF file.

The `StyleSheet.parseCSS()` method converts a string that contains CSS data into style declarations in the `StyleSheet` object. The following example shows how to read an external CSS file and apply its style declarations to a `TextField` object.

First, here is the content of the CSS file to be loaded, which will be named `example.css`:

```
p {
    font-family: Times New Roman, Times, _serif;
    font-size: 14;
}

h1 {
    font-family: Arial, Helvetica, _sans;
    font-size: 20;
    font-weight: bold;
}

.bluetext {
    color: #0000CC;
}
```

Next is the ActionScript code for a class that loads the `example.css` file and applies the styles to `TextField` content:

```
package
{
    import flash.display.Sprite;
    import flash.events.Event;
    import flash.net.URLLoader;
    import flash.net.URLRequest;
    import flash.text.StyleSheet;
    import flash.text.TextField;
    import flash.text.TextFieldAutoSize;
```

```

public class CSSFormattingExample extends Sprite
{
    var loader:URLLoader;
    var field:TextField;
    var exampleText:String = "<h1>This is a headline</h1>" +
        "<p>This is a line of text. <span class='bluetext'>" +
        "This line of text is colored blue.</span></p>";

    public function CSSFormattingExample():void
    {
        field = new TextField();
        field.width = 300;
        field.autoSize = TextFieldAutoSize.LEFT;
        field.wordWrap = true;
        addChild(field);

        var req:URLRequest = new URLRequest("example.css");

        loader = new URLLoader();
        loader.addEventListener(Event.COMPLETE, onCSSFileLoaded);
        loader.load(req);
    }

    public function onCSSFileLoaded(event:Event):void
    {
        var sheet:StyleSheet = new StyleSheet();
        sheet.parseCSS(loader.data);
        field.styleSheet = sheet;
        field.htmlText = exampleText;
    }
}

```

When the CSS data is loaded, the `onCSSFileLoaded()` method executes and calls the `StyleSheet.parseCSS()` method to transfer the style declarations to the `StyleSheet` object.

## Formatting ranges of text within a text field

A particularly useful method of the `flash.text.TextField` class is the `setTextFormat()` method. Using `setTextFormat()`, you can assign specific properties to part of a text field's contents to respond to user input, such as forms that need to remind users that certain entries are required or to change the emphasis of a subsection of a passage of text within a text field as a user selects parts of the text.

The following example uses `TextField.setTextFormat()` on a range of characters to change the appearance of part of the content of `myTextField` when the user clicks on the text field:

```
var myTextField:TextField = new TextField();
myTextField.text = "No matter where you click on this text field the TEXT IN
  ALL CAPS changes format.";
myTextField.autoSize = TextFieldAutoSize.LEFT;
addChild(myTextField);
addEventListener(MouseEvent.CLICK, changeText);

var myformat:TextFormat = new TextFormat();
myformat.color = 0xFF0000;
myformat.size = 18;
myformat.underline = true;

function changeText(event:MouseEvent):void
{
    myTextField.setTextFormat(myformat, 49, 65);
}
```

## Advanced text rendering

ActionScript 3.0 provides a variety of classes in the `flash.text` package to control the properties of displayed text, including embedded fonts, anti-aliasing settings, alpha channel control, and other specific settings. The *ActionScript 3.0 Language and Components Reference* provides detailed descriptions of these classes and properties, including the `CSSSettings`, `Font`, and `TextRenderer` classes.

### Using embedded fonts

When you specify a specific font for a `TextField` in your application, Flash Player will look for a device font (a font that resides on the user's computer) with the same name. If it doesn't find that font on the user's system, or if the user has a slightly different version of a font with that name, the text display could look very different from what you intend.

To make sure the user sees exactly the right font, you can embed that font in your application's SWF file. Embedded fonts have a number of benefits:

- Embedded font characters are anti-aliased, making their edges appear smoother, especially for larger text.
- You can rotate text that uses embedded fonts.
- Embedded font text can be made transparent or semitransparent.
- You can use the `kerning` CSS style with embedded fonts.

The biggest limitation to using embedded fonts is that they increase the file size or download size of your application.

The exact method of embedding a sound file into your application's SWF file varies according to your development environment.

Once you have embedded a font you can make sure a `TextField` uses the correct embedded font:

- Set the `embedFonts` property of the `TextField` to `true`.
- Create a `TextFormat` object, set its `fontFamily` property to the name of the embedded font, and apply the `TextFormat` object to the `TextField`. When specifying an embedded font, the `fontFamily` property should only contain a single name; it cannot use a comma-delimited list of multiple font names.
- If using CSS styles to set fonts for `TextFields` or components, set the `font-family` CSS property to the name of the embedded font. The `font-family` property must contain a single name and not a list of names if you want to specify an embedded font.

## Embedding a font in Flash

The Flash authoring tool lets you embed almost any font you have installed on your system, including TrueType fonts and Type 1 Postscript fonts.

There are many ways to embed fonts in a Flash application, including:

- Setting the font and style properties of a `TextField` on the Stage and clicking the Embed Fonts checkbox
- Creating and referencing a font symbol
- Creating and using a run-time shared library containing embedded font symbols

For more details about how to embed fonts in Flash applications, see [“Embedded fonts for dynamic or input text fields”](#) in *Using Flash*.

## Controlling sharpness, thickness, and anti-aliasing

By default, Flash Player determines the settings for text display controls like sharpness, thickness, and anti-aliasing as text resizes, changes color, or is displayed on various backgrounds. In some cases, like when you have very small or very large text, or text on a variety of unique backgrounds, you may want to maintain your own control over these settings. You can override the Flash Player settings using the `flash.text.TextRenderer` class and its associated classes, like the `CSMSettings` class. These classes give you precise control over the rendering quality of embedded text. For more information about embedded fonts, see [“Using embedded fonts” on page 525](#).

**NOTE**

The `flash.text.TextField.antiAliasType` property must have the value `AntiAliasType.ADVANCED` (which is the default value) in order for you to set the **sharpness, thickness, or the `gridFitType` property, or to use the `TextRenderer.setAdvancedAntiAliasingTable()` method.**

The following example applies custom continuous stroke modulation (CSM) properties and formatting to displayed text using an embedded font called `myFont`. When the user clicks on the displayed text, Flash Player applies the custom settings:

```
var format:TextFormat = new TextFormat();
format.color = 0x336699;
format.size = 48;
format.font = "myFont";

var myText:TextField = new TextField();
myText.embedFonts = true;
myText.autoSize = TextFieldAutoSize.LEFT;
myText.antiAliasType = AntiAliasType.ADVANCED;
myText.defaultTextFormat = format;
myText.selectable = false;
myText.mouseEnabled = true;
myText.text = "Hello World";
addChild(myText);
myText.addEventListener(MouseEvent.CLICK, clickHandler);

function clickHandler(event:Event):void
{
    var myAntiAliasSettings = new CSMSettings(48, 0.8, -0.8);
    var myAliasTable:Array = new Array(myAntiAliasSettings);
    TextRenderer.setAdvancedAntiAliasingTable("myFont", FontStyle.ITALIC,
    TextColorType.DARK_COLOR, myAliasTable);
}
```

# Working with static text

Static text is created only within the Flash authoring tool. You cannot programmatically instantiate static text using ActionScript. Static text is useful if the text is very short and is not intended to change (as dynamic text can). Think of static text as a sort of graphic element like a circle or square drawn on the Stage in the Flash authoring tool. While static text is more limited than dynamic text, ActionScript 3.0 does support the ability to read the property values of static text using the `flash.text.StaticText` class. In addition, you can use the `flash.text.TextSnapshot` class to read values out of the static text.

## Accessing static text fields with the `StaticText` class

Typically, you use the `flash.text.StaticText` class in the Actions panel of the Flash authoring tool to interact with a static text instance placed on the Stage. You may also work in ActionScript files that interact with a SWF file containing static text. In either case, you can't instantiate a static text instance programmatically. Static text is created in the Flash CS3 authoring tool.

To create a reference to an existing static text field in ActionScript 3.0, you can iterate over the items in the display list and assign a variable. For example:

```
for (var i = 0; i < this.numChildren; i++) {
    var displayitem:DisplayObject = this.getChildAt(i);
    if (displayitem instanceof StaticText) {
        trace("a static text field is item " + i + " on the display list");
        var myFieldLabel:StaticText = StaticText(displayitem);
        trace("and contains the text: " + myFieldLabel.text);
    }
}
```

Once you have a reference to a static text field, you can use the properties of that field in ActionScript 3.0. The following code is attached to a frame in the Timeline, and assumes a variable named `myFieldLabel` assigned to a static text reference. In the example, a dynamic text field named `myField` is positioned relative to the `x` and `y` values of `myFieldLabel` and displays the value of `myFieldLabel` again.

```
var myField:TextField = new TextField();
addChild(myField);
myField.x = myFieldLabel.x;
myField.y = myFieldLabel.y + 20;
myField.autoSize = TextFieldAutoSize.LEFT;
myField.text = "and " + myFieldLabel.text
```



## Using the TextSnapshot class

If you want to programmatically work with an existing static text instance, you can use the `flash.text.TextSnapshot` class to work with the `textSnapshot` property of a `flash.display.DisplayObjectContainer`. In other words, you create a `TextSnapshot` instance from the `DisplayObjectContainer.textSnapshot` property. You can then apply methods to that instance to retrieve values or select parts of the static text.

For example, place a static text field that contains the text "TextSnapshot Example" on the Stage. Add the following ActionScript to Frame 1 of the Timeline:

```
var mySnap:TextSnapshot = this.getTextSnapshot();
var count:Number = mySnap.getCount();
mySnap.setSelected(0, 4, true);
mySnap.setSelected(1, 2, false);
var myText:String = mySnap.getSelectedText(false);
trace(myText);
```

The `TextSnapshot` class is useful for getting the text out of static text fields in a loaded SWF, in case you want to use the text as a value in another part of an application.

## Example: Newspaper-style text formatting

The News Layout example formats text to look something like a story in a printed newspaper. The input text can contain a headline, a subtitle, and the body of the story. Given a display width and height, this News Layout example will format the headline and the subtitle to take the full width of the display area. The story text will be distributed across two or more columns.

This example illustrates the following ActionScript programming techniques:

- Extending the `TextField` class
- Loading and applying an external CSS file
- Converting CSS styles into `TextFormat` objects
- Using the `TextLineMetrics` class to get information about text display size

To get the application files for this sample, see [www.adobe.com/go/learn\\_programmingAS3samples\\_flash](http://www.adobe.com/go/learn_programmingAS3samples_flash). The News Layout application files can be found in the folder Samples/NewsLayout. The application consists of the following files:

File	Description
NewsLayout.mxml or NewsLayout fla	The user interface for the application for Flex (MXML) or Flash (FLA).
StoryLayout.as	The main ActionScript class that arranges all the components of a news story for display.
FormattedTextField.as	A subclass of the TextField class that manages its own TextFormat object.
HeadlineTextField.as	A subclass of the FormattedTextField class that adjusts font sizes to fit a desired width.
MultiColumnTextField.as	An ActionScript class that splits text across two or more columns.
story.css	A CSS file that defines text styles for the layout.
newsconfig.xml	An XML file containing story content.

## Reading the external CSS file

The News Layout application starts by reading story text from a local XML file. Then it reads an external CSS file that provides the formatting information for the headline, subtitle, and main text.

The CSS file defines three styles, a standard paragraph style for the story, and the h1 and h2 styles for the headline and subtitle respectively.

```
p {
    font-family: Georgia, Times New Roman, Times, _serif;
    font-size: 12;
    leading: 2;
    text-align: justify;
}

h1 {
    font-family: Verdana, Arial, Helvetica, _sans;
    font-size: 20;
    font-weight: bold;
    color: #000099;
    text-align: left;
}
```

```

h2 {
    font-family: Verdana, Arial, Helvetica, _sans;
    font-size: 16;
    font-weight: normal;
    text-align: left;
}

```

The technique used to read the external CSS file is that same as the technique described in [“Loading an external CSS file” on page 523](#). When the CSS file has been loaded the application executes the `onCSSFileLoaded()` method, shown below.

```

public function onCSSFileLoaded(event:Event):void
{
    this.sheet = new StyleSheet();
    this.sheet.parseCSS(loader.data);

    h1Format = getTextStyle("h1", this.sheet);
    if (h1Format == null)
    {
        h1Format = getDefaultHeadFormat();
    }
    h2Format = getTextStyle("h2", this.sheet);
    if (h2Format == null)
    {
        h2Format = getDefaultHeadFormat();
        h2Format.size = 16;
    }
    displayStory();
}

```

The `onCSSFileLoaded()` method creates a new `StyleSheet` object and has it parse the input CSS data. The main text for the story will be displayed in a `MultiColumnTextField` object, which can use a `StyleSheet` object directly. However, the headline fields use the `HeadlineTextField` class, which uses a `TextFormat` object for its formatting.

The `onCSSFileLoaded()` method calls the `getTextStyle()` method twice to convert a CSS style declaration into a `TextFormat` object for use with each of the two `HeadlineTextField` objects. The `getTextStyle()` method is shown below:

```

public function getTextStyle(styleName:String, ss:StyleSheet):TextFormat
{
    var format:TextFormat = null;

    var style:Object = ss.getStyle(styleName);
    if (style != null)
    {

```

```

var colorStr:String = style.color;
if (colorStr != null && colorStr.indexOf("#") == 0)
{
    style.color = colorStr.substr(1);
}
format = new TextFormat(style.fontFamily,
    style.fontSize,
    style.color,
    (style.fontWeight == "bold"),
    (style.fontStyle == "italic"),
    (style.textDecoration == "underline"),
    style.url,
    style.target,
    style.textAlign,
    style.marginLeft,
    style.marginRight,
    style.textIndent,
    style.leading);

    if (style.hasOwnProperty("letterSpacing"))
    {
        format.letterSpacing = style.letterSpacing;
    }
}
return format;
}

```

The property names and the meaning of the property values differ between CSS style declarations and TextFormat objects. The `getTextStyle()` method translates CSS property values into the values expected by the TextFormat object.

## Arranging story elements on the page

The StoryLayout class formats and lays out the headline, subtitle, and main text fields into a newspaper-style arrangement. The `displayText()` method initially creates and places the various fields.

```

public function displayText():void
{
    headlineTxt = new HeadlineTextField(h1Format);
    headlineTxt.wordWrap = true;
    this.addChild(headlineTxt);
    headlineTxt.width = 600;
    headlineTxt.height = 100;
    headlineTxt.fitText(this.headline, 1, true);
}

```

```

    subtitleTxt = new HeadlineTextField(h2Format);
    subtitleTxt.wordWrap = true;
    subtitleTxt.y = headlineTxt.y + headlineTxt.height;
    this.addChild(subtitleTxt);
    subtitleTxt.width = 600;
    subtitleTxt.height = 100;
    subtitleTxt.fitText(this.subtitle, 1, false);

    storyTxt = new MultiColumnTextField(2, 10, 600, 200);
    storyTxt.y = subtitleTxt.y + subtitleTxt.height + 4;
    this.addChild(storyTxt);
    storyTxt.styleSheet = this.sheet;
    storyTxt.htmlText = loremIpsum;
}

```

Each field is simply placed below the previous field by setting its `y` property equal to the `y` property of the previous field plus the height of the previous field. This dynamic placement calculation is needed because `HeadlineTextField` objects and `MultiColumnTextField` objects can change their height to fit their contents.

## Altering font size to fit the field size

Given a width in pixels and a maximum number of lines to display, the `HeadlineTextField` alters the font size to make the text fit the field. If the text is short the font size will be very large, creating a tabloid-style headline. If the text is long the font size will of course be smaller.

The `HeadlineTextField.fitText()` method shown below does the font sizing work:

```

public function fitText(msg:String, maxLines:uint = 1, toUpper:Boolean =
    false, targetWidth:Number = -1):uint
{
    this.text = toUpper ? msg.toUpperCase() : msg;

    if (targetWidth == -1)
    {
        targetWidth = this.width;
    }

    var pixelsPerChar:Number = targetWidth / msg.length;

    var pointSize:Number = Math.min(MAX_POINT_SIZE, Math.round(pixelsPerChar
        * 1.8 * maxLines));

    if (pointSize < 6)
    {

```

```

        // the point size is too small
        return pointSize;
    }

    this.changeSize(pointSize);

    if (this.numLines > maxLines)
    {
        return shrinkText(--pointSize, maxLines);
    }
    else
    {
        return growText(pointSize, maxLines);
    }
}

public function growText(pointSize:Number, maxLines:uint = 1):Number
{
    if (pointSize >= MAX_POINT_SIZE)
    {
        return pointSize;
    }

    this.changeSize(pointSize + 1);

    if (this.numLines > maxLines)
    {
        // set it back to the last size
        this.changeSize(pointSize);
        return pointSize;
    }
    else
    {
        return growText(pointSize + 1, maxLines);
    }
}

public function shrinkText(pointSize:Number, maxLines:uint=1):Number
{
    if (pointSize <= MIN_POINT_SIZE)
    {
        return pointSize;
    }
}

```

```

this.changeSize(pointSize);

if (this.numLines > maxLines)
{
    return shrinkText(pointSize - 1, maxLines);
}
else
{
    return pointSize;
}
}

```

The `HeadlineTextField.fitText()` method uses a simple recursive technique to size the font. First it guesses an average number of pixels per character in the text and from there calculates a starting point size. Then it changes the text field's font size and checks whether the text has word wrapped to create more than the maximum number of text lines. If there are too many lines it calls the `shrinkText()` method to decrease the font size and try again. If there are not too many lines it calls the `growText()` method to increase the font size and try again. The process stops at the point where incrementing the font size by one more point would create too many lines.

## Splitting text across multiple columns

The `MultiColumnTextField` class spreads text among multiple `TextField` objects which are then arranged like newspaper columns.

The `MultiColumnTextField()` constructor first creates an array of `TextField` objects, one for each column, as shown here:

```

for (var i:int = 0; i < cols; i++)
{
    var field:TextField = new TextField();
    field.autoSize = TextFieldAutoSize.NONE;
    field.wordWrap = true;
    field.styleSheet = this.styleSheet;

    this.fieldArray.push(field);
    this.addChild(field);
}

```

Each `TextField` object is added to the array and added to the display list with the `addChild()` method.

Whenever the `StoryLayout` object's `text` property or `styleSheet` property changes, it calls the `layoutColumns()` method to redisplay the text. The `layoutColumns()` method calls the `getOptimalHeight()` method, shown below, to figure out the correct pixel height needed to fit all of the text within the given layout width.

```

public function getOptimalHeight(str:String):int
{
  if (fieldArray.length == 0 || str == "" || str == null)
  {
    return this.preferredHeight;
  }
  else
  {
    var colWidth:int = Math.floor( (this.preferredWidth -
      ((this.numColumns - 1) * gutter)) / this.numColumns);

    var field:TextField = fieldArray[0] as TextField;
    field.width = colWidth;
    field.htmlText = str;

    var linesPerCol:int = Math.ceil(field.numLines / this.numColumns);
    var metrics:TextLineMetrics = field.getLineMetrics(0);
    var prefHeight:int = linesPerCol * metrics.height;
    return prefHeight + 4;
  }
}

```

First the `getOptimalHeight()` method calculates the width of each column. Then it sets the `width` and `htmlText` property of the first `TextField` object in the array. The `getOptimalHeight()` method uses that first `TextField` object to discover the total number of word-wrapped lines in the text, and from that it identifies how many lines should be in each column. Next it calls the `TextField.getLineMetrics()` method to retrieve a `TextLineMetrics` object that contains details about size of the text in the first line. The `TextLineMetrics.height` property represents the full height of a line of text, in pixels, including the ascent, descent, and leading. The optimal height for the `MultiColumnTextField` object is then the line height multiplied by the number of lines per column, plus 4 to account for the 2 pixel border at the top and the bottom of a `TextField` object.

Here is the code for the full `layoutColumns()` method:

```

public function layoutColumns():void
{
  if (this._text == "" || this._text == null)
  {
    return;
  }

  if (this.fitToText)
  {
    this.preferredHeight = this.getOptimalHeight(this._text);
  }

  var colWidth:int = Math.floor( (this.preferredWidth -
    ((numColumns - 1) * gutter)) / numColumns);

```



```

var field:TextField;
var remainder:String = this._text;
var fieldText:String = "";

for (var i:int = 0; i < fieldArray.length; i++)
{
    field = this.fieldArray[i] as TextField;
    field.width = colWidth;
    field.height = this.preferredHeight;

    field.x = i * (colWidth + gutter);
    field.y = 0;

    field.htmlText = "<p>" + remainder + "</p>";

    remainder = "";
    fieldText = "";

    var linesRemaining:int = field.numLines;
    var linesVisible:int = field.numLines - field.maxScrollV + 1;
    for (var j:int = 0; j < linesRemaining; j++)
    {
        if (j < linesVisible)
        {
            fieldText += field.getLineText(j);
        }
        else
        {
            remainder += field.getLineText(j);
        }
    }

    field.htmlText = "<p>" + fieldText + "</p>";
}
}

```

After the `preferredHeight` property has been set by calling the `getOptimalHeight()` method, the `layoutColumns()` method iterates through the `TextField` objects, setting the height of each to the `preferredHeight` value. The `layoutColumns()` method then distributes just enough lines of text to each field so that no scrolling occurs in any individual field, and the text in each successive field begins where the text in the previous field ended.



In addition to its vector drawing capabilities, ActionScript 3.0 includes the ability to create bitmap images or manipulate the pixel data of external bitmap images that are loaded into a SWF. With the ability to access and change individual pixel values, you can create your own filter-like image effects and use the built-in noise functions to create textures and random noise. All of these techniques are described in this chapter.

## Contents

Basics of working with bitmaps. . . . .	540
The Bitmap and BitmapData classes . . . . .	543
Manipulating pixels. . . . .	545
Copying bitmap data . . . . .	549
Making textures with noise functions. . . . .	550
Scrolling bitmaps . . . . .	552
Example: Animating sprites using an offscreen bitmap. . . . .	553

# Basics of working with bitmaps

## Introduction to working with bitmaps

When you work with digital images, you're likely to encounter two main types of graphics: bitmap and vector. Bitmap graphics, also known as raster graphics, are composed of tiny squares (pixels) that are arranged in a rectangular grid formation. Vector graphics are composed of mathematically generated geometric shapes such as lines, curves, and polygons.

Bitmap images are defined by the width and height of the image, measured in pixels, and the number of bits contained in each pixel, which represents the number of colors a pixel can contain. In the case of a bitmap image that utilizes the RGB color model, the pixels are made up of three bytes: red, green, and blue. Each of these bytes contains a value ranging from 0 to 255. When the bytes are combined within the pixel, they produce a color similar to an artist mixing paint colors. For example, a pixel containing byte values of red-255, green-102 and blue-0 would produce a vibrant orange color.

The quality of a bitmap image is determined by combining the resolution of the image with its color depth bit value. *Resolution* relates to the number of pixels contained within an image. The greater the number of pixels, the higher the resolution and the finer the image appears. *Color depth* relates to the amount of information a pixel can contain. For example, an image that has a color depth value of 16 bits per pixel cannot represent the same number of colors as an image that has a color depth of 48 bits. As a result, the 48-bit image will have smoother degrees of shading than its 16-bit counterpart.

Because bitmap graphics are resolution-dependent, they don't scale very well. This is most noticeable when bitmap images are scaled up in size. Scaling up a bitmap usually results in a loss of detail and quality.

## Bitmap file formats

Bitmap images are grouped into a number of common file formats. These formats use different types of compression algorithms to reduce file size, as well as optimize image quality based on the end purpose of the image. The bitmap image formats supported by Adobe Flash Player are GIF, JPG, and PNG.

## GIF

The Graphics Interchange Format (GIF) was originally developed by CompuServe in 1987 as a means to transmit images with 256 colors (8-bit color). The format provides small file sizes and is ideal for web-based images. Because of this format's limited color palette, GIF images are generally not suitable for photographs, which typically require high degrees of shading and color gradients. GIF images permit single-bit transparency, which allows colors to be mapped as clear (or transparent). This results in the background color of a web page showing through the image where the transparency has been mapped.

## JPEG

Developed by the Joint Photographic Experts Group (JPEG), the JPEG (often written JPG) image format uses a lossy compression algorithm to allow 24-bit color depth with a small file size. Lossy compression means that each time the image is saved, the image loses quality and data but results in a smaller file size. The JPEG format is ideal for photographs because it is capable of displaying millions of colors. The ability to control the degree of compression applied to an image allows you to manipulate image quality and file size.

## PNG

The Portable Network Graphics (PNG) format was produced as an open-source alternative to the patented GIF file format. PNGs support up to 64-bit color depth, allowing for up to 16 million colors. Because PNG is a relatively new format, some older browsers don't support PNG files. Unlike JPGs, PNGs use lossless compression, which means that none of the image data is lost when the image is saved. PNG files also support alpha transparency, which allows for up to 256 levels of transparency.

## Transparent bitmaps and opaque bitmaps

Bitmap images that use either the GIF or PNG formats can have an extra byte (alpha channel) added to each pixel. This extra pixel byte represents the transparency value of the pixel.

GIF images allow single-bit transparency, which means that you can specify a single color, from a 256-color palette, to be transparent. PNG images, on the other hand, can have up to 256 levels of transparency. This function is especially beneficial when images or text are required to blend into backgrounds.

ActionScript 3.0 replicates this extra transparency pixel byte within the `BitmapData` class. Similar to the PNG transparency model, the `BitmapDataChannel.ALPHA` constant offers up to 256 levels of transparency.

## Common tasks for working with bitmaps

The following list describes several tasks you may want to perform when working with bitmap images in ActionScript:

- Displaying bitmaps on the screen
- Retrieving and setting pixel color values
- Copying bitmap data:
  - Creating an exact copy of a bitmap
  - Copying data from one color channel of a bitmap into one color channel of another bitmap
  - Copying a snapshot of a screen display object into a bitmap
- Creating noise and textures in bitmap images
- Scrolling bitmaps

## Important concepts and terms

The following list contains important terms that you will encounter in this chapter:

- Alpha: The level of transparency (or more accurately, opacity) in a color or an image. The amount of alpha is often described as the *alpha channel* value.
- ARGB color: A color scheme where each pixel's color is a mixture of red, green, and blue color values, and its transparency is specified as an alpha value.
- Color channel: Commonly, colors are represented as a mixture of a few basic colors—usually (for computer graphics) red, green, and blue. Each basic color is considered a color channel; the amount of color in each color channel, mixed together, determines the final color.
- Color depth: Also known as *bit depth*, this refers to the amount of computer memory that is devoted to each pixel, which in turn determines the number of possible colors that can be represented in the image.
- Pixel: The smallest unit of information in a bitmap image—essentially a dot of color.
- Resolution: The pixel dimensions of an image, which determines the level of fine-grained detail contained in the image. Resolution is often expressed in terms of width and height in number of pixels.
- RGB color: A color scheme where each pixel's color is represented as a mixture of red, green, and blue color values.

## Working through in-chapter examples

While you're working through the chapter, you may want to test the example code. Because this chapter deals with creating and manipulating visual content, testing the code involves running the code and viewing the results in the SWF that's created.

To test the code examples in this chapter:

1. Create an empty Flash document.
2. Select a keyframe in the Timeline.
3. Open the Actions panel and copy the code into the Script pane.
4. Run the program using Control > Test Movie.

You see the results of the code in the SWF file that's created.

Nearly all the example code includes code that creates a bitmap image, so you can just test the code directly without needing to provide any bitmap content. Alternatively, if you want to test the code on your own image, you can import that image into Adobe Flash CS3 Professional or load the external image into the test SWF and use its bitmap data with the example code. For instructions on loading external images, see [“Loading display content dynamically” on page 418](#).

## The Bitmap and BitmapData classes

The main ActionScript 3.0 classes for working with bitmap images are the [Bitmap class](#), which is used to display bitmap images on the screen, and the [BitmapData class](#), which is used to access and manipulate the raw image data of a bitmap.

### Understanding the Bitmap class

As a subclass of the DisplayObject class, the Bitmap class is the main ActionScript 3.0 class used for displaying bitmap images. These images may have been loaded into Flash via the `flash.display.Loader` class or created dynamically using the `Bitmap()` constructor. When loading an image from an external source, a Bitmap object can only use GIF, JPEG, or PNG format images. Once instantiated, the Bitmap instance can be considered a wrapper for a BitmapData object that needs to be rendered to the Stage. Because a Bitmap instance is a display object, all the characteristics and functionality of display objects can be used to manipulate a Bitmap instance as well. For more information about working with display objects, see [Chapter 12, “Display programming,” on page 371](#).

## Pixel snapping and smoothing

In addition to the functionality common to all display objects, the `Bitmap` class provides some additional features that are specific to bitmap images.

Similar to the snap-to-pixel feature found in the Flash authoring tool, the `pixelSnapping` property of the `Bitmap` class determines whether or not a `Bitmap` object snaps to its nearest pixel. This property accepts one of three constants defined in the `PixelSnapping` class: `ALWAYS`, `AUTO`, and `NEVER`.

The syntax for applying pixel snapping is as follows:

```
myBitmap.pixelSnapping = PixelSnapping.ALWAYS;
```

Often, when bitmap images are scaled, they become blurred and distorted. To help reduce this distortion, use the `smoothing` property of the `BitmapData` class. This Boolean property, when set to `true`, smooths, or anti-aliases, the pixels within the image when it is scaled. This gives the image a clearer and more natural appearance.

## Understanding the `BitmapData` class

The `BitmapData` class, which is in the `flash.display` package, can be likened to a photographic snapshot of the pixels contained within a loaded or dynamically created bitmap image. This snapshot is represented by an array of pixel data within the object. The `BitmapData` class also contains a series of built-in methods that are useful for creation and manipulation of pixel data.

To instantiate a `BitmapData` object, use the following code:

```
var myBitmap:BitmapData = new BitmapData(width:Number, height:Number,  
    transparent:Boolean, fillColor:uint);
```

The `width` and `height` parameters specify the size of the bitmap; the maximum value of both is 2880 pixels. The `transparent` parameter specifies whether the bitmap data includes an alpha channel (`true`) or not (`false`). The `fillColor` parameter is a 32-bit color value that specifies the background color, as well as the transparency value (if it has been set to `true`). The following example creates a `BitmapData` object with an orange background that is 50 percent transparent:

```
var myBitmap:BitmapData = new BitmapData(150, 150, true, 0x80FF3300);
```



To render a newly created `BitmapData` object to the screen, assign it to or wrap it in a `Bitmap` instance. To do this, you can either pass the `BitmapData` object as a parameter of the `Bitmap` object's constructor, or you can assign it to the `bitmapData` property of an existing `Bitmap` instance. You must also add the `Bitmap` instance to the display list by calling the `addChild()` or `addChildAt()` methods of the display object container that will contain the `Bitmap` instance. For more information on working with the display list, see [“Adding display objects to the display list” on page 383](#).

The following example creates a `BitmapData` object with a red fill, and displays it in a `Bitmap` instance:

```
var myBitmapDataObject:BitmapData = new BitmapData(150, 150, false,
    0xFF0000);
var myImage:Bitmap = new Bitmap(myBitmapDataObject);
addChild(myImage);
```

## Manipulating pixels

The `BitmapData` class contains a set of methods that allow you to manipulate pixel data values.

### Manipulating individual pixels

When changing the appearance of a bitmap image at a pixel level, you first need to get the color values of the pixels contained within the area you wish to manipulate. You use the `getPixel()` method to read these pixel values.

The `getPixel()` method retrieves an RGB value from a set of `x`, `y` (pixel) coordinates that are passed as a parameter. If any of the pixels that you want to manipulate include transparency (alpha channel) information, you need to use the `getPixel32()` method. This method also retrieves an RGB value, but unlike with `getPixel()`, the value returned by `getPixel32()` contains additional data that represents the alpha channel (transparency) value of the selected pixel.

Alternatively, if you simply want to change the color or transparency of a pixel contained within a bitmap, you can use the `setPixel()` or `setPixel32()` method. To set a pixel's color, simply pass in the `x`, `y` coordinates and the color value to one of these methods.

The following example uses `setPixel()` to draw a cross on a green `BitmapData` background. It then uses `getPixel()` to retrieve the color value from the pixel at the coordinate 50, 50 and traces the returned value.

```

import flash.display.Bitmap;
import flash.display.BitmapData;

var myBitmapData:BitmapData = new BitmapData(100, 100, false, 0x009900);

for (var i:uint = 0; i < 100; i++)
{
    var red:uint = 0xFF0000;
    myBitmapData.setPixel(50, i, red);
    myBitmapData.setPixel(i, 50, red);
}

var myBitmapImage:Bitmap = new Bitmap(myBitmapData);
addChild(myBitmapImage);

var pixelValue:uint = myBitmapData.getPixel(50, 50);
trace(pixelValue.toString(16));

```

If you want to read the value of a group of pixels, as opposed to a single pixel, use the `getPixels()` method. This method generates a byte array from a rectangular region of pixel data that is passed as a parameter. Each of the elements of the byte array (in other words, the pixel values) are unsigned integers—32-bit, unmultiplied pixel values.

Conversely, in order to change (or set) the value of a group of pixels, use the `setPixels()` method. This method expects two parameters (`rect` and `inputByteArray`), which are combined to output a rectangular region (`rect`) of pixel data (`inputByteArray`).

As data is read (and written) out of the `inputByteArray`, the `ByteArray.readUnsignedInt()` method is called for each of the pixels in the array. If, for some reason, the `inputByteArray` doesn't contain a full rectangle worth of pixel data, the method stops processing the image data at that point.

It's important to remember that, for both getting and setting pixel data, the byte array expects 32-bit alpha, red, green, blue (ARGB) pixel values.

The following example uses the `getPixels()` and `setPixels()` methods to copy a group of pixels from one `BitmapData` object to another:

```

import flash.display.Bitmap;
import flash.display.BitmapData;
import flash.utils.ByteArray;
import flash.geom.Rectangle;

var bitmapDataObject1:BitmapData = new BitmapData(100, 100, false,
    0x006666FF);
var bitmapDataObject2:BitmapData = new BitmapData(100, 100, false,
    0x00FF0000);

var rect:Rectangle = new Rectangle(0, 0, 100, 100);
var bytes:ByteArray = bitmapDataObject1.getPixels(rect);

```

```
bytes.position = 0;
bitmapDataObject2.setPixels(rect, bytes);

var bitmapImage1:Bitmap = new Bitmap(bitmapDataObject1);
addChild(bitmapImage1);
var bitmapImage2:Bitmap = new Bitmap(bitmapDataObject2);
addChild(bitmapImage2);
bitmapImage2.x = 110;
```

## Pixel-level collision detection

The `BitmapData.hitTest()` method performs pixel-level collision detection between the bitmap data and another object or point.

The `BitmapData.hitTest()` method accepts five parameters:

- `firstPoint (Point)`: This parameter refers to the pixel position of the upper-left corner of the first `BitmapData` upon which the hit test is being performed.
- `firstAlphaThreshold (uint)`: This parameter specifies the highest alpha channel value that is considered opaque for this hit test.
- `secondObject (Object)`: This parameter represents the area of impact. The `secondObject` object can be a `Rectangle`, `Point`, `Bitmap`, or `BitmapData` object. This object represents the hit area on which the collision detection is being performed.
- `secondBitmapDataPoint (Point)`: This optional parameter is used to define a pixel location in the second `BitmapData` object. This parameter is used only when the value of `secondObject` is a `BitmapData` object. The default is `null`.
- `secondAlphaThreshold (uint)`: This optional parameter represents the highest alpha channel value that is considered opaque in the second `BitmapData` object. The default value is 1. This parameter is only used when the value of `secondObject` is a `BitmapData` object and both `BitmapData` objects are transparent.

When performing collision detection on opaque images, keep in mind that `ActionScript` treats the image as though it were a fully opaque rectangle (or bounding box). Alternatively, when performing pixel-level hit testing on images that are transparent, both of the images are required to be transparent. In addition to this, `ActionScript` uses the alpha threshold parameters to determine at what point the pixels change from being transparent to opaque.

The following example creates three bitmap images and checks for pixel collision using two different collision points (one returns false, the other true):

```
import flash.display.Bitmap;
import flash.display.BitmapData;
import flash.geom.Point;

var bmd1:BitmapData = new BitmapData(100, 100, false, 0x000000FF);
var bmd2:BitmapData = new BitmapData(20, 20, false, 0x00FF3300);

var bml:Bitmap = new Bitmap(bmd1);
this.addChild(bml);

// Create a red square.
var redSquare1:Bitmap = new Bitmap(bmd2);
this.addChild(redSquare1);
redSquare1.x = 0;

// Create a second red square.
var redSquare2:Bitmap = new Bitmap(bmd2);
this.addChild(redSquare2);
redSquare2.x = 150;
redSquare2.y = 150;

// Define the point at the top-left corner of the bitmap.
var pt1:Point = new Point(0, 0);
// Define the point at the center of redSquare1.
var pt2:Point = new Point(20, 20);
// Define the point at the center of redSquare2.
var pt3:Point = new Point(160, 160);

trace(bmd1.hitTest(pt1, 0xFF, pt2)); // true
trace(bmd1.hitTest(pt1, 0xFF, pt3)); // false
```

# Copying bitmap data

To copy bitmap data from one image to another, you can use several methods: `clone()`, `copyPixels()`, `copyChannel()`, and `draw()`.

As its name suggests, the `clone()` method lets you clone, or sample, bitmap data from one `BitmapData` object to another. When called, the method returns a new `BitmapData` object that is an exact clone of the original instance it was copied from.

The following example clones a copy of an orange (parent) square and places the clone beside the original parent square:

```
import flash.display.Bitmap;
import flash.display.BitmapData;

var myParentSquareBitmap:BitmapData = new BitmapData(100, 100, false,
    0x00ff3300);
var myClonedChild:BitmapData = myParentSquareBitmap.clone();

var myParentSquareContainer:Bitmap = new Bitmap(myParentSquareBitmap);
this.addChild(myParentSquareContainer);

var myClonedChildContainer:Bitmap = new Bitmap(myClonedChild);
this.addChild(myClonedChildContainer);
myClonedChildContainer.x = 110;
```

The `copyPixels()` method is a quick and easy way of copying pixels from one `BitmapData` object to another. The method takes a rectangular snapshot (defined by the `sourceRect` parameter) of the source image and copies it to another rectangular area (of equal size). The location of the newly “pasted” rectangle is defined within the `destPoint` parameter.

The `copyChannel()` method samples a predefined color channel value (alpha, red, green, or blue) from a source `BitmapData` object and copies it into a channel of a destination `BitmapData` object. Calling this method does not affect the other channels in the destination `BitmapData` object.

The `draw()` method draws, or renders, the graphical content from a source sprite, movie clip, or other display object on to a new bitmap. Using the `matrix`, `colorTransform`, `blendMode`, and destination `clipRect` parameters, you can modify the way in which the new bitmap is rendered. This method uses the Flash Player vector renderer to generate the data.

When you call `draw()`, you pass the source object (sprite, movie clip, or other display object) as the first parameter, as demonstrated here:

```
myBitmap.draw(movieClip);
```

If the source object has had any transformations (color, matrix, and so forth) applied to it after it was originally loaded, these transformations are not copied across to the new object. If you want to copy the transformations to the new bitmap, then you need to copy the value of the `transform` property from the original object to the `transform` property of the Bitmap object that uses the new BitmapData object.

## Making textures with noise functions

To modify the appearance of a bitmap, you can apply a noise effect to it, using either the `noise()` method or the `perlinNoise()` methods. A noise effect can be likened to the static that appears on an untuned television screen.

To apply a noise effect to a bitmap, use the `noise()` method. This method applies a random color value to pixels within a specified area of a bitmap image.

This method accepts five parameters:

- `randomSeed (int)`: The random seed number that determines the pattern. Despite its name, this number actually creates the same results if the same number is passed. In order to get a true random result, use the `Math.random()` method to pass a random number for this parameter.
- `low (uint)`: This parameter refers to the lowest value to be generated for each pixel (0 to 255). The default value is 0. Setting this value lower results in a darker noise pattern, while setting it to a higher value results in a brighter pattern.
- `high (uint)`: This parameter refers to the highest value to be generated for each pixel (0 to 255). The default value is 255. Setting this value lower results in a darker noise pattern, while setting it to a higher value results in a brighter pattern.
- `channelOptions (uint)`: This parameter specifies to which color channel of the bitmap object the noise pattern will be applied. The number can be a combination of any of the four color channel ARGB values. The default value is 7.
- `grayScale (Boolean)`: When set to `true`, this parameter applies the `randomSeed` value to the bitmap pixels, effectively washing all color out of the image. The alpha channel is not affected by this parameter. The default value is `false`.

The following example creates a bitmap image and applies a blue noise pattern to it:

```
import flash.display.Bitmap;
import flash.display.BitmapData;

var myBitmap:BitmapData = new BitmapData(250, 250,false, 0xff000000);
myBitmap.noise(500, 0, 255, BitmapDataChannel.BLUE,false);
var image:Bitmap = new Bitmap(myBitmap);
addChild(image);
```

If you want to create a more organic-looking texture, use the `perlinNoise()` method. The `perlinNoise()` method produces realistic, organic textures that are ideal for smoke, clouds, water, fire, or even explosions.

Because it is generated by an algorithm, the `perlinNoise()` method uses less memory than bitmap-based textures. However, it can still have an impact on processor usage, slowing down your Flash content and causing the screen to be redrawn more slowly than the frame rate, especially on older computers. This is mainly due to the floating-point calculations that need to occur in order to process the perlin noise algorithms.

The method accepts nine parameters (the first six are required):

- `baseX` (Number): Determines the x (size) value of patterns created.
- `baseY` (Number): Determines the y (size) value of the patterns created.
- `numOctaves` (uint): Number of octaves or individual noise functions to combine to create this noise. Larger numbers of octaves create images with greater detail but also require more processing time.
- `randomSeed` (int): The random seed number works exactly the same way as it does in the `noise()` function. To get a true random result, use the `Math.random()` method to pass a random number for this parameter.
- `stitch` (Boolean): If set to `true`, this method attempts to stitch (or smooth) the transition edges of the image to create seamless textures for tiling as a bitmap fill.
- `fractalNoise` (Boolean): This parameter relates to the edges of the gradients being generated by the method. If set to `true`, the method generates fractal noise that smooths the edges of the effect. If set to `false`, it generates turbulence. An image with turbulence has visible discontinuities in the gradient that can make it better approximate sharper visual effects, like flames and ocean waves.
- `channelOptions` (uint): The `channelOptions` parameter works exactly the same way as it does in the `noise()` method. It specifies to which color channel (of the bitmap) the noise pattern is applied. The number can be a combination of any of the four color channel ARGB values. The default value is 7.

- `grayScale` (Boolean): The `grayScale` parameter works exactly the same way as it does in the `noise()` method. If set to `true`, it applies the `randomSeed` value to the bitmap pixels, effectively washing all color out of the image. The default value is `false`.
- `offsets` (Array): An array of points that correspond to `x` and `y` offsets for each octave. By manipulating the offset values, you can smoothly scroll the layers of the image. Each point in the offset array affects a specific octave noise function. The default value is `null`.

The following example creates a 150 x 150 pixel `BitmapData` object that calls the `perlinNoise()` method to generate a green and blue cloud effect:

```
import flash.display.Bitmap;
import flash.display.BitmapData;

var myBitmapDataObject:BitmapData = new BitmapData(150, 150, false,
    0x00FF0000);

var seed:Number = Math.floor(Math.random() * 100);
var channels:uint = BitmapDataChannel.GREEN | BitmapDataChannel.BLUE
myBitmapDataObject.perlinNoise(100, 80, 6, seed, false, true, channels,
    false, null);

var myBitmap:Bitmap = new Bitmap(myBitmapDataObject);
addChild(myBitmap);
```

## Scrolling bitmaps

Imagine you have created a street mapping application where each time the user moves the map you are required to update the view (even if the map has been moved by just a few pixels).

One way to create this functionality would be to re-render a new image containing the updated map view each time the user moves the map. Alternatively, you could create a large single image and the `scroll()` method.

The `scroll()` method copies an on-screen bitmap and then pastes it to a new offset location—specified by `(x, y)` parameters. If a portion of the bitmap happens to reside off-stage, this gives the effect that the image has shifted. When combined with a timer function (or an `enterFrame` event), you can make the image appear to be animating or scrolling.



The following example takes the previous perlin noise example and generates a larger bitmap image (three-fourths of which is rendered off-stage). The `scroll()` method is then applied, along with an `enterFrame` event listener that offsets the image by one pixel in a diagonally downward direction. This method is called each time the frame is entered and as a result, the offscreen portions of the image are rendered to the Stage as the image scrolls down.

```
import flash.display.Bitmap;
import flash.display.BitmapData;

var myBitmapDataObject:BitmapData = new BitmapData(1000, 1000, false,
    0x00FF0000);
var seed:Number = Math.floor(Math.random() * 100);
var channels:uint = BitmapDataChannel.GREEN | BitmapDataChannel.BLUE;
myBitmapDataObject.perlinNoise(100, 80, 6, seed, false, true, channels,
    false, null);

var myBitmap:Bitmap = new Bitmap(myBitmapDataObject);
myBitmap.x = -750;
myBitmap.y = -750;
addChild(myBitmap);

addEventListener(Event.ENTER_FRAME, scrollBitmap);

function scrollBitmap(event:Event):void
{
    myBitmapDataObject.scroll(1, 1);
}
```

## Example: Animating sprites using an offscreen bitmap

Many Flash games involve hundreds of images animating on the screen at once. This bitmap animation example draws several hundred small bitmaps or sprites on to a big offscreen bitmap, then writes that one bitmap to the screen, which greatly speeds up the animation. For a description of this example and to download the source code, go to [www.adobe.com/go/learn\\_fl\\_bitmaps](http://www.adobe.com/go/learn_fl_bitmaps).



Flash video is one of the standout technologies on the Internet. However, the traditional presentation of video—in a rectangular screen with a progress bar and some control buttons underneath—is only one possible use of video in a Flash application. Through ActionScript, you have fine-tuned access to and control over video loading, presentation, and playback.

## Contents

Basics of video .....	556
Understanding the Flash Video (FLV) format .....	559
Understanding the Video class .....	560
Loading video files .....	561
Controlling video playback .....	562
Streaming video files .....	564
Understanding cue points .....	565
Writing callback methods for onCuePoint and onMetaData .....	566
Using cue points .....	572
Using video metadata .....	573
Capturing camera input .....	577
Advanced topics .....	585
Example: Video Jukebox .....	587

# Basics of video

## Introduction to working with video

One important capability of Adobe Flash Player is the ability to display and manipulate video information with ActionScript in the same way that you can manipulate other visual content such as images, animation, text, and so on.

When you create a Flash Video (FLV) file in Adobe Flash CS3 Professional, you have the option to select a skin for your video including common playback controls. However, there is no reason you need to limit yourself to the options available. Using ActionScript, you have fine-tuned control over loading, displaying, and controlling playback of video—meaning you could create your own video player skin, or use your video in any less traditional way that you want.

Working with video in ActionScript involves working with a combination of several classes:

- **Video class:** The actual video content box on the Stage is an instance of the Video class. The Video class is a display object, so it can be manipulated using the same techniques that can be applied to other display objects, such as positioning, applying transformations, applying filters and blending modes, and so forth.
- **NetStream class:** When you're loading a video file to be controlled by ActionScript, a NetStream instance is used to represent the source of the video content—in this case, a stream of video data. Using a NetStream instance also involves using a NetConnection object, which is the connection to the video file—like the tunnel that the video data is fed through.
- **Camera class:** When you're working with video data from a camera connected to the user's computer, a Camera instance represents the source of the video content—the user's camera and the video data it makes available.

When you're loading external video, you can load the file from a standard web server for progressive download playback, or you can work with streaming video delivered by a specialized server such as Adobe's Macromedia® Flash® Media Server.

## Common video tasks

This chapter describes the following video-related tasks that you will likely want to perform:

- Displaying and controlling video on the screen
- Loading external FLV files
- Handling metadata and cue point information in a video file
- Capturing and displaying video input from a user's camera

## Important concepts and terms

- **Cue point:** A marker that can be placed at a specific moment in time in a video file, for example to act like a bookmark for locating that point in time, or to provide additional data that is associated with that moment in time.
- **Encoding:** The process of taking video data in one format and converting it to another video data format; for example, taking a high resolution source video and converting it to a format that's suitable for Internet delivery.
- **Frame:** A single segment of video information; each frame is like a still image representing a snapshot of a moment in time. By playing frames in sequence at high speed, the illusion of motion is created.
- **Keyframe:** A video frame which contains the full information for the frame. Other frames that follow a keyframe only contain information about how they differ from the keyframe, rather than containing the full frame's worth of information.
- **Metadata:** Information about a video file that can be embedded within the video file and retrieved when the video has loaded.
- **Progressive download:** When a video file is delivered from a standard web server, the video data is loaded using progressive download, meaning the video information loads in sequence. This has the benefit that the video can begin playing before the entire file is downloaded; however, it prevents you from jumping ahead to a part of the video that hasn't loaded.
- **Streaming:** As an alternative to progressive download, a special video server can be used to deliver video over the Internet using a technique known as streaming (sometimes called "true streaming"). With streaming, the viewer's computer never downloads the entire video at one time. To speed up download times, at any moment the computer only needs a portion of the total video information. Because a special server controls the delivery of the video content, any part of the video can be accessed at any time, rather than needing to wait for it to download before accessing it.

## Working through in-chapter examples

As you're working through the chapter, you may want to test some of the example code listings for yourself. Because this chapter is about working with video in ActionScript, many of the code listings in this chapter involve working with a video object, which could be one that has been created and placed on the Stage in Flash authoring, or one that's created using ActionScript. Testing a sample will involve viewing the result in Flash Player to see the effects of the code on the video.

Most of the example code listings manipulate a Video object without creating the object explicitly. To test these code listings in this chapter:

1. Create an empty Flash document.
2. Select a keyframe in the Timeline.
3. Open the Actions panel and copy the code listing into the Script pane.
4. If necessary, open the Library panel.
5. From the Library panel menu, choose New Video.
6. In the Video Properties dialog box, enter a name for the new video symbol, and choose Video (ActionScript-controlled) in the Type field. Click OK to create the Video symbol.
7. Drag an instance of your video symbol from the Library panel onto the Stage.
8. With the video instance selected, in the Property inspector, give it an instance name. The name should match the name used for the Video instance in the example code listing—for example, if the code listing manipulates a Video object named `vid`, you should name your Stage instance `vid` as well.
9. Run the program using Control > Test Movie.

On the screen you will see the results of the code manipulating the video as specified in the code listing.

Some example code listings in this chapter include a class definition in addition to the example code. In those listings, in addition to the previous steps, and before testing the SWF, you will need to create the class that's used in the example. To create a class defined in an example code listing:

1. Make sure you have saved the FLA file that will be used for testing.
2. From the main menu choose File > New.
3. In the New Document dialog, in the Type section, choose ActionScript File. Click OK to create the new ActionScript file.
4. Copy the class definition code from the example into the ActionScript document.

5. From the main menu, choose File > Save. Save the file in the same directory as the Flash document. The file's name should match the name of the class in the code listing. For instance, if the code listing defines a class named "VideoTest," save the ActionScript file as "VideoTest.as".
6. Return to the Flash document.
7. Run the program using Control > Test Movie.

You will see the results of the example displayed on the screen.

Other techniques for testing example code listings are explained in more detail in ["Testing in-chapter example code listings"](#) on page 63.

## Understanding the Flash Video (FLV) format

The FLV file format contains encoded audio and video data for delivery by using Flash Player. For example, if you have a QuickTime or Windows Media video file, you use an encoder (such as Flash Video Encoder, or Sorenson™ Squeeze) to convert that file to an FLV file.

You can create FLV files by importing video into the Flash authoring tool and exporting it as an FLV file. You can use the FLV Export plug-in to export FLV files from supported video-editing applications.

Using external FLV files provides certain capabilities that are not available when you use imported video:

- Longer video clips can be used in your Flash documents without slowing down playback. External FLV files play using cached memory, which means that large files are stored in small pieces and accessed dynamically, requiring less memory than embedded video files.
- An external FLV file can have a different frame rate than the Flash document in which it plays. For example, you can set the Flash document frame rate to 30 frames per second (fps) and the video frame rate to 21 fps. This setting gives you better control of the video than embedded video, to ensure smooth video playback. It also allows you to play FLV files at different frame rates without the need to alter existing Flash content.

- With external FLV files, Flash document playback does not have to be interrupted while the video file is loading. Imported video files can sometimes interrupt document playback to perform certain functions, such as accessing a CD-ROM drive. FLV files can perform functions independently of the Flash document, which does not interrupt playback.
- Captioning video content is easier with external FLV files because you can access the video's metadata using event handlers.

TIP

To load FLV files from a web server, you might need to register the file extension and MIME type with your web server; check your web server documentation. The MIME type for FLV files is `video/x-flv`. For more information, see [“About configuring FLV files for hosting on a server” on page 585](#).

## Understanding the Video class

The Video class enables you to display live streaming video in an application without embedding it in your SWF file. You can capture and play live video using the `Camera.getCamera()` method. You can also use the Video class to play back FLV files over HTTP or from the local file system. There are several different ways to use Video in your projects:

- Load an FLV dynamically using the NetConnection and NetStream classes and display the video in a Video object.
- Capture input from the user's camera.
- Use the FLVPlayback component.

NOTE

Instances of a Video object on the Stage are instances of the Video class.

Even though the Video class is in the `flash.media` package, it inherits from the `flash.display.DisplayObject` class, therefore all display object functionality (such as matrix transformations and filters) also applies to Video instances.

For more information see [“Manipulating display objects” on page 395](#), [“Working with geometry” on page 431](#), and [“Filtering display objects” on page 465](#).



# Loading video files

Loading videos using the `NetStream` and `NetConnection` classes is a multistep process:

1. The first step is to create a `NetConnection` object. The `NetConnection` class lets you play streaming FLV files from either an HTTP address or a local drive by passing the value `null` to the `connect()` method, if you are connecting to a local FLV file that is not using a server such as Adobe's Flash Media Server 2 or Adobe Flex.

```
var nc:NetConnection = new NetConnection();
nc.connect(null);
```

2. The second step is to create a `NetStream` object which takes a `NetConnection` object as a parameter and specify which FLV file you want to load. The following snippet connects a `NetStream` object to the specified `NetConnection` instance and loads an FLV named `video.flv` in the same directory as the SWF file:

```
var ns:NetStream = new NetStream(nc);
ns.addEventListener(AsyncErrorEvent.ASYNC_ERROR, asyncErrorHandler);
ns.play("video.flv");
function asyncErrorHandler(event:AsyncErrorEvent):void
{
    // ignore error
}
```

3. The third step is to create a new `Video` object and attach the previously created `NetStream` object using the `Video` class's `attachNetStream()` method. Then you can add the video object to the display list using the `addChild()` method, as seen in the following snippet:

```
var vid:Video = new Video();
vid.attachNetStream(ns);
addChild(vid);
```

After entering the previous code, Flash Player will attempt to load the `video.flv` video file in the same directory as your SWF file.

TIP

To load FLV files from a web server, you might need to register the file extension and MIME type with your web server; check your web server documentation. The MIME type for FLV files is `video/x-flv`. For more information, see [“About configuring FLV files for hosting on a server” on page 585](#).

# Controlling video playback

The `NetStream` class offers four main methods for controlling video playback:

`pause()`: Pauses playback of a video stream. If the video is already paused, calling this method does nothing.

`resume()`: Resumes playback of a video stream that is paused. If the video is already playing, calling this method does nothing.

`seek()`: Seeks the keyframe closest to the specified location (an offset, in seconds, from the beginning of the stream).

`togglePause()`: Pauses or resumes playback of a stream.

NOTE

There is no `stop()` method. In order to stop a stream you must pause playback and seek to the beginning of the video stream.

NOTE

The `play()` method does not resume playback, it is used for loading video files.

The following example demonstrates how to control a video using several different buttons. To run the following example, create a new document and add four button instances to your workspace (`pauseBtn`, `playBtn`, `stopBtn`, and `togglePauseBtn`):

```
var nc:NetConnection = new NetConnection();
nc.connect(null);

var ns:NetStream = new NetStream(nc);
ns.addEventListener(AsyncErrorEvent.ASYNC_ERROR, asyncErrorHandler);
ns.play("video.flv");
function asyncErrorHandler(event:AsyncErrorEvent):void
{
    // ignore error
}

var vid:Video = new Video();
vid.attachNetStream(ns);
addChild(vid);

pauseBtn.addEventListener(MouseEvent.CLICK, pauseHandler);
playBtn.addEventListener(MouseEvent.CLICK, playHandler);
stopBtn.addEventListener(MouseEvent.CLICK, stopHandler);
togglePauseBtn.addEventListener(MouseEvent.CLICK, togglePauseHandler);

function pauseHandler(event:MouseEvent):void
{
    ns.pause();
}
```

```

function playHandler(event:MouseEvent):void
{
    ns.resume();
}
function stopHandler(event:MouseEvent):void
{
    // Pause the stream and move the playhead back to
    // the beginning of the stream.
    ns.pause();
    ns.seek(0);
}
function togglePauseHandler(event:MouseEvent):void
{
    ns.togglePause();
}

```

Clicking on the `pauseBtn` button instance while the video is playing causes the video file to pause. If the video is already paused, clicking this button has no effect. Clicking on the `playBtn` button instance resumes video playback if playback was previously paused, otherwise the button has no effect if the video was already playing.

## Detecting the end of a video stream

In order to listen for the beginning and end of a video stream, you need to add an event listener to the `NetStream` instance to listen for the `netStatus` event. The following code demonstrates how to listen for the various codes throughout the video's playback:

```

ns.addEventListener(NetStatusEvent.NET_STATUS, statusHandler);
function statusHandler(event:NetStatusEvent):void
{
    trace(event.info.code)
}

```

The previous code generates the following output:

```

NetStream.Play.Start
NetStream.Buffer.Empty
NetStream.Buffer.Full
NetStream.Buffer.Empty
NetStream.Buffer.Full
NetStream.Buffer.Empty
NetStream.Buffer.Full
NetStream.Buffer.Flush
NetStream.Play.Stop
NetStream.Buffer.Empty
NetStream.Buffer.Flush

```

The two codes that you want to specifically listen for are “NetStream.Play.Start” and “NetStream.Play.Stop” which signal the beginning and end of the video’s playback. The following snippet uses a switch statement to filter these two codes and trace a message:

```
function statusHandler(event:NetStatusEvent):void
{
    switch (event.info.code)
    {
        case "NetStream.Play.Start":
            trace("Start [" + ns.time.toFixed(3) + " seconds");
            break;
        case "NetStream.Play.Stop":
            trace("Stop [" + ns.time.toFixed(3) + " seconds");
            break;
    }
}
```

By listening for the `netStatus` event (`NetStatusEvent.NET_STATUS`), you can build a video player which loads the next video in a playlist once the current video has finished playing.

## Streaming video files

To stream files from Flash Media Server, you can use the `NetConnection` and `NetStream` classes to connect to a remote server instance and play a specified stream. To specify a Real-Time Messaging Protocol (RTMP) server, you pass the desired RTMP URL, such as “`rtmp://localhost/appName/appInstance`”, to the `NetConnection.connect()` method instead of passing `null`. To play a specific live or recorded stream from the specified Flash Media Server, you pass an identifying name for live data published by `NetStream.publish()`, or a recorded filename for playback to the `NetStream.play()` method. For more information, see the Flash Media Server documentation.

# Understanding cue points

Not all FLV files contain cue points. Cue points are typically embedded in an FLV file during FLV encoding, although tools exist for embedding cue points in existing FLV files.

You can use several different kinds of cue points with Flash Video. You can use ActionScript to interact with cue points that you embed in an FLV file (when you create the FLV file), or that you create by using ActionScript.

- **Navigation cue points:** You embed navigation cue points in the FLV stream and FLV metadata packet when you encode the FLV file. You use navigation cue points to let users seek to a specified part of a file.
- **Event cue points:** You embed event cue points in the FLV stream and FLV metadata packet when you encode the FLV file. You can write code to handle the events that are triggered at specified points during FLV playback.
- **ActionScript cue points:** External cue points that you create by using ActionScript code. You can write code to trigger these cue points in relation to the video's playback. These cue points are less accurate than embedded cue points (up to a tenth of a second), because the video player tracks them separately.

Navigation cue points create a keyframe at the specified cue point location, so you can use code to move a video player's playback head to that location. You can set particular points in an FLV file where you might want users to seek. For example, your video might have multiple chapters or segments, and you can control the video by embedding navigation cue points in the video file.

If you plan to create an application in which you want users to navigate to a cue point, you should create and embed cue points when you encode the file instead of using ActionScript cue points. You should embed the cue points in the FLV file, because they are more accurate to work with. For more information on encoding FLV files with cue points, see [“Embed cue points” in \*Using Flash\*](#).

You can access cue point parameters by writing ActionScript. Cue point parameters are a part of the event object received from the `onCuePoint` callback handler.

To trigger certain actions in your code when a video reaches a specific cue point, you use the `NetStream.onCuePoint` event handler. For more information, see [“Writing callback methods for `onCuePoint` and `onMetaData`” on page 566](#).

# Writing callback methods for onCuePoint and onMetaData

You can trigger actions in your application when specific cue points are reached or specific metadata is received by the player. To trigger such actions, you use the `onCuePoint` and `onMetaData` event handlers. You must write callback methods for these handlers, or Flash Player may throw errors. For example, the following code plays an FLV file named `video.flv` in the same folder as your SWF document:

```
var nc:NetConnection = new NetConnection();
nc.connect(null);

var ns:NetStream = new NetStream(nc);
ns.addEventListener(AsyncErrorEvent.ASYNC_ERROR, asyncErrorHandler);
ns.play("video.flv");
function asyncErrorHandler(event:AsyncErrorEvent):void
{
    trace(event.text);
}

var vid:Video = new Video();
vid.attachNetStream(ns);
addChild(vid);
```

The previous code loads a local FLV file named `video.flv` and listens for the `asyncError` (`AsyncErrorEvent.ASYNC_ERROR`) to be dispatched. This event is dispatched when an exception is thrown from native asynchronous code. In this case, it is dispatched when an FLV contains metadata or cue point information, and the appropriate listeners have not been defined. The previous code handles the `asyncError` event and ignores the error if you are not interested in the video file's metadata or cue point information. If you had an FLV with metadata and several cue points, the following information would be traced:

```
Error #2095: flash.net.NetStream was unable to invoke callback onMetaData.
Error #2095: flash.net.NetStream was unable to invoke callback onCuePoint.
Error #2095: flash.net.NetStream was unable to invoke callback onCuePoint.
Error #2095: flash.net.NetStream was unable to invoke callback onCuePoint.
```

The error occurs because the `NetStream` object was unable to find an `onMetaData` or `onCuePoint` callback method. There are several ways to define these callback methods within your applications:

- Set the `NetStream` object's client property to an `Object`
- Create a custom class and define methods to handle the callback methods
- Extend the `NetStream` class and add methods to handle the callback methods
- Extend the `NetStream` class and make it dynamic
- Set the `NetStream` object's client property to this

## Set the `NetStream` object's client property to an `Object`

By setting the `client` property to either an `Object` or a subclass of `NetStream`, you can reroute the `onMetaData` and `onCuePoint` callback methods or ignore them completely. The following example demonstrates how you can use an empty `Object` to ignore the callback methods without listening for the `asyncError` event:

```
var nc:NetConnection = new NetConnection();
nc.connect(null);

var customClient:Object = new Object();

var ns:NetStream = new NetStream(nc);
ns.client = customClient;
ns.play("video.flv");

var vid:Video = new Video();
vid.attachNetStream(ns);
addChild(vid);
```

If you wanted to listen for either the `onMetaData` or `onCuePoint` callback methods, you would need to define methods to handle those callback methods, as shown in the following snippet:

```
var customClient:Object = new Object();
customClient.onMetaData = metaDataHandler;
function metaDataHandler(infoObject:Object):void
{
    trace("metadata");
}
```

The previous code listens for the `onMetaData` callback method and calls the `metaDataHandler()` method, which traces a string. If Flash Player encountered a cue point, no errors would be generated even though no `onCuePoint` callback method is defined.

## Create a custom class and define methods to handle the callback methods

The following code sets the `NetStream` object's `client` property to a custom class, `CustomClient`, which defines handlers for the callback methods:

```
var nc:NetConnection = new NetConnection();
nc.connect(null);
```

```
var ns:NetStream = new NetStream(nc);
ns.client = new CustomClient();
ns.play("video.flv");
```

```
var vid:Video = new Video();
vid.attachNetStream(ns);
addChild(vid);
```

The `CustomClient` class is as follows:

```
package
{
    public class CustomClient
    {
        public function onMetaData(infoObject:Object):void
        {
            trace("metadata");
        }
    }
}
```

The `CustomClient` class defines a handler for the `onMetaData` callback handler. If a cue point was encountered and the `onCuePoint` callback handler was called, an `asynchError` event (`AsynchErrorEvent.ASYNC_ERROR`) would be dispatched saying “flash.net.NetStream was unable to invoke callback onCuePoint.” To prevent this error, you would either need to define an `onCuePoint` callback method in your `CustomClient` class, or define an event handler for the `asynchError` event.



## Extend the NetStream class and add methods to handle the callback methods

The following code creates an instance of the CustomNetStream class, which is defined in a later code listing:

```
var ns:CustomNetStream = new CustomNetStream();
ns.play("video.flv");

var vid:Video = new Video();
vid.attachNetStream(ns);
addChild(vid);
```

The following code listing defines the CustomNetStream class that extends the NetStream class, handles the creation of the necessary NetConnection object, and handles the onMetaData and onCuePoint callback handler methods:

```
package
{
    import flash.net.NetConnection;
    import flash.net.NetStream;
    public class CustomNetStream extends NetStream
    {
        private var nc:NetConnection;
        public function CustomNetStream()
        {
            nc = new NetConnection();
            nc.connect(null);
            super(nc);
        }
        public function onMetaData(infoObject:Object):void
        {
            trace("metadata");
        }
        public function onCuePoint(infoObject:Object):void
        {
            trace("cue point");
        }
    }
}
```

If you want to rename the `onMetaData()` and `onCuePoint()` methods in the `CustomNetStream` class, you could use the following code:

```
package
{
    import flash.net.NetConnection;
    import flash.net.NetStream;
    public class CustomNetStream extends NetStream
    {
        private var nc:NetConnection;
        public var onMetaData:Function;
        public var onCuePoint:Function;
        public function CustomNetStream()
        {
            onMetaData = metaDataHandler;
            onCuePoint = cuePointHandler;
            nc = new NetConnection();
            nc.connect(null);
            super(nc);
        }
        private function metaDataHandler(infoObject:Object):void
        {
            trace("metadata");
        }
        private function cuePointHandler(infoObject:Object):void
        {
            trace("cue point");
        }
    }
}
```

## Extend the `NetStream` class and make it dynamic

You can extend the `NetStream` class and make the subclass dynamic so that `onCuePoint` and `onMetaData` callback handlers can be added dynamically. This is demonstrated in the following listing:

```
var ns:DynamicCustomNetStream = new DynamicCustomNetStream();
ns.play("video.flv");

var vid:Video = new Video();
vid.attachNetStream(ns);
addChild(vid);
```

The `DynamicCustomNetStream` class is as follows:

```
package
{
    import flash.net.NetConnection;
    import flash.net.NetStream;
    public dynamic class DynamicCustomNetStream extends NetStream
    {
        private var nc:NetConnection;
        public function DynamicCustomNetStream()
        {
            nc = new NetConnection();
            nc.connect(null);
            super(nc);
        }
    }
}
```

Even with no handlers for the `onMetaData` and `onCuePoint` callback handlers, no errors are thrown since the `DynamicCustomNetStream` class is dynamic. If you want to define methods for the `onMetaData` and `onCuePoint` callback handlers, you could use the following code:

```
var ns:DynamicCustomNetStream = new DynamicCustomNetStream();
ns.onMetaData = metaDataHandler;
ns.onCuePoint = cuePointHandler;
ns.play("http://www.helpexamples.com/flash/video/cuepoints.flv");

var vid:Video = new Video();
vid.attachNetStream(ns);
addChild(vid);

function metaDataHandler(info:Object):void
{
    trace("metadata");
}
function cuePointHandler(info:Object):void
{
    trace("cue point");
}
```

## Set the NetStream object's client property to this

By setting the `client` property to `this`, Flash Player looks in the current scope for `onMetaData()` and `onCuePoint()` methods. You can see this in the following example:

```
var nc:NetConnection = new NetConnection();
nc.connect(null);
```

```
var ns:NetStream = new NetStream(nc);
ns.client = this;
ns.play("video.flv");
```

```
var vid:Video = new Video();
vid.attachNetStream(ns);
addChild(vid);
```

If the `onMetaData` or `onCuePoint` callback handlers are called and no methods exist to handle the callback, no errors are generated. To handle these callback handlers, create an `onMetaData()` and `onCuePoint()` method in your code, as seen in the following snippet:

```
function onMetaData(infoObject:Object):void
{
    trace("metadata");
}
function onCuePoint(infoObject:Object):void
{
    trace("cue point");
}
```

## Using cue points

The following example uses a simple `for...in` loop to iterate over each of the properties in the `onCuePoint` callback handler's `infoObject` parameter and trace a message when cue point data is received:

```
var nc:NetConnection = new NetConnection();
nc.connect(null);
```

```
var ns:NetStream = new NetStream(nc);
ns.client = this;
ns.play("video.flv");
```

```
var vid:Video = new Video();
vid.attachNetStream(ns);
addChild(vid);
```

```
function onCuePoint(infoObject:Object):void
{
    var key:String;
    for (key in infoObject)
    {
        trace(key + ": " + infoObject[key]);
    }
}
```

The following output appears:

```
parameters:
name: point1
time: 0.418
type: navigation
```

This code used one of several techniques to set the object on which the callback method was invoked. You can use other techniques; for more information, see [Writing callback methods for onCuePoint and onMetaData](#).

## Using video metadata

You can use the `onMetaData` callback handler to view the metadata information in your FLV file. Metadata includes information about your FLV file, such as duration, width, height, and frame rate. The metadata information that is added to your FLV file depends on the software you use to encode your FLV file or the software you use to add metadata information.

```
var nc:NetConnection = new NetConnection();
nc.connect(null);

var ns:NetStream = new NetStream(nc);
ns.client = this;
ns.play("video.flv");

var vid:Video = new Video();
vid.attachNetStream(ns);
addChild(vid);

function onMetaData(infoObject:Object):void
{
    var key:String;
    for (key in infoObject)
    {
        trace(key + ": " + infoObject[key]);
    }
}
```

The previous code generates code similar to the following, assuming your FLV file contains cue points and audio:

```
width: 320
audiodelay: 0.038
canSeekToEnd: true
height: 213
cuePoints: ..
audiodatarate: 96
duration: 16.334
videodatarate: 400
framerate: 15
videocodecid: 4
audiocodecid: 2
```

**TIP**

If your video does not have audio, the audio-related metadata information (such as `audiodatarate`) returns `undefined` because no audio information is added to the metadata during encoding.

In the previous code, the cue point information was not displaying. In order to display the cue point metadata, you can use the following function which recursively displays the items in an Object:

```
function traceObject(obj:Object, indent:uint = 0):void
{
    var indentString:String = "";
    var i:uint;
    var prop:String;
    var val:*;
    for (i = 0; i < indent; i++)
    {
        indentString += "\t";
    }
    for (prop in obj)
    {
        val = obj[prop];
        if (typeof(val) == "object")
        {
            trace(indentString + " " + prop + ": [Object]");
            traceObject(val, indent + 1);
        }
        else
        {
            trace(indentString + " " + prop + ": " + val);
        }
    }
}
```

Using the previous code snippet to trace the `infoObject` parameter in the `onMetaData()` method creates the following output:

```
width: 320
audiodatarate: 96
audiocodecid: 2
videocodecid: 4
videodatarate: 400
canSeekToEnd: true
duration: 16.334
audiodelay: 0.038
height: 213
framerate: 15
cuePoints: [Object]
  0: [Object]
    parameters: [Object]
      lights: beginning
    name: point1
    time: 0.418
    type: navigation
  1: [Object]
    parameters: [Object]
      lights: middle
    name: point2
    time: 7.748
    type: navigation
  2: [Object]
    parameters: [Object]
      lights: end
    name: point3
    time: 16.02
    type: navigation
```

## Info objects for onMetaData

The following table shows the possible values for video metadata

Parameter	Description
audiocodecid	A number that indicates the audio codec (code/decode technique) that was used.
audiodatarate	A number that indicates the rate at which audio was encoded, in kilobytes per second.
audiodelay	A number that indicates what time in the FLV file "time 0" of the original FLV file exists. The video content needs to be delayed by a small amount to properly synchronize the audio.

Parameter	Description
canSeekToEnd	A Boolean value that is <code>true</code> if the FLV file is encoded with a keyframe on the last frame that allows seeking to the end of a progressive download movie clip. It is <code>false</code> if the FLV file is not encoded with a keyframe on the last frame.
cuePoints	An array of objects, one for each cue point embedded in the FLV file. Value is undefined if the FLV file does not contain any cue points. Each object has the following properties: <ul style="list-style-type: none"> <li>■ <code>type</code>: a string that specifies the type of cue point as either "navigation" or "event".</li> <li>■ <code>name</code>: a string that is the name of the cue point.</li> <li>■ <code>time</code>: a number that is the time of the cue point in seconds with a precision of three decimal places (milliseconds).</li> <li>■ <code>parameters</code>: an optional object that has name-value pairs that are designated by the user when creating the cue points.</li> </ul>
duration	A number that specifies the duration of the FLV file, in seconds.
framerate	A number that is the frame rate of the FLV file.
height	A number that is the height of the FLV file, in pixels.
videocodecid	A number that is the codec version that was used to encode the video.
videodatarate	A number that is the video data rate of the FLV file.
width	A number that is the width of the FLV file, in pixels.

The following table shows the possible values for the `videocodecid` parameter:

videocodecid	Codec name
2	Sorenson H.263
3	Screen video (SWF 7 and later only)
4	VP6 (SWF 8 and later only)
5	VP6 video with alpha channel (SWF 8 and later only)



The following table shows the possible values for the `audiocodecid` parameter:

<b>audiocodecid</b>	<b>Codec Name</b>
0	uncompressed
1	ADPCM
2	mp3
5	Nellymoser 8kHz mono
6	Nellymoser

## Capturing camera input

In addition to external video files, a camera attached to a user's computer can serve as a source of video data that you can display and manipulate using ActionScript. The `Camera` class is the mechanism built into ActionScript for working with a computer camera.

### Understanding the `Camera` class

The `Camera` object allows you to connect to the user's local camera and broadcast the video either locally (back to the user) or remotely to a server (such as Flash Media Server).

Using the `Camera` class, you can access the following kinds of information about the user's camera:

- Which cameras installed on the user's computer are available to Flash Player
- Whether a camera is installed
- Whether Flash Player is allowed or denied access to the user's camera
- Which camera is currently active
- The width and height of the video being captured

The `Camera` class includes several useful methods and properties for working with camera objects. For example, the static `Camera.names` property contains an array of camera names currently installed on the user's computer. You can also use the `name` property to display the name of the currently active camera.

## Displaying camera content on-screen

Connecting to a camera can require less code than using the `NetConnection` and `NetStream` classes to load an FLV. The camera class can also quickly become tricky since you need a user's permission to have Flash Player connect to their camera before you can access it.

The following code demonstrates how you can use the `Camera` class to connect to a user's local camera:

```
var cam:Camera = Camera.getCamera();
var vid:Video = new Video();
vid.attachCamera(cam);
addChild(vid);
```

NOTE

The `Camera` class does not have a constructor method. In order to create a new `Camera` instance you use the static `Camera.getCamera()` method.

## Designing your camera application

When writing an application that connects to a user's camera, you need to account for the following in your code:

- Check if the user has a camera currently installed.
- Check if the user has explicitly allowed Flash Player to access their camera. For security reasons the player displays the Flash Player Settings dialog which lets the user allow or deny access to their camera. This prevents Flash Player from connecting to a user's camera and broadcasting a video stream without their permission. If a user clicks allow, your application can connect to the user's camera. If the user clicks deny, your application will be unable to access the user's camera. Your applications should always handle both cases gracefully.

## Connecting to a user's camera

The first step when connecting to a user's camera is to create a new camera instance by creating a variable of type `Camera` and initializing it to the return value of the static `Camera.getCamera()` method.

The next step is to create a new video object and attach the `Camera` object to it.

The third step is to add the video object to the display list. You need to perform steps 2 and 3 because the `Camera` class does not extend the `DisplayObject` class so it cannot be added directly to the display list. To display the camera's captured video, you create a new video object and call the `attachCamera()` method.

The following code shows these three steps:

```
var cam:Camera = Camera.getCamera();
var vid:Video = new Video();
vid.attachCamera(cam);
addChild(vid);
```

Note that if a user does not have a camera installed, Flash Player will not display anything.

In real life, you need to perform additional steps for your application. See [Verifying that cameras are installed](#) and [Detecting permissions for camera access](#) for further information.

## Verifying that cameras are installed

Before you attempt to use any methods or properties on a camera instance, you'll want to verify that the user has a camera installed. There are two ways to check whether the user has a camera installed:

- Check the static `Camera.names` property which contains an array of camera names which are available. Typically this array will have one or fewer strings, as most users will not likely have more than one camera installed at a time. The following code demonstrates how you could check the `Camera.names` property to see if the user has any available cameras:

```
if (Camera.names.length > 0)
{
    trace("User has no cameras installed.");
}
else
{
    var cam:Camera = Camera.getCamera(); // Get default camera.
}
```

- Check the return value of the static `Camera.getCamera()` method. If no cameras are available or installed, this method returns `null`, otherwise it returns a reference to a `Camera` object. The following code demonstrates how you could check the `Camera.getCamera()` method to see if the user has any available cameras:

```
var cam:Camera = Camera.getCamera();
if (cam == null)
{
    trace("User has no cameras installed.");
}
else
{
    trace("User has at least 1 camera installed.");
}
```

Since the `Camera` class doesn't extend the `DisplayObject` class, it cannot be directly added to the display list using the `addChild()` method. In order to display the camera's captured video, you need to create a new `Video` object and call the `attachCamera()` method on the `Video` instance.

This snippet shows how you can attach the camera if one exists; if not, Flash Player simply displays nothing:

```
var cam:Camera = Camera.getCamera();
if (cam != null)
{
    var vid:Video = new Video();
    vid.attachCamera(cam);
    addChild(vid);
}
```

## Detecting permissions for camera access

Before the camera's output can be displayed, the user must explicitly allow Flash Player to access the camera. When the `attachCamera()` method gets called Flash Player displays the Flash Player Settings dialog box which prompts the user to either allow or deny Flash Player access to the camera and microphone. If the user clicked the Allow button, the camera's output is displayed in the `Video` instance on the Stage. If the user clicked the Deny button, Flash Player is unable to connect to the camera and the `Video` object will not display anything.

If the user does not have a camera installed, Flash Player will display nothing. If the user does have a camera installed, Flash Player will display the Flash Player Settings dialog which prompts the user to either allow or deny Flash Player to access the Camera. If the user allows access to their camera the video will be displayed back to the user, otherwise nothing will be displayed.

If you want to detect whether the user allowed or denied access to the camera, you can listen for the camera's status event (`StatusEvent.STATUS`), as seen in the following code:

```
var cam:Camera = Camera.getCamera();
if (cam != null)
{
    cam.addEventListener(StatusEvent.STATUS, statusHandler);
    var vid:Video = new Video();
    vid.attachCamera(cam);
    addChild(vid);
}
```

```
function statusHandler(event:StatusEvent):void
{
    // This event gets dispatched when the user clicks the "Allow" or "Deny"
    // button in the Flash Player Settings dialog box.
    trace(event.code); // "Camera.Muted" or "Camera.Unmuted"
}
```

The `statusHandler()` function gets called as soon as the user clicks either Allow or Deny. You can detect which button the user clicked, using one of two methods:

- The event parameter of the `statusHandler()` function contains a code property which contains the string “Camera.Muted” or “Camera.Unmuted”. If the value is “Camera.Muted” the user clicked the Deny button and Flash Player is unable to access the camera. You can see an example of this in the following snippet:

```
function statusHandler(event:StatusEvent):void
{
    switch (event.code)
    {
        case "Camera.Muted":
            trace("User clicked Deny.");
            break;
        case "Camera.Unmuted":
            trace("User clicked Accept.");
            break;
    }
}
```

- The Camera class contains a read-only property named `muted` which specifies whether the user has denied access to the camera (`true`) or allowed access (`false`) in the Flash Player Privacy panel. You can see an example of this in the following snippet:

```
function statusHandler(event:StatusEvent):void
{
    if (cam.muted)
    {
        trace("User clicked Deny.");
    }
    else
    {
        trace("User clicked Accept.");
    }
}
```

By checking for the status event to be dispatched, you can write code that handles the user accepting or denying access to the camera and clean up appropriately. For example, if the user clicks the Deny button, you could display a message to the user stating that they need to click Allow if they want to participate in a video chat, or you could instead make sure the Video object on the display list is deleted to free up system resources.

## Maximizing video quality

By default, new instances of the `Video` class are 320 pixels wide by 240 pixels high. In order to maximize video quality you should always ensure that your video object matches the same dimensions as the video being returned by the camera object. You can get the camera object's width and height by using the `Camera` class's `width` and `height` properties, you can then set the video object's `width` and `height` properties to match the camera objects dimensions, or you can pass the camera's width and height to the `Video` class's constructor method, as seen in the following snippet:

```
var cam:Camera = Camera.getCamera();
if (cam != null)
{
    var vid:Video = new Video(cam.width, cam.height);
    vid.attachCamera(cam);
    addChild(vid);
}
```

Since the `getCamera()` method returns a reference to a camera object (or `null` if no cameras are available) you can access the camera's methods and properties even if the user denies access to their camera. This allows you to set the size of the video instance using the camera's native height and width.

```
var vid:Video;
var cam:Camera = Camera.getCamera();

if (cam == null)
{
    trace("Unable to locate available cameras.");
}
else
{
    trace("Found camera: " + cam.name);
    cam.addEventListener(StatusEvent.STATUS, statusHandler);
    vid = new Video();
    vid.attachCamera(cam);
}
```

```

function statusHandler(event:StatusEvent):void
{
    if (cam.muted)
    {
        trace("Unable to connect to active camera.");
    }
    else
    {
        // Resize Video object to match camera settings and
        // add the video to the display list.
        vid.width = cam.width;
        vid.height = cam.height;
        addChild(vid);
    }
    // Remove the status event listener.
    cam.removeEventListener(StatusEvent.STATUS, statusHandler);
}

```

## Monitoring playback conditions

The camera class contains several properties which allow you to monitor the Camera object's current status. For example, the following code displays several of the camera's properties using a Timer object and a text field instance on the display list:

```

var vid:Video;
var cam:Camera = Camera.getCamera();
var tf:TextField = new TextField();
tf.x = 300;
tf.autoSize = TextFieldAutoSize.LEFT;
addChild(tf);

if (cam != null)
{
    cam.addEventListener(StatusEvent.STATUS, statusHandler);
    vid = new Video();
    vid.attachCamera(cam);
}
function statusHandler(event:StatusEvent):void
{
    if (!cam.muted)
    {
        vid.width = cam.width;
        vid.height = cam.height;
        addChild(vid);
        t.start();
    }
}

```

```

    }
    cam.removeEventListener(StatusEvent.STATUS, statusHandler);
}

var t:Timer = new Timer(100);
t.addEventListener(TimerEvent.TIMER, timerHandler);
function timerHandler(event:TimerEvent):void
{
    tf.text = "";
    tf.appendText("activityLevel: " + cam.activityLevel + "\n");
    tf.appendText("bandwidth: " + cam.bandwidth + "\n");
    tf.appendText("currentFPS: " + cam.currentFPS + "\n");
    tf.appendText("fps: " + cam.fps + "\n");
    tf.appendText("keyFrameInterval: " + cam.keyFrameInterval + "\n");
    tf.appendText("loopback: " + cam.loopback + "\n");
    tf.appendText("motionLevel: " + cam.motionLevel + "\n");
    tf.appendText("motionTimeout: " + cam.motionTimeout + "\n");
    tf.appendText("quality: " + cam.quality + "\n");
}

```

Every 1/10 of a second (100 milliseconds) the Timer object's `timer` event is dispatched and the `timerHandler()` function updates the text field on the display list.

## Sending video to a server

If you want to build more complex applications involving video or camera objects, Flash Media Server offers a combination of streaming media capabilities and a development environment for creating and delivering media applications to a wide audience. This combination enables developers to create applications such as Video on Demand, live web-event broadcasts, and mp3 streaming as well as video blogging, video messaging, and multimedia chat environments. For more information, see the Flash Media Server documentation online at <http://livedocs.macromedia.com/fms/2/docs/>.



# Advanced topics

The following topics address some special issues for working with video.

## Flash Player compatibility with encoded FLV files

Flash Player 7 supports FLV files that are encoded with the Sorenson™ Spark™ video codec. Flash Player 8 supports FLV files encoded with Sorenson Spark or On2 VP6 encoder in Flash Professional 8. The On2 VP6 video codec supports an alpha channel. Different Flash Player versions support FLV in different ways. For more information, see the following table:

Codec	SWF file version (publish version)	Flash Player version required for playback
Sorenson Spark	6	6, 7, or 8
	7	7, 8
On2 VP6	6	8*
	7	8
	8	8

\* If your SWF file loads an FLV file, you can use the On2 VP6 video without having to republish your SWF file for Flash Player 8, as long as users use Flash Player 8 to view your SWF file. Only Flash Player 8 supports publish and playback of On2 VP6 video.

## About configuring FLV files for hosting on a server

When you work with FLV files, you might have to configure your server to work with the FLV file format. Multipurpose Internet Mail Extensions (MIME) is a standardized data specification that lets you send non-ASCII files over Internet connections. Web browsers and e-mail clients are configured to interpret numerous MIME types so that they can send and receive video, audio, graphics, and formatted text. To load FLV files from a web server, you might need to register the file extension and MIME type with your web server, so you should check your web server documentation. The MIME type for FLV files is `video/x-flv`. The full information for the FLV file type is as follows:

- Mime Type: `video/x-flv`
- File extension: `.flv`
- Required parameters: none
- Optional parameters: none

- Encoding considerations: FLV files are binary files; some applications might require the application/octet-stream subtype to be set.
- Security issues: none
- Published specification: [www.adobe.com/go/flashfileformat](http://www.adobe.com/go/flashfileformat).

Microsoft changed the way streaming media is handled in Microsoft Internet Information Services (IIS) 6.0 web server from earlier versions. Earlier versions of IIS do not require any modification to stream Flash Video. In IIS 6.0, the default web server that comes with Windows 2003, the server requires a MIME type to recognize that FLV files are streaming media.

When SWF files that stream external FLV files are placed on Microsoft Windows Server® 2003 and are viewed in a browser, the SWF file plays correctly, but the FLV video does not stream. This issue affects all FLV files placed on Windows Server 2003, including files you make with earlier versions of the Flash authoring tool, the Macromedia Flash Video Kit for Dreamweaver MX 2004 from Adobe. These files work correctly if you test them on other operating systems.

For information about configuring Microsoft Windows 2003 and Microsoft IIS Server 6.0 to stream FLV video, see [www.adobe.com/go/tn\\_19439](http://www.adobe.com/go/tn_19439).

## About targeting local FLV files on the Macintosh

If you attempt to play a local FLV from a non-system drive on an Apple® Macintosh® computer by using a path that uses a relative slash (/), the video will not play. Non-system drives include, but are not limited to, CD-ROMs, partitioned hard disks, removable storage media, and connected storage devices.

**NOTE**

The reason for this failure is a limitation of the operating system, not a limitation in Flash Player.

For an FLV file to play from a non-system drive on a Macintosh, refer to it with an absolute path using a colon-based notation (:) rather than slash-based notation (/). The following list shows the difference in the two kinds of notation:

- Slash-based notation: myDrive/myFolder/myFLV.flv
- Colon-based notation: (Mac OS®) myDrive:myFolder:myFLV.flv

You can also create a projector file for a CD-ROM you intend to use for Macintosh playback. For the latest information on Mac OS CD-ROMs and FLV files, see [www.adobe.com/go/3121b301](http://www.adobe.com/go/3121b301).

# Example: Video Jukebox

The following example builds a simple video jukebox which dynamically loads a list of videos to play back in a sequential order. This allows you to build an application that lets a user browse through a series of video tutorials, or perhaps specifies which advertisements should be played back before delivering the user's requested video. This example demonstrates the following features of ActionScript 3.0:

- Updating a playhead based on a video file's playback progress
- Listening for and parsing a video file's metadata
- Handling specific codes in a net stream
- Loading, playing, pausing, and stopping a dynamically loaded FLV
- Resizing a video object on the display list based on the net stream's metadata

To get the application files for this sample, see [www.adobe.com/go/learn\\_programmingAS3samples\\_flash](http://www.adobe.com/go/learn_programmingAS3samples_flash). The Video Jukebox application files can be found in the folder Samples/VideoJukebox. The application consists of the following files:

File	Description
VideoJukebox.as	The class that provides the main functionality of the application.
VideoJukebox fla	The main application file for Flash.
playlist.xml	A file that lists which video files will be loaded into the video jukebox.

## Loading an external video playlist file

The external playlist.xml file specifies which videos to load, and the order to play them back in. In order to load the XML file, you need to use a URLLoader object and a URLRequest object, as seen in the following code:

```
uldr = new URLLoader();
uldr.addEventListener(Event.COMPLETE, xmlCompleteHandler);
uldr.load(new URLRequest(PLAYLIST_XML_URL));
```

This code is placed in the VideoJukebox class's constructor so the file is loaded before any other code is run. As soon as the XML file has finished loading, the `xmlCompleteHandler()` method is called which parses the external file into an XML object, as seen in the following code:

```
private function xmlCompleteHandler(event:Event):void
{
    playlist = XML(event.target.data);
    videosXML = playlist.video;
    main();
}
```

The playlist XML object contains the raw XML from the external file, whereas the `videosXML` is an `XMLList` object which contains just the video nodes. A sample `playlist.xml` file can be seen in the following snippet:

```
<videos>
  <video url="video/caption_video.flv" />
  <video url="video/cuepoints.flv" />
  <video url="video/water.flv" />
</videos>
```

Finally, the `xmlCompleteHandler()` method calls the `main()` method which sets up the various component instances on the display list, as well as the `NetConnection` and `NetStream` objects which are used to load the external FLV files.

## Creating the user interface

To build the user interface you need to drag five `Button` instances onto the display list and give them the following instance names: `playButton`, `pauseButton`, `stopButton`, `backButton`, and `forwardButton`.

For each of these `Button` instances, you'll need to assign a handler for the `click` event, as seen in the following snippet:

```
playButton.addEventListener(MouseEvent.CLICK, buttonClickHandler);
pauseButton.addEventListener(MouseEvent.CLICK, buttonClickHandler);
stopButton.addEventListener(MouseEvent.CLICK, buttonClickHandler);
backButton.addEventListener(MouseEvent.CLICK, buttonClickHandler);
forwardButton.addEventListener(MouseEvent.CLICK, buttonClickHandler);
```

The `buttonClickHandler()` method uses a `switch` statement to determine which button instance was clicked, as seen in the following code:

```
private function buttonClickHandler(event:MouseEvent):void
{
    switch (event.currentTarget)
    {
        case playButton:
            ns.resume();
            break;
        case pauseButton:
            ns.togglePause();
            break;
        case stopButton:
            ns.pause();
            ns.seek(0);
            break;
        case backButton:
            playPreviousVideo();
            break;
        case forwardButton:
            playNextVideo();
            break;
    }
}
```

Next, add a `Slider` instance to the display list and give it an instance name of `volumeSlider`. The following code sets the slider instance's `liveDragging` property to `true` and defines an event listener for the slider instance's change event:

```
volumeSlider.value = volumeTransform.volume;
volumeSlider.minimum = 0;
volumeSlider.maximum = 1;
volumeSlider.snapInterval = 0.1;
volumeSlider.tickInterval = volumeSlider.snapInterval;
volumeSlider.liveDragging = true;
volumeSlider.addEventListener(SliderEvent.CHANGE, volumeChangeHandler);
```

Add a `ProgressBar` instance to the display list and give it an instance name of `positionBar`. Set its mode property to `manual`, as seen in the following snippet:

```
positionBar.mode = ProgressBarMode.MANUAL;
```

Finally add a `Label` instance to the display list and give it an instance name of `positionLabel`. This `Label` instance's value will be set by the timer instance

## Listening for a video object's metadata

When Flash Player encounters metadata for each of the loaded videos, the `onMetaData()` callback handler is called on the `NetStream` object's `client` property. The following code initializes an `Object` and sets up the specified callback handler:

```
client = new Object();
client.onMetaData = metadataHandler;
```

The `metadataHandler()` method copies its data to the metaproperty defined earlier in the code. This allows you to access the metadata for the current video anytime throughout the entire application. Next, the video object on the Stage is resized to match the dimensions returned from the metadata. Finally, the `positionBar` progress bar instance is moved and resized based on the size of the currently playing video. The following code contains the entire `metadataHandler()` method:

```
private function metadataHandler(metadataObj:Object):void
{
    meta = metadataObj;
    vid.width = meta.width;
    vid.height = meta.height;
    positionBar.move(vid.x, vid.y + vid.height);
    positionBar.width = vid.width;
}
```

## Dynamically loading a Flash video

To dynamically load each of the Flash videos the application uses a `NetConnection` and `NetStream` object. The following code creates a `NetConnection` object and passes `null` to the `connect()` method. By specifying `null`, Flash Player connects to a video on the local server instead of connecting to a server, such as a Flash Media Server.

The following code creates both the `NetConnection` and `NetStream` instances, defines an event listener for the `netStatus` event, and assigns the `client` `Object` to the `client` property:

```
nc = new NetConnection();
nc.connect(null);

ns = new NetStream(nc);
ns.addEventListener(NetStatusEvent.NET_STATUS, netStatusHandler);
ns.client = client;
```

The `netStatusHandler()` method is called whenever the status of the video is changed. This includes when a video starts or stops playback, is buffering or if a video stream cannot be found. The following code lists the `netStatusHandler()` event:

```
private function netStatusHandler(event:NetStatusEvent):void
```

```

{
  try
  {
    switch (event.info.code)
    {
      case "NetStream.Play.Start":
        t.start();
        break;
      case "NetStream.Play.StreamNotFound":
      case "NetStream.Play.Stop":
        t.stop();
        playNextVideo();
        break;
    }
  }
  catch (error:TypeError)
  {
    // Ignore any errors.
  }
}

```

The previous code evaluates the code property of the info object and filters whether the code is “NetStream.Play.Start”, “NetStream.Play.StreamNotFound”, or “NetStream.Play.Stop”. All other codes will be ignored. If the net stream is starting the code starts the Timer instance which updates the playhead. If the net stream cannot be found or is stopped, the Timer instance is stopped and the application attempts to play the next video in the playlist.

Every time the Timer executes, the `positionBar` progress bar instance updates its current position by calling the `setProgress()` method of the `ProgressBar` class and the `positionLabel` Label instance is updated with the time elapsed and total time of the current video.

```

private function timerHandler(event:TimerEvent):void
{
  try
  {
    positionBar.setProgress(ns.time, meta.duration);
    positionLabel.text = ns.time.toFixed(1) + " of "
    meta.duration.toFixed(1) + " seconds";
  }
  catch (error:Error)
  {
    // Ignore this error.
  }
}

```

## Controlling the volume of the video

You can control the volume for the dynamically loaded video by setting the `soundTransform` property on the `NetStream` object. The video jukebox application allows you to modify the volume level by changing the value of the `volumeSlider` `Slider` instance. The following code shows how you can change the volume level by assigning the value of the `Slider` component to a `SoundTransform` object which is set to the `soundTransform` property on the `NetStream` object:

```
private function volumeChangeHandler(event:SliderEvent):void
{
    volumeTransform.volume = event.value;
    ns.soundTransform = volumeTransform;
}
```

## Controlling video playback

The rest of the application controls video playback when the video reaches the end of the video stream or the user skips to the previous or next video.

The following method retrieves the video URL from the `XMLList` for the currently selected index:

```
private function getVideo():String
{
    return videosXML[idx].@url;
}
```

The `playVideo()` method calls the `play()` method on the `NetStream` object to load the currently selected video:

```
private function playVideo():void
{
    var url:String = getVideo();
    ns.play(url);
}
```

The `playPreviousVideo()` method decrements the current video index, calls the `playVideo()` method to load the new video file and sets the progress bar to visible:

```
private function playPreviousVideo():void
{
    if (idx > 0)
    {
        idx--;
        playVideo();
        positionBar.visible = true;
    }
}
```



The final method, `playNextVideo()`, increments the video index and calls the `playVideo()` method. If the current video is the last video in the playlist, the `clear()` method is called on the `Video` object and the progress bar instance's `visible` property is set to `false`:

```
private function playNextVideo():void
{
    if (idx < (videosXML.length() - 1))
    {
        idx++;
        playVideo();
        positionBar.visible = true;
    }
    else
    {
        idx++;
        vid.clear();
        positionBar.visible = false;
    }
}
```



ActionScript is made for immersive, interactive applications—and one often overlooked element of powerfully immersive applications is sound. You can add sound effects to a video game, audio feedback to an application user interface, or even make a program that analyzes mp3 files loaded over the Internet, with sound at the core of the application.

In this chapter, you'll learn about loading external audio files and working with audio that's embedded in a SWF. You'll learn to control the audio, to create visual representations of the sound information, and to capture sound from a user's microphone.

## Contents

Basics of working with sound .....	596
Understanding the sound architecture .....	599
Loading external sound files .....	600
Working with embedded sounds .....	603
Working with streaming sound files .....	604
Playing sounds .....	605
Security considerations when loading and playing sounds.....	609
Controlling sound volume and panning .....	611
Working with sound metadata .....	613
Accessing raw sound data .....	614
Capturing sound input .....	617
Example: Podcast Player .....	622

# Basics of working with sound

## Introduction to working with sound

Just as computers can encode images in a digital format, store them on a computer, and retrieve them to display on the screen, computers can capture and encode digital audio—computer representation of sound information—and can store it and retrieve it to play back over speakers connected to the computer. One way to play back sound is using Adobe Flash Player and ActionScript.

When sound data is converted to digital form, it has various characteristics, such as the sound's volume and whether it is stereo or mono sound. When you play back a sound in ActionScript, you can adjust these characteristics as well—make the sound louder, or make it seem to be coming from a certain direction, for instance.

Before you can control a sound in ActionScript, you need to have the sound information loaded into Flash Player. There are four ways you can get audio data into Flash Player so that you can work with it using ActionScript. You can load an external sound file such as an mp3 file into the SWF; you can embed the sound information into the SWF file directly when it's being created; you can get audio input using a microphone attached to a user's computer, and you can access sound data that's streamed from a server.

When you load sound data from an external sound file, you can begin playing back the start of the sound file while the rest of the sound data is still loading.

Although there are various sound file formats used to encode digital audio, ActionScript 3.0 and Flash Player support sound files that are stored in the mp3 format. They cannot directly load or play sound files in other formats like WAV or AIFF.

While you're working with sound in ActionScript, you'll likely work with several classes from the `flash.media` package. The `Sound` class is the class you use to get access to audio information by loading a sound file and starting playback. Once you start playing a sound, Flash Player gives you access to a `SoundChannel` object. Since an audio file that you've loaded may only be one of several sounds that you play on a user's computer, each individual sound that's playing uses its own `SoundChannel` object; the combined output of all the `SoundChannel` objects mixed together is what actually plays over the computer's speakers. You use this `SoundChannel` instance to control properties of the sound and to stop its playback. Finally, if you want to control the combined audio, the `SoundMixer` class gives you control over the mixed output.

You can also use several other classes to perform more specific tasks when you're working with sound in ActionScript; for more information on all the sound-related classes, see [“Understanding the sound architecture” on page 599](#).

## Common tasks for working with sound

This chapter describes the following sound-related tasks that you will likely want to perform:

- Loading external mp3 files and tracking their loading progress
- Playing, pausing, resuming, and stopping sounds
- Playing streaming sounds while they are being loaded
- Manipulating sound volume and panning
- Retrieving ID3 metadata from an mp3 file
- Using raw sound wave data
- Capturing and replaying sound input from a user's microphone

## Important concepts and terms

The following reference list contains important terms that you will encounter in this chapter:

- **Amplitude:** The distance of a point on the sound waveform from the zero or equilibrium line.
- **Bit rate:** The amount of data that is encoded or streamed for each second of a sound file. For mp3 files, the bit rate is usually stated in terms of thousands of bits per second (kbps). A higher bit rate generally means a higher quality sound wave.
- **Buffering:** The receiving and storing of sound data before it is played back.
- **mp3:** MPEG-1 Audio Layer 3, or mp3, is a popular sound compression format.
- **Panning:** The positioning of an audio signal between the left and right channels in a stereo soundfield.
- **Peak:** The highest point in a waveform.
- **Sampling rate:** Defines the number of samples per second taken from an analog audio signal to make a digital signal. The sampling rate of standard compact disc audio is 44.1 kHz or 44,100 samples per second.
- **Streaming:** The process of playing the early portions of a sound file or video file while later portions of that file are still being loaded from a server.
- **Volume:** The loudness of a sound.
- **Waveform:** The shape of a graph of the varying amplitudes of a sound signal over time.

## Working through in-chapter examples

As you're working through this chapter, you may want to try out some of the example code listings. Since this chapter covers working with sound in ActionScript, many of the examples do something that involves working with a sound file—making it play, stopping playback, or adjusting the sound in some way. To test the examples in this chapter:

1. Create a new Flash document and save it on your computer.
2. In the Timeline, select the first keyframe and open the Actions panel.
3. Copy the example code listing into the Script pane.
4. If the code involves loading an external sound file, it will have a line of code that looks something like this:

```
var req:URLRequest = new URLRequest("click.mp3");  
var s:Sound = new Sound(req);
```

where “click.mp3” is the name of the sound file being loaded. In order to test these examples, you'll need to have an mp3 file to use. You should put the mp3 file in the same folder as your Flash document. You should then alter the code to use the name of your mp3 file instead of the name in the code listing (for example, in the code above you'd change “click.mp3” to the name of your mp3 file).

5. From the main menu, choose Control > Test Movie to create the SWF file and preview (and hear) the output of the example.

In addition to playing audio, some of the examples display values using the `trace()` function; when you're testing those examples, you'll see the results of those values in the Output panel. Some examples also draw content to the screen, so for those examples you'll see the content in the Flash Player window as well.

For more information about testing the example code listings in this manual, see [“Testing in-chapter example code listings” on page 63](#).

# Understanding the sound architecture

Your applications can load sound data from four main sources:

- External sound files loaded at run time
- Sound resources embedded within the application's SWF file
- Sound data from a microphone attached to the user's system
- Sound data streamed from a remote media server, such as Flash Media Server

Sound data can be fully loaded before it is played back, or it can be streamed, meaning that it is played back while it is still loading.

ActionScript 3.0 and Flash Player support sound files that are stored in the mp3 format. They cannot directly load or play sound files in other formats like WAV or AIFF.

Using the Adobe Flash CS3 Professional, you can import WAV or AIFF sound files and then embed them into your application's SWF files in the mp3 format. The Flash Authoring tool also lets you compress embedded sound files to reduce their file size, though this size reduction comes at the expense of sound quality. For more information see [“Importing Sounds” in \*Using Flash\*](#).

The ActionScript 3.0 sound architecture makes use of the following classes in the flash.media package.

Class	Description
flash.media.Sound	The Sound class handles the loading of sound, manages basic sound properties, and starts a sound playing.
flash.media.SoundChannel	When an application plays a Sound object, a new SoundChannel object is created to control the playback. The SoundChannel object controls the volume of both the left and right playback channels of the sound. Each sound that plays has its own SoundChannel object.
flash.media.SoundLoaderContext	The SoundLoaderContext class specifies how many seconds of buffering to use when loading a sound, and whether Flash Player looks for a cross-domain policy file from the server when loading a file. A SoundLoaderContext object is used as a parameter to the <code>Sound.load()</code> method.

Class	Description
flash.media.SoundMixer	The SoundMixer class controls playback and security properties that pertain to all sounds in an application. In effect, multiple sound channels are mixed through a common SoundMixer object, so property values in the SoundMixer object will affect all SoundChannel objects that are currently playing.
flash.media.SoundTransform	The SoundTransform class contains values that control sound volume and panning. A SoundTransform object can be applied to an individual SoundChannel object, to the global SoundMixer object, or to a Microphone object, among others.
flash.media.ID3Info	An ID3Info object contains properties that represent ID3 metadata information that is often stored in mp3 sound files.
flash.media.Microphone	The Microphone class represents a microphone or other sound input device attached to the user's computer. Audio input from a microphone can be routed to local speakers or sent to a remote server. The Microphone object controls the gain, sampling rate, and other characteristics of its own sound stream.

Each sound that is loaded and played needs its own instance of the Sound class and the SoundChannel class. The output from multiple SoundChannel instances is then mixed together by the global SoundMixer class during playback,

The Sound, SoundChannel, and SoundMixer classes are not used for sound data obtained from a microphone or from a streaming media server like Flash Media Server.

## Loading external sound files

Each instance of the Sound class exists to load and trigger the playback of a specific sound resource. An application can't reuse a Sound object to load more than one sound. If it wants to load a new sound resource, it should create a new Sound object.

If you are loading a small sound file, such as a click sound to be attached to a button, your application can create a new Sound and have it automatically load the sound file, as shown below:

```
var req:URLRequest = new URLRequest("click.mp3");
var s:Sound = new Sound(req);
```



The `Sound()` constructor accepts a `URLRequest` object as its first parameter. When a value for the `URLRequest` parameter is supplied, the new `Sound` object starts loading the specified sound resource automatically.

In all but the simplest cases, your application should pay attention to the sound's loading progress and watch for errors during loading. For example, if the click sound is fairly large, it might not be completely loaded by the time the user clicks the button that triggers the sound. Trying to play an unloaded sound could cause a run-time error. It's safer to wait for the sound to load completely before letting users take actions that might start sounds playing.

A `Sound` object dispatches a number of different events during the sound loading process. Your application can listen for these events to track loading progress and make sure that the sound loads completely before playing. The following table lists the events that can be dispatched by a `Sound` object.

Event	Description
<code>open (Event.OPEN)</code>	Dispatched right before the sound loading operation begins.
<code>progress (ProgressEvent.PROGRESS)</code>	Dispatched periodically during the sound loading process when data is received from the file or stream.
<code>id3 (Event.ID3)</code>	Dispatched when ID3 data is available for an mp3 sound.
<code>complete (Event.COMPLETE)</code>	Dispatched when all of the sound resource's data has been loaded.
<code>ioError (IOErrorEvent.IO_ERROR)</code>	Dispatched when a sound file cannot be located or when the loading process is interrupted before all sound data can be received.

The following code illustrates how to play a sound after it has finished loading:

```
import flash.events.Event;
import flash.media.Sound;
import flash.net.URLRequest;

var s:Sound = new Sound();
s.addEventListener(Event.COMPLETE, onSoundLoaded);
var req:URLRequest = new URLRequest("bigSound.mp3");
s.load(req);

function onSoundLoaded(event:Event):void
{
    var localSound:Sound = event.target as Sound;
    localSound.play();
}
```

First, the code sample creates a new `Sound` object without giving it an initial value for the `URLRequest` parameter. Then, it listens for the `Event.COMPLETE` event from the `Sound` object, which causes the `onSoundLoaded()` method to execute when all the sound data is loaded. Next, it calls the `Sound.load()` method with a new `URLRequest` value for the sound file.

The `onSoundLoaded()` method executes when the sound loading is complete. The target property of the `Event` object is a reference to the `Sound` object. Calling the `play()` method of the `Sound` object then starts the sound playback.

## Monitoring the sound loading process

Sound files can be very large and take a long time to load. While Flash Player lets your application play sounds even before they are fully loaded, you might want to give the user an indication of how much of the sound data has been loaded and how much of the sound has already been played.

The `Sound` class dispatches two events that make it relatively easy to display the loading progress of a sound: `ProgressEvent.PROGRESS` and `Event.COMPLETE`. The following example shows how to use these events to display progress information about the sound being loaded:

```
import flash.events.Event;
import flash.events.ProgressEvent;
import flash.media.Sound;
import flash.net.URLRequest;

var s:Sound = new Sound();
s.addEventListener(ProgressEvent.PROGRESS, onLoadProgress);
s.addEventListener(Event.COMPLETE, onLoadComplete);
s.addEventListener(IOErrorEvent.IO_ERROR, onIOError);

var req:URLRequest = new URLRequest("bigSound.mp3");
s.load(req);

function onLoadProgress(event:ProgressEvent):void
{
    var loadedPct:uint =
        Math.round(100 * (event.bytesLoaded / event.bytesTotal));
    trace("The sound is " + loadedPct + "% loaded.");
}

function onLoadComplete(event:Event):void
{
    var localSound:Sound = event.target as Sound;
    localSound.play();
}
```

```
function onIOError(event:IOErrorEvent)
{
    trace("The sound could not be loaded: " + event.text);
}
```

This code first creates a `Sound` object and then adds listeners to that object for the `ProgressEvent.PROGRESS` and `Event.COMPLETE` events. After the `Sound.load()` method has been called and the first data is received from the sound file, a `ProgressEvent.PROGRESS` event occurs and triggers the `onSoundLoadProgress()` method.

The percentage of the sound data that has been loaded is equal to the value of the `bytesLoaded` property of the `ProgressEvent` object divided by the value of the `bytesTotal` property. The same `bytesLoaded` and `bytesTotal` properties are available on the `Sound` object as well. The example above simply shows messages about the sound loading progress, but you can easily use the `bytesLoaded` and `bytesTotal` values to update progress bar components, such as the ones that come with the Adobe Flex 2 framework or the Flash authoring tool.

This example also shows how an application can recognize and respond to an error when loading sound files. For example, if a sound file with the given filename cannot be located, an `Event.IO_ERROR` event is dispatched by the `Sound` object. In the previous code, the `onIOError()` method executes and displays a brief error message when an error occurs.

## Working with embedded sounds

Using embedded sounds, instead of loading sound from an external file, is most useful for small sounds that are used as indicators within your application's user interface, such as sounds that play when buttons are clicked.

When you embed a sound file in your application, the size of the resulting SWF file increases by the size of the sound file. In other words, embedding large sound files in your application can increase the size of your SWF file to an undesirable size.

The exact method of embedding a sound file into your application's SWF file varies according to your development environment.

## Using an embedded sound file in Flash

The Flash authoring tool lets you import sounds in a number of sound formats and store them as symbols in the Library. You can then assign them to frames in the timeline or to the frames of a button state, use them with Behaviors, or use them directly in ActionScript code. This section describes how to use embedded sounds in ActionScript code with the Flash authoring tool. For information about the other ways to use embedded sounds in Flash, see “Importing Sounds” in *Using Flash*.

### To embed a sound file in a Flash movie:

1. Select File > Import > Import to Library, and then select a sound file and import it.
2. Right-click the name of the imported file in the Library panel, and select Properties. Click the Export for ActionScript checkbox.
3. In the Class field, enter a name to use when referring to this embedded sound in ActionScript. By default, it will use the name of the sound file in this field. If the filename includes a period, as in the name “DrumSound.mp3”, you must change it to something like “DrumSound”; ActionScript does not allow a period character in a class name. The Base Class field should still show `flash.media.Sound`.
4. Click OK. You might see a dialog box saying that a definition for this class could not be found in the classpath. Click OK and continue. If you entered a class name that doesn’t match the name of any of the classes in your application’s classpath, a new class that inherits from the `flash.media.Sound` class is automatically generated for you.
5. To use the embedded sound, you reference the class name for that sound in ActionScript. For example, the following code starts by creating a new instance of the automatically generated `DrumSound` class:

```
var drum:DrumSound = new DrumSound();  
var channel:SoundChannel = drum.play();
```

`DrumSound` is a subclass of the `flash.media.Sound` class so it inherits the `Sound` class’s methods and properties, including the `play()` method as shown above.

## Working with streaming sound files

When a sound file or video file is playing back while its data is still being loaded, it is said to be *streaming*. External sound files that are loaded from a remote server are often streamed so that the user doesn’t have to wait for all the sound data to load before listening to the sound.

The `SoundMixer.bufferTime` property represents the number of milliseconds of sound data that Flash Player should gather before letting the sound play. In other words, if the `bufferTime` property is set to 5000, Flash Player loads at least 5000 milliseconds worth of data from the sound file before the sound begins to play. The default `SoundMixer.bufferTime` value is 1000.

Your application can override the global `SoundMixer.bufferTime` value for an individual sound by explicitly specifying a new `bufferTime` value when loading the sound. To override the default buffer time, first create a new instance of the `SoundLoaderContext` class, set its `bufferTime` property, and then pass it as a parameter to the `Sound.load()` method, as shown below:

```
import flash.media.Sound;
import flash.media.SoundLoaderContext;
import flash.net.URLRequest;

var s:Sound = new Sound();
var req:URLRequest = new URLRequest("bigSound.mp3");
var context:SoundLoaderContext = new SoundLoaderContext(8000, true);
s.load(req, context);
s.play();
```

As playback continues, Flash Player tries to keep the sound buffer at the same size or greater. If the sound data loads faster than the playback speed, playback will continue without interruption. However, if the data loading rate slows down because of network limitations, the playhead could reach the end of the sound buffer. If this happens, playback is suspended, though it automatically resumes once more sound data has been loaded.

To find out if playback is suspended because Flash Player is waiting for data to load, use the `Sound.isBuffering` property.

## Playing sounds

Playing a loaded sound can be as simple as calling the `Sound.play()` method for a `Sound` object, as follows:

```
var snd:Sound = new Sound(new URLRequest("smallSound.mp3"));
snd.play();
```

When playing back sounds using ActionScript 3.0, you can perform the following operations:

- Play a sound from a specific starting position
- Pause a sound and resume playback from the same position later
- Know exactly when a sound finishes playing
- Track the playback progress of a sound

- Change volume or panning while a sound plays

To perform these operations during playback, use the `SoundChannel`, `SoundMixer`, and `SoundTransform` classes.

The `SoundChannel` class controls the playback of a single sound. The `SoundChannel.position` property can be thought of as a playhead, indicating the current point in the sound data that's being played.

When an application calls the `Sound.play()` method, a new instance of the `SoundChannel` class is created to control the playback.

Your application can play a sound from a specific starting position by passing that position, in terms of milliseconds, as the `startTime` parameter of the `Sound.play()` method. It can also specify a fixed number of times to repeat the sound in rapid succession by passing a numeric value in the `loops` parameter of the `Sound.play()` method.

When the `Sound.play()` method is called with both a `startTime` parameter and a `loops` parameter, the sound is played back repeatedly from the same starting point each time, as shown in the following code:

```
var snd:Sound = new Sound(new URLRequest("repeatingSound.mp3"));
snd.play(1000, 3);
```

In this example, the sound is played from a point one second after the start of the sound, three times in succession.

## Pausing and resuming a sound

If your application plays long sounds, like songs or podcasts, you probably want to let users pause and resume the playback of those sounds. A sound cannot literally be paused during playback in `ActionScript`; it can only be stopped. However, a sound can be played starting from any point. You can record the position of the sound at the time it was stopped, and then replay the sound starting at that position later.

For example, let's say your code loads and plays a sound file like this:

```
var snd:Sound = new Sound(new URLRequest("bigSound.mp3"));
var channel:SoundChannel = snd.play();
```

While the sound plays, the `SoundChannel.position` property indicates the point in the sound file that is currently being played. Your application can store the position value before stopping the sound from playing, as follows:

```
var pausePosition:int = channel.position;
channel.stop();
```

To resume playing the sound, pass the previously stored position value to restart the sound from the same point it stopped at before.

```
channel = snd.play(pausePosition);
```

## Monitoring playback

Your application might want to know when a sound stops playing so it can start playing another sound, or clean up some resources used during the previous playback. The `SoundChannel` class dispatches an `Event.SOUND_COMPLETE` event when its sound finishes playing. Your application can listen for this event and take appropriate action, as shown below:

```
import flash.events.Event;
import flash.media.Sound;
import flash.net.URLRequest;

var snd:Sound = new Sound("smallSound.mp3");
var channel:SoundChannel = snd.play();
s.addEventListener(Event.SOUND_COMPLETE, onPlaybackComplete);

public function onPlaybackComplete(event:Event)
{
    trace("The sound has finished playing.");
}
```

The `SoundChannel` class does not dispatch progress events during playback. To report on playback progress, your application can set up its own timing mechanism and track the position of the sound playback.

To calculate what percentage of a sound has been played, you can divide the value of the `SoundChannel.position` property by the length of the sound data that's being played:

```
var playbackPercent:uint = 100 * (channel.position / snd.length);
```

However, this code only reports accurate playback percentages if the sound data was fully loaded before playback began. The `Sound.length` property shows the size of the sound data that is currently loaded, not the eventual size of the entire sound file. To track the playback progress of a streaming sound that is still loading, your application should estimate the eventual size of the full sound file and use that value in its calculations. You can estimate the eventual length of the sound data using the `bytesLoaded` and `bytesTotal` properties of the `Sound` object, as follows:

```
var estimatedLength:int =
    Math.ceil(snd.length / (snd.bytesLoaded / snd.bytesTotal));
var playbackPercent:uint = 100 * (channel.position / estimatedLength);
```

The following code loads a larger sound file and uses the `Event.ENTER_FRAME` event as its timing mechanism for showing playback progress. It periodically reports on the playback percentage, which is calculated as the current position value divided by the total length of the sound data:

```
import flash.events.Event;
import flash.media.Sound;
import flash.net.URLRequest;

var snd:Sound = new Sound();
var req:URLRequest = new
    URLRequest("http://av.adobe.com/podcast/csbu_dev_podcast_epi_2.mp3");
snd.load(req);

var channel:SoundChannel;
channel = snd.play();
addEventListener(Event.ENTER_FRAME, onEnterFrame);
snd.addEventListener(Event.SOUND_COMPLETE, onPlaybackComplete);

function onEnterFrame(event:Event):void
{
    var estimatedLength:int =
        Math.ceil(snd.length / (snd.bytesLoaded / snd.bytesTotal));
    var playbackPercent:uint =
        Math.round(100 * (channel.position / estimatedLength));
    trace("Sound playback is " + playbackPercent + "% complete.");
}

function onPlaybackComplete(event:Event)
{
    trace("The sound has finished playing.");
    removeEventListener(Event.ENTER_FRAME, onEnterFrame);
}
```

After the sound data starts loading, this code calls the `snd.play()` method and stores the resulting `SoundChannel` object in the `channel` variable. Then it adds an event listener to the main application for the `Event.ENTER_FRAME` event and another event listener to the `SoundChannel` object for the `Event.SOUND_COMPLETE` event that occurs when playback is complete.

Each time the application reaches a new frame in its animation, the `onEnterFrame()` method is called. The `onEnterFrame()` method estimates the total length of the sound file based on the amount of data that has already been loaded, and then it calculates and displays the current playback percentage.



When the entire sound has been played, the `onPlaybackComplete()` method executes, removing the event listener for the `Event.ENTER_FRAME` event so that it doesn't try to display progress updates after playback is done.

The `Event.ENTER_FRAME` event can be dispatched many times per second. In some cases, you won't want to display playback progress that frequently. In those cases, your application can set up its own timing mechanism using the `flash.util.Timer` class; see [“Working with dates and times” on page 191](#).

## Stopping streaming sounds

There is a quirk in the playback process for sounds that are streaming—that is, for sounds that are still loading while they are being played. When your application calls the `SoundChannel.stop()` method on a `SoundChannel` instance that is playing back a streaming sound, the sound playback stops for one frame, and then on the next frame, it restarts from the beginning of the sound. This occurs because the sound loading process is still underway. To stop both the loading and the playback of a streaming sound, call the `Sound.close()` method.

# Security considerations when loading and playing sounds

Your application's ability to access sound data can be limited according to the Flash Player security model. Each sound is subject to the restrictions of two different security sandboxes, the sandbox for the content itself (the “content sandbox”), and the sandbox for the application or object that loads and plays the sound (the “owner sandbox”). For more information about the Flash Player security model in general, and the definition of sandboxes, see [“Flash Player security” on page 757](#).

The content sandbox controls whether detailed sound data can be extracted from the sound using the `id3` property or the `SoundMixer.computeSpectrum()` method. It doesn't restrict the loading or playing of the sound file itself.

The domain of origin of the sound file defines the security limitations of the content sandbox. Generally, if a sound file is located in the same domain or folder as the SWF file of the application or object that loads it, the application or object will have full access to that sound file. If the sound comes from a different domain than the application does, it can still be brought within the content sandbox by using a cross-domain policy file.

Your application can pass a `SoundLoaderContext` object with a `checkPolicyFile` property as a parameter to the `Sound.load()` method. Setting the `checkPolicyFile` property to `true` tells Flash Player to look for a cross-domain policy file on the server from which the sound is loaded. If a cross-domain policy file exists, and it grants access to the domain of the loading SWF file, the SWF file can load the sound file, access the `id3` property of the `Sound` object, and call the `SoundMixer.computeSpectrum()` method for loaded sounds.

The owner sandbox controls local playback of the sounds. The application or object that starts playing a sound defines the owner sandbox.

The `SoundMixer.stopAll()` method silences the sounds in all `SoundChannel` objects that are currently playing, as long as they meet the following criteria:

- The sounds were started by objects within the same owner sandbox.
- The sounds are from a source with a cross-domain policy file that grants access to the domain of the application or object that calls the `SoundMixer.stopAll()` method.

To find out if the `SoundMixer.stopAll()` method will indeed stop all playing sounds, your application can call the `SoundMixer.areSoundsInaccessible()` method. If that method returns a value of `true`, some of the sounds being played are outside the control of the current owner sandbox and will not be stopped by the `SoundMixer.stopAll()` method.

The `SoundMixer.stopAll()` method also stops the playhead from continuing for all sounds that were loaded from external files. However, sounds that are embedded in FLA files and attached to frames in the timeline using the Flash Authoring tool might start playing again if the animation moves to a new frame.

# Controlling sound volume and panning

An individual `SoundChannel` object controls both the left and the right stereo channels for a sound. If an mp3 sound is a monaural sound, the left and right stereo channels of the `SoundChannel` object will contain identical waveforms.

You can find out the amplitude of each stereo channel of the sound being played using the `leftPeak` and `rightPeak` properties of the `SoundChannel` object. These properties show the peak amplitude of the sound waveform itself. They do not represent the actual playback volume. The actual playback volume is a function of the amplitude of the sound wave and the volume values set in the `SoundChannel` object and the `SoundMixer` class.

The `pan` property of a `SoundChannel` object can be used to specify a different volume level for each of the left and right channels during playback. The `pan` property can have a value ranging from -1 to 1, where -1 means the left channel plays at top volume while the right channel is silent, and 1 means the right channel plays at top volume while the left channel is silent. Numeric values in between -1 and 1 set proportional values for the left and right channel values, and a value of 0 means that both channels play at a balanced, mid-volume level.

The following code example creates a `SoundTransform` object with a volume value of 0.6 and a pan value of -1 (top left channel volume and no right channel volume). It passes the `SoundTransform` object as a parameter to the `play()` method, which applies that `SoundTransform` object to the new `SoundChannel` object that is created to control the playback.

```
var snd:Sound = new Sound(new URLRequest("bigSound.mp3"));
var trans:SoundTransform = new SoundTransform(0.6, -1);
var channel:SoundChannel = snd.play(0, 1, trans);
```

You can alter the volume and panning while a sound is playing by setting the `pan` or `volume` properties of a `SoundTransform` object and then applying that object as the `soundTransform` property of a `SoundChannel` object.

You can also set global volume and pan values for all sounds at once using the `soundTransform` property of the `SoundMixer` class, as the following example shows:

```
SoundMixer.soundTransform = new SoundTransform(1, -1);
```

You can also use a `SoundTransform` object to set volume and pan values for a `Microphone` object (see [“Capturing sound input” on page 617](#)) and for `Sprite` objects and `SimpleButton` objects.

The following example alternates the panning of the sound from the left channel to the right channel and back while the sound plays.

```
import flash.events.Event;
import flash.media.Sound;
import flash.media.SoundChannel;
import flash.media.SoundMixer;
import flash.net.URLRequest;

var snd:Sound = new Sound();
var req:URLRequest = new URLRequest("bigSound.mp3");
snd.load(req);

var panCounter:Number = 0;

var trans:SoundTransform;
trans = new SoundTransform(1, 0);
var channel:SoundChannel = snd.play(0, 1, trans);
channel.addEventListener(Event.SOUND_COMPLETE, onPlaybackComplete);

addEventListener(Event.ENTER_FRAME, onEnterFrame);

function onEnterFrame(event:Event):void
{
    trans.pan = Math.sin(panCounter);
    channel.soundTransform = trans; // or SoundMixer.soundTransform = trans;
    panCounter += 0.05;
}

function onPlaybackComplete(event:Event):void
{
    removeEventListener(Event.ENTER_FRAME, onEnterFrame);
}
```

This code starts by loading a sound file and then creating a new `SoundTransform` object with volume set to 1 (full volume) and pan set to 0 (evenly balanced between left and right). Then it calls the `snd.play()` method, passing the `SoundTransform` object as a parameter.

While the sound plays, the `onEnterFrame()` method executes repeatedly. The `onEnterFrame()` method uses the `Math.sin()` function to generate a value between -1 and 1, a range that corresponds to the acceptable values of the `SoundTransform.pan` property. The `SoundTransform` object's pan property is set to the new value, and then the channel's `soundTransform` property is set to use the altered `SoundTransform` object.

To run this example, replace the filename `bigSound.mp3` with the name of a local mp3 file. Then run the example. You should hear the left channel volume getting louder while the right channel volume gets softer, and vice versa.

In this example, the same effect could be achieved by setting the `soundTransform` property of the `SoundMixer` class. However, that would affect the panning of all sounds currently playing, not just the single sound being played by this `SoundChannel` object.

## Working with sound metadata

Sound files that use the mp3 format can contain additional data about the sound in the form of ID3 tags.

Not every mp3 file contains ID3 metadata. When a `Sound` object loads an mp3 sound file, it dispatches an `Event.ID3` event if the sound file contains ID3 metadata. To prevent run-time errors, your application should wait to receive the `Event.ID3` event before accessing the `Sound.id3` property for a loaded sound.

The following code shows how to recognize when the ID3 metadata for a sound file has been loaded:

```
import flash.events.Event;
import flash.media.ID3Info;
import flash.media.Sound;

var s:Sound = new Sound();
s.addEventListener(Event.ID3, onID3InfoReceived);
s.load("mySound.mp3");

function onID3InfoReceived(event:Event)
{
    var id3:ID3Info = event.target.id3;

    trace("Received ID3 Info:");
    for (var propName:String in id3)
    {
        trace(propName + " = " + id3[propName]);
    }
}
```

This code starts by creating a `Sound` object and telling it to listen for the `Event.ID3` event. When the sound file's ID3 metadata is loaded, the `onID3InfoReceived()` method is called. The target of the `Event` object that is passed to the `onID3InfoReceived()` method is the original `Sound` object, so the method then gets the `Sound` object's `id3` property and then iterates through all of its named properties to trace their values.

# Accessing raw sound data

The `SoundMixer.computeSpectrum()` method lets an application read the raw sound data for the waveform that is currently being played. If more than one `SoundChannel` object is currently playing the `SoundMixer.computeSpectrum()` method shows the combined sound data of every `SoundChannel` object mixed together.

The sound data is returned as a `ByteArray` object containing 512 bytes of data, each of which contains a floating point value between -1 and 1. These values represent the amplitude of the points in the sound waveform being played. The values are delivered in two groups of 256, the first group for the left stereo channel and the second group for the right stereo channel.

The `SoundMixer.computeSpectrum()` method returns frequency spectrum data rather than waveform data if the `FFTMode` parameter is set to `true`. The frequency spectrum shows amplitude arranged by sound frequency, from lowest frequency to highest. A Fast Fourier Transform (FFT) is used to convert the waveform data into frequency spectrum data. The resulting frequency spectrum values range from 0 to roughly 1.414 (the square root of 2).

The following diagram compares the data returned from the `computeSpectrum()` method when the `FFTMode` parameter is set to `true` and when it is set to `false`. The sound whose data was used for this diagram contains a loud bass sound in the left channel and a drum hit sound in the right channel.

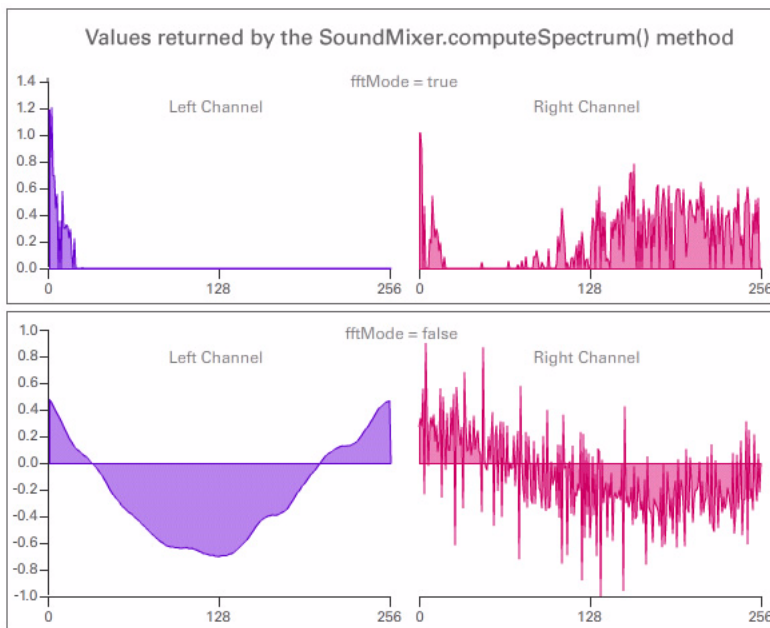

The `computeSpectrum()` method can also return data that has been resampled at a lower bit rate. Generally, this results in smoother waveform data or frequency data at the expense of detail. The `stretchFactor` parameter controls the rate at which the `computeSpectrum()` method data is sampled. When the `stretchFactor` parameter is set to 0, the default, the sound data is sampled at a rate of 44.1 kHz. The rate is halved at each successive value of the `stretchFactor` parameter, so a value of 1 specifies a rate of 22.05 kHz, a value of 2 specifies a rate of 11.025 kHz, and so on. The `computeSpectrum()` method still returns 256 bytes per stereo channel when a higher `stretchFactor` value is used.

The `SoundMixer.computeSpectrum()` method has some limitations:

- Because sound data from a microphone or from RTMP streams do not pass through the global `SoundMixer` object, the `SoundMixer.computeSpectrum()` method will not return data from those sources.
- If one or more of the sounds being played come from sources outside the current content sandbox, security restrictions will cause the `SoundMixer.computeSpectrum()` method to throw an error. For more detail about the security limitations of the `SoundMixer.computeSpectrum()` method please see [“Security considerations when loading and playing sounds” on page 609](#) and [“Accessing loaded media as data” on page 783](#).

## Building a simple sound visualizer

The following example uses the `SoundMixer.computeSpectrum()` method to show a chart of the sound waveform that animates with each frame:

```
import flash.display.Graphics;
import flash.events.Event;
import flash.media.Sound;
import flash.media.SoundChannel;
import flash.media.SoundMixer;
import flash.net.URLRequest;

const PLOT_HEIGHT:int = 200;
const CHANNEL_LENGTH:int = 256;

var snd:Sound = new Sound();
var req:URLRequest = new URLRequest("bigSound.mp3");
snd.load(req);

var channel:SoundChannel;
channel = snd.play();
addEventListener(Event.ENTER_FRAME, onEnterFrame);
snd.addEventListener(Event.SOUND_COMPLETE, onPlaybackComplete);
```

```

var bytes:ByteArray = new ByteArray();

function onEnterFrame(event:Event):void
{
    SoundMixer.computeSpectrum(bytes, false, 0);

    var g:Graphics = this.graphics;

    g.clear();
    g.lineStyle(0, 0x6600CC);
    g.beginFill(0x6600CC);
    g.moveTo(0, PLOT_HEIGHT);

    var n:Number = 0;

    // left channel
    for (var i:int = 0; i < CHANNEL_LENGTH; i++)
    {
        n = (bytes.readFloat() * PLOT_HEIGHT);
        g.lineTo(i * 2, PLOT_HEIGHT - n);
    }
    g.lineTo(CHANNEL_LENGTH * 2, PLOT_HEIGHT);
    g.endFill();

    // right channel
    g.lineStyle(0, 0xCC0066);
    g.beginFill(0xCC0066, 0.5);
    g.moveTo(CHANNEL_LENGTH * 2, PLOT_HEIGHT);

    for (i = CHANNEL_LENGTH; i > 0; i--)
    {
        n = (bytes.readFloat() * PLOT_HEIGHT);
        g.lineTo(i * 2, PLOT_HEIGHT - n);
    }
    g.lineTo(0, PLOT_HEIGHT);
    g.endFill();
}

function onPlaybackComplete(event:Event)
{
    removeEventListener(Event.ENTER_FRAME, onEnterFrame);
}

```

This example first loads and plays a sound file and then listens for the `Event.ENTER_FRAME` event which will trigger the `onEnterFrame()` method while the sound plays. The `onEnterFrame()` method starts by calling the `SoundMixer.computeSpectrum()` method, which stores the sound wave data in the `bytes` `ByteArray` object.



The sound waveform is plotted using the vector drawing API. A `for` loop cycles through the first 256 data values, representing the left stereo channel, and draws a line from each point to the next using the `Graphics.lineTo()` method. A second `for` loop cycles through the next set of 256 values, plotting them in reverse order this time, from right to left. The resulting waveform plots can produce an interesting mirror-image effect, as shown in the following image.

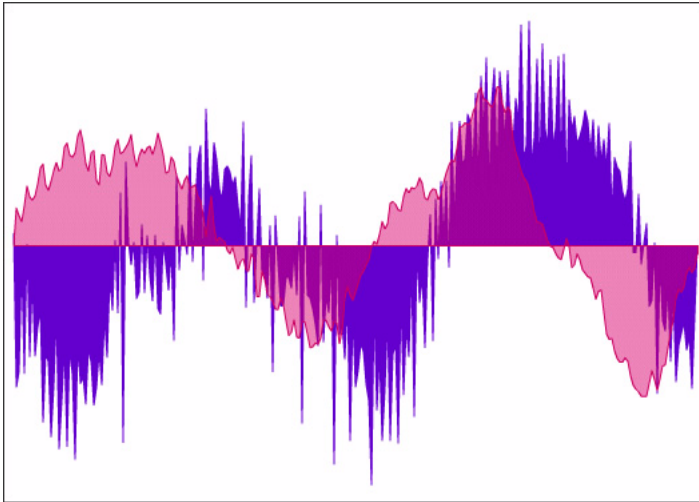

## Capturing sound input

The `Microphone` class lets your application connect to a microphone or other sound input device on the user's system and broadcast the input audio to that system's speakers or send the audio data to a remote server, such as the Flash Media Server.

### Accessing a microphone

The `Microphone` class does not have a constructor method. Instead, you use the static `Microphone.getMicrophone()` method to obtain a new `Microphone` instance, as shown below:

```
var mic:Microphone = Microphone.getMicrophone();
```

Calling the `Microphone.getMicrophone()` method without a parameter returns the first sound input device discovered on the user's system.

A system can have more than one sound input device attached to it. Your application can use the `Microphone.names` property to get an array of the names of all available sound input devices. Then it can call the `Microphone.getMicrophone()` method with an `index` parameter that matches the index value of a device's name in the array.

A system might not have a microphone or other sound input device attached to it. You can use the `Microphone.names` property or the `Microphone.getMicrophone()` method to check whether the user has a sound input device installed. If the user doesn't have a sound input device installed, the `names` array has a length of zero, and the `getMicrophone()` method returns a value of `null`.

When your application calls the `Microphone.getMicrophone()` method, Flash Player displays the Flash Player Settings dialog box, which prompts the user to either allow or deny Flash Player access to the camera and microphone on the system. After the user clicks on either the Allow button or the Deny button in this dialog, a `StatusEvent` is dispatched. The `code` property of that `StatusEvent` instance indicates whether microphone access was allowed or denied, as shown in this example:

```
import flash.media.Microphone;

var mic:Microphone = Microphone.getMicrophone();
mic.addEventListener(StatusEvent.STATUS, this.onMicStatus);

function onMicStatus(event:StatusEvent):void
{
    if (event.code == "Microphone.Unmuted")
    {
        trace("Microphone access was allowed.");
    }
    else if (event.code == "Microphone.Muted")
    {
        trace("Microphone access was denied.");
    }
}
```

The `StatusEvent.code` property will contain “`Microphone.Unmuted`” if access was allowed, or “`Microphone.Muted`” if access was denied.

**NOTE**

The `Microphone.muted` property is set to `true` or `false` when the user allows or denies microphone access, respectively. However the `muted` property is not set on the `Microphone` instance until the `StatusEvent` has been dispatched, so your application should also wait for the `StatusEvent.STATUS` event to be dispatched before checking the `Microphone.muted` property.

## Routing microphone audio to local speakers

Audio input from a microphone can be routed to the local system speakers by calling the `Microphone.setLoopback()` method with a parameter value of `true`.

When sound from a local microphone is routed to local speakers, there is a risk of creating an audio feedback loop, which can cause loud squealing sounds and can potentially damage sound hardware. Calling the `Microphone.setUseEchoSuppression()` method with a parameter value of `true` reduces, but does not completely eliminate, the risk that audio feedback will occur. Adobe recommends you always call `Microphone.setUseEchoSuppression(true)` before calling `Microphone.setLoopback(true)`, unless you are certain that the user is playing back the sound using headphones or something other than speakers.

The following code shows how to route the audio from a local microphone to the local system speakers:

```
var mic:Microphone = Microphone.getMicrophone();
mic.setUseEchoSuppression(true);
mic.setLoopBack(true);
```

## Altering microphone audio

Your application can alter the audio data that comes from a microphone in two ways. First, it can change the gain of the input sound, which effectively multiplies the input values by a specified amount to create a louder or quieter sound. The `Microphone.gain` property accepts numeric values between 0 and 100 inclusive. A value of 50 acts like a multiplier of one and specifies normal volume. A value of zero acts like a multiplier of zero and effectively silences the input audio. Values above 50 specify higher than normal volume.

Your application can also change the sample rate of the input audio. Higher sample rates increase sound quality, but they also create denser data streams that use more resources for transmission and storage. The `Microphone.rate` property represents the audio sample rate measured in kilohertz (kHz). The default sample rate is 8 kHz. You can set the `Microphone.rate` property to a value higher than 8 kHz if your microphone supports the higher rate. For example, setting the `Microphone.rate` property to a value of 11 sets the sample rate to 11 kHz; setting it to 22 sets the sample rate to 22 kHz and so on.

## Detecting microphone activity

To conserve bandwidth and processing resources, Flash Player tries to detect when no sound is being transmitted by a microphone. When the microphone's activity level stays below the silence level threshold for a period of time, Flash Player stops transmitting the audio input and dispatches a simple `ActivityEvent` instead.

Three properties of the `Microphone` class monitor and control the detection of activity:

- The read-only `activityLevel` property indicates the amount of sound the microphone is detecting, on a scale from 0 to 100.
- The `silenceLevel` property specifies the amount of sound needed to activate the microphone and dispatch an `ActivityEvent.ACTIVITY` event. The `silenceLevel` property also uses a scale from 0 to 100, and the default value is 10.
- The `silenceTimeout` property describes the number of milliseconds that the activity level must stay below the silence level, until an `ActivityEvent.ACTIVITY` event is dispatched to indicate that the microphone is now silent. The default `silenceTimeout` value is 2000.

Both the `Microphone.silenceLevel` property and the `Microphone.silenceTimeout` property are read only, but their values can be changed by using the `Microphone.setSilenceLevel()` method.

In some cases, the process of activating the microphone when new activity is detected can cause a short delay. Keeping the microphone active at all times can remove such activation delays. Your application can call the `Microphone.setSilenceLevel()` method with the `silenceLevel` parameter set to zero to tell Flash Player to keep the microphone active and keep gathering audio data, even when no sound is being detected. Conversely, setting the `silenceLevel` parameter to 100 prevents the microphone from being activated at all.

The following example displays information about the microphone and reports on activity events and status events dispatched by a `Microphone` object:

```
import flash.events.ActivityEvent;
import flash.events.StatusEvent;
import flash.media.Microphone;

var deviceArray:Array = Microphone.names;
trace("Available sound input devices:");
for (var i:int = 0; i < deviceArray.length; i++)
{
    trace("    " + deviceArray[i]);
}

var mic:Microphone = Microphone.getMicrophone();
mic.gain = 60;
mic.rate = 11;
mic.setUseEchoSuppression(true);
```

```

mic.setLoopBack(true);
mic.setSilenceLevel(5, 1000);

mic.addEventListener(ActivityEvent.ACTIVITY, this.onMicActivity);
mic.addEventListener(StatusEvent.STATUS, this.onMicStatus);

var micDetails:String = "Sound input device name: " + mic.name + '\n';
micDetails += "Gain: " + mic.gain + '\n';
micDetails += "Rate: " + mic.rate + " kHz" + '\n';
micDetails += "Muted: " + mic.muted + '\n';
micDetails += "Silence level: " + mic.silenceLevel + '\n';
micDetails += "Silence timeout: " + mic.silenceTimeout + '\n';
micDetails += "Echo suppression: " + mic.useEchoSuppression + '\n';
trace(micDetails);

function onMicActivity(event:ActivityEvent):void
{
    trace("activating=" + event.activating + ", activityLevel=" +
        mic.activityLevel);
}

function onMicStatus(event:StatusEvent):void
{
    trace("status: level=" + event.level + ", code=" + event.code);
}

```

When you run the above example, speak or makes noises into your system microphone and watch the resulting trace statements appear in a console or debug window.

## Sending audio to and from a media server

Additional audio capabilities are available when using ActionScript with a streaming media server such as Flash Media Server.

In particular, your application can attach a Microphone object to a NetStream object and transmit data directly from the user's microphone to the server. Audio data can also be streamed from the server to a Flash or Flex application and played back as part of a MovieClip or by using a Video object.

For more information, see the Flash Media Server documentation online at <http://livedocs.macromedia.com>.

# Example: Podcast Player

A podcast is a sound file that is distributed over the Internet, on demand or by subscription. Podcasts are usually published as part of a series, which is also called a podcast channel. Because podcast episodes can last anywhere from one minute to many hours, they are usually streamed while playing. Podcast episodes, which are also called items, are usually delivered in the mp3 file format. Video podcasts are also popular, but this sample application plays only audio podcasts that use mp3 files.

This example is not a full-featured podcast aggregator application. For example, it does not manage subscriptions to specific podcasts or remember which podcasts the user has listened to the next time the application is run. It could serve as a starting point for a more full-featured podcast aggregator.

The Podcast Player example illustrates the following ActionScript programming techniques:

- Reading an external RSS feed and parsing its XML content
- Creating a SoundFacade class to simplify loading and playback of sound files
- Displaying sound playback progress
- Pausing and resuming sound playback

To get the application files for this sample, see [www.adobe.com/go/learn\\_programmingAS3samples\\_flash](http://www.adobe.com/go/learn_programmingAS3samples_flash). The Podcast Player application files can be found in the folder Samples/PodcastPlayer. The application consists of the following files:

File	Description
PodcastPlayer.mxml or PodcastPlayer.fla	The user interface for the application for Flex (MXML) or Flash (FLA).
RSSBase.as	A base class that provides common properties and methods for the RSSChannel class and the RSSItem class.
RSSChannel.as	An ActionScript class that holds data about an RSS channel.
RSSItem.as	An ActionScript class that holds data about an RSS item.
SoundFacade.as	The main ActionScript class for the application. It encapsulates the methods and events of the Sound class and the SoundChannel class and adds support for pausing and resuming playback.

---

File	Description
URLService.as	An ActionScript class that retrieves data from a remote URL.
playerconfig.xml	An XML file containing a list of RSS feeds that represent podcast channels.

---

## Reading RSS data for a podcast channel

The Podcast Player application starts by reading information about a number of podcast channels and their episodes:

1. First, the application reads an XML configuration file that contains a list of podcast channels and displays the list of channels to the user.
2. When the user selects one of the podcast channels, it reads the RSS feed for the channel and displays a list of the channel episodes.

This example uses the `URLLoader` utility class to retrieve text-based data from a remote location or a local file. The Podcast Player first creates a `URLLoader` object to get a list of RSS feeds in XML format from the `playerconfig.xml` file. Next, when the user selects a specific feed from the list, a new `URLLoader` object is created to read the RSS data from that feed's URL.

## Simplifying sound loading and playback using the SoundFacade class

The ActionScript 3.0 sound architecture is powerful but complex. Applications that only need basic sound loading and playback features can use a class that hides some of the complexity by providing a simpler set of method calls and events. In the world of software design patterns, such a class is called a *facade*.

The `SoundFacade` class presents a single interface for performing the following tasks:

- Loading sound files using a `Sound` object, a `SoundLoaderContext` object, and the `SoundMixer` class
- Playing sound files using the `Sound` object and the `SoundChannel` object
- Dispatching playback progress events
- Pausing and resuming playback of the sound using the `Sound` object and the `SoundChannel` object

The `SoundFacade` class tries to offer most of the functionality of the ActionScript sound classes with less complexity.

The following code shows the class declaration, the class properties, and the `SoundFacade()` constructor method:

```
public class SoundFacade extends EventDispatcher
{
    public var s:Sound;
    public var sc:SoundChannel;
    public var url:String;
    public var bufferTime:int = 1000;

    public var isLoading:Boolean = false;
    public var isReadyToPlay:Boolean = false;
    public var isPlaying:Boolean = false;
    public var isStreaming:Boolean = true;
    public var autoLoad:Boolean = true;
    public var autoPlay:Boolean = true;

    public var pausePosition:int = 0;

    public static const PLAY_PROGRESS:String = "playProgress";
    public var progressInterval:int = 1000;
    public var playTimer:Timer;

    public function SoundFacade(soundUrl:String, autoLoad:Boolean = true,
                                autoPlay:Boolean = true, streaming:Boolean = true,
                                bufferTime:int = -1):void
    {
        this.url = soundUrl;

        // Sets Boolean values that determine the behavior of this object
        this.autoLoad = autoLoad;
        this.autoPlay = autoPlay;
        this.isStreaming = streaming;

        // Defaults to the global bufferTime value
        if (bufferTime < 0)
        {
            bufferTime = SoundMixer.bufferTime;
        }

        // Keeps buffer time reasonable, between 0 and 30 seconds
        this.bufferTime = Math.min(Math.max(0, bufferTime), 30000);

        if (autoLoad)
        {
            load();
        }
    }
}
```



The `SoundFacade` class extends the `EventDispatcher` class so that it can dispatch its own events. The class code first declares properties for a `Sound` object and a `SoundChannel` object. The class also stores the value of the URL of the sound file and a `bufferTime` property to use when streaming the sound. In addition, it accepts some Boolean parameter values that affect the loading and playback behavior:

- The `autoLoad` parameter tells the object that sound loading should start as soon as this object is created.
- The `autoPlay` parameter indicates that sound playing should start as soon as enough sound data has been loaded. If this is a streaming sound, playback will begin as soon as enough data, as specified by the `bufferTime` property, has loaded.
- The `streaming` parameter indicates that this sound file can start playing before loading has completed.

The `bufferTime` parameter defaults to a value of -1. If the constructor method detects a negative value in the `bufferTime` parameter, it sets the `bufferTime` property to the value of `SoundMixer.bufferTime`. This lets the application default to the global `SoundMixer.bufferTime` value as desired.

If the `autoLoad` parameter is set to `true`, the constructor method immediately calls the following `load()` method to start loading the sound file:

```
public function load():void
{
    if (this.isPlaying)
    {
        this.stop();
        this.s.close();
    }
    this.isLoading = false;

    this.s = new Sound();

    this.s.addEventListener(ProgressEvent.PROGRESS, onLoadProgress);
    this.s.addEventListener(Event.OPEN, onLoadOpen);
    this.s.addEventListener(Event.COMPLETE, onLoadComplete);
    this.s.addEventListener(Event.ID3, onID3);
    this.s.addEventListener(IOErrorEvent.IO_ERROR, onIOError);
    this.s.addEventListener(SecurityErrorEvent.SECURITY_ERROR, onIOError);

    var req:URLRequest = new URLRequest(this.url);

    var context:SoundLoaderContext = new SoundLoaderContext(this.bufferTime,
                                                            true);
    this.s.load(req, this.slc);
}
```

The `load()` method creates a new `Sound` object and then adds listeners for all of the important sound events. Then it tells the `Sound` object to load the sound file, using a `SoundLoaderContext` object to pass in the `bufferTime` value.

Because the `url` property can be changed, a `SoundFacade` instance can be used to play different sound files in succession: simply change the `url` property and call the `load()` method, and the new sound file will be loaded.

The following three event listener methods show how the `SoundFacade` object tracks loading progress and decides when to start playing the sound:

```
public function onLoadOpen(event:Event):void
{
    if (this.isStreaming)
    {
        this.isReadyToPlay = true;
        if (autoPlay)
        {
            this.play();
        }
    }
    this.dispatchEvent(event.clone());
}

public function onLoadProgress(event:ProgressEvent):void
{
    this.dispatchEvent(event.clone());
}

public function onLoadComplete(event:Event):void
{
    this.isReadyToPlay = true;
    this.isLoaded = true;
    this.dispatchEvent(evt.clone());

    if (autoPlay && !isPlaying)
    {
        play();
    }
}
```

The `onLoadOpen()` method executes when sound loading starts. If the sound can be played in streaming mode, the `onLoadComplete()` method sets the `isReadyToPlay` flag to `true` right away. The `isReadyToPlay` flag determines whether the application can start the sound playing, perhaps in response to a user action like clicking a `Play` button. The `SoundChannel` class manages the buffering of sound data, so there is no need to explicitly check whether enough data has been loaded before calling the `play()` method.

The `onLoadProgress()` method executes periodically during the loading process. It simply dispatches a clone of its `ProgressEvent` object for use by code that uses this `SoundFacade` object.

When the sound data has been fully loaded the `onLoadComplete()` method executes, calling the `play()` method for non-streaming sounds if needed. The `play()` method itself is shown below.

```
public function play(pos:int = 0):void
{
    if (!this.isPlaying)
    {
        if (this.isReadyToPlay)
        {
            this.sc = this.s.play(pos);
            this.sc.addEventListener(Event.SOUND_COMPLETE, onPlayComplete);
            this.isPlaying = true;

            this.playTimer = new Timer(this.progressInterval);
            this.playTimer.addEventListener(TimerEvent.TIMER, onPlayTimer);
            this.playTimer.start();
        }
    }
}
```

The `play()` method calls the `Sound.play()` method if the sound is ready to play. The resulting `SoundChannel` object is stored in the `sc` property. The `play()` method then creates a `Timer` object that will be used to dispatch playback progress events at regular intervals.

## Displaying playback progress

Creating a `Timer` object to drive playback monitoring is complex operation that you should only have to code once. Encapsulating this `Timer` logic in a reusable class like the `SoundFacade` class lets applications listen to the same kinds of progress events when a sound is loading and when it is playing.

The `Timer` object that is created by the `SoundFacade.play()` method dispatches a `TimerEvent` instance every second. The following `onPlayTimer()` method executes whenever a new `TimerEvent` arrives:

```
public function onPlayTimer(event:TimerEvent):void
{
    var estimatedLength:int =
        Math.ceil(this.s.length / (this.s.bytesLoaded / this.s.bytesTotal));
    var progEvent:ProgressEvent =
        new ProgressEvent(PLAY_PROGRESS, false, false, this.sc.position,
            estimatedLength);
```

```
        this.dispatchEvent(progEvent);
    }
```

The `onPlayTimer()` method implements the size estimation technique described in the section [“Monitoring playback” on page 607](#). Then it creates a new `ProgressEvent` instance with an event type of `SoundFacade.PLAY_PROGRESS`, with the `bytesLoaded` property set to the current position of the `SoundChannel` object and the `bytesTotal` property set to the estimated length of the sound data.

## Pausing and resuming playback

The `SoundFacade.play()` method shown previously accepts a `pos` parameter corresponding to a starting position in the sound data. If the `pos` value is zero, the sound starts playing from the beginning.

The `SoundFacade.stop()` method also accepts a `pos` parameter as shown here:

```
public function stop(pos:int = 0):void
{
    if (this.isPlaying)
    {
        this.pausePosition = pos;
        this.sc.stop();
        this.playTimer.stop();
        this.isPlaying = false;
    }
}
```

Whenever the `SoundFacade.stop()` method is called, it sets the `pausePosition` property so that the application knows where to position the playhead if the user wants to resume playback of the same sound.

The `SoundFacade.pause()` and `SoundFacade.resume()` methods shown below invoke the `SoundFacade.stop()` and `SoundFacade.play()` methods respectively, passing a `pos` parameter value each time.

```
public function pause():void
{
    stop(this.sc.position);
}

public function resume():void
{
    play(this.pausePosition);
}
```

The `pause()` method passes the current `SoundChannel.position` value to the `play()` method, which stores that value in the `pausePosition` property. The `resume()` method starts playing the same sound again using the `pausePosition` value as the starting point.

## Extending the Podcast Player example

This example presents a bare-bones Podcast Player that showcases the use of the reusable `SoundFacade` class. You could add other features to enhance the usefulness of this application, including the following:

- Store the list of feeds and usage information about each episode in a `SharedObject` instance that can be used the next time the user runs the application.
- Let the user add his or her own RSS feeds to the list of podcast channels.
- Remember the position of the playhead when the user stops or leaves an episode, so it can be restarted from that point next time the user runs the application.
- Download mp3 files of episodes for listening offline, when the user is not connected to the Internet.
- Add subscription features that periodically check for new episodes in a podcast channel and update the episode list automatically.
- Add podcast searching and browsing functionality using an API from a podcast hosting service like Odeo.com.



This chapter describes how to create interactivity by using ActionScript 3.0 to respond to user activity. It discusses keyboard and mouse events, and then proceeds to more advanced topics, including customization of the context menu and focus management. This chapter concludes with WordSearch, an example of an application that responds to mouse input.

Note that this chapter assumes that you are already familiar with the ActionScript 3.0 event model. For more information, see [Chapter 10, “Handling events,”](#) on page 313.

## Contents

<a href="#">Basics of user input</a> .....	631
<a href="#">Capturing keyboard input</a> .....	633
<a href="#">Capturing mouse input</a> .....	636
<a href="#">Example: WordSearch</a> .....	641

## Basics of user input

### Introduction to capturing user input

User interaction, whether by keyboard, mouse, camera, or a combination of these devices, is the foundation of interactivity. In ActionScript 3.0, identifying and responding to user interaction primarily involves listening to events.

The [InteractiveObject class](#), a subclass of the DisplayObject class, provides the common structure of events and functionality necessary for handling user interaction. You do not directly create an instance of the InteractiveObject class. Instead, display objects such as SimpleButton, Sprite, TextField, and various Flash and Flex components inherit their user interaction model from this class and therefore share a common structure. This means that the techniques you learn and the code you write to handle user interaction in an object derived from InteractiveObject are applicable to all the others.

The following typical user interaction tasks are described in this chapter:

- Capturing application-wide keyboard input
- Capturing keyboard input to a specific display object
- Capturing application-wide mouse actions
- Capturing mouse input to a specific display object
- Creating drag-and-drop interactivity
- Creating a custom mouse cursor (mouse pointer)
- Adding new behaviors to the context menu
- Managing focus

## Important concepts and terms

It's important to familiarize yourself with the following key user interaction terms before proceeding:

- **Character code:** A numeric code representing a character in the current character set (associated with a key being pressed on the keyboard). For example, “D” and “d” have different character codes even though they're created by the same key on a U.S. English keyboard.
- **Context menu:** The menu that appears when a user right-clicks or uses a particular keyboard-mouse combination. Context menu commands typically apply directly to what has been clicked. For example, a context menu for an image may contain a command to show the image in a separate window and a command to download it.
- **Focus:** The indication that a selected element is active and that it is the target of keyboard or mouse interaction.
- **Key code:** A numeric code corresponding to a physical key on the keyboard.

## Working through in-chapter examples

As you're working through the chapter, you may want to test some of the sample code listings for yourself. Because this chapter is about working with user input in ActionScript, essentially all the code listings in this chapter involve manipulating some type of display object—usually a text field or any `InteractiveObject` subclass. For the purposes of the examples, the display object either can be one that has been created and placed on the Stage in Adobe Flash CS3 Professional, or can be one that's created using ActionScript. Testing a sample involves viewing the result in Flash Player and interacting with the sample to see the effects of the code.



### To test the code listings in this chapter:

1. Create an empty Flash document.
2. Select a keyframe in the Timeline.
3. Open the Actions panel and copy the code listing into the Script pane.
4. Create an instance on the Stage:
  - If the code refers to a text field, use the Text tool to create a dynamic text field on the Stage.
  - Otherwise, create a button or movie clip symbol instance on the Stage.
5. Select the text field, button, or movie clip, and give it an instance name in the Property inspector. The name should match the name of the display object in the sample code—for example, if the code manipulates an object named `myDisplayObject`, name your Stage object `myDisplayObject` as well.
6. Run the program using `Control > Test Movie`.

On the screen, the display object is manipulated as specified in the code.

## Capturing keyboard input

Display objects that inherit their interaction model from the `InteractiveObject` class can respond to keyboard events by using event listeners. For example, you can place an event listener on the Stage to listen for and respond to keyboard input. In the following code, an event listener captures a key press, and the key name and key code properties are displayed:

```
function reportKeyDown(event:KeyboardEvent):void
{
    trace("Key Pressed: " + String.fromCharCode(event.charCode) +
        " (character code: " + event.charCode + ")");
}
stage.addEventListener(KeyboardEvent.KEY_DOWN, reportKeyDown);
```

Some keys, such as the Ctrl key, generate events even though they have no glyph representation.

In the previous code example, the keyboard event listener captured keyboard input for the entire Stage. You can also write an event listener for a specific display object on the Stage; this event listener is triggered when the object has the focus.

In the following example, keystrokes are reflected in the Output panel only when the user types inside the `TextField` instance. Holding the Shift key down temporarily changes the border color of the `TextField` to red.

This code assumes there is a `TextField` instance named `tf` on the Stage.

```
tf.border = true;
tf.type = "input";
tf.addEventListener(KeyboardEvent.KEY_DOWN, reportKeyDown);
tf.addEventListener(KeyboardEvent.KEY_UP, reportKeyUp);

function reportKeyDown(event:KeyboardEvent):void
{
    trace("Key Pressed: " + String.fromCharCode(event.charCode) +
        " (key code: " + event.keyCode + " character code: " +
        event.charCode + ")");
    if (event.keyCode == Keyboard.SHIFT) tf.borderColor = 0xFF0000;
}

function reportKeyUp(event:KeyboardEvent):void
{
    trace("Key Released: " + String.fromCharCode(event.charCode) +
        " (key code: " + event.keyCode + " character code: " +
        event.charCode + ")");
    if (event.keyCode == Keyboard.SHIFT)
    {
        tf.borderColor = 0x000000;
    }
}
```

The `TextField` class also reports a `textInput` event that you can listen for when a user enters text. For more information, see [“Capturing text input” on page 518](#).

## Understanding key codes and character codes

You can access the `keyCode` and `charCode` properties of a keyboard event to determine what key was pressed and then trigger other actions. The `keyCode` property is a numeric value that corresponds to the value of a key on the keyboard. The `charCode` property is the numeric value of that key in the current character set. (The default character set is UTF-8, which supports ASCII.)

The primary difference between the key code and character values is that a key code value represents a particular key on the keyboard (the 1 on a keypad is different than the 1 in the top row, but the key that generates “1” and the key that generates “!” are the same key) and the character value represents a particular character (the R and r characters are different).

NOTE

For the mappings between keys and their character code values in ASCII, see Appendix C, Keyboard Keys and Key Code Values, in *Learning ActionScript 2.0 in Adobe Flash*.

The mappings between keys and their key codes is dependent on the device and the operating system. For this reason, you should not use key mappings to trigger actions. Instead, you should use the predefined constant values provided by the `Keyboard` class to reference the appropriate `keyCode` properties. For example, instead of using the key mapping for the Shift key, use the `Keyboard.SHIFT` constant (as shown in the preceding code sample).

## Understanding KeyboardEvent precedence

As with other events, the keyboard event sequence is determined by the display object hierarchy and not the order in which `addEventListener()` methods are assigned in code.

For example, suppose you place a text field called `tf` inside a movie clip called `container` and add an event listener for a keyboard event to both instances, as the following example shows:

```
container.addEventListener(KeyboardEvent.KEY_DOWN, reportKeyDown);
container.tf.border = true;
container.tf.type = "input";
container.tf.addEventListener(KeyboardEvent.KEY_DOWN, reportKeyDown);

function reportKeyDown(event:KeyboardEvent):void
{
    trace(event.currentTarget.name + " hears key press: " +
        String.fromCharCode(event.charCode) + " (key code: " +
        event.keyCode + " character code: " + event.charCode + ")");
}
```

Because there is a listener on both the text field and its parent container, the `reportKeyDown()` function is called twice for every keystroke inside the `TextField`. Note that for each key pressed, the text field dispatches an event before the `container` movie clip dispatches an event.

The operating system and the web browser will process keyboard events before Adobe Flash Player. For example, in Microsoft Internet Explorer, pressing `Ctrl+W` closes the browser window before any contained SWF file dispatches a keyboard event.

# Capturing mouse input

Mouse clicks create mouse events that can be used to trigger interactive functionality. You can add an event listener to the Stage to listen for mouse events that occur anywhere within the SWF file. You can also add event listeners to objects on the Stage that inherit from InteractiveObject (for example, Sprite or MovieClip); these listeners are triggered when the object is clicked.

As with keyboard events, mouse events bubble. In the following example, because `square` is a child of the Stage, the event dispatches both from the sprite `square` as well as from the Stage object when the `square` is clicked:

```
var square:Sprite = new Sprite();
square.graphics.beginFill(0xFF0000);
square.graphics.drawRect(0,0,100,100);
square.graphics.endFill();
square.addEventListener(MouseEvent.CLICK, reportClick);
square.x =
square.y = 50;
addChild(square);

stage.addEventListener(MouseEvent.CLICK, reportClick);

function reportClick(event:MouseEvent):void
{
    trace(event.currentTarget.toString() +
        " dispatches MouseEvent. Local coords [" +
        event.localX + "," + event.localY + "] Stage coords [" +
        event.stageX + "," + event.stageY + "]);
}
```

In the previous example, notice that the mouse event contains positional information about the click. The `localX` and `localY` properties contain the location of the click on the lowest child in the display chain. For example, clicking at the top-left corner of `square` reports local coordinates of [0,0] because that is the registration point of `square`. Alternatively, the `stageX` and `stageY` properties refer to the global coordinates of the click on the Stage. The same click reports [50,50] for these coordinates, because `square` was moved to these coordinates. Both of these coordinate pairs can be useful depending on how you want to respond to user interaction.

The `MouseEvent` object also contains `altKey`, `ctrlKey`, and `shiftKey` Boolean properties. You can use these properties to check if the Alt, Ctrl, or Shift key is also being pressed at the time of the mouse click.

## Creating drag-and-drop functionality

Drag-and-drop functionality allows users to select an object while pressing the left mouse button, move the object to a new location on the screen, and then drop it at the new location by releasing the left mouse button. The following code shows an example of this:

```
import flash.display.Sprite;
import flash.events.MouseEvent;

var circle:Sprite = new Sprite();
circle.graphics.beginFill(0xFFCC00);
circle.graphics.drawCircle(0, 0, 40);

var target1:Sprite = new Sprite();
target1.graphics.beginFill(0xCCFF00);
target1.graphics.drawRect(0, 0, 100, 100);
target1.name = "target1";

var target2:Sprite = new Sprite();
target2.graphics.beginFill(0xCCFF00);
target2.graphics.drawRect(0, 200, 100, 100);
target2.name = "target2";

addChild(target1);
addChild(target2);
addChild(circle);

circle.addEventListener(MouseEvent.MOUSE_DOWN, mouseDown)

function mouseDown(event:MouseEvent):void
{
    circle.startDrag();
}
circle.addEventListener(MouseEvent.MOUSE_UP, mouseReleased);

function mouseReleased(event:MouseEvent):void
{
    circle.stopDrag();
    trace(circle.dropTarget.name);
}
```

For more details, see [“Creating drag-and-drop interaction” on page 396](#).

## Customizing the mouse cursor

The mouse cursor (mouse pointer) can be hidden or swapped for any display object on the Stage. To hide the mouse cursor, call the `Mouse.hide()` method. Customize the cursor by calling `Mouse.hide()`, listening to the Stage for the `MouseEvent.MOUSE_MOVE` event, and setting the coordinates of a display object (your custom cursor) to the `stageX` and `stageY` properties of the event. The following example illustrates a basic execution of this task:

```
var cursor:Sprite = new Sprite();
cursor.graphics.beginFill(0x000000);
cursor.graphics.drawCircle(0,0,20);
cursor.graphics.endFill();
addChild(cursor);

stage.addEventListener(MouseEvent.MOUSE_MOVE,redrawCursor);
Mouse.hide();

function redrawCursor(event:MouseEvent):void
{
    cursor.x = event.stageX;
    cursor.y = event.stageY;
}
```

## Customizing the context menu

Every object that inherits from the `InteractiveObject` class can have a unique context menu, which is displayed when a user right-clicks within the SWF file. Several commands are included by default, including `Forward`, `Back`, `Print`, `Quality`, and `Zoom`.

You can remove all the default commands from the menu, except for the `Settings` and `About` commands. Setting the Stage property `showDefaultContextMenu` to `false` removes these commands from the context menu.

To create a customized context menu for a specific display object, create a new instance of the `ContextMenu` class, call the `hideBuiltinItems()` method, and assign that instance to the `contextMenu` property of that `DisplayObject` instance. The following example provides a dynamically drawn square with a context menu command to change it to a random color:

```
var square:Sprite = new Sprite();
square.graphics.beginFill(0x000000);
square.graphics.drawRect(0,0,100,100);
square.graphics.endFill();
square.x =
square.y = 10;
addChild(square);
```

```

var menuItem:ContextMenuItems = new ContextMenuItem("Change Color");
menuItem.addEventListener(ContextMenuEvent.MENU_ITEM_SELECT,changeColor);
var customContextMenu:ContextMenu = new ContextMenu();
customContextMenu.hideBuiltinItems();
customContextMenu.customItems.push(menuItem);
square.contextMenu = customContextMenu;

function changeColor(event:ContextMenuEvent):void
{
    square.transform.colorTransform = getRandomColor();
}
function getRandomColor():ColorTransform
{
    return new ColorTransform(Math.random(), Math.random(),
        Math.random(),1,(Math.random() * 512) - 255,
        (Math.random() * 512) -255, (Math.random() * 512) - 255, 0);
}

```

## Managing focus

An interactive object can receive focus, either programmatically or through a user action. In both cases, setting the focus changes the object's `focus` property to `true`. Additionally, if the `tabEnabled` property is set to `true`, the user can pass focus from one object to another by pressing the Tab key. Note that the `tabEnabled` value is `false` by default, except in the following cases:

- For a `SimpleButton` object, the value is `true`.
- For a input text field, the value is `true`.
- For a `Sprite` or `MovieClip` object with `buttonMode` set to `true`, the value is `true`.

In each of these situations, you can add a listener for `FocusEvent.FOCUS_IN` or `FocusEvent.FOCUS_OUT` to provide additional behavior when focus changes. This is particularly useful for text fields and forms, but can also be used on sprites, movie clips, or any object that inherits from the `InteractiveObject` class. The following example shows how to enable focus cycling with the Tab key and how to respond to the subsequent focus event. In this case, each square changes color as it receives focus.

**NOTE**

The Flash authoring tool uses keyboard shortcuts to manage focus; therefore, to properly simulate focus management, SWF files should be tested in a browser rather than within Flash.

```

var rows:uint = 10;
var cols:uint = 10;
var rowSpacing:uint = 25;
var colSpacing:uint = 25;
var i:uint;

```

```

var j:uint;
for (i = 0; i < rows; i++)
{
    for (j = 0; j < cols; j++)
    {
        createSquare(j * colSpacing, i * rowSpacing, (i * cols) + j);
    }
}

function createSquare(startX:Number, startY:Number, tabNumber:uint):void
{
    var square:Sprite = new Sprite();
    square.graphics.beginFill(0x000000);
    square.graphics.drawRect(0, 0, colSpacing, rowSpacing);
    square.graphics.endFill();
    square.x = startX;
    square.y = startY;
    square.tabEnabled = true;
    square.tabIndex = tabNumber;
    square.addEventListener(FocusEvent.FOCUS_IN, changeColor);
    addChild(square);
}

function changeColor(event:FocusEvent):void
{
    e.target.transform.colorTransform = getRandomColor();
}

function getRandomColor():ColorTransform
{
    // Generate random values for the red, green, and blue color channels.
    var red:Number = (Math.random() * 512) - 255;
    var green:Number = (Math.random() * 512) - 255;
    var blue:Number = (Math.random() * 512) - 255;

    // Create and return a ColorTransform object with the random colors.
    return new ColorTransform(1, 1, 1, 1, red, green, blue, 0);
}

```



# Example: WordSearch

This example demonstrates user interaction by handling mouse events. Users build as many words as possible from a random grid of letters, spelling by moving horizontally or vertically in the grid, but never using the same letter twice. This example demonstrates the following features of ActionScript 3.0:

- Building a grid of components dynamically
- Responding to mouse events
- Maintaining a score based on user interaction

To get the application files for this sample, see [www.adobe.com/go/learn\\_programmingAS3samples\\_flash](http://www.adobe.com/go/learn_programmingAS3samples_flash). The WordSearch application files can be found in the folder Samples/WordSearch. The application consists of the following files:

File	Description
WordSearch.as	The class that provides the main functionality of the application.
WordSearch.fla	The main application file for Flash.
dictionary.txt	A file used to determine if spelled words are scorable and spelled correctly.

## Loading a dictionary

To create a game that involves finding words, a dictionary is needed. The example includes a text file called `dictionary.txt` that contains a list of words separated by carriage returns. After creating an array named `words`, the `loadDictionary()` function requests this file, and when it loads successfully, the file becomes a long string. You can parse this string into an array of words by using the `split()` method, breaking at each instance of a carriage return (character code 10). This parsing occurs in the `dictionaryLoaded()` function:

```
words = dictionaryText.split(String.fromCharCode(10));
```

## Creating the user interface

After the words have been stored, you can set up the user interface. Create two `Button` instances: one for submitting a word, and another for clearing a word that is currently being spelled. In each case, you must respond to user input by listening to the `MouseEvent.CLICK` event that the button broadcasts and then calling a function. In the `setupUI()` function, this code creates the listeners on the two buttons:

```
submitWordButton.addEventListener(MouseEvent.CLICK, submitWord);
clearWordButton.addEventListener(MouseEvent.CLICK, clearWord);
```

## Generating a game board

The game board is a grid of random letters. In the `generateBoard()` function, a two-dimensional grid is created by nesting one loop inside another. The first loop increments rows and the second increments the total number of columns per row. Each of the cells created by these rows and columns contains a button that represents a letter on the board.

```
private function generateBoard(startX:Number,
    startY:Number,
    totalRows:Number,
    totalCols:Number,
    buttonSize:Number):void
{
    buttons = new Array();
    var colCounter:uint;
    var rowCounter:uint;
    for (rowCounter = 0; rowCounter < totalRows; rowCounter++)
    {
        for (colCounter = 0; colCounter < totalCols; colCounter++)
        {
            var b:Button = new Button();
            b.x = startX + (colCounter*buttonSize);
            b.y = startY + (rowCounter*buttonSize);
            b.addEventListener(MouseEvent.CLICK, letterClicked);
            b.label = getRandomLetter().toUpperCase();
            b.setSize(buttonSize,buttonSize);
            b.name = "buttonRow"+rowCounter+"Col"+colCounter;
            addChild(b);

            buttons.push(b);
        }
    }
}
```

Although a listener is added for a `MouseEvent.CLICK` event on only one line, because it is in a for loop, it is assigned to each `Button` instance. Also, each button is assigned a name derived from its row and column position, which provides an easy way to reference the row and column of each button later in the code.

## Building words from user input

Words can be spelled by selecting letters that are vertically or horizontally adjacent, but never using the same letter twice. Each click generates a mouse event, at which point the word the user is spelling must be checked to ensure it properly continues from letters that have previously been clicked. If it is not, the previous word is removed and a new one is started. This check occurs in the `isLegalContinuation()` method.

```
private function isLegalContinuation(prevButton:Button,
    currButton:Button):Boolean
{
    var currButtonRow:Number = Number(currButton.name.charAt(currButton.name.
        indexOf("Row") + 3));
    var currButtonCol:Number =
        Number(currButton.name.charAt(currButton.name.indexOf("Col") + 3));
    var prevButtonRow:Number =
        Number(prevButton.name.charAt(prevButton.name.indexOf("Row") + 3));
    var prevButtonCol:Number =
        Number(prevButton.name.charAt(prevButton.name.indexOf("Col") + 3));

    return ((prevButtonCol == currButtonCol && Math.abs(prevButtonRow -
        currButtonRow) <= 1) ||
        (prevButtonRow == currButtonRow && Math.abs(prevButtonCol -
        currButtonCol) <= 1));
}
```

The `charAt()` and `indexOf()` methods of the `String` class retrieve the appropriate rows and columns from both the currently clicked button and the previously clicked button. The `isLegalContinuation()` method returns `true` if the row or column is unchanged and if the row or column that has been changed is within a single increment from the previous one. If you want to change the rules of the game and allow diagonal spelling, you can remove the checks for an unchanged row or column and the final line would look like this:

```
return (Math.abs(prevButtonRow - currButtonRow) <= 1) &&
    Math.abs(prevButtonCol - currButtonCol) <= 1));
```

## Checking word submissions

To complete the code for the game, mechanisms for checking word submissions and tallying the score are needed. The `searchForWord()` method contains both:

```
private function searchForWord(str:String):Number
{
    if (words && str)
    {
        var i:uint = 0
        for (i = 0; i < words.length; i++)
        {
            var thisWord:String = words[i];
            if (str == words[i])
            {
                return i;
            }
        }
        return -1;
    }
    else
    {
        trace("WARNING: cannot find words, or string supplied is null");
    }
    return -1;
}
```

This function loops through all of the words in the dictionary. If the user's word matches a word in the dictionary, its position in the dictionary is returned. The `submitWord()` method then checks the response and updates the score if the position is valid.

## Customization

At the beginning of the class are several constants. You can modify this game by modifying these variables. For example, you can change the amount of time available to play by increasing the `TOTAL_TIME` variable. You can also increase the `PERCENT_VOWELS` variable slightly to increase the likelihood of finding words.

# Networking and communication

This chapter explains how to enable your SWF file to communicate with external files and other Adobe Flash Player 9 instances. It also explains how to load data from external sources, send messages between a Java server and Flash Player, and perform file uploads and downloads using the `FileReference` and `FileReferenceList` classes.

## Contents

Basics of networking and communication .....	646
Working with external data .....	649
Connecting to other Flash Player instances .....	656
Socket connections .....	662
Storing local data .....	668
Working with file upload and download .....	671
Example: Building a Telnet client .....	682
Example: Uploading and downloading files .....	685

# Basics of networking and communication

## Introduction to networking and communication

When you build more complex ActionScript applications, you often need to communicate with server-side scripts, or load data from external XML or text files. The `flash.net` package contains classes to send and receive data across the Internet—for example, to load content from remote URLs, to communicate with other Flash Player instances, and to connect to remote websites.

In ActionScript 3.0, you can load external files with the `URLLoader` and `URLRequest` classes. You then use a specific class to access the data, depending on the type of data that was loaded. For instance, if the remote content is formatted as name-value pairs, you use the `URLVariables` class to parse the server results. Alternatively, if the file loaded using the `URLLoader` and `URLRequest` classes is a remote XML document, you can parse the XML document using the `XML` class's constructor, the `XMLDocument` class's constructor, or the `XMLDocument.parseXML()` method. This allows you to simplify your ActionScript code because the code for loading external files is the same whether you use the `URLVariables`, `XML`, or some other class to parse and work with the remote data.

The `flash.net` package also contains classes for other types of remote communication. These include the `FileReference` class for uploading and downloading files from a server, the `Socket` and `XMLSocket` classes that allow you to communicate directly with remote computers over socket connections, and the `NetConnection` and `NetStream` classes, which are used for communicating with Flash-specific server resources (such as Flash Media Server and Flash Remoting servers) as well as for loading video files.

Finally, the `flash.net` package includes classes for communication on the users' local computer. These include the `LocalConnection` class, which allows you to communicate between two or more SWF files running on a single computer, and the `SharedObject` class, which allows you to store data on a user's computer and retrieve it later when they return to your application.

## Common networking and communication tasks

The following list describes the most common things you'll want to do related to external communication from ActionScript; these tasks are described in this chapter:

- Loading data from an external file or server script
- Sending data to a server script
- Communicating with other local SWF files
- Working with binary socket connections

- Communicating with XML sockets
- Storing persistent local data
- Uploading files to a server
- Downloading files from a server to the user's machine

## Important concepts and terms

The following reference list contains important terms that you will encounter in this chapter:

- **External data:** Data that is stored in some form outside of the SWF file, and loaded into the SWF file when needed. This data could be stored in a file that's loaded directly, or stored in a database or other form that is retrieved by calling scripts or programs running on a server.
- **URL-encoded variables:** The URL-encoded format provides a way to represent several variables (pairs of variable names and values) in a single string of text. Individual variables are written in the format `name=value`. Each variable (that is, each name-value pair) is separated by ampersand characters, like this: `variable1=value1&variable2=value2`. In this way, an indefinite number of variables can be sent as a single message.
- **MIME type:** A standard code used to identify the type of a given file in Internet communication. Any given file type has a specific code that is used to identify it. When sending a file or message, a computer (such as a web server or a user's Flash Player instance) will specify the type of file being sent.
- **HTTP:** Hypertext Transfer Protocol—a standard format for delivering web pages and various other types of content that are sent over the Internet.
- **Request method:** When a program such as Flash Player or a web browser sends a message (called an HTTP request) to a web server, any data being sent can be embedded in the request in one of two ways; these are the two *request methods* GET and POST. On the server end, the program receiving the request will need to look in the appropriate portion of the request to find the data, so the request method used to send data from ActionScript should match the request method used to read that data on the server.
- **Socket connection:** A persistent connection for communication between two computers.
- **Upload:** To send a file to another computer.
- **Download:** To retrieve a file from another computer.

## Working through in-chapter examples

While you're working through this chapter you might want to test the example code listings. Several of the code listings in the chapter load external data or perform some other type of communication; often these samples include `trace()` function calls, so the results of running the example are displayed in the Output panel. Other examples actually perform some function, such as uploading a file to a server. Testing those examples will involve interacting with the SWF and confirming that they perform the action they claim to perform.

The code examples fall into two categories. Some of the example listings are written assuming the code is in a standalone script, such as attached to a keyframe in a Flash document. To test those examples:

1. Create a new Flash document.
2. Select the keyframe on Frame 1 of the Timeline, and open the Actions panel.
3. Copy the code listing into the Script pane.
4. From the main menu, choose Control > Test Movie to create the SWF file and test the example.

Other example code listings are written as a class; the expectation is that the example class will serve as the document class for the Flash document. To test those examples:

1. Create an empty Flash document and save it to your computer
2. Create a new ActionScript file and save it in the same directory as the Flash document. The file's name should match the name of the class in the code listing. For instance, if the code listing defines a class named "UploadTest," save the ActionScript file as "UploadTest.as".
3. Copy the code listing into the ActionScript file and save the file.
4. In the Flash document, click on a blank part of the Stage or pasteboard to activate the document Property inspector.
5. In the Property inspector, in the Document Class field, enter the name of the ActionScript class you copied from the text.
6. Run the program using Control > Test Movie and test the example.

Finally, some of the examples in the chapter involve interacting with a program running on a server. These examples include code that can be used to create the necessary server program to test the example; you will need to set up the appropriate applications on a web server computer in order to test those examples.



# Working with external data

ActionScript 3.0 includes mechanisms for loading data from external sources. Those sources can be static content such as text files, or dynamic content such as a web script that retrieves data from a database. The data can be formatted in a variety of ways, and ActionScript provides functionality for decoding and accessing the data. You can also send data to the external server as part of the process of retrieving data.

## Using the URLLoader and URLVariables classes

ActionScript 3.0 uses the URLLoader and URLVariables classes for loading external data. The URLLoader class downloads data from a URL as text, binary data, or URL-encoded variables. The URLLoader class is useful for downloading text files, XML, or other information to use in dynamic, data-driven ActionScript applications. The URLLoader class takes advantage of the ActionScript 3.0 advanced event-handling model, which allows you to listen for such events as `complete`, `httpStatus`, `ioError`, `open`, `progress`, and `securityError`. The new event-handling model is a significant improvement over the ActionScript 2.0 support for the `LoadVars.onData`, `LoadVars.onHTTPStatus`, and `LoadVars.onLoad` event handlers because it allows you to handle errors and events more efficiently. For more information on handling events, see [Chapter 10, “Handling events.”](#)

Much like the XML and LoadVars classes in earlier versions of ActionScript, the data of the URLLoader URL is not available until the download has completed. You can monitor the progress of the download (bytes loaded and bytes total) by listening for the `flash.events.ProgressEvent.PROGRESS` event to be dispatched, although if a file loads too quickly a `ProgressEvent.PROGRESS` event may not be dispatched. When a file has successfully downloaded, the `flash.events.Event.COMPLETE` event will be dispatched. The loaded data is decoded from UTF-8 or UTF-16 encoding into a string.

**NOTE**

If no value is set for `URLRequest.contentType`, values are sent as `application/x-www-form-urlencoded`.

The `URLLoader.load()` method (and optionally the URLLoader class's constructor) takes a single parameter, `request`, which is a `URLRequest` instance. A `URLRequest` instance contains all of the information for a single HTTP request, such as the target URL, request method (`GET` or `POST`), additional header information, and the MIME type (for example, when you upload XML content).

For example, to upload an XML packet to a server-side script, you could use the following ActionScript 3.0 code:

```
var secondsUTC:Number = new Date().time;
var dataXML:XML =
    <login>
        <time>{secondsUTC}</time>
        <username>Ernie</username>
        <password>guru</password>
    </login>;
var request:URLRequest = new URLRequest("http://www.yourdomain.com/
    login.cfm");
request.contentType = "text/xml";
request.data = dataXML.toXMLString();
request.method = URLRequestMethod.POST;
var loader:URLLoader = new URLLoader();
try
{
    loader.load(request);
}
catch (error:ArgumentError)
{
    trace("An ArgumentError has occurred.");
}
catch (error:SecurityError)
{
    trace("A SecurityError has occurred.");
}
```

The previous snippet creates an XML instance named `dataXML` that contains an XML packet to be sent to the server. Next, you set the `URLRequest` `contentType` property to "text/xml" and set the `URLRequest` `data` property to the contents of the XML packet, which are converted to a string by using the `XML.toXMLString()` method. Finally, you create a new `URLLoader` instance and send the request to the remote script by using the `URLLoader.load()` method.

There are three ways in which you can specify parameters to pass in a URL request:

- Within the `URLVariables` constructor
- Within the `URLVariables.decode()` method
- As specific properties within the `URLVariables` object itself

When you define variables within the `URLVariables` constructor or within the `URLVariables.decode()` method, you need to make sure that you URL-encode the ampersand character because it has a special meaning and acts as a delimiter. For example, when you pass an ampersand, you need to URL-encode the ampersand by changing it from `&` to `%26` because the ampersand acts as a delimiter for parameters.

## Loading data from external documents

When you build dynamic applications with ActionScript 3.0, it's a good idea to load data from external files or from server-side scripts. This lets you build dynamic applications without having to edit or recompile your ActionScript files. For example, if you build a “tip of the day” application, you can write a server-side script that retrieves a random tip from a database and saves it to a text file once a day. Then your ActionScript application can load the contents of a static text file instead of querying the database each time.

The following snippet creates a `URLRequest` and `URLLoader` object, which loads the contents of an external text file, `params.txt`:

```
var request:URLRequest = new URLRequest("params.txt");
var loader:URLLoader = new URLLoader();
loader.load(request);
```

You can simplify the previous snippet to the following:

```
var loader:URLLoader = new URLLoader(new URLRequest("params.txt"));
```

By default, if you do not define a request method, Flash Player loads the content using the HTTP GET method. If you want to send the data using the POST method, you need to set the `request.method` property to POST using the static constant `URLRequestMethod.POST`, as the following code shows:

```
var request:URLRequest = new URLRequest("sendfeedback.cfm");
request.method = URLRequestMethod.POST;
```

The external document, `params.txt`, that is loaded at run time contains the following data:

```
monthNames=January,February,March,April,May,June,July,August,September,October,November,December&dayNames=Sunday,Monday,Tuesday,Wednesday,Thursday,Friday,Saturday
```

The file contains two parameters, `monthNames` and `dayNames`. Each parameter contains a comma-separated list that is parsed as strings. You can split this list into an array using the `String.split()` method.

**TIP**

Avoid using reserved words or language constructs as variable names in external data files, because doing so makes reading and debugging your code more difficult.

Once the data has loaded, the `Event.COMPLETE` event is dispatched, and the contents of the external document are available to use in the `URLLoader`'s `data` property, as the following code shows:

```
private function completeHandler(event:Event):void
{
    var loader2:URLLoader = URLLoader(event.target);
    trace(loader2.data);
}
```

If the remote document contains name-value pairs, you can parse the data using the `URLVariables` class by passing in the contents of the loaded file, as follows:

```
private function completeHandler(event:Event):void
{
    var loader2:URLLoader = URLLoader(event.target);
    var variables:URLVariables = new URLVariables(loader2.data);
    trace(variables.dayNames);
}
```

Each name-value pair from the external file is created as a property in the `URLVariables` object. Each property within the variables object in the previous code sample is treated as a string. If the value of the name-value pair is a list of items, you can convert the string into an array by calling the `String.split()` method, as follows:

```
var dayNameArray:Array = variables.dayNames.split(",");
```

**TIP**

If you are loading numeric data from external text files, you need to convert the values into numeric values by using a top-level function, such as `int()`, `uint()`, or `Number()`.

Instead of loading the contents of the remote file as a string and creating a new `URLVariables` object, you could instead set the `URLLoader.dataFormat` property to one of the static properties found in the `URLLoaderDataFormat` class. The three possible values for the `URLLoader.dataFormat` property are as follows:

- `URLLoaderDataFormat.BINARY`—The `URLLoader.data` property will contain binary data stored in a `ByteArray` object.
- `URLLoaderDataFormat.TEXT`—The `URLLoader.data` property will contain text in a `String` object.
- `URLLoaderDataFormat.VARIABLES`—The `URLLoader.data` property will contain URL-encoded variables stored in a `URLVariables` object.

The following code demonstrates how setting the `URLLoader.dataFormat` property to `URLLoaderDataFormat.VARIABLES` allows you to automatically parse loaded data into a `URLVariables` object:

```
package
{
    import flash.display.Sprite;
    import flash.events.*;
    import flash.net.URLLoader;
    import flash.net.URLLoaderDataFormat;
    import flash.net.URLRequest;

    public class URLLoaderDataFormatExample extends Sprite
    {
        public function URLLoaderDataFormatExample()
        {
            var request:URLRequest = new URLRequest("http://
www.[yourdomain].com/params.txt");
            var variables:URLLoader = new URLLoader();
            variables.dataFormat = URLLoaderDataFormat.VARIABLES;
            variables.addEventListener(Event.COMPLETE, completeHandler);
            try
            {
                variables.load(request);
            }
            catch (error:Error)
            {
                trace("Unable to load URL: " + error);
            }
        }
        private function completeHandler(event:Event):void
        {
            var loader:URLLoader = URLLoader(event.target);
            trace(loader.data.dayNames);
        }
    }
}
```

**NOTE**

The default value for `URLLoader.dataFormat` is `URLLoaderDataFormat.TEXT`.

As the following example shows, Loading XML from an external file is the same as loading URLVariables. You can create a URLRequest instance and a URLLoader instance and use them to download a remote XML document. When the file has completely downloaded, the Event.COMPLETE event is dispatched and the contents of the external file are converted to an XML instance, which you can parse using XML methods and properties.

```
package
{
    import flash.display.Sprite;
    import flash.errors.*;
    import flash.events.*;
    import flash.net.URLLoader;
    import flash.net.URLRequest;

    public class ExternalDocs extends Sprite
    {
        public function ExternalDocs()
        {
            var request:URLRequest = new URLRequest("http://
www.[yourdomain].com/data.xml");
            var loader:URLLoader = new URLLoader();
            loader.addEventListener(Event.COMPLETE, completeHandler);
            try
            {
                loader.load(request);
            }
            catch (error:ArgumentError)
            {
                trace("An ArgumentError has occurred.");
            }
            catch (error:SecurityError)
            {
                trace("A SecurityError has occurred.");
            }
        }
        private function completeHandler(event:Event):void
        {
            var dataXML:XML = XML(event.target.data);
            trace(dataXML.toXMLString());
        }
    }
}
```

## Communicating with external scripts

In addition to loading external data files, you can also use the `URLVariables` class to send variables to a server-side script and process the server's response. This is useful, for example, if you are programming a game and want to send the user's score to a server to calculate whether it should be added to the high scores list, or even send a user's login information to a server for validation. A server-side script can process the user name and password, validate it against a database, and return confirmation of whether the user-supplied credentials are valid.

The following snippet creates a `URLVariables` object named `variables`, which creates a new variable called `name`. Next, a `URLRequest` object is created that specifies the URL of the server-side script to send the variables to. Then you set the `method` property of the `URLRequest` object to send the variables as an HTTP `POST` request. To add the `URLVariables` object to the URL request, you set the `data` property of the `URLRequest` object to the `URLVariables` object created earlier. Finally, the `URLLoader` instance is created and the `URLLoader.load()` method is invoked, which initiates the request.

```
var variables:URLVariables = new URLVariables("name=Franklin");
var request:URLRequest = new URLRequest();
request.url = "http://www.[yourdomain].com/greeting.cfm";
request.method = URLRequestMethod.POST;
request.data = variables;
var loader:URLLoader = new URLLoader();
loader.dataFormat = URLLoaderDataFormat.VARIABLES;
loader.addEventListener(Event.COMPLETE, completeHandler);
try
{
    loader.load(request);
}
catch (error:Error)
{
    trace("Unable to load URL");
}

function completeHandler(event:Event):void
{
    trace(event.target.data.welcomeMessage);
}
```

The following code contains the contents of the Adobe ColdFusion® `greeting.cfm` document used in the previous example:

```
<cfif NOT IsDefined("Form.name") OR Len(Trim(Form.Name)) EQ 0>
    <cfset Form.Name = "Stranger" />
</cfif>
<cfoutput>welcomeMessage=#UrlEncodedFormat("Welcome, " & Form.name)#</cfoutput>
```

# Connecting to other Flash Player instances

The `LocalConnection` class lets you communicate between different Flash Player instances, such as a SWF in an HTML container or in an embedded or stand-alone player. This allows you to build very versatile applications that can share data between Flash Player instances, such as SWF files running in a web browser or embedded in desktop applications.

## LocalConnection class

The `LocalConnection` class lets you develop SWF files that can send instructions to other SWF files without the use of the `fscommand()` method or JavaScript. `LocalConnection` objects can communicate only among SWF files that are running on the same client computer, but they can run in different applications. For example, a SWF file running in a browser and a SWF file running in a projector can share information, with the projector maintaining local information and the browser-based SWF connecting remotely. (A projector is a SWF file saved in a format that can run as a stand-alone application—that is, the projector doesn't require Flash Player to be installed because it is embedded inside the executable.)

`LocalConnection` objects can be used to communicate between SWFs using different ActionScript versions:

- ActionScript 3.0 `LocalConnection` objects can communicate with `LocalConnection` objects created in ActionScript 1.0 or 2.0.
- ActionScript 1.0 or 2.0 `LocalConnection` objects can communicate with `LocalConnection` objects created in ActionScript 3.0.

Flash Player handles this communication between `LocalConnection` objects of different versions automatically.



The simplest way to use a `LocalConnection` object is to allow communication only between `LocalConnection` objects located in the same domain. That way, you won't have to worry about security issues. However, if you need to allow communication between domains, you have several ways to implement security measures. For more information, see the discussion of the `connectionName` parameter of the `send()` method and the `allowDomain()` and `domain` entries in the `LocalConnection` class listing in the *ActionScript 3.0 Language and Components Reference*.

**TIP**

It is possible to use `LocalConnection` objects to send and receive data within a single SWF file, but Adobe does not recommend doing so. Instead, you should use shared objects.

There are three ways to add callback methods to your `LocalConnection` objects:

- Subclass the `LocalConnection` class and add methods.
- Set the `LocalConnection.client` property to an object that implements the methods.
- Create a dynamic class that extends `LocalConnection` and dynamically attach methods.

The first way to add callback methods is to extend the `LocalConnection` class. You define the methods within the custom class instead of dynamically adding them to the `LocalConnection` instance. This approach is demonstrated in the following code:

```
package
{
    import flash.net.LocalConnection;
    public class CustomLocalConnection extends LocalConnection
    {
        public function CustomLocalConnection(connectionName:String)
        {
            try
            {
                connect(connectionName);
            }
            catch (error:ArgumentError)
            {
                // server already created/connected
            }
        }
        public function onMethod(timeString:String):void
        {
            trace("onMethod called at: " + timeString);
        }
    }
}
```

In order to create a new instance of the `DynamicLocalConnection` class, you can use the following code:

```
var serverLC:CustomLocalConnection;
serverLC = new CustomLocalConnection("serverName");
```

The second way to add callback methods is to use the `LocalConnection.client` property. This involves creating a custom class and assigning a new instance to the `client` property, as the following code shows:

```
var lc:LocalConnection = new LocalConnection();
lc.client = new CustomClient();
```

The `LocalConnection.client` property indicates the object callback methods that should be invoked. In the previous code, the `client` property was set to a new instance of a custom class, `CustomClient`. The default value for the `client` property is the current `LocalConnection` instance. You can use the `client` property if you have two data handlers that have the same set of methods but act differently—for example, in an application where a button in one window toggles the view in a second window.

To create the `CustomClient` class, you could use the following code:

```
package
{
    public class CustomClient extends Object
    {
        public function onMethod(timeString:String):void
        {
            trace("onMethod called at: " + timeString);
        }
    }
}
```

The third way to add callback methods, creating a dynamic class and dynamically attaching the methods, is very similar to using the `LocalConnection` class in earlier versions of `ActionScript`, as the following code shows:

```
import flash.net.LocalConnection;
dynamic class DynamicLocalConnection extends LocalConnection {}
```

Callback methods can be dynamically added to this class by using the following code:

```
var connection:DynamicLocalConnection = new DynamicLocalConnection();
connection.onMethod = this.onMethod;
// Add your code here.
public function onMethod(timeString:String):void
{
    trace("onMethod called at: " + timeString);
}
```

The previous way of adding callback methods is not recommended because the code is not very portable. In addition, using this method of creating local connections could create performance issues, because accessing dynamic properties is dramatically slower than accessing sealed properties.

## Sending messages between two Flash Player instances

You use the `LocalConnection` class to communicate between different instances of Flash Player. For example, you could have multiple Flash Player instances on a web page, or have a Flash Player instance retrieve data from a Flash Player instance in a pop-up window.

The following code defines a local connection object that acts as a server and accepts incoming calls from other Flash Player instances:

```
package
{
    import flash.net.LocalConnection;
    import flash.display.Sprite;
    public class ServerLC extends Sprite
    {
        public function ServerLC()
        {
            var lc:LocalConnection = new LocalConnection();
            lc.client = new CustomClient1();
            try
            {
                lc.connect("conn1");
            }
            catch (error:Error)
            {
                trace("error:: already connected");
            }
        }
    }
}
```

This code first creates a `LocalConnection` object named `lc` and sets the `client` property to a custom class, `CustomClient1`. When another Flash Player instance calls a method in this local connection instance, Flash Player looks for that method in the `CustomClient1` class.

Whenever a Flash Player instance connects to this SWF file and tries to invoke any method for the specified local connection, the request is sent to the class specified by the `client` property, which is set to the `CustomClient1` class:

```
package
{
    import flash.events.*;
    import flash.system.fscommand;
    import flash.utils.Timer;
    public class CustomClient1 extends Object
    {
        public function doMessage(value:String = ""):void
        {
            trace(value);
        }
        public function doQuit():void
        {
            trace("quitting in 5 seconds");
            this.close();
            var quitTimer:Timer = new Timer(5000, 1);
            quitTimer.addEventListener(TimerEvent.TIMER, closeHandler);
        }
        public function closeHandler(event:TimerEvent):void
        {
            fscommand("quit");
        }
    }
}
```

To create a `LocalConnection` server, call the `LocalConnection.connect()` method and provide a unique connection name. If you already have a connection with the specified name, an `ArgumentError` error is generated, indicating that the connection attempt failed because the object is already connected.

The following snippet demonstrates how to create a new socket connection with the name `conn1`:

```
try
{
    connection.connect("conn1");
}
catch (error:ArgumentError)
{
    trace("Error! Server already exists\n");
}
```

**NOTE**

In earlier versions of ActionScript, the `LocalConnection.connect()` method returns a Boolean value if the connection name has already been used. In ActionScript 3.0, an error is generated if the name has already been used.

Connecting to the primary SWF file from a secondary SWF file requires that you create a new `LocalConnection` object in the sending `LocalConnection` object and then call the `LocalConnection.send()` method with the name of the connection and the name of the method to execute. For example, to connect to the `LocalConnection` object that you created earlier, you use the following code:

```
sendingConnection.send("conn1", "doQuit");
```

This code connects to an existing `LocalConnection` object with the connection name `conn1` and invokes the `doQuit()` method in the remote SWF file. If you want to send parameters to the remote SWF file, you specify additional arguments after the method name in the `send()` method, as the following snippet shows:

```
sendingConnection.send("conn1", "doMessage", "Hello world");
```

## Connecting to SWF documents in different domains

To allow communications only from specific domains, you call the `allowDomain()` or `allowInsecureDomain()` method of the `LocalConnection` class and pass a list of one or more domains that are allowed to access this `LocalConnection` object.

In earlier versions of ActionScript, `LocalConnection.allowDomain()` and `LocalConnection.allowInsecureDomain()` were callback methods that had to be implemented by developers and that had to return a Boolean value. In ActionScript 3.0, `LocalConnection.allowDomain()` and `LocalConnection.allowInsecureDomain()` are both built-in methods, which developers can call just like `Security.allowDomain()` and `Security.allowInsecureDomain()`, passing one or more names of domains to be allowed.

There are two special values that you can pass to the `LocalConnection.allowDomain()` and `LocalConnection.allowInsecureDomain()` methods: `*` and `localhost`. The asterisk value (`*`) allows access from all domains. The string `localhost` allows calls to the SWF file from SWF files that are locally installed.

Flash Player 8 introduced security restrictions on local SWF files. A SWF file that is allowed to access the Internet cannot also have access to the local file system. If you specify `localhost`, any local SWF file can access the SWF file. If the `LocalConnection.send()` method attempts to communicate with a SWF file from a security sandbox to which the calling code does not have access, a `securityError` event (`SecurityErrorEvent.SECURITY_ERROR`) is dispatched. To work around this error, you can specify the caller's domain in the receiver's `LocalConnection.allowDomain()` method.

If you implement communication only between SWF files in the same domain, you can specify a `connectionName` parameter that does not begin with an underscore (`_`) and does not specify a domain name (for example, `myDomain:connectionName`). Use the same string in the `LocalConnection.connect(connectionName)` command.

If you implement communication between SWF files in different domains, you specify a `connectionName` parameter that begins with an underscore. Specifying the underscore makes the SWF file with the receiving `LocalConnection` object more portable between domains.

Here are the two possible cases:

- If the string for `connectionName` does not begin with an underscore, Flash Player adds a prefix with the superdomain name and a colon (for example, `myDomain:connectionName`). Although this ensures that your connection does not conflict with connections of the same name from other domains, any sending `LocalConnection` objects must specify this superdomain (for example, `myDomain:connectionName`). If you move the SWF file with the receiving `LocalConnection` object to another domain, Flash Player changes the prefix to reflect the new superdomain (for example, `anotherDomain:connectionName`). All sending `LocalConnection` objects have to be manually edited to point to the new superdomain.
- If the string for `connectionName` begins with an underscore (for example, `_connectionName`), Flash Player does not add a prefix to the string. This means the receiving and sending `LocalConnection` objects will use identical strings for `connectionName`. If the receiving object uses `LocalConnection.allowDomain()` to specify that connections from any domain will be accepted, you can move the SWF file with the receiving `LocalConnection` object to another domain without altering any sending `LocalConnection` objects.

## Socket connections

There are two different types of socket connections possible in ActionScript 3.0: XML socket connections and binary socket connections. An XML socket lets you connect to a remote server and create a server connection that remains open until explicitly closed. This lets you exchange XML data between a server and client without having to continually open new server connections. Another benefit of using an XML socket server is that the user doesn't need to explicitly request data. You can send data from the server without requests, and you can send data to every client connected to the XML socket server.

A binary socket connection is similar to an XML socket except that the client and server don't need to exchange XML packets specifically. Instead, the connection can transfer data as binary information. This allows you to connect to a wide range of services, including mail servers (POP3, SMTP, and IMAP), and news servers (NNTP).

## Socket class

Introduced in ActionScript 3.0, the Socket class enables ActionScript to make socket connections and to read and write raw binary data. It is similar to the XMLSocket class, but does not dictate the format of the received and transmitted data. The Socket class is useful for interoperating with servers that use binary protocols. By using binary socket connections, you can write code that allows interaction with several different Internet protocols, such as POP3, SMTP, IMAP, and NNTP. This in turn enables Flash Player to connect to mail and news servers.

Flash Player can interface with a server by using the binary protocol of that server directly. Some servers use the big-endian byte order, and some use the little-endian byte order. Most servers on the Internet use the big-endian byte order because “network byte order” is big-endian. The little-endian byte order is popular because the Intel® x86 architecture uses it. You should use the endian byte order that matches the byte order of the server that is sending or receiving data. All operations that are performed by the IDataInput and IDataOutput interfaces, and the classes that implement those interfaces (ByteArray, Socket, and URLStream), are encoded by default in big-endian format; that is, with the most significant byte first. This is done to match Java and official network byte order. To change whether big-endian or little-endian byte order is used, you can set the `endian` property to `Endian.BIG_ENDIAN` or `Endian.LITTLE_ENDIAN`.

TIP

The Socket class inherits all the methods implemented by the IDataInput and IDataOutput interfaces (located in the flash.utils package), and those methods should be used to write to and read from the Socket.

## XMLSocket class

ActionScript provides a built-in XMLSocket class, which lets you open a continuous connection with a server. This open connection removes latency issues and is commonly used for real-time applications such as chat applications or multiplayer games. A traditional HTTP-based chat solution frequently polls the server and downloads new messages using an HTTP request. In contrast, an XMLSocket chat solution maintains an open connection to the server, which lets the server immediately send incoming messages without a request from the client.

To create a socket connection, you must create a server-side application to wait for the socket connection request and send a response to the SWF file. This type of server-side application can be written in a programming language such as Java, Python, or Perl. To use the `XMLSocket` class, the server computer must run a daemon that understands the protocol used by the `XMLSocket` class. The protocol is described in the following list:

- XML messages are sent over a full-duplex TCP/IP stream socket connection.
- Each XML message is a complete XML document, terminated by a zero (0) byte.
- An unlimited number of XML messages can be sent and received over a single `XMLSocket` connection.

NOTE

The `XMLSocket` class cannot tunnel through firewalls automatically because, unlike the Real-Time Messaging Protocol (RTMP), `XMLSocket` has no HTTP tunneling capability. If you need to use HTTP tunneling, consider using Flash Remoting or Flash Media Server (which supports RTMP) instead.

The following restrictions apply to how and where an `XMLSocket` object can connect to the server:

- The `XMLSocket.connect()` method can connect only to TCP port numbers greater than or equal to 1024. One consequence of this restriction is that the server daemons that communicate with the `XMLSocket` object must also be assigned to port numbers greater than or equal to 1024. Port numbers below 1024 are often used by system services such as FTP (21), Telnet (23), SMTP (25), HTTP (80), and POP3 (110), so `XMLSocket` objects are barred from these ports for security reasons. The port number restriction limits the possibility that these resources will be inappropriately accessed and abused.
- The `XMLSocket.connect()` method can connect only to computers in the same domain where the SWF file resides. This restriction does not apply to SWF files running off a local disk. (This restriction is identical to the security rules for `URLLoader.load()`.) To connect to a server daemon running in a domain other than the one where the SWF resides, you can create a security policy file on the server that allows access from specific domains.

NOTE

Setting up a server to communicate with the `XMLSocket` object can be challenging. If your application does not require real-time interactivity, use the `URLLoader` class instead of the `XMLSocket` class.

You can use the `XMLSocket.connect()` and `XMLSocket.send()` methods of the `XMLSocket` class to transfer XML to and from a server over a socket connection. The `XMLSocket.connect()` method establishes a socket connection with a web server port. The `XMLSocket.send()` method passes an XML object to the server specified in the socket connection.



When you invoke the `XMLSocket.connect()` method, Flash Player opens a TCP/IP connection to the server and keeps that connection open until one of the following occurs:

- The `XMLSocket.close()` method of the `XMLSocket` class is called.
- No more references to the `XMLSocket` object exist.
- Flash Player exits.
- The connection is broken (for example, the modem disconnects).

## Creating and connecting to a Java XML socket server

The following code demonstrates a simple `XMLSocket` server written in Java that accepts incoming connections and displays the received messages in the command prompt window. By default, a new server is created on port 8080 of your local machine, although you can specify a different port number when starting your server from the command line.

Create a new text document and add the following code:

```
import java.io.*;
import java.net.*;

class SimpleServer
{
    private static SimpleServer server;
    ServerSocket socket;
    Socket incoming;
    BufferedReader readerIn;
    PrintStream printOut;

    public static void main(String[] args)
    {
        int port = 8080;

        try
        {
            port = Integer.parseInt(args[0]);
        }
        catch (ArrayIndexOutOfBoundsException e)
        {
            // Catch exception and keep going.
        }

        server = new SimpleServer(port);
    }
}
```

```

private SimpleServer(int port)
{
    System.out.println(">> Starting SimpleServer");
    try
    {
        socket = new ServerSocket(port);
        incoming = socket.accept();
        readerIn = new BufferedReader(new
InputStreamReader(incoming.getInputStream()));
        printOut = new PrintStream(incoming.getOutputStream());
        printOut.println("Enter EXIT to exit.\r");
        out("Enter EXIT to exit.\r");
        boolean done = false;
        while (!done)
        {
            String str = readerIn.readLine();
            if (str == null)
            {
                done = true;
            }
            else
            {
                out("Echo: " + str + "\r");
                if(str.trim().equals("EXIT"))
                {
                    done = true;
                }
            }
            incoming.close();
        }
    }
    catch (Exception e)
    {
        System.out.println(e);
    }
}

private void out(String str)
{
    printOut.println(str);
    System.out.println(str);
}
}

```

Save the document to your hard disk as SimpleServer.java and compile it using a Java compiler, which creates a Java class file named SimpleServer.class.

You can start the XMLSocket server by opening a command prompt and typing `java SimpleServer`. The `SimpleServer.class` file can be located anywhere on your local computer or network; it doesn't need to be placed in the root directory of your web server.

**TIP**

If you're unable to start the server because the files are not located within the Java classpath, try starting the server with `java -classpath . SimpleServer`.

To connect to the XMLSocket from your ActionScript application, you need to create a new instance of the XMLSocket class, and call the `XMLSocket.connect()` method while passing a host name and port number, as follows:

```
var xmlsock:XMLSocket = new XMLSocket();
xmlsock.connect("127.0.0.1", 8080);
```

A `securityError` (`flash.events.SecurityErrorEvent`) event occurs if a call to `XMLSocket.connect()` attempts to connect either to a server outside the caller's security sandbox or to a port lower than 1024.

Whenever you receive data from the server, the data event (`flash.events.DataEvent.DATA`) is dispatched:

```
xmlsock.addEventListener(DataEvent.DATA, onData);
private function onData(event:DataEvent):void
{
    trace("[ " + event.type + " ] " + event.data);
}
```

To send data to the XMLSocket server, you use the `XMLSocket.send()` method and pass an XML object or string. Flash Player converts the supplied parameter to a String object and sends the content to the XMLSocket server followed by a zero (0) byte:

```
xmlsock.send(xmlFormattedData);
```

The `XMLSocket.send()` method does not return a value that indicates whether the data was successfully transmitted. If an error occurred while trying to send data, an `IOError` error is thrown.

**TIP**

Each message you send to the XML socket server must be terminated by a newline (`\n`) character.

# Storing local data

A shared object, sometimes referred to as a “Flash cookie,” is a data file that can be created on your computer by the sites that you visit. Shared objects are most often used to enhance your web-browsing experience—for example, by allowing you to personalize the look and feel of a website that you frequently visit. Shared objects, by themselves, can’t do anything to or with the data on your computer. More important, shared objects can never access or remember your e-mail address or other personal information—unless you willingly provide such information.

New shared object instances can be created using the static `SharedObject.getLocal()` or `SharedObject.getRemote()` methods. The `getLocal()` method attempts to load a locally persistent shared object that is available only to the current client, whereas the `getRemote()` method attempts to load a remote shared object that can be shared across multiple clients by means of a server, such as Flash Media Server. If the local or remote shared object does not exist, the `getLocal()` and `getRemote()` methods will create a new `SharedObject` instance.

The following code attempts to load a local shared object named `test`. If this shared object doesn’t exist, a new shared object with this name will be created.

```
var so:SharedObject = SharedObject.getLocal("test");
trace("SharedObject is " + so.size + " bytes");
```

If a shared object named `test` cannot be found, a new one is created with a size of 0 bytes. If the shared object previously existed, its current size (in bytes) is returned.

You can store data in a shared object by assigning values to the data object, as seen in the following example:

```
var so:SharedObject = SharedObject.getLocal("test");
so.data.now = new Date().time;
trace(so.data.now);
trace("SharedObject is " + so.size + " bytes");
```

If there is already a shared object with the name `test` and the parameter `now`, the existing value is overwritten. You can use the `SharedObject.size` property to determine if a shared object already exists, as the following example shows:

```
var so:SharedObject = SharedObject.getLocal("test");
if (so.size == 0)
{
    // Shared object doesn't exist.
    trace("created...");
    so.data.now = new Date().time;
}
trace(so.data.now);
trace("SharedObject is " + so.size + " bytes");
```

The previous code uses the `size` parameter to determine if the shared object instance with the specified name already exists. If you test the following code, you'll notice that each time you run the code, the shared object is recreated. In order for a shared object to be saved to the user's hard drive, you must explicitly call the `SharedObject.flush()` method, as the following example shows:

```
var so:SharedObject = SharedObject.getLocal("test");
if (so.size == 0)
{
    // Shared object doesn't exist.
    trace("created...");
    so.data.now = new Date().time;
}
trace(so.data.now);
trace("SharedObject is " + so.size + " bytes");
so.flush();
```

When using the `flush()` method to write shared objects to a user's hard drive, you should be careful to check whether the user has explicitly disabled local storage using the Flash Player Settings Manager ([www.macromedia.com/support/documentation/en/flashplayer/help/settings\\_manager07.html](http://www.macromedia.com/support/documentation/en/flashplayer/help/settings_manager07.html)), as shown in the following example:

```
var so:SharedObject = SharedObject.getLocal("test");
trace("Current SharedObject size is " + so.size + " bytes.");
so.flush();
```

Values can be retrieved from a shared object by specifying the property's name in the shared object's `data` property. For example, if you run the following code, Flash Player will display how many minutes ago the `SharedObject` instance was created:

```
var so:SharedObject = SharedObject.getLocal("test");
if (so.size == 0)
{
    // Shared object doesn't exist.
    trace("created...");
    so.data.now = new Date().time;
}
var ageMS:Number = new Date().time - so.data.now;
trace("SharedObject was created " + Number(ageMS / 1000 /
    60).toFixed(2) + " minutes ago");
trace("SharedObject is " + so.size + " bytes");
so.flush();
```

The first time the previous code is run, a new `SharedObject` instance named `test` will be created and have an initial size of 0 bytes. Because the initial size is 0 bytes, the `if` statement evaluates to `true` and a new property named `now` is added to the local shared object. The shared object's age is calculated by subtracting the value of the `now` property from the current time. Each subsequent time the previous code is run, the size of the shared object should be greater than 0, and the code will trace how many minutes ago the shared object was created.

## Displaying contents of a shared object

Values are stored in shared objects within the `data` property. You can loop over each value within a shared object instance by using a `for..in` loop, as the following example shows:

```
var so:SharedObject = SharedObject.getLocal("test");
so.data.hello = "world";
so.data.foo = "bar";
so.data.timezone = new Date().timezoneOffset;
for (var i:String in so.data)
{
    trace(i + ":\t" + so.data[i]);
}
```

## Creating a secure SharedObject

When you create either a local or remote `SharedObject` using `getLocal()` or `getRemote()`, there is an optional parameter named `secure` that determines whether access to this shared object is restricted to SWF files that are delivered over an HTTPS connection. If this parameter is set to `true` and your SWF file is delivered over HTTPS, Flash Player creates a new secure shared object or gets a reference to an existing secure shared object. This secure shared object can be read from or written to only by SWF files delivered over HTTPS that call `SharedObject.getLocal()` with the `secure` parameter set to `true`. If this parameter is set to `false` and your SWF file is delivered over HTTPS, Flash Player creates a new shared object or gets a reference to an existing shared object.

This shared object can be read from or written to by SWF files delivered over non-HTTPS connections. If your SWF file is delivered over a non-HTTPS connection and you try to set this parameter to `true`, the creation of a new shared object (or the access of a previously created secure shared object) fails, an error is thrown, and the shared object is set to `null`. If you attempt to run the following snippet from a non-HTTPS connection, the `SharedObject.getLocal()` method will throw an error:

```
try
{
```

```

    var so:SharedObject = SharedObject.getLocal("contactManager", null,
    true);
}
catch (error:Error)
{
    trace("Unable to create SharedObject.");
}

```

Regardless of the value of this parameter, the created shared objects count toward the total amount of disk space allowed for a domain.

## Working with file upload and download

The `FileReference` class lets you add the ability to upload and download files between a client and a server. Users are prompted to select a file to upload or a location for download from a dialog box (such as the Open dialog box on the Windows operating system).

Each `FileReference` object that you create with ActionScript refers to a single file on the user's hard disk. The object has properties that contain information about the file's size, type, name, creation date, and modification date.

**NOTE**

The `creator` property is supported on Mac OS only. All other platforms return `null`.

You can create an instance of the `FileReference` class in two ways. You can use the `new` operator, as the following code shows:

```

import flash.net.FileReference;
var myFileReference:FileReference = new FileReference();

```

Or you can call the `FileReferenceList.browse()` method, which opens a dialog box on the user's system to prompt the user to select one or more files to upload and then creates an array of `FileReference` objects if the user selects one or more files successfully. Each `FileReference` object represents a file selected by the user from the dialog box. A `FileReference` object does not contain any data in the `FileReference` properties (such as `name`, `size`, or `modificationDate`) until one of the following happens:

- The `FileReference.browse()` method or `FileReferenceList.browse()` method has been called, and the user has selected a file from the file picker.
- The `FileReference.download()` method has been called, and the user has selected a file from the file picker.

**NOTE**

When performing a download, only the `FileReference.name` property is populated before the download is complete. After the file has been downloaded, all properties are available.

While calls to the `FileReference.browse()`, `FileReferenceList.browse()`, or `FileReference.download()` method are executing, most players will continue SWF file playback.

## FileReference class

The `FileReference` class allows you to upload and download files between a user's computer and a server. An operating system dialog box prompts the user to select a file to upload or a location for download. Each `FileReference` object refers to a single file on the user's disk and has properties that contain information about the file's size, type, name, creation date, modification date, and creator.

`FileReference` instances can be created in two ways:

- When you use the `new` operator with the `FileReference` constructor, as in the following:  

```
var myFileReference:FileReference = new FileReference();
```
- When you call `FileReferenceList.browse()`, which creates an array of `FileReference` objects.

For uploading and downloading operations, a SWF file can access files only within its own domain, including any domains specified by a cross-domain policy file. You need to put a policy file on the file server if the SWF file initiating the upload or download doesn't come from the same domain as the file server.

NOTE

You can only perform one `browse()` or `download()` action at a time, because only one dialog box can be open at any point.

The server script that handles the file upload should expect an HTTP `POST` request with the following elements:

- `Content-Type` with a value of `multipart/form-data`.
- `Content-Disposition` with a `name` attribute set to "filedata" and a `filename` attribute set to the name of the original file. You can specify a custom `name` attribute by passing a value for the `uploadDataFieldName` parameter in the `FileReference.upload()` method.
- The binary contents of the file.



Here is a sample HTTP POST request:

```
POST /handler.asp HTTP/1.1
Accept: text/*
Content-Type: multipart/form-data;
boundary=-----Ij5ae0ae0KM7GI3KM7ei4cH2ei4gL6
User-Agent: Shockwave Flash
Host: www.mydomain.com
Content-Length: 421
Connection: Keep-Alive
Cache-Control: no-cache

-----Ij5ae0ae0KM7GI3KM7ei4cH2ei4gL6
Content-Disposition: form-data; name="Filename"

sushi.jpg
-----Ij5ae0ae0KM7GI3KM7ei4cH2ei4gL6
Content-Disposition: form-data; name="Filedata"; filename="sushi.jpg"
Content-Type: application/octet-stream

Test File
-----Ij5ae0ae0KM7GI3KM7ei4cH2ei4gL6
Content-Disposition: form-data; name="Upload"

Submit Query
-----Ij5ae0ae0KM7GI3KM7ei4cH2ei4gL6
(actual file data,,)
```

The following sample HTTP POST request sends three POST variables: api\_sig, api\_key, and auth\_token, and uses a custom upload data field name value of "photo":

```
POST /handler.asp HTTP/1.1
Accept: text/*
Content-Type: multipart/form-data;
boundary=-----Ij5ae0ae0KM7GI3KM7ei4cH2ei4gL6
User-Agent: Shockwave Flash
Host: www.mydomain.com
Content-Length: 421
Connection: Keep-Alive
Cache-Control: no-cache

-----Ij5GI3GI3ei4GI3ei4KM7GI3KM7KM7
Content-Disposition: form-data; name="Filename"

sushi.jpg
-----Ij5GI3GI3ei4GI3ei4KM7GI3KM7KM7
Content-Disposition: form-data; name="api_sig"

XXXXXXXXXXXXXXXXXXXXXXXXXXXXXXXXX
-----Ij5GI3GI3ei4GI3ei4KM7GI3KM7KM7
Content-Disposition: form-data; name="api_key"
```

```

XXXXXXXXXXXXXXXXXXXXXXXXXXXXXXXXXXXX
-----Ij5GI3GI3ei4GI3ei4KM7GI3KM7KM7
Content-Disposition: form-data; name="auth_token"

XXXXXXXXXXXXXXXXXXXXXXXXXXXX
-----Ij5GI3GI3ei4GI3ei4KM7GI3KM7KM7
Content-Disposition: form-data; name="photo"; filename="sushi.jpg"
Content-Type: application/octet-stream

(actual file data,,)
-----Ij5GI3GI3ei4GI3ei4KM7GI3KM7KM7
Content-Disposition: form-data; name="Upload"

Submit Query
-----Ij5GI3GI3ei4GI3ei4KM7GI3KM7KM7--

```

## Uploading files to a server

To upload files to a server, first call the `browse()` method to allow a user to select one or more files. Next, when the `FileReference.upload()` method is called, the selected file will be transferred to the server. If the user selected multiple files using the `FileReferenceList.browse()` method, Flash Player creates an array of selected files called `FileReferenceList.fileList`. You can then use the `FileReference.upload()` method to upload each file individually.

**NOTE**

Using the `FileReference.browse()` method allows you to upload single files only. To allow a user to upload multiple files, you must use the `FileReferenceList.browse()` method.

By default, the system file picker dialog box allows users to pick any file type from the local computer, although developers can specify one or more custom file type filters by using the `FileFilter` class and passing an array of file filter instances to the `browse()` method:

```

var imageTypes:FileFilter = new FileFilter("Images (*.jpg, *.jpeg, *.gif,
    *.png)", "*.jpg; *.jpeg; *.gif; *.png");
var textTypes:FileFilter = new FileFilter("Text Files (*.txt, *.rtf)",
    "*.txt; *.rtf");
var allTypes:Array = new Array(imageTypes, textTypes);
var fileRef:FileReference = new FileReference();
fileRef.browse(allTypes);

```

When the user has selected the files and clicked the Open button in the system file picker, the `Event.SELECT` event is dispatched. If the `FileReference.browse()` method was used to select a file to upload, the following code is needed to send the file to a web server:

```
var fileRef:FileReference = new FileReference();
fileRef.addEventListener(Event.SELECT, selectHandler);
fileRef.addEventListener(Event.COMPLETE, completeHandler);
try
{
    var success:Boolean = fileRef.browse();
}
catch (error:Error)
{
    trace("Unable to browse for files.");
}
function selectHandler(event:Event):void
{
    var request:URLRequest = new URLRequest("http://www.[yourdomain].com/
fileUploadScript.cfm")
    try
    {
        fileRef.upload(request);
    }
    catch (error:Error)
    {
        trace("Unable to upload file.");
    }
}
function completeHandler(event:Event):void
{
    trace("uploaded");
}
```

**TIP**

You can send data to the server with the `FileReference.upload()` method by using the `URLRequest.method` and `URLRequest.data` properties to send variables using the POST or GET methods.

When you attempt to upload a file using the `FileReference.upload()` method, any of the following events may be dispatched:

- `Event.OPEN`: Dispatched when an upload operation starts.
- `ProgressEvent.PROGRESS`: Dispatched periodically during the file upload operation.
- `Event.COMPLETE`: Dispatched when the file upload operation completes successfully.
- `SecurityErrorEvent.SECURITY_ERROR`: Dispatched when an upload fails because of a security violation.

- `HTTPStatusEvent.HTTP_STATUS`: Dispatched when an upload fails because of an HTTP error.
- `IOErrorEvent.IO_ERROR`: Dispatched if the upload fails because of any of the following reasons:
  - An input/output error occurred while Flash Player is reading, writing, or transmitting the file.
  - The SWF tried to upload a file to a server that requires authentication (such as a user name and password). During upload, Flash Player does not provide a means for users to enter passwords.
  - The `url` parameter contains an invalid protocol. The `FileReference.upload()` method must use either HTTP or HTTPS.

TIP

Flash Player does not offer complete support for servers that require authentication. Only SWF files that are running in a browser using the browser plug-in or Microsoft ActiveX® control can provide a dialog box to prompt the user to enter a user name and password for authentication, and then only for downloads. For uploads using the plug-in or ActiveX control or upload/download using either the stand-alone or external player, the file transfer fails.

If you create a server script in ColdFusion to accept a file upload from Flash Player, you can use code similar to the following:

```
<cffile action="upload" filefield="Filedata" destination="#ExpandPath('./
')#" nameconflict="OVERWRITE" />
```

This ColdFusion code uploads the file sent by Flash Player and saves it to the same directory as the ColdFusion template, overwriting any file with the same name. The previous code shows the bare minimum amount of code necessary to accept a file upload; this script should not be used in a production environment. Ideally, you should add data validation to ensure that users upload only accepted file types, such as an image instead of a potentially dangerous server-side script.

The following code demonstrates file uploads using PHP, and it includes data validation. The script limits the number of uploaded files in the upload directory to 10, ensures that the file is less than 200 KB, and permits only JPEG, GIF, or PNG files to be uploaded and saved to the file system.

```
<?php
$MAXIMUM_FILESIZE = 1024 * 200; // 200KB
$MAXIMUM_FILE_COUNT = 10; // keep maximum 10 files on server
echo exif_imagetype($_FILES['Filedata']);
if ($_FILES['Filedata']['size'] <= $MAXIMUM_FILESIZE)
{
```

```

move_uploaded_file($_FILES['Filedata']['tmp_name'], "./temporary/
".$_FILES['Filedata']['name']);
$type = exif_imagetype("./temporary/".$_FILES['Filedata']['name']);
if ($type == 1 || $type == 2 || $type == 3)
{
    rename("./temporary/".$_FILES['Filedata']['name'], "./images/
".$_FILES['Filedata']['name']);
}
else
{
    unlink("./temporary/".$_FILES['Filedata']['name']);
}
}
$directory = opendir('./images/');
$files = array();
while ($file = readdir($directory))
{
    array_push($files, array('./images/'.$file, filectime('./images/
'.$file)));
}
usort($files, sorter);
if (count($files) > $MAXIMUM_FILE_COUNT)
{
    $files_to_delete = array_splice($files, 0, count($files) -
$MAXIMUM_FILE_COUNT);
    for ($i = 0; $i < count($files_to_delete); $i++)
    {
        unlink($files_to_delete[$i][0]);
    }
}
print_r($files);
closedir($directory);

function sorter($a, $b)
{
    if ($a[1] == $b[1])
    {
        return 0;
    }
    else
    {
        return ($a[1] < $b[1]) ? -1 : 1;
    }
}
?>

```

You can pass additional variables to the upload script using either the POST or GET request method. To send additional POST variables to your upload script, you can use the following code:

```
var fileRef:FileReference = new FileReference();
fileRef.addEventListener(Event.SELECT, selectHandler);
fileRef.addEventListener(Event.COMPLETE, completeHandler);
fileRef.browse();
function selectHandler(event:Event):void
{
    var params:URLVariables = new URLVariables();
    params.date = new Date();
    params.ssid = "94103-1394-2345";
    var request:URLRequest = new URLRequest("http://www.yourdomain.com/
    FileReferenceUpload/fileupload.cfm");
    request.method = URLRequestMethod.POST;
    request.data = params;
    fileRef.upload(request, "Custom1");
}
function completeHandler(event:Event):void
{
    trace("uploaded");
}
```

The previous example creates a new `URLVariables` object that you pass to the remote server-side script. In previous versions of `ActionScript`, you could pass variables to the server upload script by passing values in the query string. `ActionScript 3.0` allows you to pass variables to the remote script using a `URLRequest` object, which allows you to pass data using either the `POST` or `GET` method; this, in turn, makes passing larger sets of data easier and cleaner. In order to specify whether the variables are passed using the `GET` or `POST` request method, you can set the `URLRequest.method` property to either `URLRequestMethod.GET` or `URLRequestMethod.POST`, respectively.

`ActionScript 3.0` also lets you override the default `Filedata` upload file field name by providing a second parameter to the `upload()` method, as demonstrated in the previous example (which replaced the default value `Filedata` with `Custom1`).

By default, `Flash Player` will not attempt to send a test upload, although you can override this by passing a value of `true` as the third parameter to the `upload()` method. The purpose of the test upload is to check whether the actual file upload will be successful and that server authentication, if required, will succeed.

**NOTE**

A test upload occurs only on Windows-based `Flash Players` at this time.

## Downloading files from a server

You can let users download files from a server using the `FileReference.download()` method, which takes two parameters: `request` and `defaultFileName`. The first parameter is the `URLRequest` object that contains the URL of the file to download. The second parameter is optional—it lets you specify a default filename that appears in the download file dialog box. If you omit the second parameter, `defaultFileName`, the filename from the specified URL is used.

The following code downloads a file named `index.xml` from the same directory as the SWF document:

```
var request:URLRequest = new URLRequest("index.xml");
var fileRef:FileReference = new FileReference();
fileRef.download(request);
```

To set the default name to `currentnews.xml` instead of `index.xml`, specify the `defaultFileName` parameter, as the following snippet shows:

```
var request:URLRequest = new URLRequest("index.xml");
var fileToDownload:FileReference = new FileReference();
fileToDownload.download(request, "currentnews.xml");
```

Renaming a file can be very useful if the server filename was not intuitive or was server-generated. It's also good to explicitly specify the `defaultFileName` parameter when you download a file using a server-side script, instead of downloading the file directly. For example, you need to specify the `defaultFileName` parameter if you have a server-side script that downloads specific files based on URL variables passed to it. Otherwise, the default name of the downloaded file is the name of your server-side script.

Data can be sent to the server using the `download()` method by appending parameters to the URL for the server script to parse. The following ActionScript 3.0 snippet downloads a document based on which parameters are passed to a ColdFusion script:

```
package
{
    import flash.display.Sprite;
    import flash.net.FileReference;
    import flash.net.URLRequest;
    import flash.net.URLRequestMethod;
    import flash.net.URLVariables;

    public class DownloadFileExample extends Sprite
    {
```

```

private var fileToDownload:FileReference;
public function DownloadFileExample()
{
    var request:URLRequest = new URLRequest();
    request.url = "http://www.[yourdomain].com/downloadfile.cfm";
    request.method = URLRequestMethod.GET;
    request.data = new URLVariables("id=2");
    fileToDownload = new FileReference();
    try
    {
        fileToDownload.download(request, "file2.txt");
    }
    catch (error:Error)
    {
        trace("Unable to download file.");
    }
}
}
}

```

The following code demonstrates the ColdFusion script, `download.cfm`, that downloads one of two files from the server, depending on the value of a URL variable:

```

<cfparam name="URL.id" default="1" />
<cfswitch expression="#URL.id#">
    <cfcase value="2">
        <cfcontent type="text/plain" file="#ExpandPath('two.txt')#"
        deletefile="No" />
    </cfcase>
    <cfdefaultcase>
        <cfcontent type="text/plain" file="#ExpandPath('one.txt')#"
        deletefile="No" />
    </cfdefaultcase>
</cfswitch>

```

## FileReferenceList class

The `FileReferenceList` class lets the user select one or more files to upload to a server-side script. The file upload is handled by the `FileReference.upload()` method, which must be called on each file that the user selects.

The following code creates two `FileFilter` objects (`imageFilter` and `textFilter`) and passes them in an array to the `FileReferenceList.browse()` method. This causes the operating system file dialog box to display two possible filters for file types.

```

var imageFilter:FileFilter = new FileFilter("Image Files (*.jpg, *.jpeg,
*.gif, *.png)", "*.jpg; *.jpeg; *.gif; *.png");
var textFilter:FileFilter = new FileFilter("Text Files (*.txt, *.rtf)",
 "*.txt; *.rtf");
var fileRefList:FileReferenceList = new FileReferenceList();

```



```

try
{
    var success:Boolean = fileRefList.browse(new Array(imageFilter,
        textFilter));
}
catch (error:Error)
{
    trace("Unable to browse for files.");
}

```

Allowing the user to select and upload one or more files by using the `FileReferenceList` class is the same as using `FileReference.browse()` to select files, although the `FileReferenceList` allows you to select more than one file. Uploading multiple files requires you to upload each of the selected files by using `FileReference.upload()`, as the following code shows:

```

var fileRefList:FileReferenceList = new FileReferenceList();
fileRefList.addEventListener(Event.SELECT, selectHandler);
fileRefList.browse();

function selectHandler(event:Event):void
{
    var request:URLRequest = new URLRequest("http://www.[yourdomain].com/
fileUploadScript.cfm");
    var file:FileReference;
    var files:FileReferenceList = FileReferenceList(event.target);
    var selectedFileArray:Array = files.fileList;
    for (var i:uint = 0; i < selectedFileArray.length; i++)
    {
        file = FileReference(selectedFileArray[i]);
        file.addEventListener(Event.COMPLETE, completeHandler);
        try
        {
            file.upload(request);
        }
        catch (error:Error)
        {
            trace("Unable to upload files.");
        }
    }
}

function completeHandler(event:Event):void
{
    trace("uploaded");
}

```

Because the `Event.COMPLETE` event is added to each individual `FileReference` object in the array, Flash Player calls the `completeHandler()` method when each individual file finishes uploading.

# Example: Building a Telnet client

The Telnet example demonstrates techniques for connecting with a remote server and transmitting data using the Socket class. The example demonstrates the following techniques:

- Creating a custom telnet client using the Socket class
- Sending text to the remote server using a ByteArray object
- Handling received data from a remote server

To get the application files for this sample, see [www.adobe.com/go/learn\\_programmingAS3samples\\_flash](http://www.adobe.com/go/learn_programmingAS3samples_flash). The Telnet application files can be found in the Samples/Telnet folder. The application consists of the following files:

---

File	Description
TelnetSocket.mxml	The main application file consisting of the MXML user interface.
com/example/programmingas3/Telnet/Telnet.as	Provides the Telnet client functionality for the application, such as connecting to a remote server, and sending, receiving, and displaying data.

---

## Telnet socket application overview

The main TelnetSocket.mxml file is responsible for creating the user interface (UI) for the entire application.

In addition to the UI, this file also defines two methods, `login()` and `sendCommand()`, to connect the user to the specified server.

The following code lists the ActionScript in the main application file:

```
import com.example.programmingas3.socket.Telnet;

private var telnetClient:Telnet;
private function connect():void
{
    telnetClient = new Telnet(serverName.text, int(portNumber.text), output);
    console.title = "Connecting to " + serverName.text + ":" +
    portNumber.text;
    console.enabled = true;
}
private function sendCommand():void
{
```

```

var ba:ByteArray = new ByteArray();
ba.writeMultiByte(command.text + "\n", "UTF-8");
telnetClient.writeBytesToSocket(ba);
command.text = "";
}

```

The first line of code imports the `Telnet` class from the custom `com.example.programmingas.socket` package. The second line of code declares an instance of the `Telnet` class, `telnetClient`, that will be initialized later by the `connect()` method. Next, the `connect()` method is declared and initializes the `telnetClient` variable declared earlier. This method passes the user-specified telnet server name, telnet server port, and a reference to a `TextArea` component on the display list, which is used to display the text responses from the socket server. The final two lines of the `connect()` method set the `title` property for the `Panel` and enable the `Panel` component, which allows the user to send data to the remote server. The final method in the main application file, `sendCommand()`, is used to send the user's commands to the remote server as a `ByteArray` object.

## Telnet class overview

The `Telnet` class is responsible for connecting to the remote Telnet server and sending/receiving data.

The `Telnet` class declares the following private variables:

```

private var serverURL:String;
private var portNumber:int;
private var socket:Socket;
private var ta:TextArea;
private var state:int = 0;

```

The first variable, `serverURL`, contains the user-specified server address to connect to.

The second variable, `portNumber`, is the port number that the Telnet server is currently running on. By default, the Telnet service runs on port 23.

The third variable, `socket`, is a `Socket` instance that will attempt to connect to the server defined by the `serverURL` and `portNumber` variables.

The fourth variable, `ta`, is a reference to a `TextArea` component instance on the `Stage`. This component is used to display responses from the remote Telnet server, or any possible error messages.

The final variable, `state`, is a numeric value that is used to determine which options your Telnet client supports.

As you saw before, the `Telnet` class's constructor function is called by the `connect()` method in the main application file.

The Telnet constructor takes three parameters: server, port, and output. The server and port parameters specify the server name and port number where the Telnet server is running. The final parameter, output, is a reference to a TextArea component instance on the Stage where server output will be displayed to users.

```
public function Telnet(server:String, port:int, output:TextArea)
{
    serverURL = server;
    portNumber = port;
    ta = output;
    socket = new Socket();
    socket.addEventListener(Event.CONNECT, connectHandler);
    socket.addEventListener(Event.CLOSE, closeHandler);
    socket.addEventListener(ErrorEvent.ERROR, errorHandler);
    socket.addEventListener(IOErrorEvent.IO_ERROR, ioErrorHandler);
    socket.addEventListener(ProgressEvent.SOCKET_DATA, dataHandler);
    Security.loadPolicyFile("http://" + serverURL + "/crossdomain.xml");
    try
    {
        msg("Trying to connect to " + serverURL + ":" + portNumber + "\n");
        socket.connect(serverURL, portNumber);
    }
    catch (error:Error)
    {
        msg(error.message + "\n");
        socket.close();
    }
}
```

## Writing data to a socket

To write data to a socket connection, you call any of the write methods in the Socket class (such as writeBoolean(), writeByte(), writeBytes(), or writeDouble()), and then flush the data in the output buffer using the flush() method. In the Telnet server, data is written to the socket connection using the writeBytes() method which takes the byte array as a parameter and sends it to the output buffer. The writeBytesToSocket() method is as follows:

```
public function writeBytesToSocket(ba:ByteArray):void
{
    socket.writeBytes(ba);
    socket.flush();
}
```

This method gets called by the sendCommand() method of the main application file.

## Displaying messages from the socket server

Whenever a message is received from the socket server, or an event occurs, the custom `msg()` method is called. This method appends a string to the `TextArea` on the Stage and calls a custom `setScroll()` method, which causes the `TextArea` component to scroll to the very bottom. The `msg()` method is as follows:

```
private function msg(value:String):void
{
    ta.text += value;
    setScroll();
}
```

If you didn't automatically scroll the contents of the `TextArea` component, users would need to manually drag the scroll bars on the text area to see the latest response from the server.

## Scrolling a `TextArea` component

The `setScroll()` method contains a single line of `ActionScript` that scrolls the `TextArea` component's contents vertically so the user can see the last line of the returned text. The following snippet shows the `setScroll()` method:

```
public function setScroll():void
{
    ta.verticalScrollPosition = ta.maxVerticalScrollPosition;
}
```

This method sets the `verticalScrollPosition` property, which is the line number of the top row of characters that is currently displayed, and sets it to the value of the `maxVerticalScrollPosition` property.

## Example: Uploading and downloading files

The `FileIO` example demonstrates techniques for performing file downloading and uploading in Flash Player. These techniques are:

- Downloading files to a user's computer
- Uploading files from a user's computer to a server
- Cancelling a download in progress
- Cancelling an upload in progress

To get the application files for this sample, see [www.adobe.com/go/learn\\_programmingAS3samples\\_flash](http://www.adobe.com/go/learn_programmingAS3samples_flash). The FileIO application files are found in the Samples/FileIO folder. The application consists of the following files:

File	Description
FileIO fla or FileIO.mxml	The main application file in Flash (FLA) or Flex (MXML).
com/example/programmingas3/fileio/ FileDownload.as	A class that includes methods for downloading files from a server.
com/example/programmingas3/fileio/ FileUpload.as	A class that includes methods for uploading files to a server.

## FileIO application overview

The FileIO application contains the user interface that allows a user to upload or download files using Flash Player. The application first defines a couple of custom components, FileUpload and FileDownload, which can be found in the `com.example.programmingas3.fileio` package. Once each custom component dispatches its `contentComplete` event, the component's `init()` method is called and passes references to a `ProgressBar` and `Button` component instance, which allow users to see the file's upload or download progress or cancel the file transfer in progress.

The relevant code from the `FileIO.mxml` file is as follows (Note that in the Flash version, the FLA file contains components placed on the stage, whose names match the names of the Flex components described in this step):

```
<example:FileUpload id="fileUpload"  
  creationComplete="fileUpload.init(uploadProgress, cancelUpload);" />  
<example:FileDownload id="fileDownload"  
  creationComplete="fileDownload.init(downloadProgress, cancelDownload);" />
```

The following code shows the Upload File panel, which contains a progress bar and two buttons. The first button, `startUpload`, calls the `FileUpload.startUpload()` method, which calls the `FileReference.browse()` method. The following excerpt shows the code for the Upload File panel:

```
<mx:Panel title="Upload File" paddingTop="10" paddingBottom="10"
paddingLeft="10" paddingRight="10">
  <mx:ProgressBar id="uploadProgress" label="" mode="manual" />
  <mx:ControlBar horizontalAlign="right">
    <mx:Button id="startUpload" label="Upload..."
click="fileUpload.startUpload();" />
    <mx:Button id="cancelUpload" label="Cancel"
click="fileUpload.cancelUpload();" enabled="false" />
  </mx:ControlBar>
</mx:Panel>
```

This code places a `ProgressBar` component instance and two `Button` component button instances on the Stage. When the user clicks the Upload button (`startUpload`), an operating system dialog box is launched that allows the user to select a file to upload to a remote server. The other button, `cancelUpload`, is disabled by default, although when a user begins a file upload, the button becomes enabled and allows the user to abort the file transfer at any time.

The code for the Download File panel is as follows:

```
<mx:Panel title="Download File" paddingTop="10" paddingBottom="10"
paddingLeft="10" paddingRight="10">
  <mx:ProgressBar id="downloadProgress" label="" mode="manual" />
  <mx:ControlBar horizontalAlign="right">
    <mx:Button id="startDownload" label="Download..."
click="fileDownload.startDownload();" />
    <mx:Button id="cancelDownload" label="Cancel"
click="fileDownload.cancelDownload();" enabled="false" />
  </mx:ControlBar>
</mx:Panel>
```

This code is very similar to the file upload code. When the user clicks the Download button, (`startDownload`), the `FileDownload.startDownload()` method is called, which begins downloading the file specified in the `FileDownload.DOWNLOAD_URL` variable. As the file downloads, the progress bar updates, showing what percentage of the file has downloaded. The user can cancel the download at any point by clicking the `cancelDownload` button, which immediately stops the file download in progress.

## Downloading files from a remote server

Downloading of files from a remote server is handled by the `flash.net.FileReference` class and the custom `com.example.programmingas3.fileio.FileDownload` class. When the user clicks the Download button, Flash Player begins to download the file specified in the `FileDownload` class's `DOWNLOAD_URL` variable.

The `FileDownload` class begins by defining four variables within the `com.example.programmingas3.fileio` package, as the following code shows:

```
/**
 * Hard-code the URL of file to download to user's computer.
 */
private const DOWNLOAD_URL:String = "http://www.yourdomain.com/
file_to_download.zip";

/**
 * Create a FileReference instance to handle the file download.
 */
private var fr:FileReference;

/**
 * Define reference to the download ProgressBar component.
 */
private var pb:ProgressBar;

/**
 * Define reference to the "Cancel" button which will immediately stop
 * the current download in progress.
 */
private var btn:Button;
```

The first variable, `DOWNLOAD_URL`, contains the path to the file, which gets downloaded onto the user's computer when the user clicks the Download button in the main application file.

The second variable, `fr`, is a `FileReference` object that gets initialized within the `FileDownload.init()` method and will handle the downloading of the remote file to the user's computer.

The last two variables, `pb` and `btn`, contain references to `ProgressBar` and `Button` component instances on the Stage, which get initialized by the `FileDownload.init()` method.



## Initializing the FileDownload component

The FileDownload component is initialized by calling the `init()` method in the FileDownload class. This method takes two parameters, `pb` and `btn`, which are ProgressBar and Button component instances, respectively.

The code for the `init()` method is as follows:

```
/**
 * Set references to the components, and add listeners for the OPEN,
 * PROGRESS, and COMPLETE events.
 */
public function init(pb:ProgressBar, btn:Button):void
{
    // Set up the references to the progress bar and cancel button,
    // which are passed from the calling script.
    this.pb = pb;
    this.btn = btn;

    fr = new FileReference();
    fr.addEventListener(Event.OPEN, openHandler);
    fr.addEventListener(ProgressEvent.PROGRESS, progressHandler);
    fr.addEventListener(Event.COMPLETE, completeHandler);
}
```

## Beginning the file download

When the user clicks the Download Button component instance on the Stage, the `startDownload()` method is to initiate the file download process. The following excerpt shows the `startDownload()` method:

```
/**
 * Begin downloading the file specified in the DOWNLOAD_URL constant.
 */
public function startDownload():void
{
    var request:URLRequest = new URLRequest();
    request.url = DOWNLOAD_URL;
    fr.download(request);
}
```

First, the `startDownload()` method creates a new `URLRequest` object, and sets the target URL to the value specified by the `DOWNLOAD_URL` variable. Next, the `FileReference.download()` method is called, and the newly created `URLRequest` object is passed as a parameter. This causes the operating system to display a dialog box on the user's computer prompting them to select a location to save the requested document. Once the user selects a location, the open event (`Event.OPEN`) is dispatched and the `openHandler()` method is invoked.

The `openHandler()` method sets the text format for the `ProgressBar` component's `label` property, and enables the Cancel button, which allows the user to immediately stop the download in progress. The `openHandler()` method is as follows:

```
/**
 * When the OPEN event has dispatched, change the progress bar's label
 * and enable the "Cancel" button, which allows the user to abort the
 * download operation.
 */
private function openHandler(event:Event):void
{
    pb.label = "DOWNLOADING %3%";
    btn.enabled = true;
}
```

## Monitoring a file's download progress

As a file downloads from a remote server to the user's computer, the progress event (`ProgressEvent.PROGRESS`) is dispatched at regular intervals. Whenever the progress event is dispatched, the `progressHandler()` method is invoked and the `ProgressBar` component instance on the Stage is updated. The code for the `progressHandler()` method is as follows:

```
/**
 * While the file is downloading, update the progress bar's status.
 */
private function progressHandler(event:ProgressEvent):void
{
    pb.setProgress(event.bytesLoaded, event.bytesTotal);
}
```

The progress event contains two properties, `bytesLoaded` and `bytesTotal`, which are used to update the `ProgressBar` component on the Stage. This gives the user a sense of how much of the file has already finished downloading and how much remains. The user can abort the file transfer at any time by clicking the Cancel button below the progress bar.

If the file is downloaded successfully, the `complete` event (`Event.COMPLETE`) invokes the `completeHandler()` method, which notifies the user that the file has completed downloading and disables the Cancel button. The code for the `completeHandler()` method is as follows:

```
/**
 * Once the download has completed, change the progress bar's label one
 * last time and disable the "Cancel" button since the download is
 * already completed.
 */
private function completeHandler(event:Event):void
{
    pb.label = "DOWNLOAD COMPLETE";
    btn.enabled = false;
}
```

## Cancelling a file download

A user can abort a file transfer and stop any further bytes from being downloaded at any time by clicking the Cancel button on the Stage. The following excerpt shows the code for cancelling a download:

```
/**
 * Cancel the current file download.
 */
public function cancelDownload():void
{
    fr.cancel();
    pb.label = "DOWNLOAD CANCELLED";
    btn.enabled = false;
}
```

First, the code stops the file transfer immediately, preventing any further data from downloading. Next, the progress bar's label property is updated to notify the user that the download has been successfully cancelled. Finally, the Cancel button is disabled, which prevents the user from clicking the button again until they attempt to download the file again.

## Uploading files to a remote server

The file upload process is very similar to the file download process. The `FileUpload` class declares the same four variables, as shown in the following code:

```
private const UPLOAD_URL:String = "http://www.yourdomain.com/  
    your_upload_script.cfm";  
private var fr:FileReference;  
private var pb:ProgressBar;  
private var btn:Button;
```

Unlike the `FileDownload.DOWNLOAD_URL` variable, the `UPLOAD_URL` variable contains the URL to the server-side script that will upload the file from the user's computer. The remaining three variables behave the same as their counterparts in the `FileDownload` class.

## Initializing the FileUpload component

The `FileUpload` component contains an `init()` method, which gets called from the main application. This method takes two parameters, `pb` and `btn`, which are references to a `ProgressBar` and `Button` component instance on the Stage. Next, the `init()` method initializes the `FileReference` object defined earlier in the `FileUpload` class. Finally, the method assigns four event listeners to the `FileReference` object. The code for the `init()` method is as follows:

```
public function init(pb:ProgressBar, btn:Button):void  
{  
    this.pb = pb;  
    this.btn = btn;  
  
    fr = new FileReference();  
    fr.addEventListener(Event.SELECT, selectHandler);  
    fr.addEventListener(Event.OPEN, openHandler);  
    fr.addEventListener(ProgressEvent.PROGRESS, progressHandler);  
    fr.addEventListener(Event.COMPLETE, completeHandler);  
}
```

## Beginning a file upload

The file upload is initiated when the user clicks on the Upload button on the Stage, which invokes the `FileUpload.startUpload()` method. This method calls the `browse()` method of the `FileReference` class which causes the operating system to display a system dialog box prompting the user to select a file to upload to the remote server. The following excerpt shows the code for the `startUpload()` method:

```
public function startUpload():void
{
    fr.browse();
}
```

Once the user selects a file to upload, the `select` event (`Event.SELECT`) is dispatched, causing the `selectHandler()` method to be invoked. The `selectHandler()` method creates a new `URLRequest` object and sets the `URLRequest.url` property to the value of the `UPLOAD_URL` constant defined earlier in the code. Finally, the `FileReference` object uploads the selected file to the specified server-side script. The code for the `selectHandler()` method is as follows:

```
private function selectHandler(event:Event):void
{
    var request:URLRequest = new URLRequest();
    request.url = UPLOAD_URL;
    fr.upload(request);
}
```

The remaining code in the `FileUpload` class is the same as the code defined in the `FileDownload` class. If a user wishes to terminate the upload at any point, they can click the Cancel button, which sets the label on the progress bar and stops the file transfer immediately. The progress bar gets updated whenever the `progress` event (`ProgressEvent.PROGRESS`) is dispatched. Similarly, once the upload has completed, the progress bar is updated to notify the user that the file has uploaded successfully. The Cancel button is then disabled until the user begins a new file transfer.



This chapter explains how to interact with the user's system. It shows you how to determine what features are supported and how to build multilingual SWF files using the user's installed input method editor (IME) if available. It also shows typical uses for application domains.

## Contents

Basics of the client system environment . . . . .	695
Using the System class . . . . .	698
Using the Capabilities class . . . . .	699
Using the ApplicationDomain class . . . . .	700
Using the IME class . . . . .	704
Example: Detecting system capabilities . . . . .	709

## Basics of the client system environment

### Introduction to the client system environment

As you build more advanced ActionScript applications, you may find a need to know details about—and access functions of—your users' operating systems. The client system environment is a collection of classes in the `flash.system` package that allow you to access system-level functionality such as the following:

- Determining which application and security domain a SWF is executing in
- Determining the capabilities of the user's Flash Player, such as the screen size (resolution) and whether certain functionality is available, such as mp3 audio
- Building multilingual sites using the IME
- Interacting with the Flash Player's container (which could be an HTML page or a container application)
- Saving information to the user's clipboard

The `flash.system` package also includes the `IMEConversionMode` and `SecurityPanel` classes. These classes contain static constants that you use with the `IME` and `Security` classes, respectively.

## Common client system environment tasks

The following common tasks for working with the client system using `ActionScript` are described in this chapter:

- Determining how much memory your application is using
- Copying text to the user's clipboard
- Determining capabilities of the user's computer, such as:
  - Screen resolution, color, DPI, and pixel aspect ratio
  - Operating system
  - Support for streaming audio, streaming video, and mp3 playback
  - Whether the installed Flash Player is a debugger version
- Working with application domains:
  - Defining an application domain
  - Separating SWF files' code into application domains
- Working with an IME in your application:
  - Determining whether an IME is installed
  - Determining and setting the IME conversion mode
  - Disabling the IME for text fields
  - Detecting when IME conversion happens

## Important concepts and terms

The following reference list contains important terms used in this chapter:

- **Operating system:** The main program that runs on a computer, within which all other applications run—such as Microsoft Windows, Mac OS X, or Linux®.
- **Clipboard:** The operating system's container for holding text or items that are copied or cut, and from which items are pasted into applications.
- **Application domain:** A mechanism for separating classes used in different SWF files, so that if the SWF files include different classes with the same name, the classes don't overwrite each other.



- IME (input method editor): A program (or operating system tool) that is used to enter complex characters or symbols using a standard keyboard.
- Client system: In programming terms, a *client* is the part of an application (or whole application) that runs on an individual's computer and is used by a single user. The *client system* is the underlying operating system on the user's computer.

## Working through in-chapter examples

As you're working through the chapter, you may want to test some of the example code listings for yourself. All the code listings in this chapter include the appropriate `trace()` function call for writing out the values being tested. To test the code listings in this chapter:

1. Create an empty Flash document.
2. Select a keyframe in the timeline.
3. Open the Actions panel and copy the code listing into the Script pane.
4. Run the program using Control > Test Movie.

You will see the results of the code listing's `trace()` functions in the Output panel.

Some of the later code listings are more complex and are written as a class. To test these examples:

1. Create an empty Flash document and save it to your computer.
2. Create a new ActionScript file and save it in the same directory as the Flash document. The file's name should match the name of the class in the code listing. For instance, if the code listing defines a class named `SystemTest`, use the name `SystemTest.as` to save the ActionScript file.
3. Copy the code listing into the ActionScript file and save the file.
4. In the Flash document, click a blank part of the Stage or work space to activate the document Property inspector.
5. In the Property inspector, in the Document Class field, enter the name of the ActionScript class you copied from the text.
6. Run the program using Control > Test Movie

You will see the results of the example in the Output panel.

Techniques for testing example code listings are described in more detail in [“Testing in-chapter example code listings” on page 63](#).

# Using the System class

The `System` class contains methods and properties that allow you to interact with the user's operating system and retrieve the current memory usage for Adobe Flash Player. The methods and properties of the `System` class also allow you to listen for `imeComposition` events, instruct Flash Player to load external text files using the user's current code page or to load them as Unicode, or set the contents of the user's clipboard.

## Getting data about the user's system at run time

By checking the `System.totalMemory` property, you can determine the amount of memory (in bytes) that Flash Player is currently using. This property allows you to monitor memory usage and optimize your applications based on how the memory level changes. For example, if a particular visual effect causes a large increase in memory usage, you may want to consider modifying the effect or eliminating it altogether.

The `System.ime` property is a reference to the currently installed Input Method Editor (IME). This property allows you to listen for `imeComposition` events (`flash.events.IMEvent.IME_COMPOSITION`) by using the `addEventListener()` method.

The third property in the `System` class is `useCodePage`. When `useCodePage` is set to `true`, Flash Player uses the traditional code page of the operating system that is running the player to load external text files. If you set this property to `false`, you tell Flash Player to interpret the external file as Unicode.

If you set `System.useCodePage` to `true`, remember that the traditional code page of the operating system running the player must include the characters used in your external text file in order for the text to display. For example, if you load an external text file that contains Chinese characters, those characters cannot display on a system that uses the English Windows code page because that code page does not include Chinese characters.

To ensure that users on all platforms can view the external text files that are used in your SWF files, you should encode all external text files as Unicode and leave `System.useCodePage` set to `false` by default. This way, Flash Player interprets the text as Unicode.

## Saving text to the clipboard

The `System` class includes a method called `setClipboard()` that allows Flash Player to set the contents of the user's clipboard with a specified string. For security reasons, there is no `Security.getClipboard()` method, since such a method could potentially allow malicious sites to access the data last copied to the user's clipboard.

The following code illustrates how an error message can be copied to the user's clipboard when a security error occurs. The error message can be useful if the user wants to report a potential bug with an application.

```
private function securityErrorHandler(event:SecurityErrorEvent):void
{
    var errorString:String = "[" + event.type + "]" + event.text;
    trace(errorString);
    System.setClipboard(errorString);
}
```

## Using the Capabilities class

The `Capabilities` class allows developers to determine the environment in which a SWF file is being run. Using various properties of the `Capabilities` class, you can find out the resolution of the user's system, whether the user's system supports accessibility software, and the language of the user's operating system, as well as the version of the currently installed Flash Player.

By checking the properties in the `Capabilities` class, you can customize your application to work best with the specific user's environment. For example, by checking the `Capabilities.screenResolutionX` and `Capabilities.screenResolutionY` properties, you can determine the display resolution the user's system is using and decide which video size may be most appropriate. Or you can check the `Capabilities.hasMP3` property to see if the user's system supports mp3 playback before attempting to load an external mp3 file.

The following code uses a regular expression to parse the Flash Player version that the client is using:

```
var versionString:String = Capabilities.version;
var pattern:RegExp = /^(\w*) (\d*),(\d*),(\d*).(\d*)$/;
var result:Object = pattern.exec(versionString);
if (result != null)
{
```

```

    trace("input: " + result.input);
    trace("platform: " + result[1]);
    trace("majorVersion: " + result[2]);
    trace("minorVersion: " + result[3]);
    trace("buildNumber: " + result[4]);
    trace("internalBuildNumber: " + result[5]);
}
else
{
    trace("Unable to match RegExp.");
}

```

If you want to send the user's system capabilities to a server-side script so that the information can be stored in a database, you can use the following ActionScript code:

```

var url:String = "log_visitor.cfm";
var request:URLRequest = new URLRequest(url);
request.method = URLRequestMethod.POST;
request.data = new URLVariables(Capabilities.serverString);
var loader:URLLoader = new URLLoader(request);

```

## Using the ApplicationDomain class

The purpose of the `ApplicationDomain` class is to store a table of ActionScript 3.0 definitions. All code in a SWF file is defined to exist in an application domain. You use application domains to partition classes that are in the same security domain. This allows multiple definitions of the same class to exist and also lets children reuse parent definitions.

You can use application domains when loading an external SWF file written in ActionScript 3.0 using the `Loader` class API. (Note that you cannot use application domains when loading an image or SWF file written in ActionScript 1.0 or ActionScript 2.0.) All ActionScript 3.0 definitions contained in the loaded class are stored in the application domain. When loading the SWF file, you can specify that the file be included in the same application domain as that of the `Loader` object, by setting the `applicationDomain` parameter of the `LoaderContext` object to `ApplicationDomain.currentDomain`. By putting the loaded SWF file in the same application domain, you can access its classes directly. This can be useful if you are loading a SWF file that contains embedded media, which you can access via their associated class names, or if you want to access the loaded SWF file's methods, as shown in the following example:

```

package
{
    import flash.display.Loader;
    import flash.display.Sprite;
    import flash.events.*;
    import flash.net.URLRequest;
    import flash.system.ApplicationDomain;
    import flash.system.LoaderContext;

    public class ApplicationDomainExample extends Sprite
    {
        private var ldr:Loader;
        public function ApplicationDomainExample()
        {
            ldr = new Loader();
            var req:URLRequest = new URLRequest("Greeter.swf");
            var ldrContext:LoaderContext = new LoaderContext(false,
ApplicationDomain.currentDomain);
            ldr.contentLoaderInfo.addEventListener(Event.COMPLETE,
completeHandler);
            ldr.load(req, ldrContext);
        }
        private function completeHandler(event:Event):void
        {
            ApplicationDomain.currentDomain.getDefinition("Greeter");
            var myGreeter:Greeter = Greeter(event.target.content);
            var message:String = myGreeter.welcome("Tommy");
            trace(message); // Hello, Tommy
        }
    }
}

```

Other things to keep in mind when you work with application domains include the following:

- All code in a SWF file is defined to exist in an application domain. The *current domain* is where your main application runs. The *system domain* contains all application domains, including the current domain, which means that it contains all Flash Player classes.
- All application domains, except the system domain, have an associated parent domain. The parent domain for your main application's application domain is the system domain. Loaded classes are defined only when their parent doesn't already define them. You cannot override a loaded class definition with a newer definition.

The following diagram shows an application that loads content from various SWF files within a single domain, domain1.com. Depending on the content you load, different application domains can be used. The text that follows describes the logic used to set the appropriate application domain for each SWF file in the application.

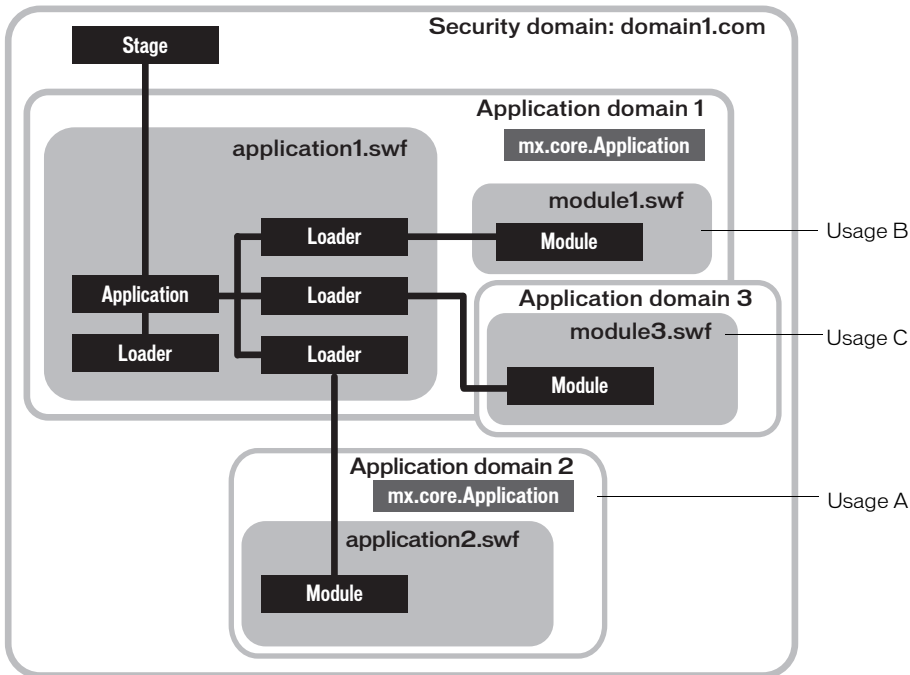

The main application file is application1.swf. It contains Loader objects that load content from other SWF files. In this scenario, the current domain is Application domain 1. Usage A, usage B, and usage C illustrate different techniques for setting the appropriate application domain for each SWF file in an application.

**Usage A:** Partition the child SWF file by creating a child of the system domain. In the diagram, Application domain 2 is created as a child of the system domain. The application2.swf file is loaded in Application domain 2, and its class definitions are thus partitioned from the classes defined in application1.swf.

One use of this technique is to have an old application dynamically loading a newer version of the same application without conflict. There is no conflict because although the same class names are used, they are partitioned into different application domains.

The following code creates an application domain that is a child of the system domain:

```
request.url = "application2.swf";  
request.applicationDomain = new ApplicationDomain();
```

**Usage B:** Add new class definitions to current class definitions. The application domain of module1.swf is set to the current domain (Application domain 1). This lets you add to the application's current set of class definitions with new class definitions. This could be used for a run-time shared library of the main application. The loaded SWF is treated as a remote shared library (RSL). Use this technique to load RSLs by a preloader before the application starts.

The following code sets an application domain to the current domain:

```
request.url = "module1.swf";  
request.applicationDomain = ApplicationDomain.currentDomain;
```

**Usage C:** Use the parent's class definitions by creating a new child domain of the current domain. The application domain of module3.swf is a child of the current domain, and the child uses the parent's versions of all classes. One use of this technique might be a module of a multiple-screen rich Internet application (RIA), loaded as a child of the main application, that uses the main application's types. If you can ensure that all classes are always updated to be backward compatible, and that the loading application is always newer than the things it loads, the children will use the parent versions. Having a new application domain also allows you to unload all the class definitions for garbage collection, if you can ensure that you do not continue to have references to the child SWF.

This technique lets loaded modules share the loader's singleton objects and static class members.

The following code creates a new child domain of the current domain:

```
request.url = "module3.swf";  
request.applicationDomain = new  
    ApplicationDomain(ApplicationDomain.currentDomain);
```

# Using the IME class

The IME class lets you manipulate the operating system's IME within Flash Player.

Using ActionScript, you can determine the following:

- If an IME is installed on the user's computer (`Capabilities.hasIME`)
- If the IME is enabled or disabled on the user's computer (`IME.enabled`)
- The conversion mode the current IME is using (`IME.conversionMode`)

You can associate an input text field with a particular IME context. When you switch between input fields, you can also switch the IME between Hiragana (Japanese), full-width numbers, half-width numbers, direct input, and so on.

An IME lets users type non-ASCII text characters in multibyte languages, such as Chinese, Japanese, and Korean.

For more information on working with IMEs, see the documentation for the operating system for which you are developing the application. For additional resources, see the following web sites:

- <http://www.microsoft.com/globaldev/default.mspx>
- <http://developer.apple.com/documentation/>
- <http://java.sun.com/>

**NOTE**

If an IME is not active on the user's computer, calls to IME methods or properties, other than `Capabilities.hasIME`, will fail. Once you manually activate an IME, subsequent ActionScript calls to IME methods and properties will work as expected. For example, if you are using a Japanese IME, you must activate it before you can call any IME method or property.

## Checking if an IME is installed and enabled

Before you call any of the IME methods or properties, you should always check to see if the user's computer currently has an IME installed and enabled. The following code illustrates how to check that the user has an IME both installed and active before you call any methods:

```
if (Capabilities.hasIME)
{
    if (IME.enabled)
    {
        trace("IME is installed and enabled.");
    }
    else
    {
```



```

        trace("IME is installed but not enabled. Please enable your IME and try
again.");
    }
}
else
{
    trace("IME is not installed. Please install an IME and try again.");
}

```

The previous code first checks to see if the user has an IME installed using the `Capabilities.hasIME` property. If this property is set to `true`, the code then checks whether the user's IME is currently enabled, using the `IME.enabled` property.

## Determining which IME conversion mode is currently enabled

When building multilingual applications, you may need to determine which conversion mode the user currently has active. The following code demonstrates how to check whether the user has an IME installed, and if so, which IME conversion mode is currently active:

```

if (Capabilities.hasIME)
{
    switch (IME.conversionMode)
    {
        case IMEConversionMode.ALPHANUMERIC_FULL:
            tf.text = "Current conversion mode is alphanumeric (full-width).";
            break;
        case IMEConversionMode.ALPHANUMERIC_HALF:
            tf.text = "Current conversion mode is alphanumeric (half-width).";
            break;
        case IMEConversionMode.CHINESE:
            tf.text = "Current conversion mode is Chinese.";
            break;
        case IMEConversionMode.JAPANESE_HIRAGANA:
            tf.text = "Current conversion mode is Japanese Hiragana.";
            break;
        case IMEConversionMode.JAPANESE_KATAKANA_FULL:
            tf.text = "Current conversion mode is Japanese Katakana (full-
width).";
            break;
        case IMEConversionMode.JAPANESE_KATAKANA_HALF:
            tf.text = "Current conversion mode is Japanese Katakana (half-
width).";
            break;
        case IMEConversionMode.KOREAN:
            tf.text = "Current conversion mode is Korean.";
            break;
        default:

```

```

        tf.text = "Current conversion mode is " + IME.conversionMode + ".";
        break;
    }
}
else
{
    tf.text = "Please install an IME and try again.";
}

```

The previous code first checks to see whether the user has an IME installed. Next it checks which conversion mode the current IME is using by comparing the `IME.conversionMode` property against each of the constants in the `IMEConversionMode` class.

## Setting the IME conversion mode

When you change the conversion mode of the user's IME, you need to make sure that the code is wrapped in a `try..catch` block, because setting a conversion mode using the `conversionMode` property can throw an error if the IME is unable to set the conversion mode. The following code demonstrates how to use a `try..catch` block when setting the `IME.conversionMode` property:

```

var statusText:TextField = new TextField;
statusText.autoSize = TextFieldAutoSize.LEFT;
addChild(statusText);
if (Capabilities.hasIME)
{
    try
    {
        IME.enabled = true;
        IME.conversionMode = IMEConversionMode.KOREAN;
        statusText.text = "Conversion mode is " + IME.conversionMode + ".";
    }
    catch (error:Error)
    {
        statusText.text = "Unable to set conversion mode.\n" + error.message;
    }
}

```

The previous code first creates a text field, which is used to display a status message to the user. Next, if the IME is installed, the code enables the IME and sets the conversion mode to Korean. If the user's computer does not have a Korean IME installed, an error is thrown by Flash Player and is caught by the `try..catch` block. The `try..catch` block displays the error message in the previously created text field.

## Disabling the IME for certain text fields

In some cases, you may want to disable the user's IME while they type characters. For example, if you had a text field that only accepts numeric input, you may not want the IME to come up and slow down data entry.

The following example demonstrates how you can listen for the `FocusEvent.FOCUS_IN` and `FocusEvent.FOCUS_OUT` events and disable the user's IME accordingly:

```
var phoneTxt:TextField = new TextField();
var nameTxt:TextField = new TextField();

phoneTxt.type = TextFieldType.INPUT;
phoneTxt.addEventListener(FocusEvent.FOCUS_IN, focusInHandler);
phoneTxt.addEventListener(FocusEvent.FOCUS_OUT, focusOutHandler);
phoneTxt.restrict = "0-9";
phoneTxt.width = 100;
phoneTxt.height = 18;
phoneTxt.background = true;
phoneTxt.border = true;
addChild(phoneTxt);

nameField.type = TextFieldType.INPUT;
nameField.x = 120;
nameField.width = 100;
nameField.height = 18;
nameField.background = true;
nameField.border = true;
addChild(nameField);

function focusInHandler(event:FocusEvent):void
{
    if (Capabilities.hasIME)
    {
        IME.enabled = false;
    }
}

function focusOutHandler(event:FocusEvent):void
{
    if (Capabilities.hasIME)
    {
        IME.enabled = true;
    }
}
```

This example creates two input text fields, `phoneTxt` and `nameTxt`, and then adds two event listeners to the `phoneTxt` text field. When the user sets focus to the `phoneTxt` text field, a `FocusEvent.FOCUS_IN` event is dispatched and the IME is disabled. When the `phoneTxt` text field loses focus, the `FocusEvent.FOCUS_OUT` event is dispatched to re-enable the IME.

## Listening for IME composition events

IME composition events are dispatched when a composition string is being set. For example, if the user has their IME enabled and active and types a string in Japanese, the `IMEEvent.IME_COMPOSITION` event would dispatch as soon as the user selects the composition string. In order to listen for the `IMEEvent.IME_COMPOSITION` event, you need to add an event listener to the static `ime` property in the `System` class (`flash.system.System.ime.addEventListener(...)`), as shown in the following example:

```
var inputTxt:TextField;
var outputTxt:TextField;

inputTxt = new TextField();
inputTxt.type = TextFieldType.INPUT;
inputTxt.width = 200;
inputTxt.height = 18;
inputTxt.border = true;
inputTxt.background = true;
addChild(inputTxt);

outputTxt = new TextField();
outputTxt.autoSize = TextFieldAutoSize.LEFT;
outputTxt.y = 20;
addChild(outputTxt);

if (Capabilities.hasIME)
{
    IME.enabled = true;
    try
    {
        IME.conversionMode = IMEConversionMode.JAPANESE_HIRAGANA;
    }
    catch (error:Error)
    {
        outputTxt.text = "Unable to change IME.";
    }
    System.ime.addEventListener(IMEEvent.IME_COMPOSITION,
        imeCompositionHandler);
}
else
{
    outputTxt.text = "Please install IME and try again.";
}

function imeCompositionHandler(event:IMEEvent):void
{
    outputTxt.text = "you typed: " + event.text;
}
```

The previous code creates two text fields and adds them to the display list. The first text field, `inputTxt`, is an input text field that allows the user to enter Japanese text. The second text field, `outputTxt`, is a dynamic text field that displays error messages to the user, or echoes the Japanese string that the user types into the `inputTxt` text field.

## Example: Detecting system capabilities

The `CapabilitiesExplorer` example demonstrates how you can use the `flash.system.Capabilities` class to determine which features the user's Flash Player supports. This example teaches the following techniques:

- Detecting which capabilities the user's Flash Player supports using the `Capabilities` class
- Using the `ExternalInterface` class to detect which browser settings the user's browser supports

To get the application files for this sample, see [www.adobe.com/go/learn\\_programmingAS3samples\\_flash](http://www.adobe.com/go/learn_programmingAS3samples_flash). The `CapabilitiesExplorer` application files can be found in the folder `Samples/CapabilitiesExplorer`. This application consists of the following files:

File	Description
<code>CapabilitiesExplorer.fla</code> or <code>CapabilitiesExplorer.mxml</code>	The main application file in Flash (FLA) or Flex (MXML).
<code>com/example/programmingas3/capabilities/CapabilitiesGrabber.as</code>	The class that provides the main functionality of the application, including adding the system <code>Capabilities</code> to an array, sorting the items, and using the <code>ExternalInterface</code> class to retrieve browser capabilities.
<code>capabilities.html</code>	An HTML container that contains the necessary JavaScript to communicate with the external API.

## CapabilitiesExplorer overview

The `CapabilitiesExplorer.mxml` file is responsible for setting up the user interface for the `CapabilitiesExplorer` application. The user's Flash Player capabilities will be displayed within a `DataGrid` component instance on the Stage. Their browser capabilities will also be displayed if they are running the application from an HTML container and if the external API is available.

When the main application file's `creationComplete` event is dispatched, the `initApp()` method is invoked. The `initApp()` method calls the `getCapabilities()` method from within the `com.example.programmingas3.capabilities.CapabilitiesGrabber` class. The code for the `initApp()` method is as follows:

```
private function initApp():void
{
    var dp:Array = CapabilitiesGrabber.getCapabilities();
    capabilitiesGrid.dataProvider = dp;
}
```

The `CapabilitiesGrabber.getCapabilities()` method returns a sorted array of the Flash Player and browser capabilities, which then gets set to the `dataProvider` property of the `capabilitiesGrid` `DataGrid` component instance on the Stage.

## CapabilitiesGrabber class overview

The static `getCapabilities()` method of the `CapabilitiesGrabber` class adds each property from the `flash.system.Capabilities` class to an array (`capDP`). It then calls the static `getBrowserObjects()` method in the `CapabilitiesGrabber` class. The `getBrowserObjects()` method uses the external API to loop over the browser's navigator object, which contains the browser's capabilities. The `getCapabilities()` method is as follows:

```
public static function getCapabilities():Array
{
    var capDP:Array = new Array();
    capDP.push({name:"Capabilities.avHardwareDisable",
    value:Capabilities.avHardwareDisable});
    capDP.push({name:"Capabilities.hasAccessibility",
    value:Capabilities.hasAccessibility});
    capDP.push({name:"Capabilities.hasAudio", value:Capabilities.hasAudio});
    ...
    capDP.push({name:"Capabilities.version", value:Capabilities.version});
    var navArr:Array = CapabilitiesGrabber.getBrowserObjects();
    if (navArr.length > 0)
    {
        capDP = capDP.concat(navArr);
    }
    capDP.sortOn("name", Array.CASEINSENSITIVE);
    return capDP;
}
```

The `getBrowserObjects()` method returns an array of each of the properties in the browser's navigator object. If this array has a length of one or more items, the array of browser capabilities (`navArr`) is appended to the array of Flash Player capabilities (`capDP`), and the entire array is sorted alphabetically. Finally, the sorted array is returned to the main application file, which then populates the data grid. The code for the `getBrowserObjects()` method is as follows:

```
private static function getBrowserObjects():Array
{
    var itemArr:Array = new Array();
    var itemVars:URLVariables;
    if (ExternalInterface.available)
    {
        try
        {
            var tempStr:String = ExternalInterface.call("JS_getBrowserObjects");
            itemVars = new URLVariables(tempStr);
            for (var i:String in itemVars)
            {
                itemArr.push({name:i, value:itemVars[i]});
            }
        }
        catch (error:SecurityError)
        {
            // ignore
        }
    }
    return itemArr;
}
```

If the external API is available in the current user environment, Flash Player calls the JavaScript `JS_getBrowserObjects()` method, which loops over the browser's navigator object and returns a string of URL-encoded values to ActionScript. This string is then converted into a `URLVariables` object (`itemVars`) and added to the `itemArr` array, which is returned to the calling script.

## Communicating with JavaScript

The final piece in building the `CapabilitiesExplorer` application is writing the necessary JavaScript to loop over each of the items in the browser's navigator object and append a name-value pair to a temporary array. The code for the JavaScript `JS_getBrowserObjects()` method in the `container.html` file is as follows:

```

<script language="JavaScript">
function JS_getBrowserObjects()
{
    // Create an array to hold each of the browser's items.
    var tempArr = new Array();

    // Loop over each item in the browser's navigator object.
    for (var name in navigator)
    {
        var value = navigator[name];

        // If the current value is a string or Boolean object, add it to the
        // array, otherwise ignore the item.
        switch (typeof(value))
        {
            case "string":
            case "boolean":

                // Create a temporary string which will be added to the array.
                // Make sure that we URL-encode the values using JavaScript's
                // escape() function.
                var tempStr = "navigator." + name + "=" + escape(value);
                // Push the URL-encoded name/value pair onto the array.
                tempArr.push(tempStr);
                break;

        }
    }
    // Loop over each item in the browser's screen object.
    for (var name in screen)
    {
        var value = screen[name];

        // If the current value is a number, add it to the array, otherwise
        // ignore the item.
        switch (typeof(value))
        {
            case "number":
                var tempStr = "screen." + name + "=" + escape(value);
                tempArr.push(tempStr);
                break;

        }
    }
    // Return the array as a URL-encoded string of name-value pairs.
    return tempArr.join("&");
}
</script>

```



The code begins by creating a temporary array that will hold all the name-value pairs in the navigator object. Next, the navigator object is looped over using a `for...in` loop, and the data type of the current value is evaluated to filter out unwanted values. In this application, we are interested only in String or Boolean values, and other data types (such as functions or arrays) are ignored. Each String or Boolean value in the navigator object is appended to the `tempArr` array. Next, the browser's screen object is looped over using a `for...in` loop, and each numeric value is added to the `tempArr` array. Finally, the temporary array is converted into a string using the `Array.join()` method. The array uses an ampersand (&) as a delimiter, which allows ActionScript to easily parse the data using the `URLVariables` class.



Adobe® Flash® Player 9 can communicate with an operating system's printing interface so that you can pass pages to the print spooler. Each page Flash Player sends to the spooler can contain content that is visible, dynamic, or offscreen to the user, including database values and dynamic text. Additionally, Flash Player sets the properties of the `flash.printing.PrintJob` class based on a user's printer settings, so that you can format pages appropriately.

This chapter details strategies for using the `flash.printing.PrintJob` class methods and properties to create a print job, read a user's print settings, and make adjustments to a print job based on feedback from Flash Player and the user's operating system.

## Contents

Basics of printing .....	716
Printing a page .....	718
Flash Player tasks and system printing .....	719
Setting size, scale, and orientation .....	722
Example: Multiple-page printing .....	725
Example: Scaling, cropping, and responding .....	727

# Basics of printing

## Introduction to printing

In ActionScript 3.0, you use the `PrintJob` class to create snapshots of display content to convert to the ink-and-paper representation in a printout. In some ways, setting up content for printing is the same as setting it up for on-screen display—you position and size elements to create the desired layout. However, printing has some idiosyncrasies that make it different from screen layout. For instance, printers use different resolution than computer monitors; the contents of a computer screen are dynamic and can change, while printed content is inherently static; and in planning printing, the constraints of fixed page size and possibility of multipage printing need to be considered.

Even though these differences may seem obvious, it's important to keep them in mind when setting up printing with ActionScript. Since accurate printing depends on a combination of the values specified by you and the characteristics of the user's printer, the `PrintJob` class includes properties that allow you to determine the important characteristics of the user's printer that you'll need to take into account.

## Common printing tasks

The following common printing tasks are described in this chapter:

- Starting a print job
- Adding pages to a print job
- Determining whether the user cancels a print job
- Specifying whether to use bitmap or vector rendering
- Setting page size, scale, and orientation
- Specifying the printable area of content
- Converting screen size to page size
- Printing multipage print jobs

## Important concepts and terms

The following reference list contains important terms used in this chapter:

- **Spooler:** A portion of the operating system or printer driver software that keeps track of pages as they are waiting to be printed and sends them to the printer when it is available.
- **Page orientation:** The rotation of the printed content in relation to the paper—either horizontal (landscape) or vertical (portrait).
- **Print job:** The page or set of pages that make up a single printout.

## Working through in-chapter examples

While you're working through this chapter, you might want to test the example code listings. Many of the code listings in the chapter are small portions of code rather than full working examples of printing or code that checks values. Testing the examples involves creating elements to be printed and using the code listings with those elements. The final two chapter examples are full examples of printing; those examples include the code that defines the content to be printed as well as performing printing tasks.

To test the example code listings:

1. Create a new Flash document.
2. Select the keyframe on Frame 1 of the Timeline, and open the Actions panel.
3. Copy the code listing into the Script pane.
4. From the main menu, choose Control > Test Movie to create the SWF file and test the example.

# Printing a page

You use an instance of the `PrintJob` class to handle printing. To print a basic page through `Flash Player`, you use these four statements in sequence:

- `new PrintJob()`: Creates a new print job instance of the name you specify.
- `PrintJob.start()`: Initiates the printing process for the operating system, invoking the print dialog box for the user, and populates the read-only properties of the print job.
- `PrintJob.addPage()`: Contains the details about the print job contents, including the `Sprite` object (and any children it contains), the size of the print area, and whether the printer should print the image as a vector or bitmap. You can use successive calls to `addPage()` to print multiple sprites over several pages.
- `PrintJob.send()`: Sends the pages to the operating system's printer.

So, for example, a very simple print job script may look like the following (including package, import and class statements for compiling):

```
package
{
    import flash.printing.PrintJob;
    import flash.display.Sprite;

    public class BasicPrintExample extends Sprite
    {
        var myPrintJob:PrintJob = new PrintJob();
        var mySprite:Sprite = new Sprite();

        public function BasicPrintExample()
        {
            myPrintJob.start();
            myPrintJob.addPage(mySprite);
            myPrintJob.send();
        }
    }
}
```

**NOTE**

This example is intended to show the basic elements of a print job script, and does not contain any error handling. To build a script that responds properly to a user canceling a print job, see [“Working with exceptions and returns” on page 719](#).

If you need to clear a `PrintJob` object's properties for any reason, set the `PrintJob` variable to `null` (as in `myPrintJob = null`).

# Flash Player tasks and system printing

Because Flash Player dispatches pages to the operating system's printing interface, you should understand the scope of the tasks managed by Flash Player, and the tasks managed by an operating system's own printing interface. Flash Player can initiate a print job, read some of a printer's page settings, pass the content for a print job to the operating system, and verify if the user or system has cancelled a print job. Other processes, such as displaying printer specific dialog boxes, cancelling a spooled print job, or reporting on the printer's status, are all handled by the operating system. Flash Player is able to respond if there is a problem initiating or formatting a print job, but can report back only on certain properties or conditions from the operating system's printing interface. As a developer, your code should have the ability to respond to these properties or conditions.

## Working with exceptions and returns

You should check to see if the `PrintJob.start()` method returns `true` before executing `addPage()` and `send()` calls, in case the user has cancelled the print job. A simple way to check whether these methods have been cancelled before continuing is to wrap them in an `if` statement, as follows:

```
if (myPrintJob.start())
{
    // addPage() and send() statements here
}
```

If `PrintJob.start()` is `true`, meaning the user has selected Print (or Flash Player has initiated a Print command), the `addPage()` and `send()` methods can be called.

Also, to help manage the printing process, Flash Player now throws exceptions for the `PrintJob.addPage()` method, so that you can catch errors and provide information and options to the user. If a `PrintJob.addPage()` method fails, you can also call another function or stop the current print job. You catch these exceptions by embedding `addPage()` calls within a `try..catch` statement, as in the following example. In the example, `[params]` is a placeholder for the parameters specifying the actual content you want to print:

```

if (myPrintJob.start())
{
    try
    {
        myPrintJob.addPage([params]);
    }
    catch (error:Error)
    {
        // Handle error,
    }
    myPrintJob.send();
}

```

After the print job starts, you can add the content using `PrintJob.addPage()` and see if that generates an exception (for example, if the user has cancelled the print job). If it does, you can add logic to the `catch` statement to provide the user (or Flash Player) with information and options, or you can stop the current print job. If you add the page successfully, you can proceed to send the pages to the printer using `PrintJob.send()`.

If Flash Player encounters a problem sending the print job to the printer (for example, if the printer is offline), you can catch that exception, too, and provide the user (or Flash Player) with information or more options (such as displaying message text or providing an alert within the Flash animation). For example, you can assign new text to a text field in an `if...else` statement, as the following code shows:

```

if (myPrintJob.start())
{
    try
    {
        myPrintJob.addPage([params]);
    }
    catch (error:Error)
    {
        // Handle error.
    }
    myPrintJob.send();
}
else
{
    myAlert.text = "Print job canceled";
}

```

For a working example, see [“Example: Scaling, cropping, and responding”](#) on page 727.



## Working with page properties

Once the user clicks OK in the Print dialog box and `PrintJob.start()` returns `true`, you can access the properties defined by the printer's settings. These include the paper width, paper height (`pageHeight` and `pageWidth`), and content orientation on the paper. Because these are printer settings, not controlled by Flash Player, you cannot alter these settings; however, you can use them to align the content you send to the printer to match the current settings. For more information, see [“Setting size, scale, and orientation” on page 722](#).

## Setting vector or bitmap rendering

You can manually set the print job to spool each page as vector graphics or a bitmap image. In some cases, vector printing will produce a smaller spool file, and a better image than bitmap printing. However, if your content includes a bitmap image, and you want to preserve any alpha transparency or color effects, you should print the page as a bitmap image. Also, a non-PostScript printer automatically converts any vector graphics to bitmap images. You specify bitmap printing in the third parameter of `PrintJob.addPage()`, by passing a `PrintJobOptions` object with the `printAsBitmap` parameter set to `true`, as follows:

```
var options:PrintJobOptions = new PrintJobOptions();
options.printAsBitmap = true;
myPrintJob.addPage(mySprite, null, options);
```

If you don't specify a value for the third parameter, the print job will use the default, which is vector printing.

NOTE

If you don't want to specify a value for `printArea` (the second parameter) but want to specify a value for bitmap printing, use `null` for `printArea`.

## Timing print job statements

ActionScript 3.0 does not restrict a `PrintJob` object to a single frame (as did previous versions of ActionScript). However, because the operating system displays print status information to the user once the user has clicked the OK button in the Print dialog box, you should call `PrintJob.addPage()` and `PrintJob.send()` as soon as possible to send pages to the spooler. A delay reaching the frame containing the `PrintJob.send()` call will delay the printing process.

In ActionScript 3.0, there is a script time-out limit of 15 seconds. Therefore, the time between each major statement in a print job sequence cannot exceed 15 seconds. In other words, the 15-second script time-out limit applies to the following intervals:

- Between `PrintJob.start()` and the first `PrintJob.addPage()`
- Between `PrintJob.addPage()` and the next `PrintJob.addPage()`
- Between the last `PrintJob.addPage()` and `PrintJob.send()`

If any of these intervals spans more than 15 seconds, the next call to `PrintJob.start()` on the `PrintJob` instance returns `false`, and the next `PrintJob.addPage()` on the `PrintJob` instance causes Flash Player to throw a run-time exception.

## Setting size, scale, and orientation

The section [“Printing a page” on page 718](#) details the steps for a basic print job, where the output directly reflects the printed equivalent of the screen size and position of the specified sprite. However, printers use different resolutions for printing, and can have settings that adversely affect the appearance of the printed sprite.

Flash Player can read an operating system’s printing settings, but note that these properties are read-only: although you can respond to their values, you can’t set them. So, for example, you can find out the printer’s page size setting and adjust your content to fit the size. You can also determine a printer’s margin settings and page orientation. To respond to the printer settings, you may need to specify a print area, adjust for the difference between a screen’s resolution and a printer’s point measurements, or transform your content to meet the size or orientation settings of the user’s printer.

## Using rectangles for the print area

The `PrintJob.addPage()` method allows you to specify the region of a sprite that you want printed. The second parameter, `printArea`, is in the form of a `Rectangle` object. You have three options for providing a value for this parameter:

- Create a `Rectangle` object with specific properties and then use that rectangle in the `addPage()` call, as in the following example:

```
private var rect1:Rectangle = new Rectangle(0, 0, 400, 200);
myPrintJob.addPage(sheet, rect1);
```
- If you haven't already specified a `Rectangle` object, you can do it within the call itself, as in the following example:

```
myPrintJob.addPage(sheet, new Rectangle(0, 0, 100, 100));
```
- If you plan to provide values for the third parameter in the `addPage()` call, but don't want to specify a rectangle, you can use `null` for the second parameter, as in the following:

```
myPrintJob.addPage(sheet, null, options);
```

NOTE

If you plan to specify a rectangle for the printing dimensions, remember to import the `flash.display.Rectangle` class.

## Comparing points and pixels

A rectangle's width and height are pixel values. A printer uses points as print units of measurement. Points are a fixed physical size ( $1/72$  inch), but the size of a pixel on the screen depends on the resolution of the particular screen. The conversion rate between pixels and points depends on the printer settings and whether the sprite is scaled. An unscaled sprite that is 72 pixels wide will print out one inch wide, with one point equal to one pixel, independent of screen resolution.

You can use the following equivalencies to convert inches or centimeters to twips or points (a twip is  $1/20$  of a point):

- 1 point =  $1/72$  inch = 20 twips
- 1 inch = 72 points = 1440 twips
- 1 centimeter = 567 twips

If you omit the `printArea` parameter, or if it is passed incorrectly, the full area of the sprite is printed.

## Scaling

If you want to scale a Sprite object before you print it, set the scale properties (see [“Manipulating size and scaling objects” on page 402](#)) before calling the `PrintJob.addPage()` method, and set them back to their original values after printing. The scale of a Sprite object has no relation to the `printArea` property. In other words, if you specify a print area that is 50 pixels by 50 pixels, 2500 pixels are printed. If you scale the Sprite object, the same 2500 pixels are printed, but the Sprite object is printed at the scaled size.

For an example, see [“Example: Scaling, cropping, and responding” on page 727](#).

## Printing for landscape or portrait orientation

Because Flash Player can detect the settings for orientation, you can build logic into your ActionScript to adjust the content size or rotation in response to the printer settings, as the following example illustrates:

```
if (myPrintJob.orientation == PrintJobOrientation.LANDSCAPE)
{
    mySprite.rotation = 90;
}
```

NOTE

If you plan to read the system setting for content orientation on the paper, remember to import the `PrintJobOrientation` class by using the following:

```
import flash.printing.PrintJobOrientation;
```

The `PrintJobOrientation` class provides constant values that define the content orientation on the page.

## Responding to page height and width

Using a strategy that is similar to handling printer orientation settings, you can read the page height and width settings and respond to them by embedding some logic into an `if` statement. The following code shows an example:

```
if (mySprite.height > myPrintJob.pageHeight)
{
    mySprite.scaleY = .75;
}
```

In addition, a page’s margin settings can be determined by comparing the page and paper dimensions, as the following example illustrates:

```
margin_height = (myPrintJob.paperHeight - myPrintJob.pageHeight) / 2;
margin_width = (myPrintJob.paperWidth - myPrintJob.pageWidth) / 2;
```

# Example: Multiple-page printing

When printing more than one page of content, you can associate each page of content with a different sprite (in this case, `sheet1` and `sheet2`), and then use `PrintJob.addPage()` for each sprite. The following code illustrates this technique:

```
package
{
    import flash.display.MovieClip;
    import flash.printing.PrintJob;
    import flash.printing.PrintJobOrientation;
    import flash.display.Stage;
    import flash.display.Sprite;
    import flash.text.TextField;
    import flash.geom.Rectangle;

    public class PrintMultiplePages extends MovieClip
    {
        private var sheet1:Sprite;
        private var sheet2:Sprite;

        public function PrintMultiplePages():void
        {
            init();
            printPages();
        }

        private function init():void
        {
            sheet1 = new Sprite();
            createSheet(sheet1, "Once upon a time...", {x:10, y:50, width:80,
height:130});
            sheet2 = new Sprite();
            createSheet(sheet2, "There was a great story to tell, and it ended
quickly.\n\nThe end.", null);
        }

        private function createSheet(sheet:Sprite, str:String,
imgValue:Object):void
        {
            sheet.graphics.beginFill(0xEEEEEE);
            sheet.graphics.lineStyle(1, 0x000000);
            sheet.graphics.drawRect(0, 0, 100, 200);
            sheet.graphics.endFill();
        }
    }
}
```

```

var txt:TextField = new TextField();
txt.height = 200;
txt.width = 100;
txt.wordWrap = true;
txt.text = str;

if (imgValue != null)
{
    var img:Sprite = new Sprite();
    img.graphics.beginFill(0xFFFFFFFF);
    img.graphics.drawRect(imgValue.x, imgValue.y, imgValue.width,
imgValue.height);
    img.graphics.endFill();
    sheet.addChild(img);
}
sheet.addChild(txt);
}

private function printPages():void
{
    var pj:PrintJob = new PrintJob();
    var pagesToPrint:uint = 0;
    if (pj.start())
    {
        if (pj.orientation == PrintJobOrientation.LANDSCAPE)
        {
            throw new Error("Page is not set to an orientation of
portrait.");
        }

        sheet1.height = pj.pageHeight;
        sheet1.width = pj.pageWidth;
        sheet2.height = pj.pageHeight;
        sheet2.width = pj.pageWidth;

        try
        {
            pj.addPage(sheet1);
            pagesToPrint++;
        }
        catch (error:Error)
        {
            // Respond to error.
        }
    }
}

```

```

        try
        {
            pj.addPage(sheet2);
            pagesToPrint++;
        }
        catch (error:Error)
        {
            // Respond to error.
        }

        if (pagesToPrint > 0)
        {
            pj.send();
        }
    }
}
}
}

```

## Example: Scaling, cropping, and responding

In some cases, you may want adjust the size (or other properties) of a display object when printing it to accommodate differences between the way it appears on screen and the way it appears printed on paper. When you adjust the properties of a display object before printing (for example, by using the `scaleX` and `scaleY` properties), be aware that if the object scales larger than the defined rectangle for the print area, the object will be cropped. You will also probably want to reset the properties after the pages have been printed.

The following code scales the dimensions of the `txt` display object (but not the green box background), and the text field ends up being cropped by the dimensions of the specified rectangle. After printing, the text field is returned to its original size for display on screen. If the user cancels the print job from the operating system's Print dialog box, the content in the Flash Player changes to alert the user that the job has been canceled.

```

package
{
    import flash.printing.PrintJob;
    import flash.display.Sprite;
    import flash.text.TextField;
    import flash.display.Stage;
    import flash.geom.Rectangle;

    public class PrintScaleExample extends Sprite
    {
        private var bg:Sprite;
    }
}

```

```

private var txt:TextField;

public function PrintScaleExample():void
{
    init();
    draw();
    printPage();
}

private function printPage():void
{
    var pj:PrintJob = new PrintJob();
    txt.scaleX = 3;
    txt.scaleY = 2;
    if (pj.start())
    {
        trace(">> pj.orientation: " + pj.orientation);
        trace(">> pj.pageWidth: " + pj.pageWidth);
        trace(">> pj.pageHeight: " + pj.pageHeight);
        trace(">> pj.paperWidth: " + pj.paperWidth);
        trace(">> pj.paperHeight: " + pj.paperHeight);

        try
        {
            pj.addPage(this, new Rectangle(0, 0, 100, 100));
        }
        catch (error:Error)
        {
            // Do nothing.
        }
        pj.send();
    }
    else
    {
        txt.text = "Print job canceled";
    }
    // Reset the txt scale properties.
    txt.scaleX = 1;
    txt.scaleY = 1;
}

private function init():void
{
    bg = new Sprite();
    bg.graphics.beginFill(0x00FF00);
    bg.graphics.drawRect(0, 0, 100, 200);
    bg.graphics.endFill();

    txt = new TextField();
    txt.border = true;
}

```



```
        txt.text = "Hello World";
    }

    private function draw():void
    {
        addChild(bg);
        addChild(txt);
        txt.x = 50;
        txt.y = 50;
    }
}
```



The ActionScript 3.0 external API enables straightforward communication between ActionScript and the container application within which Adobe Flash Player 9 is running. There are several situations in which you may want to use the external API—for example, when you create interaction between a SWF document and JavaScript in an HTML page, or when you build a desktop application that uses Flash Player to display a SWF file.

This chapter describes how to use the external API to interact with a container application, how to pass data between ActionScript and JavaScript in an HTML page, and how to establish communication and exchange data between ActionScript and a desktop application.

NOTE

This chapter only covers communication between ActionScript in a SWF and the container application that includes a reference to the Flash Player instance in which the SWF is loaded. Any other use of Flash Player within an application is outside the scope of this documentation. Flash Player is designed to be used as a browser plug-in or as a projector (standalone application). Other usage scenarios may have limited support.

## Contents

Basics of using the external API .....	732
External API requirements and advantages .....	735
Using the ExternalInterface class .....	736
Example: Using the external API with a web page container .....	742
Example: Using the external API with an ActiveX container .....	749

# Basics of using the external API

## Introduction to using the external API

Although in some cases a SWF file can run on its own (for example, if you create a SWF projector), in the majority of cases a SWF application runs as an element inside of another application. Commonly, the container that includes the SWF is an HTML file; somewhat less frequently, a SWF file is used for all or part of the user interface of a desktop application.

As you work on more advanced applications, you may find a need to set up communication between the SWF file and the container application. For instance, it's common for a web page to display text or other information in HTML, and include a SWF file to display dynamic visual content such as a chart or video. In such a case, you might want to make it so that when users click a button on the web page, it changes something in the SWF file. ActionScript contains a mechanism, known as the external API, that facilitates this type of communication between ActionScript in a SWF file and other code in the container application.

## Common external API tasks

The following common external API tasks are explained in this chapter:

- Getting information about the container application
- Using ActionScript to call code in a container application, including a web page or desktop application
- Calling ActionScript code from code in a container application
- Creating a proxy to simplify calling ActionScript code from a container application

## Important concepts and terms

The following reference list contains important terms used in this chapter:

- **ActiveX container:** A container application (not a web browser) that includes an instance of the Flash Player ActiveX control to display SWF content within the application.
- **Container application:** The application within which Flash Player is running a SWF file, such as a web browser and HTML page that includes Flash Player content.

- **Projector:** A SWF file that has been converted into a standalone executable file including Flash Player as well as the SWF file's content. A projector can be created in Adobe Flash CS3 Professional or using the standalone Flash Player. Projectors are commonly used to distribute SWF files by CD-ROM or in similar situations where download size is not an issue and the SWF author wants to be certain the user will be able to run the SWF file, regardless of whether Flash Player is installed on the user's computer.
- **Proxy:** A go-between application or code that calls code in one application (the "external application") on behalf of another application (the "calling application"), and returns values to the calling application. A proxy can be used for various reasons, including:
  - To simplify the process of making external function calls by converting native function calls in the calling application into the format understood by the external application
  - To work around security or other restrictions that prevent the caller from communicating directly with the external application
- **Serialize:** To convert objects or data values into a format that can be used to pass the values in messages between two programming systems, such as over the Internet or between two different applications running on a single computer.

## Working through in-chapter examples

While you're working through this chapter, you might want to test the example code listings. Many of the code listings in the chapter are small listings of code for demonstration purposes rather than full working examples or code that checks values. Because using the external API requires (by definition) writing ActionScript code as well as code in a container application, testing the examples involves creating a container (for example, a web page containing the SWF) and using the code listings to interact with the container.

### **To test an example of ActionScript-to-JavaScript communication:**

1. Create a new Flash document and save it to your computer.
2. From the main menu, choose File > Publish Settings.
3. In the Publish Settings dialog box, on the Formats tab, confirm that the Flash and HTML check boxes are selected.
4. Click the Publish button. This generates a SWF file and HTML file in the same folder and with the same name that you used to save the Flash document. Click OK to close the Publish Settings dialog box.

5. Deselect the HTML check box. Now that the HTML page is generated, you are going to modify it to add the appropriate JavaScript code. Deselecting the HTML check box ensures that after you modify the HTML page, Flash will not overwrite your changes with a new HTML page when it's publishing the SWF file.
6. Click OK to close the Publish Settings dialog box.
7. With an HTML or text editor application, open the HTML file that was created by Flash when you published the SWF. In the HTML source code, add a script element and copy into it the JavaScript code from the example code listing.
8. Save the HTML file and return to Flash.
9. Select the keyframe on Frame 1 of the Timeline, and open the Actions panel.
10. Copy the ActionScript code listing into the Script pane.
11. From the main menu, choose File > Publish to update the SWF file with the changes that you've made.
12. Using a web browser, open the HTML page you edited to view the page and test communication between ActionScript and the HTML page.

**To test an example of ActionScript-to-ActiveX container communication:**

1. Create a new Flash document and save it to your computer. You may want to save it in the folder where your container application will expect to find the SWF file.
2. From the main menu, choose File > Publish Settings.
3. In the Publish Settings dialog box, on the Formats tab, confirm that only the Flash check box is selected.
4. In the File field next to the Flash check box, click the folder icon to select the folder into which your SWF file will be published. By setting the location for your SWF file, you can (for example) keep the Flash document in one folder, but put the published SWF file in another folder such as the folder containing the source code for the container application.
5. Select the keyframe on Frame 1 of the Timeline, and open the Actions panel.
6. Copy the ActionScript code for the example into the Script pane.
7. From the main menu, choose File > Publish to re-publish the SWF file.
8. Create and run your container application to test communication between ActionScript and the container application.

The two examples at the end of this chapter are full examples of using the external API to communicate with an HTML page and a C# desktop application, respectively. Those examples include the full code, including ActionScript and container error-checking code, which you should use when writing code using the external API. For another full example using the external API, see the class example for the ExternalInterface class in the *ActionScript 3.0 Language and Components Reference*.

## External API requirements and advantages

The external API is the portion of ActionScript that provides a mechanism for communication between ActionScript and code running in an “external application” that is acting as a container for Flash Player (commonly a web browser or stand-alone projector application). In ActionScript 3.0, the functionality of the external API is provided by the ExternalInterface class. In Flash Player versions prior to Flash Player 8, the `fscommand()` action was used to carry out communication with the container application. The ExternalInterface class is a replacement for `fscommand()`, and its use is recommended for all communication between JavaScript and ActionScript.

**NOTE**

If you need to use the old `fscommand()` function—for example, to maintain compatibility with older applications or to interact with a third-party SWF container application or the stand-alone Flash Player—it is still available as a package-level function in the `flash.system` package.

The ExternalInterface class is a subsystem that lets you easily communicate from ActionScript and Flash Player to JavaScript in an HTML page, or to any desktop application that includes an instance of Flash Player.

The ExternalInterface class is available only under the following conditions:

- In all supported versions of Internet Explorer for Windows (5.0 and later)
- In a container application such as a desktop application using an instance of the Flash Player ActiveX control
- In any browser that supports the NPRuntime interface, which currently includes the following browsers:
  - Firefox 1.0 and later
  - Mozilla 1.7.5 and later
  - Netscape 8.0 and later
  - Safari 1.3 and later

In all other situations (such as running in a stand-alone player), the `ExternalInterface.available` property returns `false`.

From ActionScript, you can call a JavaScript function on the HTML page. The external API offers the following improved functionality compared with `fscommand()`:

- You can use any JavaScript function, not only the functions that you can use with the `fscommand()` function.
- You can pass any number of arguments, with any names; you aren't limited to passing a command and a single string argument. This gives the external API much more flexibility than `fscommand()`.
- You can pass various data types (such as Boolean, Number, and String); you are no longer limited to String parameters.
- You can receive the value of a call, and that value returns immediately to ActionScript (as the return value of the call you make).

**WARNING**

If the name given to the Flash Player instance in an HTML page (the `object` tag's `id` attribute) includes a hyphen (-) or other characters that are defined as operators in JavaScript (such as +, \*, /, \, ., and so on), `ExternalInterface` calls from ActionScript will not work when the container web page is viewed in Internet Explorer. In addition, if the HTML tags that define the Flash Player instance (the `object` and `embed` tags) are nested in an HTML `form` tag, `ExternalInterface` calls from ActionScript will not work.

## Using the `ExternalInterface` class

Communication between ActionScript and the container application can take one of two forms: either ActionScript can call code (such as a JavaScript function) defined in the container, or code in the container can call an ActionScript function that has been designated as being callable. In either case, information can be sent to the code being called, and results can be returned to the code making the call.

To facilitate this communication, the `ExternalInterface` class includes two static properties and two static methods. These properties and methods are used to obtain information about the external interface connection, to execute code in the container from ActionScript, and to make ActionScript functions available to be called by the container.



## Getting information about the external container

The `ExternalInterface.available` property indicates whether the current Flash Player is in a container that offers an external interface. If the external interface is available, this property is `true`; otherwise, it is `false`. Before using any of the other functionality in the `ExternalInterface` class, you should always check to make sure that the current container supports external interface communication, as follows:

```
if (ExternalInterface.available)
{
    // Perform ExternalInterface method calls here.
}
```

**NOTE**

The `ExternalInterface.available` property reports whether the current container is a type that supports `ExternalInterface` connectivity. It will not tell you if JavaScript is enabled in the current browser.

The `ExternalInterface.objectID` property allows you to determine the unique identifier of the Flash Player instance (specifically, the `id` attribute of the `object` tag in Internet Explorer or the `name` attribute of the `embed` tag in browsers using the `NPRuntime` interface). This unique ID represents the current SWF document in the browser, and can be used to make reference to the SWF document—for example, when calling a JavaScript function in a container HTML page. When the Flash Player container is not a web browser, this property is `null`.

## Calling external code from ActionScript

The `ExternalInterface.call()` method executes code in the container application. It requires at least one parameter, a string containing the name of the function to be called in the container application. Any additional parameters passed to the `ExternalInterface.call()` method are passed along to the container as parameters of the function call.

```
// calls the external function "addNumbers"
// passing two parameters, and assigning that function's result
// to the variable "result"
var param1:uint = 3;
var param2:uint = 7;
var result:uint = ExternalInterface.call("addNumbers", param1, param2);
```

If the container is an HTML page, this method invokes the JavaScript function with the specified name, which must be defined in a `script` element in the containing HTML page. The return value of the JavaScript function is passed back to ActionScript.

```
<script language="JavaScript">
  // adds two numbers, and sends the result back to ActionScript
  function addNumbers(num1, num2)
  {
    return (num1 + num2);
  }
</script>
```

If the container is some other ActiveX container, this method causes the Flash Player ActiveX control to dispatch its `FlashCall` event. The specified function name and any parameters are serialized into an XML string by Flash Player. The container can access that information in the `request` property of the event object and use it to determine how to execute its own code. To return a value to ActionScript, the container code calls the ActiveX object's `SetReturnValue()` method, passing the result (serialized into an XML string) as a parameter of that method. For more information about the XML format used for this communication, see [“The external API’s XML format” on page 740](#).

Whether the container is a web browser or another ActiveX container, if the call fails or the container method does not specify a return value, `null` is returned. The `ExternalInterface.call()` method throws a `SecurityError` exception if the containing environment belongs to a security sandbox to which the calling code does not have access. You can work around this by setting an appropriate value for `allowScriptAccess` in the containing environment. For example, to change the value of `allowScriptAccess` in an HTML page, you would edit the appropriate attribute in the `object` and `embed` tags.

## Calling ActionScript code from the container

A container can only call ActionScript code that's in a function—no other ActionScript code can be called by a container. To call an ActionScript function from the container application, you must do two things: register the function with the `ExternalInterface` class, and then call it from the container's code.

First, you must register your ActionScript function to indicate that it should be made available to the container. Use the `ExternalInterface.addCallback()` method, as follows:

```
function callMe(name:String):String
{
    return "busy signal";
}
ExternalInterface.addCallback("myFunction", callMe);
```

The `addCallback()` method takes two parameters. The first, a function name as a `String`, is the name by which the function will be known to the container. The second parameter is the actual ActionScript function that will be executed when the container calls the defined function name. Because these names are distinct, you can specify a function name that will be used by the container, even if the actual ActionScript function has a different name. This is especially useful if the function name is not known—for example, if an anonymous function is specified, or if the function to be called is determined at run time.

Once an ActionScript function has been registered with the `ExternalInterface` class, the container can actually call the function. How this is done varies according to the type of container. For example, in JavaScript code in a web browser, the ActionScript function is called using the registered function name as though it's a method of the Flash Player browser object (that is, a method of the JavaScript object representing the `object` or `embed` tag). In other words, parameters are passed and a result is returned as though a local function is being called.

```
<script language="JavaScript">
    // callResult gets the value "busy signal"
    var callResult = flashObject.myFunction("my name");
</script>
...
<object id="flashObject"...>
    ...
    <embed name="flashObject".../>
</object>
```

Alternatively, when calling an ActionScript function in a SWF file running in a desktop application, the registered function name and any parameters must be serialized into an XML-formatted string. Then the call is actually performed by calling the `CallFunction()` method of the ActiveX control with the XML string as a parameter. For more information about the XML format used for this communication, see [“The external API’s XML format” on page 740](#).

In either case, the return value of the ActionScript function is passed back to the container code, either directly as a value when the caller is JavaScript code in a browser, or serialized as an XML-formatted string when the caller is an ActiveX container.

## The external API’s XML format

Communication between ActionScript and an application hosting the Shockwave Flash ActiveX control uses a specific XML format to encode function calls and values. There are two parts to the XML format used by the external API. One format is used to represent function calls. Another format is used to represent individual values; this format is used for parameters in functions as well as function return values. The XML format for function calls is used for calls to and from ActionScript. For a function call from ActionScript, Flash Player passes the XML to the container; for a call from the container, Flash Player expects the container application to pass it an XML string in this format. The following XML fragment shows an example XML-formatted function call:

```
<invoke name="functionName" returntype="xml">
  <arguments>
    ... (individual argument values)
  </arguments>
</invoke>
```

The root node is the `invoke` node. It has two attributes: `name` indicates the name of the function to call, and `returntype` is always `xml`. If the function call includes parameters, the `invoke` node has a child `arguments` node, whose child nodes will be the parameter values formatted using the individual value format explained next.

Individual values, including function parameters and function return values, use a formatting scheme that includes data type information in addition to the actual values. The following table lists ActionScript classes and the XML format used to encode values of that data type:

ActionScript class/value	C# class/value	Format	Comments
null	null	<null/>	
Boolean true	bool true	<true/>	
Boolean false	bool false	<false/>	
String	string	<string>string value</string>	
Number, int, uint	single, double, int, uint	<number>27.5</number> <number>-12</number>	
Array (elements can be mixed types)	A collection that allows mixed-type elements, such as ArrayList or object[]	<array> <property id="0"> <number>27.5</number> </property> <property id="1"> <string>Hello there!</string> </property> ... </array>	The property node defines individual elements, and the id attribute is the numeric, zero-based index.
Object	A dictionary with string keys and object values, such as a Hashtable with string keys	<object> <property id="name"> <string>John Doe</string> </property> <property id="age"> <string>33</string> </property> ... </object>	The property node defines individual properties, and the id attribute is the property name (a string).
Other built-in or custom classes		<null/> or <object></object>	ActionScript encodes other objects as null or as an empty object. In either case any property values are lost.

**NOTE**

By way of example, this table shows equivalent C# classes in addition to ActionScript classes; however, the external API can be used to communicate with any programming language or run time that supports ActiveX controls, and is not limited to C# applications.

When you are building your own applications using the external API with an ActiveX container application, you'll probably find it convenient to write a proxy that will perform the task of converting native function calls to the serialized XML format. For an example of a proxy class written in C#, see [“Inside the ExternalInterfaceProxy class” on page 754](#).

## Example: Using the external API with a web page container

This sample application demonstrates appropriate techniques for communicating between ActionScript and JavaScript in a web browser, in the context of an Instant Messaging application that allows a person to chat with him or herself (hence the name of the application: Introvert IM). Messages are sent between an HTML form in the web page and a SWF interface using the external API. The techniques demonstrated by this example include the following:

- Properly initiating communication by verifying that the browser is ready to communicate before setting up communication
- Checking whether the container supports the external API
- Calling JavaScript functions from ActionScript, passing parameters, and receiving values in response
- Making ActionScript methods available to be called by JavaScript, and performing those calls

To get the application files for this sample, see [www.adobe.com/go/learn\\_programmingAS3samples\\_flash](http://www.adobe.com/go/learn_programmingAS3samples_flash). The Introvert IM application files can be found in the Samples/IntrovertIM\_HTML folder. The application consists of the following files:

File	Description
IntrovertIMApp fla or IntrovertIMApp.mxml	The main application file for Flash (FLA) or Flex (MXML).
com/example/programmingas3/ introvertIM/IMManager.as	The class that establishes and manages communication between ActionScript and the container.
com/example/programmingas3/ introvertIM/IMMessageEvent.as	Custom event type, dispatched by the IMManager class when a message is received from the container.

File	Description
com/example/programmingas3/introvertIM/IMStatus.as	Enumeration whose values represent the different “availability” status values that can be selected in the application.
html-flash/IntrovertIMApp.html or html-template/index.template.html	The HTML page for the application for Flash (html-flash/IntrovertIMApp.html) or the template that is used to create the container HTML page for the application for Adobe Flex (html-template/index.template.html). This file contains all the JavaScript functions that make up the container part of the application.

## Preparing for ActionScript-browser communication

One of the most common uses for the external API is to allow ActionScript applications to communicate with a web browser. Using the external API, ActionScript methods can call code written in JavaScript and vice versa. Because of the complexity of browsers and how they render pages internally, there is no way to guarantee that a SWF document will register its callbacks before the first JavaScript on the HTML page runs. For that reason, before calling functions in the SWF document from JavaScript, your SWF document should always call the HTML page to notify it that the SWF document is ready to accept connections.

For example, through a series of steps performed by the IMManager class, the Introvert IM determines whether the browser is ready for communication and prepares the SWF file for communication. The first step, determining when the browser is ready for communication, happens in the IMManager constructor, as follows:

```
public function IMManager(initialStatus:IMStatus)
{
    _status = initialStatus;

    // Check if the container is able to use the external API.
    if (ExternalInterface.available)
    {
        try
        {
            // This calls the isContainerReady() method, which in turn calls
            // the container to see if Flash Player has loaded and the container
            // is ready to receive calls from the SWF.
            var containerReady:Boolean = isContainerReady();
            if (containerReady)
            {
                // If the container is ready, register the SWF's functions.
            }
        }
    }
}
```

```

        setupCallbacks();
    }
    else
    {
        // If the container is not ready, set up a Timer to call the
        // container at 100ms intervals. Once the container responds that
        // it's ready, the timer will be stopped.
        var readyTimer:Timer = new Timer(100);
        readyTimer.addEventListener(TimerEvent.TIMER, timerHandler);
        readyTimer.start();
    }
}
...
}
else
{
    trace("External interface is not available for this container.");
}
}

```

First of all, the code checks whether the external API is even available in the current container using the `ExternalInterface.available` property. If so, it begins the process of setting up communication. Because security exceptions and other errors can occur when you attempt communication with an external application, the code is wrapped in a `try` block (the corresponding `catch` blocks were omitted from the listing for brevity).

The code next calls the `isContainerReady()` method, listed here:

```

private function isContainerReady():Boolean
{
    var result:Boolean = ExternalInterface.call("isReady");
    return result;
}

```

The `isContainerReady()` method in turn uses `ExternalInterface.call()` method to call the JavaScript function `isReady()`, as follows:

```

<script language="JavaScript">
<!--
// ----- Private vars -----
var jsReady = false;
...
// ----- functions called by ActionScript -----
// called to check if the page has initialized and JavaScript is available
function isReady()
{
    return jsReady;
}
...
// called by the onload event of the <body> tag
function pageInit()

```



```

{
    // Record that JavaScript is ready to go.
    jsReady = true;
}
...
//-->
</script>

```

The `isReady()` function simply returns the value of the `jsReady` variable. That variable is initially `false`; once the `onload` event of the web page has been triggered, the variable's value is changed to `true`. In other words, if `ActionScript` calls the `isReady()` function before the page is loaded, JavaScript returns `false` to `ExternalInterface.call("isReady")`, and consequently the `ActionScript isContainerReady()` method returns `false`. Once the page has loaded, the JavaScript `isReady()` function returns `true`, so the `ActionScript isContainerReady()` method also returns `true`.

Back in the `IMManager` constructor, one of two things happens depending on the readiness of the container. If `isContainerReady()` returns `true`, the code simply calls the `setupCallbacks()` method, which completes the process of setting up communication with JavaScript. On the other hand, if `isContainerReady()` returns `false`, the process is essentially put on hold. A `Timer` object is created and is told to call the `timerHandler()` method every 100 milliseconds, as follows:

```

private function timerHandler(event:TimerEvent):void
{
    // Check if the container is now ready.
    var isReady:Boolean = isContainerReady();
    if (isReady)
    {
        // If the container has become ready, we don't need to check anymore,
        // so stop the timer.
        Timer(event.target).stop();
        // Set up the ActionScript methods that will be available to be
        // called by the container.
        setupCallbacks();
    }
}

```

Each time the `timerHandler()` method gets called, it once again checks the result of the `isContainerReady()` method. Once the container is initialized, that method returns `true`. The code then stops the `Timer` and calls the `setupCallbacks()` method to finish the process of setting up communication with the browser.

## Exposing ActionScript methods to JavaScript

As the previous example showed, once the code determines that the browser is ready, the `setupCallbacks()` method is called. This method prepares ActionScript to receive calls from JavaScript, as shown here:

```
private function setupCallbacks():void
{
    // Register the SWF client functions with the container
    ExternalInterface.addCallback("newMessage", newMessage);
    ExternalInterface.addCallback("getStatus", getStatus);
    // Notify the container that the SWF is ready to be called.
    ExternalInterface.call("setSWFIsReady");
}
```

The `setCallbacks()` method finishes the task of preparing for communication with the container by calling `ExternalInterface.addCallback()` to register the two methods that will be available to be called from JavaScript. In this code, the first parameter—the name by which the method is known to JavaScript ("newMessage" and "getStatus")—is the same as the method's name in ActionScript. (In this case, there was no benefit to using different names, so the same name was reused for simplicity.) Finally, the `ExternalInterface.call()` method is used to call the JavaScript function `setSWFIsReady()`, which notifies the container that the ActionScript functions have been registered.

## Communication from ActionScript to the browser

The Introvert IM application demonstrates a range of examples of calling JavaScript functions in the container page. In the simplest case (an example from the `setupCallbacks()` method), the JavaScript function `setSWFIsReady()` is called without passing any parameters or receiving a value in return:

```
ExternalInterface.call("setSWFIsReady");
```

In another example from the `isContainerReady()` method, ActionScript calls the `isReady()` function and receives a Boolean value in response:

```
var result:Boolean = ExternalInterface.call("isReady");
```

You can also pass parameters to JavaScript functions using the external API. For instance, consider the `IMManager` class's `sendMessage()` method, which is called when the user is sending a new message to his or her “conversation partner”:

```
public function sendMessage(message:String):void
{
    ExternalInterface.call("newMessage", message);
}
```

Once again, `ExternalInterface.call()` is used to call the designated JavaScript function, notifying the browser of the new message. In addition, the message itself is passed as an additional parameter to `ExternalInterface.call()`, and consequently it is passed as a parameter to the JavaScript function `newMessage()`.

## Calling ActionScript code from JavaScript

Communication is supposed to be a two-way street, and the Introvert IM application is no exception. Not only does the Flash Player IM client call JavaScript to send messages, but the HTML form calls JavaScript code to send messages to and ask for information from the SWF file as well. For example, when the SWF file notifies the container that it has finished establishing contact and it's ready to communicate, the first thing the browser does is call the `IMManager` class's `getStatus()` method to retrieve the initial user availability status from the SWF IM client. This is done in the web page, in the `updateStatus()` function, as follows:

```
<script language="JavaScript">
...
function updateStatus()
{
    if (swfReady)
    {
        var currentStatus = getSWF("IntrovertIMApp").getStatus();
        document.forms["imForm"].status.value = currentStatus;
    }
}
...
</script>
```

The code checks the value of the `swfReady` variable, which tracks whether the SWF file has notified the browser that it has registered its methods with the `ExternalInterface` class. If the SWF file is ready to receive communication, the next line (`var currentStatus = ...`) actually calls the `getStatus()` method in the `IMManager` class. Three things happen in this line of code:

- The `getSWF()` JavaScript function is called, returning a reference to the JavaScript object representing the SWF file. The parameter passed to `getSWF()` determines which browser object is returned in case there is more than one SWF file in an HTML page. The value passed to that parameter must match the `id` attribute of the `object` tag and `name` attribute of the `embed` tag used to include the SWF file.
- Using the reference to the SWF file, the `getStatus()` method is called as though it's a method of the SWF object. In this case the function name "getStatus" is used because that's the name under which the ActionScript function is registered using `ExternalInterface.addCallback()`.

- The `getStatus()` ActionScript method returns a value, and that value is assigned to the `currentStatus` variable, which is then assigned as the content (the `value` property) of the `status` text field.

The `sendMessage()` JavaScript function demonstrates passing a parameter to an ActionScript function. (`sendMessage()` is the function that is called when the user presses the Send button on the HTML page.)

```
<script language="JavaScript">
...
function sendMessage(message)
{
    if (swfReady)
    {
        ...
        getSWF("IntrovertIMApp").newMessage(message);
    }
}
...
</script>
```

The `newMessage()` ActionScript method expects one parameter, so the JavaScript `message` variable gets passed to ActionScript by using it as a parameter in the `newMessage()` method call in the JavaScript code.

## Detecting the browser type

Because of differences in how browsers access content, it's important to always use JavaScript to detect which browser the user is running and to access the movie according to the browser-specific syntax, using the `window` or `document` object, as shown in the `getSWF()` JavaScript function in this example:

```
<script language="JavaScript">
...
function getSWF(movieName)
{
    if (navigator.appName.indexOf("Microsoft") != -1)
    {
        return window[movieName];
    }
    else
    {
        return document[movieName];
    }
}
...
</script>
```

If your script does not detect the user's browser type, the user might see unexpected behavior when playing SWF files in an HTML container.

## Example: Using the external API with an ActiveX container

This example demonstrates using the external API to communicate between ActionScript and a desktop application that uses the ActiveX control. The example reuses the Introvert IM application, including the ActionScript code and even the same SWF file, and therefore does not describe the use of the external API in ActionScript. Familiarity with the preceding example will be helpful in understanding this one.

The desktop application in this example is written in C# using Microsoft Visual Studio .NET. The focus of the discussion is the specific techniques for working with the external API using the ActiveX control. This example demonstrates the following:

- Calling ActionScript functions from a desktop application hosting the Flash Player ActiveX control
- Receiving function calls from ActionScript and processing them in an ActiveX container
- Using a proxy class to hide the details of the serialized XML format that Flash Player uses for messages sent to an ActiveX container

To get the application files for this sample, see [www.adobe.com/go/learn\\_programmingAS3samples\\_flash](http://www.adobe.com/go/learn_programmingAS3samples_flash). The Introvert IM C# files can be found in the Samples/IntrovertIM\_CSharp folder. The application consists of the following files:

File	Description
AppForm.cs	The main application file with the C# Windows Forms interface.
bin/Debug/IntrovertIMApp.swf	The SWF file loaded by the application.
ExternalInterfaceProxy/ ExternalInterfaceProxy.cs	The class that serves as a wrapper around the ActiveX control for External Interface communication. It provides mechanisms for calling and receiving calls from ActionScript.
ExternalInterfaceProxy/ ExternalInterfaceSerializer.cs	The class that performs the task of converting Flash Player's XML format messages to .NET objects.

File	Description
ExternalInterfaceProxy/ ExternalInterfaceEventArgs.cs	This file defines two C# types (classes): a custom delegate, and an event arguments class, which are used by the ExternalInterfaceProxy class to notify a listener of a function call from ActionScript.
ExternalInterfaceProxy/ ExternalInterfaceCall.cs	This class is a value object representing a function call from ActionScript to the ActiveX container, with properties for the function name and parameters.
bin/Debug/IntrovertIMApp.swf	The SWF file loaded by the application.
obj/AxInterop.ShockwaveFlashObjects.dll, obj/Interop.ShockwaveFlashObjects.dll	Wrapper assemblies created by Visual Studio .NET that are required to access the Flash Player (Adobe Shockwave® Flash) ActiveX control from managed code.

## Overview of the Introvert IM C# Application

This sample application represents two instant-messaging client programs (one within a SWF file and another built with Windows Forms) that communicate with each other. The user interface includes an instance of the Shockwave Flash ActiveX control, within which the SWF file containing the ActionScript IM client is loaded. The interface also includes several text fields that make up the Windows Forms IM client: a field for entering messages (`MessageText`), another that displays the transcript of the messages sent between the clients (`Transcript`), and a third (`Status`) that displays the availability status as set in the SWF IM client.

## Including the Shockwave Flash ActiveX control

To include the Shockwave Flash ActiveX control in your own Windows Forms application, you must first add it to the Microsoft Visual Studio Toolbox.

### To add the control to the toolbox:

1. Open the Visual Studio Toolbox.
2. Right-click the Windows Forms section in Visual Studio 2003 or any section in Visual Studio 2005. From the context menu select Add/Remove Items in Visual Studio 2003 (Choose Items... in Visual Studio 2005).

This opens the Customize Toolbox (2003)/Choose Toolbox Items (2005) dialog box.

3. Select the COM Components tab, which lists all of the available COM components on your computer, including the Flash Player ActiveX control.
4. Scroll to Shockwave Flash Object and select it.  
If this item is not listed, make sure that the Flash Player ActiveX control is installed on your system.

## Understanding ActionScript to ActiveX container communication

Communication using the external API with an ActiveX container application works like communication with a web browser, with one important difference. As described earlier, when ActionScript communicates with a web browser, as far as the developer is concerned, the functions are called directly; the details of how the function calls and responses are formatted to pass them between the player and browser are hidden. However, when the external API is used to communicate with an ActiveX container application, Flash Player sends messages (function calls and return values) to the application in a specific XML format, and it expects function calls and return values from the container application to use the same XML format. The developer of the ActiveX container application must write code that understands and can create function calls and responses in the appropriate format.

The Introvert IM C# example includes a set of classes that allow you to avoid formatting messages; instead, you can work with standard data types when calling ActionScript functions and receiving function calls from ActionScript. The `ExternalInterfaceProxy` class, together with other helper classes, provides this functionality, and can be reused in any .NET project to facilitate external API communication.

The following sections of code, excerpted from the main application form (`AppForm.cs`), demonstrate the simplified interaction that is achieved by using the `ExternalInterfaceProxy` class:

```
public class AppForm : System.Windows.Forms.Form
{
    ...
    private ExternalInterfaceProxy proxy;
    ...
    public AppForm()
    {
        ...
        // Register this app to receive notification when the proxy receives
        // a call from ActionScript.
        proxy = new ExternalInterfaceProxy(IntrovertIMApp);
        proxy.ExternalInterfaceCall += new
        ExternalInterfaceCallEventHandler(proxy_ExternalInterfaceCall);
    }
}
```

```
    ...
}
...

```

The application declares and creates an `ExternalInterfaceProxy` instance named `proxy`, passing in a reference to the Shockwave Flash ActiveX control that is in the user interface (`IntrovertIMApp`). Next, the code registers the `proxy_ExternalInterfaceCall()` method to receive the proxy's `ExternalInterfaceCall` event. This event is dispatched by the `ExternalInterfaceProxy` class when a function call comes from Flash Player. Subscribing to this event is the way the C# code receives and responds to function calls from ActionScript.

When a function call comes from ActionScript, the `ExternalInterfaceProxy` instance (`proxy`) receives the call, converts it from XML format, and notifies the objects that are listeners for the proxy's `ExternalInterfaceCall` event. In the case of the `AppForm` class, the `proxy_ExternalInterfaceCall()` method handles that event, as follows:

```
/// <summary>
/// Called by the proxy when an ActionScript ExternalInterface call
/// is made by the SWF
/// </summary>
private object proxy_ExternalInterfaceCall(object sender,
ExternalInterfaceCallEventArgs e)
{
    switch (e.FunctionCall.FunctionName)
    {
        case "isReady":
            return isReady();
        case "setSWFIsReady":
            setSWFIsReady();
            return null;
        case "newMessage":
            newMessage((string)e.FunctionCall.Arguments[0]);
            return null;
        case "statusChange":
            statusChange();
            return null;
        default:
            return null;
    }
}
...

```

The method gets passed an `ExternalInterfaceCallEventArgs` instance, named `e` in this example. That object, in turn, has a `FunctionCall` property that is an instance of the `ExternalInterfaceCall` class.



An `ExternalInterfaceCall` instance is a simple value object with two properties. The `FunctionName` property contains the function name specified in the `ActionScript ExternalInterface.Call()` statement. If any parameters are added in `ActionScript`, those parameters are included in the `ExternalInterfaceCall` object's `Arguments` property. In this case, the method that handles the event is simply a `switch` statement that acts like a traffic manager. The value of the `FunctionName` property (`e.FunctionCall.FunctionName`) determines which method of the `AppForm` class is called.

The branches of the `switch` statement in the previous code listing demonstrate common method call scenarios. For instance, any method must return a value to `ActionScript` (for example, the `isReady()` method call) or else should return `null` (as seen in the other method calls). Accessing parameters passed from `ActionScript` is demonstrated in the `newMessage()` method call (which passes along a parameter `e.FunctionCall.Arguments[0]`, the first element of the `Arguments` array).

Calling an `ActionScript` function from `C#` using the `ExternalInterfaceProxy` class is even more straightforward than receiving a function call from `ActionScript`. To call an `ActionScript` function, you use the `ExternalInterfaceProxy` instance's `Call()` method, as follows:

```
/// <summary>
/// Called when the "Send" button is pressed; the value in the
/// MessageText text field is passed in as a parameter.
/// </summary>
/// <param name="message">The message to send.</param>
private void sendMessage(string message)
{
    if (swfReady)
    {
        ...
        // Call the newMessage function in ActionScript.
        proxy.Call("newMessage", message);
    }
}

...
/// <summary>
/// Call the ActionScript function to get the current "availability"
/// status and write it into the text field.
/// </summary>
private void updateStatus()
{
    Status.Text = (string)proxy.Call("getStatus");
}

...
}
```

As this example shows, the `ExternalInterfaceProxy` class's `Call()` method is very similar to its ActionScript counterpart, `ExternalInterface.Call()`. The first parameter is a string, the name of the function to call. Any additional parameters (not shown here) are passed along to the ActionScript function. If the ActionScript function returns a value, that value is returned by the `Call()` method (as seen in the previous example).

## Inside the `ExternalInterfaceProxy` class

Using a proxy wrapper around the ActiveX control may not always be practical, or you may wish to write your own proxy class (for instance, in a different programming language or targeting a different platform). Although not all the details of creating a proxy will be explained here, it is instructive to understand the inner workings of the proxy class in this example.

You use the Shockwave Flash ActiveX control's `CallFunction()` method to call an ActionScript function from the ActiveX container using the external API. This is shown in this extract from the `ExternalInterfaceProxy` class's `Call()` method:

```
// Call an ActionScript function on the SWF in "_flashControl",
// which is a Shockwave Flash ActiveX control.
string response = _flashControl.CallFunction(request);
```

In this code excerpt, `_flashControl` is the Shockwave Flash ActiveX control. ActionScript function calls are made using the `CallFunction()` method. That method takes one parameter (`request` in the example), which is a string containing XML-formatted instructions including the name of the ActionScript function to call and any parameters. Any value returned from ActionScript is encoded as an XML-formatted string and sent back as the return value of the `CallFunction()` call. In this example, that XML string is stored in the `response` variable.

Receiving a function call from ActionScript is a multistep process. Function calls from ActionScript cause the Shockwave Flash ActiveX control to dispatch its `FlashCall` event, so a class (such as the `ExternalInterfaceProxy` class) that intends to receive calls from a SWF file needs to define a handler for that event. In the `ExternalInterfaceProxy` class, the event handler function is named `_flashControl_FlashCall()`, and it is registered to listen for the event in the class constructor, as follows:

```
private AxShockwaveFlash _flashControl;

public ExternalInterfaceProxy(AxShockwaveFlash flashControl)
{
    _flashControl = flashControl;
    _flashControl.FlashCall += new
        _IShockwaveFlashEvents_FlashCallEventHandler(_flashControl_FlashCall);
}
```

```

}
...
private void _flashControl_FlashCall(object sender,
    _IShockwaveFlashEvents_FlashCallEvent e)
{
    // Use the event object's request property ("e.request")
    // to execute some action.
    ...
    // Return a value to ActionScript;
    // the returned value must first be encoded as an XML-formatted string.
    _flashControl.SetReturnValue(encodedResponse);
}

```

The event object (e) has a request property (e.request) that is a string containing information about the function call, such as the function name and parameters, in XML format. This information can be used by the container to determine what code to execute. In the ExternalInterfaceProxy class, the request is converted from XML format to an ExternalInterfaceCall object, which provides the same information in a more accessible form. The ActiveX control's SetReturnValue() method is used to return a function result to the ActionScript caller; once again, the result parameter must be encoded in the XML format used by the external API.

Communication between ActionScript and an application hosting the Shockwave Flash ActiveX control uses a specific XML format to encode function calls and values. In the Introvert IM C# example, the ExternalInterfaceProxy class makes it possible for the code in the application form to operate directly on values sent to or received from ActionScript, and ignore the details of the XML format used by Flash Player. In order to accomplish this, the ExternalInterfaceProxy class uses the methods of the ExternalInterfaceSerializer class to actually translate the XML messages into .NET objects. The ExternalInterfaceSerializer class has four public methods:

- EncodeInvoke(): Encodes a function name and a C# ArrayList of arguments into the appropriate XML format.
- EncodeResult(): Encodes a result value into the appropriate XML format.
- DecodeInvoke(): Decodes a function call from ActionScript. The FlashCall event object's request property is passed to the DecodeInvoke() method, and it translates the call into an ExternalInterfaceCall object.
- DecodeResult(): Decodes the XML received as the result of calling an ActionScript function.

These methods encode C# values into the external API's XML format and decode the XML into C# objects. For details on the XML format used by Flash Player, see [“The external API's XML format” on page 740](#).



Security is a key concern of Adobe, users, website owners, and content developers. For this reason, Adobe Flash Player 9 includes a set of security rules and controls to safeguard the user, website owner, and content developer. This chapter discusses how to work with the Flash Player security model when you are developing Flash applications. In this chapter, all SWF files discussed are assumed to be published with ActionScript 3.0 (and thus running in Flash Player 9 or later), unless otherwise noted.

This chapter is intended as an overview of security; it does not try to comprehensively explain all implementation details, usage scenarios, or ramifications for using certain APIs. For a more detailed discussion of Flash Player Security concepts, see the *Flash Player 9 Security* white paper, at [www.adobe.com/go/fp9\\_0\\_security](http://www.adobe.com/go/fp9_0_security).

## Contents

Flash Player security overview .....	758
Overview of permission controls.....	760
Security sandboxes .....	770
Restricting networking APIs .....	773
Full-screen mode security .....	775
Loading content .....	776
Cross-scripting .....	779
Accessing loaded media as data.....	783
Loading data .....	786
Loading embedded content from SWF files imported into a security domain . . .	788
Working with legacy content .....	789
Setting LocalConnection permissions.....	790
Controlling access to scripts in a host web page.....	790
Shared objects .....	792
Camera, microphone, clipboard, mouse, and keyboard access.....	794

# Flash Player security overview

Much of Flash Player security is based on the domain of origin for loaded SWF files, media, and other assets. A SWF file from a specific Internet domain, such as `www.example.com`, can always access all data from that domain. These assets are put in the same security grouping, known as a *security sandbox*. (For more information, see [“Security sandboxes” on page 770](#).)

For example, a SWF file can load SWF files, bitmaps, audio, text files, and any other asset from its own domain. Also, cross-scripting between two SWF files from the same domain is always permitted, as long as both files are written using ActionScript 3.0. *Cross-scripting* is the ability of one SWF file to use ActionScript to access the properties, methods, and objects in another SWF file. Cross-scripting is not supported between SWF files written using ActionScript 3.0 and those using previous versions of ActionScript; however, these files can communicate by using the `LocalConnection` class. For more information, see [“Cross-scripting” on page 779](#).

The following basic security rules always apply by default:

- Resources in the same security sandbox can always access each other.
- SWF files in a remote sandbox can never access local files and data.

Flash Player considers the following to be individual domains, and sets up individual security sandboxes for each:

- `http://example.com`
- `http://www.example.com`
- `http://store.example.com`
- `https://www.example.com`
- `http://192.0.34.166`

Even if a named domain, such as `http://example.com`, maps to a specific IP address, such as `http://192.0.34.166`, Flash Player sets up separate security sandboxes for both.

There are two basic methods that a developer can use to grant a SWF file access to assets from sandboxes other than that of the SWF file:

- The `Security.allowDomain()` method (see [“Author \(developer\) controls” on page 769](#))
- The cross-domain policy file (see [“Website controls \(cross-domain policy files\)” on page 765](#))

The ability of a SWF file to cross-script ActionScript 3.0 SWF files from other domains and to load data from other domains is prohibited by default. It can be granted with a call to the `Security.allowDomain()` method in the loaded SWF file. For details, see [“Cross-scripting” on page 779](#).

In the Flash Player security model, there is a distinction between loading *content* and accessing or loading *data*:

- Loading content—*Content* is defined as media, including visual media Flash Player can display, audio, video, or a SWF file that includes displayed media. *Data* is defined as something that is accessible only to ActionScript code. You can load content using classes such as the Loader, Sound, and NetStream classes.
- Accessing content as data or loading data—You can access data in two ways: by extracting data from loaded media content or by directly loading data from an external file (such as an XML file). You can extract data from loaded media by using Bitmap objects, the `BitmapData.draw()` method, the `Sound.id3` property, or the `SoundMixer.computeSpectrum()` method. You can load data using classes such as the URLStream, URLLoader, Socket, and XMLSocket classes.

The Flash Player security model defines different rules for loading content and accessing data. In general, there are fewer restrictions on loading content than on accessing data.

In general, content (SWF files, bitmaps, mp3 files, and videos) can be loaded from anywhere, but if the content is from a domain other than that of the loading SWF file, it will be partitioned in a separate security sandbox.

There are a few barriers to loading content:

- By default, local SWF files (those loaded from a non-network address, such as a user's hard drive) are classified in the local-with-filesystem sandbox. These files cannot load content from the network. For more information, see [“Local sandboxes” on page 771](#).
- Real-Time Messaging Protocol (RTMP) servers can limit access to content. For more information, see [“Content delivered using RTMP servers” on page 779](#).

If the loaded media is an image, audio, or video, its data, such as pixel data and sound data, cannot be accessed by a SWF file outside its security sandbox, unless the domain of that SWF file has been included in a cross-domain policy file at the origin domain of the media. For details, see [“Accessing loaded media as data” on page 783](#).

Other forms of loaded data include text or XML files, which are loaded with a URLLoader object. Again in this case, to access any data from another security sandbox, permission must be granted by means of a cross-domain policy file at the origin domain. For details, see [“Using URLLoader and URLStream” on page 786](#).

# Overview of permission controls

The Flash Player client run-time security model has been designed around resources, which are objects such as SWF files, local data, and Internet URLs. *Stakeholders* are the parties who own or use those resources. Stakeholders can exercise controls (security settings) over their own resources, and each resource has four stakeholders. Flash Player strictly enforces a hierarchy of authority for these controls, as the following illustration shows:

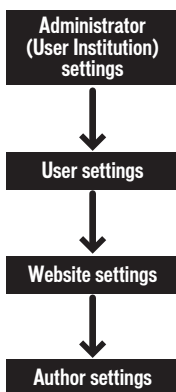

*Hierarchy of security controls*

This means, for instance, that if an administrator restricts access to a resource, no other stakeholders can override that restriction.

Administrator, user, and website controls are detailed in the following sections. Author (developer) settings are described in the rest of this chapter.

## Administrative user controls

An administrative user of a computer (a user who has logged in with administrative rights) can apply Flash Player security settings that affect all users of the computer. In a nonenterprise environment, such as on a home computer, there is usually one user who also has administrative access. Even in an enterprise environment, individual users may have administrative rights to the computer.

There are two types of administrative user controls:

- The `mms.cfg` file
- The Global Flash Player Trust directory



## The mms.cfg file

On Mac OS X systems, the mms.cfg file is located at /Library/Application Support/Macromedia/mms.cfg. On Microsoft Windows systems, the file is located in the Macromedia Flash Player folder in the system directory (for example, C:\windows\system32\macromed\flash\mms.cfg on a default Windows XP installation).

When Flash Player starts, it reads its security settings from this file, and uses them to limit functionality.

The mms.cfg file includes settings that the administrator uses to perform the following tasks:

- **Data loading**—Restrict the reading of local SWF files, disable file downloading and uploading, and set the storage limit for persistent shared objects.
- **Privacy controls**—Disable microphone and camera access, prevent SWF files from playing windowless content, and prevent SWF files in a domain that does not match the URL displayed in a browser window from accessing persistent shared objects.
- **Flash Player updates**—Set the interval for checking for an updated version of Flash Player, specify the URL to check for Flash Player update information, specify the URL from which to download updated versions of Flash Player, and disable automatic updates of Flash Player entirely.
- **Legacy file support**—Specify whether older-version SWF files should be placed in the local-trusted sandbox.
- **Local file security**—Specify whether local files can be placed in the local-trusted sandbox.
- **Full-screen mode**—Disable full-screen mode.

A SWF file can access some information on capabilities that have been disabled by calling the `Capabilities.avHardwareDisable` and `Capabilities.localFileReadDisable` properties. However, most of the settings in the mms.cfg file cannot be queried from ActionScript.

To enforce application-independent security and privacy policies for a computer, the mms.cfg file should be modified only by system administrators. The mms.cfg file is not for use by application installers. While an installer running with administrative privileges could modify the contents of the mms.cfg file, Adobe considers such usage a violation of the user's trust and urges creators of installers never to modify the mms.cfg file.

## The Global Flash Player Trust directory

Administrative users and installer applications can register specified local SWF files as trusted. These SWF files are assigned to the local-trusted sandbox. They can interact with any other SWF files, and they can load data from anywhere, remote or local. Files are designated as trusted in the Global Flash Player Trust directory, which is in the same directory as the `mms.cfg` file, in the following locations (locations are specific to the current user):

- Windows: `system\Macromed\Flash\FlashPlayerTrust`  
(for example, `C:\windows\system32\Macromed\Flash\FlashPlayerTrust`)
- Mac: `app support/Macromedia/FlashPlayerTrust`  
(for example, `/Library/Application Support/Macromedia/FlashPlayerTrust`)

The Flash Player Trust directory can contain any number of text files, each of which lists trusted paths, with one path per line. Each path can be an individual SWF file, HTML file, or directory. Comment lines begin with the `#` symbol. For example, a Flash Player trust configuration file containing the following text grants trusted status to all files in the specified directory and all subdirectories:

```
# Trust files in the following directories:  
C:\Documents and Settings\All Users\Documents\SampleApp
```

The paths listed in a trust configuration file should always be local paths or SMB network paths. Any HTTP path in a trust configuration file is ignored; only local files can be trusted.

To avoid conflicts, give each trust configuration file a filename corresponding to the installing application, and use a `.cfg` file extension.

As a developer distributing a locally run SWF file through an installer application, you can have the installer application add a configuration file to the Global Flash Player Trust directory, granting full privileges to the file that you are distributing. The installer application must be run by a user with administrative rights. Unlike the `mms.cfg` file, the Global Flash Player Trust directory is included for the purpose of installer applications granting trust permissions. Both administrative users and installer applications can designate trusted local applications using the Global Flash Player Trust directory.

There are also Flash Player Trust directories for individual users (see the next section, “[User controls](#)”).

## User controls

Flash Player provides three different user-level mechanisms for setting permissions: the Settings UI, the Settings Manager, and the User Flash Player Trust directory.

### The Settings UI and Settings Manager

The Settings UI is a quick, interactive mechanism for configuring the settings for a specific domain. The Settings Manager presents a more detailed interface and provides the ability to make global changes that affect permissions for many or all domains. Additionally, when a new permission is requested by a SWF file, requiring run-time decisions concerning security or privacy, dialog boxes are displayed in which users can adjust some Flash Player settings.

The Settings Manager and Settings UI provide the following security-related options:

- Camera and microphone settings—The user can control Flash Player access to the camera and microphone on the computer. The user can allow or deny access for all sites or for specific sites. If the user does not specify a setting for all sites or a specific site, a dialog box is displayed when a SWF file attempts to access the camera or microphone, letting the user choose whether or not to allow the SWF file to access the device. The user can also specify the camera or microphone to use, and can set the sensitivity of the microphone.
- Shared object storage settings—The user can select the amount of disk space that a domain can use to store persistent shared objects. The user can make these settings for any numbers of specific domains, and can specify the default setting for new domains. The default limit is 100 KB of disk space. For more information on persistent shared objects, see the SharedObject class in the *ActionScript 3.0 Language and Components Reference*.

NOTE

Any settings made in the mms.cfg file (see “Administrative user controls” on page 760) are not reflected in the Settings Manager.

For details on the Settings Manager, see [www.adobe.com/go/settingsmanager](http://www.adobe.com/go/settingsmanager).

## The User Flash Player Trust directory

Users and installer applications can register specified local SWF files as trusted. These SWF files are assigned to the local-trusted sandbox. They can interact with any other SWF files, and they can load data from anywhere, remote or local. A user designates a file as trusted in the User Flash Player Trust directory, which is in same directory as the Flash shared object storage area, in the following locations (locations are specific to the current user):

- Windows: app data\Macromedia\Flash Player\#Security\FlashPlayerTrust  
(for example, C:\Documents and Settings\JohnD\Application Data\Macromedia\Flash Player\#Security\FlashPlayerTrust)

NOTE

In Windows, the Application Data folder is hidden by default. To show hidden folders and files, select My Computer to open Windows Explorer, select Tools>Folder Options and then select the View tab. Under the View tab, select the Show hidden files and folders radio button.

- Mac: app data/Macromedia/Flash Player/#Security/FlashPlayerTrust  
(for example, /Users/JohnD/Library/Preferences/Macromedia/Flash Player/#Security/FlashPlayerTrust)

These settings affect only the current user, not other users who log in to the computer. If a user without administrative rights installs an application in their own portion of the system, the User Flash Player Trust directory lets the installer register the application as trusted for that user.

As a developer distributing a locally run SWF file by way of an installer application, you can have the installer application add a configuration file to the User Flash Player Trust directory, granting full privileges to the file that you are distributing. Even in this situation, the User Flash Player Trust directory file is considered a user control, because a user action (installation) initiates it.

There is also a Global Flash Player Trust directory, used by the administrative user or installers to register an application for all users of a computer (see [“Administrative user controls”](#) on page 760).

## Website controls (cross-domain policy files)

To make data from a web server available to SWF files from other domains, you can create a cross-domain policy file on your server. A *cross-domain policy file* is an XML file that provides a way for the server to indicate that its data and documents are available to SWF files served from certain domains or from all domains. Any SWF file that is served from a domain specified by the server's policy file is permitted to access data or assets from that server.

Cross-domain policy files affect access to a number of assets, including the following:

- Data in bitmaps, sounds, and videos
- Loading XML and text files
- Access to socket and XML socket connections
- Importing SWF files from other security domains into the security domain of the loading SWF file

Full details are provided in the rest of this chapter.

### Policy file syntax

The following example shows a policy file that permits access to SWF files that originate from \*.example.com, www.friendOfExample.com and 192.0.34.166:

```
<?xml version="1.0"?>
<cross-domain-policy>
  <allow-access-from domain="*.example.com" />
  <allow-access-from domain="www.friendOfExample.com" />
  <allow-access-from domain="192.0.34.166" />
</cross-domain-policy>
```

When a SWF file attempts to access data from another domain, Flash Player automatically attempts to load a policy file from that domain. If the domain of the SWF file that is attempting to access the data is included in the policy file, the data is automatically accessible.

By default, policy files must be named `crossdomain.xml` and must reside in the root directory of the server. However, a SWF file can check for a different name or in a different directory location by calling the `Security.loadPolicyFile()` method. A cross-domain policy file applies only to the directory from which it is loaded and to its child directories. So a policy file in the root directory applies to the whole server, but a policy file loaded from an arbitrary subdirectory applies only to that directory and its subdirectories.

A policy file affects access only to the particular server on which it resides. For example, a policy file located at `https://www.adobe.com:8080/crossdomain.xml` will apply only to data-loading calls made to `www.adobe.com` over HTTPS at port 8080.

A cross-domain policy file contains a single `<cross-domain-policy>` tag, which in turn contains zero or more `<allow-access-from>` tags. Each `<allow-access-from>` tag contains an attribute, `domain`, which specifies either an exact IP address, an exact domain, or a wildcard domain (any domain). Wildcard domains are indicated by either a single asterisk (\*), which matches all domains and all IP addresses, or an asterisk followed by a suffix, which matches only those domains that end with the specified suffix. Suffixes must begin with a dot. However, wildcard domains with suffixes can match domains that consist of only the suffix without the leading dot. For example, `foo.com` is considered to be part of `*.foo.com`. Wildcards are not allowed in IP domain specifications.

If you specify an IP address, access is granted only to SWF files loaded from that IP address using IP syntax (for example, `http://65.57.83.12/flashmovie.swf`), not those loaded using domain-name syntax. Flash Player does not perform DNS resolution.

You can permit access to documents originating from any domain, as shown in the following example:

```
<?xml version="1.0"?>
<!-- http://www.foo.com/crossdomain.xml -->
<cross-domain-policy>
  <allow-access-from domain="*" />
</cross-domain-policy>
```

Each `<allow-access-from>` tag also has the optional `secure` attribute, which defaults to `true`. You can set the attribute to `false` if your policy file is on an HTTPS server, and you want to allow SWF files on a non-HTTPS server to load data from the HTTPS server.

Setting the `secure` attribute to `false` could compromise the security offered by HTTPS. In particular, setting this attribute to `false` opens secure content to snooping and spoofing attacks. Adobe strongly recommends that you not set the `secure` attribute to `false`.

If data to be loaded is on a HTTPS server, but the SWF file loading it is on an HTTP server, Adobe recommends that you move the loading SWF file to an HTTPS server so that you can keep all copies of your secure data under the protection of HTTPS. However, if you decide that you must keep the loading SWF file on an HTTP server, add the `secure="false"` attribute to the `<allow-access-from>` tag, as shown in the following code:

```
<allow-access-from domain="www.example.com" secure="false" />
```

A policy file that contains no `<allow-access-from>` tags has the same effect as not having a policy on a server.

## Socket policy files

ActionScript objects instantiate two different kinds of server connections: document-based server connections and socket connections. ActionScript objects like Loader, Sound, URLLoader, and URLStream instantiate document-based server connections, and these each load a file from a URL. ActionScript Socket and XMLSocket objects make socket connections, which operate with streaming data, not loaded documents. Flash Player supports two kinds of policy files: document-based policy files and socket policy files. Document-based connections require document-based policy files, while socket connections require socket policy files.

Flash Player requires that a policy file be transmitted using the same kind of protocol that the attempted connection wishes to use. For example, when you place a policy file on your HTTP server, SWF files from other domains are allowed to load data from it as an HTTP server. However, by not providing a socket policy file at the same server, you are forbidding SWF files from other domains to connect to the server at the socket level. The means by which a socket policy file is retrieved must match the means of connecting.

A policy file served by a socket server has the same syntax as any other policy file, except that it must also specify the ports to which it grants access. When a policy file comes from a port number that is less than 1024, it may grant access to any ports; when a policy file comes from port 1024 or higher, it may only grant access to ports 1024 and higher. The allowed ports are specified in a `to-ports` attribute in the `<allow-access-from>` tag. Single port numbers, port ranges, and wildcards are accepted values.

Here is an example XMLSocket policy file:

```
<cross-domain-policy>
  <allow-access-from domain="*" to-ports="507" />
  <allow-access-from domain="*.example.com" to-ports="507,516" />
  <allow-access-from domain="*.example2.com" to-ports="516-523" />
  <allow-access-from domain="www.example2.com" to-ports="507,516-523" />
  <allow-access-from domain="www.example3.com" to-ports="*" />
</cross-domain-policy>
```

When policy files were first introduced in Flash Player 6, there was no support for socket policy files. Connections to socket servers were authorized by a policy file from the default location of the cross-domain policy file on an HTTP server on port 80 of the same host as the socket server. To make it possible to preserve existing server arrangements, Flash Player 9 still supports this capability. However, Flash Player's default is now to retrieve a socket policy file on the same port as the socket connection. If you wish to use an HTTP-based policy file to authorize a socket connection, you must explicitly request the HTTP policy file using code such as the following:

```
Security.loadPolicyFile("http://socketServerHost.com/crossdomain.xml")
```

In addition, in order to authorize socket connections, an HTTP policy file must come only from the default location of the cross-domain policy file, and not from any other HTTP location. A policy file obtained from an HTTP server implicitly authorizes socket access to all ports 1024 and above; any `to-ports` attributes in an HTTP policy file are ignored.

For more information on socket policy files, see [“Connecting to sockets” on page 786](#).

## Preloading policy files

Loading data from a server or connecting to a socket is an asynchronous operation, and Flash Player simply waits for the cross-domain policy file to finish downloading before it begins the main operation. However, extracting pixel data from images or extracting sample data from sounds is a synchronous operation—the cross-domain policy file must load before you can extract data. When you load the media, you need to specify that it check for a cross-domain policy file:

- When using the `Loader.load()` method, set the `checkPolicyFile` property of the `context` parameter, which is a `LoaderContext` object.
- When embedding an image in a text field using the `<img>` tag, set the `checkPolicyFile` attribute of the `<img>` tag to `"true"`, as in the following: `<img checkPolicyFile = "true" src = "example.jpg">`.
- When using the `Sound.load()` method, set the `checkPolicyFile` property of the `context` parameter, which is a `SoundLoaderContext` object.
- When using the `NetStream` class, set the `checkPolicyFile` property of the `NetStream` object.

When you set one of these parameters, Flash Player first checks for any policy files that it already has downloaded for that domain. Then it considers any pending calls to the `Security.loadPolicyFile()` method to see if they are in scope, and waits for those if they are. Then it looks for the cross-domain policy file in the default location on the server.



## Author (developer) controls

The main ActionScript API used to grant security privileges is the `Security.allowDomain()` method, which grants privileges to SWF files in the domains that you specify. In the following example, a SWF file grants access to SWF files served from the `www.example.com` domain:

```
Security.allowDomain("www.example.com")
```

This method grants permissions for the following:

- Cross-scripting between SWF files (see [“Cross-scripting” on page 779](#))
- Display list access (see [“Traversing the display list” on page 782](#))
- Event detection (see [“Event security” on page 782](#))
- Full access to properties and methods of the Stage object (see [“Stage security” on page 781](#))

The primary purpose of calling the `Security.allowDomain()` method is to grant permission for SWF files in an outside domain to script the SWF file calling the

`Security.allowDomain()` method. For more information, see [“Cross-scripting” on page 779](#).

Specifying an IP address as a parameter to the `Security.allowDomain()` method does not permit access by all parties that originate at the specified IP address. Instead, it permits access only by a party that contains the specified IP address as its URL, rather than a domain name that maps to that IP address. For example, if the domain name `www.example.com` maps to the IP address `192.0.34.166`, a call to `Security.allowDomain("192.0.34.166")` does not grant access to `www.example.com`.

You can pass the `*` wildcard to the `Security.allowDomain()` method to allow access from all domains. Because it grants permission for SWF files from *all* domains to script the calling SWF file, use the `*` wildcard with care.

ActionScript includes a second permission API, called `Security.allowInsecureDomain()`. This method does the same thing as the `Security.allowDomain()` method, except that, when called from a SWF file served by a secure HTTPS connection, it additionally permits access to the calling SWF file by other SWF files that are served from an insecure protocol, such as HTTP. However, it is not a good security practice to allow scripting between files from a secure protocol (HTTPS) and those from insecure protocols (such as HTTP); doing so can open secure content to snooping and spoofing attacks. Here is how such attacks can work: since the `Security.allowInsecureDomain()` method allows access to your secure HTTPS data by SWF files served over HTTP connections, an attacker interposed between your HTTP server and your users could replace your HTTP SWF file with one of their own, which can then access your HTTPS data.

Another important security-related method is the `Security.loadPolicyFile()` method, which causes Flash Player to check for a cross-domain policy file at a nonstandard location. For more information, see [“Website controls \(cross-domain policy files\)” on page 765](#).

## Security sandboxes

Client computers can obtain individual SWF files from a number of sources, such as from external web sites or from a local file system. Flash Player individually assigns SWF files and other resources, such as shared objects, bitmaps, sounds, videos, and data files, to security sandboxes based on their origin when they are loaded into Flash Player. The following sections describe the rules, enforced by Flash Player, that govern what a SWF file within a given sandbox can access.

For more information on security sandboxes, see the *Flash Player 9 Security* white paper.

## Remote sandboxes

Flash Player classifies assets (including SWF files) from the Internet in separate sandboxes that correspond to their website origin domains. By default, these files are authorized to access any resources from their own server. Remote SWF files can be allowed to access additional data from other domains by explicit website and author permissions, such as cross-domain policy files and the `Security.allowDomain()` method. For details, see [“Website controls \(cross-domain policy files\)” on page 765](#) and [“Author \(developer\) controls” on page 769](#).

Remote SWF files cannot load any local files or resources.

For more information, see the *Flash Player 9 Security* white paper.

## Local sandboxes

*Local file* describes any file that is referenced by using the `file:` protocol or a Universal Naming Convention (UNC) path. Local SWF files are placed into one of three local sandboxes:

- The local-with-filesystem sandbox—For security purposes, Flash Player places all local SWF files and assets in the local-with-file-system sandbox, by default. From this sandbox, SWF files can read local files (by using the `URLLoader` class, for example), but they cannot communicate with the network in any way. This assures the user that local data cannot be leaked out to the network or otherwise inappropriately shared.
- The local-with-networking sandbox—When compiling a SWF file, you can specify that it has network access when run as a local file (see [“Setting the sandbox type of local SWF files” on page 772](#)). These files are placed in the local-with-networking sandbox. SWF files that are assigned to the local-with-networking sandbox forfeit their local file access. In return, the SWF files are allowed to access data from the network. However, a local-with-networking SWF file is still not allowed to read any network-derived data unless permissions are present for that action, through a cross-domain policy file or a call to the `Security.allowDomain()` method. In order to grant such permission, a cross-domain policy file must grant permission to *all* domains by using `<allow-access-from domain="*" />` or by using `Security.allowDomain("*")`. For more information, see [“Website controls \(cross-domain policy files\)” on page 765](#) and [“Author \(developer\) controls” on page 769](#).
- The local-trusted sandbox—Local SWF files that are registered as trusted (by users or by installer programs) are placed in the local-trusted sandbox. System administrators and users also have the ability to reassign (move) a local SWF file to or from the local-trusted sandbox based on security considerations (see [“Administrative user controls” on page 760](#) and [“User controls” on page 763](#)). SWF files that are assigned to the local-trusted sandbox can interact with any other SWF files and can load data from anywhere (remote or local).

Communication between the local-with-networking and local-with-filesystem sandboxes, as well as communication between the local-with-filesystem and remote sandboxes, is strictly forbidden. Permission to allow such communication cannot be granted by a Flash application or by a user or administrator.

Scripting in either direction between local HTML files and local SWF files—for example, using the `ExternalInterface` class—requires that both the HTML file and SWF file involved be in the local-trusted sandbox. This is because the local security models for browsers differ from the Flash Player local security model.

SWF files in the local-with-networking sandbox cannot load SWF files in the local-with-filesystem sandbox. SWF files in the local-with-filesystem sandbox cannot load SWF files in the local-with-networking sandbox.

## Setting the sandbox type of local SWF files

You can configure a SWF file for the local-with-filesystem sandbox or the local-with-networking sandbox by setting the document's publish settings in the Adobe Flash CS3 Professional authoring tool. For more information, see [“Set publish options for the Flash SWF file format”](#) in *Using Flash*.

An end user or the administrator of a computer can specify that a local SWF file is trusted, allowing it to load data from all domains, both local and network. This is specified in the Global Flash Player Trust and User Flash Player Trust directories. For more information, see [“Administrative user controls”](#) on page 760 and [“User controls”](#) on page 763.

For more information on local sandboxes, see [“Local sandboxes”](#) on page 771.

## The Security.sandboxType property

An author of a SWF file can use the read-only static `Security.sandboxType` property to determine the type of sandbox to which Flash Player has assigned the SWF file. The `Security` class includes constants that represent possible values of the `Security.sandboxType` property, as follows:

- `Security.REMOTE`—The SWF file is from an Internet URL, and operates under domain-based sandbox rules.
- `Security.LOCAL_WITH_FILE`—The SWF file is a local file, but it has not been trusted by the user and was not published with a networking designation. The SWF file can read from local data sources but cannot communicate with the Internet.
- `Security.LOCAL_WITH_NETWORK`—The SWF file is a local file and has not been trusted by the user, but it was published with a networking designation. The SWF can communicate with the Internet but cannot read from local data sources.
- `Security.LOCAL_TRUSTED`—The SWF file is a local file and has been trusted by the user, using either the Settings Manager or a Flash Player trust configuration file. The SWF file can both read from local data sources and communicate with the Internet.

# Restricting networking APIs

You can control a SWF file's access to network functionality by setting the `allowNetworking` parameter in the `<object>` and `<embed>` tags in the HTML page that contains the SWF content.

Possible values of `allowNetworking` are:

- "all" (the default)—All networking APIs are permitted in the SWF.
- "internal"—The SWF file may not call browser navigation or browser interaction APIs, listed later in this section, but it may call any other networking APIs.
- "none"—The SWF file may not call browser navigation or browser interaction APIs, listed later in this section, and it cannot use any SWF-to-SWF communication APIs, also listed later.

Calling a prevented API throws a `SecurityError` exception.

To set the `allowNetworking` parameter, in the `<object>` and `<embed>` tags in the HTML page that contains a reference the SWF file, add the `allowNetworking` parameter and set its value, as shown in the following example:

```
<object classid="clsid:d27cdb6e-ae6d-11cf-96b8-444553540000"
  codebase="http://fpdownload.macromedia.com/pub/shockwave/cabs/flash/
  swflash.cab#version=9,0,18,0"
  width="600" height="400" id="test" align="middle">
<param name="allowNetworking" value="none" />
<param name="movie" value="test.swf" />
<param name="bgcolor" value="#333333" />
<embed src="test.swf" allowNetworking="none" bgcolor="#333333"
  width="600" height="400"
  name="test" align="middle" type="application/x-shockwave-flash"
  pluginspage="http://www.macromedia.com/go/getflashplayer" />
</object>
```

An HTML page may also use a script to generate SWF-embedding tags. You need to alter the script so that it inserts the proper `allowNetworking` settings. HTML pages generated by Flash and Adobe Flex Builder use the `AC_FL_RunContent()` function to embed references to SWF files, and you need to add the `allowNetworking` parameter settings to the script, as in the following:

```
AC_FL_RunContent( ... "allowNetworking", "none", ...)
```

The following APIs are prevented when `allowNetworking` is set to "internal":

- `navigateToURL()`
- `fscommand()`
- `ExternalInterface.call()`

An addition to those APIs on the previous list, the following APIs are also prevented when `allowNetworking` is set to "none":

- `sendToURL()`
- `FileReference.download()`
- `FileReference.upload()`
- `Loader.load()`
- `LocalConnection.connect()`
- `LocalConnection.send()`
- `NetConnection.connect()`
- `NetStream.play()`
- `Security.loadPolicyFile()`
- `SharedObject.getLocal()`
- `SharedObject.getRemote()`
- `Socket.connect()`
- `Sound.load()`
- `URLLoader.load()`
- `URLStream.load()`
- `XMLSocket.connect()`

Even if the selected `allowNetworking` setting permits a SWF file to use a networking API, there may be other restrictions based on security sandbox limitations, as described in this chapter.

When `allowNetworking` is set to "none", you cannot reference external media in an `<img>` tag in the `htmlText` property of a `TextField` object (a `SecurityError` exception is thrown).

When `allowNetworking` is set to "none", a symbol from an imported shared library added in the Flash authoring tool (not ActionScript) is blocked at run time.

# Full-screen mode security

Flash Player 9.0.27.0 and later support full-screen mode, in which Flash content can fill the entire screen. To enter full-screen mode, the `displayState` property of the Stage is set to the `StageDisplayState.FULL_SCREEN` constant. For more information, see [“Working with full-screen mode” on page 391](#).

For SWF files running in a browser, there are some security considerations.

To enable full-screen mode, in the `<object>` and `<embed>` tags in the HTML page that contains a reference to the SWF file, add the `allowFullScreen` parameter, with its value set to `"true"` (the default value is `"false"`), as shown in the following example:

```
<object classid="clsid:d27cdb6e-ae6d-11cf-96b8-444553540000"
  codebase="http://fpdownload.macromedia.com/pub/shockwave/cabs/flash/
  swflash.cab#version=9,0,18,0"
  width="600" height="400" id="test" align="middle">
<param name="allowFullScreen" value="true" />
<param name="movie" value="test.swf" />
<param name="bgcolor" value="#333333" />
<embed src="test.swf" allowFullScreen="true" bgcolor="#333333"
  width="600" height="400"
  name="test" align="middle" type="application/x-shockwave-flash"
  pluginspage="http://www.macromedia.com/go/getflashplayer" />
</object>
```

An HTML page may also use a script to generate SWF-embedding tags. You must alter the script so that it inserts the proper `allowFullScreen` settings. HTML pages generated by Flash and Flex Builder use the `AC_FL_RunContent()` function to embed references to SWF files, and you need to add the `allowFullScreen` parameter settings, as in the following:

```
AC_FL_RunContent( ... "allowFullScreen", "true", ...)
```

The ActionScript that initiates full-screen mode can be called only in response to a mouse event or keyboard event. If it is called in other situations, Flash Player throws an exception.

Users cannot enter text in text input fields while in full-screen mode. All keyboard input and keyboard-related ActionScript is disabled while in full-screen mode, with the exception of the keyboard shortcuts (such as pressing the Esc key) that return the application to normal mode.

A message appears when the content enters full-screen mode, instructing the user how to exit and return to normal mode. The message appears for a few seconds and then fades out.

Calling the `displayState` property of a Stage object throws an exception for any caller that is not in the same security sandbox as the Stage owner (the main SWF file). For more information, see [“Stage security” on page 781](#).

Administrators can disable full-screen mode for SWF files running in browsers by setting `FullScreenDisable = 1` in the `mms.cfg` file. For details, see [“Administrative user controls” on page 760](#).

In a browser, a SWF file must be contained in an HTML page to allow full-screen mode. Full-screen mode is always permitted in the stand-alone player or in a projector file.

## Loading content

A SWF file can load the following types of content:

- SWF files
- Images
- Sound
- Video

## Loading SWF files and images

You use the `Loader` class to load SWF files and images (JPG, GIF, or PNG files). Any SWF file, other than one in the `local-with-file-system` sandbox, can load SWF files and images from any network domain. Only SWF files in local sandboxes can load SWF files and images from the local file system. However, files in the `local-with-networking` sandbox can only load local SWF files that are in the `local-trusted` or `local-with-networking` sandbox. SWF files in the `local-with-networking` sandbox load local content other than SWF files (such as images), however they cannot access data in the loaded content.

When loading a SWF file from a non-trusted source (such as a domain other than that of the `Loader` object’s root SWF file), you may want to define a mask for the `Loader` object, to prevent the loaded content (which is a child of the `Loader` object) from drawing to portions of the `Stage` outside of that mask, as in the following code:

```
import flash.display.*;
import flash.net.URLRequest;
var rect:Shape = new Shape();
rect.graphics.beginFill(0xFFFFFF);
rect.graphics.drawRect(0, 0, 100, 100);
addChild(rect);
var ldr:Loader = new Loader();
ldr.mask = rect;
var url:String = "http://www.unknown.example.com/content.swf";
var urlReq:URLRequest = new URLRequest(url);
ldr.load(urlReq);
addChild(ldr);
```



When you call the `load()` method of the Loader object, you can specify a `context` parameter, which is a `LoaderContext` object. The `LoaderContext` class includes three properties that let you define the context of how the loaded content can be used:

- `checkPolicyFile`: Use this property only when loading an image file (not a SWF file). Specify this for an image file from a domain other than that of the file containing the Loader object. If you set this property to `true`, the Loader checks the origin server for a cross-domain policy file (see “[Website controls \(cross-domain policy files\)](#)” on page 765). If the server grants permission to the Loader domain, ActionScript from SWF files in the Loader domain can access data in the loaded image. In other words, you can use the `Loader.content` property to obtain a reference to the `Bitmap` object that represents the loaded image, or the `BitmapData.draw()` method to access pixels from the loaded image.
- `securityDomain`: Use this property only when loading a SWF file (not an image). Specify this for a SWF file from a domain other than that of the file containing the Loader object. Only two values are currently supported for the `securityDomain` property: `null` (the default) and `SecurityDomain.currentDomain`. If you specify `SecurityDomain.currentDomain`, this requests that the loaded SWF file be *imported* to the sandbox of the loading SWF file, meaning that it operates as though it had been loaded from the loading SWF file’s own server. This is only permitted if a cross-domain policy file is found on the loaded SWF file’s server, allowing access by the loading SWF file’s domain. If the required policy file is found, the loader and loadee can freely script each other once the load begins, since they are in the same sandbox. Note that sandbox importing can mostly be replaced by performing an ordinary load and then having the loaded SWF file call the `Security.allowDomain()` method. This latter method may be easier to use, since the loaded SWF file will then be in its own natural sandbox, and thus able to access resources on its own actual server.
- `applicationDomain`: Use this property only when loading a SWF file written in ActionScript 3.0 (not an image or a SWF file written in ActionScript 1.0 or 2.0). When loading the file, you can specify that the file be placed into a particular application domain, rather than the default of being placed in a new application domain that is a child of the loading SWF file’s application domain. Note that application domains are subunits of security domains, and thus you can specify a target application domain only if the SWF file that you are loading is from your own security domain, either because it is from your own server, or because you have successfully imported it into your security domain using the `securityDomain` property. If you specify an application domain but the loaded SWF file is part of a different security domain, the domain you specify in `applicationDomain` is ignored. For more information, see “[Using the ApplicationDomain class](#)” on page 700.

For details, see “[Specifying loading context](#)” on page 421.

An important property of a Loader object is the `contentLoaderInfo` property, which is a `LoaderInfo` object. Unlike most other objects, a `LoaderInfo` object is shared between the loading SWF file and the loaded content, and it is always accessible to both parties. When the loaded content is a SWF file, it can access the `LoaderInfo` object through the `DisplayObject.loaderInfo` property. `LoaderInfo` objects include information such as load progress, the URLs of loader and loadee, the trust relationship between loader and loadee, and other information. For more information, see [“Monitoring loading progress” on page 420](#).

## Loading sound and videos

All SWF files, other than those in the `local-with-filesystem` sandbox, are allowed to load sound and video from network origins, using the `Sound.load()`, `NetConnection.connect()`, and `NetStream.play()` methods.

Only local SWF files can load media from the local file system. Only SWF files in the `local-with-filesystem` sandbox or the `local-trusted` sandbox can access data in these loaded files.

There are other restrictions on accessing data from loaded media. For details, see [“Accessing loaded media as data” on page 783](#).

## Loading SWF files and images using the <img> tag in a text field

You can load SWF files and bitmaps into a text field by using the `<img>` tag, as in the following code:

```
<img src = 'filename.jpg' id = 'instanceName' >
```

You can access content loaded this way by using the `getImageReference()` method of the `TextField` instance, as in the following code:

```
var loadedObject:DisplayObject =  
    myTextField.getImageReference('instanceName');
```

Note, however, that SWF files and images loaded in this way are put in the sandbox that corresponds to their origin.

When you load an image file using an `<img>` tag in a text field, access to the data in the image may be permitted by a cross-domain policy file. You can check for a policy file by adding a `checkPolicyFile` attribute to the `<img>` tag, as in the following code:

```
<img src = 'filename.jpg' checkPolicyFile = 'true' id = 'instanceName' >
```

When you load a SWF using an `<img>` tag in a text field, you can permit access to that SWF file's data through a call to the `Security.allowDomain()` method.

When you use an `<img>` tag in a text field to load an external file (as opposed to using a `Bitmap` class embedded within your SWF), a `Loader` object is automatically created as a child of the `TextField` object, and the external file is loaded into that `Loader` just as if you had used a `Loader` object in ActionScript to load the file. In this case, the `getImageReference()` method returns the `Loader` that was automatically created. No security check is needed to access this `Loader` object because it is in the same security sandbox as the calling code.

However, when you refer to the `content` property of the `Loader` object to access the loaded media, security rules apply. If the content is an image, you need to implement a cross-domain policy file, and if the content is a SWF file, you need to have the code in the SWF file call the `allowDomain()` method.

## Content delivered using RTMP servers

Flash Media Server uses the Real-Time Media Protocol (RTMP) to serve data, audio, and video. A SWF file loads this media by using the `connect()` method of the `NetConnection` class, passing an RTMP URL as the parameter. Flash Media Server can restrict connections and prevent content from downloading, based on the domain of the requesting file. For details, see the Flash Media Server documentation.

For media loaded from RTMP sources, you cannot use the `BitmapData.draw()` and `SoundMixer.computeSpectrum()` methods to extract run-time graphics and sound data.

## Cross-scripting

If two SWF files written with ActionScript 3.0 are served from the same domain—for example, the URL for one SWF file is `http://www.example.com/swfA.swf` and the URL for the other is `http://www.example.com/swfB.swf`—then one SWF file can examine and modify variables, objects, properties, methods, and so on in the other, and vice versa. This is called *cross-scripting*.

Cross-scripting is not supported between AVM1 SWF files and AVM2 SWF files. An AVM1 SWF file is one created by using ActionScript 1.0 or ActionScript 2.0. (AVM1 and AVM2 refer to the ActionScript Virtual Machine.) You can, however, use the `LocalConnection` class to send data between AVM1 and AVM2.

If two SWF files written with ActionScript 3.0 are served from different domains—for example, `http://siteA.com/swfA.swf` and `http://siteB.com/swfB.swf`—then, by default, Flash Player does not allow `swfA.swf` to script `swfB.swf`, nor `swfB.swf` to script `swfA.swf`. A SWF file gives permission to SWF files from other domains by calling `Security.allowDomain()`. By calling `Security.allowDomain("siteA.com")`, `swfB.swf` gives SWF files from `siteA.com` permission to script it.

In any cross-domain situation, it is important to be clear about the two parties involved. For the purposes of this discussion, the side that is performing the cross-scripting is called the *accessing party* (usually the accessing SWF), and the other side is called the *party being accessed* (usually the SWF being accessed). When `siteA.swf` scripts `siteB.swf`, `siteA.swf` is the accessing party, and `siteB.swf` is the party being accessed, as the following illustration shows:

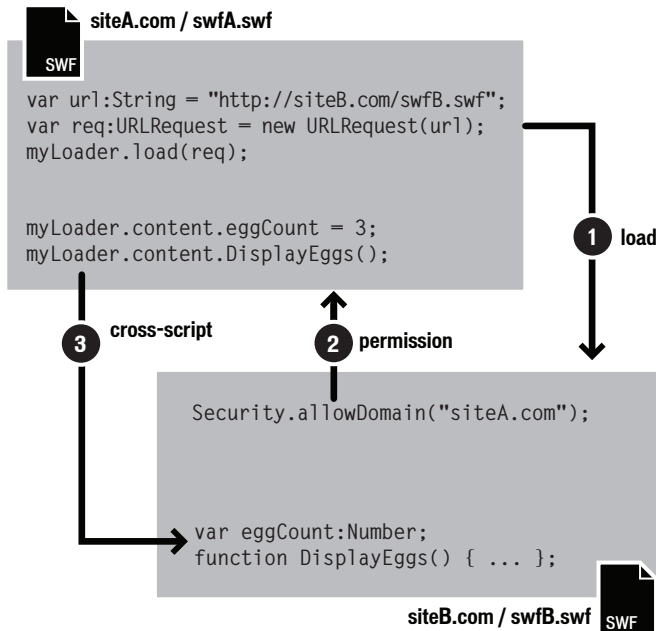

Cross-domain permissions that are established with the `Security.allowDomain()` method are asymmetrical. In the previous example, `siteA.swf` can script `siteB.swf`, but `siteB.swf` cannot script `siteA.swf`, because `siteA.swf` has not called the `Security.allowDomain()` method to give SWF files at `siteB.com` permission to script it. You can set up symmetrical permissions by having both SWF files call the `Security.allowDomain()` method.

In addition to protecting SWF files from cross-domain scripting originated by other SWF files, Flash Player protects SWF files from cross-domain scripting originated by HTML files. HTML-to-SWF scripting can occur with callbacks established through the `ExternalInterface.addCallback()` method. When HTML-to-SWF scripting crosses domains, the SWF file being accessed must call the `Security.allowDomain()` method, just as when the accessing party is a SWF file, or the operation will fail. For more information, see [“Author \(developer\) controls” on page 769](#).

Also, Flash Player provides security controls for SWF-to-HTML scripting. For more information, see [“Controlling access to scripts in a host web page” on page 790](#).

## Stage security

Some properties and methods of the Stage object are available to any sprite or movie clip on the display list.

However, the Stage object is said to have an owner: the first SWF file loaded. By default, the following properties and methods of the Stage object are available only to SWF files in the same security sandbox as the Stage owner:

Properties		Methods
<code>align</code>	<code>showDefaultContextMenu</code>	<code>addChild()</code>
<code>displayState</code>	<code>stageFocusRect</code>	<code>addChildAt()</code>
<code>frameRate</code>	<code>stageHeight</code>	<code>addEventListener()</code>
<code>height</code>	<code>stageWidth</code>	<code>dispatchEvent()</code>
<code>mouseChildren</code>	<code>tabChildren</code>	<code>hasEventListener()</code>
<code>numChildren</code>	<code>textSnapshot</code>	<code>setChildIndex()</code>
<code>quality</code>	<code>width</code>	<code>willTrigger()</code>
<code>scaleMode</code>		

In order for a SWF file in a sandbox other than that of the Stage owner to access these properties and methods, the Stage owner SWF file must call the `Security.allowDomain()` method to permit the domain of the external sandbox. For more information, see [“Author \(developer\) controls” on page 769](#).

The `frameRate` property is a special case—any SWF file can read the `frameRate` property. However, only those in the Stage owner’s security sandbox (or those granted permission by a call to the `Security.allowDomain()` method) can change the property.

There are also restrictions on the `removeChildAt()` and `swapChildrenAt()` methods of the Stage object, but these are different from the other restrictions. Rather than needing to be in the same domain as the Stage owner, to call these methods code must be in the same domain as the owner of the affected child object(s), or the child object(s) can call the `Security.allowDomain()` method.

## Traversing the display list

The ability of one SWF file to access display objects loaded from other sandboxes is restricted. In order for a SWF file to access a display object created by another SWF file in a different sandbox, the SWF file being accessed must call the `Security.allowDomain()` method to permit access by the domain of the accessing SWF file. For more information, see [“Author \(developer\) controls” on page 769](#).

To access a Bitmap object that was loaded by a Loader object, a cross-domain policy file must exist on the origin server of the image file, and that cross-domain policy file must grant permission to the domain of the SWF file trying to access the Bitmap object (see [“Website controls \(cross-domain policy files\)” on page 765](#)).

The LoaderInfo object that corresponds to a loaded file (and to the Loader object) includes the following three properties, which define the relationship between the loaded object and the Loader object: `childAllowsParent`, `parentAllowsChild`, and `sameDomain`.

## Event security

Events related to the display list have security access limitations, based on the sandbox of the display object that is dispatching the event. An event in the display list has bubbling and capture phases (described in [Chapter 10, “Handling events,” on page 313](#)). During the bubbling and capture phases, an event migrates from the source display object through parent display objects in the display list. If a parent object is in a different security sandbox than the source display object, the capture and bubble phase stops below that parent object, unless there is mutual trust between the owner of the parent object and the owner of the source object. This mutual trust can be achieved by the following:

1. The SWF file that owns the parent object must call the `Security.allowDomain()` method to trust the domain of the SWF file that owns the source object.
2. The SWF file that owns the source object must call the `Security.allowDomain()` method to trust the domain of the SWF file that owns the parent object.

The `LoaderInfo` object that corresponds to a loaded file (and to the `Loader` object) includes the following two properties, which define the relationship between the loaded object and the `Loader` object: `childAllowsParent` and `parentAllowsChild`.

For events that are dispatched from objects other than display objects, there are no security checks or security-related implications.

## Accessing loaded media as data

You access loaded data using methods such as `BitmapData.draw()` and `SoundMixer.computeSpectrum()`. By default, a SWF file from one security sandbox cannot obtain pixel data or audio data from graphic or audio objects rendered or played by loaded media in another sandbox. However, you can use the following methods to grant this permission:

- In a loaded SWF file, call the `Security.allowDomain()` method to grant data access to SWF files in other domains.
- For a loaded image, sound, or video, add a cross-domain policy file on the server of the loaded file. This policy file must grant access to the domain of the SWF file that is attempting to call the `BitmapData.draw()` or `SoundMixer.computeSpectrum()` methods to extract data from the file.

The following sections provide details on accessing bitmap, sound, and video data.

### Accessing bitmap data

The `draw()` method of a `BitmapData` object lets you draw the currently displayed pixels of any display object to the `BitmapData` object. This could include the pixels of a `MovieClip` object, a `Bitmap` object, or any display object. The following conditions must be met for the `draw()` method to draw pixels to the `BitmapData` object:

- In the case of a source object other than a loaded bitmap, the source object and (in the case of a `Sprite` or `MovieClip` object) all of its child objects must come from the same domain as the object calling the `draw()` method, or they must be in a SWF file that is accessible to the caller by having called the `Security.allowDomain()` method.
- In the case of a Loaded bitmap source object, the source object must come from the same domain as the object calling the `draw()` method, or its source server must include a cross-domain policy file that grants permission to the calling domain.

If these conditions are not met, a `SecurityError` exception is thrown.

When you load the image using the `load()` method of the `Loader` class, you can specify a `context` parameter, which is a `LoaderContext` object. If you set the `checkPolicyFile` property of the `LoaderContext` object to `true`, Flash Player checks for a cross-domain policy file on the server from which the image is loaded. If there is a cross-domain policy file, and the file permits the domain of the loading SWF file, the file is allowed to access data in the `Bitmap` object; otherwise, access is denied.

You can also specify a `checkPolicyFile` property in an image loaded via an `<img>` tag in a text field. For details, see [“Loading SWF files and images using the `<img>` tag in a text field” on page 778](#).

## Accessing sound data

The following sound-related ActionScript 3.0 APIs have security restrictions:

- The `SoundMixer.computeSpectrum()` method—Always permitted for SWF files that are in the same security sandbox as the sound file. For files in other sandboxes, there are security checks.
- The `SoundMixer.stopAll()` method—Always permitted for SWF files that are in the same security sandbox as the sound file. For files in other sandboxes, there are security checks.
- The `id3` property of the `Sound` class—Always permitted for SWF files that are in the same security sandbox as the sound file. For files in other sandboxes, there are security checks.

Every sound has two kinds of sandboxes associated with it—a content sandbox and an owner sandbox:

- The origin domain for the sound determines the content sandbox, and this determines whether data can be extracted from the sound via the `id3` property of the sound and the `SoundMixer.computeSpectrum()` method.
- The object that started the sound playing determines the owner sandbox, and this determines whether the sound can be stopped using the `SoundMixer.stopAll()` method.

When you load the sound using the `load()` method of the `Sound` class, you can specify a `context` parameter, which is a `SoundLoaderContext` object. If you set the `checkPolicyFile` property of the `SoundLoaderContext` object to `true`, Flash Player checks for a cross-domain policy file on the server from which the sound is loaded. If there is a cross-domain policy file, and the file permits the domain of the loading SWF file, the file is allowed to access the `id` property of the `Sound` object; otherwise, it will not. Also, setting the `checkPolicyFile` property can enable the `SoundMixer.computeSpectrum()` method for loaded sounds.



You can use the `SoundMixer.areSoundsInaccessible()` method to find out whether a call to the `SoundMixer.stopAll()` method would not stop all sounds because the sandbox of one or more sound owners is inaccessible to the caller.

Calling the `SoundMixer.stopAll()` method stops those sounds whose owner sandbox is the same as that of the caller of `stopAll()`. It also stops those sounds whose playback was started by SWF files that have called the `Security.allowDomain()` method to permit access by the domain of the SWF file calling the `stopAll()` method. Any other sounds are not stopped, and the presence of such sounds can be revealed by calling the `SoundMixer.areSoundsInaccessible()` method.

Calling the `computeSpectrum()` method requires that every sound that is playing be either from the same sandbox as the object calling the method or from a source that has granted permission to the caller's sandbox; otherwise, a `SecurityError` exception is thrown. For sounds that were loaded from embedded sounds in a library in a SWF file, permission is granted with a call to the `Security.allowDomain()` method in the loaded SWF file. For sounds loaded from sources other than SWF files (originating from loaded mp3 files or from Flash video), a cross-domain policy file on the source server grants access to data in loaded media. You cannot use the `computeSpectrum()` method if a sound is loaded from RTMP streams.

For more information, see [“Author \(developer\) controls” on page 769](#) and [“Website controls \(cross-domain policy files\)” on page 765](#).

## Accessing video data

You can use the `BitmapData.draw()` method to capture the pixel data of the current frame of a video.

There are two different kinds of video:

- RTMP video
- Progressive video, which is loaded from an FLV file without an RTMP server

You cannot use the `BitmapData.draw()` method to access RTMP video.

When you call the `BitmapData.draw()` method with progressive video as the source parameter, the caller of `BitmapData.draw()` must either be from the same sandbox as the FLV file, or the server of the FLV file must have a policy file that grants permission to the domain of the calling SWF file. You can request that the policy file be downloaded by setting the `checkPolicyFile` property of the `NetStream` object to `true`.

# Loading data

SWF files can load data from servers into ActionScript, and send data from ActionScript to servers. Loading data is a different kind of operation from loading media, because the loaded information appears directly in ActionScript, rather than being displayed as media. Generally, SWF files may load data from their own domains. However, they usually require cross-domain policy files in order to load data from other domains.

## Using URLLoader and URLStream

You can load data, such as an XML file or a text file. The `load()` methods of the `URLLoader` and `URLStream` classes are governed by cross-domain policy file permissions.

If you use the `load()` method to load content from a domain other than that of the SWF file that is calling the method, Flash Player checks for a cross-domain policy file on the server of the loaded assets. If there is a cross-domain policy file, and it grants access to the domain of the loading SWF file, you can load the data.

## Connecting to sockets

Cross-domain access to socket and XML socket connections is disabled by default. Also disabled by default is access to socket connections in the same domain as the SWF file on ports lower than 1024. You can permit access to these ports by serving a cross-domain policy file from any of the following locations:

- The same port as the main socket connection
- A different port
- An HTTP server on port 80 in the same domain as the socket server

If you serve the cross-domain policy file from same port as the main socket connection, or in a different port, you enumerate permitted ports by using a `to-ports` attribute in the cross-domain policy file, as the following example shows:

```
<?xml version="1.0"?>
<!DOCTYPE cross-domain-policy
  SYSTEM "http://www.adobe.com/xml/dtds/cross-domain-policy.dtd">
<!-- Policy file for xmlsocket://socks.mysite.com -->
<cross-domain-policy>
  <allow-access-from domain="*" to-ports="507" />
  <allow-access-from domain="*.example.com" to-ports="507,516" />
  <allow-access-from domain="*.example.org" to-ports="516-523" />
  <allow-access-from domain="adobe.com" to-ports="507,516-523" />
  <allow-access-from domain="192.0.34.166" to-ports="*" />
</cross-domain-policy>
```

To retrieve a socket policy file from the same port as a main socket connection, simply call the `Socket.connect()` or `XMLSocket.connect()` method, and, if the specified domain is not the same as the domain of the calling SWF file, Flash Player automatically attempts to retrieve a policy file from the same port as the main connection you are attempting. To retrieve a socket policy file from a different port on the same server as your main connection, call the `Security.loadPolicyFile()` method with the special "xml socket" syntax, as in the following:

```
Security.loadPolicyFile("xmlsocket://server.com:2525");
```

Call the `Security.loadPolicyFile()` method before calling the `Socket.connect()` or `XMLSocket.connect()` method. Flash Player then waits until it has fulfilled your policy file request before deciding whether to allow your main connection.

If you are implementing a socket server and you need to provide a socket policy file, decide whether you will provide the policy file using the same port that accepts main connections, or using a different port. In either case, your server must wait for the first transmission from your client before deciding whether to send a policy file or set up a main connection. When Flash Player requests a policy file, it always transmits the following string as soon as a connection is established:

```
<policy-file-request/>
```

Once the server receives this string, it can transmit the policy file. Do not expect to reuse the same connection for both a policy file request and a main connection; you should close the connection after transmitting the policy file. If you do not, Flash Player closes the policy file connection before reconnecting to set up the main connection.

For more information, see [“Socket policy files” on page 767](#).

## Sending data

Data sending occurs when ActionScript code from a SWF file sends data to a server or resource. Sending data is always permitted for network domain SWF files. A local SWF file can send data to network addresses only if it is in the local-trusted or local-with-networking sandbox. For more information, see [“Local sandboxes” on page 771](#).

You can use the `flash.net.sendToURL()` function to send data to a URL. Other methods also send requests to URLs. These include loading methods, such as `Loader.load()` and `Sound.load()`, and data-loading methods, such as `URLLoader.load()` and `URLStream.load()`.

## Uploading and downloading files

The `FileReference.upload()` method starts the upload of a file selected by a user to a remote server. You must call the `FileReference.browse()` or `FileReferenceList.browse()` method before calling the `FileReference.upload()` method.

Calling the `FileReference.download()` method opens a dialog box in which the user can download a file from a remote server.

**NOTE**

If your server requires user authentication, only SWF files running in a browser—that is, using the browser plug-in or ActiveX control—can provide a dialog box to prompt the user for a user name and password for authentication, and only for downloads. Flash Player does not allow uploads to a server that requires user authentication.

Uploads and downloads are not allowed if the calling SWF file is in the local-with-filesystem sandbox.

By default, a SWF file may not initiate an upload to, or a download from, a server other than its own. A SWF file may upload to, or download from, a different server if that server provides a cross-domain policy file that grants permission to the domain of the invoking SWF file.

## Loading embedded content from SWF files imported into a security domain

When you load a SWF file, you can set the `context` parameter of the `load()` method of the `Loader` object that is used to load the file. This parameter takes a `LoaderContext` object.

When you set the `securityDomain` property of this `LoaderContext` object to `Security.currentDomain`, Flash Player checks for a cross-domain policy file on the server of the loaded SWF file. If there is a cross-domain policy file, and it grants access to the domain of the loading SWF file, you can load the SWF file as imported media. In this way, the loading file can get access to objects in the library of the SWF file.

An alternative way for a SWF file to access classes in loaded SWF files from a different security sandbox is to have the loaded SWF file call the `Security.allowDomain()` method to grant access to the domain of the calling SWF file. You can add the call to the `Security.allowDomain()` method to the constructor method of the main class of the loaded SWF file, and then have the loading SWF file add an event listener to respond to the `init` event dispatched by the `contentLoaderInfo` property of the `Loader` object. When this event is dispatched, the loaded SWF file has called the `Security.allowDomain()` method in the constructor method, and classes in the loaded SWF file are available to the loading SWF file. The loading SWF file can retrieve classes from the loaded SWF file by calling `Loader.contentLoaderInfo.applicationDomain.getDefinition()`.

## Working with legacy content

In Flash Player 6, the domain that is used for certain Flash Player settings is based on the trailing portion of the domain of the SWF file. These settings include settings for camera and microphone permissions, storage quotas, and storage of persistent shared objects.

If the domain of a SWF file includes more than two segments, such as `www.example.com`, the first segment of the domain (`www`) is removed, and the remaining portion of the domain is used. So, in Flash Player 6, `www.example.com` and `store.example.com` both use `example.com` as the domain for these settings. Similarly, `www.example.co.uk` and `store.example.co.uk` both use `example.co.uk` as the domain for these settings. This can lead to problems in which SWF files from unrelated domains, such as `example1.co.uk` and `example2.co.uk`, have access to the same shared objects.

In Flash Player 7 and later, player settings are chosen by default according to a SWF file's exact domain. For example, a SWF file from `www.example.com` would use the player settings for `www.example.com`. A SWF file from `store.example.com` would use the separate player settings for `store.example.com`.

In a SWF file written using ActionScript 3.0, when `Security.exactSettings` is set to `true` (the default), Flash Player uses exact domains for player settings. When it is set to `false`, Flash Player uses the domain settings used in Flash Player 6. If you change `exactSettings` from its default value, you must do so before any events occur that require Flash Player to choose player settings—for example, using a camera or microphone, or retrieving a persistent shared object.

If you published a version 6 SWF file and created persistent shared objects from it, to retrieve those persistent shared objects from a SWF that uses ActionScript 3.0, you must set `Security.exactSettings` to `false` before calling `SharedObject.getLocal()`.

# Setting LocalConnection permissions

The LocalConnection class lets you develop SWF files that can send instructions to each other. LocalConnection objects can communicate only among SWF files that are running on the same client computer, but they can be running in different applications—for example, a SWF file running in a browser and a SWF file running in a projector.

For every LocalConnection communication, there is a sender SWF file and a listener SWF file. By default, Flash Player allows LocalConnection communication between SWF files in the same domain. For SWF files in different sandboxes, the listener must allow the sender permission by using the LocalConnection.allowDomain() method. The string you pass as an argument to the LocalConnection.allowDomain() method can contain any of the following: exact domain names, IP addresses, and the \* wildcard.

NOTE

The allowDomain() method has changed from the form it had in ActionScript 1.0 and 2.0. In those earlier versions, allowDomain() was a callback method that you implemented. In ActionScript 3.0, allowDomain() is a built-in method of the LocalConnection class that you call. With this change, allowDomain() works in much the same way as Security.allowDomain().

A SWF file can use the domain property of the LocalConnection class to determine its domain.

## Controlling access to scripts in a host web page

Outbound scripting is achieved through use of the following ActionScript 3.0 APIs:

- The flash.system.fscallback() function
- The flash.net.navigateToURL() function (when specifying a scripting statement, such as navigateToURL("javascript: alert('Hello from Flash Player.')."))
- The flash.net.navigateToURL() function (when the window parameter is set to "\_top", "\_self", or "\_parent")
- The ExternalInterface.call() method

For SWF files running locally, calls to these methods are successful only if the SWF file and the containing web page (if there is one) are in the local-trusted security sandbox. Calls to these methods fail if the content is in the local-with-networking or local-with-filesystem sandbox.

The AllowScriptAccess parameter in the HTML code that loads a SWF file controls the ability to perform outbound scripting from within a SWF file.

Set this parameter in the HTML code for the web page that hosts a SWF file. You set the parameter in the `PARAM` or `EMBED` tag.

The `AllowScriptAccess` parameter can have one of three possible values: "always", "sameDomain", or "never":

- When `AllowScriptAccess` is "sameDomain", outbound scripting is allowed only if the SWF file and the web page are in the same domain. This is the default for AVM2 content.
- When `AllowScriptAccess` is "never", outbound scripting always fails.
- When `AllowScriptAccess` is "always", outbound scripting always succeeds.

If the `AllowScriptAccess` parameter is not specified for a SWF file in an HTML page, it defaults to "sameDomain" for AVM2 content.

Here is an example of setting the `AllowScriptAccess` tag in an HTML page:

```
<object id='MyMovie.swf' classid='clsid:D27CDB6E-AE6D-11cf-96B8-444553540000' codebase='http://download.adobe.com/pub/shockwave/cabs/flash/swflash.cab#version=9,0,0,0' height='100%' width='100%'>
  <param name='AllowScriptAccess' value='never' />
  <param name='src' value='MyMovie.swf' />
  <embed name='MyMovie.swf' pluginspage='http://www.adobe.com/go/getflashplayer' src='MyMovie.swf' height='100%' width='100%'
    AllowScriptAccess='never' />
</object>
```

The `AllowScriptAccess` parameter can prevent a SWF file hosted from one domain from accessing a script in an HTML page that comes from another domain. Using `AllowScriptAccess="never"` for all SWF files hosted from another domain can ensure the security of scripts located in an HTML page.

For more information, see the following entries in the *ActionScript 3.0 Language and Components Reference*:

- The `flash.system.fscommand()` function
- The `flash.net.navigateToURL()` function
- The `call()` method of the `ExternalInterface` class

# Shared objects

Flash Player provides the ability to use *shared objects*, which are ActionScript objects that persist outside of a SWF file, either locally on a user's file system or remotely on an RTMP server. Shared objects, like other media in Flash Player, are partitioned into security sandboxes. However, the sandbox model for shared objects is somewhat different, because shared objects are not resources that can ever be accessed across domain boundaries. Instead, shared objects are always retrieved from a shared object store that is particular to the domain of each SWF file that calls methods of the SharedObject class. Usually a shared object store is even more particular than a SWF file's domain: by default, each SWF file uses a shared object store particular to its entire origin URL.

A SWF file can use the `localPath` parameter of the `SharedObject.getLocal()` and `SharedObject.getRemote()` methods to use a shared object store associated with only a part of its URL. In this way, the SWF file can permit sharing with other SWF files from other URLs. Even if you pass `'/'` as the `localPath` parameter, this still specifies a shared object store particular to its own domain.

Users can restrict shared object access by using the Flash Player Settings dialog box or the Settings Manager. By default, shared objects can be created up to a maximum of 100 KB of data per domain. Administrative users and users can also place restrictions on the ability to write to the file system. For more information, see [“Administrative user controls” on page 760](#) and [“User controls” on page 763](#).

You can specify that a shared object is secure, by specifying `true` for the `secure` parameter of the `SharedObject.getLocal()` method or the `SharedObject.getRemote()` method. Note the following about the `secure` parameter:

- If this parameter is set to `true`, Flash Player creates a new secure shared object or gets a reference to an existing secure shared object. This secure shared object can be read from or written to only by SWF files delivered over HTTPS that call `SharedObject.getLocal()` with the `secure` parameter set to `true`.
- If this parameter is set to `false`, Flash Player creates a new shared object or gets a reference to an existing shared object that can be read from or written to by SWF files delivered over non-HTTPS connections.

If the calling SWF file is not from an HTTPS URL, specifying `true` for the `secure` parameter of the `SharedObject.getLocal()` method or the `SharedObject.getRemote()` method results in a `SecurityError` exception.



The choice of a shared object store is based on a SWF file's origin URL. This is true even in the two situations where a SWF file does not originate from a simple URL: import loading and dynamic loading. Import loading refers to the situation where you load a SWF file with the `LoaderContext.securityDomain` property set to `SecurityDomain.currentDomain`. In this situation, the loaded SWF file will have a pseudo-URL that begins with its loading SWF file's domain and then specifies its actual origin URL. Dynamic loading refers to the loading of a SWF file using the `Loader.loadBytes()` method. In this situation, the loaded SWF file will have a pseudo-URL that begins with its loading SWF file's full URL followed by an integer ID. In both the import loading and dynamic loading cases, a SWF file's pseudo-URL can be examined using the `LoaderInfo.url` property. The pseudo-URL is treated exactly like a real URL for the purposes of choosing a shared object store. You can specify a shared object `localPath` parameter that uses part or all of the pseudo-URL.

Users and administrators can elect to disable the use of *third-party shared objects*. This is the usage of shared objects by any SWF file that is executing in a web browser, when that SWF file's origin URL is from a different domain than the URL shown in the browser's address bar. Users and administrators may choose to disable third-party shared object usage for reasons of privacy, wishing to avoid cross-domain tracking. In order to avoid this restriction, you may wish to ensure that any SWF file using shared objects is loaded only within HTML page structures that ensure that the SWF file comes from the same domain as is shown in the browser's address bar. When you attempt to use shared objects from a third-party SWF file, and third-party shared object use is disabled, the `SharedObject.getLocal()` and `SharedObject.getRemote()` methods return `null`. For more information, see [www.adobe.com/products/flashplayer/articles/thirdpartyiso](http://www.adobe.com/products/flashplayer/articles/thirdpartyiso).

# Camera, microphone, clipboard, mouse, and keyboard access

When a SWF file attempts to access a user's camera or microphone using the `Camera.get()` or `Microphone.get()` methods, Flash Player displays a Privacy dialog box, in which the user can allow or deny access to their camera and microphone. The user and the administrative user can also disable camera access on a per-site or global basis, through controls in the `mms.cfg` file, the Settings UI, and the Settings Manager (see [“Administrative user controls” on page 760](#) and [“User controls” on page 763](#)). With user restrictions, the `Camera.get()` and `Microphone.get()` methods each return a `null` value. You can use the `Capabilities.avHardwareDisable` property to determine whether the camera and microphone have been administratively prohibited (`true`) or allowed (`false`).

The `System.setClipboard()` method allows a SWF file to replace the contents of the clipboard with a plain-text string of characters. This poses no security risk. To protect against the risk posed by passwords and other sensitive data being cut or copied to clipboards, there is no corresponding `“getClipboard”` (read) method.

A Flash application can monitor only keyboard and mouse events that occur within its focus. A Flash application cannot detect keyboard or mouse events in another application.

# Index

## Symbols

- != (inequality) operator 208
- != (strict inequality) operator 208
- \$ metacharacter 291
- \$ replacement codes 214
- & (ampersand) 650
- () (parentheses) metacharacters 291
- () (parentheses) operators 106
- () (XML filtering) operators 361
- \* (asterisk) metacharacter 291
- \* (asterisk) type annotation 87, 89, 96, 97
- \* (wildcard) operator, XML 360
- + (addition) operator 209
- + (concatenation) operator, XMLList 357
- + (plus) metacharacter 291
- += (addition assignment) operator 209, 357
- , (comma) operator 84
- . (dot) metacharacter 291
- . (dot) operator 103, 125
- . (dot) operator, XML 349, 358
- .. (descendent accessor) operator, XML 358
- ... (rest) parameter 133
- / (forward slash) 289, 291
- : (colon) operator 89
- < operator 110
- == operator 208
- === operator 208
- > operator 110, 208
- >= operator 208
- ? (question mark) 291
- ?: (conditional) operator 116
- @ (attribute identifier) operator, XML 349, 360
- [ (left bracket) 291
- \ (backslash)
  - in regular expressions 291
  - in strings 207
- ] (right bracket) 291

- ^ (caret) 291
- \_\_proto\_\_ 69
- \_\_resolve 69
- | (pipe) 297

## A

- abstract classes 142
- accessor functions, get and set 153
- ActionScript
  - about 68
  - advantages of 20
  - building applications with 47
  - compatibility with previous versions 24
  - description of 19
  - development process 51
  - documentation 15
  - history of OOP support 172
  - new features in 21
  - storing in ActionScript files 48
  - tools for writing 50
  - ways to include in applications 48
  - writing with text editors 51
- ActionScript 1.0 172
- ActionScript 2.0, prototype chain 174
- ActionScript Virtual Machine (AVM1) 171
- ActionScript Virtual Machine 2 (AVM2) 171, 176
- activation object 135
- addCallback() method 781
- addEventListener() method 156, 319, 332
- addition (+) operator 209
- addition assignment (+=) operator 209
- additive operators 114
- addListener() method 319
- allowDomain() method
  - about cross-scripting 780
  - constructor and 789

- img tag and 778
- loading context 421
- LocalConnection class 661
- sound and 785
- allowFullScreen attribute 775
- allowInsecureDomain() method 661
- allowNetworking tag 773
- AllowScriptAccess parameter 791
- alpha channel masking 415
- alternation in regular expressions 297
- ampersand (&) 650
- animation 416
- anonymous functions 124, 132
- anti-aliasing text 527
- application/x-www-form-urlencoded 649
- ApplicationDomain class 422, 700, 777
- applications, development decisions 47
- apply() method 243
- arguments object 128, 131, 133
- arguments, passing by reference or value 129
- arguments.callee property 131
- arguments.caller property 132
- arguments.length property 131
- Array class
  - concat() method 233
  - constructor algorithm 243
  - extending 241
  - join() method 233
  - length property 229, 235
  - pop() method 228
  - push() method 227, 244
  - reverse() method 229
  - shift() method 228
  - slice() method 233
  - sort() method 229
  - sortOn() method 229, 231
  - splice() method 227, 228
  - toString() method 233
  - unshift() method 227
- arrays
  - about 223
  - array literals 104, 227
  - associative 234
  - cloning 241
  - common tasks 224
  - constructor 226
  - creating 212, 226
  - deep copy of 241
  - delete operator 229
  - examples 247
  - indexed 225
  - inserting elements 227
  - iterating through 237
  - key and value pairs 235
  - length of 229
  - maximum size 226
  - multidimensional 239
  - nested arrays and join() method 234
  - object keys 236
  - querying 233
  - removing elements 228
  - shallow copy 241
  - sorting 229
  - superconstructor 243
  - terms 225
  - typed arrays not supported 226
  - using associative and indexed arrays 240
- as operator 92, 159
- as3 compiler option 243
- AS3 namespace 179, 243
- ASCII characters 203
- assignment operators 116
- associativity, rules of 110
- asterisk (\*) metacharacter 291
- asterisk (\*) type annotation 87, 89, 96, 97
- asterisk (wildcard) operator, XML 360
- asynchronous errors 258
- asynchronous operation 334
- attribute identifier (@) operator, XML 349, 360
- audio playback, monitoring 627
- audio security 784
- avHardwareDisable property 761
- AVM1 (ActionScript Virtual Machine) 171
- AVM1Movie class 378
- AVM2 (ActionScript Virtual Machine 2) 171, 176

## B

- background color, making opaque 409
- backslash (\) character
  - in regular expressions 291
  - in strings 207
- bar (|) character 297
- base classes 162
- basic concepts
  - comments 42
  - creating object instances 40
  - events 33
  - example 44

- flow control 43
- methods 32
- objects 31
- operators 42
- properties 31
- variables 28

beginGradientFill() method 455

big-endian byte order 663

binary operators 109

bitmap caching

- advantages and disadvantages 406
- caching movie clips 408
- filters and 470
- when to avoid 408
- when to use 407

Bitmap class 377, 543

bitmap data, copying 549

bitmap printing 721

BitmapData class 543

BitmapData objects, applying filters 469

bitmaps

- about 540
- defining in Bitmap class 377
- file formats 540
- security 783
- smoothing 544
- transparent versus opaque 541

bitwise logical operators 115

bitwise shift operators 114

block-level scope 85

Boolean class

- casting 101
- implicit coercion in strict mode 99

Boolean data type 94

bound methods 136, 154

brace operators ({ and }) in XML 356

bracket ([ and ]) characters 291

bracket ([ and ]) operators 125

browse() method 788

bubbles property 324

bubbling phase 320

build path 73

built-in classes 69

byte order 663

ByteArray class 241

bytes loaded 420

## C

caching filters and bitmaps 470

call() method (ExternalInterface class) 773, 790

callback methods

- handling 568
- ignoring 567

callee property 131

caller property 132

Camera class 577

cameras

- capturing input 577
- displaying content on-screen 578
- permissions 580
- playback conditions 583
- security 789, 794
- verifying installation 579

cancelable property 322

Capabilities class 699

Capabilities.avHardwareDisable property 761

Capabilities.localFileReadDisable property 761

capture phase 320

capturing camera input 577

capturing user-selected text 518

caret (^) character 291

cascading style sheets. *See* CSS

case replacement in strings 215

case sensitivity 103

casting 97, 99, 101

catch blocks 262

character classes (in regular expressions) 293

character codes 634

character ranges, specifying 294

character-delimited string, combining arrays into 251

characters

- in regular expressions 290
- in strings 208, 211

charAt() method 208

charCodeAt() method 208

checkPolicyFile property 768

childAllowsParent property 782, 783

class definitions, multiple 700

class inheritance 177

class keyword 141

class object 68, 175

classes

- about 140
- about writing code for 54
- abstract not supported 142
- attributes 141

- base 162
- body 143
- built-in 69
- characteristics 31
- creating custom 53
- declaring static and instance properties 143
- default access control 146
- defining namespaces inside 143
- definitions of 141
- dynamic 93, 125, 145
- dynamic attribute 142
- inheriting instance properties 164
- internal attribute 146
- organizing 56
- private attribute 144
- private classes 71
- property attributes 144
- protected attribute 146
- public attribute 144
- public classes 74
- sealed 93
- static properties 169
- subclasses 162
- top-level statements 143
- classpath 73
- clearInterval() function 198
- clearTimeout() function 198
- client system environment
  - about 695
  - common tasks 696
- Clipboard
  - saving text 699
  - security 794
- clock example 199
- clone() method (BitmapData class) 549
- clone() method (Event class) 325
- close bracket 291
- close parenthesis 291
- code, ways to include in applications 48
- ColdFusion 655
- collision detection at pixel level 547
- colon (:) operator 89
- colors
  - adjusting in display objects 410
  - altering specific 412
  - background 409
  - combining from different images 409
  - setting for display objects 411
- ColorTransform class 442
- colorTransform property 442
- comma operator 84
- comments
  - about 42, 106
  - in XML 350
- communication
  - between Flash Player instances 656
  - between SWF files 659
  - between SWF files in different domains 661
- compatibility, Flash Player and FLV files 585
- compile-time type checking 88
- compiler options 180, 243
- complex values 87
- compound literals 104
- computeSpectrum() method (SoundMixer class) 779, 783, 784
- concat() method
  - Array class 233
  - String class 209
- concatenation
  - of strings 209
  - of XML objects 357
- concatenation (+) operator, XMLList 357
- conditional (?:) operator 116
- conditionals 117
- connect() method
  - LocalConnection class 774
  - NetConnection class 774, 778
  - Socket class 774
  - XMLSocket class 664, 774
- constants 108, 147, 322
- constructors
  - about 149
  - in ActionScript 1.0 172
- content property (Loader class) 779
- content, loading dynamically 418
- contentLoaderInfo property 420, 789
- contentType property 649
- context menu, customizing 638
- cookies 668
- coordinate spaces
  - defined 432
  - translating 435
- Coordinated Universal Time (UTC) 193
- core Error classes in ActionScript 275
- core Error classes in ECMAScript 272
- createBox() method 441
- createGradientBox() method 455
- cross-domain policy files 786
  - checkPolicyFile property and 421, 784
  - extracting data 783

- img tag and 778
- securityDomain property and 777
- URLLoader and URLStream classes 786
- cross-scripting 779
- CSS
  - defined 511
  - loading 523
  - styles 521
- cue points
  - triggering actions 566
  - in video 565
- currentDomain property 788
- currentTarget property 325
- cursors, customizing 638
- custom classes 53
- custom data types, enumerations 156
- custom error classes 267
- custom LocalConnection client 658

## D

- data
  - loading external 649
  - security of 783, 787
  - sending to servers 655
- data property (URLRequest class) 650
- data structures 223
- data types
  - about 29
  - Boolean 94
  - custom 156
  - default (untyped) 69
  - defined 87
  - int 94
  - Number 95
  - simple and complex 29
  - String 96
  - uint 96
  - void 96
- dataFormat property 655
- date arithmetic 195
- Date class
  - about 191
  - constructor 193
  - date property 194
  - day property 194
  - fullYear property 194
  - getMonth() method 151, 194
  - getMonthUTC() method 194
  - getTime() method 195
  - getTimezoneOffset() method 196
  - hours property 194
  - milliseconds property 194
  - minutes property 194
  - month property 194
  - monthUTC property 194
  - parse() method 151
  - seconds property 194
  - setTime() method 195
- Date objects
  - example of creating 193
  - getting time values from 194
- date property 194
- Date() constructor 193
- dates and times
  - about 191
  - examples 192
- day property 194
- debugger version, Flash Player 335
- debugging 261
- decode() method 650
- decrementing values 112
- default behavior
  - canceling 323
  - defined 318
- default data type 69
- default parameter values 130
- default xml namespace directive 364
- Delegate class 330
- delete operator 126, 229
- delimiter character, splitting strings into array 212
- depth management, improved 380
- descendent accessor (..) operator, XML 358
- development
  - planning 47
  - process 51
- device fonts 511
- Dictionary class
  - about 236
  - useWeakReference parameter 238
- dispatchEvent() method 334
- dispatching events 314
- display architecture 372, 448
- display content, loading dynamically 418
- display list
  - about 372
  - advantages 379
  - event flow 320
  - security 782

- traversing 387
- display list object 318
- display object containers 373, 383
- display objects
  - about 373
  - adding to display list 383
  - adjusting colors 410
  - animating 416
  - assembling complicated objects 381
  - bitmaps 539
  - caching 405
  - choosing a subclass 393
  - clicking and dragging example 428
  - common tasks 374
  - creating 382
  - depth management 380
  - drawing API and 447
  - events 392
  - example 423, 462
  - example of rearranging 429
  - fading 413
  - filtering 465, 467, 472
  - grouping 383
  - inheritance of core classes 377
  - masking 414
  - matrix transformation 442
  - movie clips 491
  - off-list 381
  - positioning 395
  - removing filters 469
  - rotating 413, 440
  - scaling 402, 403, 440
  - security 782
  - setting colors of 411
  - size 402
  - skewing 440
  - subclassing 381
  - terms 375
  - translation 440
  - types of 377
  - user input and 631
- display programming, about 372
- displaying camera content on-screen 578
- DisplayObject class
  - about 373, 382
  - stage property 320
  - subclasses 377
- DisplayObjectContainer class 373, 378, 383
- displayState property 391, 775
- distance() method 434
- division by zero 96
- do..while loop 122
- Document Object Model (DOM) Level 3 Events
  - specification 313, 318
- documentation
  - ActionScript 15
  - Adobe Developer Center and Adobe Design Center 17
  - Flash 15
  - Programming ActionScript 3.0* contents 14
- dollar sign (\$) metacharacter 291
- dollar sign (\$) replacement codes 214
- DOM Events specification 313, 318
- domain property (LocalConnection class) 790
- domains, communicating between 661
- dot (.) metacharacter 291
- dot (.) operator 103, 125
- dot (.) operator, XML 349, 358
- dot syntax 103
- dotall flag in regular expressions 303
- dotall property of regular expressions 301
- double quotation mark in strings 206, 207
- download() method 774, 788
- downloading files 679, 788
- drag-and-drop
  - capturing interactions 637
  - creating interaction 396
- draw() method 421, 777, 779, 783, 785
- dynamic attribute 142
- dynamic classes 93, 125, 145
- dynamic text fields 511

## E

- E4X. *See* XML
- ECMAScript edition 4 draft 68
- ECMAScript for XML. *See* XML
- embedded asset classes 158
- embedded fonts
  - defined 511
  - using 525
- encoding ampersand (&) 650
- Endian.BIG\_ENDIAN 663
- Endian.LITTLE\_ENDIAN 663
- enterFrame event 321
- enumerations 156
- equality operators 115, 208
- Error classes
  - about 272



- ActionScript 275
- ECMAScript 272
- error events 268, 334
- error handling
  - common tasks 255
  - default behaviors 318
  - examples 335
  - strategies 261
  - terms 255
  - tools 260
- ErrorEvent class 269, 335
- errors
  - about handling 254
  - asynchronous 258
  - custom classes 267
  - debugging tools 261
  - displaying 265
  - MouseEvent class 268, 335
  - print 719
  - rethrowing 266
  - status-based events 268
  - throw statement 264
  - types of 254, 257
- es compiler option 243
- escape sequences in character classes 293
- Event class
  - about 322
  - bubbles property 324
  - cancelable property 322
  - clone() method 325
  - constants 322
  - currentTarget property 325
  - eventPhase property 324
  - isDefaultPrevented() method 326
  - method categories 325
  - preventDefault() method 318, 326
  - stopImmediatePropagation() method 326
  - stopPropagation() method 326
  - subclasses 327
  - target property 324
  - toString() method 325
  - type property 322
- event flow 314, 320, 323
- event handlers 317, 566
- event listeners
  - about 314
  - changes in ActionScript 3.0 319
  - as class methods 329
  - creating 327
  - managing 331
  - outside a class 328
  - removing 333
  - technique to avoid 330
- event objects 314
- event target 314, 320
- Event.COMPLETE 649
- EventDispatcher class
  - addEventListener() method 156, 319
  - dispatchEvent() method 334
  - IEventDispatch interface and 159
  - references to 104
  - willTrigger() method 334
- eventPhase property 324
- events
  - basic concepts 33
  - default behaviors 318
  - dispatching 314, 334
  - for display objects 392
  - enterFrame event 321
  - error 268, 334
  - event flow 314, 320, 323
  - event objects 322
  - init event 321
  - parent node 321
  - security 782
  - status change 270
  - target node 320
  - this keyword 330
  - See also* event listeners
- exactSettings property (Security class) 789
- examples
  - animating sprites with offscreen bitmaps 553
  - arrays 247
  - building a Telnet client 682
  - detecting system capabilities 709
  - error handling 335
  - filtering images 490
  - GeometricShapes 180
  - loading RSS data 367
  - Matrix class 442
  - multi-page printing 725
  - rearranging display object layers 429
  - regular expressions 306
  - RunTimeAssetsExplorer 503
  - SimpleClock 199
  - sound application 622
  - SpriteArranger class 424
  - strings 215
  - text formatting 529
  - using external API with a web page container 742

- video jukebox 587
- Wiki parser 306
- WordSearch 641
- exceptions 257
- exec() method 305
- explicit type conversion 97
- exporting library symbols 498
- extended flag in regular expressions 303
- extended property of regular expressions 301
- extends keyword 162
- external API
  - about 732
  - advantages 735
  - common tasks 732
  - concepts and terms 732
  - example 742
  - XML format 740
- external code, calling from ActionScript 737
- external containers, getting information about 737
- external data, loading 649
- external documents, loading data 651
- external SWF files, loading 501
- ExternalInterface class 735, 773, 790
- ExternalInterface.addCallback() method 781

## F

- facade class 623
- fading display objects 413
- fast-forwarding movie clips 495
- file size, smaller for shapes 379
- FileReference class 672, 774, 788
- FileReferenceList class 680, 788
- files
  - downloading 788
  - uploading 680, 788
- filtering XML data 361
- filters
  - applying for display objects 467
  - applying to BitmapData objects 469
  - bitmap caching and 470
  - changing at run time 470
  - common tasks 466
  - creating 467
  - for display and bitmap objects 472
  - explanation of 470
  - for images, example 490
  - removing for display objects 469
- final attribute 91, 153, 156, 167

- first sprite loaded 373, 420
- fixed property inheritance 177
- flags in regular expressions 301
- Flash authoring, when to use for ActionScript 50
- Flash cookie 668
- Flash documentation 15
- Flash Media Server 779
- flash package 72
- Flash Player
  - communicating between instances 656
  - compatibility with encoded FLV 585
  - debugger version 335
  - IME and 704
  - version 6 172
- Flash timeline, adding ActionScript 48
- Flash Video. *See* FLV
- flash.display package
  - about display programming 371
  - bitmaps and 539
  - drawing API and 447
  - filtering and 465
  - movie clips and 491
  - sound and 595
  - text and 509
  - user input and 631
- flash.geom package 431
- flash\_proxy namespace 79
- Flex, when to use for ActionScript 50
- flow control, basic concepts 43
- FLV
  - configuring for hosting on server 585
  - file format 559
  - Flash Player and 585
  - on Macintosh 586
- focus, managing in interactions 639
- fonts
  - device 511
  - embedded 511, 525
- for each..in statement 120, 237, 362
- for loops 119
- for loops, XML 349, 362
- for..in statement 119, 237, 362
- form feed character 207
- formatting text 520, 524
- forward slash 289, 291
- frameRate property 389
- frames, jumping to 496
- fromCharCode() method 208
- fscCommand() function 656, 773, 790
- full-screen mode 391, 392, 775

- fullScreen event 391
- fullYear property 194
- function closures 122, 128, 136
- function expressions 124
- function keyword 123, 149
- function objects 140
- function parameters 128
- function statements 123
- Function.apply() method 243
- functions
  - about 122
  - accessor 153
  - adding properties to 135
  - anonymous 124, 132
  - arguments object 128
  - calling 123
  - nested 128, 135, 136
  - objects 134
  - parameters 128
  - parentheses 123
  - recursive 132
  - returning values 127
  - scope 127, 135
  - timing 198

## G

- g flag (in regular expressions) 301
- garbage collection 126, 237
- generic objects 105, 234
- GeometricShapes example 180
- geometry
  - about 431
  - common tasks using 432
  - concepts and terms 433, 448
- getDefinition() method 789
- getImageReference() method 779
- getLocal() method 668, 774, 789, 792
- getMonth() method 151, 194
- getMonthUTC() method 194
- getRect() method 439
- getRemote() method 668, 774, 792
- getters and setters
  - about 153
  - overriding 168
- getTime() method 195
- getTimer() function 198
- getTimezoneOffset() method 196
- GIF graphics 418

- global flag in regular expressions 301
- global object 135
- global property of regular expressions 301
- global scope 135
- global variables 84
- gradients 455
- graphics, loading 419
- greater-than operator 110, 208
- greater-than-or-equal-to operator 208
- grouping display objects 383
- groups, in regular expressions 297

## H

- hashes 234, 236
- hoisting 86
- hours property 194
- HTML text
  - and CSS 521
  - displaying 514
- htmlText property 514
- HTTP tunneling 664

## I

- i flag (in regular expressions) 301
- id3 property 784
- IDataInput and IDataOutput interfaces 663
- identifiers 75
- IEventDispatcher interface 158, 331, 332
- if statement 117
- if..else statement 117
- ignore flag in regular expressions 302
- ignoreCase property of regular expressions 301
- images
  - defining in Bitmap class 377
  - filtering example 490
  - loading 418
  - security 783
  - in text fields 515
- IME
  - checking availability 704
  - composition events 708
  - manipulating in Flash Player 704
- IME conversion mode
  - determining 705
  - setting 706
- img tag in text fields, security 778
- implicit type conversion 97

- import statement 73
- importing SWF files 788
- incrementing values 112
- index positions in strings 208
- indexed arrays 225
- indexOf() method 211
- inequality (!=) operator 208
- infinity 96
- inheritance
  - defined 162
  - fixed property 177
  - instance properties 164
  - static properties 169
- init event 321
- input text fields 511
- instance methods 151
- instance properties
  - declaring 143
  - inheriting 164
- instance variables 148
- instanceof operator 92
- instances, creating 40
- int class, casting 99
- int data type 94
- InteractiveObject class 378
- interfaces
  - about 158
  - defining 160
  - extending 160
  - implementing in a class 161
- internal attribute 74, 75, 146
- intersection() method 439
- intersects() method 439
- is operator 91, 159
- isDefaultPrevented() method 326
- isNaN() global function 87
- iterating through arrays 237

## J

- Java socket server 665
- join() method 233
- JPG graphics 418

## K

- key codes 634
- keyboard input, capturing 633
- keyboard security 794
- keys, string 234
- keywords 107

## L

- landscape printing 724
- lastIndexOf() method 211
- layering, rearranging 429
- left bracket 291
- left parenthesis 291
- left-associative operators 110
- length property
  - arguments object 131
  - Array class 229
  - strings 207
- less-than operator 110, 208
- less-than-or-equal operator 208
- level property 335
- lexical environment 136
- library symbols, exporting 498
- lineGradientStyle() method 455
- listeners. *See* event listeners
- literal values
  - about 104
  - array literals 104, 227
  - object 235
- little-endian byte order 663
- load progress 420
- load() method (Loader class) 421, 768, 774
- load() method (Sound class) 768, 774, 778, 787
- load() method (URLLoader class) 649, 774
- load() method (URLStream class) 774, 787
- loadBytes() method 421, 768
- loaded media, accessing as data 783
- Loader class 418, 419, 774, 784, 789
- LoaderContext class 421, 777, 784
- LoaderContext object 768
- LoaderInfo class
  - display object access 782
  - monitoring loading progress 420
- loaderInfo property 420
- loading context 421
- loading graphics 419
- loadPolicyFile() method 774
- local storage 668

- local variables 84
- LocalConnection class
  - about 656
  - connectionName parameter 662
  - permissions 790
  - restricted 774
- LocalConnection.allowDomain() method 661, 790
- LocalConnection.allowInsecureDomain() method 661
- LocalConnection.client property 657, 658
- LocalConnection.connect() method 774
- localFileReadDisable property 761
- localToGlobal() method 435
- logical operators 116
- looping
  - do..while 122
  - for 119
  - for (XML) 349, 362
  - for each..in 120, 237, 362
  - for..in 119, 237, 362
  - while 121

## M

- m flag (in regular expressions) 301
- Macintosh, FLV files 586
- mantissa 95
- maps 234, 236
- masking display objects 414
- masking for alpha channel 415
- match() method 213
- Matrix class
  - defined 440
  - defining gradients with 455
  - example 442
  - objects, defining 441
  - rotating 441
  - scaling 441
  - skewing 441
  - translating 441
- MAX\_VALUE (Number class) 95
- memory management 237
- metacharacters, in regular expressions 290
- metadata, video 573, 575
- metasequences, in regular expressions 290, 292
- method property (URLRequest class) 650
- methods
  - basic concepts 32
  - bound 136, 154
  - constructors 149
  - defined 148
  - getters and setters 153, 168
  - instance 151
  - overriding 167
  - static 151
- microphone
  - accessing 617
  - detecting activity 620
  - routing to local speakers 619
  - security 789, 794
- Microphone class 324
- milliseconds property 194
- MIN\_VALUE (Number class) 95
- minutes property 194
- monitor, full-screen mode 391
- month property 194
- monthUTC property 194
- MorphShape class 378
- mouse cursors, customizing 638
- mouse security 794
- MouseEvent class 319, 327
- movie clips
  - about 491
  - caching 408
  - common tasks 492
  - concepts and terms 492
  - fast-forwarding 495
  - frame rate 389
  - playing and stopping 495
  - rewinding 495
- MovieClip class 378
  - frame rates 389
- MovieClip objects, creating 498
- multiline flag in regular expressions 302
- multiline property of regular expressions 301
- multiple class definitions 700
- multiplicative operators 114
- mx.util.Delegate class 330

## N

- name conflicts, avoiding 71, 74
- named groups (in regular expressions) 300
- namespaces
  - about 75
  - access control specifiers 77
  - applying 77
  - AS3 179, 243
  - default namespace 75

- defining 76, 143
- flash\_proxy 79
- importing 81
- namespace keyword 76
- opening 78
- referencing 78
- use namespace directive 78, 81, 180
- user-defined attributes 147
- XML 363
- NaN value 96
- navigateToURL() function 773, 790
- negated character classes (in regular expressions) 295
- negative infinity 96
- nested functions 128, 135, 136
- nested packages 71
- NetConnection class 774
- NetConnection.connect() method 774, 778
- NetStream class 768, 774, 778
- network byte order 663
- networking
  - about 646
  - concepts and terms 647
  - restricting 773
- new operator 70
- newline character 207
- nodes in XML, accessing 359
- noncapturing groups in regular expressions 299
- null value 87, 95, 96, 238
- Number class
  - casting 99
  - default value 86
  - integer range 96
  - isNaN() global function 87
  - precision 95
- Number data type 95

## O

- Object class
  - associative arrays 234
  - data type and 97
  - prototype property 173, 177
  - valueOf() method 178
- object keys in arrays 236
- object literals 235
- object-oriented programming
  - common tasks for 138
  - concepts 139
- objects

- basic concepts 31
- instantiating 40
- octal numbers 100
- off-list display objects 381
- on() event handlers 317
- onClipEvent() function 317
- onCuePoint event handlers 566
- opaque background 409
- open bracket ([]) 291
- open parenthesis 291
- operators
  - about 109
  - additive 114
  - assignment 116
  - basic concepts 42
  - bitwise logical 115
  - bitwise shift 114
  - conditional 116
  - equality 115, 208
  - logical 116
  - multiplicative 114
  - postfix 112
  - precedence 110
  - prefix 113
  - primary 112
  - relational 115
  - unary 109, 113
- optional parameters 130
- overloaded operators 109
- override keyword 153, 154
- overriding getters and setters 168

## P

- package statement 141
- packages
  - about 70
  - creating 72
  - dot operator 71, 103
  - dot syntax 104
  - importing 73
  - nested packages 71
  - top level 71, 72
- page properties 721
- parameters
  - optional or required 130
  - passing by value or by reference 129
- parentAllowsChild property 782, 783
- parentheses

- empty 123
- metacharacters 291
- operators 106
- XML filtering operators 361
- parse() method 151
- performance, improving for display objects 406
- period (.). *See* dot
- permissions
  - camera 580
  - LocalConnection class 790
- pipe (|) character 297
- pixel snapping 544
- pixels, manipulating individual 545
- play() method (NetStream class) 774
- playback
  - camera and 583
  - controlling frame rate 389
  - monitoring audio 627
  - of movie clips 494
  - pausing and resuming audio 628
  - video 562
- player. *See* Flash Player
- plus sign (+) 291
- PNG graphics 418
- podcast applications
  - creating 622
  - extending 629
- Point objects
  - about 434
  - additional uses for 436
  - distance between points 434
  - translating coordinate spaces 435
- pointers (cursors), customizing 638
- points versus pixels 723
- polar() method 435
- polymorphism 163
- pop() method 228
- portrait printing 724
- ports, security 786
- positions
  - of characters in strings 211
  - of display objects 395
- positive infinity 96
- postfix operators 112
- prefix operators 113
- preventDefault() method 318, 326
- primary operators 112
- primitive types, implicit conversions 98
- primitive values 69, 87
- printArea parameter 721
- printing
  - about 716
  - common tasks 716
  - concepts and terms 717
  - exceptions and returns 719
  - multiple pages, example 725
  - orientation 724
  - page height and width 724
  - page properties 721
  - pages 718
  - points 723
  - Rectangle objects 723
  - scaling 724
  - specifying area 723
  - timeout 722
  - vector or bitmap 721
- PrintJob statements, timing 722
- PrintJob() constructor 718
- priority parameter, addEventListener() method 332
- private attribute 144
- private classes 71
- private constructors not supported 150
- program flow 117
- programs, basic definition 27
- progress of audio playback 627
- ProgressEvent.PROGRESS 649
- properties
  - ActionScript versus other languages 68
  - adding to functions 135
  - basic concepts 31
  - defined, for ActionScript 3.0 144
  - of regular expressions 301
  - static and instance 143, 169
  - XML 350
- property access operator 236
- protected attribute 146
- \_\_proto\_\_ 69
- prototype chain 68, 173
- prototype object 125, 173, 177
- prototype property 173, 177
- Proxy class 79
- public attribute 144
- public classes 74
- push() method 227, 244

## Q

quantifiers (in regular expressions) 295  
question mark (?) metacharacter 291  
quotation marks 206, 207

## R

Real-Time Messaging Protocol content security 779  
Rectangle objects  
    additional uses for 440  
    defined 436  
    intersections 438  
    printing 723  
    repositioning 437  
    resizing 437  
    unions 438  
recursive functions 132  
reference, passing by 129  
RegExp class  
    about 285  
    methods 305  
    properties 301  
regular expressions  
    about 286  
    alternation using pipe (|) metacharacter 297  
    alternators and character groups 298  
    capturing substring matches 298  
    character classes 293  
    characters in 290  
    creating 289  
    example 306  
    flags 301  
    forward slash delimiter 289  
    groups 297  
    metacharacters 290, 291  
    metasequences 290, 292  
    methods for working with 305  
    named groups 300  
    parameters in String methods 306  
    properties 301  
    quantifiers 295  
    searching 304  
relational operators 115  
replace() method 198, 214  
replacement codes 214  
replacing text in strings 212  
required parameters 130  
reserved words 107  
\_\_resolve 69

rest parameter 133  
return statement 127, 150  
reverse() method 229  
rewinding movie clips 495  
right bracket (]) 291  
right parenthesis 291  
right-associative operators 110  
right-click menu (context menu) 638  
rotate() method 441  
rotating display objects 413, 440  
rotating matrixes 440  
RSS data  
    loading, example 367  
    reading for a podcast channel 623  
RTMP content security 779  
run time, determining user's system 698

## S

s flag (in regular expressions) 301  
sameDomain property 782  
scale() method 441  
scaling  
    controlling distortion 403  
    display objects 440  
    matrixes 440  
    printing 724  
    Stage 389  
scenes, to demarcate timelines 497  
scope  
    block-level 85  
    functions and 127, 135  
    global 135  
    variables 84  
scope chain 135, 170  
script timeout limit 722  
scrolling text 516, 517  
sealed classes 93  
search() method 213  
search, in regular expressions 304  
searching strings 213  
seconds property 194  
security  
    accessing loaded media as data 783  
    allowNetworking tag 773  
    bitmaps 783  
    camera 789, 794  
    Clipboard 794  
    display list 782



- event-related 782
- files, uploading and downloading 788
- full-screen mode 775
- images 783
- img tag 778
- imported SWF files 788
- keyboard 794
- LocalConnection class 790
- microphone 789, 794
- mouse 794
- ports 786
- RTMP 779
- sending data 787
- shared objects 789, 792
- sockets 786
- sound 778, 784
- Stage 781
- URLLoader 786
- URLStream 786
- video 778, 785
- See also* cross-domain policy files
- Security class 774
- Security.allowDomain() method
  - about cross-scripting 780
  - constructor and 789
  - img tag and 778
  - loading context 421
  - sound and 785
- Security.currentDomain property 788
- Security.exactSettings property 789
- SecurityDomain class 421, 777
- semicolons 105
- send() method (LocalConnection class) 657, 774
- sendToURL() function 774, 787
- Server, Flash Media 779
- server-side scripts 655
- setClipboard() method 794
- setInterval() function 198
- setters. *See* getters and setters
- setTime() method 195
- setTimeout() method 198
- shadow 171
- Shape class 377
- shared objects
  - about 668
  - displaying contents of 670
  - Flash Player settings and 789
  - security and 670, 792
- SharedObject class 668, 774
- SharedObject.getLocal() method 789, 792
- SharedObject.getRemote() method 792
- shift() method 228
- shortcut menu (context menu) 638
- significand 95
- SimpleButton class 377
- SimpleClock example 199
- single quotation mark in strings 206, 207
- skewing display objects 440
- skewing matrixes 440, 441
- slash syntax 104
- slashes
  - backslash (\) 207, 291
  - forward slash (/) 289, 291
- slice() method
  - Array class 233
  - String class 211
- smoothing bitmaps 544
- Socket class 663, 774, 786
- socket connections 662
- socket server 665
- sorting arrays 229, 231
- sound
  - sample application 622
  - security of 778, 784
  - sending to and from a server 621
- Sound class 768, 774, 778
- SoundFacade class 623
- SoundLoaderContext class 768
- SoundMixer.computeSpectrum() method 779, 783, 784
- SoundMixer.stopAll() method 784
- source path 73
- speakers and microphones 619
- speed, improving for rendering 406
- splice() method 227, 228
- split() method 212
- Sprite class 378
- sprite, first loaded 373, 420
- SpriteArranger class example 424
- Stage
  - about 320, 372
  - as display object container 374
  - properties, setting 389
  - scaling 389
  - security 781
- Stage class 320
- Stage owner 781
- StageDisplayState class 775
- standard mode 90, 125
- star (\*). *See* asterisk

- static attribute 146
- static methods 151
- static properties
  - declaring 143
  - inheritance 169
  - within scope chain 170
  - XML 350
- static text
  - accessing 528
  - creating 379
- static text fields 511
- static variables 147
- StaticText class 379
- status change events 270
- status-based error events 268
- stopAll() method (SoundMixer class) 784
- stopImmediatePropogation() method 326
- stopping movie clips 495
- stopPropogation() method 326
- storing data 668
- streaming video 564
- strict inequality (!=) operator 208
- strict mode
  - about 88
  - casting 98
  - dot syntax and 125
  - explicit conversion 98
  - returning values 127
  - run-time errors 90
- String class
  - charAt() method 208
  - charCodeAt() method 208
  - concat() method 209
  - fromCharCode() method 208
  - indexOf() method 211
  - lastIndexOf() method 211
  - match() method 213
  - replace() method 214
  - search() method 213
  - slice() method 211
  - split() method 212
  - substr() and substring() methods 211
  - toLowerCase() and toUpperCase() methods 215
- String data type 96
- string keys 234
- string representations of objects 209
- strings
  - about 204
  - character position 211
  - checking matches in regular expressions 305
  - combining arrays into character-delimited string 251
  - common tasks 204
  - comparing 208
  - concatenating 209
  - converting case 215
  - converting data type for XML attributes 365
  - converting XML objects to 364
  - declaring 205
  - example 215, 216
  - finding substrings 211
  - index positions 208
  - length 207
  - matching substrings 298
  - patterns, finding 210, 212
  - replacing text 212
  - substrings 210, 212
  - terms 205
- style sheets. *See* CSS
- StyleSheet class 521
- subclasses 162
- substr() and substring() methods 211
- substrings
  - about 210
  - creating based on a delimiter 212
  - finding and replacing 211, 212
  - matching in regular expressions 298
- super statement 150, 151, 167
- superclasses 162
- superconstructor for arrays 243
- SWF files
  - communication between domains 661
  - communication between instances 659
  - determining run-time environment 699
  - importing loaded 788
  - loading 418
  - loading external 501
  - loading older versions 502
- switch statement 118
- symbols in regular expressions 290
- synchronous errors 257
- syntactic keywords 107
- syntax 103
- system, determining user's 698
- System.setClipboard() method 794

## T

- tab character 207
- target node or phase 320
- target property 324
- Telnet client example 682
- terminating statements 105
- ternary operators 109
- test() method 305
- text
  - about 510
  - anti-aliasing 527
  - assigning formats 521
  - available types 513
  - capturing input 518
  - common tasks 511
  - concepts and terms 511
  - displaying 513
  - formatting 520, 529
  - formatting ranges of 524
  - manipulating 517
  - replacing 212
  - restricting input 520
  - saving to Clipboard 699
  - scrolling 516, 517
  - selecting 517
  - sharpness 527
  - static 379, 528
  - thickness 527
- text editors 51
- text fields
  - disabling IME for 707
  - dynamic 511
  - HTML in 521
  - images in 515
  - img tag and security 778
  - input 511
  - modifying 514
  - scrolling text 516
  - static 511
- text line metrics 511, 536
- TextEvent class 318
- TextField class 318, 378
- TextFormat class 521
- TextLineMetrics class 536
- TextSnapshot class 529
- this keyword 151, 152, 155, 330
- throw statement 264
- time formats 193
- time intervals 196

- time unit values 194
- time zones 193, 196
- timeline, Flash 48
- timeout limit 722
- Timer class
  - about 197
  - monitoring playback 627
- timer events 197
- timers 196
- timing functions 198
- toLowerCase() method 215
- toString() method
  - about 209
  - Array class 233
  - Event class 325
- toUpperCase() method 215
- traits object 176
- Transform class
- transform property 442
- transformation matrixes. *See* Matrix class
- translate() method 441
- translating matrixes 440
- try..catch..finally statements 262
- twips 723
- type annotations 83, 89
- type checking
  - compile-time 88
  - run-time 90
- type conversion 97, 99, 364
- type mismatches 89
- type property (Event class) 322
- typed arrays 226
- types. *See* data types

## U

- UIEventDispatcher class 318
- uint class, casting 99
- uint data type 96
- unary operators 109, 113
- undefined 69, 96, 97, 226
- Unicode characters 203
- Uniform Resource Identifier (URI) 76
- union() method 438
- Universal Time (UTC) 193
- unordered arrays 234
- unshift() method 227
- untyped variables 69, 87
- upcasting 91

- upload() method 774, 788
- uploading files 674, 680, 788
- URIs 76
- URL encoding 650
- URLLoader class
  - about 649
  - loading XML data 355, 366
  - security and 786
  - when restricted 774
- URLLoader constructor 649
- URLLoader.dataFormat property 655
- URLLoader.load() method 649, 650
- URLLoaderDataFormat.VARIABLES 655
- URLRequest instance 649, 650
- URLRequest.contentType property 649
- URLRequest.data property 650
- URLRequest.method property 650
- URLRequestMethod.GET 651
- URLRequestMethod.POST 651
- URLs of loaded objects 420
- URLStream class 774, 786
- URLVariables class 649
- URLVariables.decode() method 650
- use namespace directive 78, 81, 180
- useCapture parameter, addEventListener() method 332
- user input
  - about 631
  - common tasks 632
  - concepts and terms 632
- user interactions, managing focus 639
- user-selected text, capturing 518
- user's system, determining at run time 698
- useWeakReference parameter 238
- UTC (Coordinated Universal Time) 193

## V

- valueOf() method (Object class) 178
- values
  - assigning to variables 83
  - passing arguments by 129
- var keyword 83, 147
- variables
  - basic concepts 28
  - declaring 147
  - default value 86
  - initializing 86, 354
  - instance 148
  - overriding not permitted 148

- scope of 84
- static 147
- type annotations 83, 89
- types of 147
- uninitialized 86
- untyped 69, 87
- var statement 83
- vector printing 721
- video
  - about 556
  - common tasks 557
  - end of stream 563
  - loading 561
  - on Macintosh 586
  - metadata 573, 575
  - playback 562
  - quality 582
  - security 778, 785
  - sending to server 584
  - streaming 564
- Video class 560
- video jukebox example 587
- visual objects. *See* display objects
- void 96

## W

- weak references 238
- while loop 121
- white space 350
- Wiki parser example 306
- wildcard (\*) operator, XML 360
- willTrigger() method 334
- words, reserved 107
- WordSearch example 641
- wrapper objects 88

## X

- x flag (in regular expressions) 301
- XML
  - accessing attributes 360
  - ActionScript for 346
  - basic concepts 344
  - brace operators ({ and }) 356
  - child nodes 359
  - comments 350
  - common tasks 347
  - concepts and terms 347

- documents 345
- E4X (ECMAScript for XML) 71, 343, 348
- filtering 361
- for each..in loops 120
- for loops 349, 362
- format for external API 740
- initializing variables 354
- loading data 355, 366
- methods 351
- namespaces 363
- parent nodes 359
- processing instructions 350
- properties 350
- socket server 665
- transforming 356
- traversing structures 358
- type conversion 364
- white space 350
- XML class 71
- XMLDocument class 71, 348
- XMLList objects
  - about 353
  - concatenating 357
- XMLNode class 348
- XMLParser class 348
- XMLSocket class 355, 366, 663, 774, 786
- XMLSocket.connect() method 664, 774
- XMLTag class 348

